



FCC TEST REPORT

REPORT NO.: RF981204L03
MODEL NO.: EM113-MV
RECEIVED: Dec. 04, 2009
TESTED: Dec. 10 ~ Dec. 14, 2009
ISSUED: Dec. 17, 2009

APPLICANT: Quanta Microsystems, Inc.

ADDRESS: 188 Wenhwa 2nd Rd., Kueishan Hsiang
Taoyuan Shien 333, Taiwan, R.O.C.

ISSUED BY: Bureau Veritas Consumer Products Services
(H.K.) Ltd., Taoyuan Branch

LAB ADDRESS: No. 47, 14th Ling, Chia Pau Tsuen, Lin Kou
Hsiang, Taipei Hsien 244, Taiwan, R.O.C.

TEST LOCATION: No. 19, Hwa Ya 2nd Rd, Wen Hwa Tsuen, Kwei
Shan Hsiang, Taoyuan Hsien 333, Taiwan,
R.O.C.

This test report consists of 61 pages in total. It may be duplicated completely for legal use with the approval of the applicant. It should not be reproduced except in full, without the written approval of our laboratory. The client should not use it to claim product endorsement by TAF or any government agencies. The test results in the report only apply to the tested sample.





A D T

TABLE OF CONTENTS

1.	CERTIFICATION	4
2.	SUMMARY OF TEST RESULTS	5
2.1	MEASUREMENT UNCERTAINTY	5
3.	GENERAL INFORMATION	6
3.1	GENERAL DESCRIPTION OF EUT	6
3.2	DESCRIPTION OF TEST MODES	7
3.2.1	CONFIGURATION OF SYSTEM UNDER TEST	7
3.2.2	TEST MODE APPLICABILITY AND TESTED CHANNEL DETAIL	8
3.3	GENERAL DESCRIPTION OF APPLIED STANDARDS	10
3.4	DESCRIPTION OF SUPPORT UNITS	11
4.	TEST TYPES AND RESULTS	12
4.1	RADIATED EMISSION MEASUREMENT	12
4.1.1	LIMITS OF RADIATED EMISSION MEASUREMENT	12
4.1.2	TEST INSTRUMENTS	13
4.1.3	TEST PROCEDURES	14
4.1.4	DEVIATION FROM TEST STANDARD	14
4.1.5	TEST SETUP	15
4.1.6	EUT OPERATING CONDITIONS	15
4.1.7	TEST RESULTS	16
4.2	CONDUCTED EMISSION MEASUREMENT	30
4.2.1	LIMITS OF CONDUCTED EMISSION MEASUREMENT	30
4.2.2	TEST INSTRUMENTS	30
4.2.3	TEST PROCEDURES	31
4.2.4	DEVIATION FROM TEST STANDARD	31
4.2.5	TEST SETUP	32
4.2.6	EUT OPERATING CONDITIONS	32
4.2.7	TEST RESULTS	33
4.3	6dB BANDWIDTH MEASUREMENT	37
4.3.1	LIMITS OF 6dB BANDWIDTH MEASUREMENT	37
4.3.2	TEST INSTRUMENTS	37
4.3.3	TEST PROCEDURE	37
4.3.4	DEVIATION FROM TEST STANDARD	37
4.3.5	TEST SETUP	38
4.3.6	EUT OPERATING CONDITIONS	38
4.3.7	TEST RESULTS	39



4.4	MAXIMUM OUTPUT POWER.....	41
4.4.1	LIMITS OF MAXIMUM OUTPUT POWER MEASUREMENT	41
4.4.2	INSTRUMENTS	41
4.4.3	TEST PROCEDURES.....	41
4.4.4	DEVIATION FROM TEST STANDARD	41
4.4.5	TEST SETUP	42
4.4.6	EUT OPERATING CONDITIONS.....	42
4.4.7	TEST RESULTS	43
4.5	POWER SPECTRAL DENSITY MEASUREMENT	44
4.5.1	LIMITS OF POWER SPECTRAL DENSITY MEASUREMENT	44
4.5.2	TEST INSTRUMENTS	44
4.5.3	TEST PROCEDURE	44
4.5.4	DEVIATION FROM TEST STANDARD	44
4.5.5	TEST SETUP	45
4.5.6	EUT OPERATING CONDITION	45
4.5.7	TEST RESULTS	46
4.6	BAND EDGES MEASUREMENT	48
4.6.1	LIMITS OF BAND EDGES MEASUREMENT	48
4.6.2	TEST INSTRUMENTS	48
4.6.3	TEST PROCEDURE	48
4.6.4	DEVIATION FROM TEST STANDARD	48
4.6.5	EUT OPERATING CONDITION	48
4.6.6	TEST RESULTS	49
5.	PHOTOGRAPHS OF THE TEST CONFIGURATION	59
6.	INFORMATION ON THE TESTING LABORATORIES.....	60
7.	APPENDIX A - MODIFICATIONS RECORDERS FOR ENGINEERING CHANGES TO THE EUT BY THE LAB.....	61



1. CERTIFICATION

PRODUCT: IEEE 802.11b/g WLAN minicard
MODEL: EM113-MV
BRAND: QMI
APPLICANT: Quanta Microsystems, Inc.
TESTED: Dec. 10 ~ Dec. 14, 2009
TEST SAMPLE: ENGINEERING SAMPLE
STANDARDS: FCC Part 15, Subpart C (Section 15.247)
ANSI C63.4-2003

The above equipment (model: EM113-MV) has been tested by **Bureau Veritas Consumer Products Services (H.K.) Ltd., Taoyuan Branch**, and found compliance with the requirement of the above standards. The test record, data evaluation & Equipment Under Test (EUT) configurations represented herein are true and accurate accounts of the measurements of the sample's EMC characteristics under the conditions specified in this report.

PREPARED BY : Peggy Chen , **DATE** : Dec. 17, 2009
Peggy Chen / Specialist

TECHNICAL ACCEPTANCE : Long Chen , **DATE** : Dec. 17, 2009
Responsible for RF Long Chen / Senior Engineer

APPROVED BY : Gary Chang , **DATE** : Dec. 17, 2009
Gary Chang / Assistant Manager

2. SUMMARY OF TEST RESULTS

The EUT has been tested according to the following specifications:

APPLIED STANDARD: FCC Part 15, Subpart C			
Standard Section	Test Type and Limit	Result	Remark
15.207	AC Power Conducted Emission	PASS	Meet the requirement of limit. Minimum passing margin is -19.06dB at 0.170MHz.
15.247(a)(2)	Spectrum Bandwidth of a Direct Sequence Spread Spectrum System Limit: min. 500kHz	PASS	Meet the requirement of limit.
15.247(b)	Maximum Peak Output Power Limit: max. 30dBm	PASS	Meet the requirement of limit.
15.247(d)	Radiated Emissions Limit: Table 15.209	PASS	Meet the requirement of limit. Minimum passing margin is -0.4dB at 183.22MHz.
15.247(e)	Power Spectral Density Limit: max. 8dBm	PASS	Meet the requirement of limit.
15.247(d)	Band Edge Measurement Limit: 20dB less than the peak value of fundamental frequency	PASS	Meet the requirement of limit.
15.203	Antenna Requirement	PASS	Antenna connector is I-PEX not a standard connector.

2.1 MEASUREMENT UNCERTAINTY

Where relevant, the following measurement uncertainty levels have been estimated for tests performed on the EUT as specified in CISPR 16-4-2:

MEASUREMENT	FREQUENCY	UNCERTAINTY
Conducted emissions	150kHz ~ 30MHz	2.44 dB
Radiated emissions	30MHz ~ 200MHz	3.34 dB
	200MHz ~ 1000MHz	3.35 dB
	1GHz ~ 18GHz	2.26 dB
	18GHz ~ 40GHz	1.94 dB

This uncertainty represents an expanded uncertainty expressed at approximately the 95% confidence level using a coverage factor of k=2.



3. GENERAL INFORMATION

3.1 GENERAL DESCRIPTION OF EUT

PRODUCT	IEEE 802.11b/g WLAN minicard		
MODEL NO.	EM113-MV		
FCC ID	T5U-EM113MV		
POWER SUPPLY	1.8 and 3.3Vdc		
MODULATION TYPE	CCK, DQPSK, DBPSK for DSSS 64QAM, 16QAM, QPSK, BPSK for OFDM		
MODULATION TECHNOLOGY	DSSS, OFDM		
TRANSFER RATE	802.11b: 11.0/ 5.5/ 2.0/ 1.0Mbps 802.11g: 54.0/ 48.0/ 36.0/ 24.0/ 18.0/ 12.0/ 9.0/ 6.0Mbps		
OPERATING FREQUENCY	2412MHz ~ 2462MHz		
NUMBER OF CHANNEL	11		
MAXIMUM OUTPUT POWER	229.1mW		
ANTENNA TYPE		Main antenna gain	Aux. antenna gain
	Dipole	2.0dBi	2.0dBi
	PIFA	0.2dBi	3.1dBi
ANTENNA CONNECTOR	I-PEX		
DATA CABLE	NA		
I/O PORTS	NA		
ACCESSORY DEVICES	NA		

NOTE:

1. The EUT, operates in the 2.4GHz frequency range, lets you connect IEEE 802.11g or IEEE 802.11b devices to the network. With its high-speed data transmissions of up to 54Mbps.
2. The above EUT information was declared by manufacturer and for more detailed features description, please refer to the manufacturer's specifications or user's manual.

3.2 DESCRIPTION OF TEST MODES

Eleven channels are provided for 802.11b and 802.11g:

CHANNEL	FREQUENCY	CHANNEL	FREQUENCY
1	2412MHz	7	2442MHz
2	2417MHz	8	2447MHz
3	2422MHz	9	2452MHz
4	2427MHz	10	2457MHz
5	2432MHz	11	2462MHz
6	2437MHz		

3.2.1 CONFIGURATION OF SYSTEM UNDER TEST

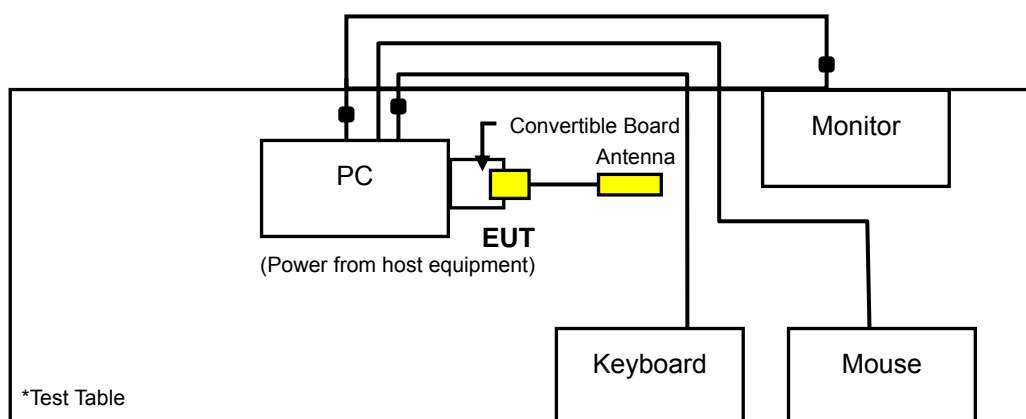

3.2.2 TEST MODE APPLICABILITY AND TESTED CHANNEL DETAIL

EUT CONFIGURE MODE	APPLICABLE TO				DESCRIPTION
	RE \geq 1G	RE<1G	PLC	APCM	
A	√	√	√	√	Dipole Antenna
B	√	√	√	-	PIFA Antenna

Where **PLC**: Power Line Conducted Emission

RE<1G: Radiated Emission below 1GHz

RE \geq 1G: Radiated Emission above 1GHz

APCM: Antenna Port Conducted Measurement

NOTE: "-" means no effect.

RADIATED EMISSION TEST (ABOVE 1 GHz):

- Pre-Scan has been conducted to determine the worst-case mode from all possible combinations between available modulations, data rates, XYZ axis and antenna ports (if EUT with antenna diversity architecture).
- Following channel(s) was (were) selected for the final test as listed below.

EUT CONFIGURE MODE	MODE	AVAILABLE CHANNEL	TESTED CHANNEL	MODULATION TECHNOLOGY	MODULATION TYPE	DATA RATE (Mbps)	ANT. AXIS
A	802.11b	1 to 11	1, 6, 11	DSSS	DBPSK	1.0	Y
B	802.11b	1 to 11	1, 6, 11	DSSS	DBPSK	1.0	X
A	802.11g	1 to 11	1, 6, 11	OFDM	BPSK	6.0	Y
B	802.11g	1 to 11	1, 6, 11	OFDM	BPSK	6.0	X

RADIATED EMISSION TEST (BELOW 1 GHz):

- Pre-Scan has been conducted to determine the worst-case mode from all possible combinations between available modulations, data rates, XYZ axis and antenna ports (if EUT with antenna diversity architecture).
- Following channel(s) was (were) selected for the final test as listed below.

EUT CONFIGURE MODE	MODE	AVAILABLE CHANNEL	TESTED CHANNEL	MODULATION TECHNOLOGY	MODULATION TYPE	DATA RATE (Mbps)	ANT. AXIS
A	802.11g	1 to 11	6	OFDM	BPSK	6.0	Y
B	802.11g	1 to 11	6	OFDM	BPSK	6.0	X

POWER LINE CONDUCTED EMISSION TEST:

- Pre-Scan has been conducted to determine the worst-case mode from all possible combinations between available modulations, data rates and antenna ports (if EUT with antenna diversity architecture).
- Following channel(s) was (were) selected for the final test as listed below.

EUT CONFIGURE MODE	MODE	AVAILABLE CHANNEL	TESTED CHANNEL	MODULATION TECHNOLOGY	MODULATION TYPE	DATA RATE (Mbps)
A	802.11g	1 to 11	6	OFDM	BPSK	6.0
B	802.11g	1 to 11	6	OFDM	BPSK	6.0

BANDEDGE MEASUREMENT:

- Pre-Scan has been conducted to determine the worst-case mode from all possible combinations between available modulations, data rates, XYZ axis and antenna ports (if EUT with antenna diversity architecture).
- Following channel(s) was (were) selected for the final test as listed below.

EUT CONFIGURE MODE	MODE	AVAILABLE CHANNEL	TESTED CHANNEL	MODULATION TECHNOLOGY	MODULATION TYPE	DATA RATE (Mbps)	ANT. AXIS
A, B	802.11b	1 to 11	1, 11	DSSS	DBPSK	1.0	Y
A, B	802.11g	1 to 11	1, 11	OFDM	BPSK	6.0	X

ANTENNA PORT CONDUCTED MEASUREMENT:

- This item includes all test value of each mode, but only includes spectrum plot of worst value of each mode.
- Pre-Scan has been conducted to determine the worst-case mode from all possible combinations between available modulations, data rates and antenna ports (if EUT with antenna diversity architecture).
- Following channel(s) was (were) selected for the final test as listed below.

EUT CONFIGURE MODE	MODE	AVAILABLE CHANNEL	TESTED CHANNEL	MODULATION TECHNOLOGY	MODULATION TYPE	DATA RATE (Mbps)
A	802.11b	1 to 11	1, 6, 11	DSSS	DBPSK	1.0
A	802.11g	1 to 11	1, 6, 11	OFDM	BPSK	6.0

TEST CONDITION:

APPLICABLE TO	ENVIRONMENTAL CONDITIONS	INPUT POWER	TESTED BY
RE \geq 1G	23deg. C, 70%RH, 1006 hPa	120Vac, 60Hz	Match Tsui
RE $<$ 1G	23deg. C, 65%RH, 1005 hPa	120Vac, 60Hz	Lori Chiu
PLC	23deg. C, 68%RH, 1014 hPa	120Vac, 60Hz	Sun Lin
APCM	24deg. C, 67%RH, 1016 hPa	120Vac, 60Hz	Dean Wang

3.3 GENERAL DESCRIPTION OF APPLIED STANDARDS

The EUT is a RF product. According to the specifications of the manufacturer, it must comply with the requirements of the following standards:

FCC Part 15, Subpart C (15.247)

ANSI C63.4-2003

All test items have been performed and recorded as per the above standards.

NOTE: The EUT is also considered as a kind of computer peripheral, because the connection to computer is necessary for typical use. It has been verified to comply with the requirements of FCC Part 15, Subpart B, Class B (DoC). The test report has been issued separately.

3.4 DESCRIPTION OF SUPPORT UNITS

The EUT has been tested as an independent unit together with other necessary accessories or support units. The following support units or accessories were used to form a representative test configuration during the tests.

NO.	PRODUCT	BRAND	MODEL NO.	SERIAL NO.	FCC ID
1	PC	DELL	DIMENSION 4700	JN39F1S	FCC DoC Approved
2	LCD MONITOR	ACER	AL1511 bm	ET.L1408.043348001 3APK01	FCC DoC Approved
3	KEYBOARD	DELL	SK-8115	MY-0DJ325-71619-68 U-1757	FCC DoC Approved
4	MOUSE	DELL	MO56U0	513001542	FCC DoC Approved
5	CONVERTIBLE BOARD	NA	NA	NA	NA

NO.	SIGNAL CABLE DESCRIPTION OF THE ABOVE SUPPORT UNITS
1	NA
2	1.8 m braid shielded wire, terminated with VGA connector via metallic frame, with two cores
3	2.0m foil shielded wire, USB Connector, with core.
4	1.8m foil shielded wire, USB Connector, w/o core.
5	NA

NOTE:

1. All power cords of the above support units are non-shielded (1.8 m).
2. Item 5 was provided by the client.

4. TEST TYPES AND RESULTS

4.1 RADIATED EMISSION MEASUREMENT

4.1.1 LIMITS OF RADIATED EMISSION MEASUREMENT

Emissions radiated outside of the specified bands, shall be according to the general radiated limits in 15.209 as following:

FREQUENCIES (MHz)	FIELD STRENGTH (microvolts/meter)	MEASUREMENT DISTANCE (meters)
0.009 ~ 0.490	2400 / F(kHz)	300
0.490 ~ 1.705	24000 / F(kHz)	30
1.705 ~ 30.0	30	30
30 ~ 88	100	3
88 ~ 216	150	3
216 ~ 960	200	3
Above 960	500	3

NOTE:

1. The lower limit shall apply at the transition frequencies.
2. Emission level (dBuV/m) = 20 log Emission level (uV/m).
3. As shown in 15.35(b), for frequencies above 1000MHz, the field strength limits are based on average detector, however, the peak field strength of any emission shall not exceed the maximum permitted average limits, specified above by more than 20dB under any condition of modulation.

4.1.2 TEST INSTRUMENTS

DESCRIPTION & MANUFACTURER	MODEL NO.	SERIAL NO.	DATE OF CALIBRATION	DUE DATE OF CALIBRATION
Test Receiver ROHDE & SCHWARZ	ESIB7	100212	May 25, 2009	May 24, 2010
Spectrum Analyzer ROHDE & SCHWARZ	FSP40	100040	Jul. 07, 2009	Jul. 06, 2010
BILOG Antenna SCHWARZBECK	VULB9168	9168-156	Apr. 30, 2009	Apr. 29, 2010
HORN Antenna SCHWARZBECK	BBHA 9120 D	9120D-563	Aug. 10, 2009	Aug. 09, 2010
HORN Antenna SCHWARZBECK	BBHA 9170	BBHA9170242	Jan. 06, 2009	Jan. 05, 2010
Preamplifier Agilent	8449B	3008A01910	Sep. 11, 2009	Sep. 10, 2010
Preamplifier Agilent	8447D	2944A10638	Dec. 26, 2008	Dec. 25, 2009
RF signal cable HUBER+SUHNNER	SUCOFLEX 104	218190/4 231241/4	May 13, 2009	May 12, 2010
RF signal cable Worken	8D-FB	Cable-HYCH9-01	Aug. 17, 2009	Aug. 16, 2010
Software	ADT_Radiated_ V7.6.15.9.2	NA	NA	NA
Antenna Tower EMCO	2070/2080	512.835.4684	NA	NA
Turn Table EMCO	2087-2.03	NA	NA	NA
Antenna Tower & Turn Table Controller EMCO	2090	NA	NA	NA

- NOTE:**
1. The calibration interval of the above test instruments is 12 months and the calibrations are traceable to NML/ROC and NIST/USA.
 2. The test was performed in HwaYa Chamber 9.
 3. The horn antenna and HP preamplifier (model: 8449B) are used only for the measurement of emission frequency above 1GHz if tested.
 4. The FCC Site Registration No. is 460141.
 5. The IC Site Registration No. is IC 7450F-4.

4.1.3 TEST PROCEDURES

- a. The EUT was placed on the top of a rotating table 0.8 meters above the ground at a 3 meters semi-anechoic chamber. The table was rotated 360 degrees to determine the position of the highest radiation.
- b. The EUT was set 3 meters away from the interference-receiving antenna, which was mounted on the top of a variable-height antenna tower.
- c. The antenna is a broadband antenna, and its height is varied from one meter to four meters above the ground to determine the maximum value of the field strength. Both horizontal and vertical polarizations of the antenna are set to make the measurement.
- d. For each suspected emission, the EUT was arranged to its worst case and then the antenna was tuned to heights from 1 meter to 4 meters and the rotatable table was turned from 0 degrees to 360 degrees to find the maximum reading.
- e. The test-receiver system was set to Peak Detect Function and Specified Bandwidth with Maximum Hold Mode.
- f. If the emission level of the EUT in peak mode was lower than the limit specified, then testing could be stopped and the peak values of the EUT would be reported. Otherwise the emissions would be re-tested one by one using peak, quasi-peak or average method as specified and then reported in a data sheet.

NOTE:

1. The resolution bandwidth and video bandwidth of test receiver/spectrum analyzer is 120kHz for Peak detection (PK) and Quasi-peak detection (QP) at frequency below 1GHz.
2. The resolution bandwidth of test receiver/spectrum analyzer is 1 MHz and video bandwidth is 3MHz for Peak detection at frequency above 1GHz.
3. The resolution bandwidth of test receiver/spectrum analyzer is 1MHz and the video bandwidth is 10Hz for Average detection (AV) at frequency above 1GHz.
4. All modes of operation were investigated and the worst-case emissions are reported.

4.1.4 DEVIATION FROM TEST STANDARD

No deviation.

4.1.5 TEST SETUP

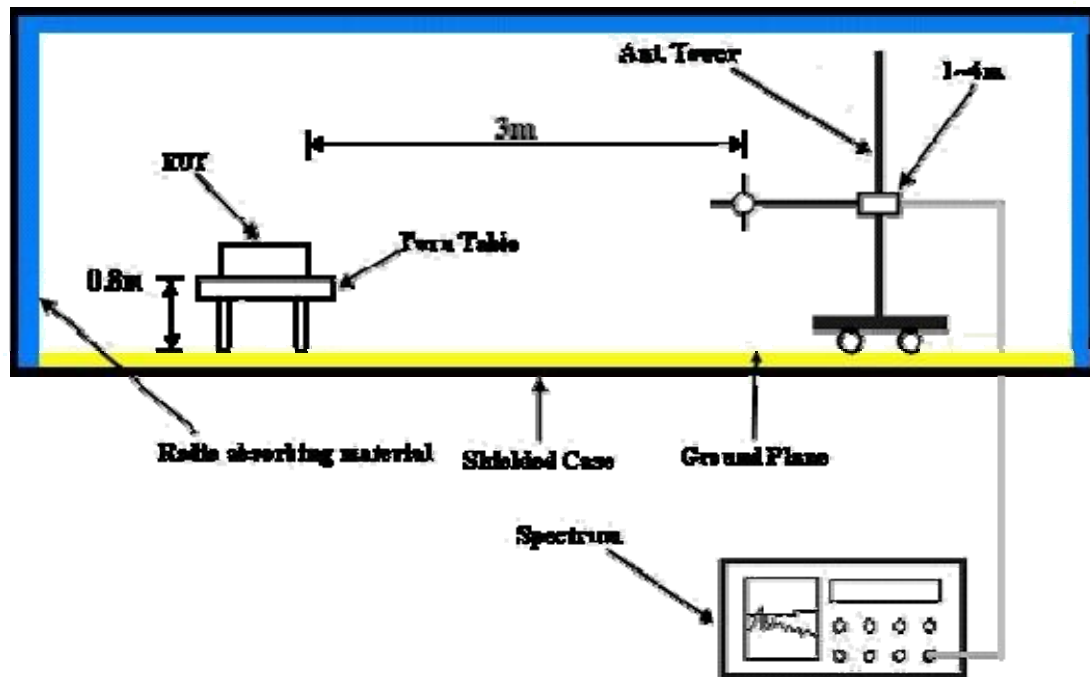

For the actual test configuration, please refer to the attached file (Test Setup Photo)

4.1.6 EUT OPERATING CONDITIONS

- a. Connected the EUT with convertible board to PC and placed on a testing table.
- b. The PC ran a test program (provided by manufacturer) to enable EUT under transmission condition continuously at specific channel frequency.
- c. The necessary accessories enable the system in full functions.

4.1.7 TEST RESULTS

802.11b

EUT TEST CONDITION		MEASUREMENT DETAIL	
CHANNEL	Channel 1	FREQUENCY RANGE	1 ~ 25GHz
INPUT POWER (SYSTEM)	120Vac, 60 Hz	DETECTOR FUNCTION	Peak (PK) Average (AV)
ENVIRONMENTAL CONDITIONS	23deg. C, 70%RH 1006 hPa	TESTED BY	Match Tsui
TEST MODE	A		

ANTENNA POLARITY & TEST DISTANCE: HORIZONTAL AT 3 M								
NO.	FREQ. (MHz)	EMISSION LEVEL (dBuV/m)	LIMIT (dBuV/m)	MARGIN (dB)	ANTENNA HEIGHT (m)	TABLE ANGLE (Degree)	RAW VALUE (dBuV)	CORRECTION FACTOR (dB/m)
1	2386.00	56.2 PK	74.0	-17.8	1.00 H	40	23.96	32.21
2	2386.00	46.3 AV	54.0	-7.7	1.00 H	40	14.05	32.21
3	*2412.00	98.3 PK			1.00 H	4	66.03	32.30
4	*2412.00	94.2 AV			1.00 H	4	61.93	32.30
5	4824.00	48.3 PK	74.0	-25.8	1.00 H	100	9.92	38.33
6	4824.00	34.6 AV	54.0	-19.4	1.00 H	100	-3.75	38.33
ANTENNA POLARITY & TEST DISTANCE: VERTICAL AT 3 M								
NO.	FREQ. (MHz)	EMISSION LEVEL (dBuV/m)	LIMIT (dBuV/m)	MARGIN (dB)	ANTENNA HEIGHT (m)	TABLE ANGLE (Degree)	RAW VALUE (dBuV)	CORRECTION FACTOR (dB/m)
1	2386.00	59.5 PK	74.0	-14.5	1.10 V	78	27.28	32.21
2	2386.00	48.0 AV	54.0	-6.0	1.10 V	78	15.78	32.21
3	*2412.00	108.4 PK			1.07 V	111	76.09	32.30
4	*2412.00	104.1 AV			1.07 V	111	71.76	32.30
5	4824.00	48.5 PK	74.0	-25.5	1.10 V	198	10.20	38.33
6	4824.00	36.8 AV	54.0	-17.2	1.10 V	198	-1.56	38.33

- REMARKS:**
1. Emission level (dBuV/m) = Raw Value (dBuV) + Correction Factor (dB/m).
 2. Correction Factor (dB/m) = Antenna Factor (dB/m) + Cable Factor (dB).
 3. The other emission levels were very low against the limit.
 4. Margin value = Emission level – Limit value.
 5. “ * “: Fundamental frequency.



EUT TEST CONDITION		MEASUREMENT DETAIL	
CHANNEL	Channel 6	FREQUENCY RANGE	1 ~ 25GHz
INPUT POWER (SYSTEM)	120Vac, 60 Hz	DETECTOR FUNCTION	Peak (PK) Average (AV)
ENVIRONMENTAL CONDITIONS	23deg. C, 70%RH 1006 hPa	TESTED BY	Match Tsui
TEST MODE	A		

ANTENNA POLARITY & TEST DISTANCE: HORIZONTAL AT 3 M								
NO.	FREQ. (MHz)	EMISSION LEVEL (dBuV/m)	LIMIT (dBuV/m)	MARGIN (dB)	ANTENNA HEIGHT (m)	TABLE ANGLE (Degree)	RAW VALUE (dBuV)	CORRECTION FACTOR (dB/m)
1	*2437.00	99.2 PK			1.82 H	241	66.76	32.39
2	*2437.00	94.6 AV			1.82 H	241	62.20	32.39
3	4874.00	47.6 PK	74.0	-26.4	1.00 H	56	9.18	38.41
4	4874.00	34.5 AV	54.0	-19.5	1.00 H	56	-3.88	38.41
5	7311.00	52.0 PK	74.0	-22.0	1.38 H	286	7.34	44.64
6	7311.00	40.2 AV	54.0	-13.8	1.38 H	286	-4.40	44.64
ANTENNA POLARITY & TEST DISTANCE: VERTICAL AT 3 M								
NO.	FREQ. (MHz)	EMISSION LEVEL (dBuV/m)	LIMIT (dBuV/m)	MARGIN (dB)	ANTENNA HEIGHT (m)	TABLE ANGLE (Degree)	RAW VALUE (dBuV)	CORRECTION FACTOR (dB/m)
1	*2437.00	108.2 PK			1.07 V	111	75.81	32.39
2	*2437.00	104.0 AV			1.07 V	111	71.56	32.39
3	4874.00	49.1 PK	74.0	-24.9	1.23 V	343	10.73	38.41
4	4874.00	37.9 AV	54.0	-16.1	1.23 V	343	-0.49	38.41
5	7311.00	54.5 PK	74.0	-19.5	1.23 V	288	9.84	44.64
6	7311.00	44.6 AV	54.0	-9.4	1.23 V	288	-0.05	44.64

- REMARKS:**
1. Emission level (dBuV/m) = Raw Value (dBuV) + Correction Factor (dB/m).
 2. Correction Factor (dB/m) = Antenna Factor (dB/m) + Cable Factor (dB).
 3. The other emission levels were very low against the limit.
 4. Margin value = Emission level – Limit value.
 5. “ * ”: Fundamental frequency.



A D T

EUT TEST CONDITION		MEASUREMENT DETAIL	
CHANNEL	Channel 11	FREQUENCY RANGE	1 ~ 25GHz
INPUT POWER (SYSTEM)	120Vac, 60 Hz	DETECTOR FUNCTION	Peak (PK) Average (AV)
ENVIRONMENTAL CONDITIONS	23deg. C, 70%RH 1006 hPa	TESTED BY	Match Tsui
TEST MODE	A		

ANTENNA POLARITY & TEST DISTANCE: HORIZONTAL AT 3 M								
NO.	FREQ. (MHz)	EMISSION LEVEL (dBuV/m)	LIMIT (dBuV/m)	MARGIN (dB)	ANTENNA HEIGHT (m)	TABLE ANGLE (Degree)	RAW VALUE (dBuV)	CORRECTION FACTOR (dB/m)
1	*2462.00	99.0 PK			1.00 H	175	66.48	32.48
2	*2462.00	94.6 AV			1.00 H	175	62.07	32.48
3	2487.00	58.7 PK	74.0	-15.3	1.00 H	48	26.09	32.57
4	2487.00	46.9 AV	54.0	-7.1	1.00 H	48	14.32	32.57
5	4924.00	47.4 PK	74.0	-26.7	1.00 H	360	8.83	38.51
6	4924.00	34.4 AV	54.0	-19.6	1.00 H	360	-4.14	38.51
7	7386.00	53.7 PK	74.0	-20.3	1.11 H	5	8.89	44.83
8	7386.00	40.5 AV	54.0	-13.5	1.11 H	5	-4.31	44.83
ANTENNA POLARITY & TEST DISTANCE: VERTICAL AT 3 M								
NO.	FREQ. (MHz)	EMISSION LEVEL (dBuV/m)	LIMIT (dBuV/m)	MARGIN (dB)	ANTENNA HEIGHT (m)	TABLE ANGLE (Degree)	RAW VALUE (dBuV)	CORRECTION FACTOR (dB/m)
1	*2462.00	108.4 PK			1.09 V	335	75.91	32.48
2	*2462.00	104.1 AV			1.09 V	335	71.64	32.48
3	2487.00	60.7 PK	74.0	-13.3	1.33 V	337	28.09	32.57
4	2487.00	49.4 AV	54.0	-4.7	1.33 V	337	16.78	32.57
5	4924.00	49.3 PK	74.0	-24.7	1.23 V	1	10.77	38.51
6	4924.00	37.7 AV	54.0	-16.3	1.23 V	1	-0.80	38.51
7	7386.00	55.7 PK	74.0	-18.3	1.78 V	287	10.84	44.83
8	7386.00	46.2 AV	54.0	-7.8	1.78 V	287	1.41	44.83

- REMARKS:**
1. Emission level (dBuV/m) = Raw Value (dBuV) + Correction Factor (dB/m).
 2. Correction Factor (dB/m) = Antenna Factor (dB/m) + Cable Factor (dB).
 3. The other emission levels were very low against the limit.
 4. Margin value = Emission level – Limit value.
 5. “ * “: Fundamental frequency.



A D T

EUT TEST CONDITION		MEASUREMENT DETAIL	
CHANNEL	Channel 1	FREQUENCY RANGE	1 ~ 25GHz
INPUT POWER (SYSTEM)	120Vac, 60 Hz	DETECTOR FUNCTION	Peak (PK) Average (AV)
ENVIRONMENTAL CONDITIONS	23deg. C, 70%RH 1006 hPa	TESTED BY	Match Tsui
TEST MODE	B		

ANTENNA POLARITY & TEST DISTANCE: HORIZONTAL AT 3 M								
NO.	FREQ. (MHz)	EMISSION LEVEL (dBuV/m)	LIMIT (dBuV/m)	MARGIN (dB)	ANTENNA HEIGHT (m)	TABLE ANGLE (Degree)	RAW VALUE (dBuV)	CORRECTION FACTOR (dB/m)
1	2386.00	57.6 PK	74.0	-16.4	1.31 H	239	27.16	30.42
2	2386.00	47.8 AV	54.0	-6.2	1.31 H	239	17.40	30.42
3	*2412.00	104.1 PK			1.31 H	239	73.57	30.51
4	*2412.00	99.8 AV			1.31 H	239	69.31	30.51
5	4824.00	49.3 PK	74.0	-24.7	1.09 H	26	13.17	36.09
6	4824.00	38.0 AV	54.0	-16.0	1.09 H	26	1.95	36.09
ANTENNA POLARITY & TEST DISTANCE: VERTICAL AT 3 M								
NO.	FREQ. (MHz)	EMISSION LEVEL (dBuV/m)	LIMIT (dBuV/m)	MARGIN (dB)	ANTENNA HEIGHT (m)	TABLE ANGLE (Degree)	RAW VALUE (dBuV)	CORRECTION FACTOR (dB/m)
1	2390.00	56.7 PK	74.0	-17.3	1.03 V	224	26.23	30.43
2	2390.00	46.1 AV	54.0	-7.9	1.03 V	224	15.68	30.43
3	*2412.00	100.8 PK			1.03 V	225	70.24	30.51
4	*2412.00	96.4 AV			1.03 V	225	65.92	30.51
5	4824.00	47.9 PK	74.0	-26.1	1.01 V	142	11.85	36.09
6	4824.00	36.1 AV	54.0	-17.9	1.01 V	142	0.03	36.09

- REMARKS:**
1. Emission level (dBuV/m) = Raw Value (dBuV) + Correction Factor (dB/m).
 2. Correction Factor (dB/m) = Antenna Factor (dB/m) + Cable Factor (dB).
 3. The other emission levels were very low against the limit.
 4. Margin value = Emission level – Limit value.
 5. “ * ”: Fundamental frequency.



A D T

EUT TEST CONDITION		MEASUREMENT DETAIL	
CHANNEL	Channel 6	FREQUENCY RANGE	1 ~ 25GHz
INPUT POWER (SYSTEM)	120Vac, 60 Hz	DETECTOR FUNCTION	Peak (PK) Average (AV)
ENVIRONMENTAL CONDITIONS	23deg. C, 70%RH 1006 hPa	TESTED BY	Match Tsui
TEST MODE	B		

ANTENNA POLARITY & TEST DISTANCE: HORIZONTAL AT 3 M								
NO.	FREQ. (MHz)	EMISSION LEVEL (dBuV/m)	LIMIT (dBuV/m)	MARGIN (dB)	ANTENNA HEIGHT (m)	TABLE ANGLE (Degree)	RAW VALUE (dBuV)	CORRECTION FACTOR (dB/m)
1	*2437.00	103.7 PK			1.30 H	241	73.09	30.60
2	*2437.00	99.4 AV			1.30 H	241	68.83	30.60
3	4874.00	49.5 PK	74.0	-24.5	1.03 H	211	13.36	36.12
4	4874.00	38.3 AV	54.0	-15.7	1.03 H	211	2.14	36.12
ANTENNA POLARITY & TEST DISTANCE: VERTICAL AT 3 M								
NO.	FREQ. (MHz)	EMISSION LEVEL (dBuV/m)	LIMIT (dBuV/m)	MARGIN (dB)	ANTENNA HEIGHT (m)	TABLE ANGLE (Degree)	RAW VALUE (dBuV)	CORRECTION FACTOR (dB/m)
1	*2437.00	100.4 PK			1.05 V	226	69.76	30.60
2	*2437.00	96.1 AV			1.05 V	226	65.45	30.60
3	4874.00	47.6 PK	74.0	-26.4	1.08 V	135	11.52	36.12
4	4874.00	35.9 AV	54.0	-18.1	1.08 V	135	-0.20	36.12

- REMARKS:**
1. Emission level (dBuV/m) = Raw Value (dBuV) + Correction Factor (dB/m).
 2. Correction Factor (dB/m) = Antenna Factor (dB/m) + Cable Factor (dB).
 3. The other emission levels were very low against the limit.
 4. Margin value = Emission level – Limit value.
 5. “ * “: Fundamental frequency.



A D T

EUT TEST CONDITION		MEASUREMENT DETAIL	
CHANNEL	Channel 11	FREQUENCY RANGE	1 ~ 25GHz
INPUT POWER (SYSTEM)	120Vac, 60 Hz	DETECTOR FUNCTION	Peak (PK) Average (AV)
ENVIRONMENTAL CONDITIONS	23deg. C, 70%RH 1006 hPa	TESTED BY	Match Tsui
TEST MODE	B		

ANTENNA POLARITY & TEST DISTANCE: HORIZONTAL AT 3 M								
NO.	FREQ. (MHz)	EMISSION LEVEL (dBuV/m)	LIMIT (dBuV/m)	MARGIN (dB)	ANTENNA HEIGHT (m)	TABLE ANGLE (Degree)	RAW VALUE (dBuV)	CORRECTION FACTOR (dB/m)
1	*2462.00	103.3 PK			1.28 H	243	72.58	30.68
2	*2462.00	99.1 AV			1.28 H	243	68.37	30.68
3	2483.50	57.2 PK	74.0	-16.8	1.28 H	243	26.48	30.75
4	2483.50	47.5 AV	54.0	-6.6	1.28 H	243	16.70	30.75
5	4924.00	49.0 PK	74.0	-25.0	1.12 H	46	12.82	36.21
6	4924.00	37.9 AV	54.0	-16.1	1.12 H	46	1.71	36.21
ANTENNA POLARITY & TEST DISTANCE: VERTICAL AT 3 M								
NO.	FREQ. (MHz)	EMISSION LEVEL (dBuV/m)	LIMIT (dBuV/m)	MARGIN (dB)	ANTENNA HEIGHT (m)	TABLE ANGLE (Degree)	RAW VALUE (dBuV)	CORRECTION FACTOR (dB/m)
1	*2462.00	99.9 PK			1.06 V	228	69.23	30.68
2	*2462.00	95.7 AV			1.06 V	228	65.00	30.68
3	2483.50	56.3 PK	74.0	-17.7	1.06 V	228	25.53	30.75
4	2483.50	45.9 AV	54.0	-8.1	1.06 V	228	15.16	30.75
5	4924.00	47.5 PK	74.0	-26.5	1.10 V	149	11.30	36.21
6	4924.00	35.8 AV	54.0	-18.2	1.10 V	149	-0.38	36.21

- REMARKS:**
1. Emission level (dBuV/m) = Raw Value (dBuV) + Correction Factor (dB/m).
 2. Correction Factor (dB/m) = Antenna Factor (dB/m) + Cable Factor (dB).
 3. The other emission levels were very low against the limit.
 4. Margin value = Emission level – Limit value.
 5. “ * “: Fundamental frequency.



802.11g

EUT TEST CONDITION		MEASUREMENT DETAIL	
CHANNEL	Channel 1	FREQUENCY RANGE	1 ~ 25GHz
INPUT POWER (SYSTEM)	120Vac, 60 Hz	DETECTOR FUNCTION	Peak (PK) Average (AV)
ENVIRONMENTAL CONDITIONS	23deg. C, 70%RH 1006 hPa	TESTED BY	Match Tsui
TEST MODE	A		

ANTENNA POLARITY & TEST DISTANCE: HORIZONTAL AT 3 M								
NO.	FREQ. (MHz)	EMISSION LEVEL (dBuV/m)	LIMIT (dBuV/m)	MARGIN (dB)	ANTENNA HEIGHT (m)	TABLE ANGLE (Degree)	RAW VALUE (dBuV)	CORRECTION FACTOR (dB/m)
1	2390.00	59.3 PK	74.0	-14.7	1.22 H	190	27.04	32.22
2	2390.00	46.4 AV	54.0	-7.6	1.22 H	190	14.18	32.22
3	*2412.00	98.6 PK			1.23 H	190	66.25	32.30
4	*2412.00	88.1 AV			1.23 H	190	55.78	32.30
5	4824.00	47.4 PK	74.0	-26.6	1.17 H	230	9.04	38.33
6	4824.00	34.7 AV	54.0	-19.3	1.17 H	230	-3.65	38.33
ANTENNA POLARITY & TEST DISTANCE: VERTICAL AT 3 M								
NO.	FREQ. (MHz)	EMISSION LEVEL (dBuV/m)	LIMIT (dBuV/m)	MARGIN (dB)	ANTENNA HEIGHT (m)	TABLE ANGLE (Degree)	RAW VALUE (dBuV)	CORRECTION FACTOR (dB/m)
1	2390.00	66.8 PK	74.0	-7.2	1.12 V	278	34.58	32.22
2	2390.00	51.5 AV	54.0	-2.5	1.12 V	278	19.27	32.22
3	*2412.00	108.2 PK			1.12 V	51	75.91	32.30
4	*2412.00	97.8 AV			1.12 V	51	65.48	32.30
5	4824.00	48.3 PK	74.0	-25.8	1.00 V	0	9.92	38.33
6	4824.00	35.3 AV	54.0	-18.7	1.00 V	0	-3.07	38.33

- REMARKS:**
1. Emission level (dBuV/m) = Raw Value (dBuV) + Correction Factor (dB/m).
 2. Correction Factor (dB/m) = Antenna Factor (dB/m) + Cable Factor (dB).
 3. The other emission levels were very low against the limit.
 4. Margin value = Emission level – Limit value.
 5. “ * “: Fundamental frequency.



A D T

EUT TEST CONDITION		MEASUREMENT DETAIL	
CHANNEL	Channel 6	FREQUENCY RANGE	1 ~ 25GHz
INPUT POWER (SYSTEM)	120Vac, 60 Hz	DETECTOR FUNCTION	Peak (PK) Average (AV)
ENVIRONMENTAL CONDITIONS	23deg. C, 70%RH 1006 hPa	TESTED BY	Match Tsui
TEST MODE	A		

ANTENNA POLARITY & TEST DISTANCE: HORIZONTAL AT 3 M								
NO.	FREQ. (MHz)	EMISSION LEVEL (dBuV/m)	LIMIT (dBuV/m)	MARGIN (dB)	ANTENNA HEIGHT (m)	TABLE ANGLE (Degree)	RAW VALUE (dBuV)	CORRECTION FACTOR (dB/m)
1	*2437.00	98.6 PK			1.00 H	173	66.16	32.39
2	*2437.00	88.9 AV			1.00 H	173	56.49	32.39
3	4874.00	47.4 PK	74.0	-26.6	1.06 H	180	9.00	38.41
4	4874.00	34.3 AV	54.0	-19.7	1.06 H	180	-4.13	38.41
ANTENNA POLARITY & TEST DISTANCE: VERTICAL AT 3 M								
NO.	FREQ. (MHz)	EMISSION LEVEL (dBuV/m)	LIMIT (dBuV/m)	MARGIN (dB)	ANTENNA HEIGHT (m)	TABLE ANGLE (Degree)	RAW VALUE (dBuV)	CORRECTION FACTOR (dB/m)
1	*2437.00	107.8 PK			1.10 V	55	75.42	32.39
2	*2437.00	97.4 AV			1.10 V	55	64.96	32.39
3	4874.00	48.6 PK	74.0	-25.4	1.10 V	360	10.22	38.41
4	4874.00	35.3 AV	54.0	-18.7	1.10 V	360	-3.10	38.41

- REMARKS:**
1. Emission level (dBuV/m) = Raw Value (dBuV) + Correction Factor (dB/m).
 2. Correction Factor (dB/m) = Antenna Factor (dB/m) + Cable Factor (dB).
 3. The other emission levels were very low against the limit.
 4. Margin value = Emission level – Limit value.
 5. “ * “: Fundamental frequency.



A D T

EUT TEST CONDITION		MEASUREMENT DETAIL	
CHANNEL	Channel 11	FREQUENCY RANGE	1 ~ 25GHz
INPUT POWER (SYSTEM)	120Vac, 60 Hz	DETECTOR FUNCTION	Peak (PK) Average (AV)
ENVIRONMENTAL CONDITIONS	23deg. C, 70%RH 1006 hPa	TESTED BY	Match Tsui
TEST MODE	A		

ANTENNA POLARITY & TEST DISTANCE: HORIZONTAL AT 3 M								
NO.	FREQ. (MHz)	EMISSION LEVEL (dBuV/m)	LIMIT (dBuV/m)	MARGIN (dB)	ANTENNA HEIGHT (m)	TABLE ANGLE (Degree)	RAW VALUE (dBuV)	CORRECTION FACTOR (dB/m)
1	*2462.00	98.2 PK			1.23 H	186	65.69	32.48
2	*2462.00	88.1 AV			1.23 H	186	55.57	32.48
3	2483.50	58.9 PK	74.0	-15.1	1.24 H	177	26.36	32.56
4	2483.50	47.1 AV	54.0	-6.9	1.24 H	177	14.56	32.56
5	4924.00	48.1 PK	74.0	-25.9	1.24 H	360	9.58	38.51
6	4924.00	35.6 AV	54.0	-18.4	1.24 H	360	-2.94	38.51
ANTENNA POLARITY & TEST DISTANCE: VERTICAL AT 3 M								
NO.	FREQ. (MHz)	EMISSION LEVEL (dBuV/m)	LIMIT (dBuV/m)	MARGIN (dB)	ANTENNA HEIGHT (m)	TABLE ANGLE (Degree)	RAW VALUE (dBuV)	CORRECTION FACTOR (dB/m)
1	*2462.00	107.8 PK			1.09 V	17	75.34	32.48
2	*2462.00	97.2 AV			1.09 V	17	64.75	32.48
3	2483.50	68.0 PK	74.0	-6.0	1.09 V	57	35.40	32.56
4	2483.50	50.9 AV	54.0	-3.1	1.09 V	57	18.33	32.56
5	4924.00	48.2 PK	74.0	-25.8	1.09 V	360	9.66	38.51
6	4924.00	35.6 AV	54.0	-18.4	1.09 V	360	-2.87	38.51

- REMARKS:**
1. Emission level (dBuV/m) = Raw Value (dBuV) + Correction Factor (dB/m).
 2. Correction Factor (dB/m) = Antenna Factor (dB/m) + Cable Factor (dB).
 3. The other emission levels were very low against the limit.
 4. Margin value = Emission level – Limit value.
 5. “ * “: Fundamental frequency.



A D T

EUT TEST CONDITION		MEASUREMENT DETAIL	
CHANNEL	Channel 1	FREQUENCY RANGE	1 ~ 25GHz
INPUT POWER (SYSTEM)	120Vac, 60 Hz	DETECTOR FUNCTION	Peak (PK) Average (AV)
ENVIRONMENTAL CONDITIONS	23deg. C, 70%RH 1006 hPa	TESTED BY	Match Tsui
TEST MODE	B		

ANTENNA POLARITY & TEST DISTANCE: HORIZONTAL AT 3 M								
NO.	FREQ. (MHz)	EMISSION LEVEL (dBuV/m)	LIMIT (dBuV/m)	MARGIN (dB)	ANTENNA HEIGHT (m)	TABLE ANGLE (Degree)	RAW VALUE (dBuV)	CORRECTION FACTOR (dB/m)
1	2390.00	65.6 PK	74.0	-8.4	1.33 H	240	35.14	30.43
2	2390.00	49.2 AV	54.0	-4.8	1.33 H	240	18.74	30.43
3	*2412.00	103.6 PK			1.32 H	239	73.11	30.51
4	*2412.00	94.5 AV			1.32 H	239	64.03	30.51
5	4824.00	45.7 PK	74.0	-28.3	1.02 H	213	9.59	36.09
6	4824.00	33.8 AV	54.0	-20.2	1.02 H	213	-2.25	36.09
ANTENNA POLARITY & TEST DISTANCE: VERTICAL AT 3 M								
NO.	FREQ. (MHz)	EMISSION LEVEL (dBuV/m)	LIMIT (dBuV/m)	MARGIN (dB)	ANTENNA HEIGHT (m)	TABLE ANGLE (Degree)	RAW VALUE (dBuV)	CORRECTION FACTOR (dB/m)
1	2390.00	60.0 PK	74.0	-14.0	1.38 V	19	29.59	30.43
2	2390.00	45.9 AV	54.0	-8.1	1.38 V	19	15.43	30.43
3	*2412.00	100.1 PK			1.38 V	19	69.61	30.51
4	*2412.00	90.1 AV			1.38 V	19	59.59	30.51
5	4824.00	45.1 PK	74.0	-28.9	1.06 V	59	9.04	36.09
6	4824.00	33.3 AV	54.0	-20.7	1.06 V	59	-2.80	36.09

- REMARKS:**
1. Emission level (dBuV/m) = Raw Value (dBuV) + Correction Factor (dB/m).
 2. Correction Factor (dB/m) = Antenna Factor (dB/m) + Cable Factor (dB).
 3. The other emission levels were very low against the limit.
 4. Margin value = Emission level – Limit value.
 5. “ * ”: Fundamental frequency.



A D T

EUT TEST CONDITION		MEASUREMENT DETAIL	
CHANNEL	Channel 6	FREQUENCY RANGE	1 ~ 25GHz
INPUT POWER (SYSTEM)	120Vac, 60 Hz	DETECTOR FUNCTION	Peak (PK) Average (AV)
ENVIRONMENTAL CONDITIONS	23deg. C, 70%RH 1006 hPa	TESTED BY	Match Tsui
TEST MODE	B		

ANTENNA POLARITY & TEST DISTANCE: HORIZONTAL AT 3 M								
NO.	FREQ. (MHz)	EMISSION LEVEL (dBuV/m)	LIMIT (dBuV/m)	MARGIN (dB)	ANTENNA HEIGHT (m)	TABLE ANGLE (Degree)	RAW VALUE (dBuV)	CORRECTION FACTOR (dB/m)
1	*2437.00	103.1 PK			1.31 H	242	72.54	30.60
2	*2437.00	94.1 AV			1.31 H	242	63.46	30.60
3	4874.00	45.5 PK	74.0	-28.5	1.05 H	216	9.39	36.12
4	4874.00	33.7 AV	54.0	-20.3	1.05 H	216	-2.43	36.12
ANTENNA POLARITY & TEST DISTANCE: VERTICAL AT 3 M								
NO.	FREQ. (MHz)	EMISSION LEVEL (dBuV/m)	LIMIT (dBuV/m)	MARGIN (dB)	ANTENNA HEIGHT (m)	TABLE ANGLE (Degree)	RAW VALUE (dBuV)	CORRECTION FACTOR (dB/m)
1	*2437.00	99.6 PK			1.36 V	21	69.03	30.60
2	*2437.00	89.6 AV			1.36 V	21	59.03	30.60
3	4874.00	45.3 PK	74.0	-28.7	1.01 V	64	9.14	36.12
4	4874.00	33.4 AV	54.0	-20.6	1.01 V	64	-2.69	36.12

- REMARKS:**
1. Emission level (dBuV/m) = Raw Value (dBuV) + Correction Factor (dB/m).
 2. Correction Factor (dB/m) = Antenna Factor (dB/m) + Cable Factor (dB).
 3. The other emission levels were very low against the limit.
 4. Margin value = Emission level – Limit value.
 5. “ * “: Fundamental frequency.



A D T

EUT TEST CONDITION		MEASUREMENT DETAIL	
CHANNEL	Channel 11	FREQUENCY RANGE	1 ~ 25GHz
INPUT POWER (SYSTEM)	120Vac, 60 Hz	DETECTOR FUNCTION	Peak (PK) Average (AV)
ENVIRONMENTAL CONDITIONS	23deg. C, 70%RH 1006 hPa	TESTED BY	Match Tsui
TEST MODE	B		

ANTENNA POLARITY & TEST DISTANCE: HORIZONTAL AT 3 M								
NO.	FREQ. (MHz)	EMISSION LEVEL (dBuV/m)	LIMIT (dBuV/m)	MARGIN (dB)	ANTENNA HEIGHT (m)	TABLE ANGLE (Degree)	RAW VALUE (dBuV)	CORRECTION FACTOR (dB/m)
1	*2462.00	102.6 PK			1.30 H	248	71.95	30.68
2	*2462.00	93.6 AV			1.30 H	248	62.90	30.68
3	2483.50	62.7 PK	74.0	-11.3	1.30 H	248	31.99	30.75
4	2483.50	49.3 AV	54.0	-4.7	1.30 H	248	18.54	30.75
5	4924.00	45.4 PK	74.0	-28.6	1.01 H	253	9.21	36.21
6	4924.00	33.6 AV	54.0	-20.4	1.01 H	253	-2.60	36.21
ANTENNA POLARITY & TEST DISTANCE: VERTICAL AT 3 M								
NO.	FREQ. (MHz)	EMISSION LEVEL (dBuV/m)	LIMIT (dBuV/m)	MARGIN (dB)	ANTENNA HEIGHT (m)	TABLE ANGLE (Degree)	RAW VALUE (dBuV)	CORRECTION FACTOR (dB/m)
1	*2462.00	99.1 PK			1.35 V	23	68.46	30.68
2	*2462.00	89.1 AV			1.35 V	23	58.44	30.68
3	2483.50	60.1 PK	74.0	-13.9	1.35 V	23	29.39	30.75
4	2483.50	47.0 AV	54.0	-7.1	1.35 V	23	16.20	30.75
5	4924.00	45.4 PK	74.0	-28.6	1.06 V	219	9.17	36.21
6	4924.00	33.6 AV	54.0	-20.4	1.06 V	219	-2.65	36.21

- REMARKS:**
1. Emission level (dBuV/m) = Raw Value (dBuV) + Correction Factor (dB/m).
 2. Correction Factor (dB/m) = Antenna Factor (dB/m) + Cable Factor (dB).
 3. The other emission levels were very low against the limit.
 4. Margin value = Emission level – Limit value.
 5. “ * “: Fundamental frequency.



BELOW 1GHz WORST-CASE DATA : 802.11g

EUT TEST CONDITION		MEASUREMENT DETAIL	
CHANNEL	Channel 6	FREQUENCY RANGE	Below 1000MHz
INPUT POWER (SYSTEM)	120Vac, 60 Hz	DETECTOR FUNCTION	Quasi-Peak
ENVIRONMENTAL CONDITIONS	23deg. C, 65%RH 1005 hPa	TESTED BY	Lori Chiu
TEST MODE	A		

ANTENNA POLARITY & TEST DISTANCE: HORIZONTAL AT 3 M								
NO.	FREQ. (MHz)	EMISSION LEVEL (dBuV/m)	LIMIT (dBuV/m)	MARGIN (dB)	ANTENNA HEIGHT (m)	TABLE ANGLE (Degree)	RAW VALUE (dBuV)	CORRECTION FACTOR (dB/m)
1	183.50	39.3 QP	43.5	-4.2	1.25 H	238	27.35	11.92
2	216.55	38.5 QP	46.0	-7.5	1.00 H	193	27.20	11.33
3	234.05	37.9 QP	46.0	-8.1	1.50 H	196	25.77	12.12
4	282.66	37.6 QP	46.0	-8.4	1.00 H	100	24.24	13.37
5	350.71	36.1 QP	46.0	-9.9	1.00 H	358	21.22	14.86
6	381.82	36.8 QP	46.0	-9.2	1.00 H	325	21.16	15.62
7	502.36	36.1 QP	46.0	-10.0	1.25 H	139	16.73	19.31
8	531.53	38.6 QP	46.0	-7.4	1.25 H	121	18.36	20.20
ANTENNA POLARITY & TEST DISTANCE: VERTICAL AT 3 M								
NO.	FREQ. (MHz)	EMISSION LEVEL (dBuV/m)	LIMIT (dBuV/m)	MARGIN (dB)	ANTENNA HEIGHT (m)	TABLE ANGLE (Degree)	RAW VALUE (dBuV)	CORRECTION FACTOR (dB/m)
1	183.50	29.0 QP	43.5	-14.5	1.00 V	163	17.06	11.92
2	199.05	27.8 QP	43.5	-15.7	1.50 V	160	17.13	10.67
3	383.76	34.4 QP	46.0	-11.6	1.50 V	298	18.71	15.67
4	799.84	33.7 QP	46.0	-12.3	1.50 V	256	8.40	25.32
5	819.28	31.0 QP	46.0	-15.0	1.50 V	151	5.52	25.44
6	951.49	32.5 QP	46.0	-13.5	1.00 V	121	6.03	26.50

- REMARKS:**
1. Emission level (dBuV/m) = Raw Value (dBuV) + Correction Factor (dB/m).
 2. Correction Factor (dB/m) = Antenna Factor (dB/m) + Cable Factor (dB).
 3. The other emission levels were very low against the limit.
 4. Margin value = Emission level – Limit value.



A D T

EUT TEST CONDITION		MEASUREMENT DETAIL	
CHANNEL	Channel 6	FREQUENCY RANGE	Below 1000MHz
INPUT POWER (SYSTEM)	120Vac, 60 Hz	DETECTOR FUNCTION	Quasi-Peak
ENVIRONMENTAL CONDITIONS	23deg. C, 65%RH 1005 hPa	TESTED BY	Lori Chiu
TEST MODE	B		

ANTENNA POLARITY & TEST DISTANCE: HORIZONTAL AT 3 M								
NO.	FREQ. (MHz)	EMISSION LEVEL (dBuV/m)	LIMIT (dBuV/m)	MARGIN (dB)	ANTENNA HEIGHT (m)	TABLE ANGLE (Degree)	RAW VALUE (dBuV)	CORRECTION FACTOR (dB/m)
1	150.45	39.4 QP	43.5	-4.1	1.75 H	55	25.47	13.90
2	183.22	43.1 QP	43.5	-0.4	1.75 H	79	31.19	11.94
3	216.55	36.1 QP	46.0	-9.9	1.00 H	199	24.78	11.33
4	232.11	34.9 QP	46.0	-11.1	1.25 H	178	22.89	12.03
5	383.76	35.5 QP	46.0	-10.5	2.00 H	181	19.87	15.67
6	531.53	37.3 QP	46.0	-8.7	1.25 H	112	17.12	20.20
ANTENNA POLARITY & TEST DISTANCE: VERTICAL AT 3 M								
NO.	FREQ. (MHz)	EMISSION LEVEL (dBuV/m)	LIMIT (dBuV/m)	MARGIN (dB)	ANTENNA HEIGHT (m)	TABLE ANGLE (Degree)	RAW VALUE (dBuV)	CORRECTION FACTOR (dB/m)
1	150.45	31.8 QP	43.5	-11.7	2.00 V	151	17.90	13.90
2	183.50	39.1 QP	43.5	-4.4	2.00 V	142	27.14	11.92
3	381.82	34.9 QP	46.0	-11.1	1.75 V	130	19.30	15.62
4	799.84	31.5 QP	46.0	-14.5	1.50 V	256	6.19	25.32
5	899.00	30.4 QP	46.0	-15.6	1.25 V	148	4.32	26.10
6	947.60	30.9 QP	46.0	-15.1	1.75 V	301	4.39	26.47

- REMARKS:**
1. Emission level (dBuV/m) = Raw Value (dBuV) + Correction Factor (dB/m).
 2. Correction Factor (dB/m) = Antenna Factor (dB/m) + Cable Factor (dB).
 3. The other emission levels were very low against the limit.
 4. Margin value = Emission level – Limit value.

4.2 CONDUCTED EMISSION MEASUREMENT

4.2.1 LIMITS OF CONDUCTED EMISSION MEASUREMENT

FREQUENCY OF EMISSION (MHz)	CONDUCTED LIMIT (dB μ V)	
	Quasi-peak	Average
0.15-0.5	66 to 56	56 to 46
0.5-5	56	46
5-30	60	50

- NOTE:**
1. The lower limit shall apply at the transition frequencies.
 2. The limit decreases in line with the logarithm of the frequency in the range of 0.15 to 0.50 MHz.
 3. All emanations from a class A/B digital device or system, including any network of conductors and apparatus connected thereto, shall not exceed the level of field strengths specified above.

4.2.2 TEST INSTRUMENTS

DESCRIPTION & MANUFACTURER	MODEL NO.	SERIAL NO.	DATE OF CALIBRATION	DUE DATE OF CALIBRATION
Test Receiver ROHDE & SCHWARZ	ESCS30	100288	Sep. 24, 2009	Sep. 23, 2010
RF signal cable Woken	5D-FB	Cable-HYCO2-01	Dec. 31, 2008	Dec. 30, 2009
LISN ROHDE & SCHWARZ	ESH2-Z5	100100	Dec. 29, 2008	Dec. 28, 2009
LISN ROHDE & SCHWARZ	ESH3-Z5	100311	Jul. 29, 2009	Jul. 28, 2010
Software ADT	ADT_Cond_ V7.3.7	NA	NA	NA

- NOTE:**
1. The calibration interval of the above test instruments is 12 months and the calibrations are traceable to NML/ROC and NIST/USA.
 2. The test was performed in HwaYa Shielded Room 2.
 3. The VCCI Site Registration No. is C-2047.

4.2.3 TEST PROCEDURES

- a. The EUT was placed 0.4 meters from the conducting wall of the shielded room with EUT being connected to the power mains through a line impedance stabilization network (LISN). Other support units were connected to the power mains through another LISN. The two LISNs provide 50 ohm/ 50uH of coupling impedance for the measuring instrument.
- b. Both lines of the power mains connected to the EUT were checked for maximum conducted interference.
- c. The frequency range from 150kHz to 30MHz was searched. Emission levels under (Limit - 20dB) was not recorded.

NOTE: All modes of operation were investigated and the worst-case emissions are reported.

4.2.4 DEVIATION FROM TEST STANDARD

No deviation.

4.2.5 TEST SETUP

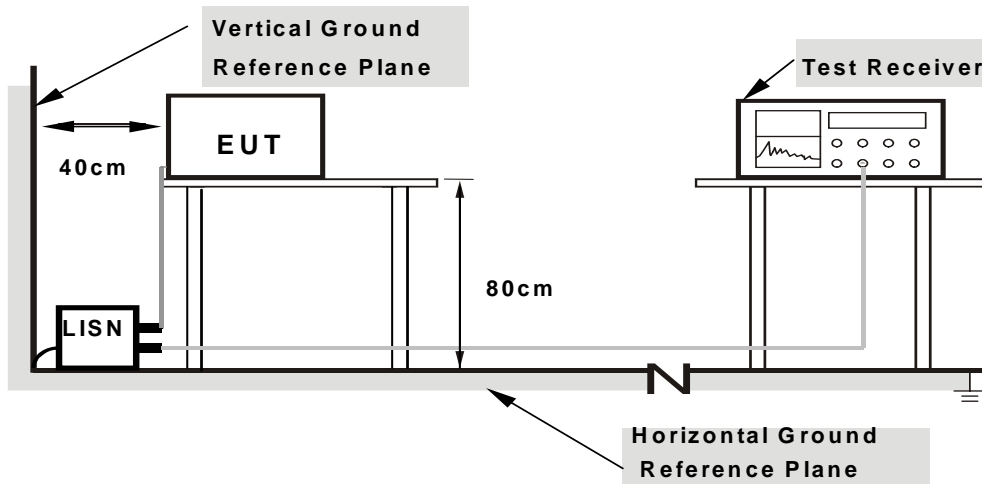

- Note:**
1. Support units were connected to second LISN.
 2. Both of LISNs (AMN) are 80 cm from EUT and at least 80 cm from other units and other metal planes

For the actual test configuration, please refer to the attached file (Test Setup Photo).

4.2.6 EUT OPERATING CONDITIONS

Same as 4.1.6.

4.2.7 TEST RESULTS

CONDUCTED WORST-CASE DATA: 802.11g

PHASE	Line 1	6dB BANDWIDTH	9kHz
TEST MODE	A		

No	Freq. [MHz]	Corr. Factor (dB)	Reading Value		Emission Level		Limit		Margin	
			[dB (uV)]		[dB (uV)]		[dB (uV)]		(dB)	
			Q.P.	AV.	Q.P.	AV.	Q.P.	AV.	Q.P.	AV.
1	0.170	0.13	45.79	-	45.92	-	64.98	54.98	-19.06	-
2	0.236	0.13	40.27	-	40.40	-	62.24	52.24	-21.84	-
3	0.373	0.14	31.82	-	31.96	-	58.44	48.44	-26.48	-
4	0.505	0.15	23.66	-	23.81	-	56.00	46.00	-32.19	-
5	15.988	0.58	24.96	-	25.54	-	60.00	50.00	-34.46	-
6	27.770	0.63	26.73	-	27.36	-	60.00	50.00	-32.64	-

- REMARKS:**
1. Q.P. and AV. are abbreviations of quasi-peak and average individually.
 2. "-": The Quasi-peak reading value also meets average limit and measurement with the average detector is unnecessary.
 3. The emission levels of other frequencies were very low against the limit.
 4. Margin value = Emission level - Limit value
 5. Correction factor = Insertion loss + Cable loss
 6. Emission Level = Correction Factor + Reading Value.

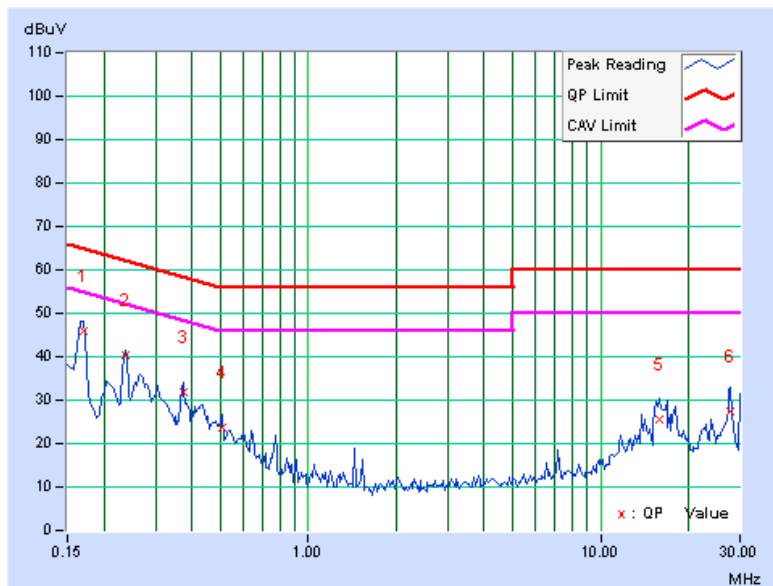

PHASE	Line 2	6dB BANDWIDTH	9kHz
TEST MODE	A		

No	Freq. [MHz]	Corr. Factor (dB)	Reading Value		Emission Level		Limit		Margin	
			[dB (uV)]		[dB (uV)]		[dB (uV)]		(dB)	
			Q.P.	AV.	Q.P.	AV.	Q.P.	AV.	Q.P.	AV.
1	0.170	0.13	44.03	-	44.16	-	64.98	54.98	-20.82	-
2	0.236	0.13	35.31	-	35.44	-	62.24	52.24	-26.79	-
3	0.275	0.14	28.29	-	28.43	-	60.97	50.97	-32.54	-
4	0.373	0.15	26.62	-	26.77	-	58.44	48.44	-31.67	-
5	16.470	0.71	22.78	-	23.49	-	60.00	50.00	-36.51	-
6	27.430	0.77	28.50	-	29.27	-	60.00	50.00	-30.73	-

- REMARKS:**
1. Q.P. and AV. are abbreviations of quasi-peak and average individually.
 2. "-": The Quasi-peak reading value also meets average limit and measurement with the average detector is unnecessary.
 3. The emission levels of other frequencies were very low against the limit.
 4. Margin value = Emission level - Limit value
 5. Correction factor = Insertion loss + Cable loss
 6. Emission Level = Correction Factor + Reading Value.

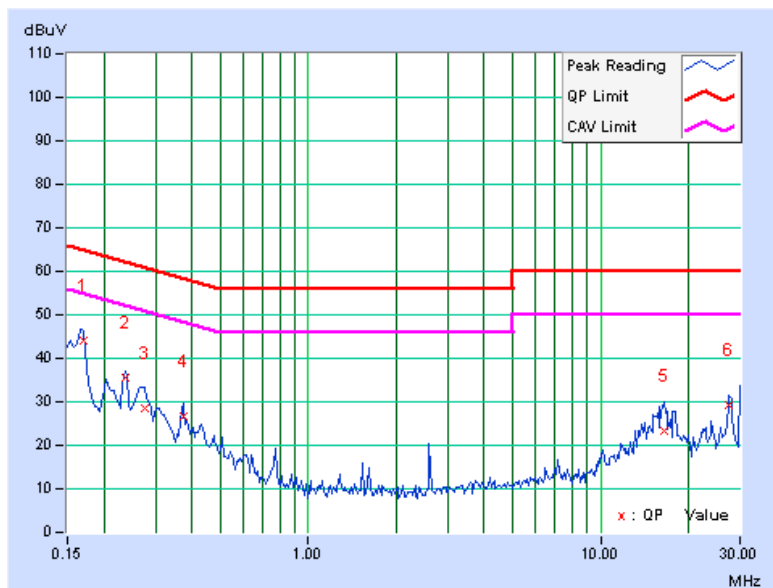

PHASE	Line 1	6dB BANDWIDTH	9kHz
TEST MODE	B		

No	Freq. [MHz]	Corr. Factor (dB)	Reading Value		Emission Level		Limit		Margin	
			[dB (uV)]		[dB (uV)]		[dB (uV)]		(dB)	
			Q.P.	AV.	Q.P.	AV.	Q.P.	AV.	Q.P.	AV.
1	0.170	0.13	44.33	-	44.46	-	64.98	54.98	-20.52	-
2	0.240	0.13	36.95	-	37.08	-	62.10	52.10	-25.02	-
3	0.373	0.14	29.92	-	30.06	-	58.44	48.44	-28.38	-
4	2.176	0.20	18.27	-	18.47	-	56.00	46.00	-37.53	-
5	15.992	0.58	24.92	-	25.50	-	60.00	50.00	-34.50	-
6	27.484	0.63	28.57	-	29.20	-	60.00	50.00	-30.80	-

- REMARKS:**
1. Q.P. and AV. are abbreviations of quasi-peak and average individually.
 2. "-": The Quasi-peak reading value also meets average limit and measurement with the average detector is unnecessary.
 3. The emission levels of other frequencies were very low against the limit.
 4. Margin value = Emission level - Limit value
 5. Correction factor = Insertion loss + Cable loss
 6. Emission Level = Correction Factor + Reading Value.

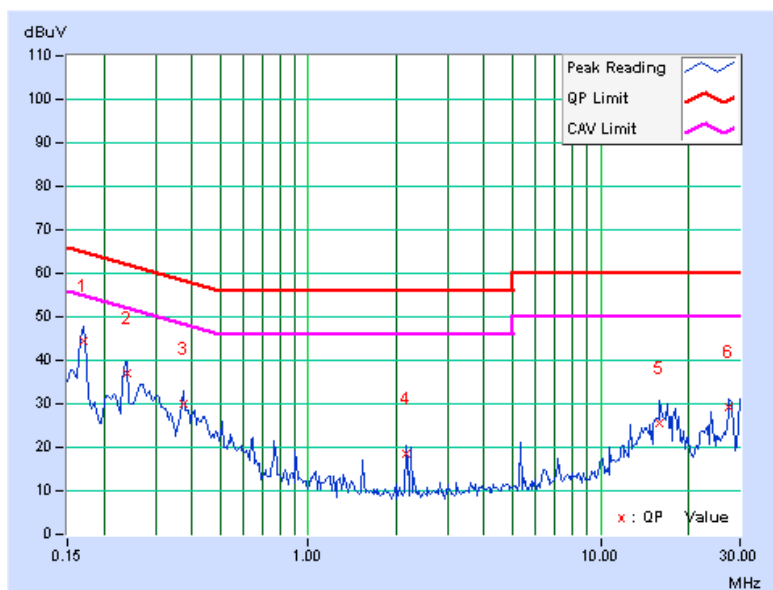

PHASE	Line 2	6dB BANDWIDTH	9kHz
TEST MODE	B		

No	Freq. [MHz]	Corr. Factor (dB)	Reading Value		Emission Level		Limit		Margin	
			[dB (uV)]		[dB (uV)]		[dB (uV)]		(dB)	
			Q.P.	AV.	Q.P.	AV.	Q.P.	AV.	Q.P.	AV.
1	0.170	0.13	43.83	-	43.96	-	64.98	54.98	-21.02	-
2	0.236	0.13	34.74	-	34.87	-	62.24	52.24	-27.36	-
3	0.271	0.14	32.29	-	32.43	-	61.08	51.08	-28.66	-
4	0.771	0.16	16.77	-	16.93	-	56.00	46.00	-39.07	-
5	16.477	0.71	22.42	-	23.13	-	60.00	50.00	-36.87	-
6	27.430	0.77	27.86	-	28.63	-	60.00	50.00	-31.37	-

- REMARKS:**
1. Q.P. and AV. are abbreviations of quasi-peak and average individually.
 2. "-": The Quasi-peak reading value also meets average limit and measurement with the average detector is unnecessary.
 3. The emission levels of other frequencies were very low against the limit.
 4. Margin value = Emission level - Limit value
 5. Correction factor = Insertion loss + Cable loss
 6. Emission Level = Correction Factor + Reading Value.

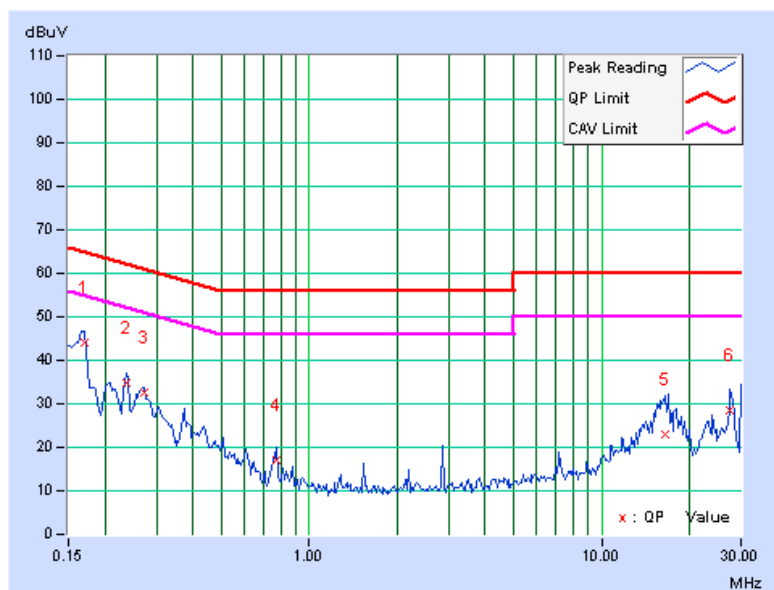

4.3 6dB BANDWIDTH MEASUREMENT

4.3.1 LIMITS OF 6dB BANDWIDTH MEASUREMENT

The minimum of 6dB Bandwidth Measurement is 0.5 MHz.

4.3.2 TEST INSTRUMENTS

DESCRIPTION & MANUFACTURER	MODEL NO.	SERIAL NO.	DATE OF CALIBRATION	DUE DATE OF CALIBRATION
R&S SPECTRUM ANALYZER	FSP40	100041	May 13, 2009	May 12, 2010

NOTE: The calibration interval of the above test instruments is 12 months and the calibrations are traceable to NML/ROC and NIST/USA.

4.3.3 TEST PROCEDURE

The transmitter output was connected to the spectrum analyzer through an attenuator. The bandwidth of the fundamental frequency was measured by spectrum analyzer with 100kHz RBW and 300kHz VBW. The 6dB bandwidth is defined as the total spectrum the power of which is higher than peak power minus 6dB.

4.3.4 DEVIATION FROM TEST STANDARD

No deviation.

4.3.5 TEST SETUP

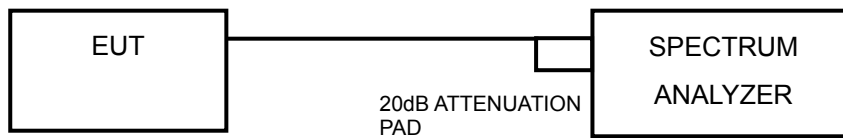

4.3.6 EUT OPERATING CONDITIONS

The software provided by client to enable the EUT under transmission condition continuously at lowest, middle and highest channel frequencies individually.

4.4 MAXIMUM OUTPUT POWER

4.4.1 LIMITS OF MAXIMUM OUTPUT POWER MEASUREMENT

The Maximum Peak Output Power Measurement is 30dBm.

4.4.2 INSTRUMENTS

DESCRIPTION & MANUFACTURER	MODEL NO.	SERIAL NO.	DATE OF CALIBRATION	DUE DATE OF CALIBRATION
High Speed Peak Power Meter	ML2495A	0824011	Jul. 30, 2009	Jul. 29, 2010
Power Sensor	MA2411B	0738171	Jul. 30, 2009	Jul. 29, 2010

NOTE:

1. The calibration interval of the above test instruments is 12 months and the calibrations are traceable to NML/ROC and NIST/USA.
2. Measurement Bandwidth of ML2495A is 65MHz greater than 6dB bandwidth of emission.

4.4.3 TEST PROCEDURES

A power sensor was used on the output port of the EUT. A power meter was used to read the response of the power sensor. Record the power level.

4.4.4 DEVIATION FROM TEST STANDARD

No deviation.

4.4.5 TEST SETUP

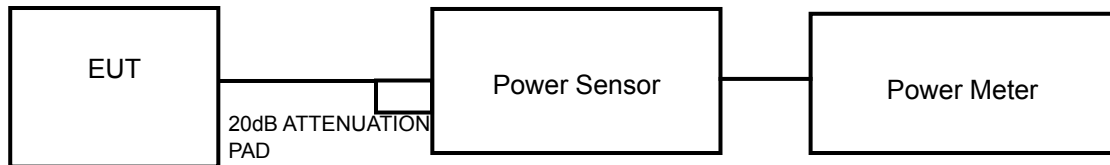

4.4.6 EUT OPERATING CONDITIONS

Same as Item 4.3.6.

4.4.7 TEST RESULTS

802.11b

CHAN	CHANNEL FREQUENCY (MHz)	POWER OUTPUT (mW)	POWER OUTPUT (dBm)	POWER LIMIT (dBm)	PASS/FAIL
1	2412	89.1	19.5	30	PASS
6	2437	91.2	19.6	30	PASS
11	2462	89.1	19.6	30	PASS

802.11g

CHAN	CHANNEL FREQUENCY (MHz)	POWER OUTPUT (mW)	POWER OUTPUT (dBm)	POWER LIMIT (dBm)	PASS/FAIL
1	2412	223.9	23.5	30	PASS
6	2437	229.1	23.6	30	PASS
11	2462	223.9	23.5	30	PASS



4.5 POWER SPECTRAL DENSITY MEASUREMENT

4.5.1 LIMITS OF POWER SPECTRAL DENSITY MEASUREMENT

The Maximum of Power Spectral Density Measurement is 8dBm.

4.5.2 TEST INSTRUMENTS

DESCRIPTION & MANUFACTURER	MODEL NO.	SERIAL NO.	DATE OF CALIBRATION	DUE DATE OF CALIBRATION
R&S SPECTRUM ANALYZER	FSP40	100041	May 13, 2009	May 12, 2010

NOTE: The calibration interval of the above test instruments is 12 months and the calibrations are traceable to NML/ROC and NIST/USA.

4.5.3 TEST PROCEDURE

The transmitter output was connected to the spectrum analyzer through an attenuator, the bandwidth of the fundamental frequency was measured with the spectrum analyzer using 3kHz RBW and 30kHz VBW, set sweep time = span/3kHz. The power spectral density was measured and recorded.

The sweep time is allowed to be longer than span/3kHz for a full response of the mixer in the spectrum analyzer.

4.5.4 DEVIATION FROM TEST STANDARD

No deviation.

4.5.5 TEST SETUP

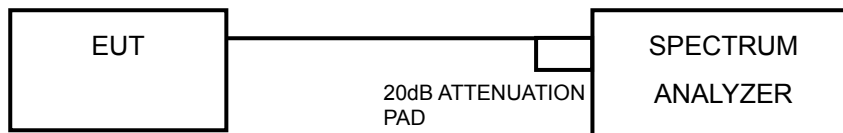

4.5.6 EUT OPERATING CONDITION

Same as Item 4.3.6.

4.6 BAND EDGES MEASUREMENT

4.6.1 LIMITS OF BAND EDGES MEASUREMENT

Below –20dB of the highest emission level of operating band (in 100kHz Resolution Bandwidth).

4.6.2 TEST INSTRUMENTS

DESCRIPTION & MANUFACTURER	MODEL NO.	SERIAL NO.	DATE OF CALIBRATION	DUE DATE OF CALIBRATION
R&S SPECTRUM ANALYZER	FSP40	100041	May 13, 2009	May 12, 2010

NOTE: The calibration interval of the above test instruments is 12 months and the calibrations are traceable to NML/ROC and NIST/USA.

4.6.3 TEST PROCEDURE

The transmitter output was connected to the spectrum analyzer via a low lose cable. Set both RBW and VBW of spectrum analyzer to 100kHz and 300kHz with suitable frequency span including 100MHz bandwidth from band edge. The band edges was measured and recorded.

The spectrum plots (Peak RBW = 100kHz, VBW = 300kHz; Average RBW = 1MHz, VBW = 10Hz) are attached on the following pages.

4.6.4 DEVIATION FROM TEST STANDARD

No deviation.

4.6.5 EUT OPERATING CONDITION

Same as Item 4.3.6.

4.6.6 TEST RESULTS

The spectrum plots are attached on the following pages. D1 line indicates the highest level, and D2 line indicates the 20dB offset below D1. It shows compliance with the requirement in part 15.247(d).

802.11b_FOR TEST MODE A

RESTRICT BAND (2310 ~ 2390 MHz)

FREQUENCY (MHz)	FUNDAMENTAL EMISSION (dBuV/m)	DELTA (dB)	MAXIMUM FIELD STRENGTH IN RESTRICT BAND (dBuV/m)	LIMIT (dBuV/m)
2412.00 (PK)	108.4	52.30	56.10	74.00
2412.00 (AV)	104.1	58.73	45.37	54.00

RESTRICT BAND (2483.5 ~ 2500 MHz)

FREQUENCY (MHz)	FUNDAMENTAL EMISSION (dBuV/m)	DELTA (dB)	MAXIMUM FIELD STRENGTH IN RESTRICT BAND (dBuV/m)	LIMIT (dBuV/m)
2462.00 (PK)	108.4	51.05	57.35	74.00
2462.00 (AV)	104.1	56.88	47.22	54.00

NOTE:

- Delta = Amplitude between the peak of the fundamental and the peak of the band edge emission. Please check following 3 pages.
- Maximum field strength in restrict band = Fundamental emission – Delta.

FOR TEST MODE B

RESTRICT BAND (2310 ~ 2390 MHz)

FREQUENCY (MHz)	FUNDAMENTAL EMISSION (dBuV/m)	DELTA (dB)	MAXIMUM FIELD STRENGTH IN RESTRICT BAND (dBuV/m)	LIMIT (dBuV/m)
2412.00 (PK)	104.1	52.30	51.80	74.00
2412.00 (AV)	99.8	58.73	41.07	54.00

RESTRICT BAND (2483.5 ~ 2500 MHz)

FREQUENCY (MHz)	FUNDAMENTAL EMISSION (dBuV/m)	DELTA (dB)	MAXIMUM FIELD STRENGTH IN RESTRICT BAND (dBuV/m)	LIMIT (dBuV/m)
2462.00 (PK)	103.3	51.05	52.25	74.00
2462.00 (AV)	99.1	56.88	42.22	54.00

NOTE:

- Delta = Amplitude between the peak of the fundamental and the peak of the band edge emission. Please check following 3 pages.
- Maximum field strength in restrict band = Fundamental emission – Delta.



A D T

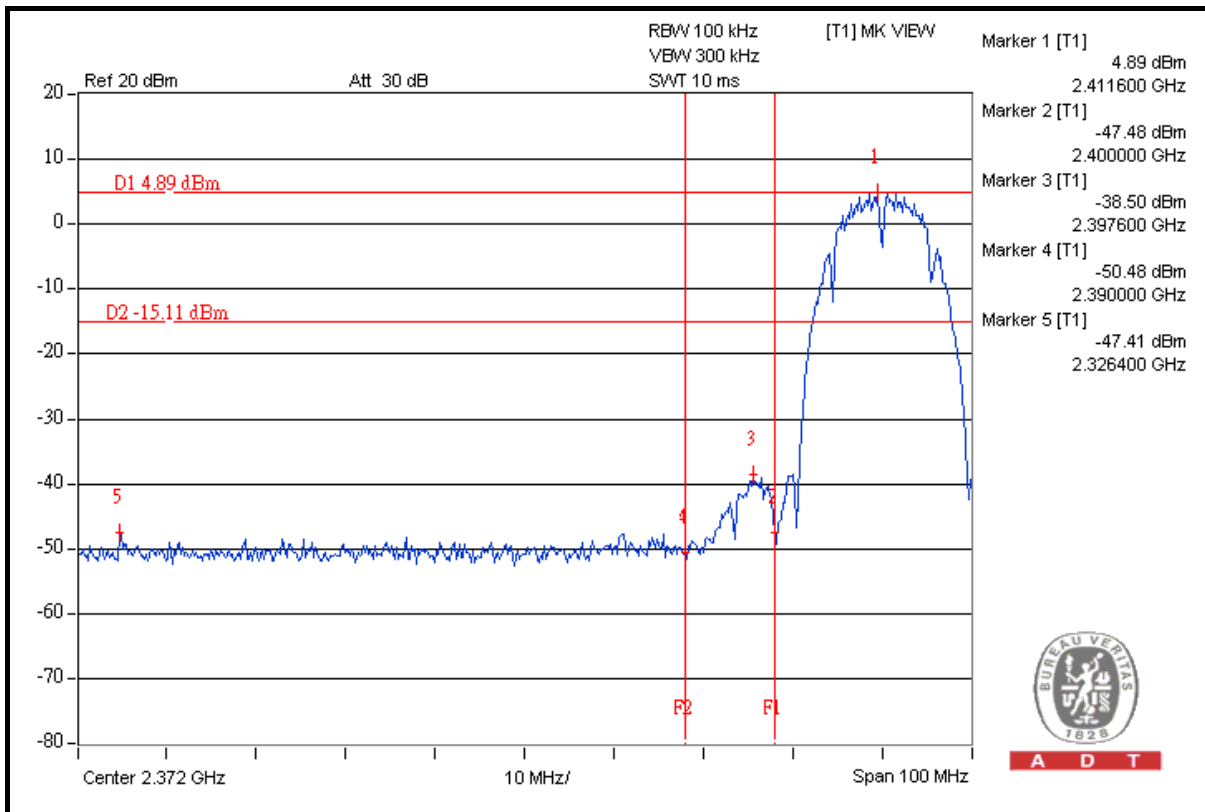

A D T

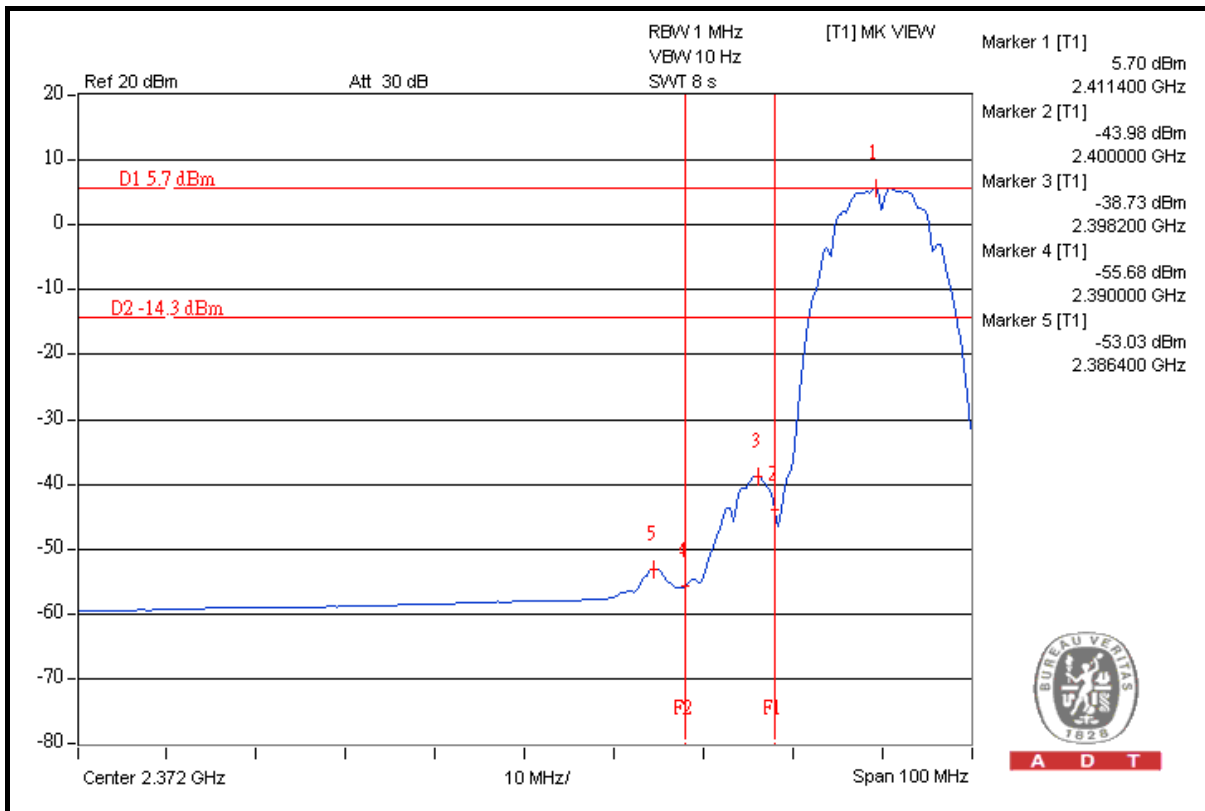

A D T



A D T

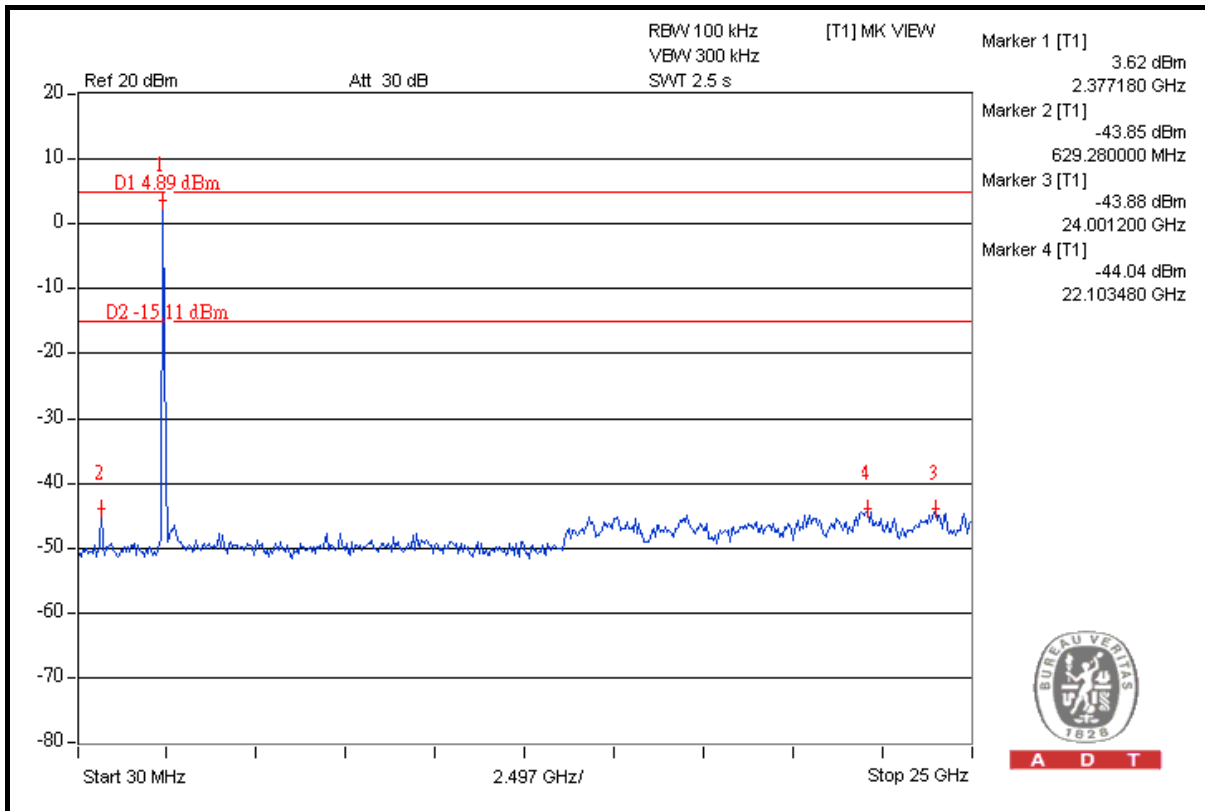

A D T

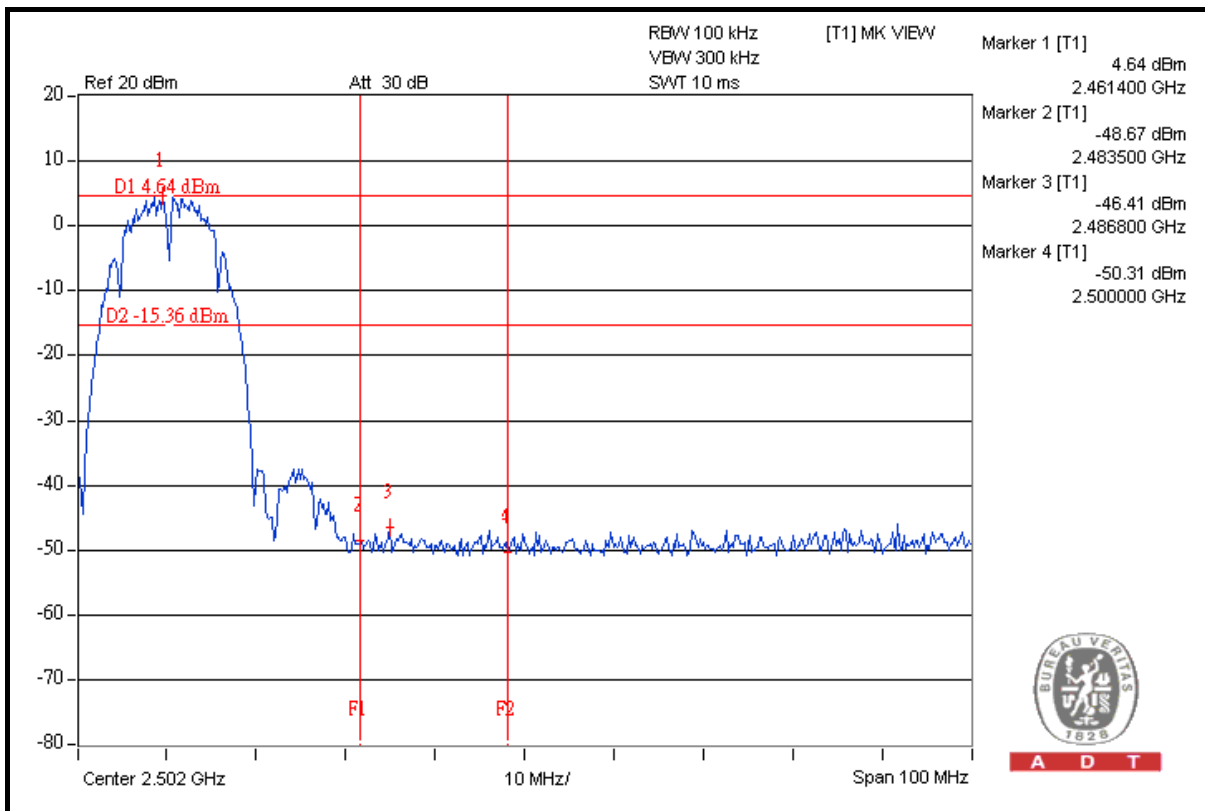

A D T



A D T

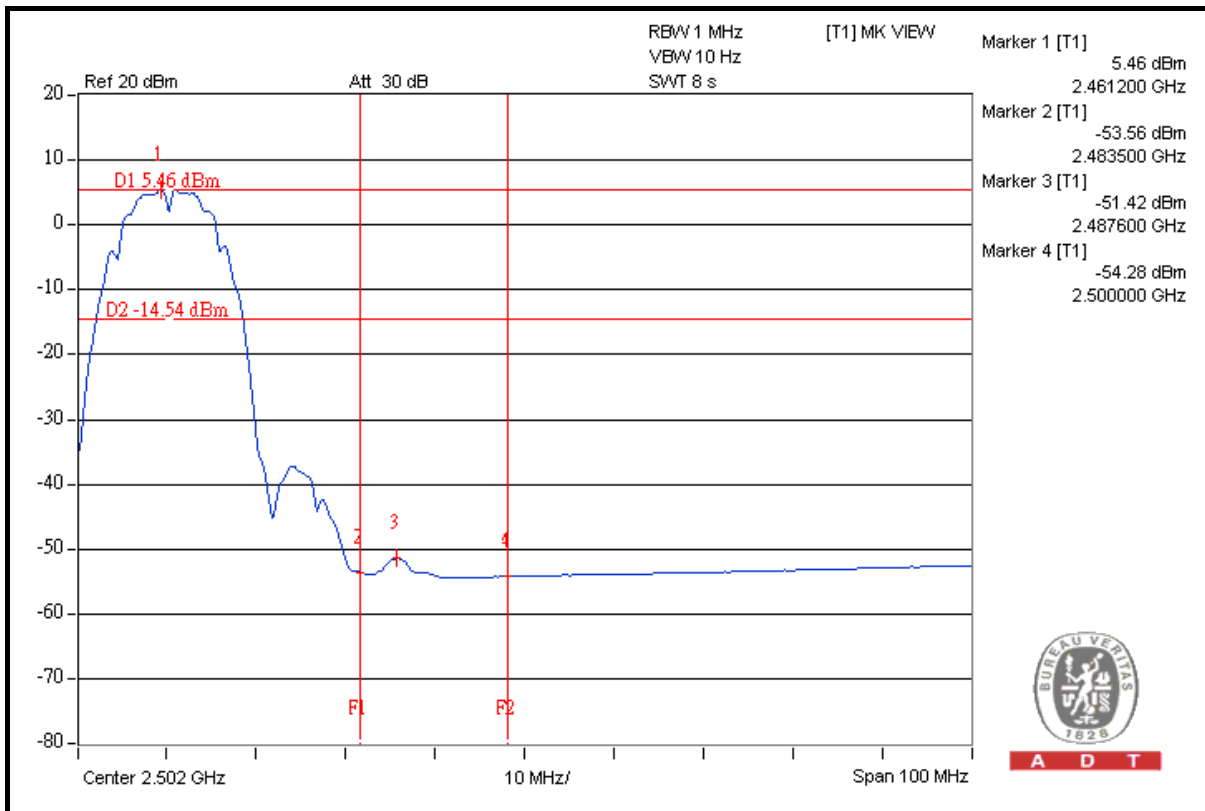

A D T

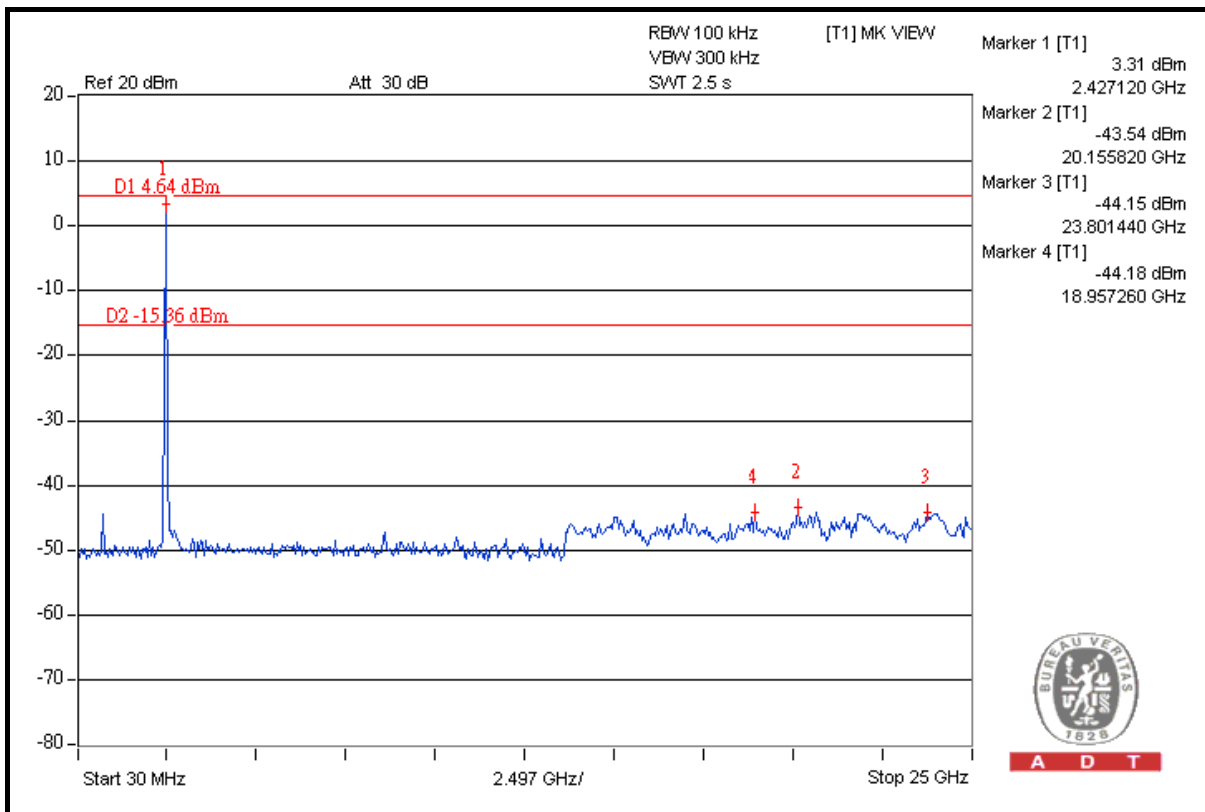

A D T

802.11g _FOR TEST MODE A

RESTRICT BAND (2310 ~ 2390 MHz)

FREQUENCY (MHz)	FUNDAMENTAL EMISSION (dBuV/m)	DELTA (dB)	MAXIMUM FIELD STRENGTH IN RESTRICT BAND (dBuV/m)	LIMIT (dBuV/m)
2412.00 (PK)	108.2	40.31	67.89	74.00
2412.00 (AV)	97.8	46.03	51.77	54.00

RESTRICT BAND (2483.5 ~ 2500 MHz)

FREQUENCY (MHz)	FUNDAMENTAL EMISSION (dBuV/m)	DELTA (dB)	MAXIMUM FIELD STRENGTH IN RESTRICT BAND (dBuV/m)	LIMIT (dBuV/m)
2462.00 (PK)	107.8	38.49	69.31	74.00
2462.00 (AV)	97.2	45.25	51.95	54.00

NOTE:

1. Delta = Amplitude between the peak of the fundamental and the peak of the band edge emission. Please check following 3 pages.
2. Maximum field strength in restrict band = Fundamental emission – Delta.

FOR TEST MODE B

RESTRICT BAND (2310 ~ 2390 MHz)

FREQUENCY (MHz)	FUNDAMENTAL EMISSION (dBuV/m)	DELTA (dB)	MAXIMUM FIELD STRENGTH IN RESTRICT BAND (dBuV/m)	LIMIT (dBuV/m)
2412.00 (PK)	103.6	40.31	63.29	74.00
2412.00 (AV)	94.5	46.03	48.47	54.00

RESTRICT BAND (2483.5 ~ 2500 MHz)

FREQUENCY (MHz)	FUNDAMENTAL EMISSION (dBuV/m)	DELTA (dB)	MAXIMUM FIELD STRENGTH IN RESTRICT BAND (dBuV/m)	LIMIT (dBuV/m)
2462.00 (PK)	102.6	38.49	64.11	74.00
2462.00 (AV)	93.6	45.25	48.35	54.00

NOTE:

- Delta = Amplitude between the peak of the fundamental and the peak of the band edge emission. Please check following 3 pages.
- Maximum field strength in restrict band = Fundamental emission – Delta.



A D T

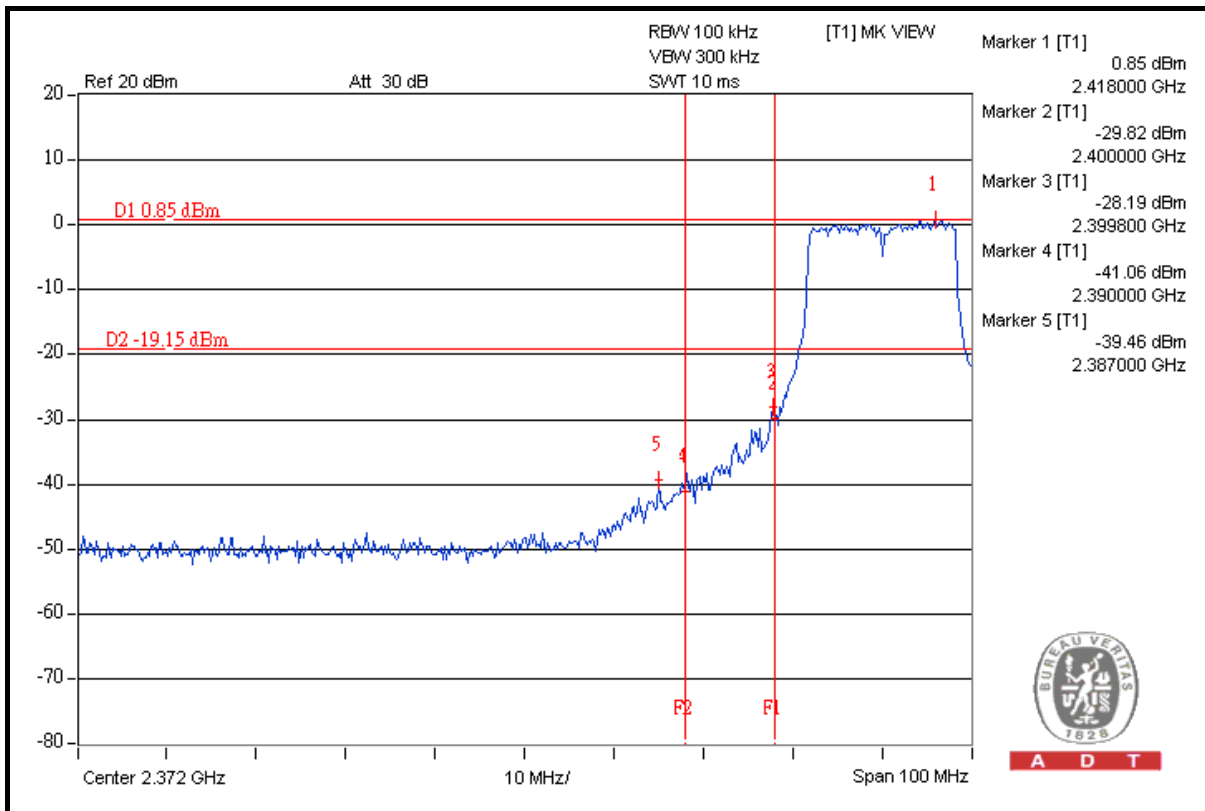

A D T

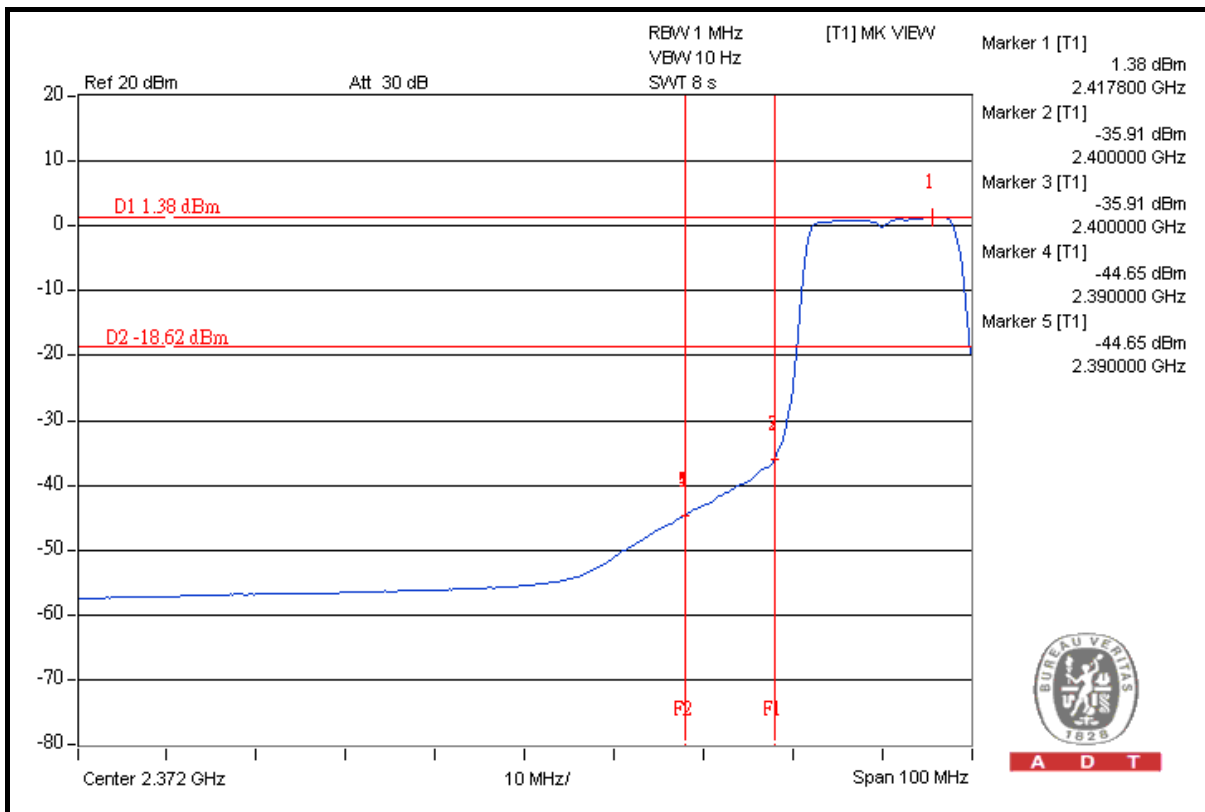

A D T



A D T

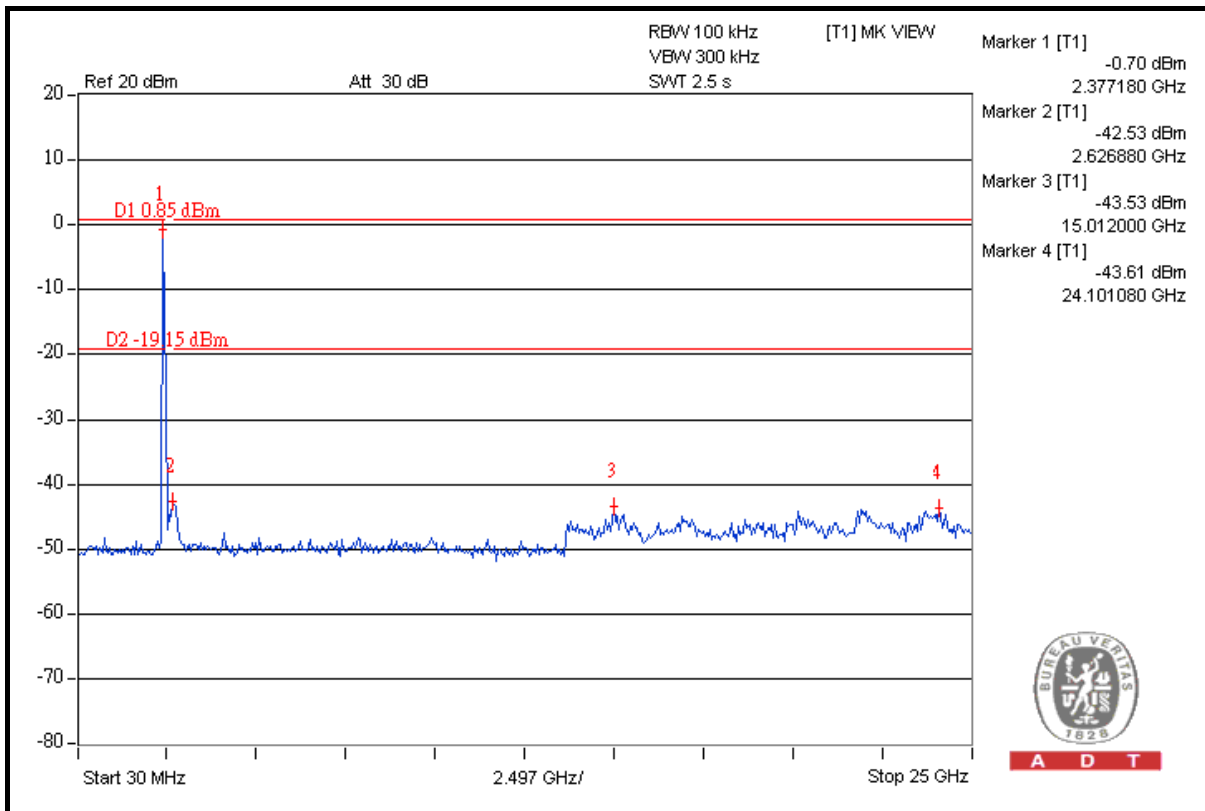

A D T

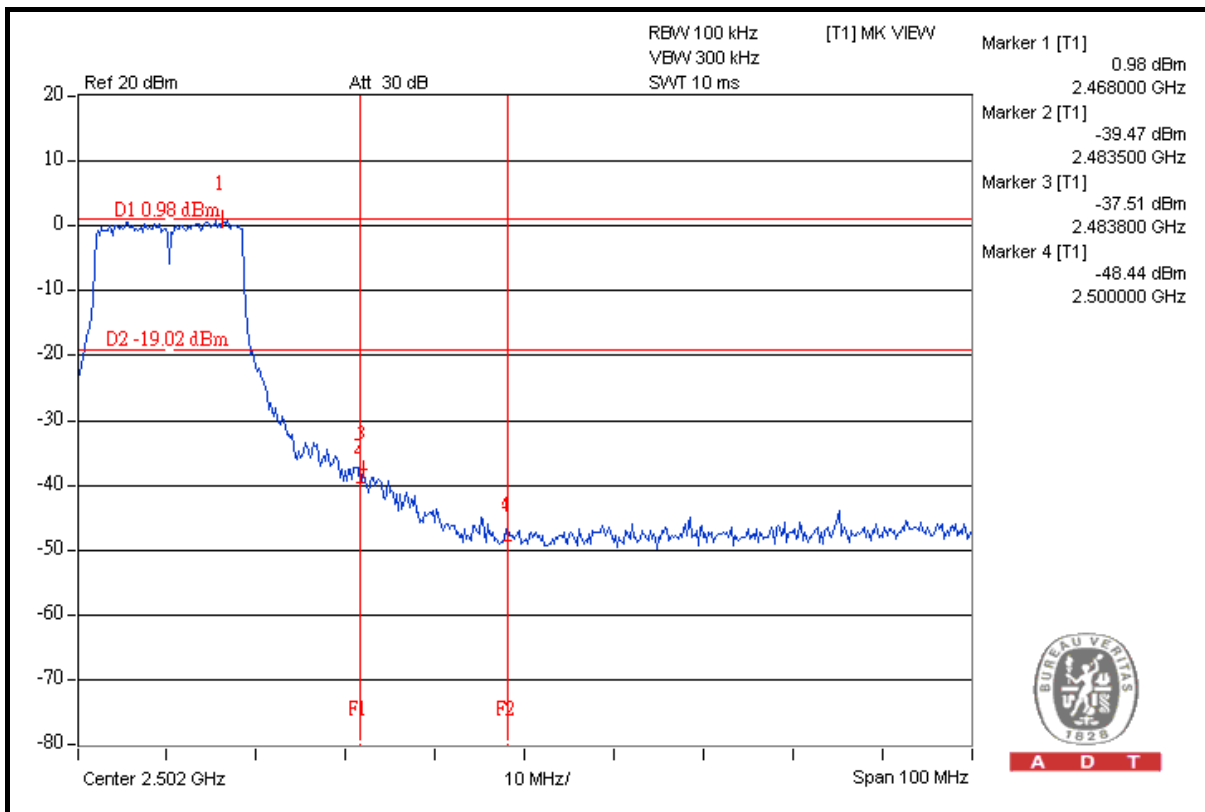

A D T



A D T

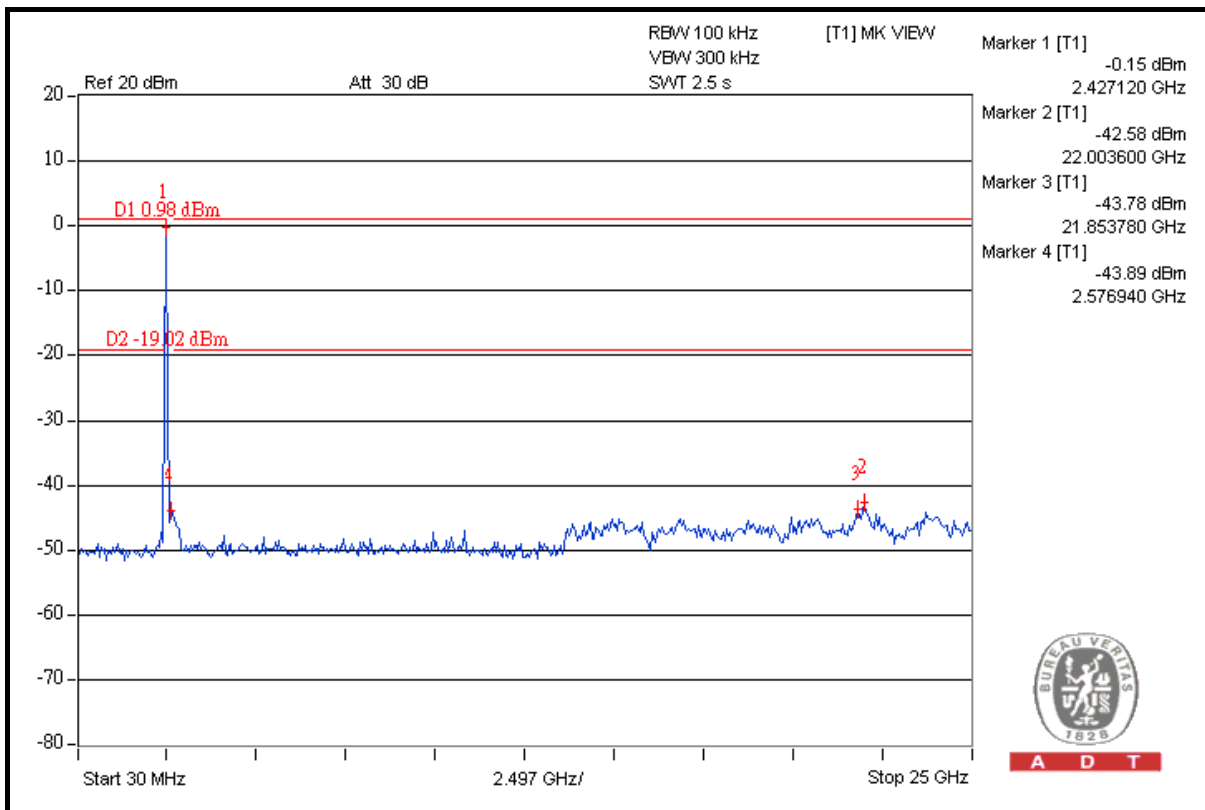
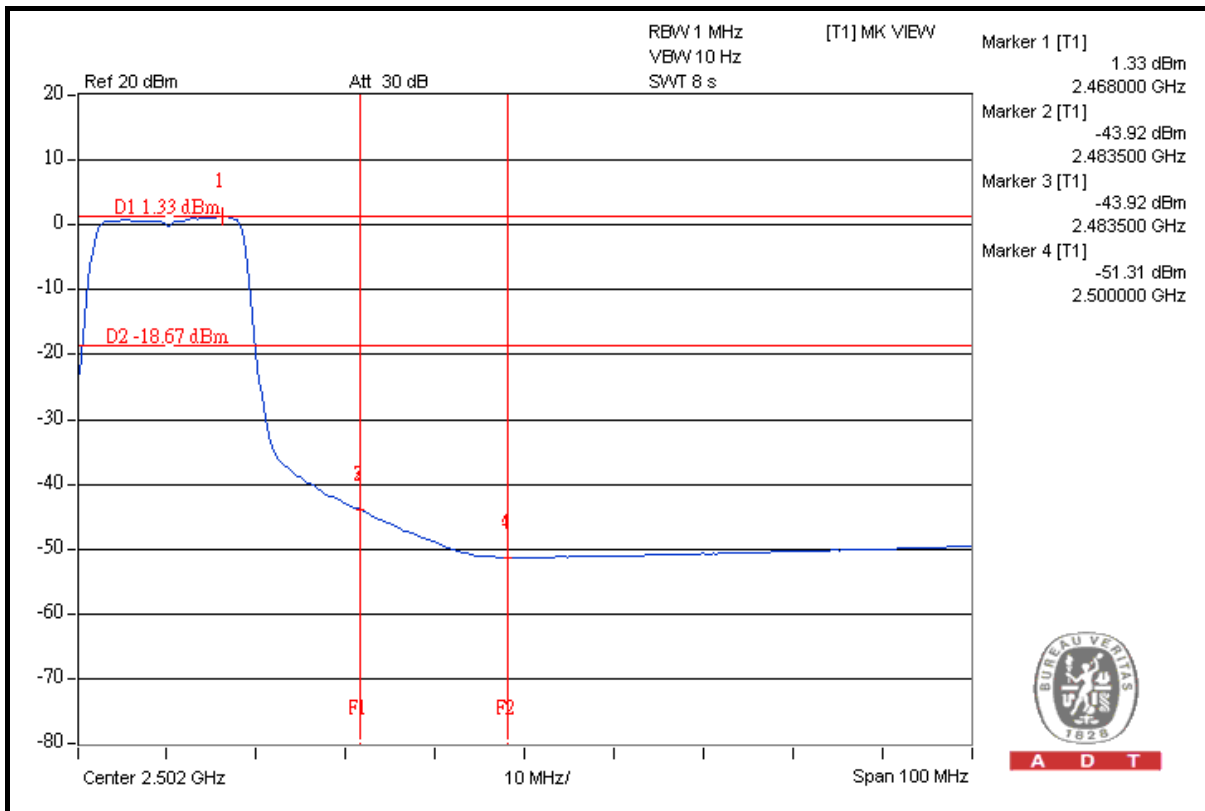

5. PHOTOGRAPHS OF THE TEST CONFIGURATION

Please refer to the attached file (Test Setup Photo).

6. INFORMATION ON THE TESTING LABORATORIES

We, Bureau Veritas Consumer Products Services (H.K.) Ltd., Taoyuan Branch, were founded in 1988 to provide our best service in EMC, Radio, Telecom and Safety consultation. Our laboratories are accredited and approved by the following approval agencies according to ISO/IEC 17025.

USA	FCC, NVLAP
Germany	TUV Rheinland
Japan	VCCI
Norway	NEMKO
Canada	INDUSTRY CANADA , CSA
R.O.C.	TAF, BSMI, NCC
Netherlands	Telefication
Singapore	GOST-ASIA(MOU)
Russia	CERTIS(MOU)

Copies of accreditation certificates of our laboratories obtained from approval agencies can be downloaded from our web site:

www.adt.com.tw/index.5/phtml. If you have any comments, please feel free to contact us at the following:

Linko EMC/RF Lab:

Tel: 886-2-26052180

Fax: 886-2-26051924

Hsin Chu EMC/RF Lab:

Tel: 886-3-5935343

Fax: 886-3-5935342

Hwa Ya EMC/RF/Safety Telecom Lab:

Tel: 886-3-3183232

Fax: 886-3-3185050

Web Site: www.adt.com.tw

The address and road map of all our labs can be found in our web site also.

7. APPENDIX A - MODIFICATIONS RECORDERS FOR ENGINEERING CHANGES TO THE EUT BY THE LAB

No any modifications are made to the EUT by the lab during the test.

--- END ---