



FCC SAR Test Report

APPLICANT : DAP Technologies
EQUIPMENT : Rugged Mobile Tablet Computer
BRAND NAME : DAP
MODEL NAME : 9000WBWZV1
MARKETING NAME : M9010
FCC ID : T5M9000WBWZV1
STANDARD : FCC 47 CFR Part 2 (2.1093)
IEEE C95.1-1991
IEEE 1528-2003
FCC OET Bulletin 65 Supplement C (Edition 01-01)

The product was received on Jul. 23, 2011 and completely tested on Aug. 27, 2011. We, SPORTON INTERNATIONAL INC., would like to declare that the tested sample has been evaluated in accordance with the procedures and shown the compliance with the applicable technical standards.

The test results in this report apply exclusively to the tested model / sample. Without written approval of SPORTON INTERNATIONAL INC., the test report shall not be reproduced except in full.

Reviewed by:

Jones Tsai / Manager



SPORTON INTERNATIONAL INC.

No. 52, Hwa Ya 1st Rd., Hwa Ya Technology Park, Kwei-Shan Hsiang, Tao Yuan Hsien, Taiwan, R.O.C.

SPORTON INTERNATIONAL INC.

TEL : 886-3-327-3456

FAX : 886-3-328-4978

FCC ID : T5M9000WBWZV1

Page Number : 1 of 38

Report Issued Date : Oct. 31, 2011

Report Version : Rev. 01



Table of Contents

Revision History..... 3
1. Statement of Compliance 4
2. Administration Data 5
2.1 Testing Laboratory 5
2.2 Applicant 5
2.3 Manufacturer 5
2.4 Application Details 5
3. General Information 6
3.1 Description of Device Under Test (DUT) 6
3.2 Applied Standards 7
3.3 Device Category and SAR Limits 7
3.4 Test Conditions 7
3.4.1 Ambient Condition 7
3.4.2 Test Configuration 8
4. Specific Absorption Rate (SAR) 9
4.1 Introduction 9
4.2 SAR Definition 9
5. SAR Measurement System 10
5.1 E-Field Probe 11
5.1.1 E-Field Probe Specification 11
5.1.2 E-Field Probe Calibration 12
5.2 Data Acquisition Electronics (DAE) 12
5.3 Robot 12
5.4 Measurement Server 13
5.5 Phantom 14
5.6 Device Holder 15
5.7 Data Storage and Evaluation 17
5.7.1 Data Storage 17
5.7.2 Data Evaluation 17
5.8 Test Equipment List 19
6. Tissue Simulating Liquids 20
7. Uncertainty Assessment 22
8. SAR Measurement Evaluation 25
8.1 Purpose of System Performance check 25
8.2 System Setup 25
8.3 Validation Results 26
9. DUT Testing Position 27
10. Measurement Procedures 28
10.1 Spatial Peak SAR Evaluation 28
10.2 Area & Zoom Scan Procedures 29
10.3 Volume Scan Procedures 29
10.4 SAR Averaged Methods 29
10.5 Power Drift Monitoring 29
11. SAR Test Configurations 30
11.1 Exposure Positions Consideration 30
11.2 Simultaneous Transmitting Configurations 31
12. SAR Test Results 32
12.1 Conducted Power (Unit: dBm) 32
12.2 Test Records for Body SAR Test 37
13. References 38

- Appendix A. Plots of System Performance Check
Appendix B. Plots of SAR Measurement
Appendix C. DASY Calibration Certificate
Appendix D. Test Setup Photos
Appendix E. FCC 3G SAR Measurement Procedures (for WCDMA)
Appendix F. FCC 3G SAR Measurement Procedures (for CDMA2000)



Revision History

| REPORT NO. | VERSION | DESCRIPTION | ISSUED DATE |
|------------|---------|-------------------------|---------------|
| FA170707 | Rev. 01 | Initial issue of report | Oct. 31, 2011 |
| | | | |
| | | | |
| | | | |
| | | | |
| | | | |
| | | | |
| | | | |



1. Statement of Compliance

The maximum results of Specific Absorption Rate (SAR) found during testing for **DAP Technologies Rugged Mobile Tablet Computer DAP 9000WBWZV1 M9010** are as follows (with expanded uncertainty 21.4 % for 300 MHz to 3 GHz, and 25.2% for 3 GHz to 6 GHz).

| Band | Position | SAR _{1g} (W/kg) |
|---------------|-------------|-----------------------------|
| GSM850 | Body (0 cm) | 0.403 |
| GSM1900 | Body (0 cm) | 0.411 |
| WCDMA Band V | Body (0 cm) | 0.3 |
| WCDMA Band IV | Body (0 cm) | 0.463 |
| WCDMA Band II | Body (0 cm) | 0.629 |
| CDMA2000 BC0 | Body (0 cm) | 0.303 |
| CDMA2000 BC1 | Body (0 cm) | 0.75 |
| 802.11 b/g/n | Body (0 cm) | 0.047 |
| 802.11 a/n | Body (0 cm) | 0.03 |
| Bluetooth | Body (0 cm) | N/A |

Note: BT SAR not tested due to that average power is below the FCC procedure thresholds, per KDB 447498.

This device is in compliance with Specific Absorption Rate (SAR) for general population/uncontrolled exposure limits (1.6 W/kg) specified in FCC 47 CFR part 2 (2.1093) and ANSI/IEEE C95.1-1991, and had been tested in accordance with the measurement methods and procedures specified in IEEE 1528-2003 and FCC OET Bulletin 65 Supplement C (Edition 01-01).



2. Administration Data

2.1 Testing Laboratory

| | |
|---------------------------|---|
| Test Site | SPORTON INTERNATIONAL INC. |
| Test Site Location | No. 52, Hwa Ya 1 st Rd., Hwa Ya Technology Park, Kwei-Shan Hsiang, Tao Yuan Hsien, Taiwan, R.O.C. TEL: +886-3-327-3456 FAX: +886-3-328-4978 |

2.2 Applicant

| | |
|---------------------|------------------------------------|
| Company Name | DAP Technologies |
| Address | 7450 South Priest DR Tempe, AZ, US |

2.3 Manufacturer

| | |
|---------------------|---|
| Company Name | Venture Corporation Limited |
| Address | Blk5006, Ang Mo Kio Avenue 5, #03-07 TECHplace II, Singapore 569870 |

2.4 Application Details

| | |
|---------------------------------------|---------------|
| Date of Receipt of Application | Jul. 23, 2011 |
| Date of Start during the Test | Jul. 23, 2011 |
| Date of End during the Test | Aug. 27, 2011 |



3. General Information

3.1 Description of Device Under Test (DUT)

| Product Feature & Specification | |
|---|---|
| DUT Type | Rugged Mobile Tablet Computer |
| Brand Name | DAP |
| Model Name | 9000WBWZV1 |
| Marketing Name | M9010 |
| FCC ID | T5M9000WBWZV1 |
| Tx Frequency | GSM850 : 824 MHz ~ 849 MHz GSM1900 : 1850 MHz ~ 1910 MHz WCDMA Band V : 824 MHz ~ 849 MHz WCDMA Band IV : 1710 MHz ~ 1755 MHz WCDMA Band II : 1850 MHz ~ 1910 MHz CDMA2000 BC0 : 824.70 MHz ~ 848.31 MHz CDMA2000 BC1 : 1815.25 MHz ~ 1908.75 MHz 802.11b/g/n : 2400 MHz ~ 2483.5 MHz 802.11a/n : 5150 MHz ~ 5350 MHz; 5470 MHz ~ 5725 MHz; 5725 MHz ~ 5850 MHz Bluetooth : 2400 MHz ~ 2483.5 MHz |
| Rx Frequency | GSM850 : 869 MHz ~ 894 MHz GSM1900 : 1930 MHz ~ 1990 MHz WCDMA Band V : 869 MHz ~ 894 MHz WCDMA Band IV : 2110 MHz ~ 2155 MHz WCDMA Band II : 1930 MHz ~ 1990 MHz CDMA2000 BC0 : 869.70 MHz ~ 893.31 MHz CDMA2000 BC1 : 1931.25 MHz ~ 1988.75 MHz 802.11b/g/n : 2400 MHz ~ 2483.5 MHz 802.11a/n : 5150 MHz ~ 5350 MHz; 5470 MHz ~ 5725 MHz; 5725 MHz ~ 5850 MHz Bluetooth : 2400 MHz ~ 2483.5 MHz |
| Maximum Average Output Power to Antenna | GSM850 : 31.21 dBm GSM1900 : 29.00 dBm WCDMA Band V : 23.71 dBm WCDMA Band IV : 23.35 dBm WCDMA Band II : 23.58 dBm CDMA2000 BC0 : 23.97 dBm CDMA2000 BC1 : 23.98 dBm 802.11b : 13.70 dBm 802.11g : 7.98 dBm 802.11n (2.4GHz) : 7.30 dBm (BW 20MHz) 802.11n (2.4GHz) : 6.84 dBm (BW 40MHz) 802.11a : 12.41 dBm 802.11n (5GHz) : 12.02 dBm (BW 20MHz) 802.11n (5GHz) : 11.31 dBm (BW 40MHz) Bluetooth : 7.51 dBm |
| Antenna Type | WWAN : Fixed Internal Antenna WLAN : PIFA Antenna Bluetooth : Chip Antenna |



| Product Feature & Specification | |
|---------------------------------|--|
| HW Version | Merlion P3 |
| SW Version | MER_00.00.10 |
| Type of Modulation | GSM : GMSK WCDMA : QPSK (uplink) HSDPA : QPSK (uplink) HSUPA : QPSK (uplink) CDMA2000 : QPSK 802.11b : DSSS (BPSK / QPSK / CCK) 802.11a/g/n : OFDM (BPSK / QPSK / 16QAM / 64QAM) Bluetooth (1Mbps) : GFSK Bluetooth EDR (2Mbps) : $\pi/4$ -DQPSK Bluetooth EDR (3Mbps) : 8-DPSK |
| DUT Stage | Production Unit |

3.2 Applied Standards

The Specific Absorption Rate (SAR) testing specification, method and procedure for this device is in accordance with the following standards:

- FCC 47 CFR Part 2 (2.1093)
- IEEE C95.1-1991
- IEEE 1528-2003
- FCC OET Bulletin 65 Supplement C (Edition 01-01)
- FCC KDB 447498 D01 v04
- FCC KDB 616217 D03 v01
- FCC KDB 941225 D01 v02
- FCC KDB 941225 D03 v01
- FCC KDB 248227 D01 v01r02

3.3 Device Category and SAR Limits

This device belongs to portable device category because its radiating structure is allowed to be used within 20 centimeters of the body of the user. Limit for General Population/Uncontrolled exposure should be applied for this device, it is 1.6 W/kg as averaged over any 1 gram of tissue.

3.4 Test Conditions

3.4.1 Ambient Condition

| | |
|---------------------|-------------|
| Ambient Temperature | 20 to 24 °C |
| Humidity | < 60 % |



3.4.2 Test Configuration

For WWAN SAR testing, the DUT is in GPRS or WCDMA or CDMA2000 link mode.

For WWAN SAR testing, the DUT is in GPRS or WCDMA or CDMA2000 link mode. In general, the crest factor is 8.3 for GPRS/EDGE multi-slot class 8, 4 for GPRS/EDGE multi-slot class 10, and 1 for CDMA2000/WCDMA/HSDPA/HSUPA.

For WLAN SAR testing, WLAN engineering testing software installed on the DUT can provide continuous transmitting RF signal. This RF signal utilized in SAR measurement has almost 100% duty cycle and its crest factor is 1.

Bluetooth standalone SAR is not required because the Bluetooth power (7.51 dBm) is less than 60/f.

4. Specific Absorption Rate (SAR)

4.1 Introduction

SAR is related to the rate at which energy is absorbed per unit mass in an object exposed to a radio field. The SAR distribution in a biological body is complicated and is usually carried out by experimental techniques or numerical modeling. The standard recommends limits for two tiers of groups, occupational/controlled and general population/uncontrolled, based on a person's awareness and ability to exercise control over his or her exposure. In general, occupational/controlled exposure limits are higher than the limits for general population/uncontrolled.

4.2 SAR Definition

The SAR definition is the time derivative (rate) of the incremental energy (dW) absorbed by (dissipated in) an incremental mass (dm) contained in a volume element (dv) of a given density (ρ). The equation description is as below:

$$\text{SAR} = \frac{d}{dt} \left(\frac{dW}{dm} \right) = \frac{d}{dt} \left(\frac{dW}{\rho dv} \right)$$

SAR is expressed in units of Watts per kilogram (W/kg)

SAR measurement can be either related to the temperature elevation in tissue by

$$\text{SAR} = c \left(\frac{\delta T}{\delta t} \right)$$

Where: C is the specific heat capacity, δT is the temperature rise and δt is the exposure duration, or related to the electrical field in the tissue by

$$\text{SAR} = \frac{\sigma |E|^2}{\rho}$$

Where: σ is the conductivity of the tissue, ρ is the mass density of the tissue and E is the RMS electrical field strength.

However for evaluating SAR of low power transmitter, electrical field measurement is typically applied.

5. SAR Measurement System

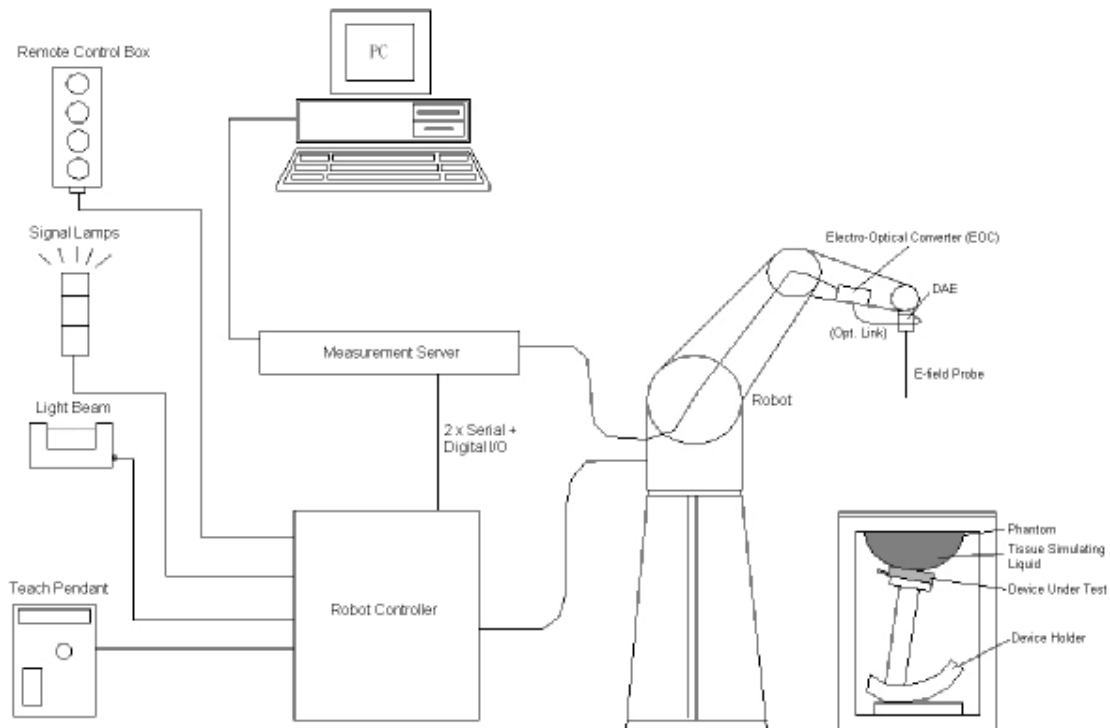

Fig 5.1 SPEAG DASY5 System Configurations

The DASY5 system for performance compliance tests is illustrated above graphically. This system consists of the following items:

- A standard high precision 6-axis robot with controller, a teach pendant and software
- A data acquisition electronic (DAE) attached to the robot arm extension
- A dosimetric probe equipped with an optical surface detector system
- The electro-optical converter (ECO) performs the conversion between optical and electrical signals
- A measurement server performs the time critical tasks such as signal filtering, control of the robot operation and fast movement interrupts.
- A probe alignment unit which improves the accuracy of the probe positioning
- A computer operating Windows XP
- DASY5 software
- Remote control with teach pendant and additional circuitry for robot safety such as warning lamps, etc.
- The SAM twin phantom
- A device holder
- Tissue simulating liquid
- Dipole for evaluating the proper functioning of the system

Some of the components are described in details in the following sub-sections.

5.1 E-Field Probe

The SAR measurement is conducted with the dosimetric probe (manufactured by SPEAG). The probe is specially designed and calibrated for use in liquid with high permittivity. The dosimetric probe has special calibration in liquid at different frequency. This probe has a built in optical surface detection system to prevent from collision with phantom.

5.1.1 E-Field Probe Specification

<ET3DV6 Probe >

| | |
|----------------------|--|
| Construction | Symmetrical design with triangular core Built-in optical fiber for surface detection system. Built-in shielding against static charges. PEEK enclosure material (resistant to organic solvents, e.g., DGBE) |
| Frequency | 10 MHz to 3 GHz; Linearity: ± 0.2 dB |
| Directivity | ± 0.2 dB in HSL (rotation around probe axis) ± 0.4 dB in HSL (rotation normal to probe axis) |
| Dynamic Range | 5 μ W/g to 100 mW/g; Linearity: ± 0.2 dB |
| Dimensions | Overall length: 330 mm (Tip: 16 mm) Tip diameter: 6.8 mm (Body: 12 mm) Distance from probe tip to dipole centers: 2.7 mm |



Fig 5.2 Photo of ET3DV6

<EX3DV4 Probe>

| | |
|----------------------|---|
| Construction | Symmetrical design with triangular core Built-in shielding against static charges PEEK enclosure material (resistant to organic solvents, e.g., DGBE) |
| Frequency | 10 MHz to 6 GHz; Linearity: ± 0.2 dB |
| Directivity | ± 0.3 dB in HSL (rotation around probe axis) ± 0.5 dB in tissue material (rotation normal to probe axis) |
| Dynamic Range | 10 μ W/g to 100 mW/g; Linearity: ± 0.2 dB (noise: typically < 1 μ W/g) |
| Dimensions | Overall length: 330 mm (Tip: 20 mm) Tip diameter: 2.5 mm (Body: 12 mm) Typical distance from probe tip to dipole centers: 1 mm |



Fig 5.3 Photo of EX3DV4

5.1.2 E-Field Probe Calibration

Each probe needs to be calibrated according to a dosimetric assessment procedure with accuracy better than $\pm 10\%$. The spherical isotropy shall be evaluated and within ± 0.25 dB. The sensitivity parameters (NormX, NormY, and NormZ), the diode compression parameter (DCP) and the conversion factor (ConvF) of the probe are tested. The calibration data can be referred to appendix C of this report.

5.2 Data Acquisition Electronics (DAE)

The data acquisition electronics (DAE) consists of a highly sensitive electrometer-grade preamplifier with auto-zeroing, a channel and gain-switching multiplexer, a fast 16 bit AD-converter and a command decoder and control logic unit. Transmission to the measurement server is accomplished through an optical downlink for data and status information as well as an optical uplink for commands and the clock.

The input impedance of the DAE is 200 MOhm; the inputs are symmetrical and floating. Common mode rejection is above 80 dB.



Fig 5.4 Photo of DAE

5.3 Robot

The SPEAG DASY system uses the high precision robots (DASY4: RX90BL; DASY5: TX90XL) type from Stäubli SA (France). For the 6-axis controller system, the robot controller version (DASY4: CS7MB; DASY5: CS8c) from Stäubli is used. The Stäubli robot series have many features that are important for our application:

- High precision (repeatability ± 0.035 mm)
- High reliability (industrial design)
- Jerk-free straight movements
- Low ELF interference (the closed metallic construction shields against motor control fields)



Fig 5.1 Photo of DASY4



Fig 5.2 Photo of DASY5

5.4 Measurement Server

The measurement server is based on a PC/104 CPU board with CPU (DASY4: 166 MHz, Intel Pentium; DASY5: 400 MHz, Intel Celeron), chipdisk (DASY4: 32 MB; DASY5: 128 MB), RAM (DASY4: 64 MB, DASY5: 128 MB). The necessary circuits for communication with the DAE electronic box, as well as the 16 bit AD converter system for optical detection and digital I/O interface are contained on the DASY I/O board, which is directly connected to the PC/104 bus of the CPU board.

The measurement server performs all the real-time data evaluation for field measurements and surface detection, controls robot movements and handles safety operations.



Fig 5.1 Photo of Server for DASY4



Fig 5.2 Photo of Server for DASY5

5.5 Phantom

<SAM Twin Phantom>

| | | |
|--------------------------|--|--|
| Shell Thickness | 2 ± 0.2 mm; Center ear point: 6 ± 0.2 mm |  <p>Fig 5.3 Photo of SAM Phantom</p> |
| Filling Volume | Approx. 25 liters | |
| Dimensions | Length: 1000 mm; Width: 500 mm; Height: adjustable feet | |
| Measurement Areas | Left Hand, Right Hand, Flat Phantom | |

The bottom plate contains three pair of bolts for locking the device holder. The device holder positions are adjusted to the standard measurement positions in the three sections. A white cover is provided to tap the phantom during off-periods to prevent water evaporation and changes in the liquid parameters. On the phantom top, three reference markers are provided to identify the phantom position with respect to the robot.

<ELI4 Phantom>

| | | |
|------------------------|--|---|
| Shell Thickness | 2 ± 0.2 mm (sagging: <1%) |  <p>Fig 5.4 Photo of ELI4 Phantom</p> |
| Filling Volume | Approx. 30 liters | |
| Dimensions | Major ellipse axis: 600 mm Minor axis: 400 mm | |

The ELI4 phantom is intended for compliance testing of handheld and body-mounted wireless devices in the frequency range of 30 MHz to 6 GHz. ELI4 is fully compatible with standard and all known tissue simulating liquids.

5.6 Device Holder

<Device Holder for SAM Twin Phantom>

The SAR in the phantom is approximately inversely proportional to the square of the distance between the source and the liquid surface. For a source at 5 mm distance, a positioning uncertainty of ± 0.5 mm would produce a SAR uncertainty of ± 20 %. Accurate device positioning is therefore crucial for accurate and repeatable measurements. The positions in which the devices must be measured are defined by the standards.

The DASY device holder is designed to cope with different positions given in the standard. It has two scales for the device rotation (with respect to the body axis) and the device inclination (with respect to the line between the ear reference points). The rotation center for both scales is the ear reference point (EPR). Thus the device needs no repositioning when changing the angles.

The DASY device holder is constructed of low-loss POM material having the following dielectric parameters: relative permittivity $\epsilon = 3$ and loss tangent $\delta = 0.02$. The amount of dielectric material has been reduced in the closest vicinity of the device, since measurements have suggested that the influence of the clamp on the test results could thus be lowered.



Fig 5.5 Device Holder

<Laptop Extension Kit>

The extension is lightweight and made of POM, acrylic glass and foam. It fits easily on the upper part of the mounting device in place of the phone positioned. The extension is fully compatible with the SAM Twin and ELI phantoms.

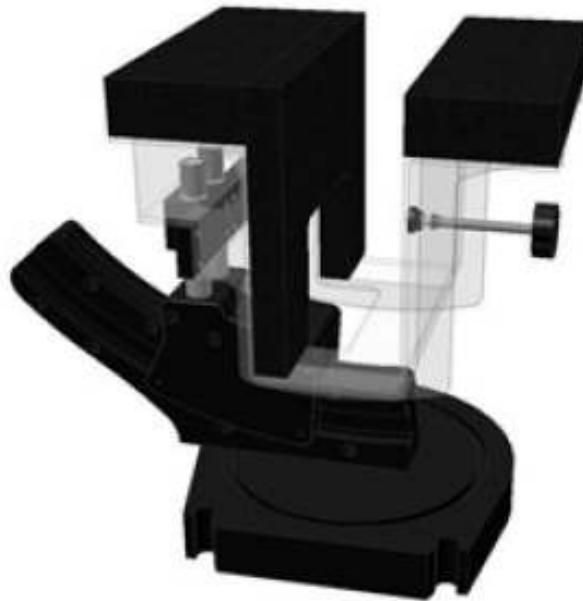

Fig 5.6 **Laptop Extension Kit**



5.7 Data Storage and Evaluation

5.7.1 Data Storage

The DASY software stores the assessed data from the data acquisition electronics as raw data (in microvolt readings from the probe sensors), together with all the necessary software parameters for the data evaluation (probe calibration data, liquid parameters and device frequency and modulation data) in measurement files. The post-processing software evaluates the desired unit and format for output each time the data is visualized or exported. This allows verification of the complete software setup even after the measurement and allows correction of erroneous parameter settings. For example, if a measurement has been performed with an incorrect crest factor parameter in the device setup, the parameter can be corrected afterwards and the data can be reevaluated.

The measured data can be visualized or exported in different units or formats, depending on the selected probe type (e.g., [V/m], [A/m], [mW/g]). Some of these units are not available in certain situations or give meaningless results, e.g., a SAR-output in a non-lose media, will always be zero. Raw data can also be exported to perform the evaluation with other software packages.

5.7.2 Data Evaluation

The DASY post-processing software (SEMCAD) automatically executes the following procedures to calculate the field units from the microvolt readings at the probe connector. The parameters used in the evaluation are stored in the configuration modules of the software :

| | | |
|----------------------------|---------------------------|---|
| Probe parameters : | - Sensitivity | Norm _i , a ₁₀ , a ₁₁ , a ₁₂ |
| | - Conversion factor | ConvF _i |
| | - Diode compression point | dcp _i |
| Device parameters : | - Frequency | f |
| | - Crest factor | cf |
| Media parameters : | - Conductivity | σ |
| | - Density | ρ |

These parameters must be set correctly in the software. They can be found in the component documents or they can be imported into the software from the configuration files issued for the DASY components. In the direct measuring mode of the multi-meter option, the parameters of the actual system setup are used. In the scan visualization and export modes, the parameters stored in the corresponding document files are used.

The first step of the evaluation is a linearization of the filtered input signal to account for the compression characteristics of the detector diode. The compensation depends on the input signal, the diode type and the DC-transmission factor from the diode to the evaluation electronics. If the exciting field is pulsed, the crest factor of the signal must be known to correctly compensate for peak power.

The formula for each channel can be given as :

$$V_i = U_i + U_i^2 \cdot \frac{cf}{dcp_i}$$

with V_i = compensated signal of channel i, (i = x, y, z)
 U_i = input signal of channel i, (i = x, y, z)
 cf = crest factor of exciting field (DASY parameter)
 dcp_i = diode compression point (DASY parameter)

From the compensated input signals, the primary field data for each channel can be evaluated :

$$\text{E-field Probes : } E_i = \sqrt{\frac{V_i}{\text{Norm}_i \cdot \text{ConvF}}}$$

$$\text{H-field Probes : } H_i = \sqrt{V_i} \cdot \frac{a_{i0} + a_{i1}f + a_{i2}f^2}{f}$$

with V_i = compensated signal of channel i, (i = x, y, z)
 Norm_i = sensor sensitivity of channel i, (i = x, y, z), $\mu\text{V}/(\text{V/m})^2$ for E-field Probes
 ConvF = sensitivity enhancement in solution
 a_{ij} = sensor sensitivity factors for H-field probes
 f = carrier frequency [GHz]
 E_i = electric field strength of channel i in V/m
 H_i = magnetic field strength of channel i in A/m

The RSS value of the field components gives the total field strength (Hermitian magnitude) :

$$E_{\text{tot}} = \sqrt{E_x^2 + E_y^2 + E_z^2}$$

The primary field data are used to calculate the derived field units.

$$\text{SAR} = E_{\text{tot}}^2 \cdot \frac{\sigma}{\rho \cdot 1000}$$

with SAR = local specific absorption rate in mW/g
 E_{tot} = total field strength in V/m
 σ = conductivity in [mho/m] or [Siemens/m]
 ρ = equivalent tissue density in g/cm^3

Note that the density is set to 1, to account for actual head tissue density rather than the density of the tissue simulating liquid.



5.8 Test Equipment List

| Manufacturer | Name of Equipment | Type/Model | Serial Number | Calibration | |
|--------------|--------------------------------------|---------------|---------------|---------------|---------------|
| | | | | Last Cal. | Due Date |
| SPEAG | Dosimetric E-Field Probe | ET3DV6 | 1787 | May. 20, 2011 | May. 19, 2012 |
| SPEAG | Dosimetric E-Field Probe | EX3DV4 | 3578 | Jun. 21, 2011 | Jun. 20, 2012 |
| SPEAG | Dosimetric E-Filed Probe | EX3DV4 | 3792 | Jun. 20, 2011 | Jun. 19, 2012 |
| SPEAG | 835MHz System Validation Kit | D835V2 | 499 | Mar. 22, 2010 | Mar. 21, 2012 |
| SPEAG | 1800MHz System Validation Kit | D1800V2 | 2d052 | Jun. 16, 2011 | Jun. 15, 2013 |
| SPEAG | 1900MHz System Validation Kit | D1900V2 | 5d041 | Mar. 23, 2010 | Mar. 22, 2012 |
| SPEAG | 2450MHz System Validation Kit | D2450V2 | 735 | Jun. 22, 2011 | Jun. 21, 2012 |
| SPEAG | 5GHz System Validation Kit | D5GHzV2 | 1040 | Jun. 21, 2011 | Jun. 20, 2012 |
| SPEAG | Data Acquisition Electronics | DAE3 | 577 | Jun. 20, 2011 | Jun. 19, 2012 |
| SPEAG | Data Acquisition Electronics | DAE4 | 778 | Oct. 22, 2010 | Oct. 21, 2011 |
| SPEAG | Data Acquisition Electronics | DAE3 | 495 | Apr. 28, 2011 | Apr. 27, 2012 |
| SPEAG | Device Holder | N/A | N/A | NCR | NCR |
| SPEAG | ELI4 Phantom | QD 0VA 001 BA | 1029 | NCR | NCR |
| SPEAG | ELI4 Phantom | QD 0VA 002 AA | TP-1127 | NCR | NCR |
| Agilent | ENA Series Network Analyzer | E5071C | MY46100746 | Jun. 10, 2011 | Jun. 09, 2012 |
| Agilent | Wireless Communication Test Set | E5515C | MY48360820 | Jan. 12, 2010 | Jan. 11, 2012 |
| Agilent | Wireless Communication Test Set | E5515C | GB46311322 | Mar. 23, 2011 | Mar. 22, 2013 |
| Agilent | Wireless Communication Test Set | E5515C | MY50264370 | Apr. 19, 2011 | Apr. 18, 2013 |
| Agilent | RF Vector Network Analyzer | E8358A | US40260131 | May. 17, 2011 | May. 16, 2012 |
| R&S | Universal Radio Communication Tester | CMU200 | 114256 | Feb. 08, 2010 | Feb. 07, 2012 |
| Agilent | Dielectric Probe Kit | 85070D | US01440205 | NCR | NCR |
| Agilent | Dual Directional Coupler | 778D | 50422 | NCR | NCR |
| AR | Power Amplifier | 5S1G4M2 | 0328767 | NCR | NCR |
| R&S | Spectrum Analyzer | FSP30 | 101329 | May. 03, 2011 | May. 02, 2012 |

Table 5.1 Test Equipment List

Note: The calibration certificate of DASY can be referred to appendix C of this report.

6. Tissue Simulating Liquids

For the measurement of the field distribution inside the SAM phantom with DASY, the phantom must be filled with around 25 liters of homogeneous body tissue simulating liquid. For head SAR testing, the liquid height from the ear reference point (ERP) of the phantom to the liquid top surface is larger than 15 cm, which is shown in Fig. 6.1. For body SAR testing, the liquid height from the center of the flat phantom to the liquid top surface is larger than 15 cm, which is shown in Fig. 6.2.



Fig 6.1 Photo of Liquid Height for Head SAR



Fig 6.2 Photo of Liquid Height for Body SAR

The following table gives the recipes for tissue simulating liquid.

| Frequency (MHz) | Water (%) | Sugar (%) | Cellulose (%) | Salt (%) | Preventol (%) | DGBE (%) | Conductivity (σ) | Permittivity (ϵ_r) |
|------------------|-----------|-----------|---------------|----------|---------------|----------|---------------------------|-------------------------------|
| For Head | | | | | | | | |
| 835 | 40.3 | 57.9 | 0.2 | 1.4 | 0.2 | 0 | 0.90 | 41.5 |
| 900 | 40.3 | 57.9 | 0.2 | 1.4 | 0.2 | 0 | 0.97 | 41.5 |
| 1800, 1900, 2000 | 55.2 | 0 | 0 | 0.3 | 0 | 44.5 | 1.40 | 40.0 |
| 2450 | 55.0 | 0 | 0 | 0 | 0 | 45.0 | 1.80 | 39.2 |
| For Body | | | | | | | | |
| 835 | 50.8 | 48.2 | 0 | 0.9 | 0.1 | 0 | 0.97 | 55.2 |
| 900 | 50.8 | 48.2 | 0 | 0.9 | 0.1 | 0 | 1.05 | 55.0 |
| 1800, 1900, 2000 | 70.2 | 0 | 0 | 0.4 | 0 | 29.4 | 1.52 | 53.3 |
| 2450 | 68.6 | 0 | 0 | 0 | 0 | 31.4 | 1.95 | 52.7 |

Table 6.1 Recipes of Tissue Simulating Liquid

Simulating Liquid for 5G, Manufactured by SPEAG

| Ingredients | (% by weight) |
|--------------------|---------------|
| Water | 64~78% |
| Mineral oil | 11~18% |
| Emulsifiers | 9~15% |
| Additives and Salt | 2~3% |

The following table gives the targets for tissue simulating liquid.

| Frequency (MHz) | Liquid Type | Conductivity (σ) | $\pm 5\%$ Range | Permittivity (ϵ_r) | $\pm 5\%$ Range |
|------------------|-------------|---------------------------|-----------------|-------------------------------|-----------------|
| 835 | Head | 0.90 | 0.86 ~ 0.95 | 41.5 | 39.4 ~ 43.6 |
| 900 | Head | 0.97 | 0.92 ~ 1.02 | 41.5 | 39.4 ~ 43.6 |
| 1800, 1900, 2000 | Head | 1.40 | 1.33 ~ 1.47 | 40.0 | 38.0 ~ 42.0 |
| 2450 | Head | 1.80 | 1.71 ~ 1.89 | 39.2 | 37.2 ~ 41.2 |
| 835 | Body | 0.97 | 0.92 ~ 1.02 | 55.2 | 52.4 ~ 58.0 |
| 900 | Body | 1.05 | 1.00 ~ 1.10 | 55.0 | 52.3 ~ 57.8 |
| 1800, 1900, 2000 | Body | 1.52 | 1.44 ~ 1.60 | 53.3 | 50.6 ~ 56.0 |
| 2450 | Body | 1.95 | 1.85 ~ 2.05 | 52.7 | 50.1 ~ 55.3 |
| 5200 | Body | 5.30 | 5.04 ~ 5.57 | 49.0 | 46.6 ~ 51.5 |
| 5500 | Body | 5.65 | 5.37 ~ 5.93 | 48.6 | 46.2 ~ 51.0 |
| 5800 | Body | 6.00 | 5.70 ~ 6.30 | 48.2 | 45.8 ~ 50.6 |

Table 6.2 Targets of Tissue Simulating Liquid

The dielectric parameters of the liquids were verified prior to the SAR evaluation using an Agilent 85070D Dielectric Probe Kit and an Agilent Network Analyzer.

The following table shows the measuring results for simulating liquid.

| Frequency (MHz) | Liquid Type | Temperature ($^{\circ}\text{C}$) | Conductivity (σ) | Permittivity (ϵ_r) | Measurement Date |
|-----------------|-------------|------------------------------------|---------------------------|-------------------------------|------------------|
| 850 | Body | 21.3 | 0.979 | 52.7 | Jul. 23, 2011 |
| 1800 | Body | 21.3 | 1.58 | 51.9 | Jul. 25, 2011 |
| 1900 | Body | 21.5 | 1.52 | 54.8 | Jul. 23, 2011 |
| 2450 | Body | 21.3 | 1.957 | 53.837 | Aug. 27, 2011 |
| 5500 | Body | 21.6 | 5.727 | 48.178 | Aug. 25, 2011 |

Table 6.3 Measuring Results for Simulating Liquid

7. Uncertainty Assessment

The component of uncertainty may generally be categorized according to the methods used to evaluate them. The evaluation of uncertainty by the statistical analysis of a series of observations is termed a Type A evaluation of uncertainty. The evaluation of uncertainty by means other than the statistical analysis of a series of observation is termed a Type B evaluation of uncertainty. Each component of uncertainty, however evaluated, is represented by an estimated standard deviation, termed standard uncertainty, which is determined by the positive square root of the estimated variance.

A Type A evaluation of standard uncertainty may be based on any valid statistical method for treating data. This includes calculating the standard deviation of the mean of a series of independent observations; using the method of least squares to fit a curve to the data in order to estimate the parameter of the curve and their standard deviations; or carrying out an analysis of variance in order to identify and quantify random effects in certain kinds of measurement.

A type B evaluation of standard uncertainty is typically based on scientific judgment using all of the relevant information available. These may include previous measurement data, experience and knowledge of the behavior and properties of relevant materials and instruments, manufacture’s specification, data provided in calibration reports and uncertainties assigned to reference data taken from handbooks. Broadly speaking, the uncertainty is either obtained from an outdoor source or obtained from an assumed distribution, such as the normal distribution, rectangular or triangular distributions indicated in Table 7.1

| Uncertainty Distributions | Normal | Rectangular | Triangular | U-Shape |
|------------------------------------|-------------|--------------|--------------|--------------|
| Multi-plying Factor ^(a) | $1/k^{(b)}$ | $1/\sqrt{3}$ | $1/\sqrt{6}$ | $1/\sqrt{2}$ |

(a) standard uncertainty is determined as the product of the multiplying factor and the estimated range of variations in the measured quantity

(b) k is the coverage factor

Table 7.1 Standard Uncertainty for Assumed Distribution

The combined standard uncertainty of the measurement result represents the estimated standard deviation of the result. It is obtained by combining the individual standard uncertainties of both Type A and Type B evaluation using the usual “root-sum-squares” (RSS) methods of combining standard deviations by taking the positive square root of the estimated variances.

Expanded uncertainty is a measure of uncertainty that defines an interval about the measurement result within which the measured value is confidently believed to lie. It is obtained by multiplying the combined standard uncertainty by a coverage factor. Typically, the coverage factor ranges from 2 to 3. Using a coverage factor allows the true value of a measured quantity to be specified with a defined probability within the specified uncertainty range. For purpose of this document, a coverage factor two is used, which corresponds to confidence interval of about 95 %. The DASY uncertainty Budget is showed in Table 7.2.



| Error Description | Uncertainty Value (±%) | Probability Distribution | Divisor | Ci (1g) | Standard Uncertainty (1g) |
|--------------------------------------|------------------------|--------------------------|---------|---------|---------------------------|
| Measurement System | | | | | |
| Probe Calibration | 5.5 | Normal | 1 | 1 | ± 5.5 % |
| Axial Isotropy | 4.7 | Rectangular | √3 | 0.7 | ± 1.9 % |
| Hemispherical Isotropy | 9.6 | Rectangular | √3 | 0.7 | ± 3.9 % |
| Boundary Effects | 1.0 | Rectangular | √3 | 1 | ± 0.6 % |
| Linearity | 4.7 | Rectangular | √3 | 1 | ± 2.7 % |
| System Detection Limits | 1.0 | Rectangular | √3 | 1 | ± 0.6 % |
| Readout Electronics | 0.3 | Normal | 1 | 1 | ± 0.3 % |
| Response Time | 0.8 | Rectangular | √3 | 1 | ± 0.5 % |
| Integration Time | 2.6 | Rectangular | √3 | 1 | ± 1.5 % |
| RF Ambient Noise | 3.0 | Rectangular | √3 | 1 | ± 1.7 % |
| RF Ambient Reflections | 3.0 | Rectangular | √3 | 1 | ± 1.7 % |
| Probe Positioner | 0.4 | Rectangular | √3 | 1 | ± 0.2 % |
| Probe Positioning | 2.9 | Rectangular | √3 | 1 | ± 1.7 % |
| Max. SAR Eval. | 1.0 | Rectangular | √3 | 1 | ± 0.6 % |
| Test Sample Related | | | | | |
| Device Positioning | 2.9 | Normal | 1 | 1 | ± 2.9 % |
| Device Holder | 3.6 | Normal | 1 | 1 | ± 3.6 % |
| Power Drift | 5.0 | Rectangular | √3 | 1 | ± 2.9 % |
| Phantom and Setup | | | | | |
| Phantom Uncertainty | 4.0 | Rectangular | √3 | 1 | ± 2.3 % |
| Liquid Conductivity (Target) | 5.0 | Rectangular | √3 | 0.64 | ± 1.8 % |
| Liquid Conductivity (Meas.) | 2.5 | Normal | 1 | 0.64 | ± 1.6 % |
| Liquid Permittivity (Target) | 5.0 | Rectangular | √3 | 0.6 | ± 1.7 % |
| Liquid Permittivity (Meas.) | 2.5 | Normal | 1 | 0.6 | ± 1.5 % |
| Combined Standard Uncertainty | | | | | ± 10.7 % |
| Coverage Factor for 95 % | | | | | K = 2 |
| Expanded Uncertainty | | | | | ± 21.4 % |

Table 7.2 Uncertainty Budget of DASY for frequency range 300 MHz to 3 GHz



| Error Description | Uncertainty Value (±%) | Probability Distribution | Divisor | Ci (10g) | Standard Uncertainty (10g) |
|--------------------------------------|------------------------|--------------------------|---------|----------|----------------------------|
| Measurement System | | | | | |
| Probe Calibration | 6.55 | Normal | 1 | 1 | ± 6.55 % |
| Axial Isotropy | 4.7 | Rectangular | √3 | 0.7 | ± 1.9 % |
| Hemispherical Isotropy | 9.6 | Rectangular | √3 | 0.7 | ± 3.9 % |
| Boundary Effects | 2.0 | Rectangular | √3 | 1 | ± 1.2 % |
| Linearity | 4.7 | Rectangular | √3 | 1 | ± 2.7 % |
| System Detection Limits | 1.0 | Rectangular | √3 | 1 | ± 0.6 % |
| Readout Electronics | 0.3 | Normal | 1 | 1 | ± 0.3 % |
| Response Time | 0.8 | Rectangular | √3 | 1 | ± 0.5 % |
| Integration Time | 2.6 | Rectangular | √3 | 1 | ± 1.5 % |
| RF Ambient Noise | 3.0 | Rectangular | √3 | 1 | ± 1.7 % |
| RF Ambient Reflections | 3.0 | Rectangular | √3 | 1 | ± 1.7 % |
| Probe Positioner | 0.8 | Rectangular | √3 | 1 | ± 0.5 % |
| Probe Positioning | 9.9 | Rectangular | √3 | 1 | ± 5.7 % |
| Max. SAR Eval. | 4.0 | Rectangular | √3 | 1 | ± 2.3 % |
| Test Sample Related | | | | | |
| Device Positioning | 2.9 | Normal | 1 | 1 | ± 2.9 % |
| Device Holder | 3.6 | Normal | 1 | 1 | ± 3.6 % |
| Power Drift | 5.0 | Rectangular | √3 | 1 | ± 2.9 % |
| Phantom and Setup | | | | | |
| Phantom Uncertainty | 4.0 | Rectangular | √3 | 1 | ± 2.3 % |
| Liquid Conductivity (Target) | 5.0 | Rectangular | √3 | 0.43 | ± 1.2 % |
| Liquid Conductivity (Meas.) | 2.5 | Normal | 1 | 0.43 | ± 1.1 % |
| Liquid Permittivity (Target) | 5.0 | Rectangular | √3 | 0.49 | ± 1.4 % |
| Liquid Permittivity (Meas.) | 2.5 | Normal | 1 | 0.49 | ± 1.2 % |
| Combined Standard Uncertainty | | | | | ± 12.6 % |
| Coverage Factor for 95 % | | | | | K = 2 |
| Expanded Uncertainty | | | | | ± 25.2 % |

Table 7.3 Uncertainty Budget of DASY for frequency range 3 GHz to 6 GHz

8. SAR Measurement Evaluation

Each DASY system is equipped with one or more system validation kits. These units, together with the predefined measurement procedures within the DASY software, enable the user to conduct the system performance check and system validation. System validation kit includes a dipole, tripod holder to fix it underneath the flat phantom and a corresponding distance holder.

8.1 Purpose of System Performance check

The system performance check verifies that the system operates within its specifications. System and operator errors can be detected and corrected. It is recommended that the system performance check be performed prior to any usage of the system in order to guarantee reproducible results. The system performance check uses normal SAR measurements in a simplified setup with a well characterized source. This setup was selected to give a high sensitivity to all parameters that might fail or vary over time. The system check does not intend to replace the calibration of the components, but indicates situations where the system uncertainty is exceeded due to drift or failure.

8.2 System Setup

In the simplified setup for system evaluation, the DUT is replaced by a calibrated dipole and the power source is replaced by a continuous wave that comes from a signal generator. The calibrated dipole must be placed beneath the flat phantom section of the SAM twin phantom with the correct distance holder. The distance holder should touch the phantom surface with a light pressure at the reference marking and be oriented parallel to the long side of the phantom. The equipment setup is shown below:

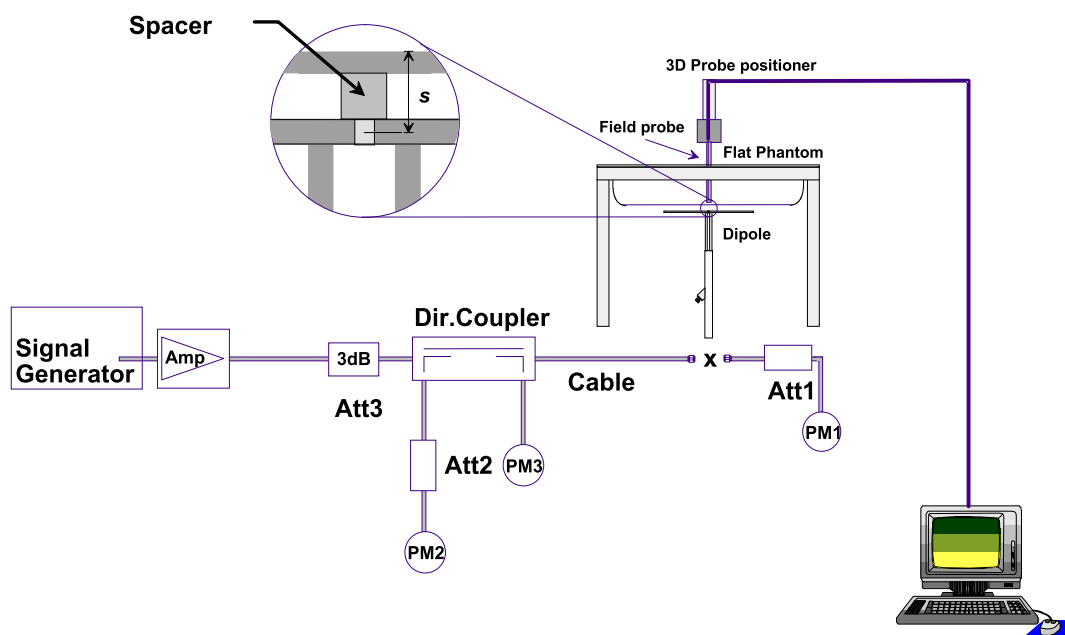

Fig 8.1 System Setup for System Evaluation

1. Signal Generator
2. Amplifier
3. Directional Coupler
4. Power Meter
5. Calibrated Dipole

The output power on dipole port must be calibrated to 24 dBm (250 mW) before dipole is connected.



Fig 8.2 Photo of Dipole Setup

8.3 Validation Results

Comparing to the original SAR value provided by SPEAG, the validation data should be within its specification of 10 %. Table 8.1 shows the target SAR and measured SAR after normalized to 1W input power. The table below indicates the system performance check can meet the variation criterion and the plots can be referred to Appendix A of this report.

| Measurement Date | Frequency (MHz) | Liquid Type | Targeted SAR _{1g} (W/kg) | Measured SAR _{1g} (W/kg) | Normalized SAR _{1g} (W/kg) | Deviation (%) |
|------------------|-----------------|-------------|-----------------------------------|-----------------------------------|-------------------------------------|---------------|
| Jul. 23, 2011 | 850 | Body | 9.820 | 2.580 | 10.32 | 5.09 |
| Jul. 25, 2011 | 1800 | Body | 37.800 | 9.180 | 36.72 | -2.86 |
| Jul. 23, 2011 | 1900 | Body | 40.000 | 10.400 | 41.60 | 4.00 |
| Aug. 27, 2011 | 2450 | Body | 51.200 | 12.900 | 51.60 | 0.78 |
| Aug. 25, 2011 | 5500 | Body | 81.700 | 20.600 | 82.40 | 0.86 |

Table 8.1 Target and Measurement SAR after Normalized

9. DUT Testing Position

This DUT was tested in two different positions. They are bottom face of tablet PC and Secondary landscape. In these positions, the surface of DUT is touching with phantom 0 cm gap. Please refer to Appendix D for the test setup photos.

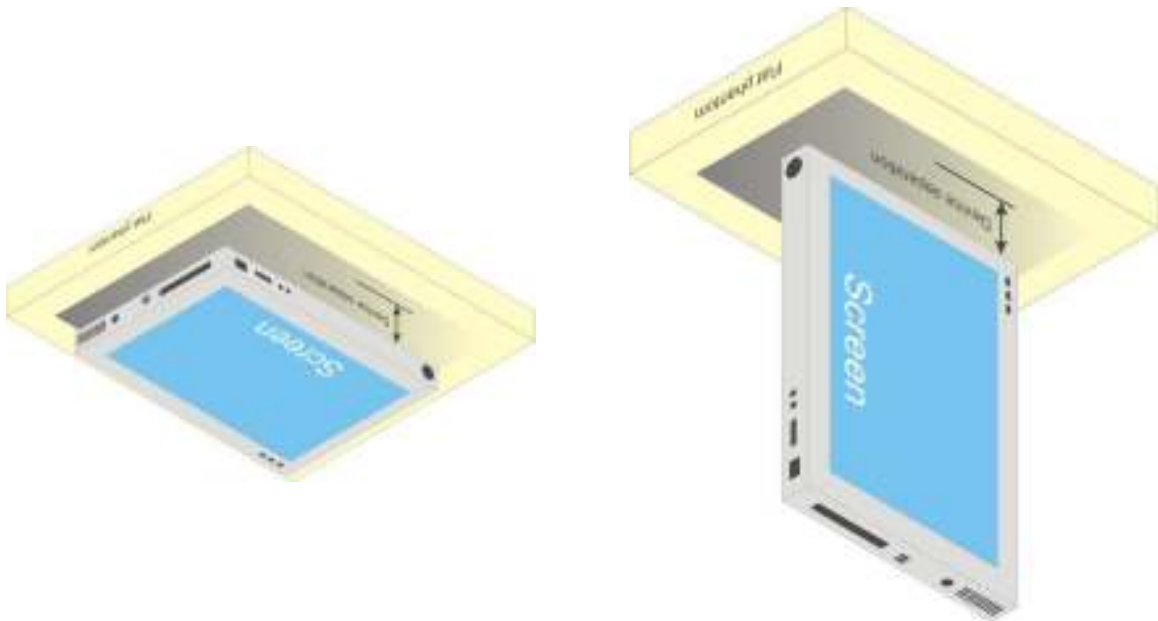

Fig 9.1 Illustration for Lap-touching Position

10. Measurement Procedures

The measurement procedures are as follows:

- (a) For WWAN function, link DUT with base station emulator in highest power channel
- (b) Set base station emulator to allow DUT to radiate maximum output power
- (c) For WLAN function, using engineering software to transmit RF power continuously (continuous Tx) in the middle channel
- (d) Measure output power through RF cable and power meter
- (e) Place the DUT in the positions described in the last section
- (f) Set scan area, grid size and other setting on the DASY software
- (g) Taking data for the middle channel on each testing position
- (h) Find out the largest SAR result on these testing positions of each band
- (i) Measure SAR results for other channels in worst SAR testing position if the SAR of highest power channel is larger than 0.8 W/kg

According to the test standard, the recommended procedure for assessing the peak spatial-average SAR value consists of the following steps:

- (a) Power reference measurement
- (b) Area scan
- (c) Zoom scan
- (d) Power drift measurement

10.1 Spatial Peak SAR Evaluation

The procedure for spatial peak SAR evaluation has been implemented according to the test standard. It can be conducted for 1g and 10g, as well as for user-specific masses. The DASY software includes all numerical procedures necessary to evaluate the spatial peak SAR value.

The base for the evaluation is a "cube" measurement. The measured volume must include the 1g and 10g cubes with the highest averaged SAR values. For that purpose, the center of the measured volume is aligned to the interpolated peak SAR value of a previously performed area scan.

The entire evaluation of the spatial peak values is performed within the post-processing engine (SEMCAD). The system always gives the maximum values for the 1g and 10g cubes. The algorithm to find the cube with highest averaged SAR is divided into the following stages:

- (a) Extraction of the measured data (grid and values) from the Zoom Scan
- (b) Calculation of the SAR value at every measurement point based on all stored data (A/D values and measurement parameters)
- (c) Generation of a high-resolution mesh within the measured volume
- (d) Interpolation of all measured values from the measurement grid to the high-resolution grid
- (e) Extrapolation of the entire 3-D field distribution to the phantom surface over the distance from sensor to surface
- (f) Calculation of the averaged SAR within masses of 1g and 10g



10.2 Area & Zoom Scan Procedures

First Area Scan is used to locate the approximate location(s) of the local peak SAR value(s). The measurement grid within an Area Scan is defined by the grid extent, grid step size and grid offset. Next, in order to determine the EM field distribution in a three-dimensional spatial extension, Zoom Scan is required. The Zoom Scan measures 5x5x7 points with step size 8, 8 and 5 mm for 300 MHz to 3 GHz, and 8x8x8 points with step size 4, 4 and 2.5 mm for 3 GHz to 6 GHz. The Zoom Scan is performed around the highest E-field value to determine the averaged SAR-distribution over 10 g.

10.3 Volume Scan Procedures

The volume scan is used for assess overlapping SAR distributions for antennas transmitting in different frequency bands. It is equivalent to an oversized zoom scan used in standalone measurements. The measurement volume will be used to enclose all the simultaneous transmitting antennas. For antennas transmitting simultaneously in different frequency bands, the volume scan is measured separately in each frequency band. In order to sum correctly to compute the 1g aggregate SAR, the DUT remain in the same test position for all measurements and all volume scan use the same spatial resolution and grid spacing (step-size is 4, 4 and 2.5 mm). When all volume scan were completed, the software, SEMCAD postprocessor can combine and subsequently superpose these measurement data to calculating the multiband SAR.

10.4 SAR Averaged Methods

In DASy, the interpolation and extrapolation are both based on the modified Quadratic Shepard's method. The interpolation scheme combines a least-square fitted function method and a weighted average method which are the two basic types of computational interpolation and approximation.

Extrapolation routines are used to obtain SAR values between the lowest measurement points and the inner phantom surface. The extrapolation distance is determined by the surface detection distance and the probe sensor offset. The uncertainty increases with the extrapolation distance. To keep the uncertainty within 1% for the 1 g and 10 g cubes, the extrapolation distance should not be larger than 5 mm.

10.5 Power Drift Monitoring

All SAR testing is under the DUT install full charged battery and transmit maximum output power. In DASy measurement software, the power reference measurement and power drift measurement procedures are used for monitoring the power drift of DUT during SAR test. Both these procedures measure the field at a specified reference position before and after the SAR testing. The software will calculate the field difference in dB. If the power drift more than 5%, the SAR will be retested.

11. SAR Test Configurations

11.1 Exposure Positions Consideration

Secondary Landscape

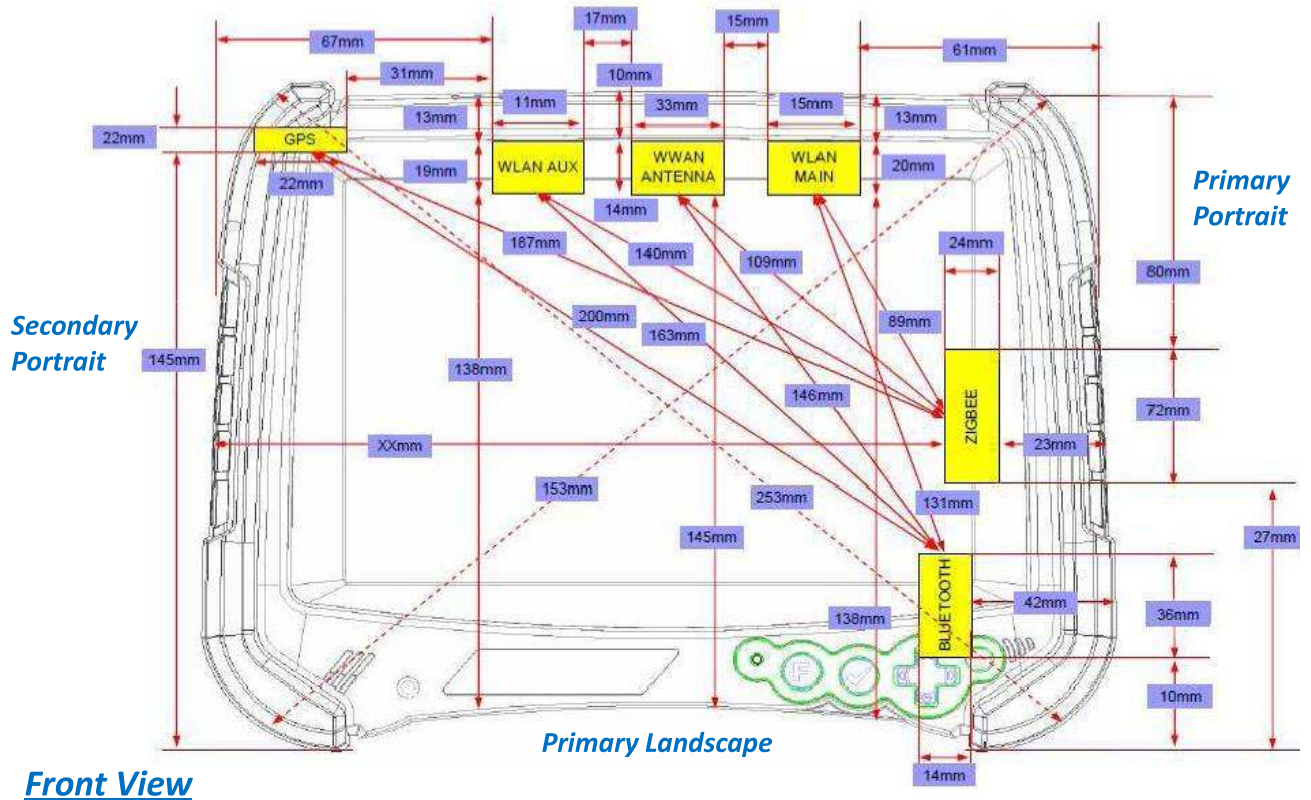

Front View

| | |
|-------------------------|---|
| CDMA2000 antenna | CDMA2000 BC 0 CDMA2000 BC 1 |
| UMTS antenna | GSM850 PCS WCDMA Band II WCDMA Band IV WCDMA Band V |
| WLAN/BT antenna | 802.11 b/g/n 802.11 a/n Bluetooth |



| Sides for SAR tests; Tablet mode | | | | | | |
|----------------------------------|-------------|------------|---------------------|-------------------|--------------------|------------------|
| | Bottom Face | Front Face | Secondary Landscape | Primary Landscape | Secondary Portrait | Primary Portrait |
| UMTS | ✓ (0mm) | x | ✓ (0mm) | x | x | X |
| CDMA2000 | ✓ (0mm) | x | ✓ (0mm) | x | X | x |
| WLAN/BT | ✓ (0 mm) | x | ✓ (0mm) | x | x | x |

Note:

1. The DUT diagonal dimension is 253 mm; per KDB 941225 D07, the DUT diagonal > 20 cm and Mini-Tablet procedure is not applied. Therefore, SAR tests follow the Tablet Mode in KDB447498.
2. There is no screen orientation limitation in DUT; that is 4 orientations are supported. The power reduction for SAR compliance is not triggered by the screen orientation.
3. As in (1), the test distance is 0 mm to the flat phantom; SAR evaluation is required for Bottom Face and each applicable Edge with the antenna within 5 cm to the user.
4. DUT does not support voice call function; therefore GSM SAR is not required.

11.2 Simultaneous Transmitting Configurations

| | Applicable Combination |
|---------------------------|------------------------|
| Simultaneous Transmission | 2G/3G + BT |
| | WLAN + BT |

Note:

1. Per KDB 447498 D01, Bluetooth output power < 60/f thus standalone SAR is not required; Simultaneous SAR is also not required due to the distance to other antennas > 5cm.
2. The GPRS/EDGE and WCDMA share the same WWAN transmitting antenna, and GPRS/EDGE will not transmit simultaneously with WCDMA.

12. SAR Test Results

12.1 Conducted Power (Unit: dBm)

< GPRS / EDGE 850, 1900 >

| GSM/GPRS/EDGE Burst Average Power | | | | | | |
|-----------------------------------|--------|-------|-------|---------|--------|--------|
| Band | GSM850 | | | GSM1900 | | |
| Channel | 128 | 189 | 251 | 512 | 661 | 810 |
| Frequency (MHz) | 824.2 | 836.4 | 848.8 | 1850.2 | 1880.0 | 1909.8 |
| GPRS 8 (1 Uplink) – CS1 | 31.07 | 31.00 | 31.04 | 28.74 | 28.55 | 28.32 |
| GPRS 10 (2 Uplink) – CS1 | 30.98 | 31.19 | 31.21 | 29.00 | 28.75 | 28.78 |
| EDGE 8 (GMSK, 1 Uplink) – MCS1 | 31.19 | 30.98 | 31.04 | 28.02 | 27.84 | 28.18 |
| EDGE 10 (GMSK, 2 Uplink) – MCS1 | 31.07 | 31.14 | 31.11 | 27.99 | 27.75 | 28.09 |
| EDGE 8 (8PSK, 1 Uplink) – MCS9 | 26.34 | 26.33 | 26.27 | 25.14 | 24.85 | 24.76 |
| EDGE 10 (8PSK, 2 Uplink) – MCS9 | 26.26 | 26.24 | 26.18 | 25.04 | 24.81 | 24.69 |

Note: Maximum burst average power in the table above.

| Source-Based Time-Averaged Power | | | | | | |
|----------------------------------|--------|-------|-------|---------|--------|--------|
| Band | GSM850 | | | GSM1900 | | |
| Channel | 128 | 189 | 251 | 512 | 661 | 810 |
| Frequency (MHz) | 824.2 | 836.4 | 848.8 | 1850.2 | 1880.0 | 1909.8 |
| GPRS 8 (1 Uplink) – CS1 | 22.07 | 22.00 | 22.04 | 19.74 | 19.55 | 19.32 |
| GPRS 10 (2 Uplink) – CS1 | 24.98 | 25.19 | 25.21 | 23.00 | 22.75 | 22.78 |
| EDGE 8 (GMSK, 1 Uplink) – MCS1 | 22.19 | 21.98 | 22.04 | 19.02 | 18.84 | 19.18 |
| EDGE 10 (GMSK, 2 Uplink) – MCS1 | 25.07 | 25.14 | 25.11 | 21.99 | 21.75 | 22.09 |
| EDGE 8 (8PSK, 1 Uplink) – MCS9 | 17.34 | 17.33 | 17.27 | 16.14 | 15.85 | 15.76 |
| EDGE 10 (8PSK, 2 Uplink) – MCS9 | 20.26 | 20.24 | 20.18 | 19.04 | 18.81 | 18.69 |

Remark:
The source-based time-averaged power is linearly scaled the maximum burst averaged power based on time slots. The calculated method are shown as below:
Source based time averaged power = Maximum burst averaged power (1 Uplink) - 9 dB
Source based time averaged power = Maximum burst averaged power (2 Uplink) - 6 dB
Source based time averaged power = Maximum burst averaged power (4 Uplink) - 3 dB

Note:

1. Following KDB 941225 D03, for Body-worn SAR testing, the DUT was set in GPRS10 for GSM850 and for GSM1900 due to its highest source-based time-average power.
2. Per 2010/10 workshop, the maximum output power channel is used for SAR testing and for further SAR test reduction.
3. EDGE tests with MCS1 setting, GMSK modulation. Burst average power with MCS9 setting 8 PSK modulation, is provided voluntary for reference.



<WCDMA>

| Band | WCDMA Band V | | | WCDMA Band II | | |
|-----------------|--------------|-------|-------|---------------|--------|--------|
| Channel | 4132 | 4182 | 4233 | 9262 | 9400 | 9538 |
| Frequency (MHz) | 826.4 | 836.4 | 846.6 | 1852.4 | 1880.0 | 1907.6 |
| RMC 12.2K | 23.42 | 23.71 | 23.26 | 23.53 | 23.58 | 23.27 |
| HSDPA Subtest-1 | 22.75 | 23.22 | 22.71 | 22.95 | 23.09 | 23.33 |
| HSDPA Subtest-2 | 22.83 | 23.37 | 23.14 | 22.99 | 23.07 | 23.01 |
| HSDPA Subtest-3 | 22.36 | 22.66 | 22.17 | 22.46 | 22.49 | 22.12 |
| HSDPA Subtest-4 | 22.38 | 22.21 | 22.12 | 22.44 | 22.46 | 22.09 |
| HSUPA Subtest-1 | 22.48 | 22.25 | 22.55 | 23.05 | 22.61 | 22.14 |
| HSUPA Subtest-2 | 21.28 | 21.25 | 21.29 | 21.56 | 21.77 | 21.51 |
| HSUPA Subtest-3 | 21.46 | 21.64 | 20.91 | 21.41 | 21.99 | 21.45 |
| HSUPA Subtest-4 | 21.85 | 21.48 | 22.21 | 22.56 | 22.25 | 21.75 |
| HSUPA Subtest-5 | 22.32 | 22.27 | 22.54 | 22.87 | 23.01 | 22.62 |

| Band | WCDMA Band IV | | |
|-----------------|---------------|--------|--------|
| Channel | 1312 | 1413 | 1513 |
| Frequency (MHz) | 1712.4 | 1732.6 | 1752.6 |
| RMC 12.2K | 23.33 | 23.35 | 23.19 |
| HSDPA Subtest-1 | 22.73 | 22.74 | 22.66 |
| HSDPA Subtest-2 | 22.75 | 22.74 | 22.63 |
| HSDPA Subtest-3 | 22.38 | 22.32 | 22.21 |
| HSDPA Subtest-4 | 22.33 | 22.28 | 22.18 |
| HSUPA Subtest-1 | 21.67 | 21.54 | 21.43 |
| HSUPA Subtest-2 | 21.74 | 21.67 | 21.56 |
| HSUPA Subtest-3 | 20.90 | 21.19 | 20.99 |
| HSUPA Subtest-4 | 21.57 | 21.34 | 21.18 |
| HSUPA Subtest-5 | 20.75 | 20.70 | 20.64 |



| MPR | | | | | | | |
|------------------|-----------------|--------------|-------|-------|---------------|------|------|
| 3GPP Requirement | | WCDMA band V | | | WCDMA band II | | |
| 0 | HSDPA Subtest-1 | 0.00 | 0.00 | 0.00 | 0.00 | 0.00 | 0.00 |
| 0 | HSDPA Subtest-2 | -0.08 | -0.15 | -0.43 | -0.04 | 0.02 | 0.32 |
| 0.5 | HSDPA Subtest-3 | 0.39 | 0.56 | 0.54 | 0.49 | 0.60 | 1.21 |
| 0.5 | HSDPA Subtest-4 | 0.37 | 1.01 | 0.59 | 0.51 | 0.63 | 1.24 |
| 0 | HSUPA Subtest-1 | -0.16 | 0.02 | -0.01 | -0.18 | 0.40 | 0.48 |
| 2 | HSUPA Subtest-2 | 1.04 | 1.02 | 1.25 | 1.31 | 1.24 | 1.11 |
| 1 | HSUPA Subtest-3 | 0.86 | 0.63 | 1.63 | 1.46 | 1.02 | 1.17 |
| 2 | HSUPA Subtest-4 | 0.47 | 0.79 | 0.33 | 0.31 | 0.76 | 0.87 |
| 0 | HSUPA Subtest-5 | 0.00 | 0.00 | 0.00 | 0.00 | 0.00 | 0.00 |

| MPR | | | | |
|------------------|-----------------|---------------|-------|-------|
| 3GPP Requirement | | WCDMA band IV | | |
| 0 | HSDPA Subtest-1 | 0.00 | 0.00 | 0.00 |
| 0 | HSDPA Subtest-2 | -0.02 | 0.00 | 0.03 |
| 0.5 | HSDPA Subtest-3 | 0.35 | 0.42 | 0.45 |
| 0.5 | HSDPA Subtest-4 | 0.40 | 0.46 | 0.48 |
| 0 | HSUPA Subtest-1 | -0.92 | -0.84 | -0.79 |
| 2 | HSUPA Subtest-2 | -0.99 | -0.97 | -0.92 |
| 1 | HSUPA Subtest-3 | -0.15 | -0.49 | -0.35 |
| 2 | HSUPA Subtest-4 | -0.82 | -0.64 | -0.54 |
| 0 | HSUPA Subtest-5 | 0.00 | 0.00 | 0.00 |

Note:

- Referring to KDB 941225 D01, RMC 12.2kbps setting is used for all SAR tests. If HSDPA and HSUPA output power is less than 1/4 dB higher than RMC 12.2kbps, SAR tests for HSDPA and HSUPA can be excluded.
- DUT HSUPA subtests output power is declared to follow the minimum requirement of 3GPP Table 5.2B.5 specification, HSDPA subtests output power is declared to follow the minimum requirement of 3GPP Table 5.2AA.2 specification. Since there is tolerance in measuring 3G output power, the difference between the measured value and the specification is treated as tolerance. According to KDB 941225 D02 v02, 1)b), the MPR implementation information is provided here.



<CDMA2000>

| Band | CDMA2000 BC0 | | | CDMA2000 BC1 | | |
|--------------------------|--------------|--------|--------|--------------|---------|---------|
| Channel | 1013 | 384 | 777 | 25 | 600 | 1175 |
| Frequency (MHz) | 824.70 | 836.52 | 848.31 | 1851.25 | 1880.00 | 1908.75 |
| 1xRTT RC1+SO55 | 23.62 | 23.65 | 23.55 | 23.96 | 23.60 | 23.16 |
| 1xRTT RC3+SO55 | 23.61 | 23.60 | 23.53 | 23.81 | 23.54 | 23.16 |
| 1xRTT RC3+SO32 (+ F-SCH) | 23.71 | 23.58 | 23.65 | 23.84 | 23.53 | 23.10 |
| 1xRTT RC3+SO32 (+SCH) | 23.64 | 23.58 | 23.71 | 23.76 | 23.46 | 23.17 |
| 1xEVDO RTAP 153.6 | 23.88 | 23.97 | 23.90 | 23.98 | 23.90 | 23.68 |
| 1xEVDO RETAP 4096 | 23.91 | 23.74 | 23.75 | 23.97 | 23.91 | 23.73 |

<WLAN>

| Band | 802.11b | | | 802.11g | | |
|-----------------|---------|-------|-------|---------|------|------|
| Channel | 1 | 6 | 11 | 1 | 6 | 11 |
| Frequency (MHz) | 2412 | 2437 | 2462 | 2412 | 2437 | 2462 |
| Power | 13.41 | 13.70 | 13.56 | 7.75 | 7.98 | 7.86 |

| Band | 802.11n (BW 20MHz) | | | 802.11n (BW 40MHz) | | |
|-----------------|--------------------|------|------|--------------------|------|------|
| Channel | 1 | 6 | 11 | 3 | 6 | 9 |
| Frequency (MHz) | 2412 | 2437 | 2462 | 2422 | 2437 | 2452 |
| Power | 6.99 | 7.30 | 6.91 | 6.43 | 6.84 | 6.34 |

| Band | 802.11a | | | | | | | | | | | |
|-----------------|---------|------|------|------|------|------|------|------|-------|-------|-------|-------|
| Channel | 36 | 40 | 44 | 48 | 52 | 56 | 60 | 64 | 100 | 104 | 108 | 112 |
| Frequency (MHz) | 5180 | 5200 | 5220 | 5240 | 5260 | 5280 | 5300 | 5320 | 5500 | 5520 | 5540 | 5560 |
| Average Power | 8.43 | 8.38 | 7.94 | 8.03 | 9.80 | 9.82 | 9.74 | 9.85 | 12.13 | 12.35 | 12.13 | 12.29 |

| Band | 802.11a | | | | | | | | | | | |
|-----------------|---------|-------|-------|-------|-------|-------|-------|-------|-------|------|-------|------|
| Channel | 116 | 120 | 124 | 128 | 132 | 136 | 140 | 149 | 153 | 157 | 161 | 165 |
| Frequency (MHz) | 5580 | 5600 | 5620 | 5640 | 5660 | 5680 | 5700 | 5745 | 5765 | 5785 | 5805 | 5825 |
| Average Power | 12.12 | 12.41 | 12.18 | 12.32 | 12.38 | 12.26 | 12.26 | 10.42 | 10.16 | 9.87 | 10.12 | 9.69 |

| Band | 802.11n (BW 20MHz) | | | | | | | | | | | |
|-----------------|--------------------|------|------|------|------|------|------|------|-------|-------|-------|-------|
| Channel | 36 | 40 | 44 | 48 | 52 | 56 | 60 | 64 | 100 | 104 | 108 | 112 |
| Frequency (MHz) | 5180 | 5200 | 5220 | 5240 | 5260 | 5280 | 5300 | 5320 | 5500 | 5520 | 5540 | 5560 |
| Average Power | 8.03 | 8.02 | 7.74 | 7.58 | 9.46 | 9.43 | 9.30 | 9.68 | 11.84 | 11.89 | 11.67 | 11.57 |



| Band | 802.11n (BW 20MHz) | | | | | | | | | | | |
|-----------------|--------------------|-------|-------|-------|-------|-------|-------|------|------|------|------|------|
| Channel | 116 | 120 | 124 | 128 | 132 | 136 | 140 | 149 | 153 | 157 | 161 | 165 |
| Frequency (MHz) | 5580 | 5600 | 5620 | 5640 | 5660 | 5680 | 5700 | 5745 | 5765 | 5785 | 5805 | 5825 |
| Average Power | 11.96 | 12.02 | 11.62 | 11.41 | 11.84 | 11.52 | 11.58 | 9.67 | 9.98 | 9.06 | 9.37 | 9.19 |

| Band | 802.11n (BW 40MHz) | | | | | | | | | |
|-----------------|--------------------|------|------|------|-------|-------|-------|------|------|--|
| Channel | 38 | 46 | 54 | 62 | 102 | 118 | 134 | 151 | 159 | |
| Frequency (MHz) | 5190 | 5230 | 5270 | 5310 | 5510 | 5590 | 5670 | 5755 | 5795 | |
| Average Power | 8.18 | 8.12 | 8.95 | 8.85 | 11.12 | 11.31 | 11.19 | 9.01 | 8.30 | |

Note:

1. Per KDB 248227, choose 11b mode to test SAR; 11g and 11n output power is less than 11b mode, and SAR can be excluded.
2. Per 2010/4 TCB workshop, choose the highest output power channel to test SAR and determine further SAR exclusion, and 11b CH06 is chosen here.

| Band | Bluetooth | | |
|------------|-----------|------|------|
| Data Rate | 1 Mbps | | |
| Channel | 0 | 39 | 78 |
| Frequency | 2402 | 2441 | 2480 |
| Avg. Power | 7.20 | 7.51 | 7.41 |

Note: Bluetooth standalone SAR is not required because the Bluetooth power (7.51 dBm) is less than 60/f.



12.2 Test Records for Body SAR Test

<2G/3G >

| Plot No. | Band | Mode | Test Position | Gap (cm) | Ch. | Ear- phone | SAR _{1g} (W/kg) |
|----------|----------|----------|---------------------|----------|------|---------------|--------------------------|
| 7 | GSM850 | GPRS10 | Bottom Face | 0 | 251 | - | 0.246 |
| 8 | GSM850 | GPRS10 | Secondary Landscape | 0 | 251 | v | 0.403 |
| 1 | GSM1900 | GPRS10 | Bottom Face | 0 | 512 | - | 0.411 |
| 2 | GSM1900 | GPRS10 | Secondary Landscape | 0 | 512 | v | 0.366 |
| 9 | WCDMA V | RMC12.2K | Bottom Face | 0 | 4182 | - | 0.146 |
| 10 | WCDMA V | RMC12.2K | Secondary Landscape | 0 | 4182 | v | 0.3 |
| 13 | WCDMA IV | RMC12.2K | Bottom Face | 0 | 1413 | - | 0.463 |
| 14 | WCDMA IV | RMC12.2K | Secondary Landscape | 0 | 1413 | v | 0.431 |
| 3 | WCDMA II | RMC12.2K | Bottom Face | 0 | 9400 | - | 0.629 |
| 4 | WCDMA II | RMC12.2K | Secondary Landscape | 0 | 9400 | v | 0.5 |

Note:

1 cm test results are for confirming operation of the power reduction scheme, and are not applicable for compliance demonstration for the FCC tablet PC SAR test procedures

<CDMA2000>

| Plot No. | Band | Mode | Test Position | Gap (cm) | Ch. | Ear- phone | SAR _{1g} (W/kg) |
|----------|--------------|-----------|---------------------|----------|-----|---------------|--------------------------|
| 11 | CDMA2000 BC0 | RTAP153.6 | Bottom Face | 0 | 384 | - | 0.151 |
| 12 | CDMA2000 BC0 | RTAP153.6 | Secondary Landscape | 0 | 384 | v | 0.303 |
| 5 | CDMA2000 BC1 | RTAP153.6 | Bottom Face | 0 | 25 | - | 0.75 |
| 6 | CDMA2000 BC1 | RTAP153.6 | Secondary Landscape | 0 | 25 | v | 0.595 |

<WLAN >

| Plot No. | Band | Mode | Test Position | Gap (cm) | Channel | Ear- phone | SAR _{1g} (W/kg) |
|----------|---------|------|---------------------|----------|---------|---------------|--------------------------|
| 17 | 802.11b | - | Bottom Face | 0 | 6 | - | 0.018 |
| 18 | 802.11b | - | Secondary Landscape | 0 | 6 | v | 0.047 |
| 16 | 802.11a | - | Secondary Landscape | 0 | 120 | v | 0.03 |

Note:

- Since Bluetooth standalone SAR is excluded, simultaneous SAR can be excluded referring to KDB 616217 D03 4)b). Only the antennas included in simultaneous transmission configuration that require SAR evaluation are concerned.

Test Engineer : Nick Tour and Angelo Chang and Niels Ouyang and Vic Yang and Jack Wu



13. References

- [1] FCC 47 CFR Part 2 "Frequency Allocations and Radio Treaty Matters; General Rules and Regulations"
- [2] IEEE Std. C95.1-1991, "IEEE Standard for Safety Levels with Respect to Human Exposure to Radio Frequency Electromagnetic Fields, 3 kHz to 300 GHz", 1991
- [3] IEEE Std. 1528-2003, "Recommended Practice for Determining the Peak Spatial-Average Specific Absorption Rate (SAR) in the Human Head from Wireless Communications Devices: Measurement Techniques", December 2003
- [4] FCC OET Bulletin 65 (Edition 97-01) Supplement C (Edition 01-01), "Evaluating Compliance with FCC Guidelines for Human Exposure to Radiofrequency Electromagnetic Fields", June 2001
- [5] SPEAG DASY System Handbook
- [6] FCC KDB 248227 D01 v01r02, "SAR Measurement Procedures for 802.11 a/b/g Transmitters", May 2007
- [7] FCC KDB 447498 D01 v04, "Mobile and Portable Device RF Exposure Procedures and Equipment Authorization Policies", November 2009
- [8] FCC KDB 616217 D03 v01, "SAR Evaluation Considerations for Laptop/Notebook/Netbook and Tablet Computers", November 2009
- [9] FCC KDB 941225 D01 v02, "SAR Measurement Procedures for 3G Devices – CDMA 2000 / Ev-Do / WCDMA / HSDPA / HSPA", October 2007
- [10] FCC KDB 941225 D03 v01, "Recommended SAR Test Reduction Procedures for GSM / GPRS / EDGE", December 2008
- [11] FCC KDB 941225 D04 v01, "Evaluating SAR for GSM/(E)GPRS Dual Transfer Mode", January 27 2010
- [12] FCC KDB 941225 D07 01, "SAR Evaluation Procedure for UMPC Mini-Tablet Devices", April 2011



Appendix A. Plots of System Performance Check

The plots are shown as follows.

System Check_Body_835MHz_110723

DUT: Dipole 835 MHz

Communication System: CW; Frequency: 835 MHz; Duty Cycle: 1:1

Medium: MSL_850_110723 Medium parameters used: $f = 835$ MHz; $\sigma = 0.979$ mho/m; $\epsilon_r = 52.7$; $\rho = 1000$

kg/m³

! MBIENT4EMPERATUREi , QUID4EMPERATUREi

DASY5 Configuration:

- Probe: ET3DV6 - SN1787; ConvF(6.35, 6.35, 6.35); Calibrated: 2011/5/20
- Sensor-Surface: 4mm (Mechanical Surface Detection)
- Electronics: DAE3 Sn495; Calibrated: 2011/4/28
- Phantom: ELI 4.0; Type: QDOVA001BA; Serial: 1029
- Measurement SW: DASY5, V5.0 Build 125; SEMCAD X Version 13.4 Build 125

Pin=250mW/Area Scan (61x61x1): Measurement grid: dx=15mm, dy=15mm

Maximum value of SAR (interpolated) = 2.8 mW/g

Pin=250mW/Zoom Scan (7x7x7)/Cube 0: Measurement grid: dx=5mm, dy=5mm, dz=5mm

Reference Value = 55.9 V/m; Power Drift = -0.014 dB

Peak SAR (extrapolated) = 3.57 W/kg

SAR(1 g) = 2.58 mW/g; SAR(10 g) = 1.72 mW/g

Maximum value of SAR (measured) = 2.8 mW/g

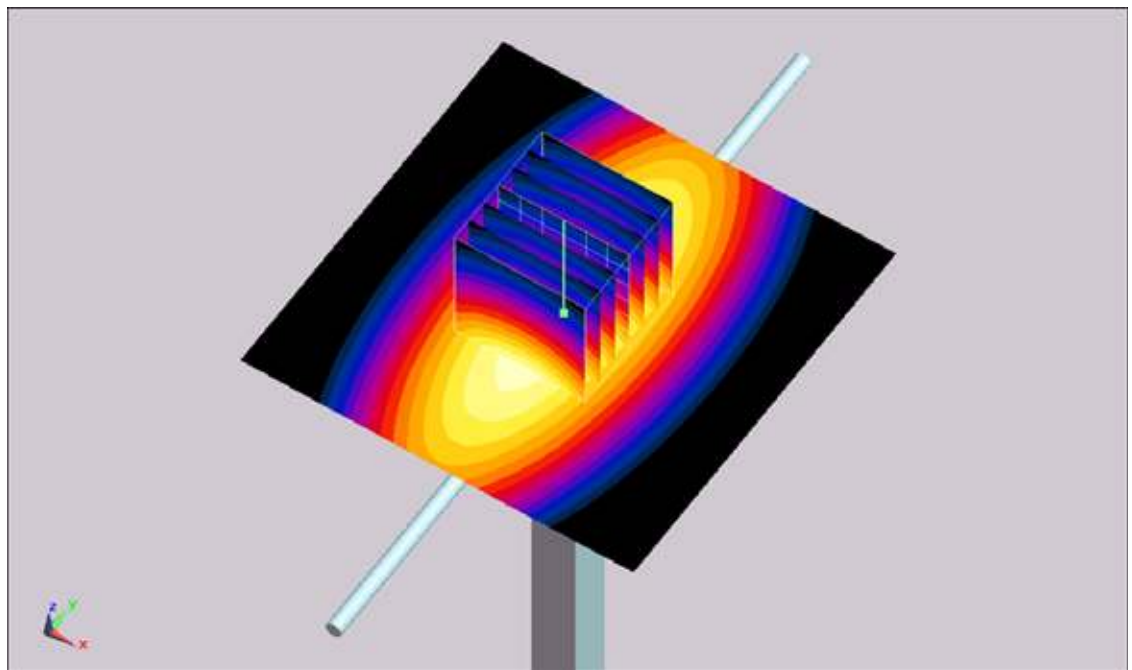
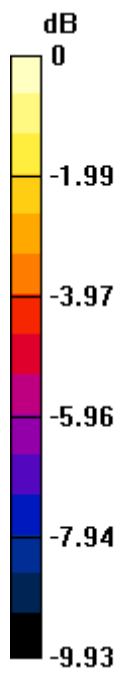

0 dB = 2.8mW/g

System Check_Body_1800MHz_110725

DUT: Dipole 1800 MHz

Communication System: CW; Frequency: 1800 MHz; Duty Cycle: 1:1

Medium: MSL_1800_110725 Medium parameters used: $f = 1800$ MHz; $\sigma = 1.58$ mho/m; $\epsilon_r = 51.9$; $\rho = 1000$

kg/m³

! MBIENT4EMPERATUREi , QUID4EMPERATUREi

DASY5 Configuration:

- Probe: ET3DV6 - SN1787; ConvF(4.74, 4.74, 4.74); Calibrated: 2011/5/20
- Sensor-Surface: 4mm (Mechanical Surface Detection)
- Electronics: DAE3 Sn495; Calibrated: 2011/4/28
- Phantom: ELI 4.0; Type: QDOVA001BA; Serial: 1029
- Measurement SW: DASY5, V5.0 Build 125; SEMCAD X Version 13.4 Build 125

Pin=250mW/Area Scan (61x61x1): Measurement grid: dx=15mm, dy=15mm

Maximum value of SAR (interpolated) = 10.8 mW/g

Pin=250mW/Zoom Scan (7x7x7)/Cube 0: Measurement grid: dx=5mm, dy=5mm, dz=5mm

Reference Value = 87 V/m; Power Drift = 0.025 dB

Peak SAR (extrapolated) = 14.4 W/kg

SAR(1 g) = 9.18 mW/g; SAR(10 g) = 5.11 mW/g

Maximum value of SAR (measured) = 10.3 mW/g

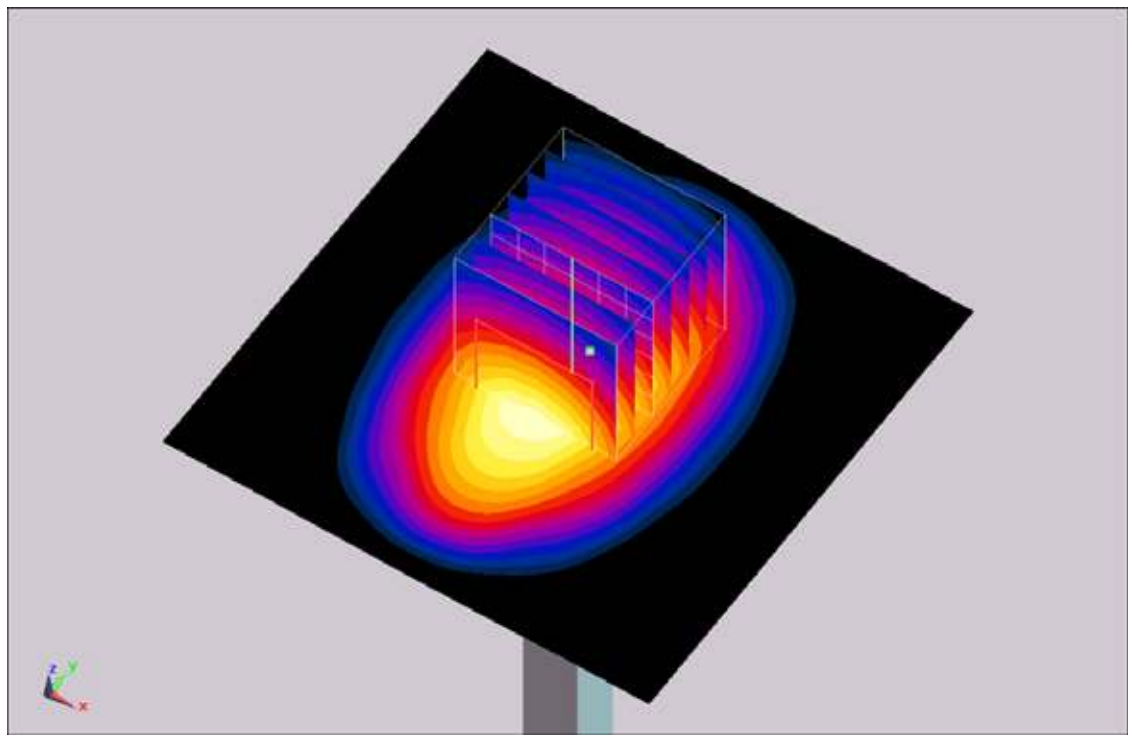
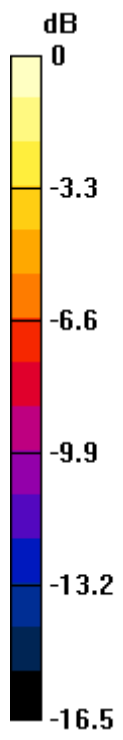

0 dB = 10.3mW/g

System Check_Body_1900MHz_110723

DUT: Dipole 1900 MHz

Communication System: CW; Frequency: 1900 MHz; Duty Cycle: 1:1

Medium: MSL_1900_110723 Medium parameters used: $f = 1900$ MHz; $\sigma = 1.52$ mho/m; $\epsilon_r = 54.8$; $\rho = 1000$

kg/m³

! MBIENT4EMPERATUREi , QUID4EMPERATUREi

DASY5 Configuration:

- Probe: EX3DV4 - SN3792; ConvF(7.17, 7.17, 7.17); Calibrated: 2011/6/20
- Sensor-Surface: 4mm (Mechanical Surface Detection)
- Electronics: DAE4 Sn778; Calibrated: 2010/10/22
- Phantom: ELI 4.0; Type: QDOVA001BA; Serial: 1029
- Measurement SW: DASY5, V5.0 Build 125; SEMCAD X Version 13.4 Build 125

Pin=250mW/Area Scan (91x91x1): Measurement grid: dx=10mm, dy=10mm

Maximum value of SAR (interpolated) = 11.5 mW/g

Pin=250mW/Zoom Scan (7x7x7)/Cube 0: Measurement grid: dx=5mm, dy=5mm, dz=5mm

Reference Value = 84.1 V/m; Power Drift = 0.093 dB

Peak SAR (extrapolated) = 19 W/kg

SAR(1 g) = 10.4 mW/g; SAR(10 g) = 5.74 mW/g

Maximum value of SAR (measured) = 11.4 mW/g

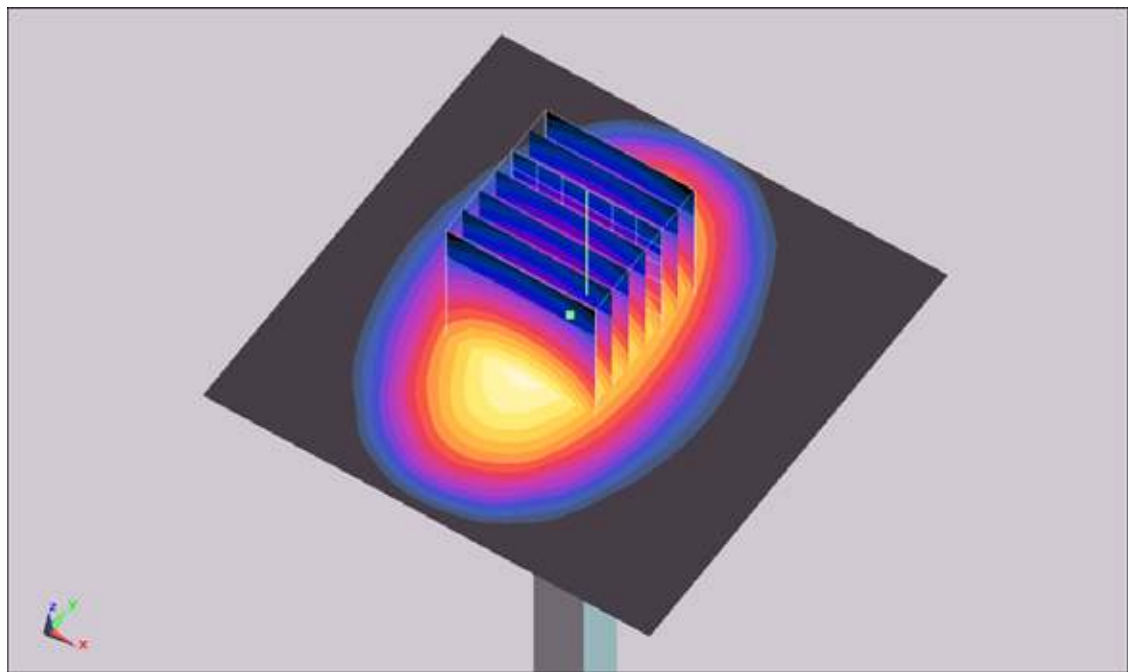
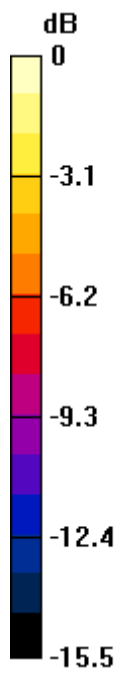

0 dB = 11.4mW/g

System Check_Body_2450MHz_110827

DUT: Dipole 2450 MHz D2450V2

Communication System: CW; Frequency: 2450 MHz; Duty Cycle: 1:1

Medium: MSL_2450_110827 Medium parameters used: $f = 2450$ MHz; $\sigma = 1.957$ mho/m; $\epsilon_r =$

53.837 ; $\rho = 1000$ kg/m³

Ambient Temperature : 22.3 °C ; Liquid Temperature : 21.3 °C

DASY5 Configuration:

- Probe: EX3DV4 - SN3578; ConvF(6.18, 6.18, 6.18); Calibrated: 2011/6/21
- Sensor-Surface: 4mm (Mechanical Surface Detection)
- Electronics: DAE3 Sn577; Calibrated: 2011/1/13
- Phantom: ELI v5.0; Type: QDOVA002AA; Serial: TP1127
- Measurement SW: DASY52, Version 52.6 (2); SEMCAD X Version 14.4.5 (3634)

Pin=250mW/Area Scan (61x61x1): Measurement grid: dx=15mm, dy=15mm

Maximum value of SAR (interpolated) = 15.759 mW/g

Pin=250mW/Zoom Scan (7x7x7)/Cube 0: Measurement grid: dx=5mm, dy=5mm, dz=5mm

Reference Value = 85.278 V/m; Power Drift = 0.0059 dB

Peak SAR (extrapolated) = 29.253 W/kg

SAR(1 g) = 12.9 mW/g; SAR(10 g) = 5.77 mW/g

Maximum value of SAR (measured) = 14.373 mW/g

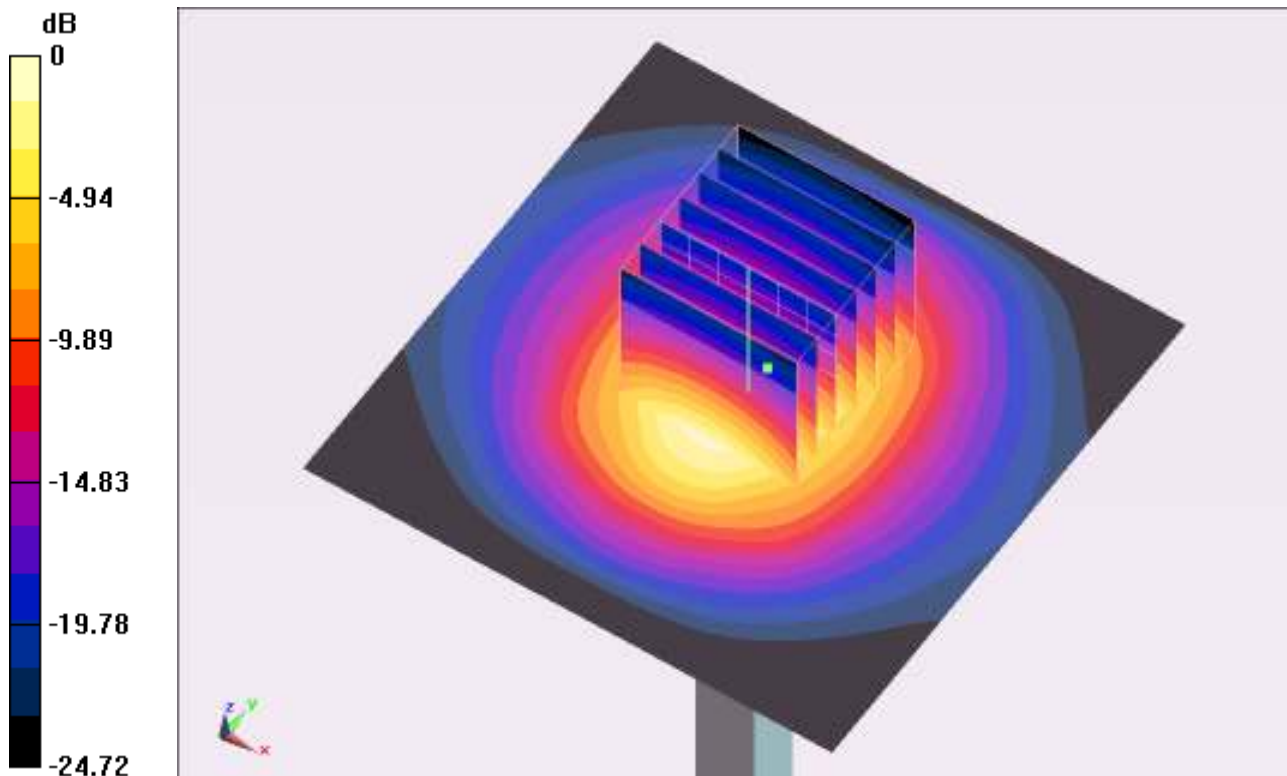

0 dB = 14.370mW/g

System Check_Body_5500MHz_110825

DUT: Dipole 5GHz

Communication System: CW; Frequency: 5500 MHz; Duty Cycle: 1:1

Medium: MSL_5G_110825 Medium parameters used: $f = 5500$ MHz; $\sigma = 5.727$ mho/m; $\epsilon_r = 48.178$;

$\rho = 1000$ kg/m³

Ambient Temperature : 22.6 °C ; Liquid Temperature : 21.6 °C

DASY5 Configuration:

- Probe: EX3DV4 - SN3578; ConvF(3.4, 3.4, 3.4); Calibrated: 2011/6/21
- Sensor-Surface: 2.5mm (Mechanical Surface Detection)
- Electronics: DAE3 Sn577; Calibrated: 2011/1/13
- Phantom: ELI v5.0; Type: QDOVA002AA; Serial: TP1127
- Measurement SW: DASY52, Version 52.6 (2); SEMCAD X Version 14.4.5 (3634)

Pin=250mW/Area Scan (91x91x1): Measurement grid: dx=10mm, dy=10mm

Maximum value of SAR (interpolated) = 37.796 mW/g

Pin=250mW/Zoom Scan (8x8x8)/Cube 0: Measurement grid: dx=4.3mm, dy=4.3mm, dz=3mm

Reference Value = 88.511 V/m; Power Drift = 0.02 dB

Peak SAR (extrapolated) = 59.523 W/kg

SAR(1 g) = 20.6 mW/g; SAR(10 g) = 5.97 mW/g

Maximum value of SAR (measured) = 34.500 mW/g

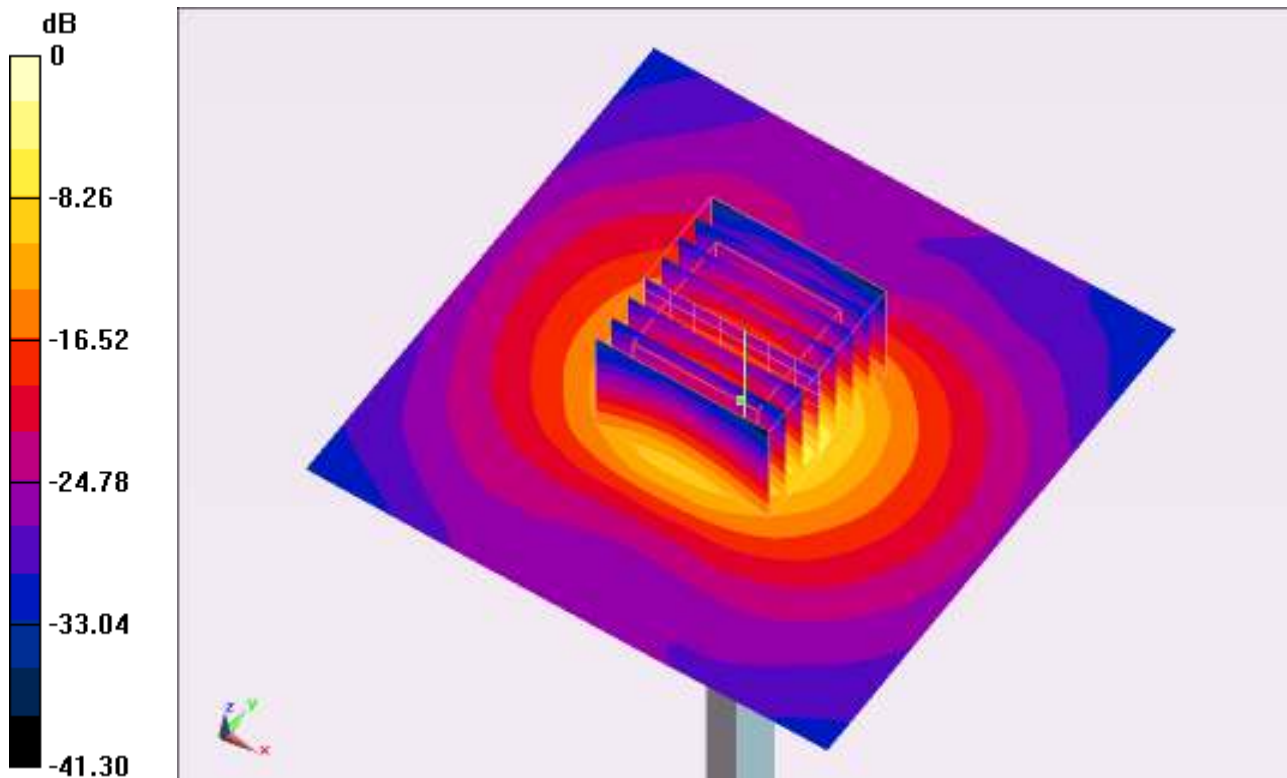

0 dB = 34.500mW/g



Appendix B. Plots of SAR Measurement

The plots are shown as follows.

#07 GSM850_GPRS10_Bottom Face_0cm_Ch251

DUT: 170707

Communication System: GSM850; Frequency: 848.8 MHz; Duty Cycle: 1:4

Medium: MSL_850_110723 Medium parameters used: $f = 849$ MHz; $\sigma = 0.993$ mho/m; $\epsilon_r = 52.5$; $\rho = 1000$ kg/m³

Ambient Temperature : 22.3 °C; Liquid Temperature : 21.3 °C

DASY5 Configuration:

- Probe: ET3DV6 - SN1787; ConvF(6.35, 6.35, 6.35); Calibrated: 2011/5/20
- Sensor-Surface: 4mm (Mechanical Surface Detection)
- Electronics: DAE3 Sn495; Calibrated: 2011/4/28
- Phantom: ELI 4.0; Type: QDOVA001BA; Serial: 1029
- Measurement SW: DASY5, V5.0 Build 125; SEMCAD X Version 13.4 Build 125

Ch251/Area Scan (101x131x1): Measurement grid: dx=20mm, dy=20mm

Maximum value of SAR (interpolated) = 0.279 mW/g

Ch251/Zoom Scan (5x5x7)/Cube 0: Measurement grid: dx=8mm, dy=8mm, dz=5mm

Reference Value = 13.1 V/m; Power Drift = -0.113 dB

Peak SAR (extrapolated) = 0.326 W/kg

SAR(1 g) = 0.246 mW/g; SAR(10 g) = 0.168 mW/g

Maximum value of SAR (measured) = 0.261 mW/g

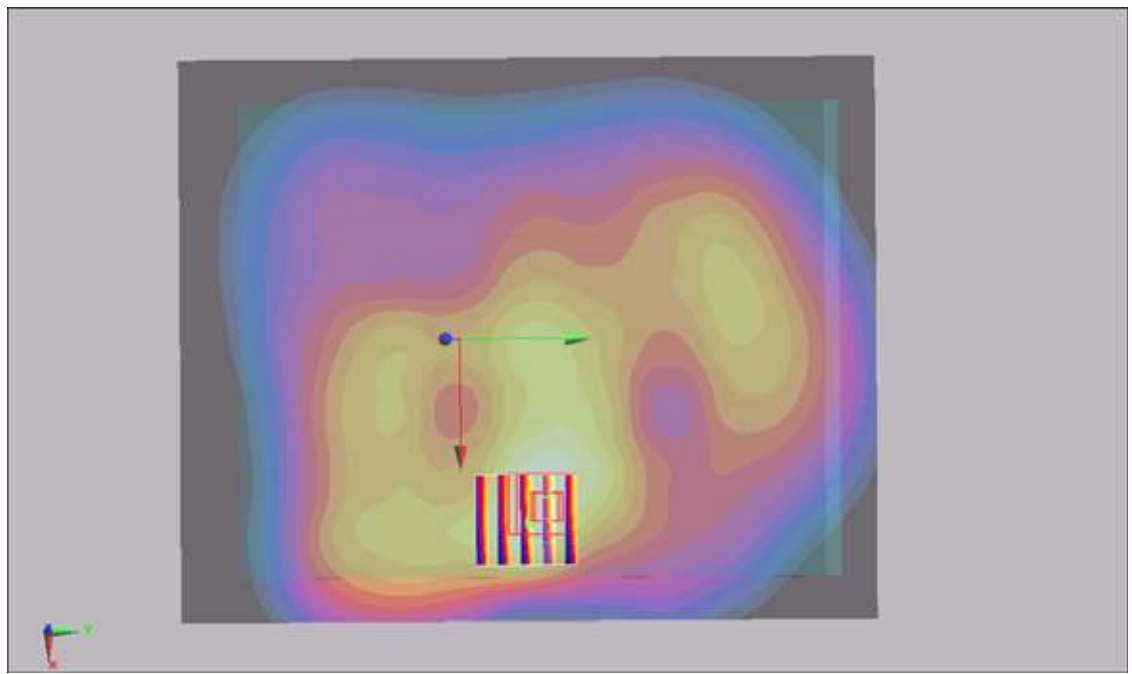
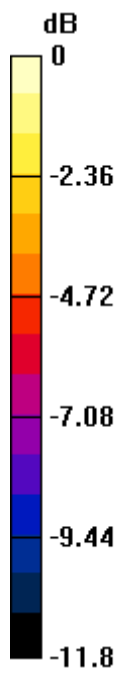

0 dB = 0.261mW/g

#08 GSM850_GPRS10_Secondary Landscape_0cm_Ch251_Earphone

DUT: 170707

Communication System: GSM850; Frequency: 848.8 MHz; Duty Cycle: 1:4

Medium: MSL_850_110723 Medium parameters used: $f = 849$ MHz; $\sigma = 0.993$ mho/m; $\epsilon_r = 52.5$; $\rho = 1000$ kg/m³

Ambient Temperature : 22.3 °C ; Liquid Temperature : 21.3 °C

DASY5 Configuration:

- Probe: ET3DV6 - SN1787; ConvF(6.35, 6.35, 6.35); Calibrated: 2011/5/20
- Sensor-Surface: 4mm (Mechanical Surface Detection)
- Electronics: DAE3 Sn495; Calibrated: 2011/4/28
- Phantom: ELI 4.0; Type: QDOVA001BA; Serial: 1029
- Measurement SW: DASY5, V5.0 Build 125; SEMCAD X Version 13.4 Build 125

Ch251/Area Scan (41x131x1): Measurement grid: dx=20mm, dy=20mm

Maximum value of SAR (interpolated) = 0.418 mW/g

Ch251/Zoom Scan (5x5x7)/Cube 0: Measurement grid: dx=8mm, dy=8mm, dz=5mm

Reference Value = 20.7 V/m; Power Drift = 0.028 dB

Peak SAR (extrapolated) = 0.718 W/kg

SAR(1 g) = 0.403 mW/g; SAR(10 g) = 0.248 mW/g

Maximum value of SAR (measured) = 0.431 mW/g

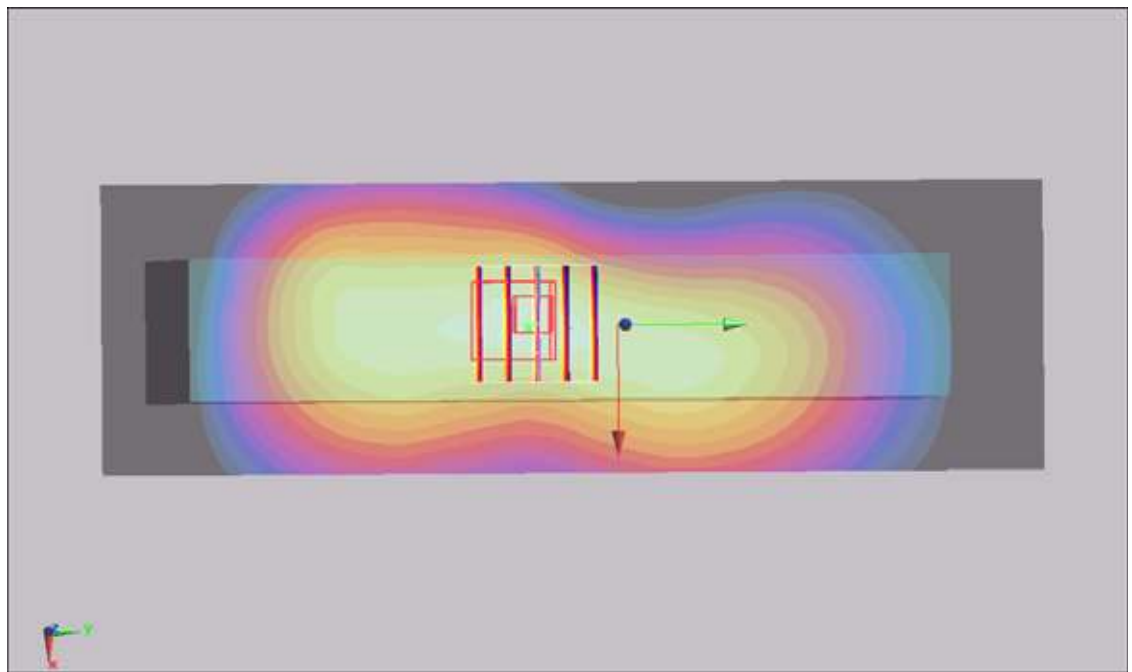
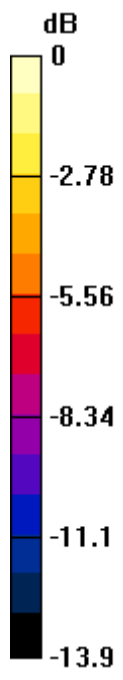

0 dB = 0.431mW/g

#08 GSM850_GPRS10_Secondary Landscape_0cm_Ch251_Earphone_2D

DUT: 170707

Communication System: GSM850; Frequency: 848.8 MHz; Duty Cycle: 1:4

Medium: MSL_850_110723 Medium parameters used: $f = 849$ MHz; $\sigma = 0.993$ mho/m; $\epsilon_r = 52.5$; $\rho = 1000$ kg/m³

Ambient Temperature : 22.3 °C ; Liquid Temperature : 21.3 °C

DASY5 Configuration:

- Probe: ET3DV6 - SN1787; ConvF(6.35, 6.35, 6.35); Calibrated: 2011/5/20
- Sensor-Surface: 4mm (Mechanical Surface Detection)
- Electronics: DAE3 Sn495; Calibrated: 2011/4/28
- Phantom: ELI 4.0; Type: QDOVA001BA; Serial: 1029
- Measurement SW: DASY5, V5.0 Build 125; SEMCAD X Version 13.4 Build 125

Ch251/Area Scan (41x131x1): Measurement grid: dx=20mm, dy=20mm

Maximum value of SAR (interpolated) = 0.418 mW/g

Ch251/Zoom Scan (5x5x7)/Cube 0: Measurement grid: dx=8mm, dy=8mm, dz=5mm

Reference Value = 20.7 V/m; Power Drift = 0.028 dB

Peak SAR (extrapolated) = 0.718 W/kg

SAR(1 g) = 0.403 mW/g; SAR(10 g) = 0.248 mW/g

Maximum value of SAR (measured) = 0.431 mW/g

1g/10g Averaged SAR

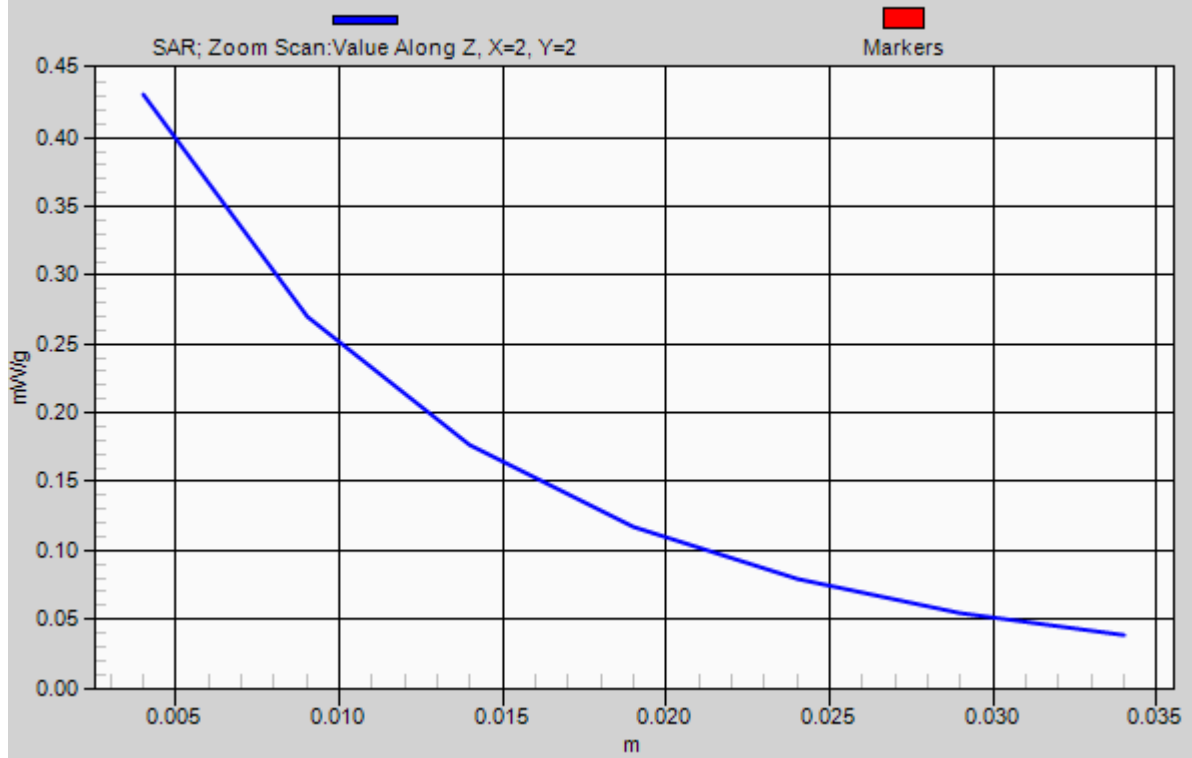

#01 GSM1900_GPRS10_Bottom Face_0cm_Ch512

DUT: 170707

Communication System: PCS; Frequency: 1850.2 MHz; Duty Cycle: 1:4

Medium: MSL_1900_110723 Medium parameters used : $f = 1850.2$ MHz; $\sigma = 1.46$ mho/m; $\epsilon_r = 54.9$; $\rho = 1000$ kg/m³

Ambient Temperature : 22.5 °C; Liquid Temperature : 21.5 °C

DASY5 Configuration:

- Probe: EX3DV4 - SN3792; ConvF(7.17, 7.17, 7.17); Calibrated: 2011/6/20
- Sensor-Surface: 4mm (Mechanical Surface Detection)
- Electronics: DAE4 Sn778; Calibrated: 2010/10/22
- Phantom: ELI 4.0; Type: QDOVA001BA; Serial: 1029
- Measurement SW: DASY5, V5.0 Build 125; SEMCAD X Version 13.4 Build 125

Ch512/Area Scan (101x131x1): Measurement grid: dx=20mm, dy=20mm

Maximum value of SAR (interpolated) = 0.391 mW/g

Ch512/Zoom Scan (5x5x7)/Cube 0: Measurement grid: dx=8mm, dy=8mm, dz=5mm

Reference Value = 4.93 V/m; Power Drift = -0.015 dB

Peak SAR (extrapolated) = 0.690 W/kg

SAR(1 g) = 0.411 mW/g; SAR(10 g) = 0.228 mW/g

Maximum value of SAR (measured) = 0.447 mW/g

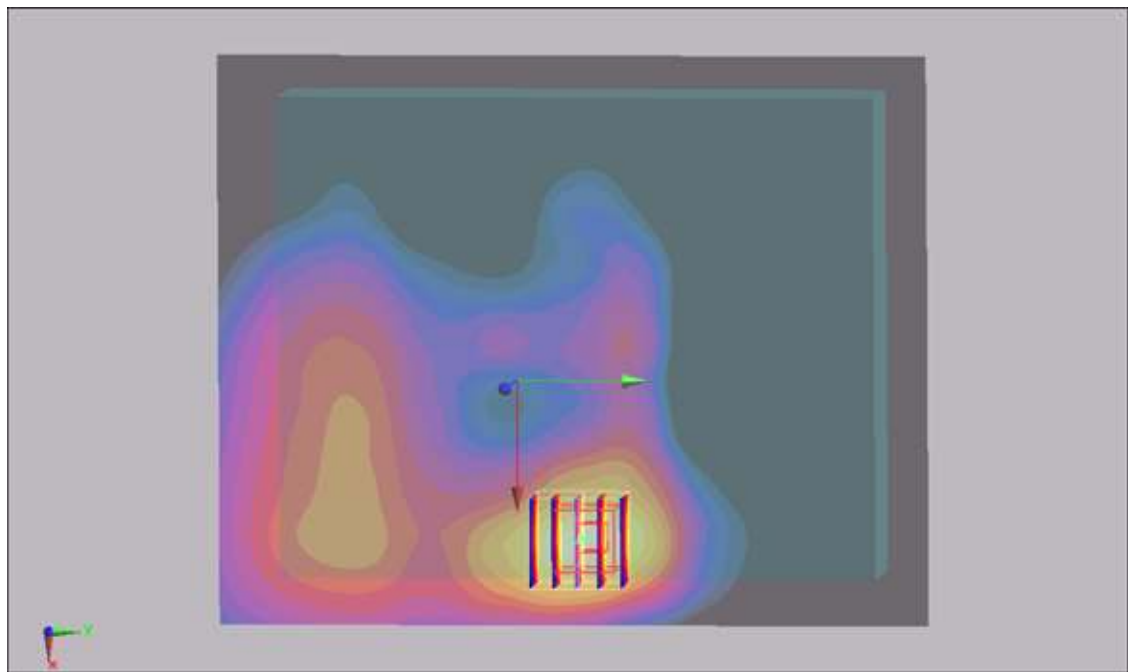
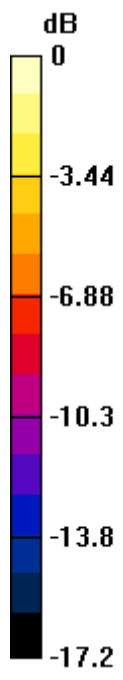

0 dB = 0.447mW/g

#01 GSM1900_GPRS10_Bottom Face_0cm_Ch512_2D

DUT: 170707

Communication System: PCS; Frequency: 1850.2 MHz; Duty Cycle: 1:4

Medium: MSL_1900_110723 Medium parameters used : $f = 1850.2$ MHz; $\sigma = 1.46$ mho/m; $\epsilon_r = 54.9$; $\rho = 1000$ kg/m³

Ambient Temperature : 22.5 °C ; Liquid Temperature : 21.5 °C

DASY5 Configuration:

- Probe: EX3DV4 - SN3792; ConvF(7.17, 7.17, 7.17); Calibrated: 2011/6/20
- Sensor-Surface: 4mm (Mechanical Surface Detection)
- Electronics: DAE4 Sn778; Calibrated: 2010/10/22
- Phantom: ELI 4.0; Type: QDOVA001BA; Serial: 1029
- Measurement SW: DASY5, V5.0 Build 125; SEMCAD X Version 13.4 Build 125

Ch512/Area Scan (101x131x1): Measurement grid: dx=20mm, dy=20mm

Maximum value of SAR (interpolated) = 0.391 mW/g

Ch512/Zoom Scan (5x5x7)/Cube 0: Measurement grid: dx=8mm, dy=8mm, dz=5mm

Reference Value = 4.93 V/m; Power Drift = -0.015 dB

Peak SAR (extrapolated) = 0.690 W/kg

SAR(1 g) = 0.411 mW/g; SAR(10 g) = 0.228 mW/g

Maximum value of SAR (measured) = 0.447 mW/g

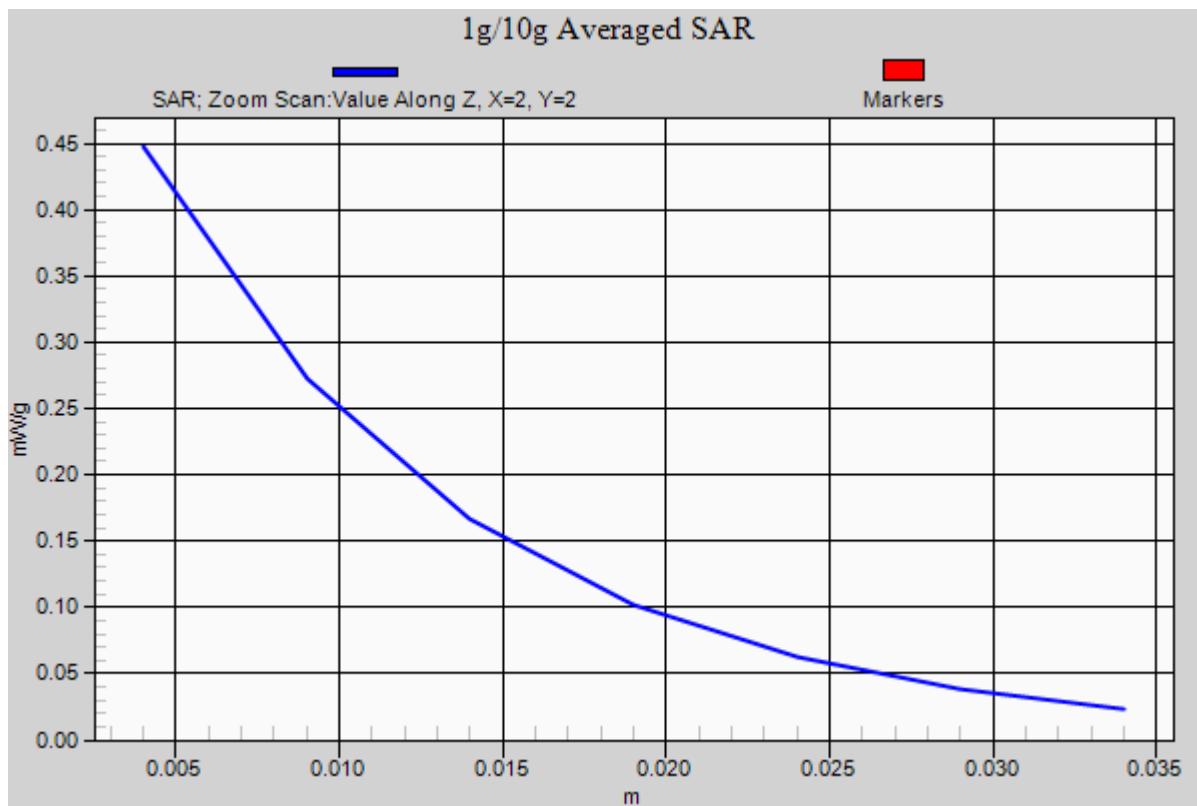

#02 GSM1900_GPRS10_Secondary Landscape_0cm_Ch512_Earphone

DUT: 170707

Communication System: PCS; Frequency: 1850.2 MHz; Duty Cycle: 1:4

Medium: MSL_1900_110723 Medium parameters used : $f = 1850.2$ MHz; $\sigma = 1.46$ mho/m; $\epsilon_r = 54.9$; $\rho = 1000$ kg/m³

Ambient Temperature : 22.5 °C; Liquid Temperature : 21.5 °C

DASY5 Configuration:

- Probe: EX3DV4 - SN3792; ConvF(7.17, 7.17, 7.17); Calibrated: 2011/6/20
- Sensor-Surface: 4mm (Mechanical Surface Detection)
- Electronics: DAE4 Sn778; Calibrated: 2010/10/22
- Phantom: ELI 4.0; Type: QDOVA001BA; Serial: 1029
- Measurement SW: DASY5, V5.0 Build 125; SEMCAD X Version 13.4 Build 125

Ch512/Area Scan (41x131x1): Measurement grid: dx=20mm, dy=20mm

Maximum value of SAR (interpolated) = 0.431 mW/g

Ch512/Zoom Scan (5x5x7)/Cube 0: Measurement grid: dx=8mm, dy=8mm, dz=5mm

Reference Value = 14.5 V/m; Power Drift = -0.198 dB

Peak SAR (extrapolated) = 0.614 W/kg

SAR(1 g) = 0.366 mW/g; SAR(10 g) = 0.216 mW/g

Maximum value of SAR (measured) = 0.400 mW/g

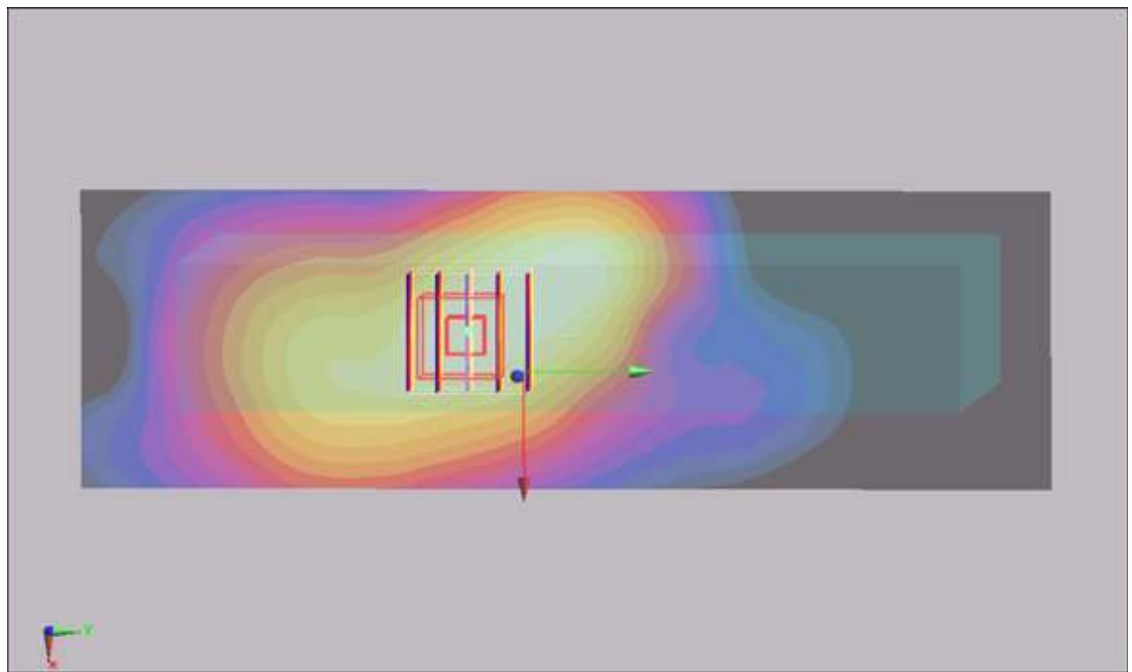
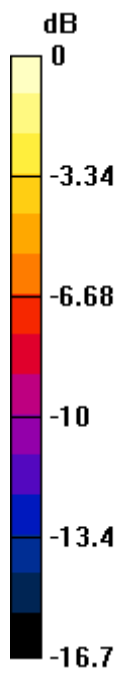

0 dB = 0.400mW/g

#09 WCDMA V_RMC12.2K_Bottom Face_0cm_Ch4182

DUT: 170707

Communication System: WCDMA; Frequency: 836.4 MHz; Duty Cycle: 1:1

Medium: MSL_850_110723 Medium parameters used : $f = 836.4$ MHz; $\sigma = 0.98$ mho/m; $\epsilon_r = 52.6$; $\rho = 1000$ kg/m³

Ambient Temperature : 22.3 °C ; Liquid Temperature : 22.3 °C

DASY5 Configuration:

- Probe: ET3DV6 - SN1787; ConvF(6.35, 6.35, 6.35); Calibrated: 2011/5/20
- Sensor-Surface: 4mm (Mechanical Surface Detection)
- Electronics: DAE3 Sn495; Calibrated: 2011/4/28
- Phantom: ELI 4.0; Type: QDOVA001BA; Serial: 1029
- Measurement SW: DASY5, V5.0 Build 125; SEMCAD X Version 13.4 Build 125

Ch4182/Area Scan (10x131x1): Measurement grid: dx=20mm, dy=20mm

Maximum value of SAR (interpolated) = 0.163 mW/g

Ch4182/Zoom Scan (5x5x7)/Cube 0: Measurement grid: dx=8mm, dy=8mm, dz=5mm

Reference Value = 9.69 V/m; Power Drift = -0.051 dB

Peak SAR (extrapolated) = 0.198 W/kg

SAR(1 g) = 0.146 mW/g; SAR(10 g) = 0.098 mW/g

Maximum value of SAR (measured) = 0.154 mW/g

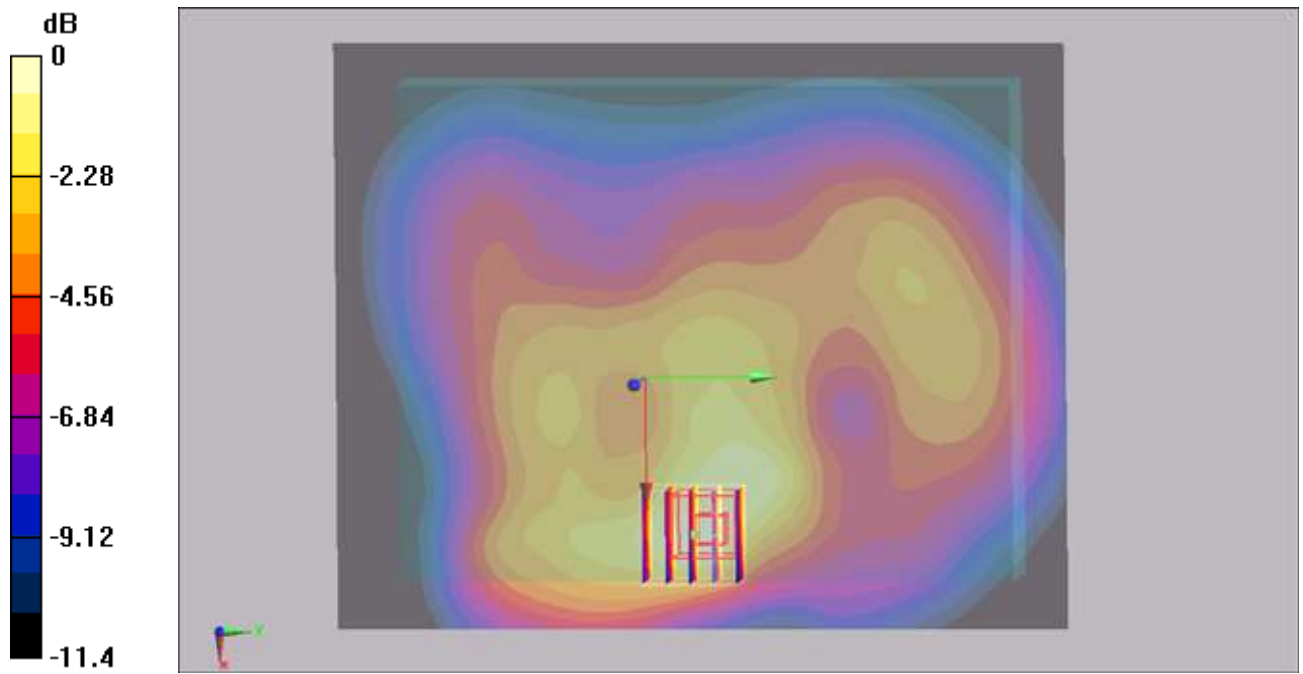

0 dB = 0.154mW/g

#10 WCDMA V_RMC12.2K_Secondary Landscape_0cm_Ch4182_Earphone

DUT: 170707

Communication System: WCDMA; Frequency: 836.4 MHz; Duty Cycle: 1:1

Medium: MSL_850_110723 Medium parameters used : $f = 836.4$ MHz; $\sigma = 0.98$ mho/m; $\epsilon_r = 52.6$; $\rho = 1000$ kg/m³

Ambient Temperature : 22.3 °C; Liquid Temperature : 21.3 °C

DASY5 Configuration:

- Probe: ET3DV6 - SN1787; ConvF(6.35, 6.35, 6.35); Calibrated: 2011/5/20
- Sensor-Surface: 4mm (Mechanical Surface Detection)
- Electronics: DAE3 Sn495; Calibrated: 2011/4/28
- Phantom: ELI 4.0; Type: QDOVA001BA; Serial: 1029
- Measurement SW: DASY5, V5.0 Build 125; SEMCAD X Version 13.4 Build 125

Ch4182/Area Scan (41x131x1): Measurement grid: dx=20mm, dy=20mm

Maximum value of SAR (interpolated) = 0.309 mW/g

Ch4182/Zoom Scan (5x5x7)/Cube 0: Measurement grid: dx=8mm, dy=8mm, dz=5mm

Reference Value = 17.6 V/m; Power Drift = 0.184 dB

Peak SAR (extrapolated) = 0.531 W/kg

SAR(1 g) = 0.300 mW/g; SAR(10 g) = 0.185 mW/g

Maximum value of SAR (measured) = 0.326 mW/g

Ch4182/Zoom Scan (5x5x7)/Cube 1: Measurement grid: dx=8mm, dy=8mm, dz=5mm

Reference Value = 17.6 V/m; Power Drift = 0.184 dB

Peak SAR (extrapolated) = 0.318 W/kg

SAR(1 g) = 0.240 mW/g; SAR(10 g) = 0.168 mW/g

Maximum value of SAR (measured) = 0.268 mW/g

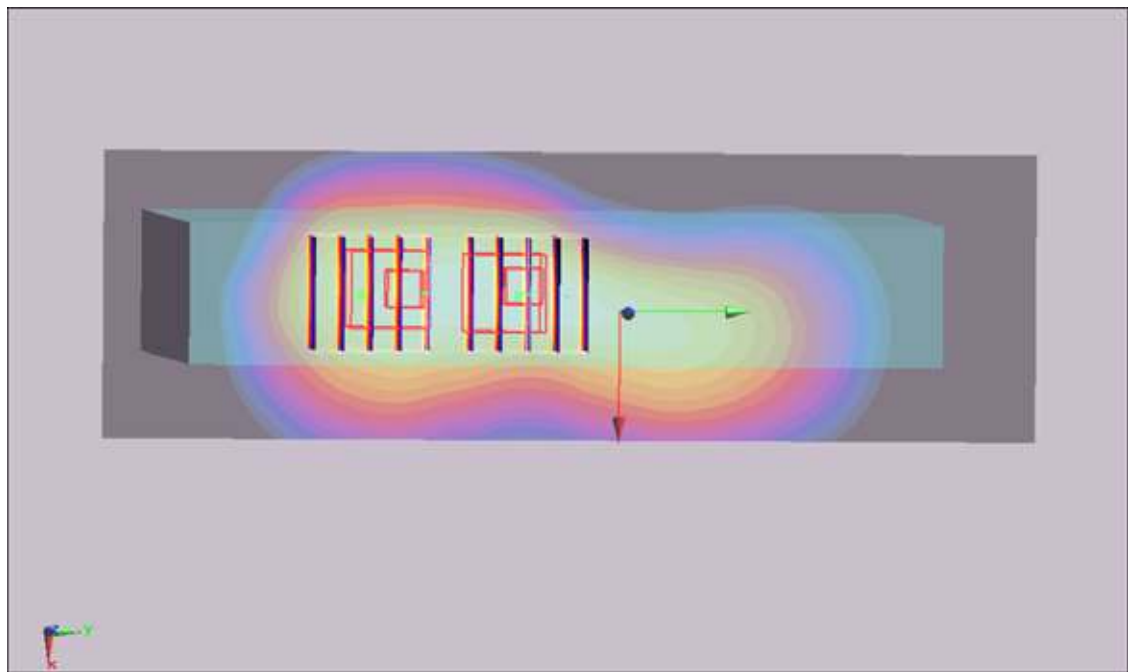
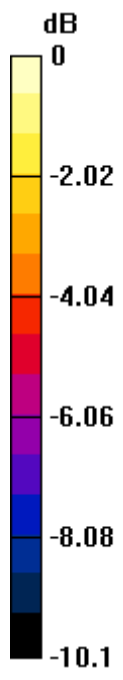

0 dB = 0.268mW/g

#10 WCDMA V_RMC12.2K_Secondary Landscape_0cm_Ch4182_Earphone_2D

DUT: 170707

Communication System: WCDMA; Frequency: 836.4 MHz; Duty Cycle: 1:1

Medium: MSL_850_110723 Medium parameters used : $f = 836.4$ MHz; $\sigma = 0.98$ mho/m; $\epsilon_r = 52.6$; $\rho = 1000$ kg/m³

Ambient Temperature : 22.3 °C; Liquid Temperature : 21.3 °C

DASY5 Configuration:

- Probe: ET3DV6 - SN1787; ConvF(6.35, 6.35, 6.35); Calibrated: 2011/5/20
- Sensor-Surface: 4mm (Mechanical Surface Detection)
- Electronics: DAE3 Sn495; Calibrated: 2011/4/28
- Phantom: ELI 4.0; Type: QDOVA001BA; Serial: 1029
- Measurement SW: DASY5, V5.0 Build 125; SEMCAD X Version 13.4 Build 125

Ch4182/Area Scan (41x131x1): Measurement grid: dx=20mm, dy=20mm

Maximum value of SAR (interpolated) = 0.309 mW/g

Ch4182/Zoom Scan (5x5x7)/Cube 0: Measurement grid: dx=8mm, dy=8mm, dz=5mm

Reference Value = 17.6 V/m; Power Drift = 0.184 dB

Peak SAR (extrapolated) = 0.531 W/kg

SAR(1 g) = 0.300 mW/g; SAR(10 g) = 0.185 mW/g

Maximum value of SAR (measured) = 0.326 mW/g

Ch4182/Zoom Scan (5x5x7)/Cube 1: Measurement grid: dx=8mm, dy=8mm, dz=5mm

Reference Value = 17.6 V/m; Power Drift = 0.184 dB

Peak SAR (extrapolated) = 0.318 W/kg

SAR(1 g) = 0.240 mW/g; SAR(10 g) = 0.168 mW/g

Maximum value of SAR (measured) = 0.268 mW/g

1g/10g Averaged SAR

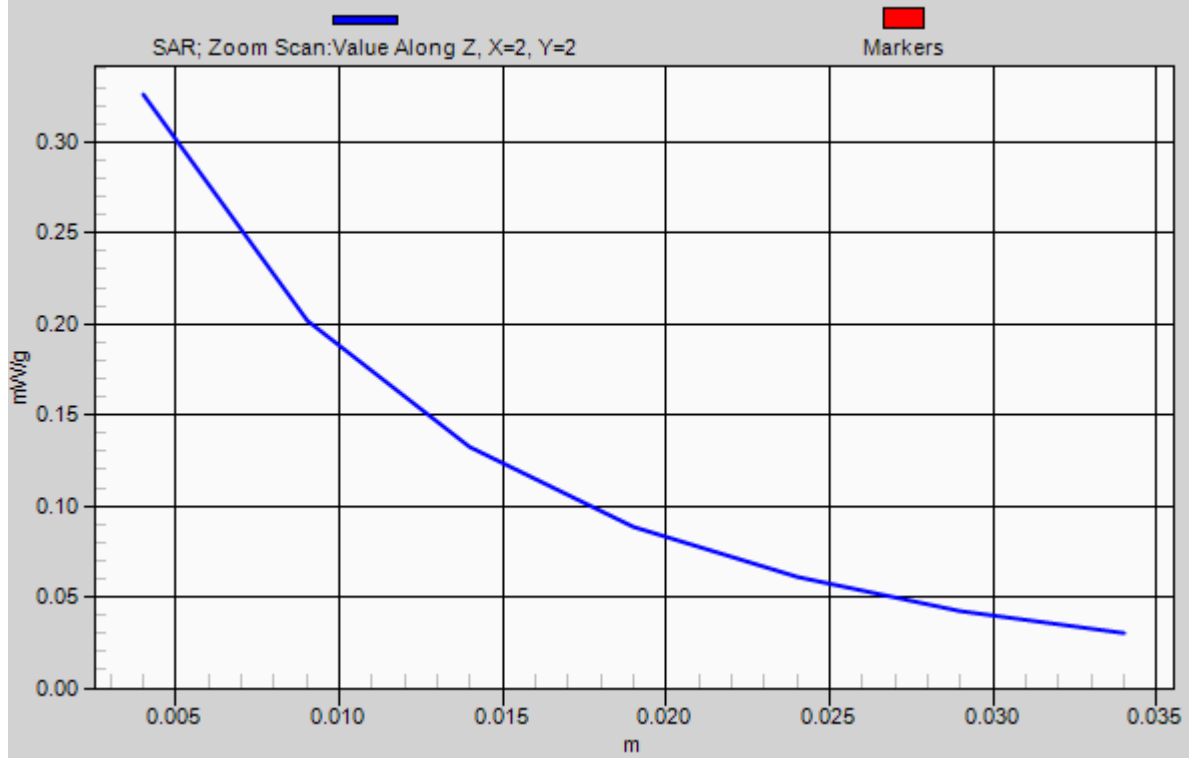

#13 WCDMA IV_RMC12.2K_Bottom Face_0cm_Ch1413

DUT: 170707

Communication System: WCDMA; Frequency: 1732.6 MHz; Duty Cycle: 1:1

Medium: MSL_1800_110725 Medium parameters used: $f = 1733$ MHz; $\sigma = 1.51$ mho/m; $\epsilon_r = 52.1$; $\rho = 1000$ kg/m³

Ambient Temperature : 22.3 °C ; Liquid Temperature : 21.3 °C

DASY5 Configuration:

- Probe: ET3DV6 - SN1787; ConvF(4.74, 4.74, 4.74); Calibrated: 2011/5/20
- Sensor-Surface: 4mm (Mechanical Surface Detection)
- Electronics: DAE3 Sn495; Calibrated: 2011/4/28
- Phantom: ELI 4.0; Type: QDOVA001BA; Serial: 1029
- Measurement SW: DASY5, V5.0 Build 125; SEMCAD X Version 13.4 Build 125

Ch1413/Area Scan (10x131x1): Measurement grid: dx=20mm, dy=20mm

Maximum value of SAR (interpolated) = 0.485 mW/g

Ch1413/Zoom Scan (5x5x7)/Cube 0: Measurement grid: dx=8mm, dy=8mm, dz=5mm

Reference Value = 4.15 V/m; Power Drift = -0.086 dB

Peak SAR (extrapolated) = 0.678 W/kg

SAR(1 g) = 0.463 mW/g; SAR(10 g) = 0.269 mW/g

Maximum value of SAR (measured) = 0.516 mW/g

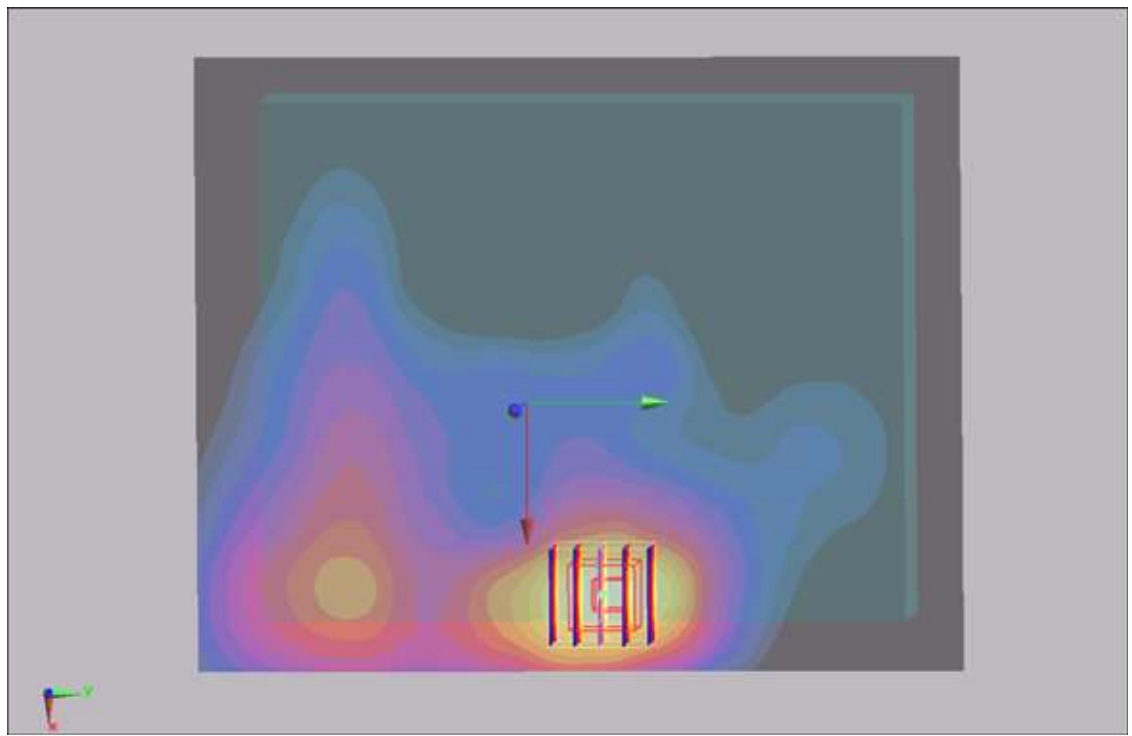
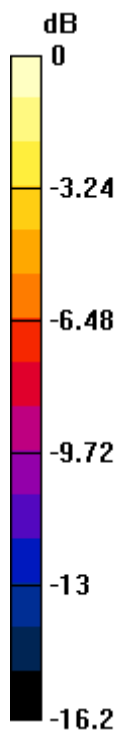

0 dB = 0.516mW/g

#13 WCDMA IV_RMC12.2K_Bottom Face_0cm_Ch1413_2D

DUT: 170707

Communication System: WCDMA; Frequency: 1732.6 MHz; Duty Cycle: 1:1

Medium: MSL_1800_110725 Medium parameters used: $f = 1733$ MHz; $\sigma = 1.51$ mho/m; $\epsilon_r = 52.1$; $\rho = 1000$ kg/m³

Ambient Temperature : 22.3 °C ; Liquid Temperature : 21.3 °C

DASY5 Configuration:

- Probe: ET3DV6 - SN1787; ConvF(4.74, 4.74, 4.74); Calibrated: 2011/5/20
- Sensor-Surface: 4mm (Mechanical Surface Detection)
- Electronics: DAE3 Sn495; Calibrated: 2011/4/28
- Phantom: ELI 4.0; Type: QDOVA001BA; Serial: 1029
- Measurement SW: DASY5, V5.0 Build 125; SEMCAD X Version 13.4 Build 125

Ch1413/Area Scan (10x131x1): Measurement grid: dx=20mm, dy=20mm

Maximum value of SAR (interpolated) = 0.485 mW/g

Ch1413/Zoom Scan (5x5x7)/Cube 0: Measurement grid: dx=8mm, dy=8mm, dz=5mm

Reference Value = 4.15 V/m; Power Drift = -0.086 dB

Peak SAR (extrapolated) = 0.678 W/kg

SAR(1 g) = 0.463 mW/g; SAR(10 g) = 0.269 mW/g

Maximum value of SAR (measured) = 0.516 mW/g

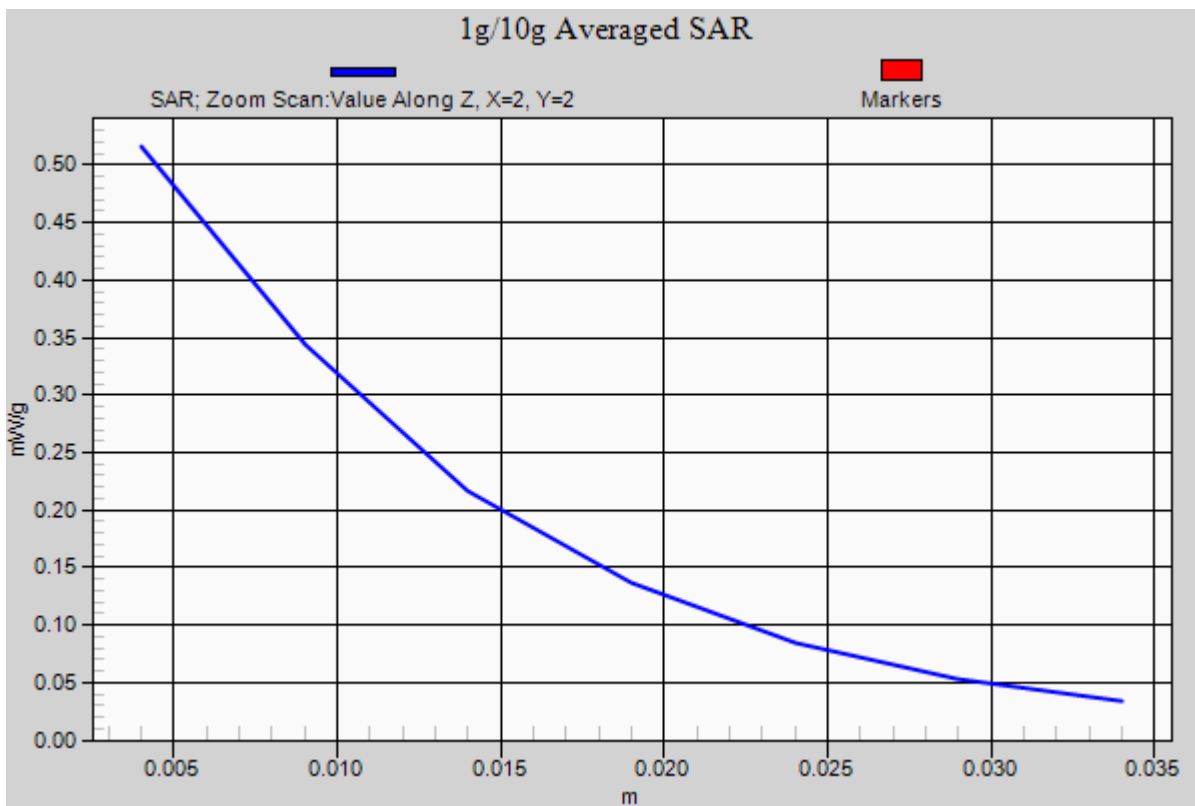

#14 WCDMA IV_RMC12.2K_Secondary Landscape_0cm_Ch1413_Earphone

DUT: 170707

Communication System: WCDMA; Frequency: 1732.6 MHz; Duty Cycle: 1:1

Medium: MSL_1800_110725 Medium parameters used: $f = 1733$ MHz; $\sigma = 1.51$ mho/m; $\epsilon_r = 52.1$; $\rho = 1000$ kg/m³

Ambient Temperature : 22.3 °C ; Liquid Temperature : 21.3 °C

DASY5 Configuration:

- Probe: ET3DV6 - SN1787; ConvF(4.74, 4.74, 4.74); Calibrated: 2011/5/20
- Sensor-Surface: 4mm (Mechanical Surface Detection)
- Electronics: DAE3 Sn495; Calibrated: 2011/4/28
- Phantom: ELI 4.0; Type: QDOVA001BA; Serial: 1029
- Measurement SW: DASY5, V5.0 Build 125; SEMCAD X Version 13.4 Build 125

Ch1413/Area Scan (41x131x1): Measurement grid: dx=20mm, dy=20mm

Maximum value of SAR (interpolated) = 0.515 mW/g

Ch1413/Zoom Scan (5x5x7)/Cube 0: Measurement grid: dx=8mm, dy=8mm, dz=5mm

Reference Value = 16.3 V/m; Power Drift = 0.011 dB

Peak SAR (extrapolated) = 0.619 W/kg

SAR(1 g) = 0.431 mW/g; SAR(10 g) = 0.265 mW/g

Maximum value of SAR (measured) = 0.467 mW/g

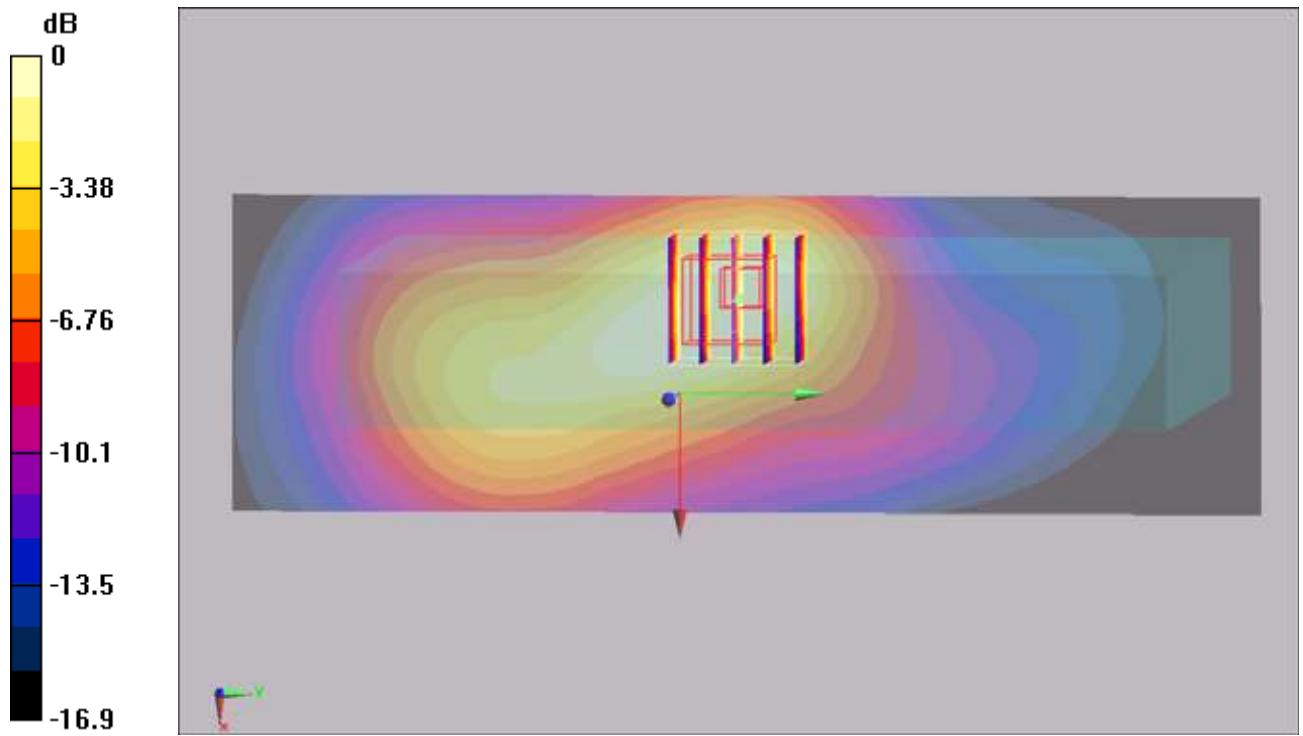

0 dB = 0.467mW/g

#03 WCDMA II_RMC12.2K_Bottom Face_0cm_Ch9400

DUT: 170707

Communication System: WCDMA; Frequency: 1880 MHz; Duty Cycle: 1:1

Medium: MSL_1900_110723 Medium parameters used: $f = 1880$ MHz; $\sigma = 1.5$ mho/m; $\epsilon_r = 54.8$; $\rho = 1000$ kg/m³

Ambient Temperature : 22.5 °C; Liquid Temperature : 21.5 °C

DASY5 Configuration:

- Probe: EX3DV4 - SN3792; ConvF(7.17, 7.17, 7.17); Calibrated: 2011/6/20
- Sensor-Surface: 4mm (Mechanical Surface Detection)
- Electronics: DAE4 Sn778; Calibrated: 2010/10/22
- Phantom: ELI 4.0; Type: QDOVA001BA; Serial: 1029
- Measurement SW: DASY5, V5.0 Build 125; SEMCAD X Version 13.4 Build 125

Ch9400/Area Scan (101x131x1): Measurement grid: dx=20mm, dy=20mm

Maximum value of SAR (interpolated) = 0.647 mW/g

Ch9400/Zoom Scan (5x5x7)/Cube 0: Measurement grid: dx=8mm, dy=8mm, dz=5mm

Reference Value = 5.2 V/m; Power Drift = -0.117 dB

Peak SAR (extrapolated) = 1.07 W/kg

SAR(1 g) = 0.629 mW/g; SAR(10 g) = 0.345 mW/g

Maximum value of SAR (measured) = 0.651 mW/g

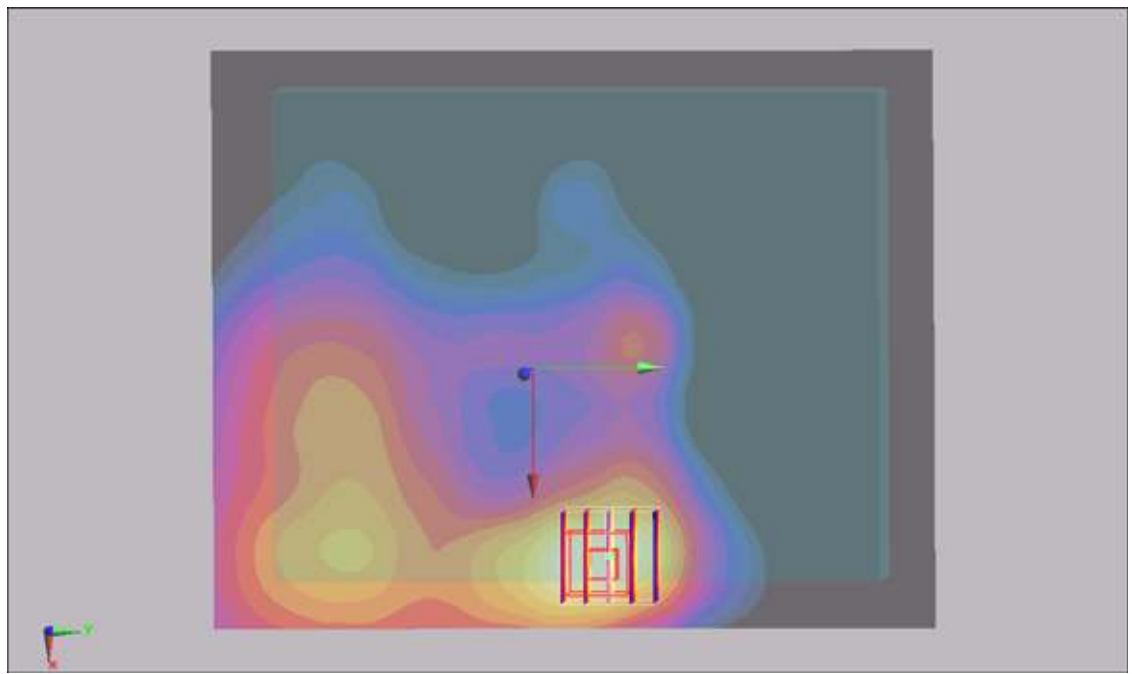
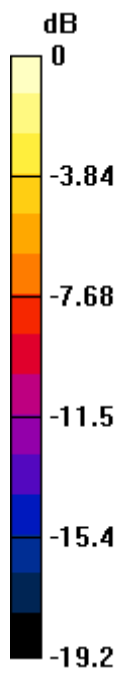

0 dB = 0.651mW/g

#03 WCDMA II_RMC12.2K_Bottom Face_0cm_Ch9400_2D

DUT: 170707

Communication System: WCDMA; Frequency: 1880 MHz; Duty Cycle: 1:1

Medium: MSL_1900_110723 Medium parameters used: $f = 1880$ MHz; $\sigma = 1.5$ mho/m; $\epsilon_r = 54.8$; $\rho = 1000$ kg/m³

Ambient Temperature : 22.5 °C ; Liquid Temperature : 21.5 °C

DASY5 Configuration:

- Probe: EX3DV4 - SN3792; ConvF(7.17, 7.17, 7.17); Calibrated: 2011/6/20
- Sensor-Surface: 4mm (Mechanical Surface Detection)
- Electronics: DAE4 Sn778; Calibrated: 2010/10/22
- Phantom: ELI 4.0; Type: QDOVA001BA; Serial: 1029
- Measurement SW: DASY5, V5.0 Build 125; SEMCAD X Version 13.4 Build 125

Ch9400/Area Scan (101x131x1): Measurement grid: dx=20mm, dy=20mm

Maximum value of SAR (interpolated) = 0.647 mW/g

Ch9400/Zoom Scan (5x5x7)/Cube 0: Measurement grid: dx=8mm, dy=8mm, dz=5mm

Reference Value = 5.2 V/m; Power Drift = -0.117 dB

Peak SAR (extrapolated) = 1.07 W/kg

SAR(1 g) = 0.629 mW/g; SAR(10 g) = 0.345 mW/g

Maximum value of SAR (measured) = 0.651 mW/g

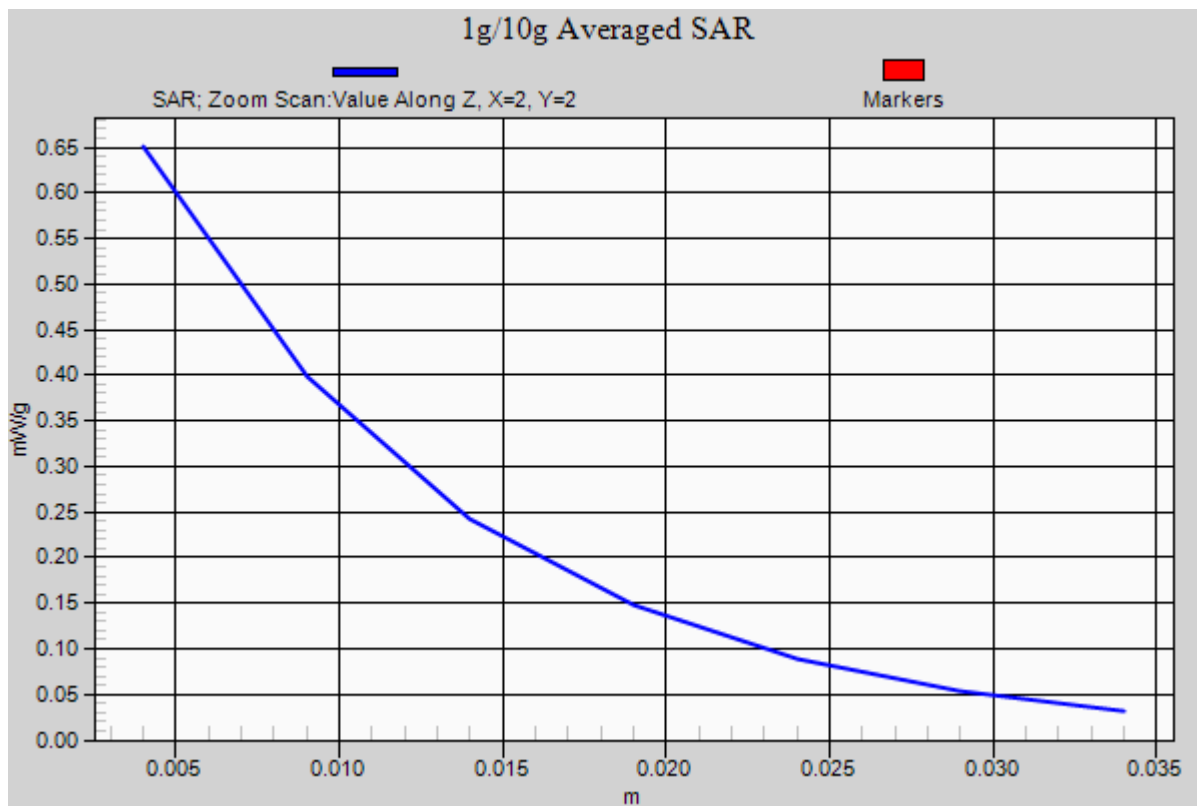

#04 WCDMA II_RMC12.2K_Secondary Landscape_0cm_Ch9400_Earphone

DUT: 170707

Communication System: WCDMA; Frequency: 1880 MHz; Duty Cycle: 1:1

Medium: MSL_1900_110723 Medium parameters used: $f = 1880$ MHz; $\sigma = 1.5$ mho/m; $\epsilon_r = 54.8$; $\rho = 1000$ kg/m³

Ambient Temperature : 22.5 °C ; Liquid Temperature : 21.5 °C

DASY5 Configuration:

- Probe: EX3DV4 - SN3792; ConvF(7.17, 7.17, 7.17); Calibrated: 2011/6/20
- Sensor-Surface: 4mm (Mechanical Surface Detection)
- Electronics: DAE4 Sn778; Calibrated: 2010/10/22
- Phantom: ELI 4.0; Type: QDOVA001BA; Serial: 1029
- Measurement SW: DASY5, V5.0 Build 125; SEMCAD X Version 13.4 Build 125

Ch9400/Area Scan (41x131x1): Measurement grid: dx=20mm, dy=20mm

Maximum value of SAR (interpolated) = 0.633 mW/g

Ch9400/Zoom Scan (5x5x7)/Cube 0: Measurement grid: dx=8mm, dy=8mm, dz=5mm

Reference Value = 16.3 V/m; Power Drift = -0.139 dB

Peak SAR (extrapolated) = 0.913 W/kg

SAR(1 g) = 0.500 mW/g; SAR(10 g) = 0.285 mW/g

Maximum value of SAR (measured) = 0.594 mW/g

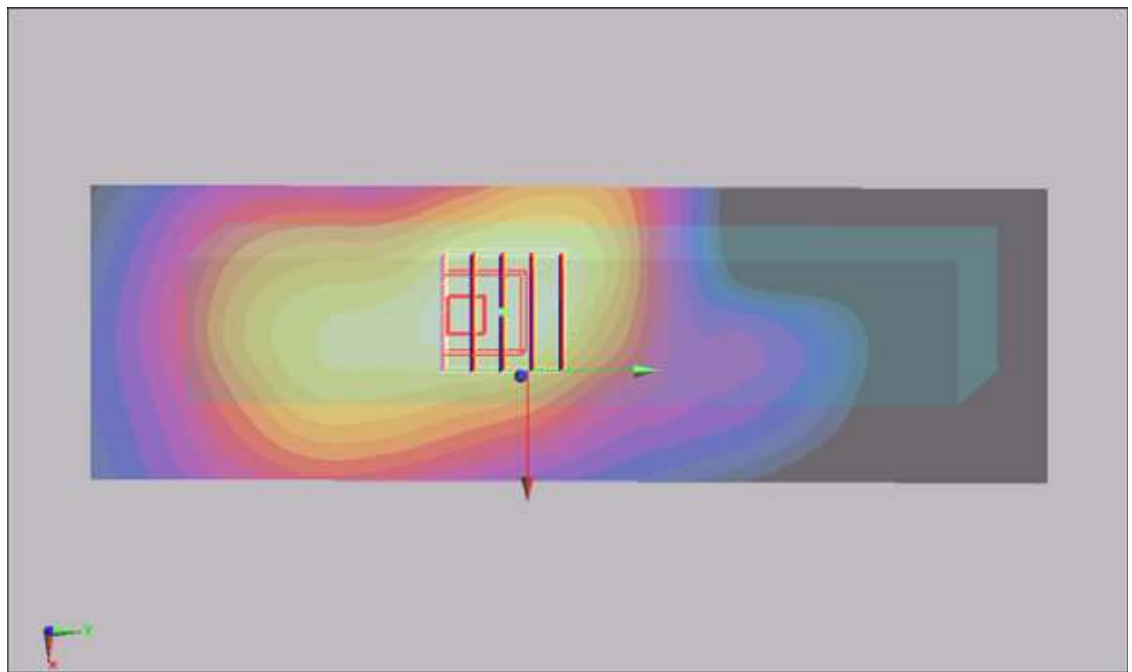
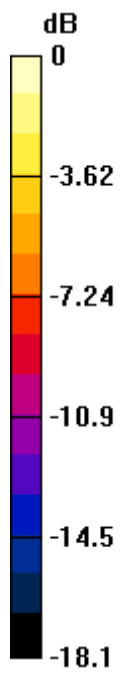

0 dB = 0.594mW/g

#11 CDMA2000 BC0_RTAP153.6_Bottom Face_0cm_Ch384

DUT: 170707

Communication System: CDMA ; Frequency: 836.52 MHz; Duty Cycle: 1:1

Medium: MSL_850_110723 Medium parameters used: $f = 837$ MHz; $\sigma = 0.981$ mho/m; $\epsilon_r = 52.6$; $\rho = 1000$ kg/m³

Ambient Temperature : 22.3 °C ; Liquid Temperature : 21.3 °C

DASY5 Configuration:

- Probe: ET3DV6 - SN1787; ConvF(6.35, 6.35, 6.35); Calibrated: 2011/5/20
- Sensor-Surface: 4mm (Mechanical Surface Detection)
- Electronics: DAE3 Sn495; Calibrated: 2011/4/28
- Phantom: ELI 4.0; Type: QDOVA001BA; Serial: 1029
- Measurement SW: DASY5, V5.0 Build 125; SEMCAD X Version 13.4 Build 125

Ch384/Area Scan (10x131x1): Measurement grid: dx=20mm, dy=20mm

Maximum value of SAR (interpolated) = 0.153 mW/g

Ch384/Zoom Scan (5x5x7)/Cube 0: Measurement grid: dx=8mm, dy=8mm, dz=5mm

Reference Value = 10.6 V/m; Power Drift = -0.142 dB

Peak SAR (extrapolated) = 0.202 W/kg

SAR(1 g) = 0.151 mW/g; SAR(10 g) = 0.101 mW/g

Maximum value of SAR (measured) = 0.156 mW/g

Ch384/Zoom Scan (5x5x7)/Cube 1: Measurement grid: dx=8mm, dy=8mm, dz=5mm

Reference Value = 10.6 V/m; Power Drift = -0.142 dB

Peak SAR (extrapolated) = 0.225 W/kg

SAR(1 g) = 0.105 mW/g; SAR(10 g) = 0.059 mW/g

Maximum value of SAR (measured) = 0.111 mW/g

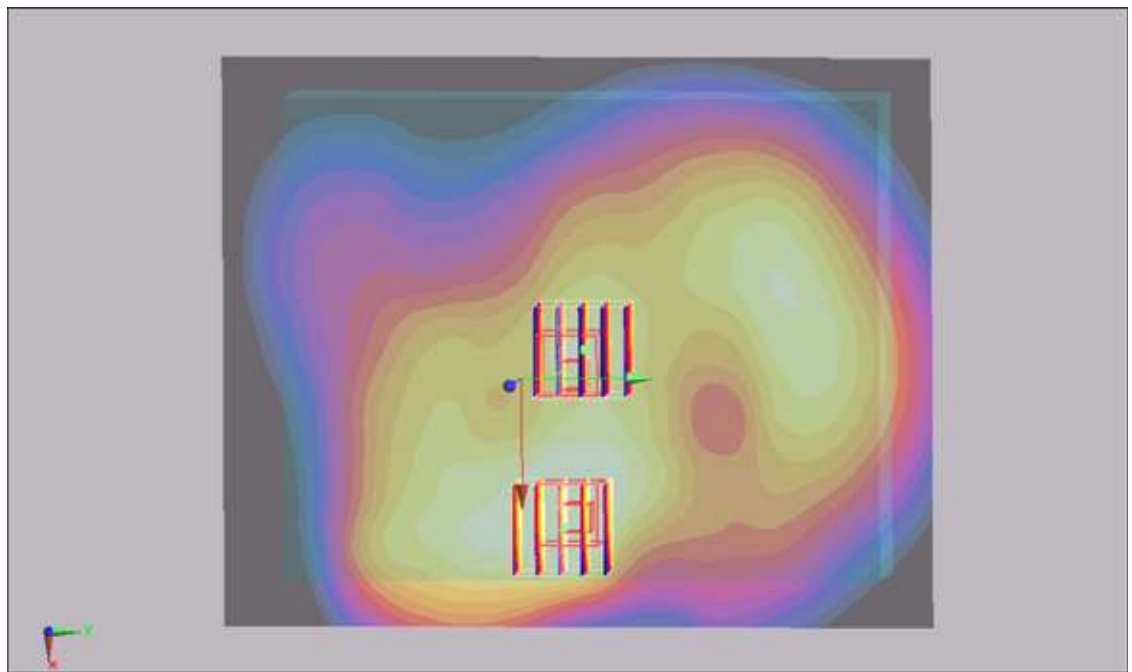
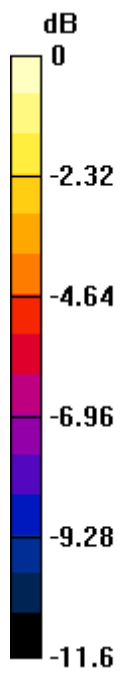

0 dB = 0.111mW/g

#12 CDMA2000 BC0_RTAP153.6_Secondary Landscape_0cm_Ch384_Earphone

DUT: 170707

Communication System: CDMA ; Frequency: 836.52 MHz; Duty Cycle: 1:1

Medium: MSL_850_110723 Medium parameters used: $f = 837$ MHz; $\sigma = 0.981$ mho/m; $\epsilon_r = 52.6$; $\rho = 1000$ kg/m³

Ambient Temperature : 22.3 °C ; Liquid Temperature : 21.3 °C

DASY5 Configuration:

- Probe: ET3DV6 - SN1787; ConvF(6.35, 6.35, 6.35); Calibrated: 2011/5/20
- Sensor-Surface: 4mm (Mechanical Surface Detection)
- Electronics: DAE3 Sn495; Calibrated: 2011/4/28
- Phantom: ELI 4.0; Type: QDOVA001BA; Serial: 1029
- Measurement SW: DASY5, V5.0 Build 125; SEMCAD X Version 13.4 Build 125

Ch384/Area Scan (41x131x1): Measurement grid: dx=20mm, dy=20mm

Maximum value of SAR (interpolated) = 0.334 mW/g

Ch384/Zoom Scan (5x5x7)/Cube 0: Measurement grid: dx=8mm, dy=8mm, dz=5mm

Reference Value = 19.3 V/m; Power Drift = -0.158 dB

Peak SAR (extrapolated) = 0.547 W/kg

SAR(1 g) = 0.303 mW/g; SAR(10 g) = 0.184 mW/g

Maximum value of SAR (measured) = 0.330 mW/g

Ch384/Zoom Scan (5x5x7)/Cube 1: Measurement grid: dx=8mm, dy=8mm, dz=5mm

Reference Value = 19.3 V/m; Power Drift = -0.158 dB

Peak SAR (extrapolated) = 0.334 W/kg

SAR(1 g) = 0.204 mW/g; SAR(10 g) = 0.142 mW/g

Maximum value of SAR (measured) = 0.228 mW/g

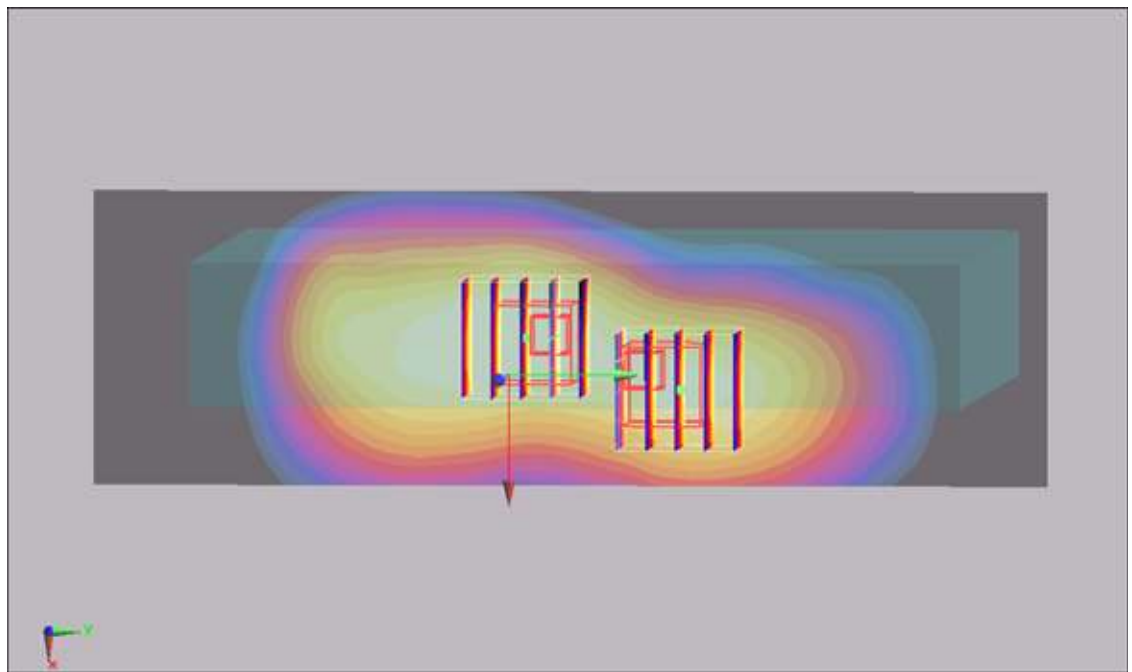
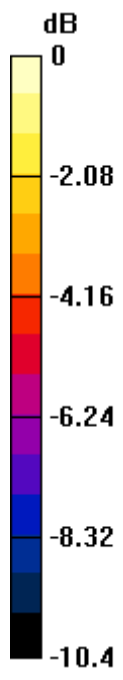

0 dB = 0.228mW/g

#12 CDMA2000 BC0_RTAP153.6_Secondary Landscape_0cm_Ch384_Earphone_2D

DUT: 170707

Communication System: CDMA ; Frequency: 836.52 MHz; Duty Cycle: 1:1

Medium: MSL_850_110723 Medium parameters used: $f = 837$ MHz; $\sigma = 0.981$ mho/m; $\epsilon_r = 52.6$; $\rho = 1000$ kg/m³

Ambient Temperature : 22.3 °C ; Liquid Temperature : 21.3 °C

DASY5 Configuration:

- Probe: ET3DV6 - SN1787; ConvF(6.35, 6.35, 6.35); Calibrated: 2011/5/20
- Sensor-Surface: 4mm (Mechanical Surface Detection)
- Electronics: DAE3 Sn495; Calibrated: 2011/4/28
- Phantom: ELI 4.0; Type: QDOVA001BA; Serial: 1029
- Measurement SW: DASY5, V5.0 Build 125; SEMCAD X Version 13.4 Build 125

Ch384/Area Scan (41x131x1): Measurement grid: dx=20mm, dy=20mm

Maximum value of SAR (interpolated) = 0.334 mW/g

Ch384/Zoom Scan (5x5x7)/Cube 0: Measurement grid: dx=8mm, dy=8mm, dz=5mm

Reference Value = 19.3 V/m; Power Drift = -0.158 dB

Peak SAR (extrapolated) = 0.547 W/kg

SAR(1 g) = 0.303 mW/g; SAR(10 g) = 0.184 mW/g

Maximum value of SAR (measured) = 0.330 mW/g

Ch384/Zoom Scan (5x5x7)/Cube 1: Measurement grid: dx=8mm, dy=8mm, dz=5mm

Reference Value = 19.3 V/m; Power Drift = -0.158 dB

Peak SAR (extrapolated) = 0.334 W/kg

SAR(1 g) = 0.204 mW/g; SAR(10 g) = 0.142 mW/g

Maximum value of SAR (measured) = 0.228 mW/g

1g/10g Averaged SAR

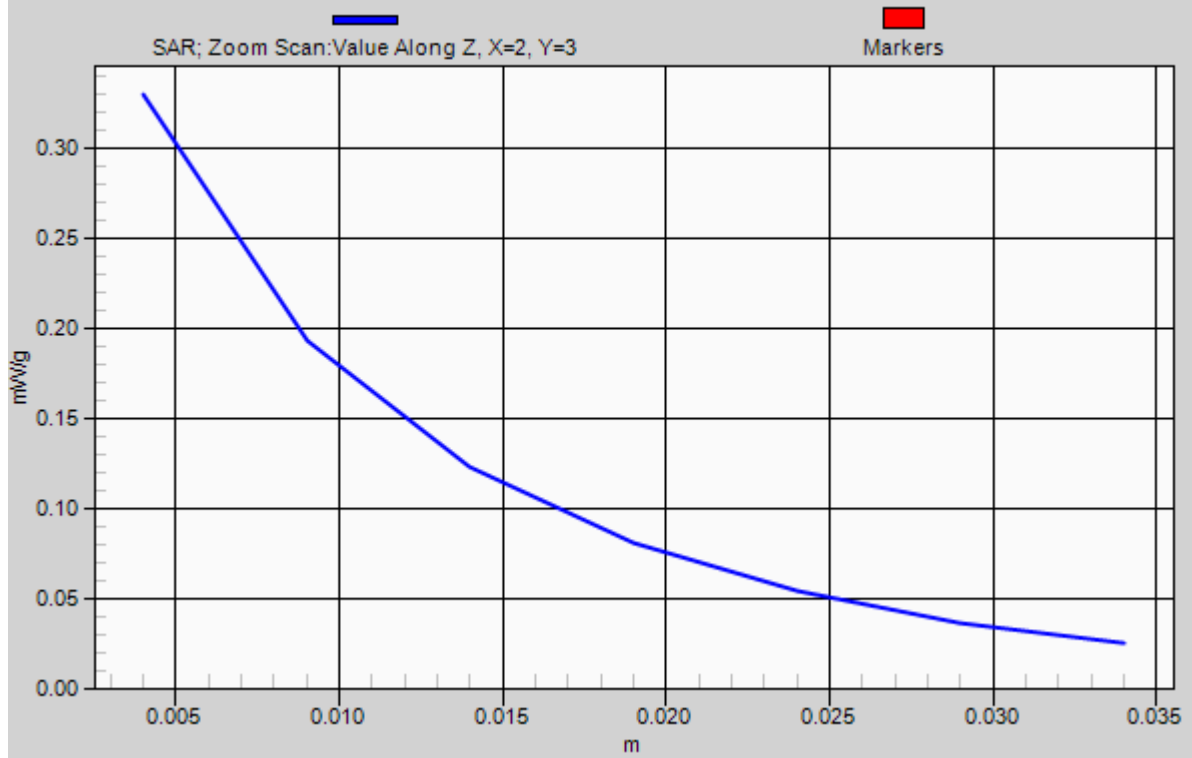

#05 CDMA2000 BC1_RTAP153.6_Bottom Face_0cm_Ch25

DUT: 170707

Communication System: CDMA ; Frequency: 1851.25 MHz;Duty Cycle: 1:1

Medium: MSL_1900_110723 Medium parameters used : $f = 1851.25$ MHz; $\sigma = 1.47$ mho/m; $\epsilon_r = 54.9$; $\rho = 1000$ kg/m³

Ambient Temperature : 22.5 °C ; Liquid Temperature : 21.5 °C

DASY5 Configuration:

- Probe: EX3DV4 - SN3792; ConvF(7.17, 7.17, 7.17); Calibrated: 2011/6/20
- Sensor-Surface: 4mm (Mechanical Surface Detection)
- Electronics: DAE4 Sn778; Calibrated: 2010/10/22
- Phantom: ELI 4.0; Type: QDOVA001BA; Serial: 1029
- Measurement SW: DASY5, V5.0 Build 125; SEMCAD X Version 13.4 Build 125

Ch25/Area Scan (101x131x1): Measurement grid: dx=20mm, dy=20mm

Maximum value of SAR (interpolated) = 0.769 mW/g

Ch25/Zoom Scan (5x5x7)/Cube 0: Measurement grid: dx=8mm, dy=8mm, dz=5mm

Reference Value = 5.09 V/m; Power Drift = -0.100 dB

Peak SAR (extrapolated) = 1.26 W/kg

SAR(1 g) = 0.750 mW/g; SAR(10 g) = 0.414 mW/g

Maximum value of SAR (measured) = 0.814 mW/g

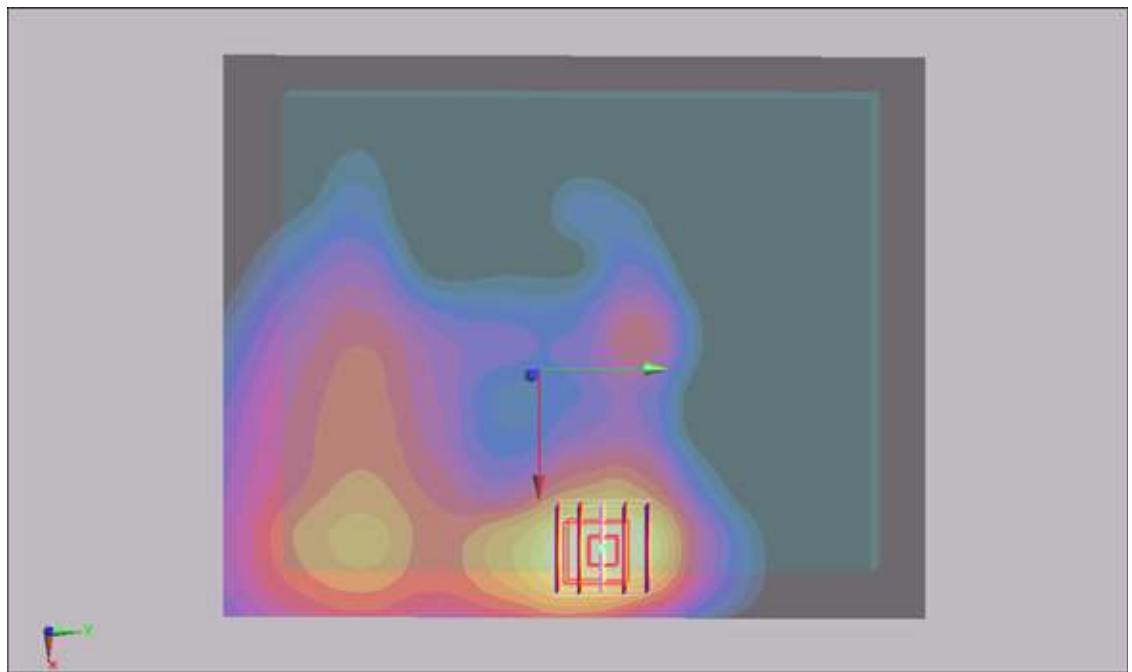
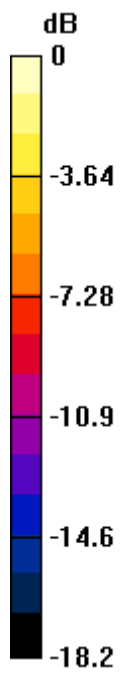

0 dB = 0.814mW/g

#05 CDMA2000 BC1_RTAP153.6_Bottom Face_0cm_Ch25_2D

DUT: 170707

Communication System: CDMA ; Frequency: 1851.25 MHz;Duty Cycle: 1:1

Medium: MSL_1900_110723 Medium parameters used : $f = 1851.25$ MHz; $\sigma = 1.47$ mho/m; $\epsilon_r = 54.9$; $\rho = 1000$ kg/m³

Ambient Temperature : 22.5 °C ; Liquid Temperature : 21.5 °C

DASY5 Configuration:

- Probe: EX3DV4 - SN3792; ConvF(7.17, 7.17, 7.17); Calibrated: 2011/6/20
- Sensor-Surface: 4mm (Mechanical Surface Detection)
- Electronics: DAE4 Sn778; Calibrated: 2010/10/22
- Phantom: ELI 4.0; Type: QDOVA001BA; Serial: 1029
- Measurement SW: DASY5, V5.0 Build 125; SEMCAD X Version 13.4 Build 125

Ch25/Area Scan (101x131x1): Measurement grid: dx=20mm, dy=20mm
 Maximum value of SAR (interpolated) = 0.769 mW/g

Ch25/Zoom Scan (5x5x7)/Cube 0: Measurement grid: dx=8mm, dy=8mm, dz=5mm
 Reference Value = 5.09 V/m; Power Drift = -0.100 dB
 Peak SAR (extrapolated) = 1.26 W/kg
SAR(1 g) = 0.750 mW/g; SAR(10 g) = 0.414 mW/g
 Maximum value of SAR (measured) = 0.814 mW/g

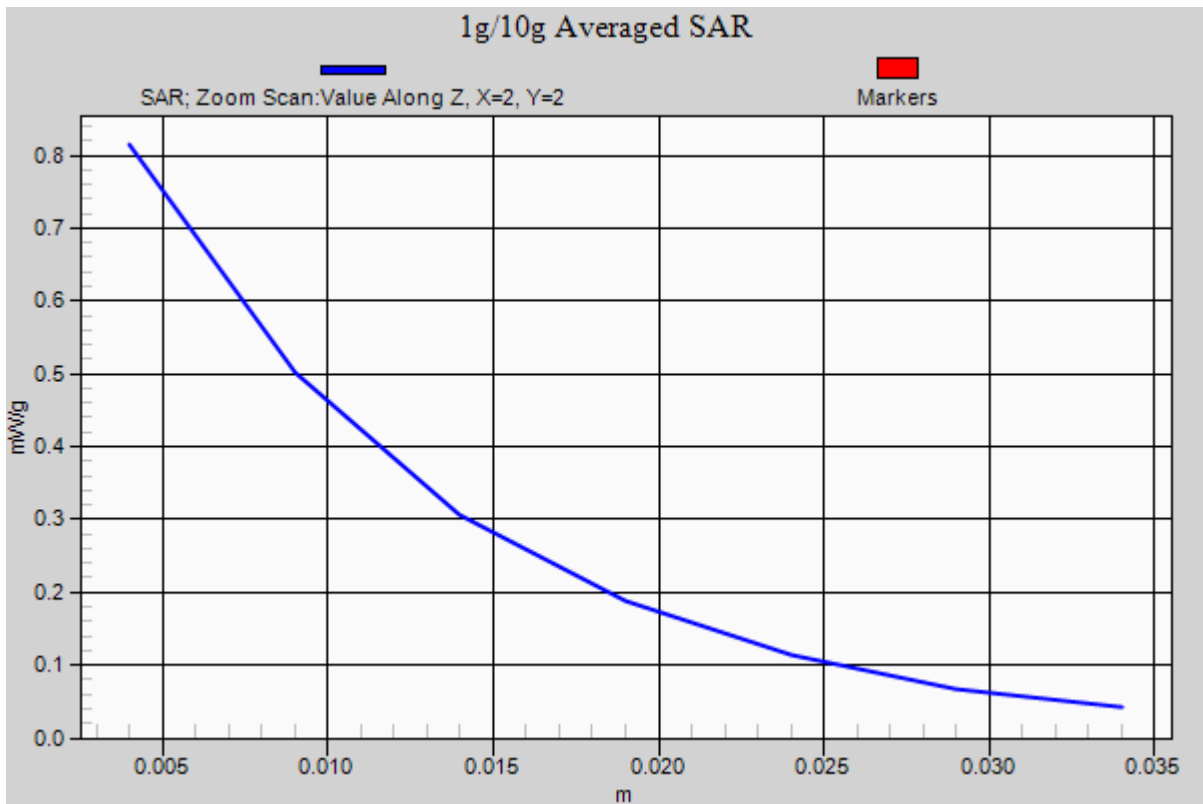

#06 CDMA2000 BC1_RTAP153.6_Secondary Landscape_0cm_Ch25_Earphone

DUT: 170707

Communication System: CDMA ; Frequency: 1851.25 MHz; Duty Cycle: 1:1

Medium: MSL_1900_110723 Medium parameters used : $f = 1851.25$ MHz; $\sigma = 1.47$ mho/m; $\epsilon_r = 54.9$; $\rho = 1000$ kg/m³

Ambient Temperature : 22.5 °C ; Liquid Temperature : 21.5 °C

DASY5 Configuration:

- Probe: EX3DV4 - SN3792; ConvF(7.17, 7.17, 7.17); Calibrated: 2011/6/20
- Sensor-Surface: 4mm (Mechanical Surface Detection)
- Electronics: DAE4 Sn778; Calibrated: 2010/10/22
- Phantom: ELI 4.0; Type: QDOVA001BA; Serial: 1029
- Measurement SW: DASY5, V5.0 Build 125; SEMCAD X Version 13.4 Build 125

Ch25/Area Scan (41x131x1): Measurement grid: dx=20mm, dy=20mm

Maximum value of SAR (interpolated) = 0.727 mW/g

Ch25/Zoom Scan (5x5x7)/Cube 0: Measurement grid: dx=8mm, dy=8mm, dz=5mm

Reference Value = 17.9 V/m; Power Drift = 0.029 dB

Peak SAR (extrapolated) = 1.02 W/kg

SAR(1 g) = 0.595 mW/g; SAR(10 g) = 0.343 mW/g

Maximum value of SAR (measured) = 0.681 mW/g

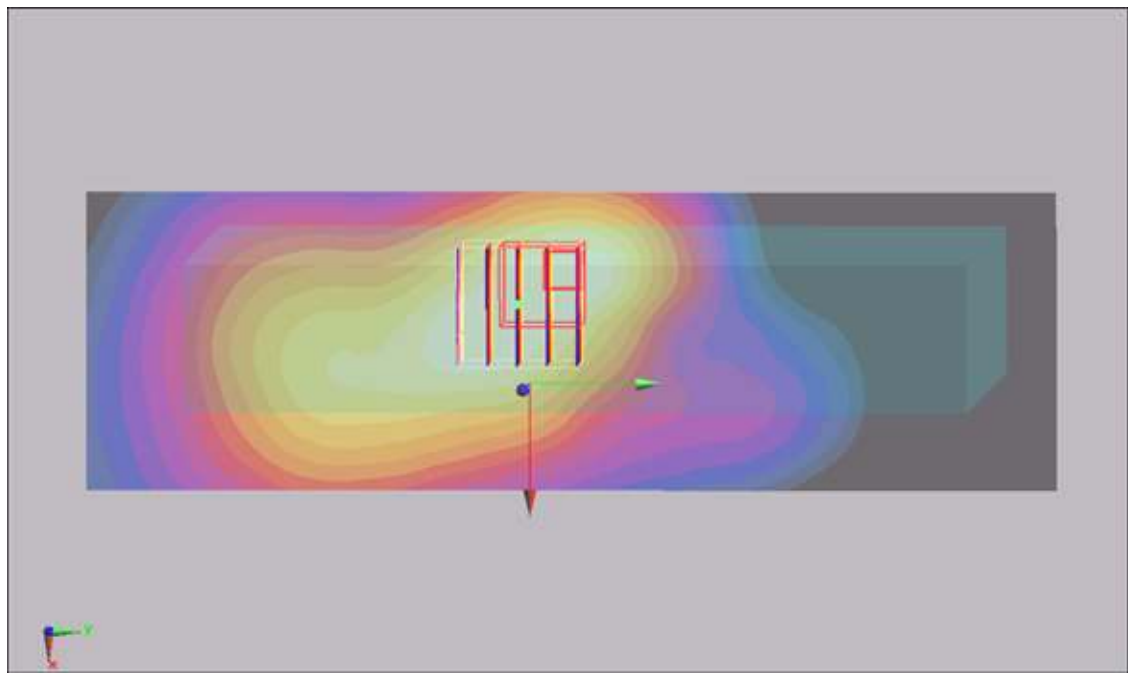

0 dB = 0.681mW/g

#17 802.11b_Bottom Face_0cm_Ch6

DUT: 170707

Communication System: 802.11b; Frequency: 2437 MHz; Duty Cycle: 1:1

Medium: MSL_2450_110827 Medium parameters used: $f = 2437$ MHz; $\sigma = 1.938$ mho/m; $\epsilon_r =$

53.878 ; $\rho = 1000$ kg/m³

Ambient Temperature : 22.3 °C ; Liquid Temperature : 21.3 °C

DASY5 Configuration:

- Probe: EX3DV4 - SN3578; ConvF(6.18, 6.18, 6.18); Calibrated: 2011/6/21
- Sensor-Surface: 4mm (Mechanical Surface Detection)
- Electronics: DAE3 Sn577; Calibrated: 2011/1/13
- Phantom: ELI v5.0; Type: QDOVA002AA; Serial: TP1127
- Measurement SW: DASY52, Version 52.6 (2); SEMCAD X Version 14.4.5 (3634)

Ch6/Area Scan (10x131x1): Measurement grid: dx=20mm, dy=20mm

Maximum value of SAR (interpolated) = 0.034 mW/g

Ch6/Zoom Scan (5x5x7)/Cube 0: Measurement grid: dx=8mm, dy=8mm, dz=5mm

Reference Value = 1.340 V/m; Power Drift = 0.098 dB

Peak SAR (extrapolated) = 0.032 W/kg

SAR(1 g) = 0.018 mW/g; SAR(10 g) = 0.00953 mW/g

Maximum value of SAR (measured) = 0.021 mW/g

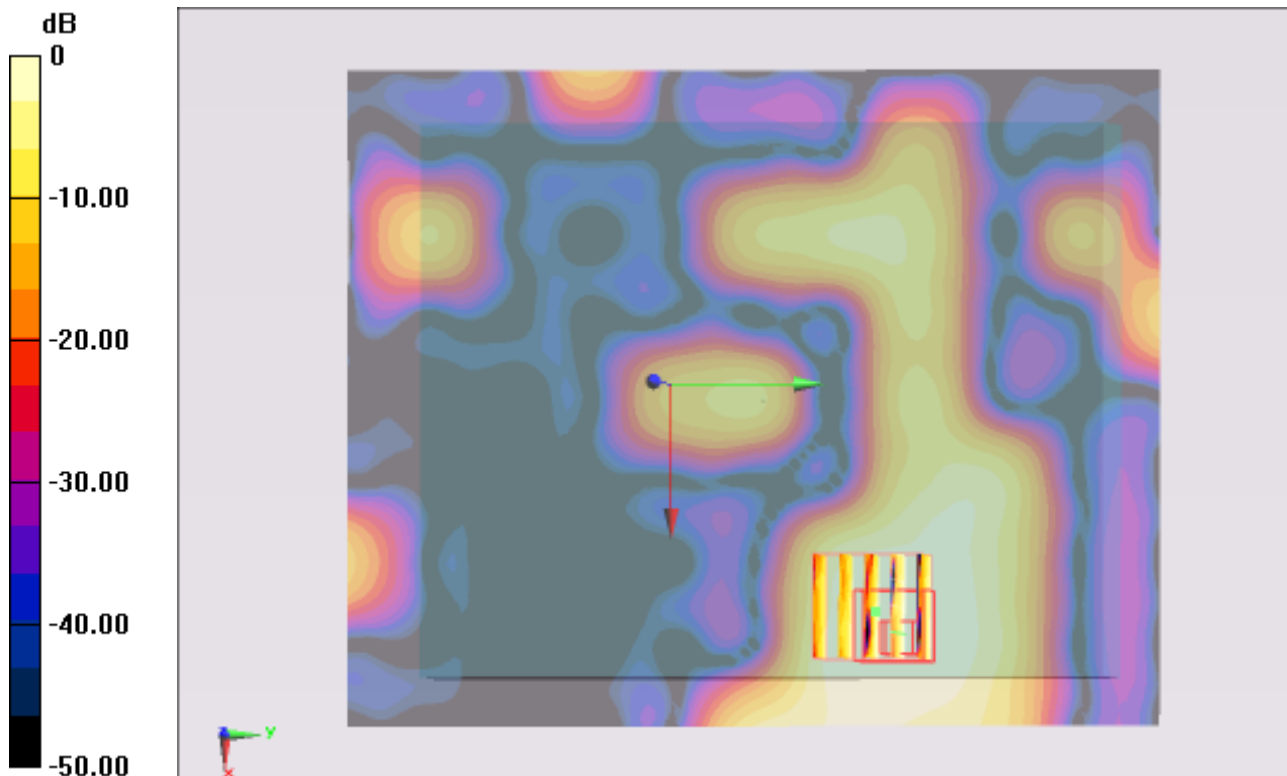

0 dB = 0.020mW/g

#18 802.11b_Secondary Landscape_0cm_Ch6_Earphone

DUT: 170707

Communication System: 802.11b; Frequency: 2437 MHz; Duty Cycle: 1:1

Medium: MSL_2450_110827 Medium parameters used: $f = 2437$ MHz; $\sigma = 1.938$ mho/m; $\epsilon_r =$

53.878 ; $\rho = 1000$ kg/m³

Ambient Temperature : 22.3 °C ; Liquid Temperature : 21.3°C

DASY5 Configuration:

- Probe: EX3DV4 - SN3578; ConvF(6.18, 6.18, 6.18); Calibrated: 2011/6/21
- Sensor-Surface: 4mm (Mechanical Surface Detection)
- Electronics: DAE3 Sn577; Calibrated: 2011/1/13
- Phantom: ELI v5.0; Type: QDOVA002AA; Serial: TP1127
- Measurement SW: DASY52, Version 52.6 (2); SEMCAD X Version 14.4.5 (3634)

Ch6/Area Scan (41x131x1): Measurement grid: dx=20mm, dy=20mm

Maximum value of SAR (interpolated) = 0.056 mW/g

Ch6/Zoom Scan (5x5x7)/Cube 0: Measurement grid: dx=8mm, dy=8mm, dz=5mm

Reference Value = 2.594 V/m; Power Drift = -0.031 dB

Peak SAR (extrapolated) = 0.090 W/kg

SAR(1 g) = 0.047 mW/g; SAR(10 g) = 0.023 mW/g

Maximum value of SAR (measured) = 0.048 mW/g

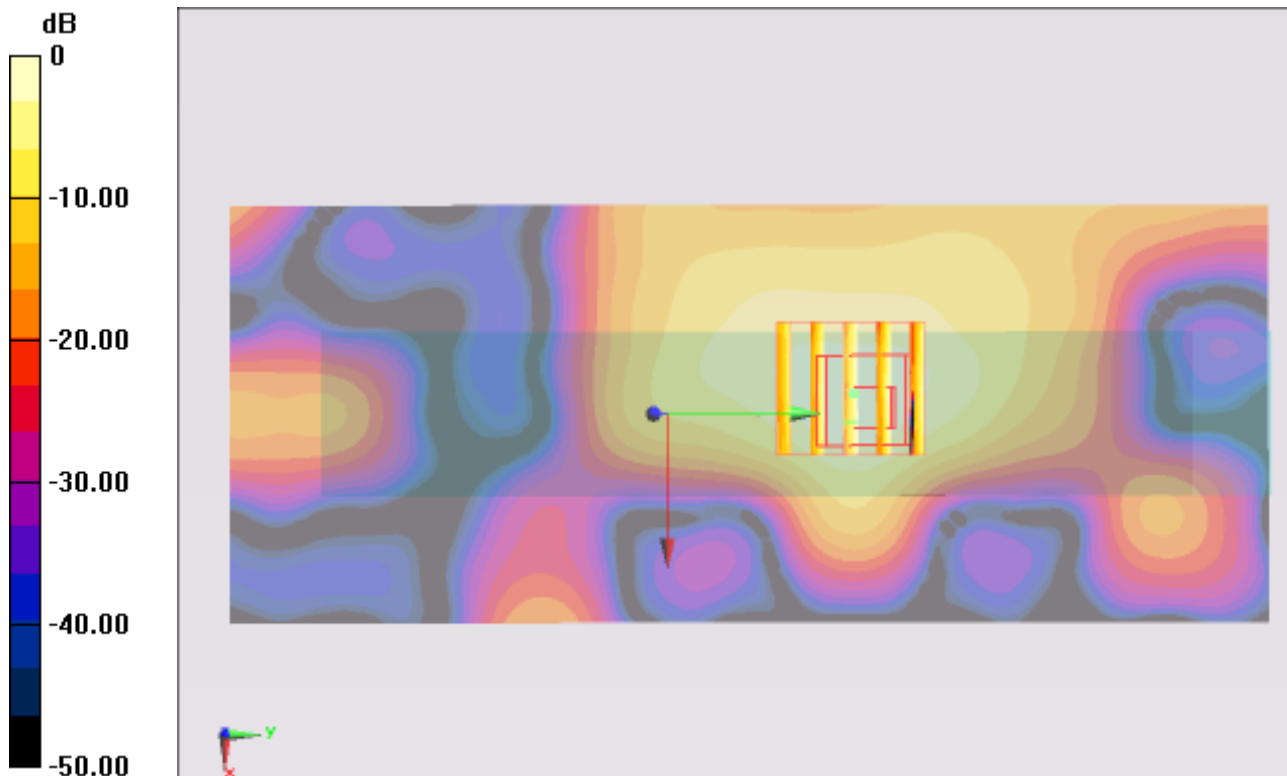

0 dB = 0.050mW/g

#18 802.11b_Secondary Landscape_0cm_Ch6_Earphone_2D

DUT: 170707

Communication System: 802.11b; Frequency: 2437 MHz; Duty Cycle: 1:1
Medium: MSL_2450_110827 Medium parameters used: $f = 2437$ MHz; $\sigma = 1.938$ mho/m; $\epsilon_r = 53.878$; $\rho = 1000$ kg/m³
Ambient Temperature : 22.3 °C ; Liquid Temperature : 21.3 °C

DASY5 Configuration:

- Probe: EX3DV4 - SN3578; ConvF(6.18, 6.18, 6.18); Calibrated: 2011/6/21
- Sensor-Surface: 4mm (Mechanical Surface Detection)
- Electronics: DAE3 Sn577; Calibrated: 2011/1/13
- Phantom: ELI v5.0; Type: QDOVA002AA; Serial: TP1127
- Measurement SW: DASY52, Version 52.6 (2); SEMCAD X Version 14.4.5 (3634)

Ch6/Area Scan (41x101x1): Measurement grid: dx=25mm, dy=25mm
Maximum value of SAR (interpolated) = 0.056 mW/g

Ch6/Zoom Scan (5x5x7)/Cube 0: Measurement grid: dx=8mm, dy=8mm, dz=5mm
Reference Value = 2.594 V/m; Power Drift = -0.031 dB
Peak SAR (extrapolated) = 0.090 W/kg
SAR(1 g) = 0.047 mW/g; SAR(10 g) = 0.023 mW/g
Maximum value of SAR (measured) = 0.048 mW/g

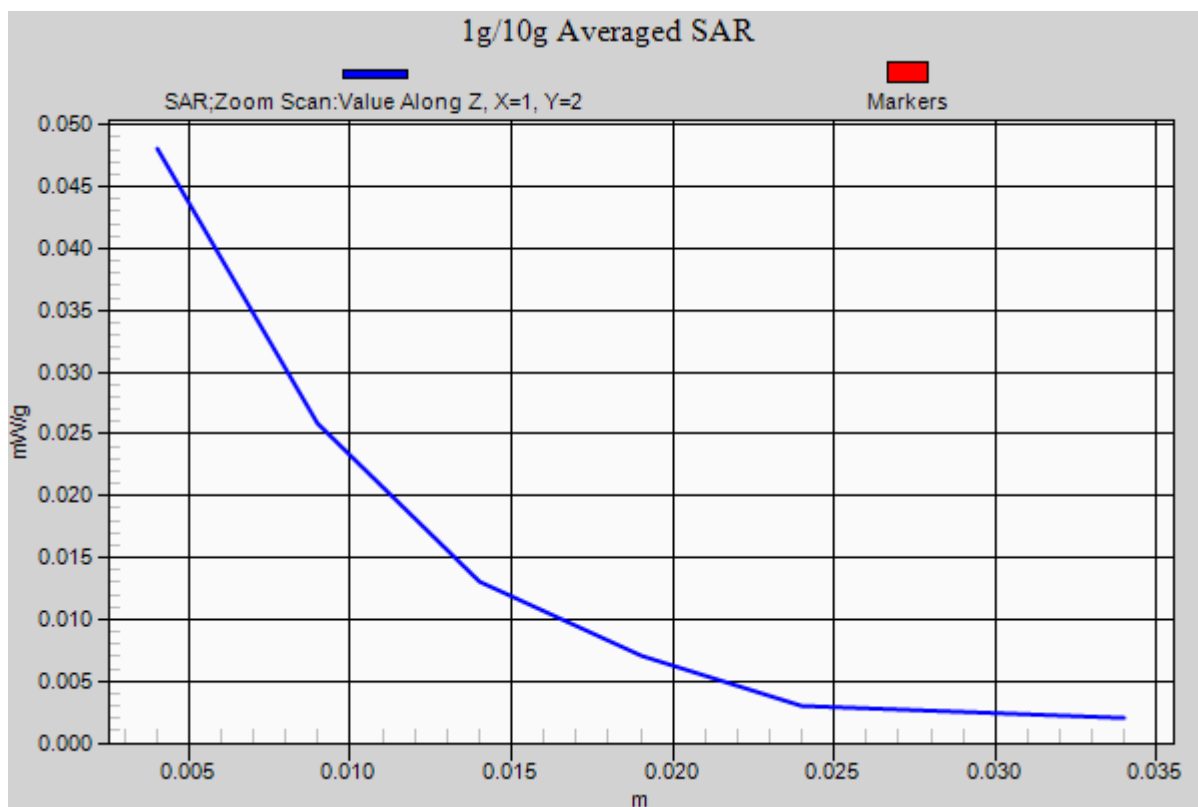

#16 802.11a_Secondary Landscape_0cm_Ch120_Earphone

DUT: 170707

Communication System: 802.11a; Frequency: 5600 MHz; Duty Cycle: 1:1

Medium: MSL_5G_110825 Medium parameters used: $f = 5600$ MHz; $\sigma = 5.86$ mho/m; $\epsilon_r = 47.892$; $\rho = 1000$ kg/m³

Ambient Temperature : 22.6 °C ; Liquid Temperature : 21.6 °C

DASY5 Configuration:

- Probe: EX3DV4 - SN3578; ConvF(3.11, 3.11, 3.11); Calibrated: 2011/6/21
- Sensor-Surface: 4mm (Mechanical Surface Detection), Sensor-Surface: 2mm (Mechanical Surface Detection)
- Electronics: DAE3 Sn577; Calibrated: 2011/1/13
- Phantom: ELI v5.0; Type: QDOVA002AA; Serial: TP1127
- Measurement SW: DASY52, Version 52.6 (2); SEMCAD X Version 14.4.5 (3634)

Ch120/Area Scan (91x121x1): Measurement grid: dx=20mm, dy=20mm

Maximum value of SAR (interpolated) = 0.082 mW/g

Ch120/Zoom Scan (8x8x10)/Cube 0: Measurement grid: dx=4mm, dy=4mm, dz=2.5mm

Reference Value = 1.017 V/m; Power Drift = 0.091 dB

Peak SAR (extrapolated) = 0.040 W/kg

SAR(1 g) = 0.030 mW/g; SAR(10 g) = 0.023 mW/g

Maximum value of SAR (measured) = 0.040 mW/g

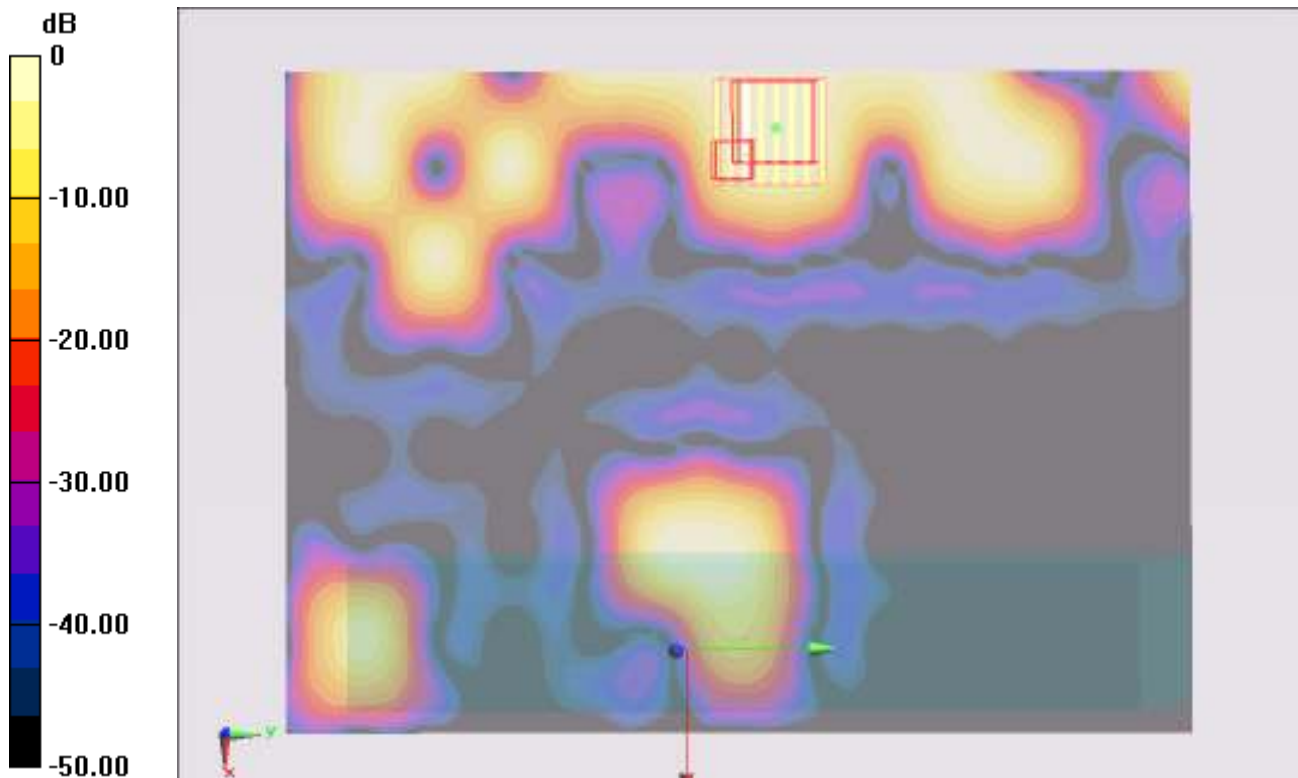

0 dB = 0.040mW/g

#16 802.11a_Secundary Landscape_0cm_Ch120_Earphone_2D

DUT: 170707

Communication System: 802.11a; Frequency: 5600 MHz; Duty Cycle: 1:1

Medium: MSL_5G_110825 Medium parameters used: $f = 5600$ MHz; $\sigma = 5.86$ mho/m; $\epsilon_r = 47.892$;

$\rho = 1000$ kg/m³

Ambient Temperature : 22.6 °C ; Liquid Temperature : 21.6 °C

DASY5 Configuration:

- Probe: EX3DV4 - SN3578; ConvF(3.11, 3.11, 3.11); Calibrated: 2011/6/21

- Sensor-Surface: 4mm (Mechanical Surface Detection), Sensor-Surface: 2mm (Mechanical Surface Detection)

- Electronics: DAE3 Sn577; Calibrated: 2011/1/13

- Phantom: ELI v5.0; Type: QDOVA002AA; Serial: TP1127

- Measurement SW: DASY52, Version 52.6 (2); SEMCAD X Version 14.4.5 (3634)

Ch120/Area Scan (91x121x1): Measurement grid: dx=20mm, dy=20mm

Maximum value of SAR (interpolated) = 0.082 mW/g

Ch120/Zoom Scan (8x8x10)/Cube 0: Measurement grid: dx=4mm, dy=4mm, dz=2.5mm

Reference Value = 1.017 V/m; Power Drift = 0.091 dB

Peak SAR (extrapolated) = 0.040 W/kg

SAR(1 g) = 0.030 mW/g; SAR(10 g) = 0.023 mW/g

Maximum value of SAR (measured) = 0.040 mW/g

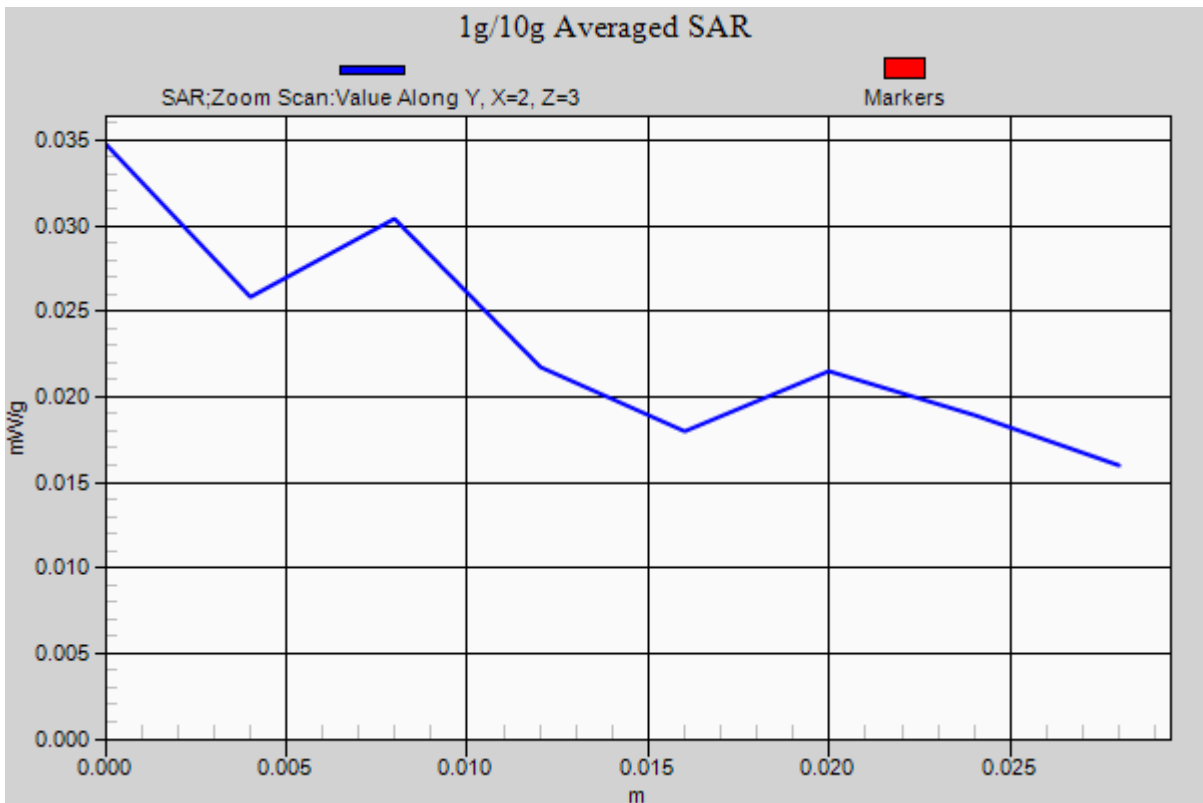



Appendix C. DAS Y Calibration Certificate

The DAS Y calibration certificates are shown as follows.



Calibration Laboratory of Schmid & Partner Engineering AG Zeughausstrasse 43, 8004 Zurich, Switzerland



S Schweizerischer Kalibrierdienst
S Service suisse d'etalonnage
C Servizio svizzero di taratura
S Swiss Calibration Service

Accredited by the Swiss Accreditation Service (SAS)
The Swiss Accreditation Service is one of the signatories to the EA Multilateral Agreement for the recognition of calibration certificates

Accreditation No.: SCS 108

Client Sporton (Auden)

Certificate No: D835V2-499_Mar10

CALIBRATION CERTIFICATE

Object D835V2 - SN: 499
Calibration procedure(s) QA CAL-05.v7
Calibration procedure for dipole validation kits
Calibration date: March 22, 2010

This calibration certificate documents the traceability to national standards, which realize the physical units of measurements (SI). The measurements and the uncertainties with confidence probability are given on the following pages and are part of the certificate.

All calibrations have been conducted in the closed laboratory facility: environment temperature (22 ± 3)°C and humidity < 70%.

Calibration Equipment used (M&TE critical for calibration)

Table with 4 columns: Primary Standards, ID #, Cal Date (Certificate No.), Scheduled Calibration. Includes items like Power meter EPM-442A, Power sensor HP 8481A, Reference 20 dB Attenuator, etc.

Calibrated by: Dimce Iliev, Laboratory Technician
Approved by: Katja Pokovic, Technical Manager

Issued: March 22, 2010

This calibration certificate shall not be reproduced except in full without written approval of the laboratory.

Calibration Laboratory of
Schmid & Partner
Engineering AG
Zeughausstrasse 43, 8004 Zurich, Switzerland



S Schweizerischer Kalibrierdienst
C Service suisse d'étalonnage
S Servizio svizzero di taratura
S Swiss Calibration Service

Accredited by the Swiss Accreditation Service (SAS)
The Swiss Accreditation Service is one of the signatories to the EA
Multilateral Agreement for the recognition of calibration certificates

Accreditation No.: SCS 108

Glossary:

| | |
|-------|---------------------------------|
| TSL | tissue simulating liquid |
| ConvF | sensitivity in TSL / NORM x,y,z |
| N/A | not applicable or not measured |

Calibration is Performed According to the Following Standards:

- IEEE Std 1528-2003, "IEEE Recommended Practice for Determining the Peak Spatial-Averaged Specific Absorption Rate (SAR) in the Human Head from Wireless Communications Devices: Measurement Techniques", December 2003
- IEC 62209-1, "Procedure to measure the Specific Absorption Rate (SAR) for hand-held devices used in close proximity to the ear (frequency range of 300 MHz to 3 GHz)", February 2005
- Federal Communications Commission Office of Engineering & Technology (FCC OET), "Evaluating Compliance with FCC Guidelines for Human Exposure to Radiofrequency Electromagnetic Fields; Additional Information for Evaluating Compliance of Mobile and Portable Devices with FCC Limits for Human Exposure to Radiofrequency Emissions", Supplement C (Edition 01-01) to Bulletin 65

Additional Documentation:

- DASY4/5 System Handbook

Methods Applied and Interpretation of Parameters:

- Measurement Conditions:** Further details are available from the Validation Report at the end of the certificate. All figures stated in the certificate are valid at the frequency indicated.
- Antenna Parameters with TSL:** The dipole is mounted with the spacer to position its feed point exactly below the center marking of the flat phantom section, with the arms oriented parallel to the body axis.
- Feed Point Impedance and Return Loss:** These parameters are measured with the dipole positioned under the liquid filled phantom. The impedance stated is transformed from the measurement at the SMA connector to the feed point. The Return Loss ensures low reflected power. No uncertainty required.
- Electrical Delay:** One-way delay between the SMA connector and the antenna feed point. No uncertainty required.
- SAR measured:** SAR measured at the stated antenna input power.
- SAR normalized:** SAR as measured, normalized to an input power of 1 W at the antenna connector.
- SAR for nominal TSL parameters:** The measured TSL parameters are used to calculate the nominal SAR result.



Measurement Conditions

DASY system configuration, as far as not given on page 1:

| | | |
|------------------------------|---------------------------|-------------|
| DASY Version | DASY5 | V5.2 |
| Extrapolation | Advanced Extrapolation | |
| Phantom | Modular Flat Phantom V4.9 | |
| Distance Dipole Center - TSL | 15 mm | with Spacer |
| Zoom Scan Resolution | dx, dy, dz = 5 mm | |
| Frequency | 835 MHz \pm 1 MHz | |

Head TSL parameters

The following parameters and calculations were applied:

| | Temperature | Permittivity | Conductivity |
|----------------------------------|---------------------|----------------|----------------------|
| Nominal Head TSL parameters | 22.0 °C | 41.5 | 0.90 mho/m |
| Measured Head TSL parameters | (22.0 \pm 0.2) °C | 42.9 \pm 6 % | 0.91 mho/m \pm 6 % |
| Head TSL temperature during test | (22.0 \pm 0.2) °C | ---- | ---- |

SAR result with Head TSL

| SAR averaged over 1 cm ³ (1 g) of Head TSL | Condition | |
|---|--------------------|--|
| SAR measured | 250 mW input power | 2.43 mW / g |
| SAR normalized | normalized to 1W | 9.72 mW / g |
| SAR for nominal Head TSL parameters | normalized to 1W | 9.71 mW / g \pm 17.0 % (k=2) |

| SAR averaged over 10 cm ³ (10 g) of Head TSL | condition | |
|---|--------------------|--|
| SAR measured | 250 mW input power | 1.58 mW / g |
| SAR normalized | normalized to 1W | 6.32 mW / g |
| SAR for nominal Head TSL parameters | normalized to 1W | 6.31 mW / g \pm 16.5 % (k=2) |



Body TSL parameters

The following parameters and calculations were applied.

| | Temperature | Permittivity | Conductivity |
|----------------------------------|-----------------|--------------|------------------|
| Nominal Body TSL parameters | 22.0 °C | 55.2 | 0.97 mho/m |
| Measured Body TSL parameters | (22.0 ± 0.2) °C | 55.3 ± 6 % | 1.01 mho/m ± 6 % |
| Body TSL temperature during test | (22.0 ± 0.2) °C | ---- | ---- |

SAR result with Body TSL

| SAR averaged over 1 cm ³ (1 g) of Body TSL | Condition | |
|---|--------------------|-----------------------------------|
| SAR measured | 250 mW input power | 2.53 mW / g |
| SAR normalized | normalized to 1W | 10.1 mW / g |
| SAR for nominal Body TSL parameters | normalized to 1W | 9.62 mW / g ± 17.0 % (k=2) |

| SAR averaged over 10 cm ³ (10 g) of Body TSL | condition | |
|---|--------------------|-----------------------------------|
| SAR measured | 250 mW input power | 1.66 mW / g |
| SAR normalized | normalized to 1W | 6.64 mW / g |
| SAR for nominal Body TSL parameters | normalized to 1W | 6.49 mW / g ± 16.5 % (k=2) |



Appendix

Antenna Parameters with Head TSL

| | |
|--------------------------------------|--------------------------------|
| Impedance, transformed to feed point | 52.2 Ω - 3.2 j Ω |
| Return Loss | - 28.4 dB |

Antenna Parameters with Body TSL

| | |
|--------------------------------------|--------------------------------|
| Impedance, transformed to feed point | 50.1 Ω - 5.9 j Ω |
| Return Loss | - 24.7 dB |

General Antenna Parameters and Design

| | |
|----------------------------------|----------|
| Electrical Delay (one direction) | 1,391 ns |
|----------------------------------|----------|

After long term use with 100W radiated power, only a slight warming of the dipole near the feedpoint can be measured.

The dipole is made of standard semirigid coaxial cable. The center conductor of the feeding line is directly connected to the second arm of the dipole. The antenna is therefore short-circuited for DC-signals.

No excessive force must be applied to the dipole arms, because they might bend or the soldered connections near the feedpoint may be damaged.

Additional EUT Data

| | |
|-----------------|---------------|
| Manufactured by | SPEAG |
| Manufactured on | July 10, 2003 |

DASY5 Validation Report for Head TSL

Date/Time: 22.03.2010 10:17:58

Test Laboratory: SPEAG, Zurich, Switzerland

DUT: Dipole 835 MHz; Type: D835V2; Serial: D835V2 - SN:499

Communication System: CW; Frequency: 835 MHz; Duty Cycle: 1:1

Medium: HSL900

Medium parameters used: $f = 835 \text{ MHz}$; $\sigma = 0.91 \text{ mho/m}$; $\epsilon_r = 42.9$; $\rho = 1000 \text{ kg/m}^3$

Phantom section: Flat Section

Measurement Standard: DASYS (IEEE/IEC/ANSI C63.19-2007)

DASY5 Configuration:

- Probe: ES3DV3 - SN3205; ConvF(6.04, 6.04, 6.04); Calibrated: 26.06.2009
- Sensor-Surface: 3mm (Mechanical Surface Detection)
- Electronics: DAE4 Sn601; Calibrated: 02.03.2010
- Phantom: Flat Phantom 4.9L; Type: QD000P49AA; Serial: 1001
- Measurement SW: DASYS, V5.2 Build 157; SEMCAD X Version 14.0 Build 57

Pin=250 mW /d=15mm, dist=3.0mm (ES-Probe)/Zoom Scan (7x7x7) /Cube 0: Measurement grid: dx=5mm, dy=5mm, dz=5mm

Reference Value = 57.5 V/m; Power Drift = 0.00691 dB

Peak SAR (extrapolated) = 3.63 W/kg

SAR(1 g) = 2.43 mW/g; SAR(10 g) = 1.58 mW/g

Maximum value of SAR (measured) = 2.84 mW/g

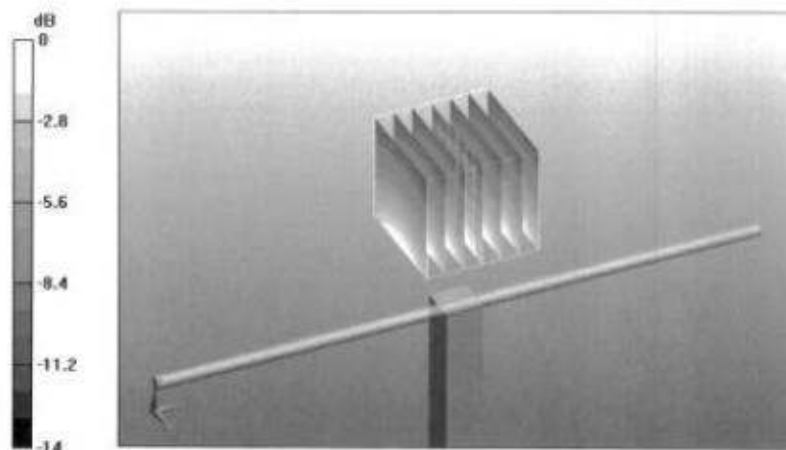

0 dB = 2.84mW/g



Impedance Measurement Plot for Head TSL

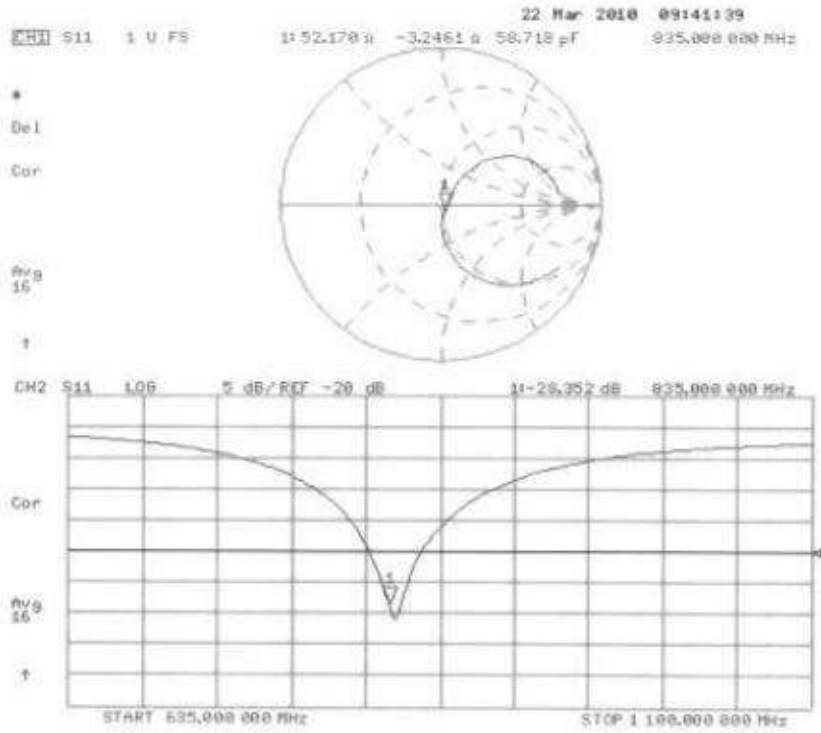

DASY5 Validation Report for Body

Date/Time: 22.03.2010 14:07:53

Test Laboratory: SPEAG, Zurich, Switzerland

DUT: Dipole 835 MHz; Type: D835V2; Serial: D835V2 - SN:499

Communication System: CW; Frequency: 835 MHz; Duty Cycle: 1:1

Medium: MSL900

Medium parameters used: $f = 835 \text{ MHz}$; $\sigma = 1.01 \text{ mho/m}$; $\epsilon_r = 55.3$; $\rho = 1000 \text{ kg/m}^3$

Phantom section: Flat Section

Measurement Standard: DASY5 (IEEE/IEC/ANSI C63.19-2007)

DASY5 Configuration:

- Probe: ES3DV3 - SN3205; ConvF(5.97, 5.97, 5.97); Calibrated: 26.06.2009
- Sensor-Surface: 3mm (Mechanical Surface Detection)
- Electronics: DAE4 Sn601; Calibrated: 02.03.2010
- Phantom: Flat Phantom 4.9L; Type: QD000P49AA; Serial: 1001
- Measurement SW: DASY5, V5.2 Build 157; SEMCAD X Version 14.0 Build 57

Pin250 mW /d=15mm, dist=3.0mm (ES-Probe)/Zoom Scan (7x7x7) /Cube 0: Measurement

grid: dx=5mm, dy=5mm, dz=5mm

Reference Value = 55.6 V/m; Power Drift = 0.011 dB

Peak SAR (extrapolated) = 3.73 W/kg

SAR(1 g) = 2.53 mW/g; SAR(10 g) = 1.66 mW/g

Maximum value of SAR (measured) = 2.94 mW/g

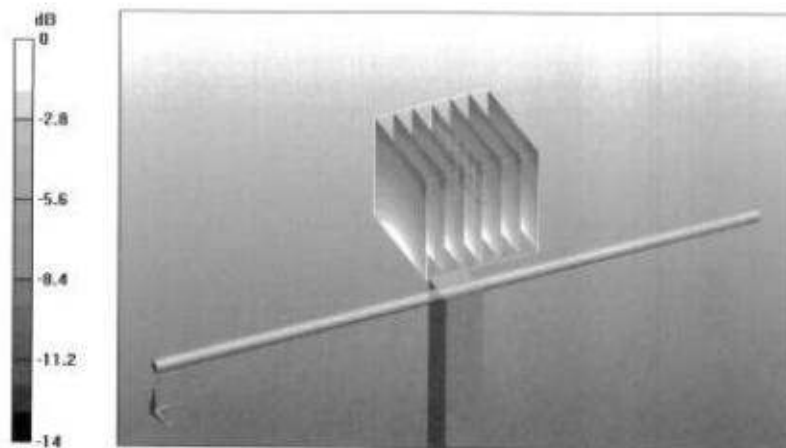

0 dB = 2.94mW/g