



# Partial FCC RF Test Report

APPLICANT : DAP Technologies  
EQUIPMENT : Rugged Mobile Tablet Computer  
BRAND NAME : DAP  
MODEL NAME : 9000WBWZV1  
MARKETING NAME : M9010  
FCC ID : T5M9000WBWZV1  
STANDARD : FCC Part 15 Subpart C §15.247  
CLASSIFICATION : Digital Spread Spectrum (DSS)

The product was integrated the Bluetooth Module (Brand Name: Bluegiga / Model Name: WT21-A, FCC ID: QOQWT21A) during the test.

This is a partial report which is included the Radiated Emissions test only. The product was received on Jul. 07, 2011 and completely tested on Sep. 19, 2011. We, SPORTON INTERNATIONAL INC., would like to declare that the tested sample has been evaluated in accordance with the procedures given in ANSI C63.4-2003 and shown the compliance with the applicable technical standards.

The test results in this report apply exclusively to the tested model / sample. Without written approval of SPORTON INTERNATIONAL INC., the test report shall not be reproduced except in full.

Reviewed by:

Jones Tsai / Manager



## SPORTON INTERNATIONAL INC.

No. 52, Hwa Ya 1<sup>st</sup> Rd., Hwa Ya Technology Park, Kwei-Shan Hsiang, Tao Yuan Hsien, Taiwan, R.O.C.

SPORTON INTERNATIONAL INC.

TEL : 886-3-327-3456

FAX : 886-3-328-4978

FCC ID : T5M9000WBWZV1

Page Number : 1 of 41

Report Issued Date : Oct. 24, 2011

Report Version : Rev. 01



# TABLE OF CONTENTS

**REVISION HISTORY..... 3**

**SUMMARY OF TEST RESULT ..... 4**

**1 GENERAL DESCRIPTION..... 5**

    1.1 Applicant ..... 5

    1.2 Manufacturer..... 5

    1.3 Feature of Equipment Under Test ..... 5

    1.4 Testing Site ..... 6

    1.5 Applied Standards ..... 6

    1.6 Ancillary Equipment List ..... 7

**2 TEST CONFIGURATION OF EQUIPMENT UNDER TEST..... 8**

    2.1 RF Output Power ..... 8

    2.2 Test Mode..... 9

    2.3 Connection Diagram of Test System..... 10

    2.4 RF Utility ..... 11

**3 TEST RESULT ..... 12**

    3.1 Peak Output Power Measurement ..... 12

    3.2 Band Edges Measurement ..... 15

    3.3 AC Conducted Emission Measurement..... 25

    3.4 Radiated Emission Measurement..... 29

    3.5 Antenna Requirements ..... 38

**4 LIST OF MEASURING EQUIPMENT..... 39**

**5 UNCERTAINTY OF EVALUATION..... 40**

**APPENDIX A. PHOTOGRAPHS OF EUT**

**APPENDIX B. SETUP PHOTOGRAPHS**



### REVISION HISTORY

REPORT NO.	VERSION	DESCRIPTION	ISSUED DATE
FR170707A	Rev. 01	Initial issue of report	Oct. 24, 2011



### SUMMARY OF TEST RESULT

Report Section	FCC Rule	IC Rule	Description	Limit	Result	Remark
3.1	15.247(b)(1)	A8.1(b)	Peak Output Power	≤ 125 mW	Pass	-
3.2	15.247(d)	A8.5	Frequency Band Edges	≤ 20dBc	Pass	-
3.3	15.207	Gen 7.2.4	AC Conducted Emission	15.207(a)	Pass	Under limit 12.9 dB at 0.52 MHz
3.4	15.247(d)	A8.5	Transmitter Radiated Emission	15.209(a) & 15.247(d)	Pass	Under limit 3.12 dB at 34.86 MHz
3.5	15.203 & 15.247(b)	A8.4	Antenna Requirement	N/A	Pass	-



# 1 General Description

## 1.1 Applicant

DAP Technologies

7450 South Priest DR Tempe, AZ, US

## 1.2 Manufacturer

Venture Corporation Limited

Blk5006, Ang Mo Kio Avenue 5, #03-07 TECHplace II, Singapore 569870

## 1.3 Feature of Equipment Under Test

Product Feature & Specification	
Equipment	Rugged Mobile Tablet Computer
Brand Name	DAP
Model Name	9000WBWZV1
Marketing Name	M9010
FCC ID	T5M9000WBWZV1
Tx/Rx Frequency Range	2400 MHz ~ 2483.5 MHz
Number of Channels	79
Carrier Frequency of Each Channel	2402+n*1 MHz; n=0~78
Channel Spacing	1 MHz
Maximum Output Power to Antenna	Bluetooth (1Mbps) : 7.69 dBm (0.0059 W) Bluetooth EDR (2Mbps) : 6.41 dBm (0.0044 W) Bluetooth EDR (3Mbps) : 6.99 dBm (0.0050 W)
Antenna Type	Chip Antenna
HW Version	Merlion P3
SW Version	MER_00.00.10
Type of Modulation	Bluetooth (1Mbps) : GFSK Bluetooth EDR (2Mbps) : $\pi/4$ -DQPSK Bluetooth EDR (3Mbps) : 8-DPSK
EUT Stage	Production Unit

### Remark:

1. For other wireless features of this EUT, test report will be issued separately.
2. This test report recorded only product characteristics and test results of Digital Spread Spectrum (DSS).
3. The above EUT's information was declared by manufacturer. Please refer to the specifications or user's manual for more detailed description.

### 1.4 Testing Site

<b>Test Site</b>	SPORTON INTERNATIONAL INC.		
<b>Test Site Location</b>	No. 52, Hwa Ya 1 <sup>st</sup> Rd., Hwa Ya Technology Park, Kwei-Shan Hsiang, Tao Yuan Hsien, Taiwan, R.O.C. TEL: +886-3-3273456 / FAX: +886-3-3284978		
<b>Test Site No.</b>	<b>Sporton Site No.</b>		<b>FCC/IC Registration No.</b>
	CO05-HY	03CH07-HY	722060/4086B-1

### 1.5 Applied Standards

According to the specifications of the manufacturer, the EUT must comply with the requirements of the following standards:

- ♦ FCC Part 15 Subpart C §15.247
- ♦ FCC Public Notice DA 00-705
- ♦ ANSI C63.4-2003
- ♦ IC RSS-210 Issue 8

**Remark:**

1. All test items were verified and recorded according to the standards and without any deviation during the test.
2. This EUT has also been tested and complied with the requirements of FCC Part 15, Subpart B (DoC), recorded in a separate test report.



### 1.6 Ancillary Equipment List

Item	Equipment	Trade Name	Model Name	FCC ID	Data Cable	Power Cord
1.	iPod Earphone	Apple	N/A	FCC DoC	Unshielded, 1.0 m	N/A
2.	Bluetooth Earphone	Motorola	S705	IHDT6GH1	N/A	N/A
3.	WLAN AP	D-Link	DIR-628	KA2DIR628A2	N/A	Unshielded, 1.8 m
4.	(USB) Mouse	DELL	MOC5UO	FCC DoC	Shielded, 1.8 m	N/A
5.	(USB) Mouse	Logitech	M90	FCC DoC	Shielded, 1.8 m	N/A

## 2 Test Configuration of Equipment Under Test

### 2.1 RF Output Power

Preliminary tests were performed in different data rate and recorded the RF output power in the following table:

Channel	Frequency	Bluetooth RF Output Power		
		Data Rate / Modulation		
		GFSK	$\pi/4$ -DQPSK	8-DPSK
		1Mbps	2Mbps	3Mbps
Ch00	2402MHz	7.39 dBm	6.29 dBm	6.81 dBm
Ch39	2441MHz	7.69 dBm	6.41 dBm	6.99 dBm
Ch78	2480MHz	7.47 dBm	5.92 dBm	6.64 dBm

**Remark:**

1. The data rate was set in 1Mbps for all the test items due to the highest RF output power.
2. The EUT is programmed to transmit signals continuously for all testing.



## 2.2 Test Mode

The EUT has been associated with peripherals pursuant to ANSI C63.4-2003 and configuration operated in a manner tended to maximize its emission characteristics in a typical application. Frequency range investigated: conduction (150 kHz to 30 MHz), radiation (9 kHz to the 10th harmonic of the highest fundamental frequency or to 40 GHz, whichever is lower).

Pre-scanned tests, X, Y, Z in three orthogonal panels, were conducted to determine the final configuration from all possible combinations, laptop / tablet modes.

The following tables are showing the test modes as the worst cases (E2 plane) and recorded in this report.

Test Cases			
Test Item	Data Rate / Modulation		
	Bluetooth 1Mbps GFSK	Bluetooth EDR 2Mbps $\pi/4$ -DQPSK	Bluetooth EDR 3Mbps 8-DPSK
<b>Conducted TCs</b>	Mode 1: CH00_2402 MHz Mode 2: CH39_2441 MHz Mode 3: CH78_2480 MHz	Mode 4: CH00_2402 MHz Mode 5: CH39_2441 MHz Mode 6: CH78_2480 MHz	Mode 7: CH00_2402 MHz Mode 8: CH39_2441 MHz Mode 9: CH78_2480 MHz
<b>Radiated TCs</b>	Mode 1: CH00_2402 MHz Mode 2: CH39_2441 MHz Mode 3: CH78_2480 MHz	N/A	N/A
<b>AC Conducted Emission</b>	Mode 1 :WLAN Link + Bluetooth Link + Zigbee On + TC + Adapter		
<b>Remark:</b>			
<ol style="list-style-type: none"> <li>1. TC stands for Test Configuration, and consists of iPod earphone, RS232 Cable and Mouse.</li> <li>2. For radiated TCs, the data rate was set in 1Mbps due to the highest RF output power; only the data of these modes was reported.</li> </ol>			

## 2.3 Connection Diagram of Test System

<Bluetooth Tx Mode>

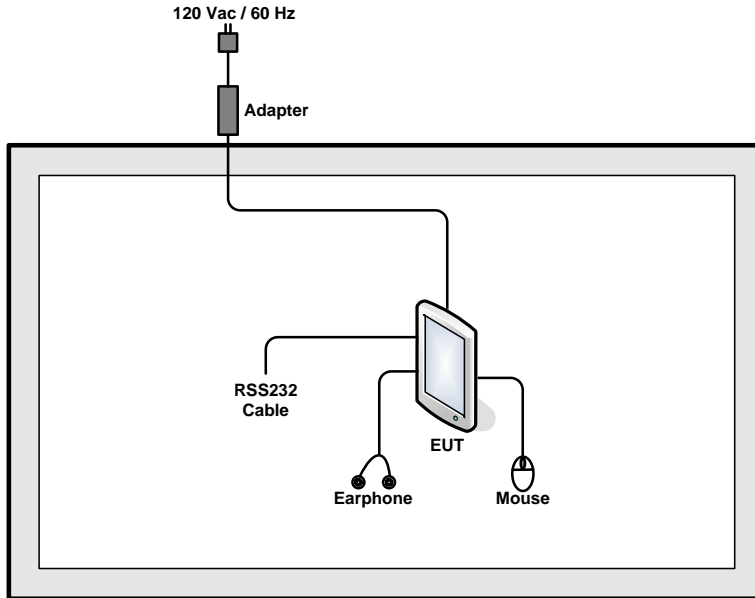

<AC Conducted Emission Mode>

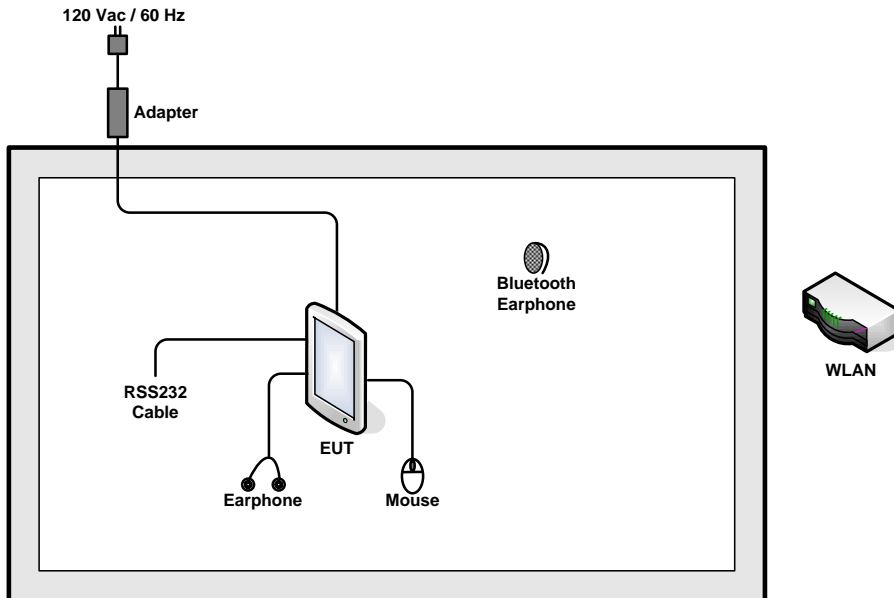



## **2.4 RF Utility**

For Bluetooth function, select "BlueSoleil" after the EUT was turned on, the RF utility "Blue Test3" was installed in EUT which was programmed in order to make the EUT transmitting and receiving signals automatically.

### 3 Test Result

#### 3.1 Peak Output Power Measurement

##### 3.1.1 Limit of Peak Output Power

Frequency hopping systems operating in the 2400-2483.5 MHz band may have hopping channel carrier frequencies that are separated by 25 kHz or two-thirds of the 20 dB bandwidth of the hopping channel, whichever is greater, provided the systems operate with an output power no greater than 125 mW (20.97dBm).

##### 3.1.2 Measuring Instruments

See list of measuring instruments of this test report.

##### 3.1.3 Test Procedures

1. The testing follows FCC Public Notice DA 00-705 Measurement Guidelines.
2. The RF output of EUT was connected to the spectrum analyzer by a low loss cable.

##### 3.1.4 Test Setup

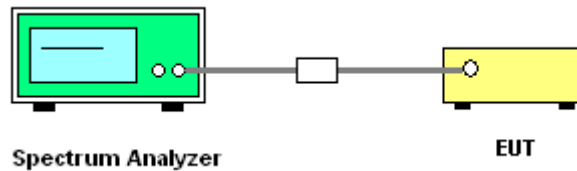

##### 3.1.5 Test Result of Peak Output Power

<b>Test Mode :</b>	Mode 1, 2, 3	<b>Temperature :</b>	24~26°C
<b>Test Engineer :</b>	Pinkston Tu	<b>Relative Humidity :</b>	55~58%

Channel	Frequency (MHz)	RF Power (dBm)		
		GFSK	Max. Limits (dBm)	Pass/Fail
		1 Mbps		
00	2402	7.39	30	Pass
39	2441	7.69	30	Pass
78	2480	7.47	30	Pass



Peak Output Power Plot on Channel 00

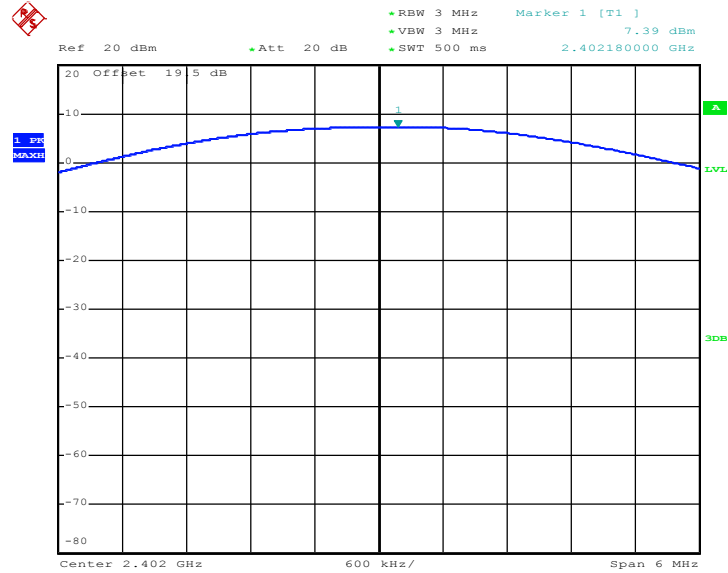

Date: 1.AUG.2011 16:51:27

Peak Output Power Plot on Channel 39

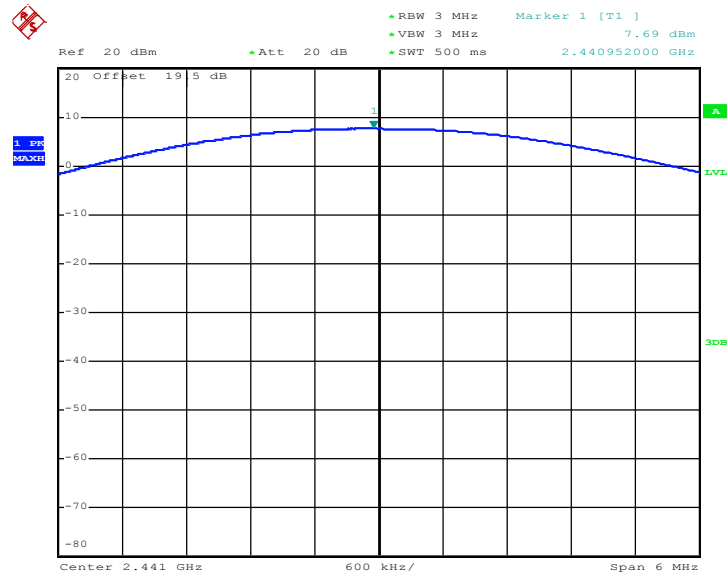

Date: 1.AUG.2011 16:49:44



Peak Output Power Plot on Channel 78

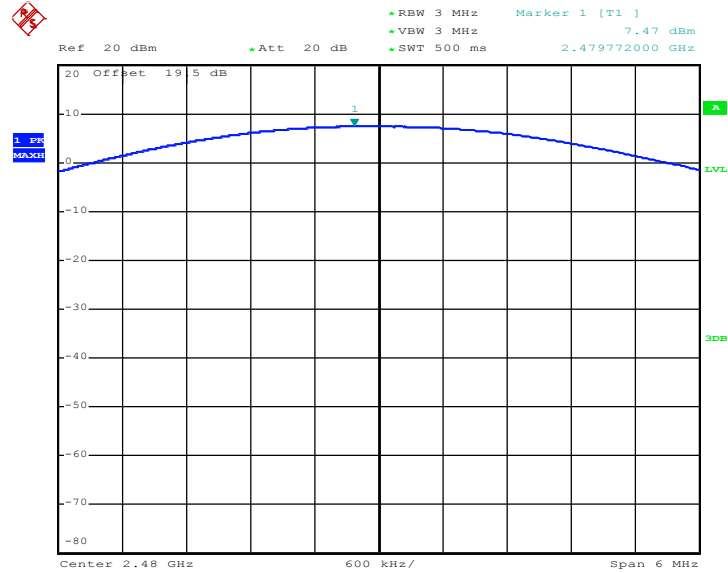

Date: 1.AUG.2011 16:53:03



## **3.2 Band Edges Measurement**

### **3.2.1 Limit of Band Edges**

In any 100 kHz bandwidth outside the intentional radiation frequency band, the radio frequency power shall be at least 20 dB below the highest level of the radiated power. In addition, radiated emissions which fall in the restricted bands must also comply with the radiated emission limits.

### **3.2.2 Measuring Instruments**

See list of measuring instruments of this test report.

### **3.2.3 Test Procedures**

1. The testing follows the guidelines in ANSI C63.4-2003 and FCC Public Notice DA 00-705 Measurement Guidelines.
2. RF antenna conducted test: Set RBW = 300kHz, Video bandwidth (VBW)  $\geq$  RBW. Band edge emissions must be at least 20 dB down from the highest emission level within the authorized band as measured with a 300k Hz RBW. Note: If the device complies with the use of power option 2 the attenuation under this paragraph shall be 30 dB instead of 20 dB.
3. Radiated emission test: Applies to band edge emissions that fall in the restricted bands listed in FCC Section 15.205. The maximum permitted average field strength is listed in FCC Section 15.209. A pre-amp is necessary for this measurement. For measurements above 1 GHz, set RBW = 1MHz, VBW = 1MHz, Sweep: Auto for Peak; set RBW = 1MHz, VBW = 10 Hz, Sweep: Auto for Average. If the emission is pulsed, modify the unit for continuous operation; use the settings shown above, then correct the reading by subtracting the peak-average correction factor, derived from the appropriate duty cycle calculation. See FCC Section 15.35(b) and (c).
4. In case the emission is fail due to the used RBW / VBW is too wide, marker-delta method of FCC Public Notice DA 00-705 will be followed.

### 3.2.4 Test Setup

#### <Radiated Band Edges>

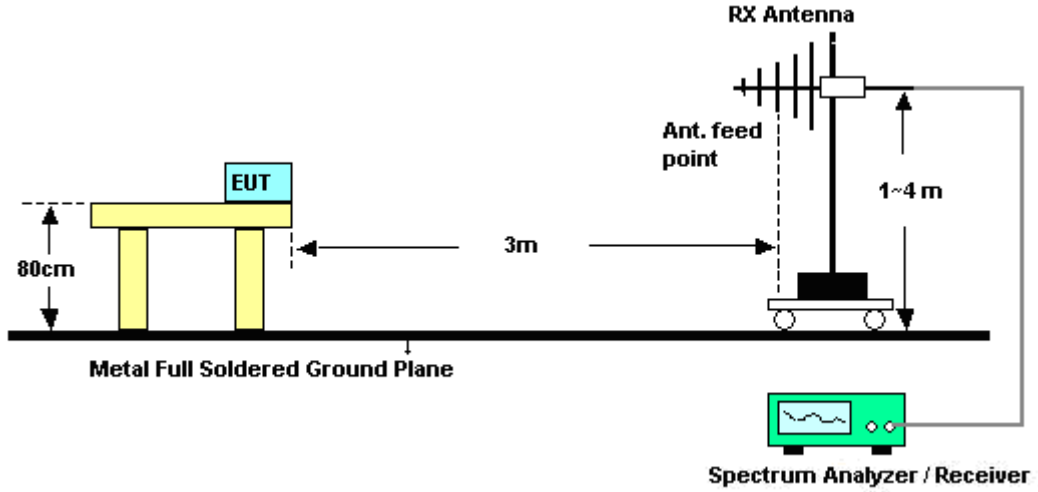

#### <Conducted Band Edges>

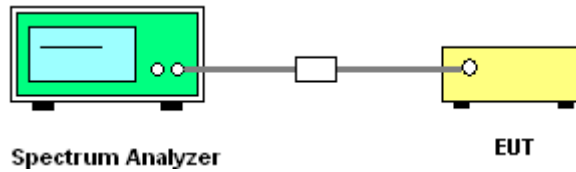





3.2.5 Test Result of Radiated Band Edges

Test Mode :	Mode 1	Temperature :	23~26°C
Test Channel :	00	Relative Humidity :	53~56%
		Test Engineer :	Wii Chang

ANTENNA POLARITY : HORIZONTAL										
Frequency ( MHz )	Level ( dBuV/m )	Over Limit ( dB )	Limit Line ( dBuV/m )	Read Level ( dBuV )	Antenna Factor ( dB )	Cable Loss ( dB )	Preamp Factor ( dB )	Ant Pos ( cm )	Table Pos ( deg )	Remark
2349.9	45.97	-28.03	74	41.87	31.98	5.95	33.83	100	285	Peak
2349.9	34.51	-19.49	54	30.41	31.98	5.95	33.83	100	285	Average

ANTENNA POLARITY : VERTICAL										
Frequency ( MHz )	Level ( dBuV/m )	Over Limit ( dB )	Limit Line ( dBuV/m )	Read Level ( dBuV )	Antenna Factor ( dB )	Cable Loss ( dB )	Preamp Factor ( dB )	Ant Pos ( cm )	Table Pos ( deg )	Remark
2381.82	45.54	-28.46	74	41.33	32.03	6.03	33.85	116	299	Peak
2381.82	33.04	-20.96	54	28.83	32.03	6.03	33.85	116	299	Average

Test Mode :	Mode 3	Temperature :	23~26°C
Test Channel :	78	Relative Humidity :	53~56%
		Test Engineer :	Wii Chang

ANTENNA POLARITY : HORIZONTAL										
Frequency ( MHz )	Level ( dBuV/m )	Over Limit ( dB )	Limit Line ( dBuV/m )	Read Level ( dBuV )	Antenna Factor ( dB )	Cable Loss ( dB )	Preamp Factor ( dB )	Ant Pos ( cm )	Table Pos ( deg )	Remark
2483.5	64.1	-9.9	74	59.64	32.18	6.18	33.9	100	250	Peak
2483.5	39.55	-14.45	54	35.09	32.18	6.18	33.9	100	250	Average

Summary results of marker-delta method:

Test mode	Maximum field strength of the fundamental emission (dBµV/m)	Delta Result (dB)	Average Result (dBµV/m)	Average Limit (dBµV/m)	Margin (dB)	Result
Single Carrier Mode	90.3	50.75	39.55	54	-14.45	Pass
Hopping Mode	90.3	52.35	37.95	54	-16.05	Pass

Note : Average result = Maximum field strength – Delta result



ANTENNA POLARITY : VERTICAL										
Frequency ( MHz )	Level ( dBuV/m )	Over Limit ( dB )	Limit Line ( dBuV/m )	Read Level ( dBuV )	Antenna Factor ( dB )	Cable Loss ( dB )	Preamp Factor ( dB )	Ant Pos ( cm )	Table Pos ( deg )	Remark
2483.5	62.75	-11.25	74	58.29	32.18	6.18	33.9	104	338	Peak
2483.5	34.17	-19.83	54	29.71	32.18	6.18	33.9	104	338	Average

Summary results of marker-delta method:

Test mode	Maximum field strength of the fundamental emission (dBµV/m)	Delta Result (dB)	Average Result (dBµV/m)	Average Limit (dBµV/m)	Margin (dB)	Result
Single Carrier Mode	85.01	50.84	34.17	54	-19.83	Pass
Hopping Mode	85.01	51.68	33.33	54	-20.67	Pass

Note : Average result = Maximum field strength – Delta result



Test Mode :	Mode 3	Temperature :	23~26°C
Test Channel :	78	Relative Humidity :	53~56%
Test Engineer :	Wii Chang	Polarization :	Horizontal

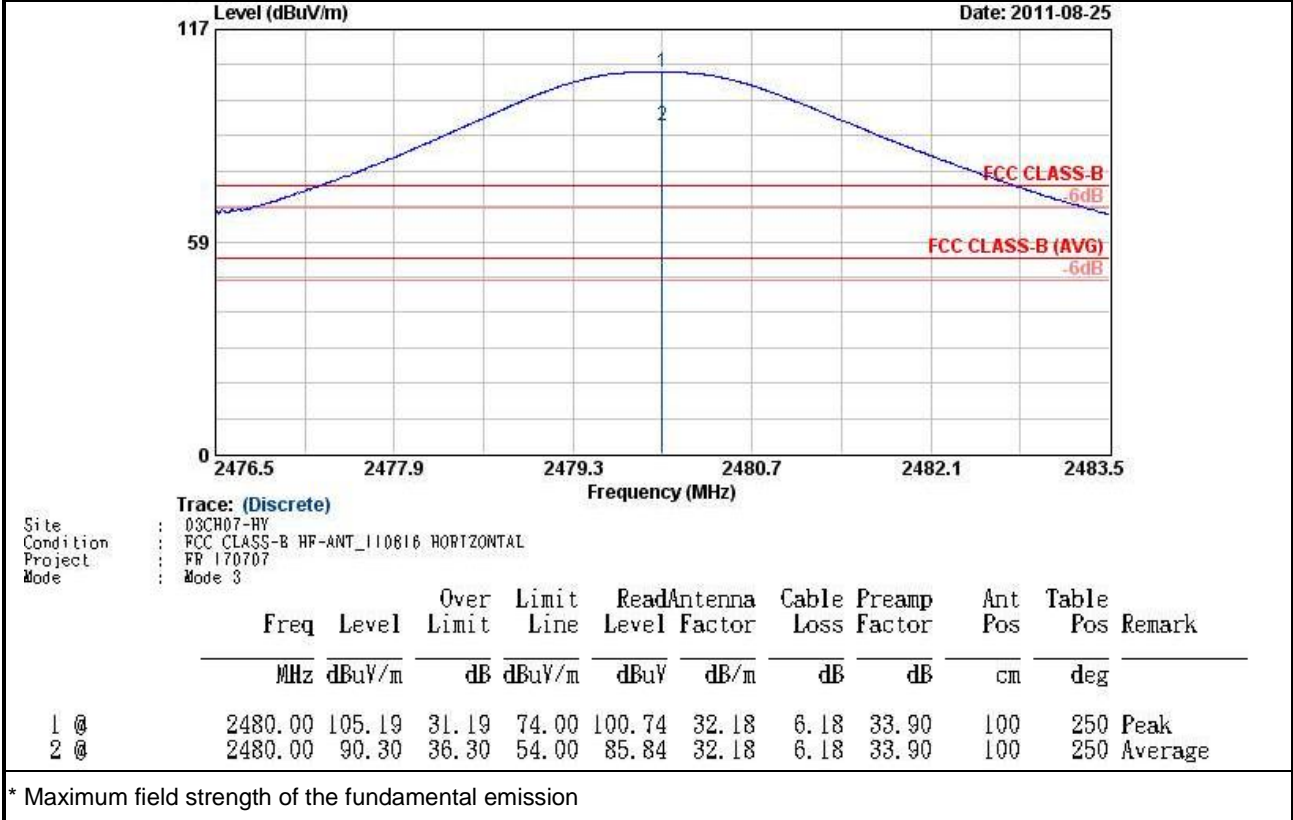



Test Mode :	Mode 3	Temperature :	23~26°C
Test Channel :	78	Relative Humidity :	53~56%
Test Engineer :	Wii Chang	Polarization :	Horizontal

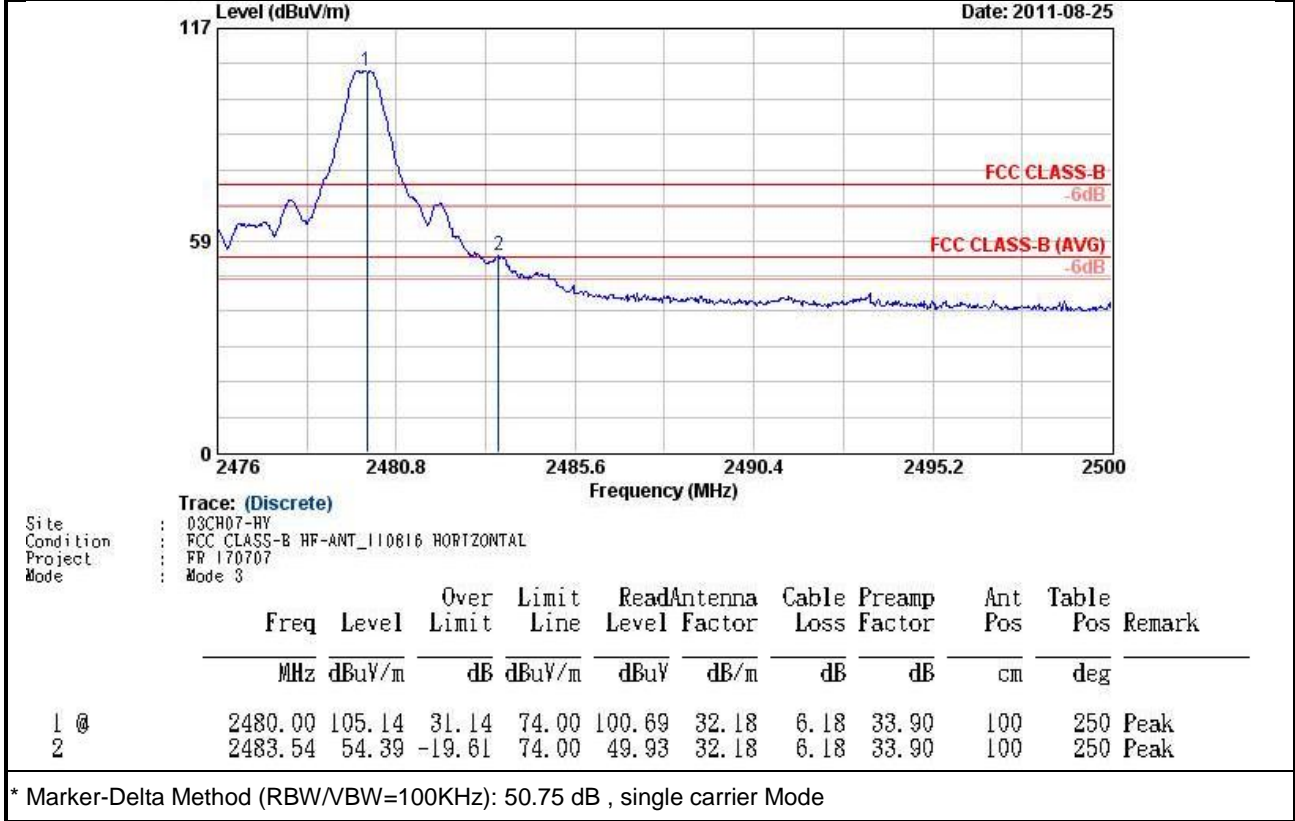



Test Mode :	Mode 3	Temperature :	23~26°C
Test Channel :	78	Relative Humidity :	53~56%
Test Engineer :	Wii Chang	Polarization :	Horizontal

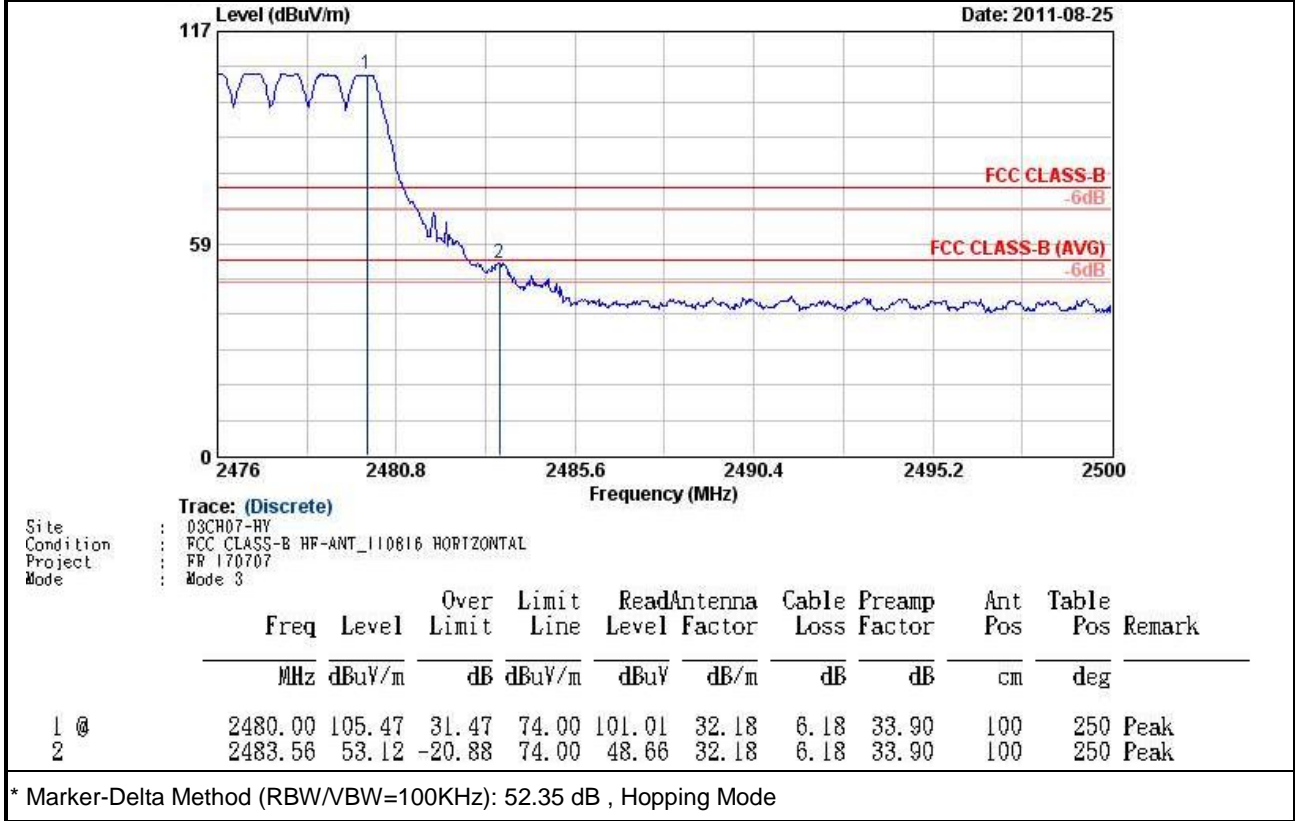



Test Mode :	Mode 3	Temperature :	23~26°C
Test Channel :	78	Relative Humidity :	53~56%
Test Engineer :	Wii Chang	Polarization :	Vertical

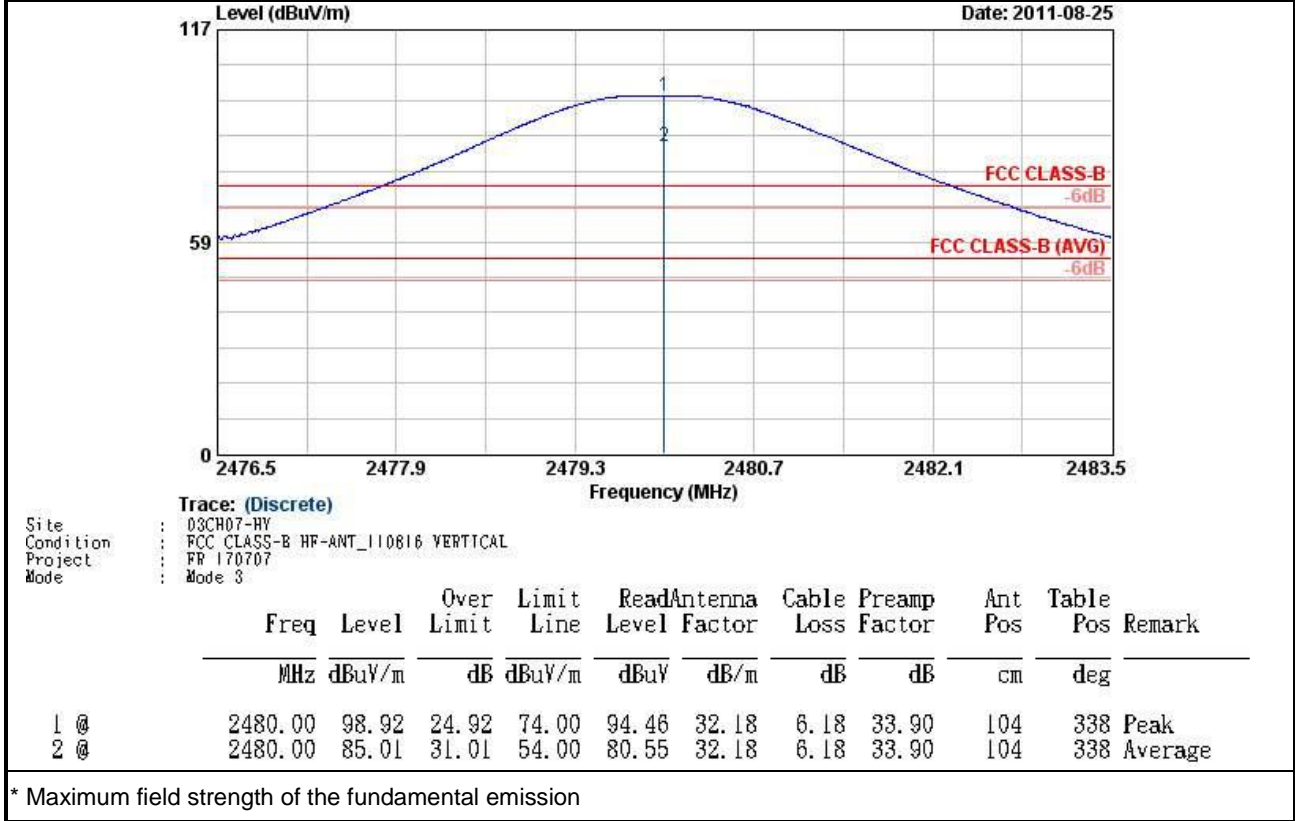



Test Mode :	Mode 3	Temperature :	23~26°C
Test Channel :	78	Relative Humidity :	53~56%
Test Engineer :	Wii Chang	Polarization :	Vertical

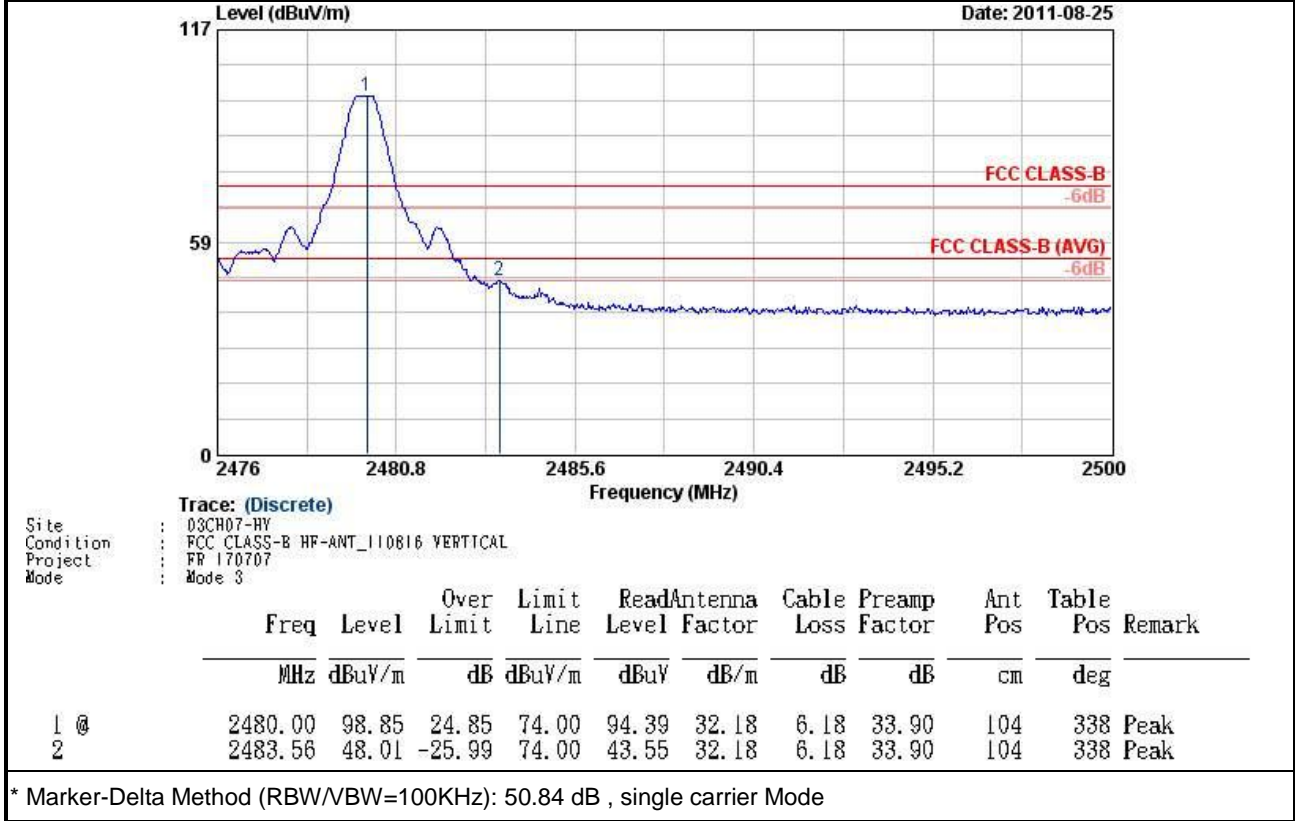



Test Mode :	Mode 3	Temperature :	23~26°C
Test Channel :	78	Relative Humidity :	53~56%
Test Engineer :	Wii Chang	Polarization :	Vertical

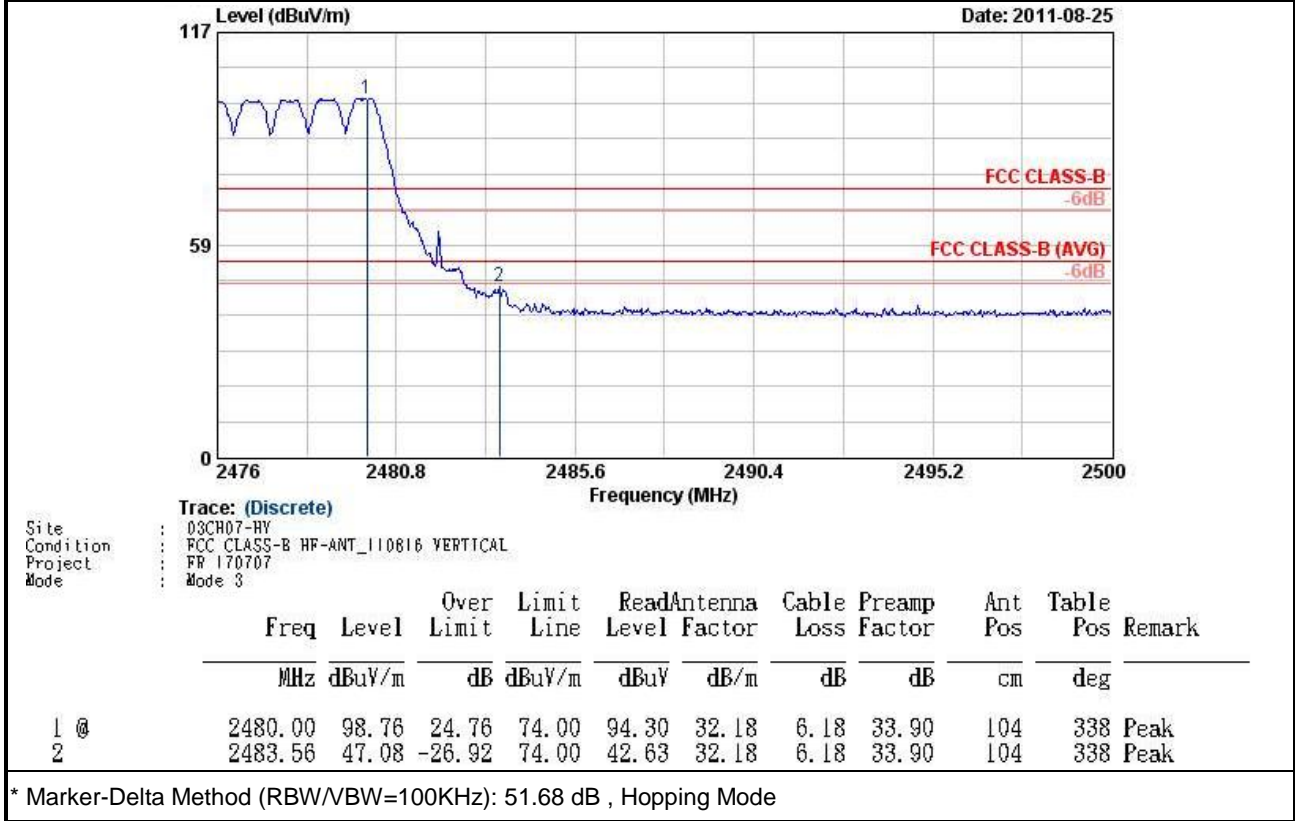



### 3.3 AC Conducted Emission Measurement

#### 3.3.1 Limit of AC Conducted Emission

For equipment that is designed to be connected to the public utility (AC) power line, the radio frequency voltage that is conducted back onto the AC power line on any frequency or frequencies within the band 150 kHz to 30 MHz shall not exceed the limits in the following table.

Frequency of emission (MHz)	Conducted limit (dBuV)	
	Quasi-peak	Average
0.15-0.5	66 to 56*	56 to 46*
0.5-5	56	46
5-30	60	50

\*Decreases with the logarithm of the frequency.

#### 3.3.2 Measuring Instruments

See list of measuring instruments of this test report.

#### 3.3.3 Test Procedures

1. Please follow the guidelines in ANSI C63.4-2003.
2. The EUT was placed 0.4 meter from the conducting wall of the shielding room was kept at least 80 centimeters from any other grounded conducting surface.
  1. Connect EUT to the power mains through a line impedance stabilization network (LISN).
  2. All the support units are connecting to the other LISN.
  3. The LISN provides 50 ohm coupling impedance for the measuring instrument.
  4. The FCC states that a 50 ohm, 50 microhenry LISN should be used.
  5. Both sides of AC line were checked for maximum conducted interference.
  6. The frequency range from 150 kHz to 30 MHz was searched.
  7. Set the test-receiver system to Peak Detect Function and specified bandwidth with Maximum Hold Mode.

### 3.3.4 Test Setup

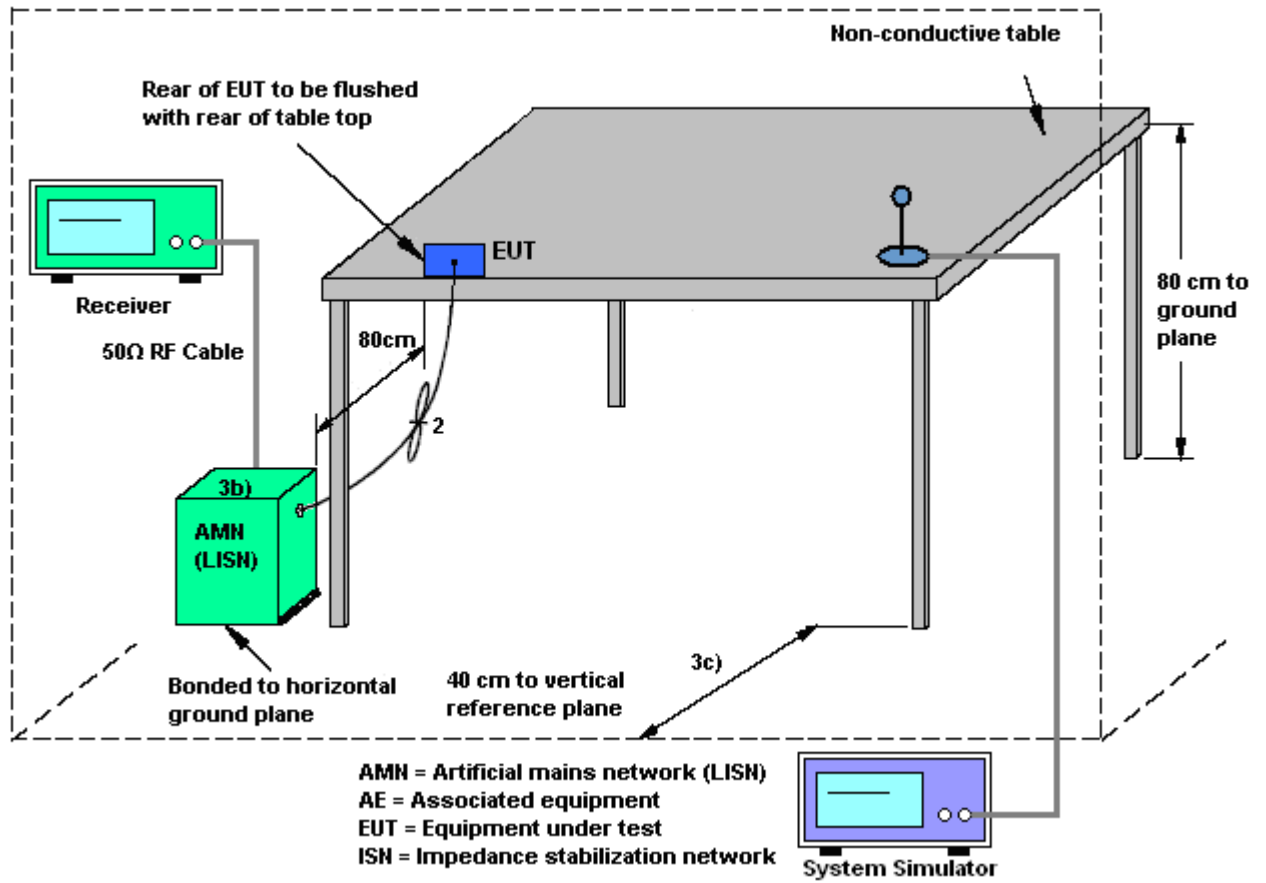

3.3.5 Test Result of AC Conducted Emission

Test Mode :	Mode 1	Temperature :	21~23°C
Test Engineer :	Kai-Chun Chu	Relative Humidity :	42~44%
Test Voltage :	120Vac / 60Hz	Phase :	Line
Function Type :	WLAN Link + Bluetooth Link + Zigbee On + TC + Adapter		
Remark :	All emissions not reported here are more than 10 dB below the prescribed limit.		

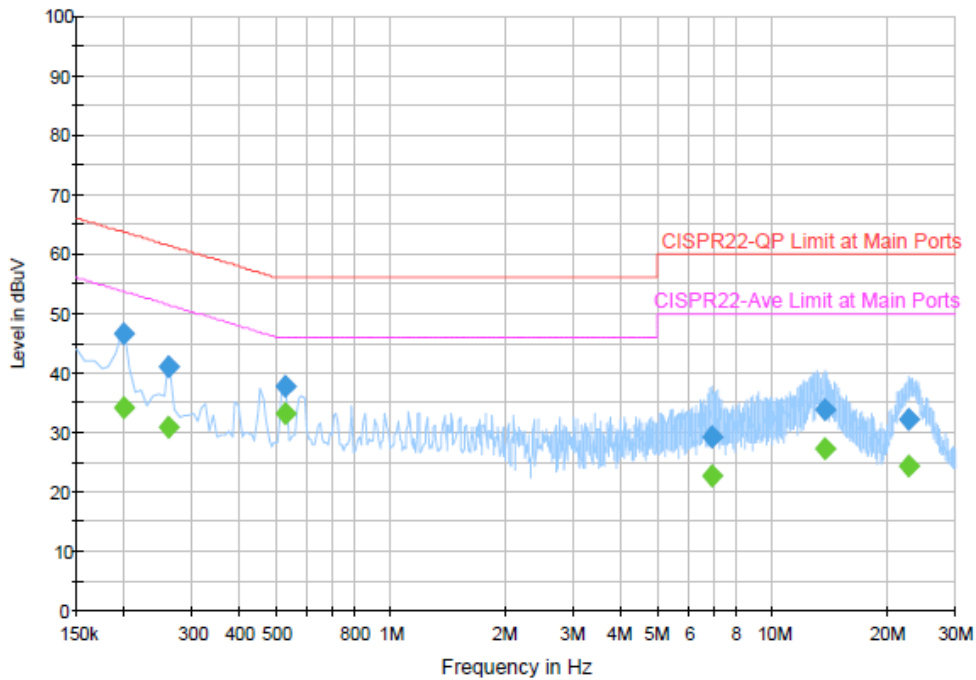

Final Result 1

Frequency (MHz)	QuasiPeak (dBμV)	Filter	Line	Corr. (dB)	Margin (dB)	Limit (dBμV)
0.198000	46.6	Off	L1	19.4	17.1	63.7
0.262000	41.0	Off	L1	19.4	20.4	61.4
0.526000	37.6	Off	L1	19.4	18.4	56.0
6.934000	29.1	Off	L1	19.5	30.9	60.0
13.694000	33.9	Off	L1	19.6	26.1	60.0
22.550000	32.0	Off	L1	19.8	28.0	60.0

Final Result 2

Frequency (MHz)	Average (dBμV)	Filter	Line	Corr. (dB)	Margin (dB)	Limit (dBμV)
0.198000	34.2	Off	L1	19.4	19.5	53.7
0.262000	30.7	Off	L1	19.4	20.7	51.4
0.526000	33.1	Off	L1	19.4	12.9	46.0
6.934000	22.6	Off	L1	19.5	27.4	50.0
13.694000	27.2	Off	L1	19.6	22.8	50.0
22.550000	24.3	Off	L1	19.8	25.7	50.0



Test Mode :	Mode 1	Temperature :	21~23°C
Test Engineer :	Kai-Chun Chu	Relative Humidity :	42~44%
Test Voltage :	120Vac / 60Hz	Phase :	Neutral
Function Type :	WLAN Link + Bluetooth Link + Zigbee On + TC + Adapter		
Remark :	All emissions not reported here are more than 10 dB below the prescribed limit.		

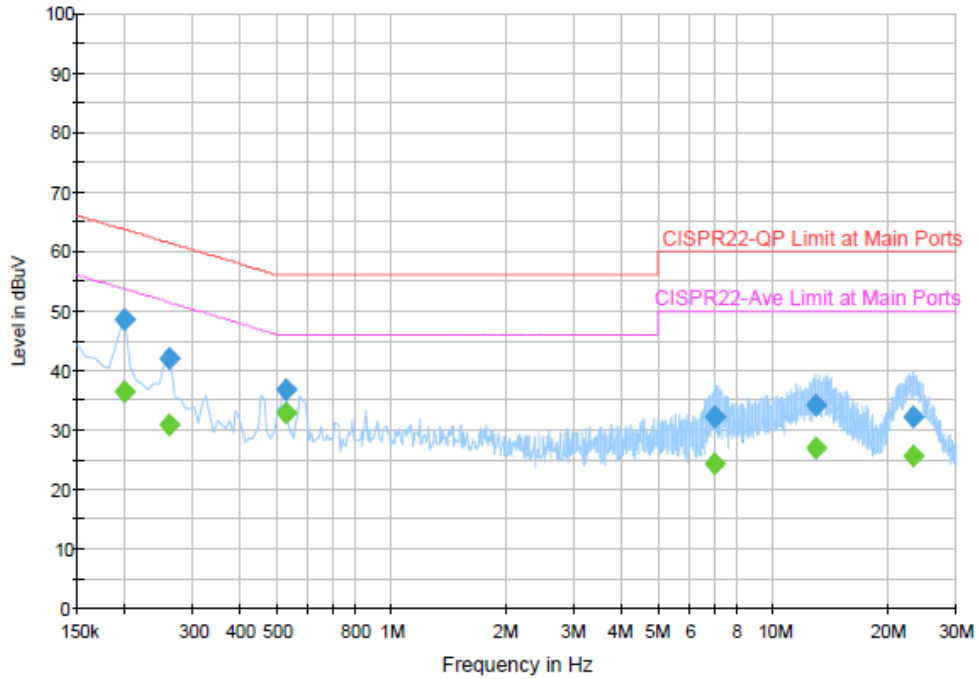

**Final Result 1**

Frequency (MHz)	QuasiPeak (dBμV)	Filter	Line	Corr. (dB)	Margin (dB)	Limit (dBμV)
0.198000	48.4	Off	N	19.4	15.3	63.7
0.262000	42.1	Off	N	19.4	19.3	61.4
0.526000	36.8	Off	N	19.4	19.2	56.0
7.014000	32.1	Off	N	19.6	27.9	60.0
12.918000	34.0	Off	N	19.7	26.0	60.0
23.262000	32.1	Off	N	19.8	27.9	60.0

**Final Result 2**

Frequency (MHz)	Average (dBμV)	Filter	Line	Corr. (dB)	Margin (dB)	Limit (dBμV)
0.198000	36.3	Off	N	19.4	17.4	53.7
0.262000	30.7	Off	N	19.4	20.7	51.4
0.526000	32.8	Off	N	19.4	13.2	46.0
7.014000	24.4	Off	N	19.6	25.6	50.0
12.918000	27.0	Off	N	19.7	23.0	50.0
23.262000	25.6	Off	N	19.8	24.4	50.0

### 3.4 Radiated Emission Measurement

#### 3.4.1 Limit of Radiated Emission

In any 100 kHz bandwidth outside the intentional radiator frequency band, all harmonics/spurious must be at least 20 dB below the highest emission level within the authorized band. In addition, radiated emissions which fall in the restricted bands must also comply with the FCC section 15.209 limits as below.

Frequency (MHz)	Field Strength (microvolts/meter)	Measurement Distance (meters)
0.009 – 0.490	2400/F(kHz)	300
0.490 – 1.705	24000/F(kHz)	30
1.705 – 30.0	30	30
30 – 88	100	3
88 – 216	150	3
216 - 960	200	3
Above 960	500	3

#### 3.4.2 Measuring Instruments

See list of measuring instruments of this test report.

#### 3.4.3 Test Procedures

1. The testing follows the guidelines in FCC Public Notice DA 00-705 Measurement Guidelines.
2. Use the following spectrum analyzer settings:
  - (1) Span = wide enough to fully capture the emission being measured; RBW = 1 MHz for  $f \geq 1$  GHz, 100 kHz for  $f < 1$  GHz; VBW  $\geq$  RBW; Sweep = auto; Detector function = peak; Trace = max hold.
  - (2) Above 18 GHz shall be extrapolated to the specified distance using an extrapolation factor of 20 dB/decade from 3m to 1m.  
 Distance extrapolation factor =  $20 \log(\text{specific distance [3m]} / \text{test distance [1m]})$  (dB)
3. Follow the guidelines in ANSI C63.4-2003 with respect to maximizing the emission by rotating the EUT, measuring the emission for three EUT orthogonal planes, and adjusting the measurement antenna height and polarization. A pre-amp and a high pass filter are used for this test in order to get the good signal level.
4. Measured average value for the peak value is greater than 54 dBuV/m

### 3.4.4 Test Setup

For radiated emissions below 30MHz

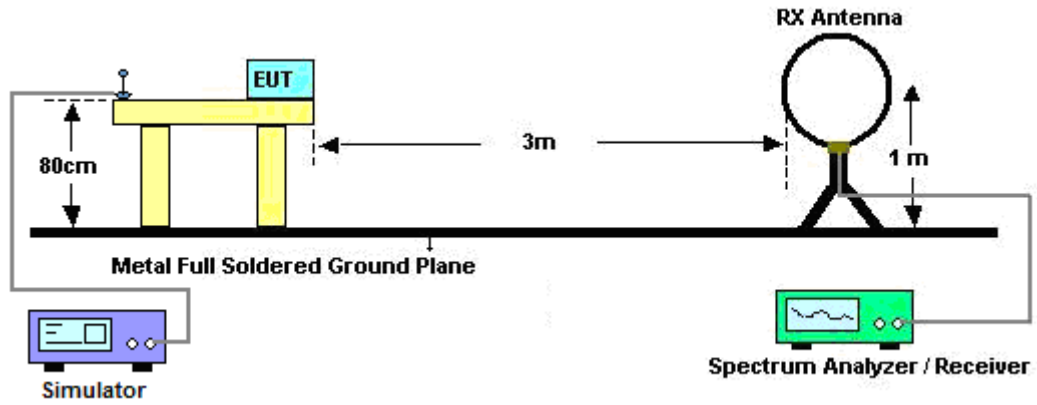

For radiated emissions from 30MHz to 1GHz

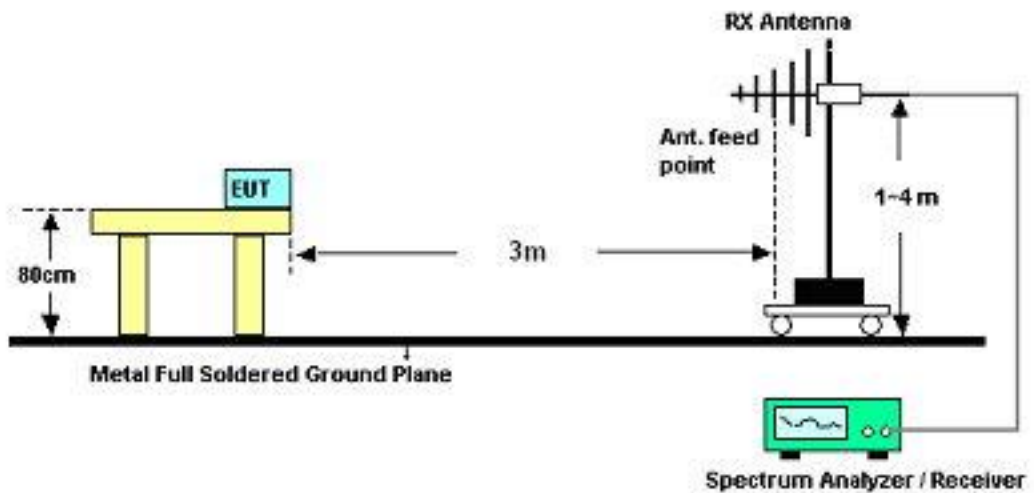

For radiated emissions above 1GHz

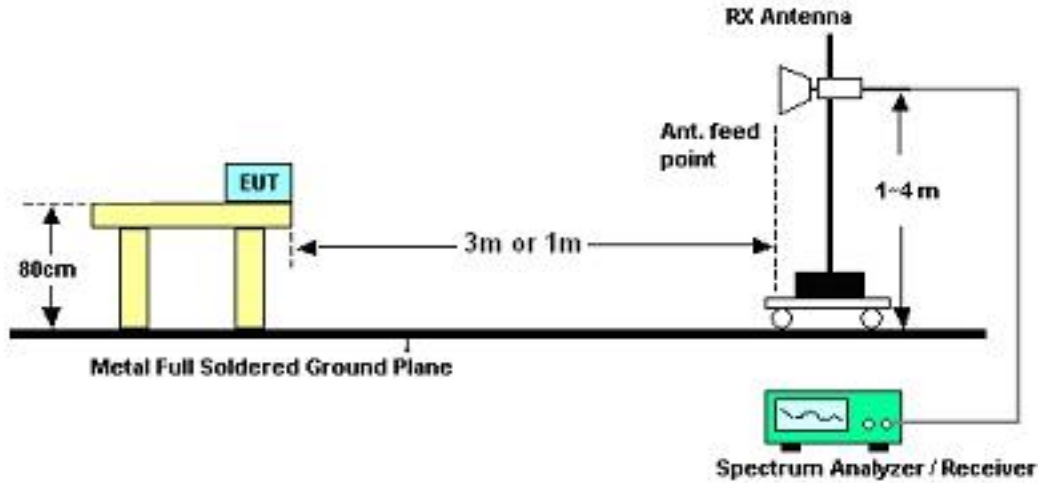

### 3.4.5 Test Results of Radiated Emissions (9 kHz ~ 30 MHz)

Test Engineer :	Wii Chang	Temperature :	23~26°C	
		Relative Humidity :	53~56%	
Frequency (MHz)	Level (dBuV)	Over Limit (dB)	Limit Line (dBuV)	Remark
-	-	-	-	See Note

**Note:**

The amplitude of spurious emissions that are attenuated by more than 20dB below the permissible value has no need to be reported.

Distance extrapolation factor = 40 log (specific distance / test distance) (dB);

Limit line = specific limits (dBuV) + distance extrapolation factor.



3.4.6 Test Result of Radiated Emission (30 MHz ~ 10<sup>th</sup> Harmonic)

Test Mode :	Mode 1	Temperature :	23~26°C
Test Channel :	00	Relative Humidity :	53~56%
Test Engineer :	Wii Chang	Polarization :	Horizontal
Remark :	1. 2402 MHz is Fundamental Signals which can be ignored. 2. 7206 MHz is not within a restricted band.		

Frequency ( MHz )	Level ( dBuV/m )	Over Limit ( dB )	Limit Line ( dBuV/m )	Read Level ( dBuV )	Antenna Factor ( dB )	Cable Loss ( dB )	Preamp Factor ( dB )	Ant Pos ( cm )	Table Pos ( deg )	Remark
34.86	36.88	-3.12	40	52.44	15.33	0.58	31.47	145	223	Peak
116.13	38.84	-4.66	43.5	58.12	11.2	1.08	31.56	-	-	Peak
167.97	35.8	-7.7	43.5	56.2	9.89	1.23	31.52	-	-	Peak
315.4	37.41	-8.59	46	52.99	13.94	1.8	31.32	-	-	Peak
374.2	35.92	-10.08	46	49.3	15.78	2.09	31.25	-	-	Peak
416.2	36.59	-9.41	46	48.72	16.83	2.2	31.16	-	-	Peak
2349.9	45.97	-28.03	74	41.87	31.98	5.95	33.83	100	285	Peak
2349.9	34.51	-19.49	54	30.41	31.98	5.95	33.83	100	285	Average
2402	104.43	-	-	100.17	32.08	6.03	33.85	100	285	Peak
2402	90.23	-	-	85.99	32.06	6.03	33.85	100	285	Average
2486	31.97	-22.03	54	27.51	32.18	6.18	33.9	100	285	Average
2486	44.39	-29.61	74	39.93	32.18	6.18	33.9	100	285	Peak
4804	52.11	-21.89	74	68.03	34.1	9.12	59.14	100	159	Peak
4804	44.83	-9.17	54	60.76	34.1	9.11	59.14	100	159	Average
7206	53.3	-31.13	84.43	65.67	35.7	10.02	58.09	100	0	Peak





<b>Test Mode :</b>	Mode 1	<b>Temperature :</b>	23~26°C
<b>Test Channel :</b>	00	<b>Relative Humidity :</b>	53~56%
<b>Test Engineer :</b>	Wii Chang	<b>Polarization :</b>	Vertical
<b>Remark :</b>	1. 2402 MHz is Fundamental Signals which can be ignored. 2. 7206 MHz is not within a restricted band.		

Frequency ( MHz )	Level ( dBuV/m )	Over Limit ( dB )	Limit Line ( dBuV/m )	Read Level ( dBuV )	Antenna Factor ( dB )	Cable Loss ( dB )	Preamp Factor ( dB )	Ant Pos ( cm )	Table Pos ( deg )	Remark
69.42	29.2	-10.8	40	53.63	6.29	0.84	31.56	-	-	Peak
92.37	31.05	-12.45	43.5	52.71	8.9	0.96	31.52	-	-	Peak
216.3	29.02	-16.98	46	48.81	10.27	1.4	31.46	-	-	Peak
349	35.19	-10.81	46	49.52	14.99	1.97	31.29	-	-	Peak
380.5	37.09	-8.91	46	50.27	15.96	2.1	31.24	122	141	Peak
463.8	33.77	-12.23	46	44.9	17.62	2.33	31.08	-	-	Peak
2381.82	45.54	-28.46	74	41.33	32.03	6.03	33.85	116	299	Peak
2381.82	33.04	-20.96	54	28.83	32.03	6.03	33.85	116	299	Average
2402	98.08	-	-	93.82	32.08	6.03	33.85	116	299	Peak
2402	84.04	-	-	79.8	32.06	6.03	33.85	116	299	Average
2486	32.13	-21.87	54	27.67	32.18	6.18	33.9	116	299	Average
2486	44.88	-29.12	74	40.42	32.18	6.18	33.9	116	299	Peak
4804	47.68	-26.32	74	63.6	34.1	9.12	59.14	100	0	Peak
7206	52.29	-25.79	78.08	64.66	35.7	10.02	58.09	100	0	Peak



<b>Test Mode :</b>	Mode 2	<b>Temperature :</b>	23~26°C
<b>Test Channel :</b>	39	<b>Relative Humidity :</b>	53~56%
<b>Test Engineer :</b>	Wii Chang	<b>Polarization :</b>	Horizontal
<b>Remark :</b>	2441 MHz is Fundamental Signals which can be ignored.		

Frequency ( MHz )	Level ( dBuV/m )	Over Limit ( dB )	Limit Line ( dBuV/m )	Read Level ( dBuV )	Antenna Factor ( dB )	Cable Loss ( dB )	Preamp Factor ( dB )	Ant Pos ( cm )	Table Pos ( deg )	Remark
34.05	33.4	-6.6	40	48.73	15.57	0.57	31.47	100	221	Peak
94.26	35.49	-8.01	43.5	56.93	9.12	0.97	31.53	-	-	Peak
167.97	35.66	-7.84	43.5	56.06	9.89	1.23	31.52	-	-	Peak
374.2	35.51	-10.49	46	48.89	15.78	2.09	31.25	-	-	Peak
478.5	34.74	-11.26	46	45.57	17.86	2.37	31.06	-	-	Peak
624.1	32.81	-13.19	46	40.92	20.03	2.76	30.9	-	-	Peak
2388	46.15	-27.85	74	41.91	32.06	6.03	33.85	100	252	Peak
2388	35.46	-18.54	54	31.22	32.06	6.03	33.85	100	252	Average
2441	105.34	-	-	100.98	32.13	6.11	33.88	100	252	Peak
2441	90.48	-	-	86.12	32.13	6.11	33.88	100	252	Average
2494	46.76	-27.24	74	42.28	32.2	6.18	33.9	100	252	Peak
2494	36.91	-17.09	54	32.43	32.2	6.18	33.9	100	252	Average
4882	53.7	-20.3	74	69.5	34.1	9.14	59.04	100	174	Peak
4882	42.31	-11.69	54	58.11	34.1	9.14	59.04	100	174	Average
7323	49.85	-24.15	74	62.23	35.7	10.06	58.14	100	0	Peak



<b>Test Mode :</b>	Mode 2	<b>Temperature :</b>	23~26°C
<b>Test Channel :</b>	39	<b>Relative Humidity :</b>	53~56%
<b>Test Engineer :</b>	Wii Chang	<b>Polarization :</b>	Vertical
<b>Remark :</b>	2441 MHz is Fundamental Signals which can be ignored.		

Frequency ( MHz )	Level ( dBuV/m )	Over Limit ( dB )	Limit Line ( dBuV/m )	Read Level ( dBuV )	Antenna Factor ( dB )	Cable Loss ( dB )	Preamp Factor ( dB )	Ant Pos ( cm )	Table Pos ( deg )	Remark
52.41	29.88	-10.12	40	52.95	7.76	0.71	31.54	-	-	Peak
67.53	32.15	-7.85	40	56.71	6.17	0.82	31.55	-	-	Peak
199.29	27.9	-15.6	43.5	48.96	9.1	1.32	31.48	-	-	Peak
486.9	39.28	-6.72	46	49.93	18.01	2.4	31.06	-	-	Peak
525.4	41.57	-4.43	46	51.47	18.62	2.5	31.02	-	-	Peak
561.8	41.69	-4.31	46	50.91	19.17	2.58	30.97	133	209	Peak
2388	46.52	-27.48	74	42.28	32.06	6.03	33.85	100	337	Peak
2388	34.16	-19.84	54	29.92	32.06	6.03	33.85	100	337	Average
2441	85.64	-	-	81.28	32.13	6.11	33.88	100	337	Average
2441	99.24	-	-	94.88	32.13	6.11	33.88	100	337	Peak
2494	45.88	-28.12	74	41.4	32.2	6.18	33.9	100	337	Peak
2494	33.64	-20.36	54	29.16	32.2	6.18	33.9	100	337	Average
4882	50.46	-23.54	74	66.26	34.1	9.14	59.04	100	0	Peak
7323	48.24	-25.76	74	60.62	35.7	10.06	58.14	100	0	Peak



<b>Test Mode :</b>	Mode 3	<b>Temperature :</b>	23~26°C
<b>Test Channel :</b>	78	<b>Relative Humidity :</b>	53~56%
<b>Test Engineer :</b>	Wii Chang	<b>Polarization :</b>	Horizontal
<b>Remark :</b>	2480 MHz is Fundamental Signals which can be ignored.		

Frequency ( MHz )	Level ( dBuV/m )	Over Limit ( dB )	Limit Line ( dBuV/m )	Read Level ( dBuV )	Antenna Factor ( dB )	Cable Loss ( dB )	Preamp Factor ( dB )	Ant Pos ( cm )	Table Pos ( deg )	Remark
31.89	35.41	-4.59	40	50.28	16.04	0.55	31.46	133	265	Peak
167.97	34.73	-8.77	43.5	55.13	9.89	1.23	31.52	-	-	Peak
238.98	34.17	-11.83	46	52.22	11.85	1.52	31.42	-	-	Peak
360.2	35.35	-10.65	46	49.23	15.33	2.06	31.27	-	-	Peak
478.5	34.06	-11.94	46	44.89	17.86	2.37	31.06	-	-	Peak
624.1	32.71	-13.29	46	40.82	20.03	2.76	30.9	-	-	Peak
2374	45.45	-28.55	74	41.27	32.03	5.99	33.84	100	250	Peak
2374	33.5	-20.5	54	29.32	32.03	5.99	33.84	100	250	Average
2480	90.3	-	-	85.84	32.18	6.18	33.9	100	250	Average
2480	105.18	-	-	100.72	32.18	6.18	33.9	100	250	Peak
2483.5	64.1	-9.9	74	59.64	32.18	6.18	33.9	100	250	Peak
2483.5	39.55	-14.45	54	35.09	32.18	6.18	33.9	100	250	Average
4960	49.92	-24.08	74	65.57	34.1	9.16	58.91	100	0	Peak
7440	47.18	-26.82	74	59.55	35.7	10.12	58.19	100	0	Peak



<b>Test Mode :</b>	Mode 3	<b>Temperature :</b>	23~26°C
<b>Test Channel :</b>	78	<b>Relative Humidity :</b>	53~56%
<b>Test Engineer :</b>	Wii Chang	<b>Polarization :</b>	Vertical
<b>Remark :</b>	2480 MHz is Fundamental Signals which can be ignored.		

Frequency ( MHz )	Level ( dBuV/m )	Over Limit ( dB )	Limit Line ( dBuV/m )	Read Level ( dBuV )	Antenna Factor ( dB )	Cable Loss ( dB )	Preamp Factor ( dB )	Ant Pos ( cm )	Table Pos ( deg )	Remark
54.57	28.7	-11.3	40	52.29	7.24	0.72	31.55	133	218	Peak
119.1	31.03	-12.47	43.5	50.04	11.45	1.1	31.56	-	-	Peak
243.57	29.66	-16.34	46	47.36	12.19	1.53	31.42	-	-	Peak
382.6	30.98	-15.02	46	44.05	16.05	2.11	31.23	-	-	Peak
486.9	32.58	-13.42	46	43.23	18.01	2.4	31.06	-	-	Peak
624.1	32.25	-13.75	46	40.36	20.03	2.76	30.9	-	-	Peak
2388	46.18	-27.82	74	41.94	32.06	6.03	33.85	104	338	Peak
2388	33.55	-20.45	54	29.31	32.06	6.03	33.85	104	338	Average
2480	85.01	-	-	80.55	32.18	6.18	33.9	104	338	Average
2480	98.87	-	-	94.41	32.18	6.18	33.9	104	338	Peak
2483.5	62.75	-11.25	74	58.29	32.18	6.18	33.9	104	338	Peak
2483.5	34.17	-19.83	54	29.71	32.18	6.18	33.9	104	338	Average
4960	51.54	-22.46	74	67.19	34.1	9.16	58.91	100	149	Peak
4960	35.11	-18.89	54	50.76	34.1	9.16	58.91	100	149	Average
7440	45.43	-28.57	74	57.8	35.7	10.12	58.19	100	0	Peak



## **3.5 Antenna Requirements**

### **3.5.1 Standard Applicable**

If directional gain of transmitting antennas is greater than 6dBi, the power shall be reduced by the same level in dB comparing to gain minus 6dBi. The use of a permanently attached antenna or of an antenna that uses a unique coupling to the intentional radiator shall be considered sufficient to comply with the FCC rule.

### **3.5.2 Antenna Connected Construction**

The antennas type used in this product is Chip Antenna without connector and it is considered to meet antenna requirement.

### **3.5.3 Antenna Gain**

The antenna peak gain of EUT is less than 6 dBi. Therefore, it is not necessary to reduce maximum peak output power limit.



## 4 List of Measuring Equipment

Instrument	Manufacturer	Model No.	Serial No.	Characteristics	Calibration Date	Due Date	Remark
System Simulator	R&S	CMU200	117995	N/A	Jul. 28, 2011	Jul. 27, 2012	Conducted (TH02-HY)
Spectrum Analyzer	R&S	FSP40	100055	9kHz~40GHz	Jun. 13, 2011	Jun. 12, 2012	Conducted (TH02-HY)
Thermal Chamber	Ten Billion	TTH-D35P	TBN-9307 01	N/A	Jul. 27, 2011	Jul. 26, 2012	Conducted (TH02-HY)
EMI Test Receive	R&S	ESCI 7	100724	9kHz~7GHz	Aug. 22, 2011	Aug. 21, 2012	Conduction (CO05-HY)
Two-LISN	R&S	ENV216	11-100081	9kHz ~ 30MHz	Dec. 03, 2010	Dec. 02, 2011	Conduction (CO05-HY)
Two-LISN	R&S	ENV216	11-100080	9kHz ~ 30MHz	Dec. 01, 2010	Nov. 30, 2011	Conduction (CO05-HY)
AC Power Source	APC	APC-1000W	N/A	N/A	N/A	N/A	Conduction (CO05-HY)
Bilog Antenna	SCHAFFNER	CBL6111C	2726	30MHz ~ 1GHz	Oct. 30, 2010	Oct. 29, 2011	Radiation (03CH07-HY)
Spectrum Analyzer	R&S	FSP30	101067	9kHz ~ 30GHz	Dec. 03, 2010	Dec. 02, 2011	Radiation (03CH07-HY)
Double Ridge Horn Antenna	ESCO	3117	00075962	1GHz ~ 18GHz	Aug. 10, 2011	Aug. 09, 2012	Radiation (03CH07-HY)
Pre Amplifier	Agilent	8449B	3008A023 62	1GHz~ 26.5GHz	Dec. 06, 2010	Dec. 05, 2011	Radiation (03CH07-HY)
Pre Amplifier	COM-POWER	PA-103A	161241	10-1000MHz.32 dB.GAIN	Mar. 29, 2011	Mar. 28, 2012	Radiation (03CH07-HY)
EMI TEST RECEIVER	R&S	ESCI 7	100724	9kHz~7GHz	Aug. 22, 2011	Aug. 21, 2012	Radiation (03CH07-HY)
Pre Amplifier	MITEQ	AMF-7D-0010 1800-30-10P	159088	1GHz ~ 18GHz	Feb. 21, 2011	Feb. 20, 2012	Radiation (03CH07-HY)

## 5 Uncertainty of Evaluation

### Uncertainty of Conducted Emission Measurement (150 kHz ~ 30 MHz)

Contribution	Uncertainty of $X_i$		$u(X_i)$
	dB	Probability Distribution	
Receiver Reading	0.10	Normal (k=2)	0.05
Cable Loss	0.10	Normal (k=2)	0.05
AMN Insertion Loss	2.50	Rectangular	0.63
Receiver Specification	1.50	Rectangular	0.43
Site Imperfection	1.39	Rectangular	0.80
Mismatch	+0.34 / -0.35	U-Shape	0.24
<b>Combined Standard Uncertainty <math>U_c(y)</math></b>	<b>1.13</b>		
<b>Measuring Uncertainty for a Level of Confidence of 95% (<math>U = 2U_c(y)</math>)</b>	<b>2.26</b>		

### Uncertainty of Radiated Emission Measurement (30 MHz ~ 1000 MHz)

Contribution	Uncertainty of $X_i$		$u(X_i)$
	dB	Probability Distribution	
Receiver Reading	0.41	Normal (k=2)	0.21
Antenna Factor Calibration	0.83	Normal (k=2)	0.42
Cable Loss Calibration	0.25	Normal (k=2)	0.13
Pre-Amplifier Gain Calibration	0.27	Normal (k=2)	0.14
RCV/SPA Specification	2.50	Rectangular	0.72
Antenna Factor Interpolation for Frequency	1.00	Rectangular	0.29
Site Imperfection	1.43	Rectangular	0.83
Mismatch	+0.39 / -0.41	U-Shape	0.28
<b>Combined Standard Uncertainty <math>U_c(y)</math></b>	<b>1.27</b>		
<b>Measuring Uncertainty for a Level of Confidence of 95% (<math>U = 2U_c(y)</math>)</b>	<b>2.54</b>		





**Uncertainty of Radiated Emission Measurement (1 GHz ~ 40 GHz)**

Contribution	Uncertainty of $X_i$		$u(X_i)$	$C_i$	$C_i * u(X_i)$
	dB	Probability Distribution			
Receiver Reading	±0.10	Normal (k=2)	0.10	1	0.10
Antenna Factor Calibration	±1.70	Normal (k=2)	0.85	1	0.85
Cable Loss Calibration	±0.50	Normal (k=2)	0.25	1	0.25
Receiver Correction	±2.00	Rectangular	1.15	1	1.15
Antenna Factor Directional	±1.50	Rectangular	0.87	1	0.87
Site Imperfection	±2.80	Triangular	1.14	1	1.14
Mismatch Receiver VSWR $\Gamma_1 = 0.197$ Antenna VSWR $\Gamma_2 = 0.194$ Uncertainty = $20\text{Log}(1-\Gamma_1*\Gamma_2)$	+0.34 / -0.35	U-Shape	0.244	1	0.244
<b>Combined Standard Uncertainty <math>U_c(y)</math></b>	<b>2.36</b>				
<b>Measuring Uncertainty for a Level of Confidence of 95% (<math>U = 2U_c(y)</math>)</b>	<b>4.72</b>				



## **Appendix A. Photographs of EUT**

Please refer to Sporton report number EP170707 as below.

1. External Photograph of EUT

Brand Name: DAP / Model Name: 9000WBWZV1 / Marketing Name: M9010





Brand Name: DAP / Model Name: 9000WBWZV1 / Marketing Name: M9010





2. Photograph of Accessory

Brand Name: DAP / Model Name: 9000WBWZV1 / Marketing Name: M9010

List of Accessory:

Specification of Accessory		
AC Adapter	Brand Name	CINCON ELECTRONICS
	Model Name	TRG36A15 12E03
Battery 1	Brand Name	DAP
	Model Name	VE026-8034
Battery 2	Brand Name	DAP
	Model Name	VE026-8035
LCD Panel	Brand Name	SGD
	Model Name	GNTW70NNBA1E0
Camera 1	Brand Name	DEMARREN
	Model Name	Q5M03A
WWAN Module	Brand Name	Sierra Wireless
	Model Name	MC8355
WLAN Module	Brand Name	Summit Data Communications
	Model Name	SDC-PE15N
Bluetooth Module	Brand Name	Bluegiga
	Model Name	WT21-A
Zigbee Module	Brand Name	Atmel
	Model Name	ATmega128RFA1
Power Cord 1	Brand Name	QUAIL
	Model Name	1062.079(NAM032)
Power Cord 2	Brand Name	QUAIL
	Model Name	8002.079(NAM033)
Power Cord 3	Brand Name	QUAIL
	Model Name	9657.079(NAM034)

Remark: For accessories equipped with this EUT, please refer to the following photos.



Brand Name: DAP / Model Name: 9000WBWZV1 / Marketing Name: M9010



Brand Name: DAP / Model Name: 9000WBWZV1 / Marketing Name: M9010

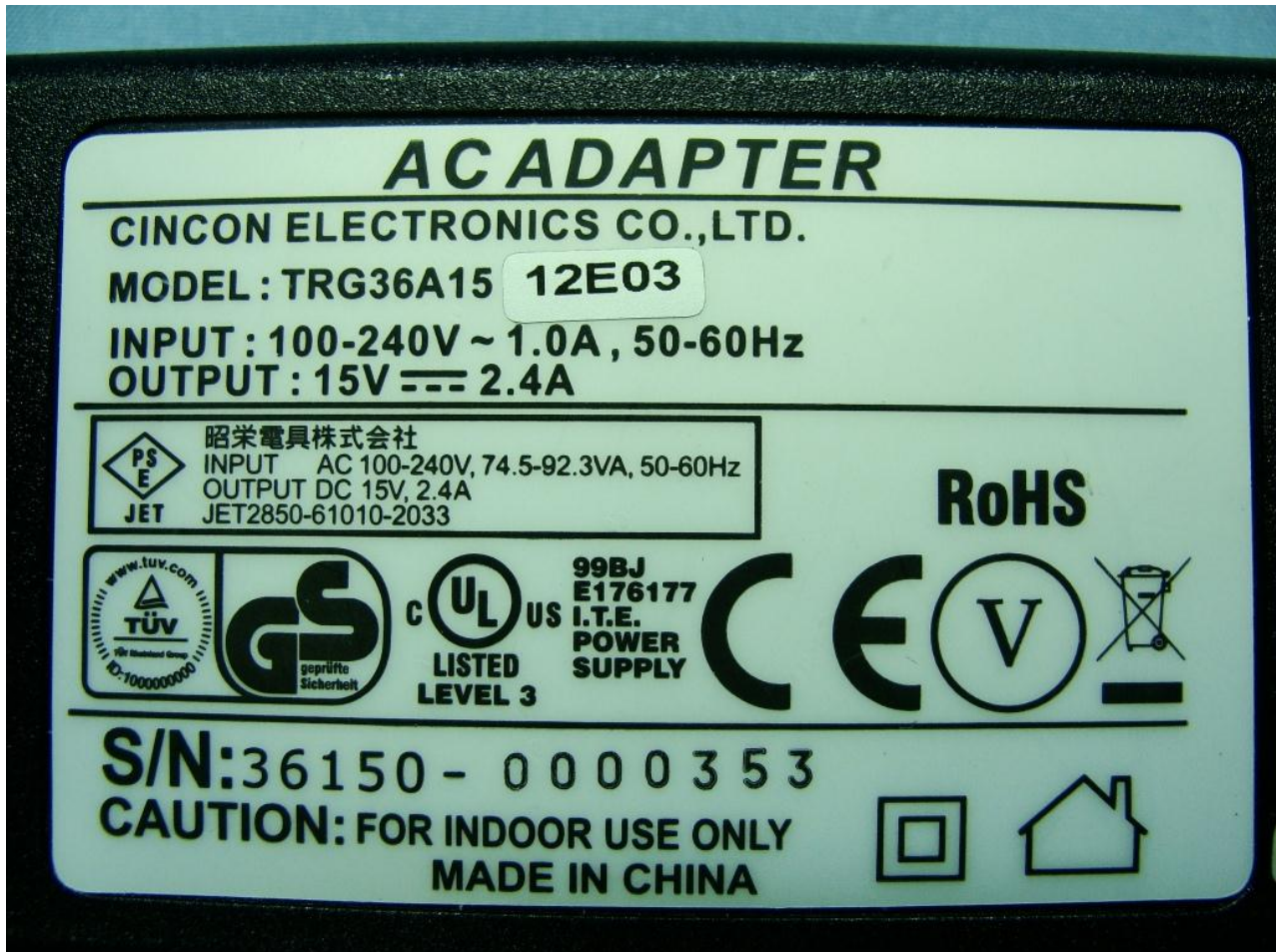

Brand Name: DAP / Model Name: 9000WBWZV1 / Marketing Name: M9010

Battery 1





Brand Name: DAP / Model Name: 9000WBWZV1 / Marketing Name: M9010

Battery 2



### 3. Internal Photograph of EUT

Brand Name: DAP / Model Name: 9000WBWZV1 / Marketing Name: M9010

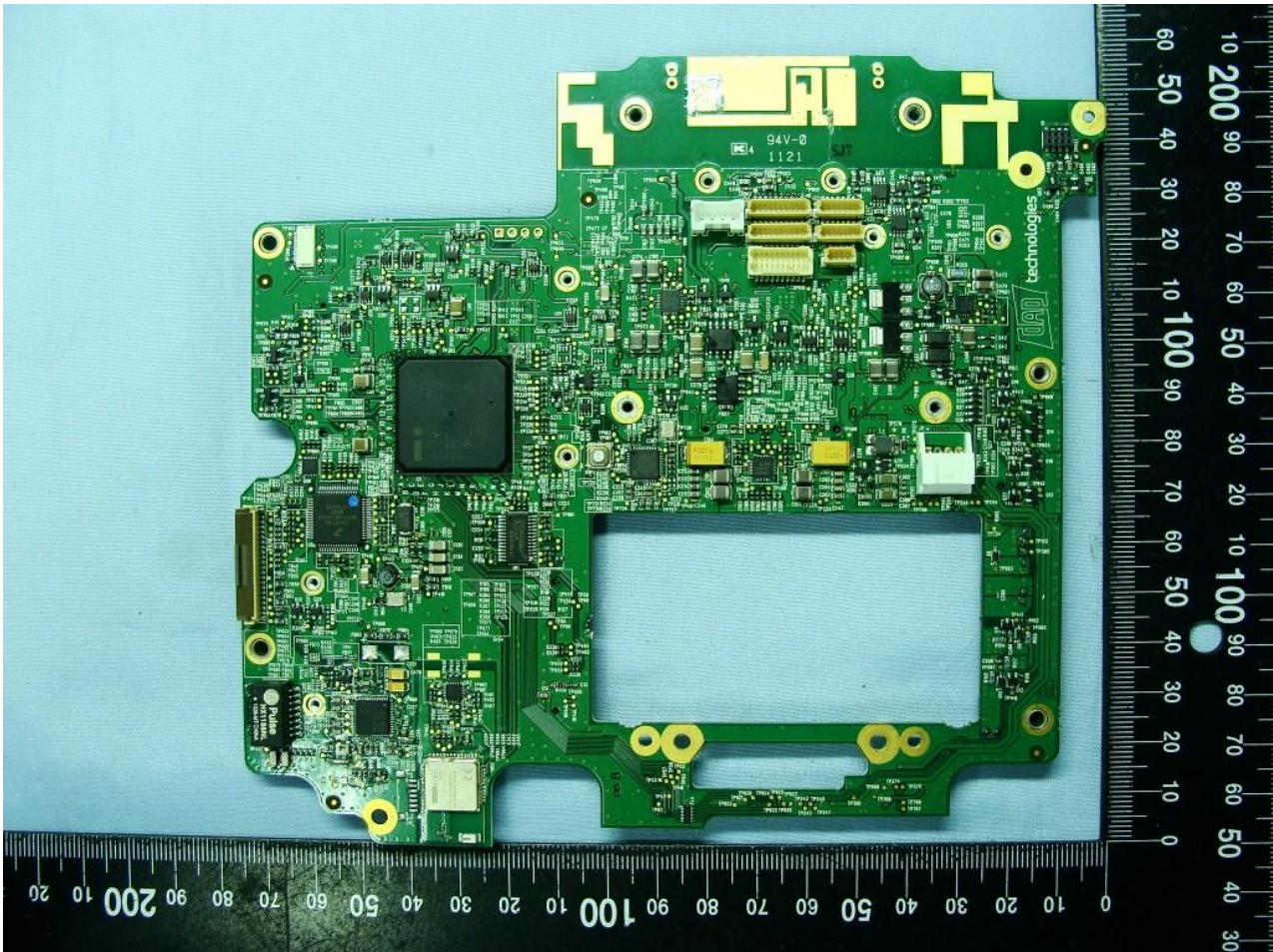

Brand Name: DAP / Model Name: 9000WBWZV1 / Marketing Name: M9010

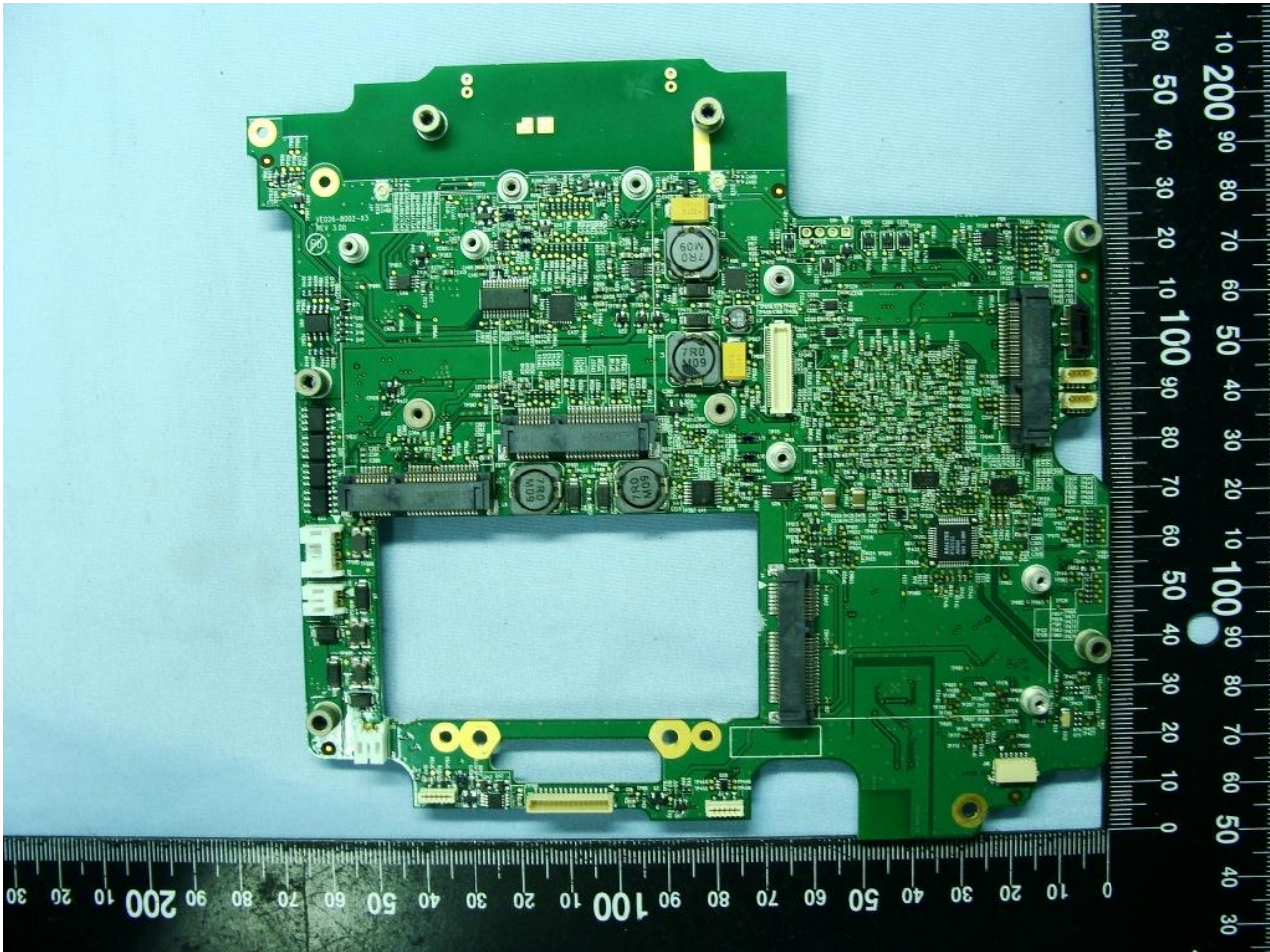

Brand Name: DAP / Model Name: 9000WBWZV1 / Marketing Name: M9010

WWAN and GPS Module

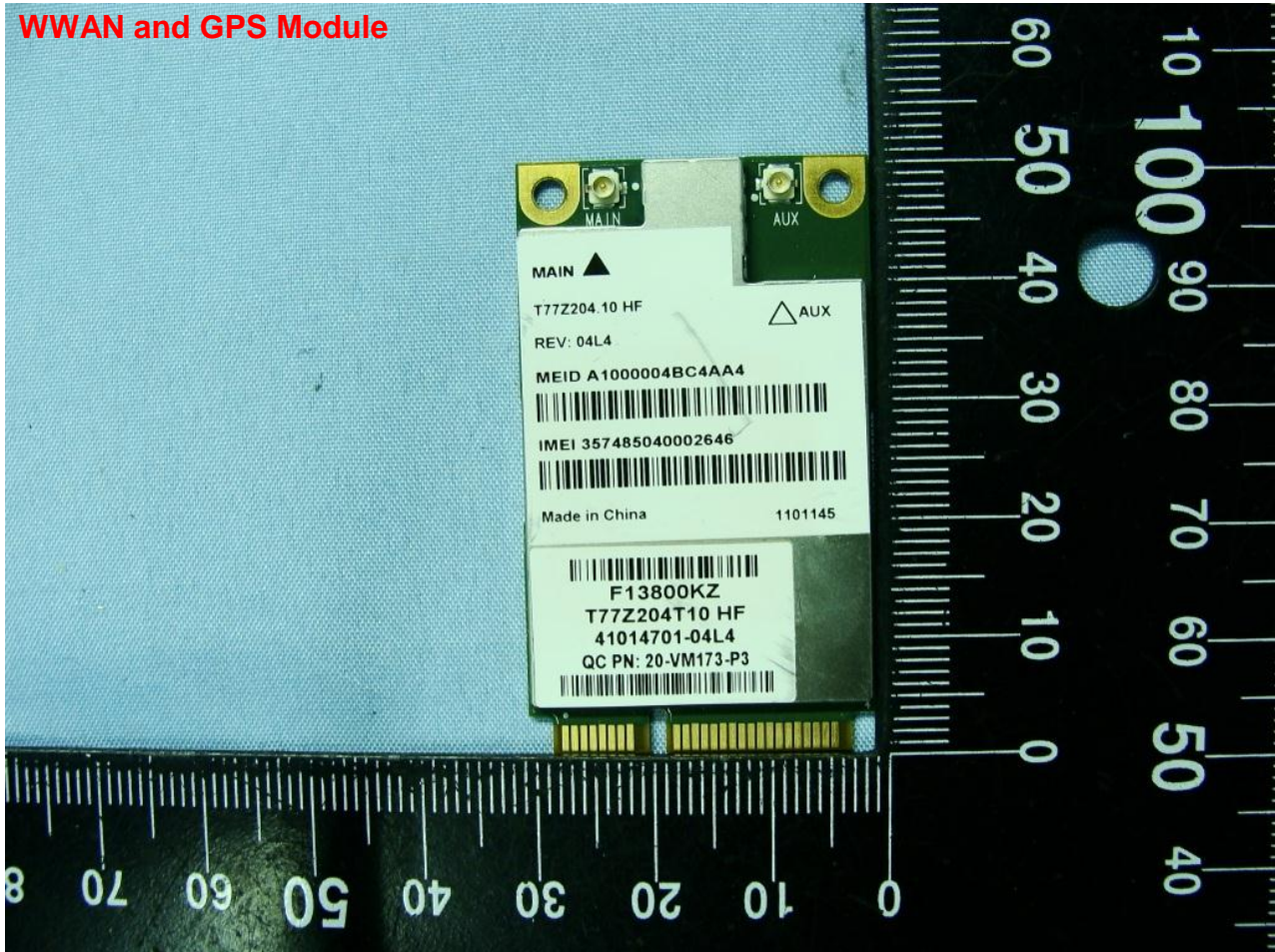

Brand Name: DAP / Model Name: 9000WBWZV1 / Marketing Name: M9010

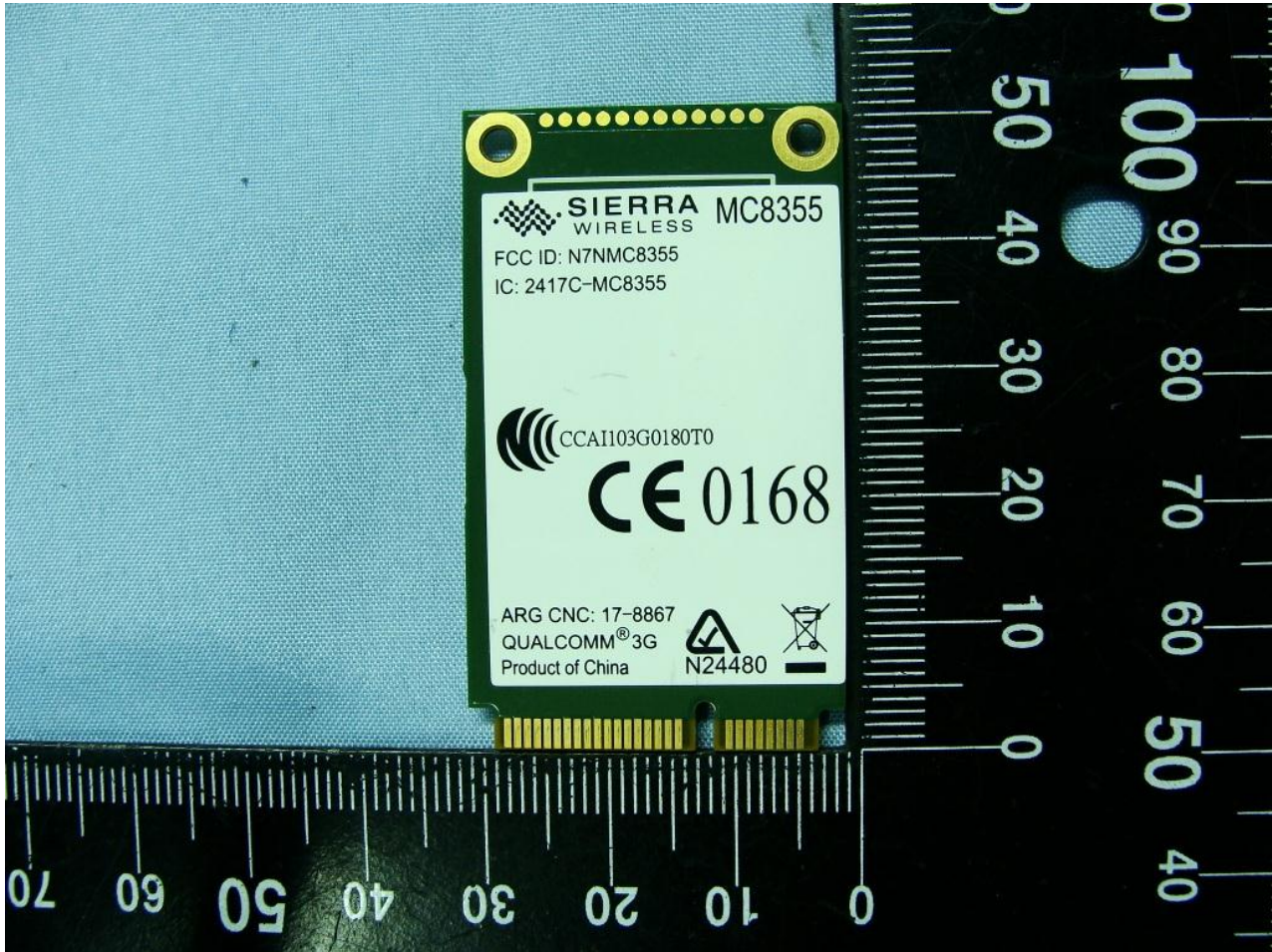

Brand Name: DAP / Model Name: 9000WBWZV1 / Marketing Name: M9010

WLAN Module

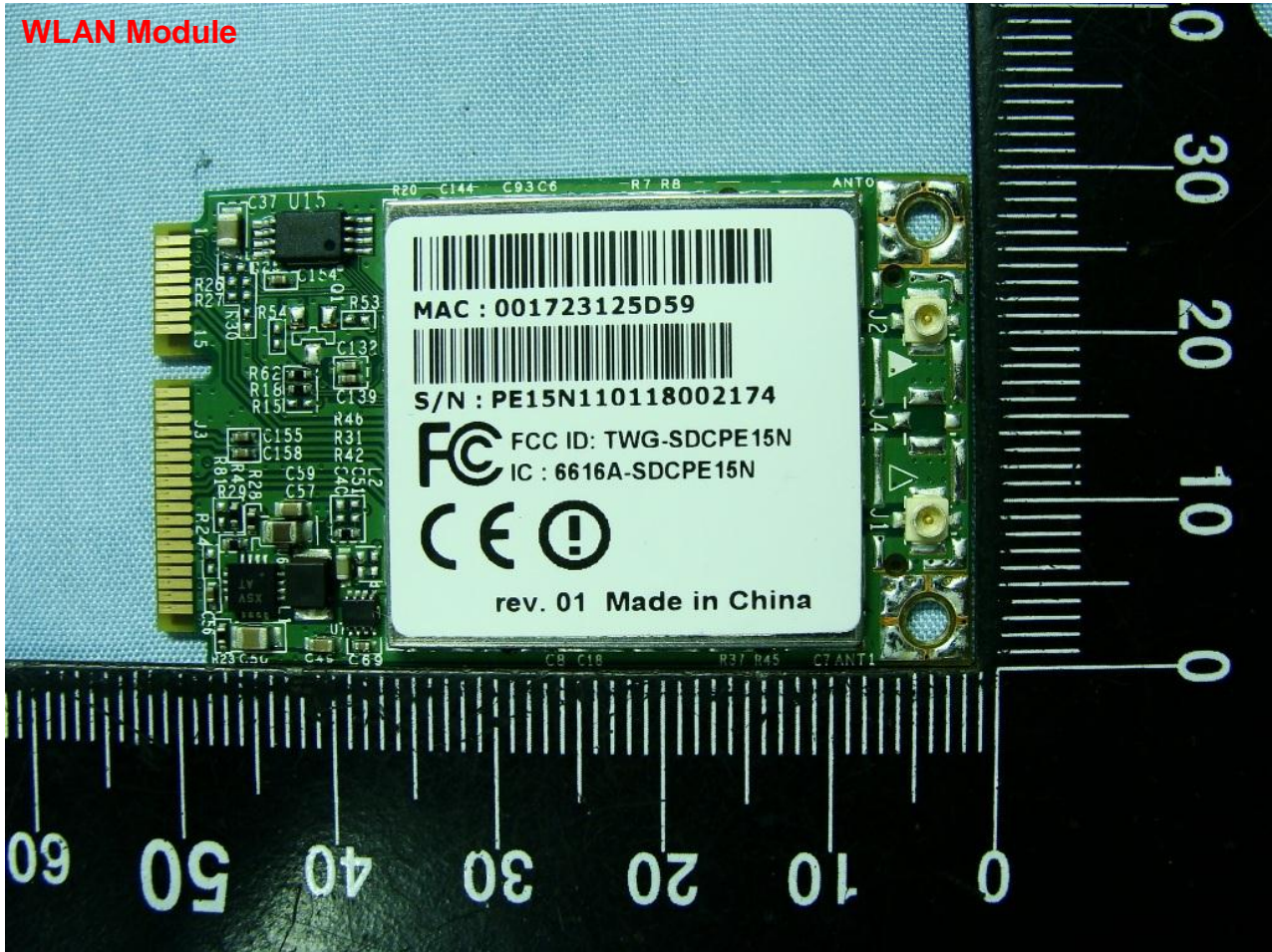

Brand Name: DAP / Model Name: 9000WBWZV1 / Marketing Name: M9010

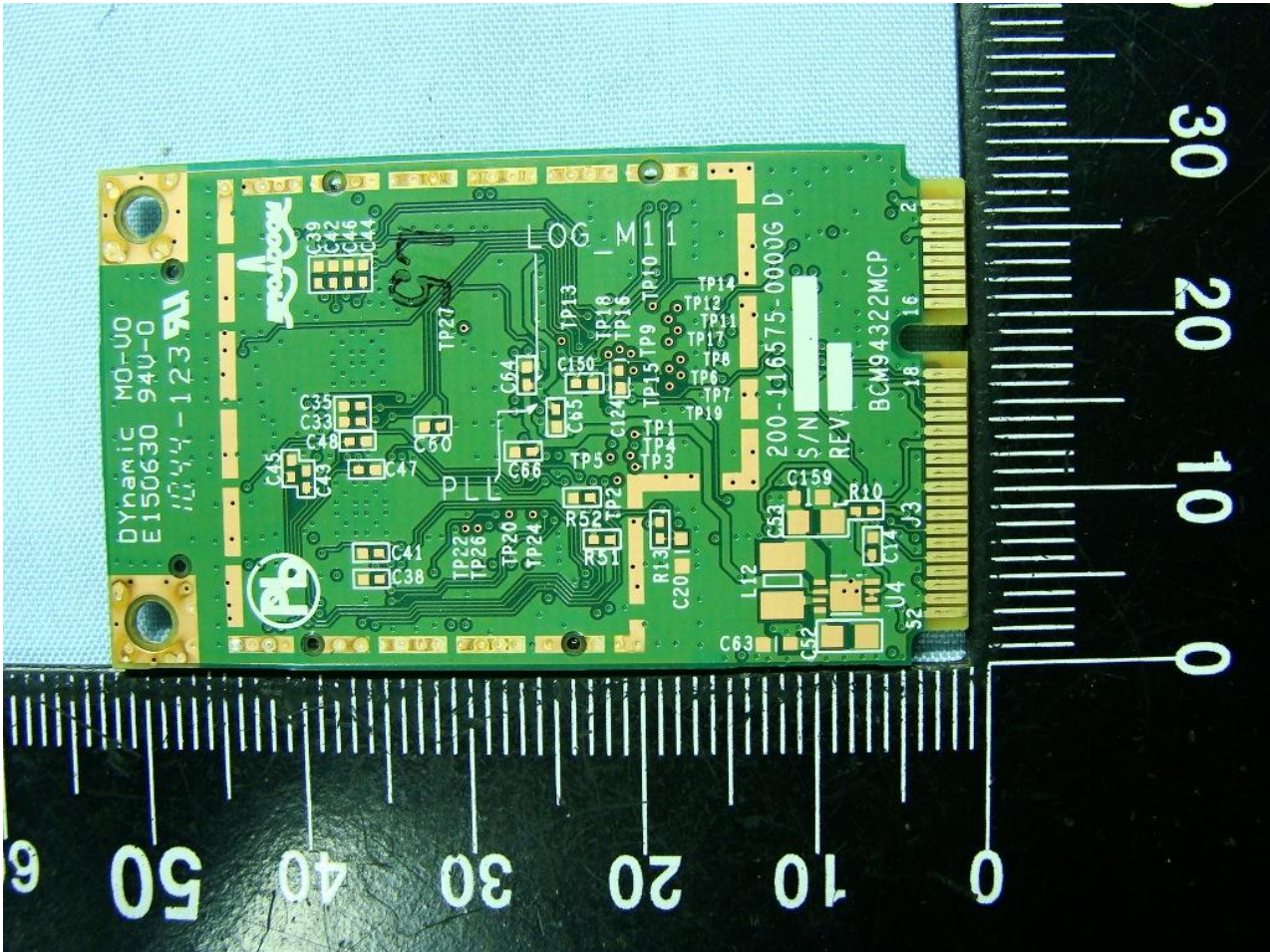

Brand Name: DAP / Model Name: 9000WBWZV1 / Marketing Name: M9010

**Bluetooth Module**

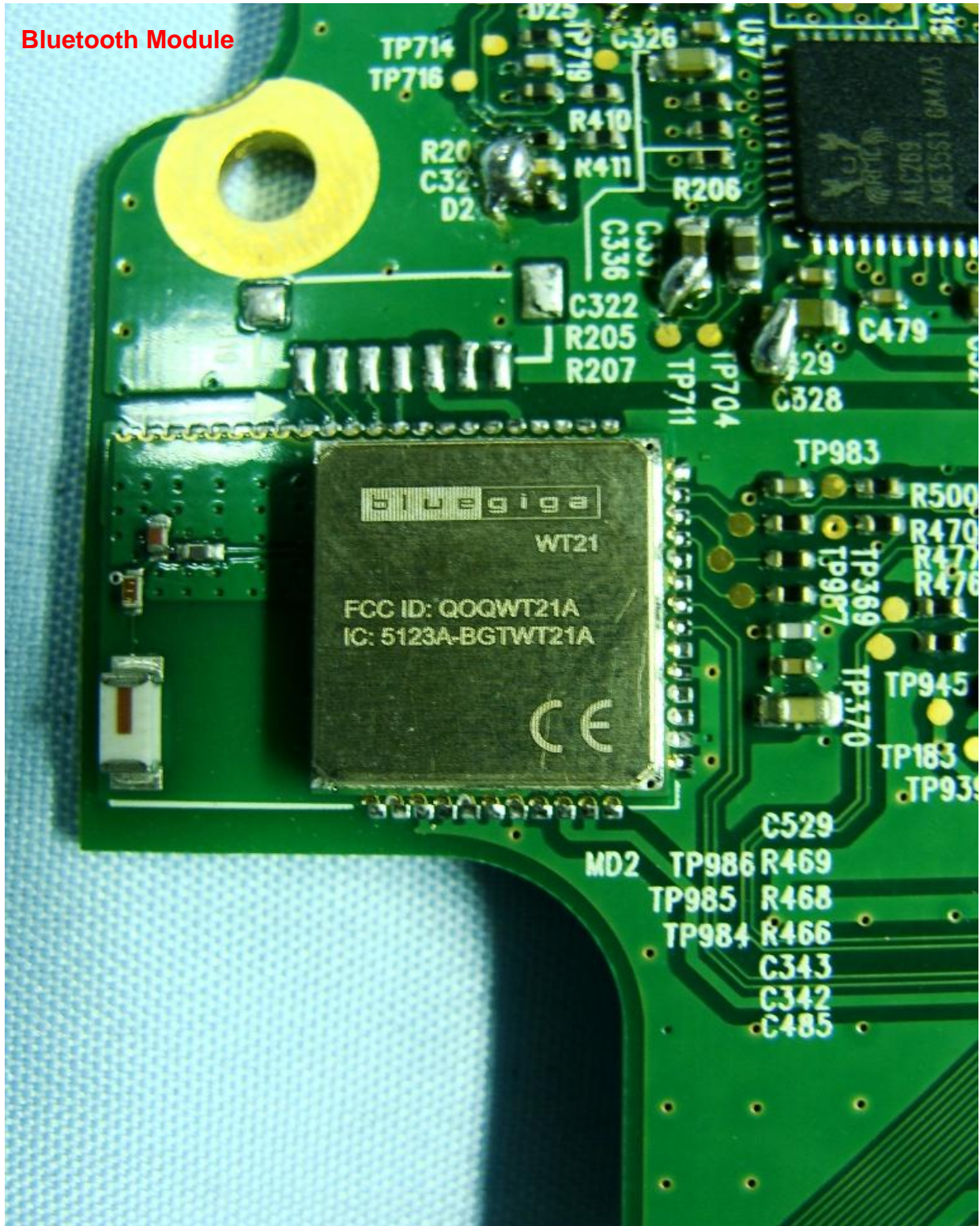



Brand Name: DAP / Model Name: 9000WBWZV1 / Marketing Name: M9010

**Zigbee Module**

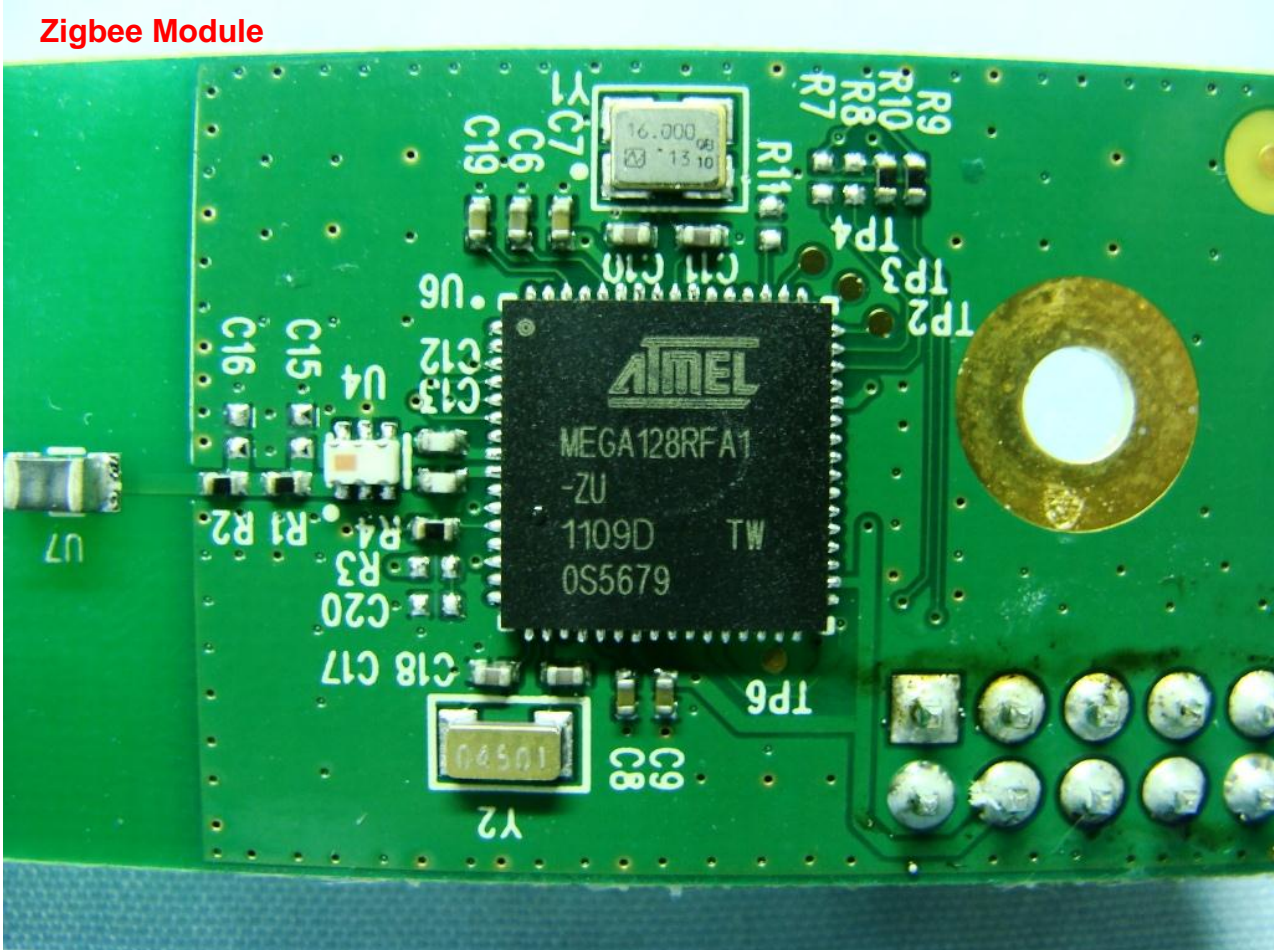

Brand Name: DAP / Model Name: 9000WBWZV1 / Marketing Name: M9010

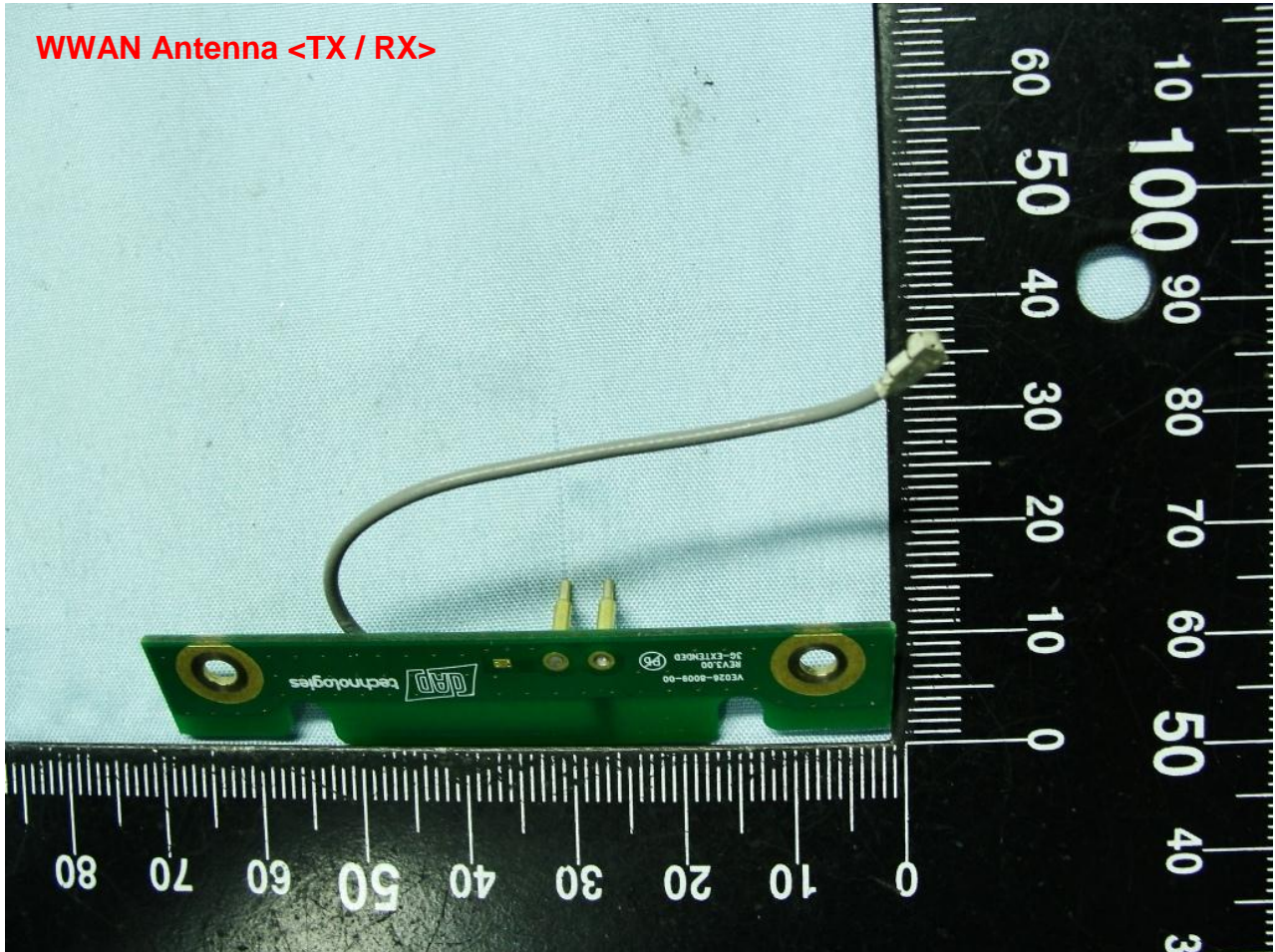

Brand Name: DAP / Model Name: 9000WBWZV1 / Marketing Name: M9010

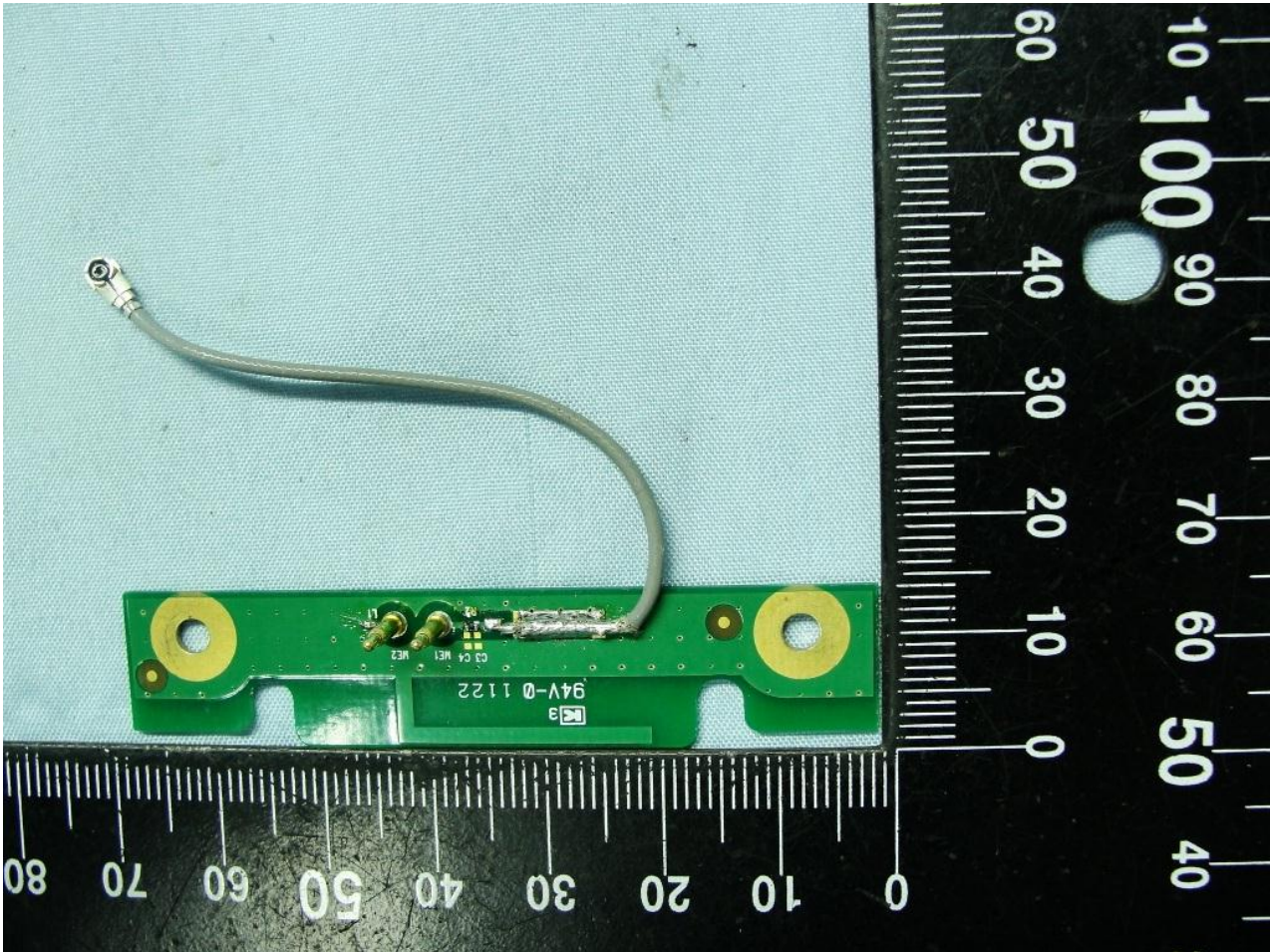

Brand Name: DAP / Model Name: 9000WBWZV1 / Marketing Name: M9010

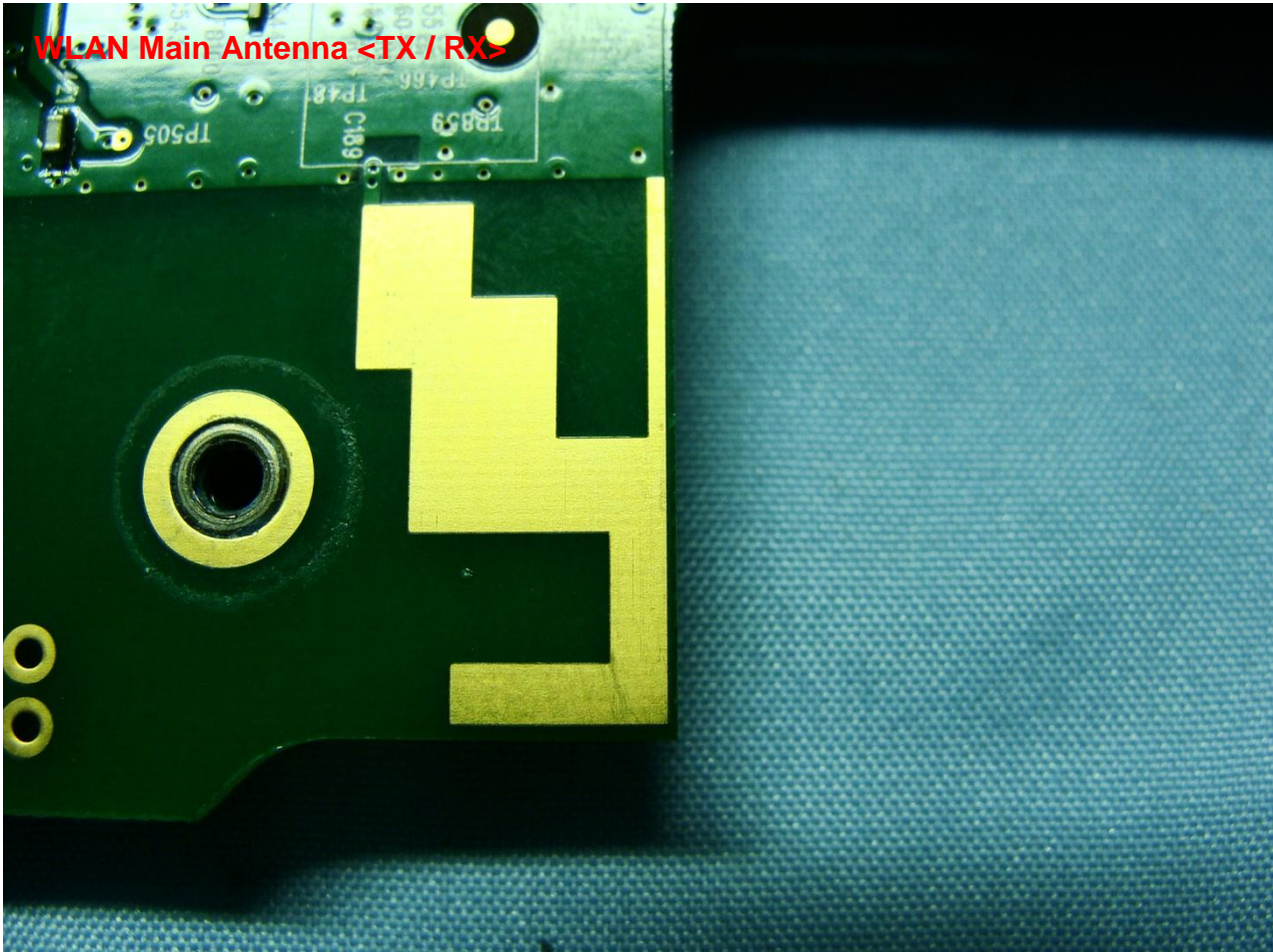



Brand Name: DAP / Model Name: 9000WBWZV1 / Marketing Name: M9010

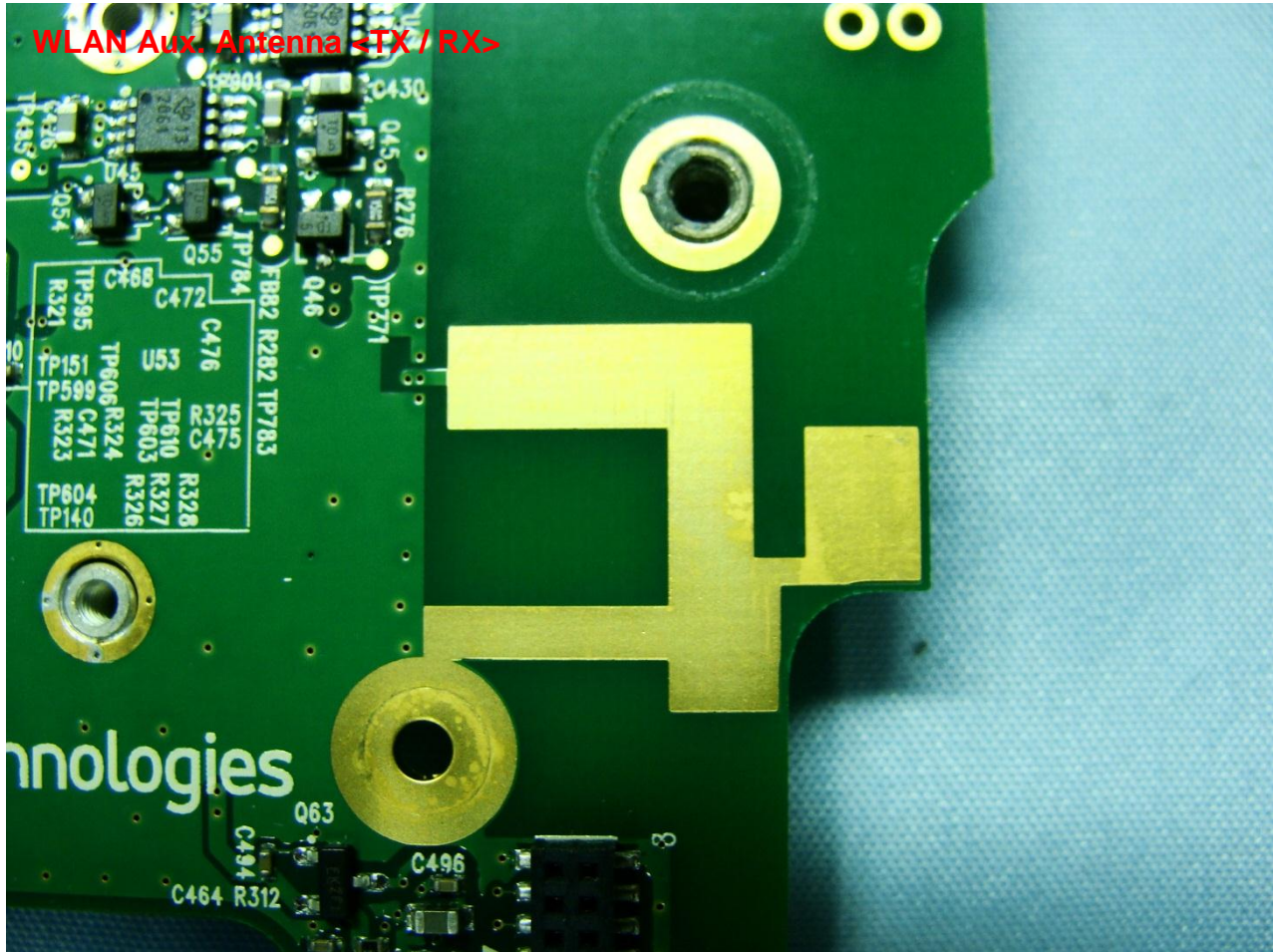

Brand Name: DAP / Model Name: 9000WBWZV1 / Marketing Name: M9010

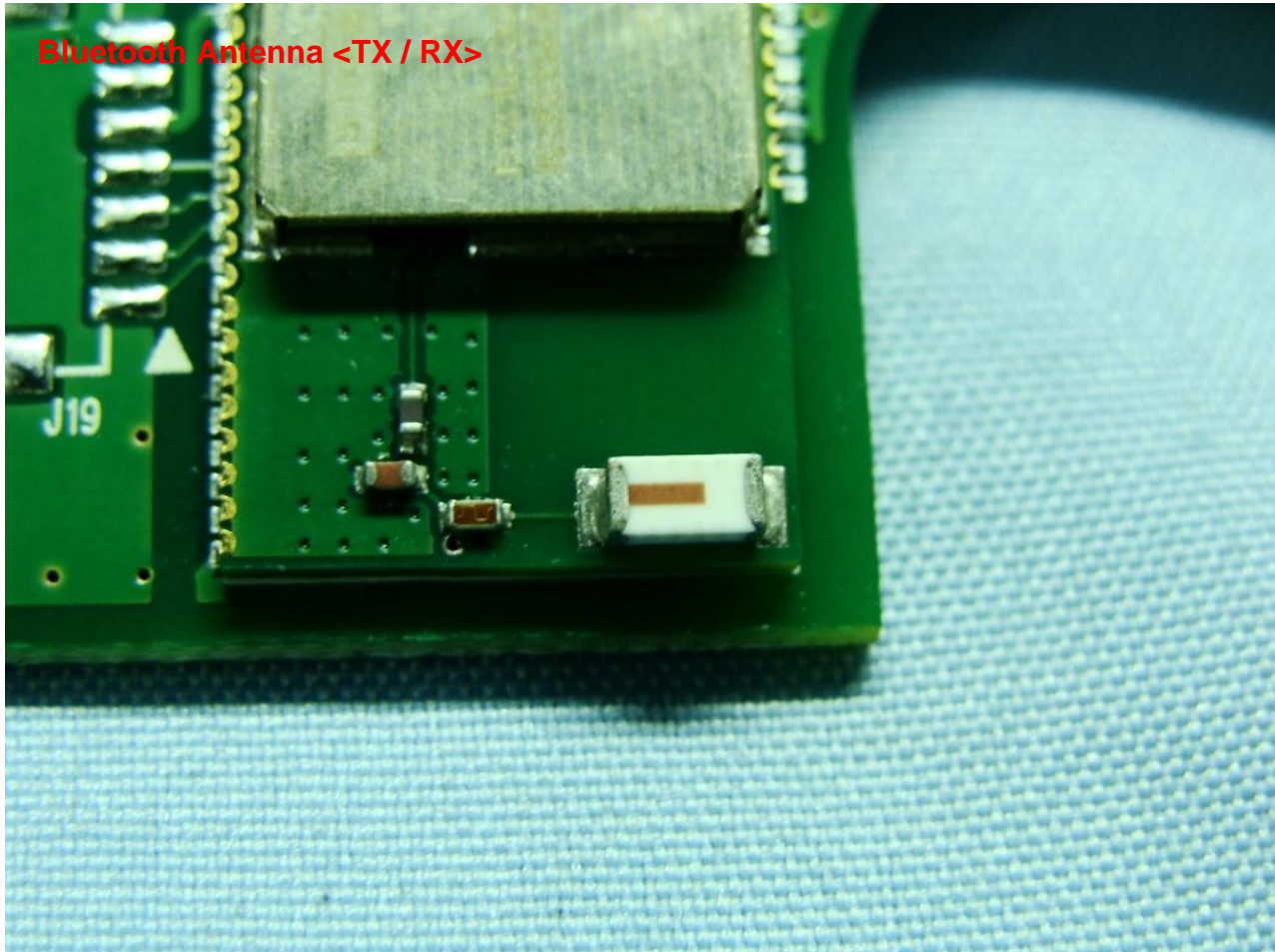

Brand Name: DAP / Model Name: 9000WBWZV1 / Marketing Name: M9010

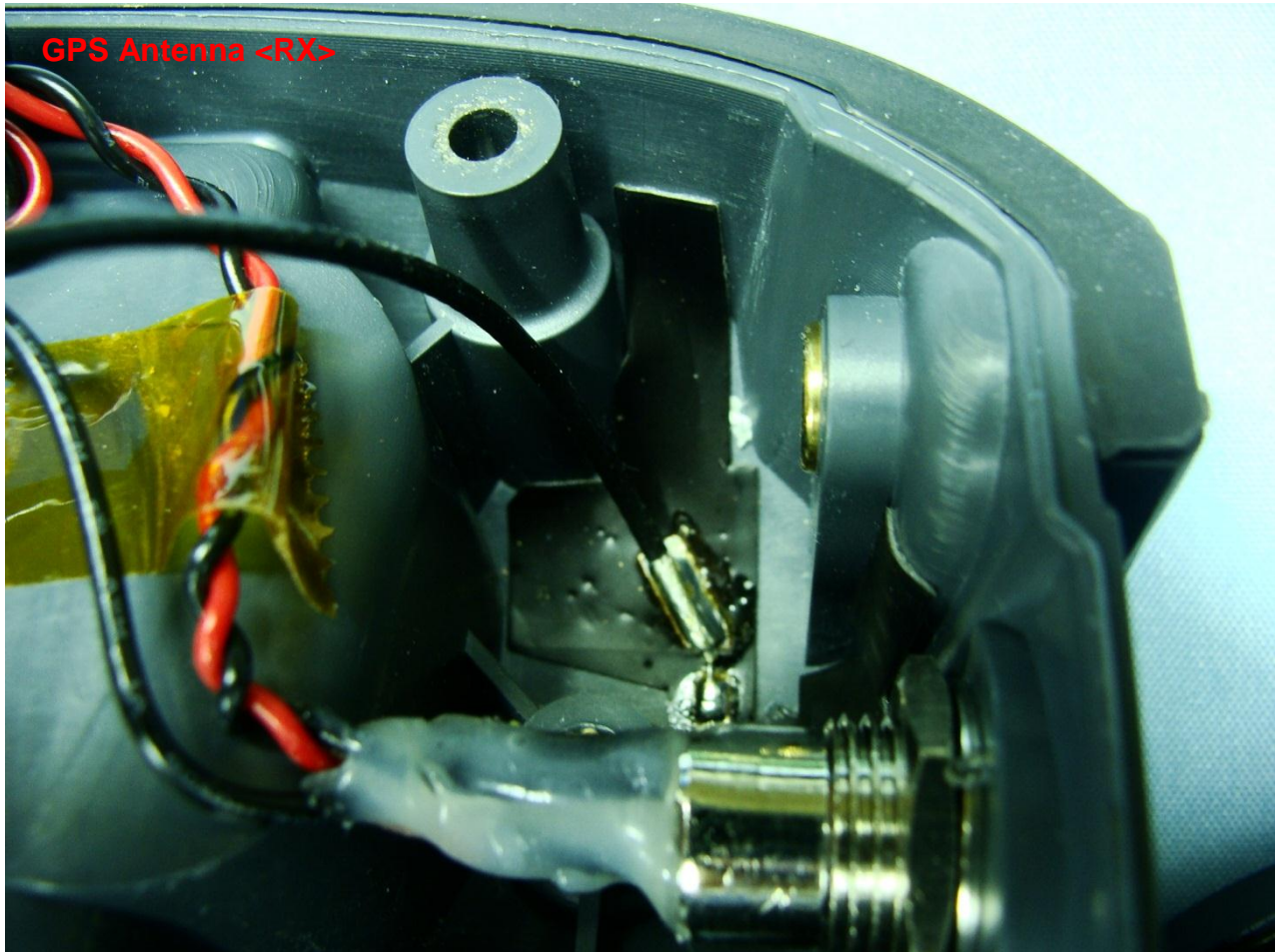

Brand Name: DAP / Model Name: 9000WBWZV1 / Marketing Name: M9010

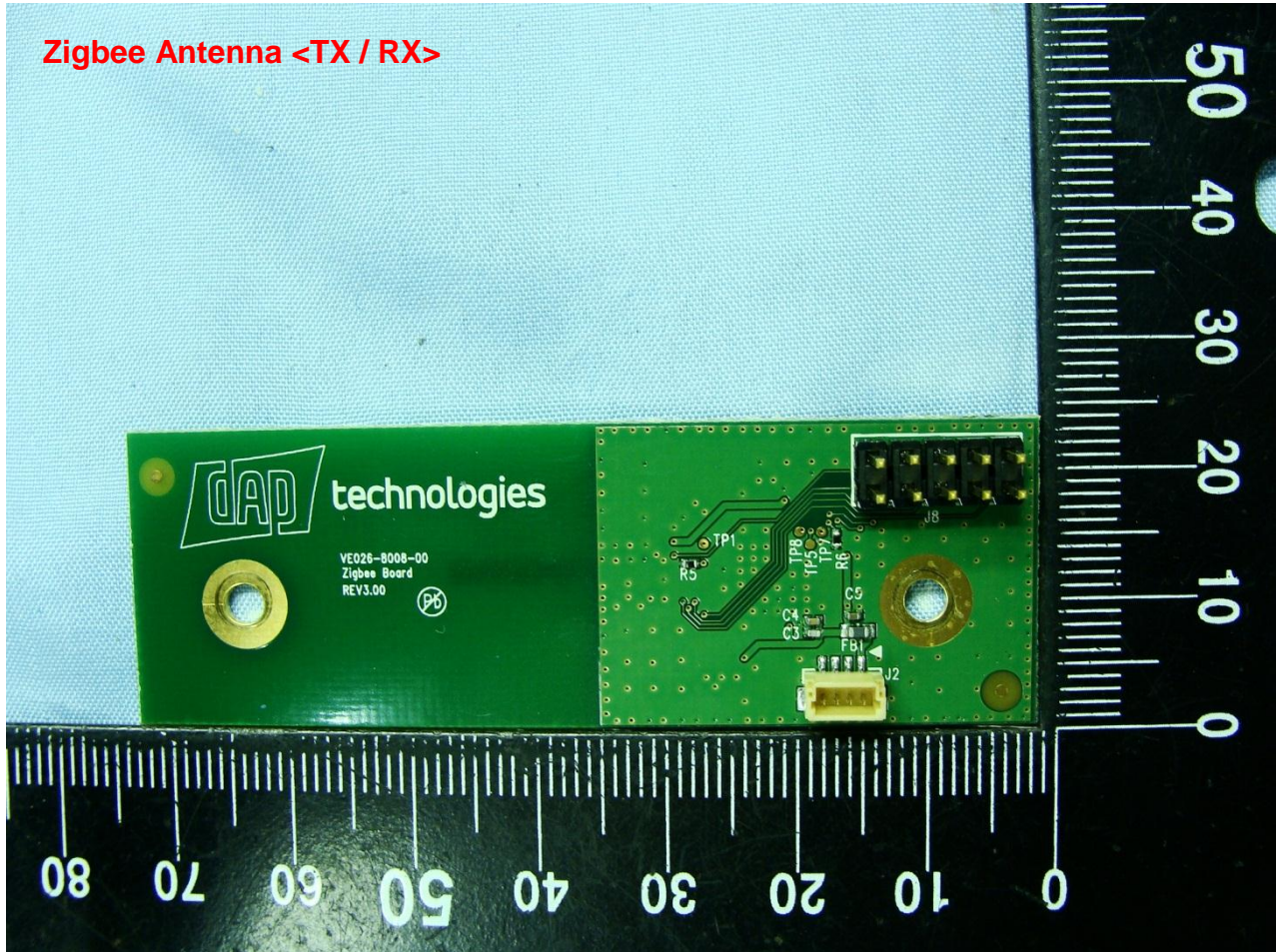



Brand Name: DAP / Model Name: 9000WBWZV1 / Marketing Name: M9010

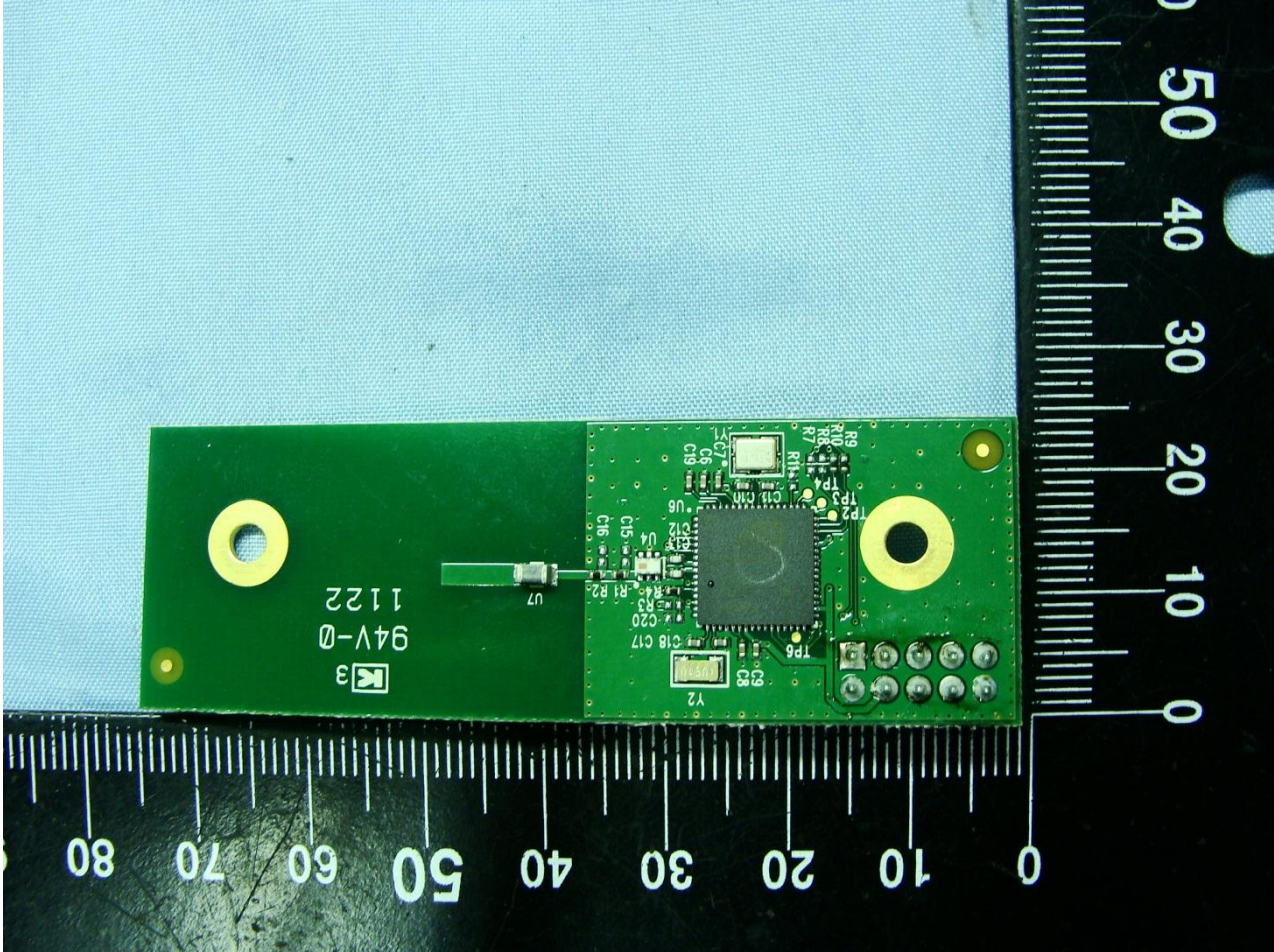

## Appendix B. Setup Photographs

### <Conducted Emission>

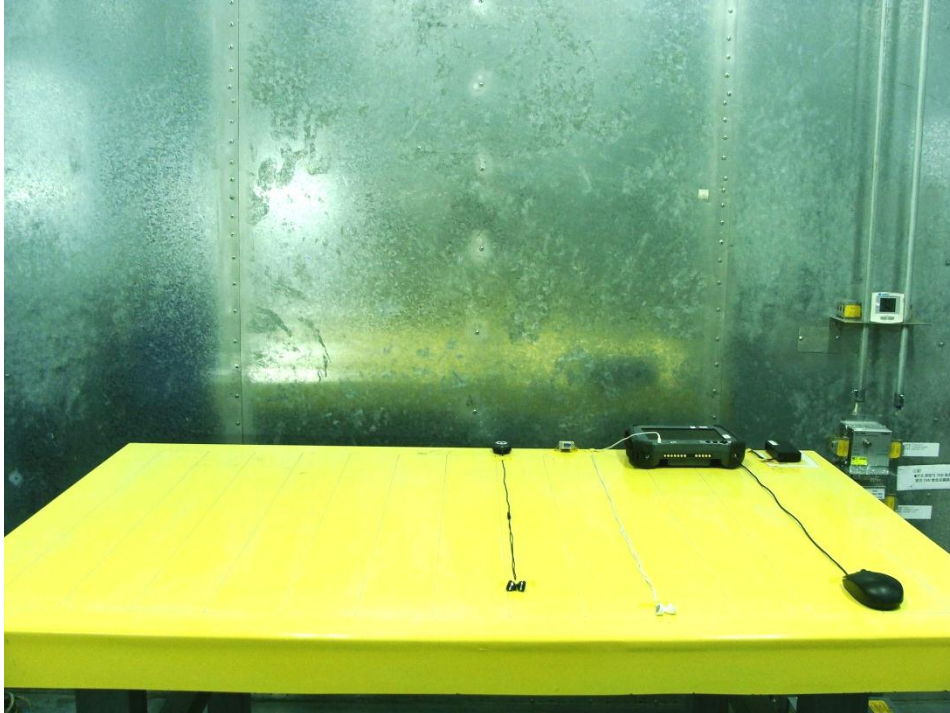

<Radiated Emission>

LF

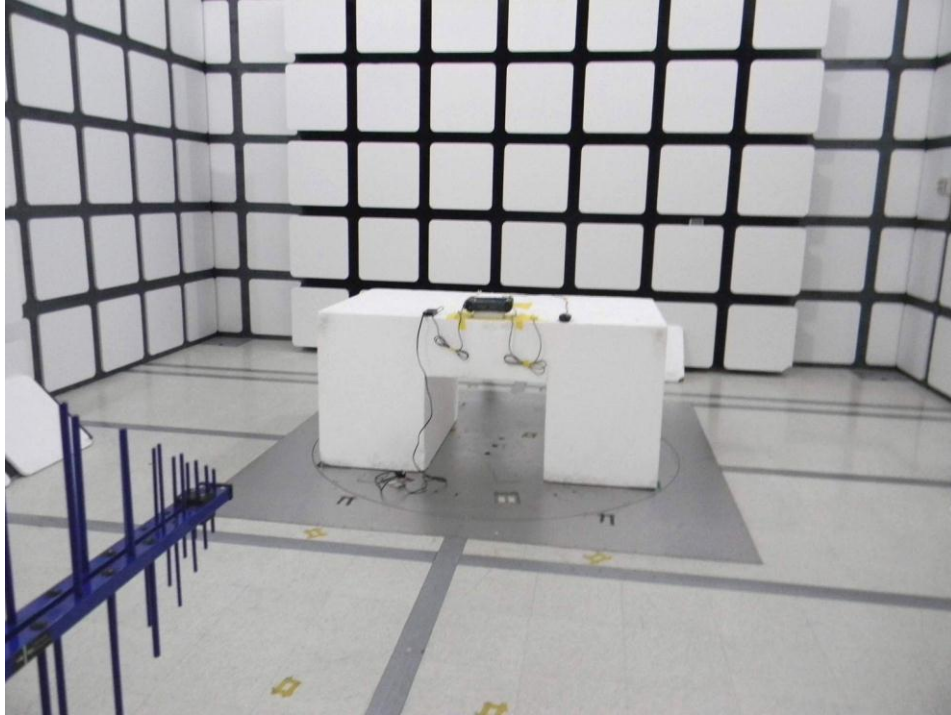

HF

