



## **MC8790 Test Report**

FCC Part 22, 24 / IC RSS 132, 133

FOR

FCC and IC Certifications

**IC: 2417C-MC8790**  
**FCC ID: N7NMC8790**

Prepared by  
SIERRA WIRELESS INC.  
13811 WIRELESS WAY  
RICHMOND, BC V6V 3A4  
CANADA

© 2008 Sierra Wireless, Inc.

This document contains information which is proprietary and confidential to Sierra Wireless, Inc. Disclosure to persons other than the officers, employees, agents, or subcontractors of the Company or licensee of this document without the prior written permission of Sierra Wireless, Inc. is strictly prohibited.

# SIERRA WIRELESS, INC.

FCC Part 22, 24 / RSS 132, 133	MC8790	April 29, 2008	Page 2 of 77
--------------------------------	--------	----------------	--------------

## Table of Contents

1	Introduction and Purpose.....	3
2	Test Summary .....	3
3	Description of Equipment Under Test .....	4
4	RF Power Output .....	4
4.1	<i>Test Procedure</i> .....	4
4.2	<i>Test Equipment</i> .....	5
4.3	<i>Test Results GSM/EDGE</i> .....	5
4.4	<i>Test Results UMTS</i> .....	5
4.4.1	<i>Test 1: RF Output Power Results for WCDMA R99</i> .....	5
4.4.2	<i>Test 2: RF Output Power Results for HSDPA Rel6</i> .....	6
4.4.3	<i>Test 3: RF Output Power Results for HSPA (HSDPA &amp; HSUPA) Rel6</i> .....	8
4.5	<i>Test Settings for UMTS Mode on CMU200</i> .....	10
5	Occupied Bandwidth.....	14
5.1	<i>Test Procedure</i> .....	14
5.2	<i>Test Results</i> .....	14
5.3	<i>Test Plots</i> .....	15
6	Out of Band Emissions at Antenna Terminals .....	24
6.1	<i>Test Procedure</i> .....	24
6.2	<i>Test Equipment</i> .....	24
6.3	<i>Test Results</i> .....	24
6.4	<i>Test Plots</i> .....	26
7	Block Edge Compliance.....	62
7.1	<i>Test Procedure</i> .....	62
7.2	<i>Test Equipment</i> .....	62
7.3	<i>Test Results</i> .....	62
7.4	<i>Test Plots</i> .....	63
8	Frequency Stability Versus Temperature.....	69
8.1	<i>Summary of Results</i> .....	69
8.2	<i>Test Procedure</i> .....	69
8.3	<i>Test Equipment</i> .....	69
8.4	<i>Test Results</i> .....	70
9	Frequency Stability Versus Voltage .....	74
9.1	<i>Summary of Results</i> .....	74
9.2	<i>Test Procedure</i> .....	74
9.3	<i>Test Equipment</i> .....	74
9.4	<i>Test Results</i> .....	75

## SIERRA WIRELESS, INC.

FCC Part 22, 24 / RSS 132, 133	MC8790	April 29, 2008	Page 3 of 77
--------------------------------	--------	----------------	--------------

### 1 Introduction and Purpose

This document provides the MC8790 wireless modem test data for the FCC and Industry Canada certifications. The tests included in this report are limited to all conducted tests required. The radiated tests were performed at an external test facility.

### 2 Test Summary

FCC RULE	DESCRIPTION OF TEST	RESULT	PAGE
2.1046	RF Power Output	Complies	5
2.1049	Occupied Bandwidth	Complies	14
2.1051, 22.901(d) 22.917, 24.238(a)	Out of Band Emissions at Antenna Terminals	Complies	24
FCC Part 22H/24E	Block Edge Requirements	Complies	62
2.1053	Field Strength of Spurious Radiation	Complies	See CCS Report
2.1055	Frequency Stability versus Temperature	Complies	69
2.1055	Frequency Stability versus Voltage	Complies	74

The tests described in this report were performed by Mr. Hari Shankar Shukla at:

Sierra Wireless, Inc.  
13811 Wireless Way  
Richmond, B.C. V6V 3A4  
Canada

© 2008 Sierra Wireless, Inc.

The contents of this page are subject to the confidentiality information on page one.

## SIERRA WIRELESS, INC.

### 3 Description of Equipment Under Test

The Sierra Wireless Inc. model MC8790 is a multi-band wireless modem operating on the GSM/GPRS/EDGE/UMTS network. In the US and Canada, only cellular and PCS bands are used for GSM/GPRS/UMTS operation, so this test report only contains data for these two bands (850MHz and 1900MHz).

### 4 RF Power Output

FCC 2.1046

#### 4.1 Test Procedure

The transmitter output was connected to a Rohde & Schwarz CMU200 Test Set and configured to operate at maximum power in a call. The power was measured using the spectrum analyzer at three equally spaced operating frequencies for each band. The RBW was set to 300 KHz for the GSM and EDGE measurements, and 5MHz for the WCDMA measurements. The spectrum analyzer was set to measure the RF output power with the cable and coupler losses accounted for.

#### Test Setup

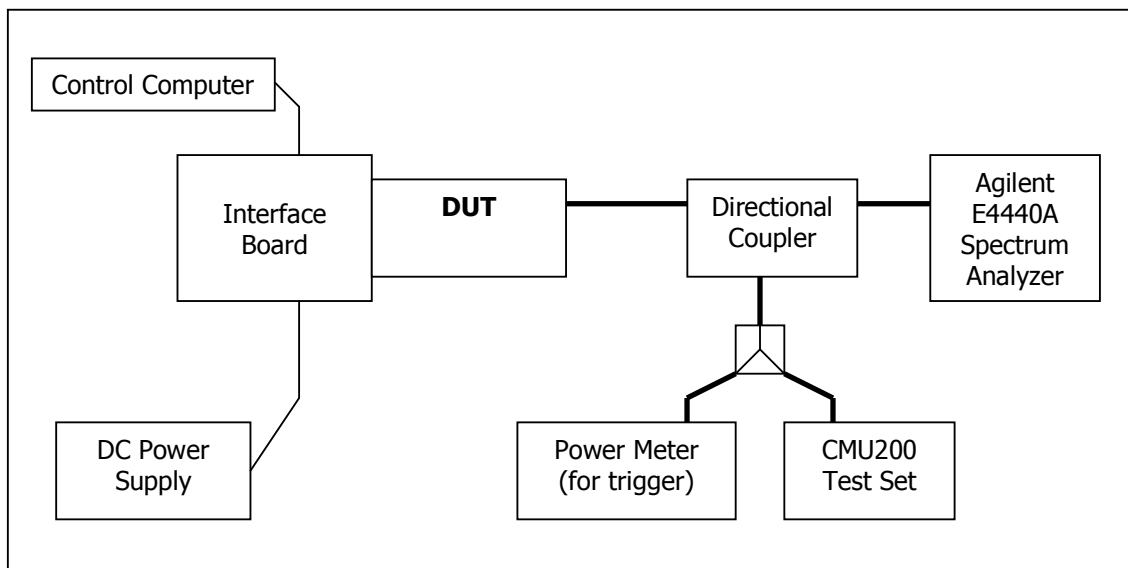

## SIERRA WIRELESS, INC.

FCC Part 22, 24 / RSS 132, 133	MC8790	April 29, 2008	Page 5 of 77
--------------------------------	--------	----------------	--------------

### 4.2 Test Equipment

#### Instrument List

EQUIPMENT	MANUFACTURER	MODEL NO.	SERIAL NO.	CAL. DATE
Control Computer	TC	Generic PC	100488	N/A
Wireless Test Set	Rohde & Schwarz	CMU200	111682	November 18, 2008
Spectrum Analyzer	Agilent	PSA E4440A	US41421268	March 11, 2008
DC Power Supply	HP	E3631A	3530A	N/A
Interface Board	Shop built	Minnow	N/A	N/A
Directional Coupler	Mini-Circuits	ZA3PD-2	N/A	N/A

### 4.3 Test Results GSM/EDGE

Frequency (MHz)	Channel	Power (dBm)	
		GMSK Mode	8-PSK Mode
824.2	128	31.83	27.11
836.6	190	31.79	27.05
848.8	251	31.50	26.77
1850.2	512	28.71	25.87
1880.0	661	28.63	25.81
1909.8	810	28.59	25.79

### 4.4 Test Results UMTS

#### 4.4.1 Test 1: RF Output Power Results for WCDMA R99

The following tests were completed according to the test requirements outlined in section 5.2 of the 3GPP TS34.121-1 V7.5.0 specification. The MC8790 supports power Class 3, which has a nominal maximum output power of 24 dBm (+1.7/-3.7).

The test was performed according to section 5.2 of the 3GPP TS34.121-1 V7.5.

Frequency (MHz)	Channel	WCDMA R99	
		RMS Power (dBm)	Peak Power (dBm)
826.4	4132	22.76	26.21
836.4	4182	23.09	26.52
846.6	4233	22.80	26.29
1852.4	9262	23.31	26.58
1880.0	9400	23.23	26.47
1907.6	9538	23.12	26.45

Note: The results above reflect max power with all up bits.

© 2008 Sierra Wireless, Inc.

The contents of this page are subject to the confidentiality information on page one.

## SIERRA WIRELESS, INC.

FCC Part 22, 24 / RSS 132, 133	MC8790	April 29, 2008	Page 6 of 77
--------------------------------	--------	----------------	--------------

### 4.4.2 Test 2: RF Output Power Results for HSDPA Rel6

The MC8790 supports Category 8 FDD HS-DSCH physical layer. As stated in the 3GPP TS25.306 V7.3.0 Table 5.1a, the details of Category 8 are as follows:

- Maximum of 10 E-DSCH received codes
- Minimum 1 inter-TTI interval
- Maximum 14411bits in an E-DSCH transport block received within an E-DSCH TTI
- Total number of soft channel bits is 134400
- Support of QPSK and 16QAM

A detailed list of all settings used is included at the end of this report in section 6.0

The following Sub-Tests were completed according to the test requirements outlined in section 5.2A of the 3GPP TS34.121-1 V7.5.0 specification. All TX RMS and Peak power requirements for Power Class 3 were met according to table 5.2AA.5 and achieved through the outlined test procedure in section 5.2AA.4.2. All UE channels and power ratio's are set according to table C10.1.4 in the 3GPP TS34.121-1 V7.5.0 specification. A summary of these settings are illustrated below:

Subtest	Mode	Call Type	RMC (kbps)	HSDPA FRC	Power Class 3 Max Limit dBm	$\beta_c/\beta_d$	$\beta_{hs}$	CM (db)	MPR (db)
1	HSDPA	PS	12.2	H-Set 1 QPSK	24 (+1.7/-3.7 db)	2 /15	4/15	0.0	0.0
2	HSDPA	PS	12.2	H-Set 1 QPSK	24 (+1.7/-3.7 db)	12 /15	24/15	1.0	0.0
3	HSDPA	PS	12.2	H-Set 1 QPSK	23.5 (+2.2/-3.7 db)	15 /8	30/15	1.5	0.5
4	HSDPA	PS	12.2	H-Set 1 QPSK	23.5 (+2.2/-3.7 db)	15 /4	30/15	1.5	0.5

#### 4.4.2.1 Sub-Test 1

$\beta_c=2/15$ ,  $\beta_d=15/15$ ,  $\beta_{hs}=4/15$

Frequency (MHz)	Channel	Power (dBm)	
		RMS	Peak
826.4	4132	22.48	25.76
836.4	4182	22.74	26.03
846.6	4233	22.45	25.88
1852.4	9262	22.82	26.17
1880.0	9400	22.77	26.01
1907.6	9538	22.80	26.06

© 2008 Sierra Wireless, Inc.

The contents of this page are subject to the confidentiality information on page one.

**SIERRA WIRELESS, INC.**

4.4.2.2 *Sub-Test 2*

$\beta_c=12/15, \beta_d=15/15, \beta_{hs}=24/15$

Frequency (MHz)	Channel	Power (dBm)	
		RMS	Peak
826.4	4132	22.43	25.49
836.4	4182	22.67	25.82
846.6	4233	22.49	25.48
1852.4	9262	22.88	25.89
1880.0	9400	22.68	25.97
1907.6	9538	22.45	25.91

4.4.2.3 *Sub-Test 3*

$\beta_c=15/15, \beta_d=15/8, \beta_{hs}=30/15$

Frequency (MHz)	Channel	Power (dBm)	
		RMS	Peak
826.4	4132	22.34	25.71
836.4	4182	22.65	25.86
846.6	4233	22.27	25.52
1852.4	9262	22.67	26.03
1880.0	9400	22.75	26.11
1907.6	9538	22.54	25.86

4.4.2.4 *Sub-Test 4*

$\beta_c=15/15, \beta_d=4/15, \beta_{hs}=30/15$

Frequency (MHz)	Channel	Power (dBm)	
		RMS	Peak
826.4	4132	22.42	25.65
836.4	4182	22.69	25.77
846.6	4233	21.60	25.69
1852.4	9262	22.71	26.12
1880.0	9400	22.58	25.99
1907.6	9538	22.61	25.96

## SIERRA WIRELESS, INC.

FCC Part 22, 24 / RSS 132, 133	MC8790	April 29, 2008	Page 8 of 77
--------------------------------	--------	----------------	--------------

### 4.4.3 Test 3: RF Output Power Results for HSPA (HSDPA & HSUPA) Rel6

The MC8790 supports Category 5 FDD E-DCH physical layer. As stated in the 3GPP TS25.306 V7.3.0 Table 5.1g, the details of Category 5 are as follows:

- Maximum of 2 E-DCH transmitted codes
- Minimum spreading factor of SF2
- Support for only 10 ms TTI E-DCH
- Maximum 20000 bits in an E-DCH transport block within a 10 ms E-DCH TTI
- Data rate of 2 Mbps
- Support of QPSK only

A detailed list of all settings used is included at the end of this report in section 6.0

The following 5 Sub-Tests were completed according to the test requirements outlined in section 5.2B of the 3GPP TS34.121-1 V7.5.0 specification. All TX RMS and Peak power requirements were met according to table 5.2B.5 and achieved through the outlined test procedure in section 5.2B.4.2. All UE channels and power ratio's are set according to table C11.1.3 in the 3GPP TS34.121-1 V7.5.0 specification. A summary of these settings are illustrated below:

Subtest	Mode	Call Type	RMC (kbps)	HSDPA FRC	Power Class 3 Max Limit dBm	$\beta_c/\beta_d$	$\beta_{hs}$	$\beta_{ed}$	CM (db)	MPR (db)
1	HSPA	PS	12.2	H-Set 1 QPSK	24 (+1.7/-5.2 db)	11 /15	22/15	209/225	1.0	0.0
2	HSPA	PS	12.2	H-Set 1 QPSK	22 (+3.7/-5.2 db)	6 /15	12/15	12/15	3.0	2.0
3	HSPA	PS	12.2	H-Set 1 QPSK	23 (+2.7/-5.2 db)	15 /15	30/15	30/15	2.0	1.0
4	HSPA	PS	12.2	H-Set 1 QPSK	22 (+1.7/-5.2 db)	15 /9	4/15	2/15	3.0	2.0
5	HSPA	PS	12.2	H-Set 1 QPSK	24 (+1.7/-5.2 db)	15/15	30/15	24/15	1.0	0.0

#### 4.4.3.1 Sub-Test 1:

$\beta_c=11/15$ ,  $\beta_d=15/15$ ,  $\beta_{hs}=22/15$ ,  $\beta_{ec}=209/225$ ,  $\beta_{ed}=1039/225$ , AG=20, 1xSF4, E-TFCI=75.

Frequency (MHz)	Channel	Power (dBm)	
		RMS	Peak
826.4	4132	22.37	25.66
836.4	4182	22.63	25.97
846.6	4233	22.41	25.78
1852.4	9262	22.86	26.27
1880.0	9400	22.61	26.13
1907.6	9538	22.78	25.98

© 2008 Sierra Wireless, Inc.

The contents of this page are subject to the confidentiality information on page one.



**SIERRA WIRELESS, INC.**

4.4.3.2 *Sub-Test 2:*

$\beta_c=6/15$ ,  $\beta_d=15/15$ ,  $\beta_{hs}=12/15$ ,  $\beta_{ec}=12/15$ ,  $\beta_{ed}=94/75$ , AG=12, 1xSF4, E-TFCI=67.

Frequency (MHz)	Channel	Power (dBm)	
		RMS	Peak
826.4	4132	22.01	25.77
836.4	4182	22.46	25.92
846.6	4233	22.11	25.69
1852.4	9262	22.63	26.19
1880.0	9400	22.66	26.21
1907.6	9538	22.46	26.02

4.4.3.3 *Sub-Test 3:*

$\beta_c=15/15$ ,  $\beta_d=15/15$ ,  $\beta_{hs}=30/15$ ,  $\beta_{ec}=30/15$ ,  $\beta_{ed}=47/15$ , AG=15, 2xSF4. E-TFCI=92,  
Note: # of Reference E-TFCI=2.

Frequency (MHz)	Channel	Power (dBm)	
		RMS	Peak
826.4	4132	22.18	25.62
836.4	4182	22.33	25.84
846.6	4233	22.11	25.67
1852.4	9262	22.65	26.12
1880.0	9400	22.60	26.00
1907.6	9538	22.53	25.96

4.4.3.4 *Sub-Test 4:*

$\beta_c=2/15$ ,  $\beta_d=15/15$ ,  $\beta_{hs}=4/15$ ,  $\beta_{ec}=2/15$ ,  $\beta_{ed}=56/75$ , AG=17, 1xSF4, E-TFCI=71.

Frequency (MHz)	Channel	Power (dBm)	
		RMS	Peak
826.4	4132	22.09	25.51
836.4	4182	22.25	25.70
846.6	4233	22.11	25.59
1852.4	9262	22.69	26.15
1880.0	9400	22.51	25.93
1907.6	9538	22.72	26.08

4.4.3.5 *Sub-Test 5:*

$\beta_c=15/15$ ,  $\beta_d=15/15$ ,  $\beta_{hs}=30/15$ ,  $\beta_{ec}=24/15$ ,  $\beta_{ed}=134/15$ , AG=21, 1xSF4, E-TFCI=81.

Frequency (MHz)	Channel	Power (dBm)	
		RMS	Peak
826.4	4132	21.99	25.53
836.4	4182	22.21	25.77
846.6	4233	22.05	25.61
1852.4	9262	22.71	26.26
1880.0	9400	22.64	26.07
1907.6	9538	22.65	26.00

## SIERRA WIRELESS, INC.

FCC Part 22, 24 / RSS 132, 133	MC8790	April 29, 2008	Page 10 of 77
--------------------------------	--------	----------------	---------------

### *4.5 Test Settings for UMTS Mode on CMU200*

#### UE Power Control Settings

Maximum allowable UE-Power = 24.0 dBm

UL Target Power = 24.0 dBm

#### Node B Settings

Primary Scrambling Code = 9

Output Channel Power = -51.7 dBm

OCNS = Off

Total Output Power (Ior+Ioc) = -51.7 dBm

#### RMC Settings

Reference Channel Type: 12.2 kbps Downlink/Uplink

DL DTCH Transport Format: 12.2 kbps

DL Resources in Use: 100 %

UL CRC (Sym. Loop Mode 2): Off

Test Mode: Loop Mode 2

Channel Data Source DTCH: PRBS9

#### Voice Settings

Voice Source: Echo

Loopback Type: Off

#### Adaptive Multirate Settings

Active Code Set: Selection A

Codec Mode: 12.2 kbps

#### Signaling RAB Settings

SRB Cell DCH: 3.4 kbps

#### BS Down Link Physical Channels Settings

Ior = -51.7 dBm

P-CPICH = -3.3 dB

P-SCH = -8.3 dB

S-SCH = -8.3 dB

P-CCPCH = -5.3 dB

S-CCPCH = -5.3 dB

S-CCPCH Channel Code = 2

PICH = -8.3 dB

PICH Channel Code = 3

AICH = -8.3 dB

© 2008 Sierra Wireless, Inc.

The contents of this page are subject to the confidentiality information on page one.

## SIERRA WIRELESS, INC.

FCC Part 22, 24 / RSS 132, 133	MC8790	April 29, 2008	Page 11 of 77
--------------------------------	--------	----------------	---------------

AICH Channel Code = 6  
DPDCH = -10.3 dB  
DPDCH Channel Code = 96  
Power Offset (DPCCH/DPDCH) = 0.0 dB  
DL DPCH Timing Offset = 0  
Secondary Scrambling Code = 0  
Secondary Scrambling Code (HSDPA) = 0  
HSDPA Channels = On

### TPC Settings

Algorithm = 2  
TPC Step Size = 1dB  
TPC Pattern Setup = Set 1 (All 1, after linked to get maximum power)

### **HSDPA Mode Settings:**

#### Node B Settings

Primary Scrambling Code = 9  
Output Channel Power = -86 dBm  
OCNS = Off  
Total Output Power (Ior+Ioc) = -86 dBm

### Network Settings

Packet Switched Domain = ON

### HSDPA Test Mode Settings

Radiobearer Setup = RMC 12.2 kbps + HSPDA  
RMC Test Loop = Loop Mode 1 RLC TM

### HSDPA HS-DSCH

CQI Feedback Cycle = 4ms  
CQI Repetition Factor = 2  
ACK/NACK Repetition Factor = 3  
UE Category = 8  
Channel Configuration Type = FRC  
H-Set Selection = H-Set 1 QPSK  
RV Coding Sequence {0,2,5,6}

HSDPA Gain Factors are set according to each specific sub-test in table C.10.1.4 of 3GPP TS 34.121.

© 2008 Sierra Wireless, Inc.

The contents of this page are subject to the confidentiality information on page one.

## SIERRA WIRELESS, INC.

FCC Part 22, 24 / RSS 132, 133	MC8790	April 29, 2008	Page 12 of 77
--------------------------------	--------	----------------	---------------

### HSPA Mode Settings:

#### UE Power Control Settings

Maximum allowable UE-Power = 24.0 dBm

UL Target Power: Set according to each specific sub-test in table 5.2B.5 of 3GPP TS 34.121 less 5db for starting point.

#### UE Packet Data Gain Factors

Bc and Bd: \*

$\Delta\text{ACK}, \Delta\text{NACK}, \Delta\text{CQI}=8$

### HSUPA

E-DCH Physical Layer Category = 5

E-TFCI Table Index = 1

Minimum Set E-TFCI = 1\*

Maximum Channelisation Code: 1xSF4 or 2xSF4\*

Initial Service Grant: \*

#### UE Gain Factors

$\Delta\text{E-DPCCH}$ : \*

Number of Reference E-TFCIs: \*\*

Reference E-TFCI's: \*\*

E-TFCI Power offsets: \*\*

#### Node B Settings

Primary Scrambling Code = 9

Output Channel Power = -86 dBm

OCNS = Off

Total Output Power (Ior+Ioc) = -86 dBm

#### Paket Switched

DCH Type: HSUPA Test Mode

Data Rate: HSDPA/HSUPA

#### HSDPA Test Mode Settings

Radiobearer Setup = RMC 12.2kbps + HSDPA

RMC Test Loop = Loop Mode 1 RLC TM

#### HSDPA HS-DSCH

CQI Feedback Cycle = 4ms

CQI Repetition Factor = 2

ACK/NACK Repetition Factor = 3

UE Category = 8

Channel Configuration Type = FRC

H-Set Selection = H-Set 1 QPSK

RV Coding Sequence {0,2,5,6}

© 2008 Sierra Wireless, Inc.

The contents of this page are subject to the confidentiality information on page one.

**SIERRA WIRELESS, INC.**

FCC Part 22, 24 / RSS 132, 133	MC8790	April 29, 2008	Page 13 of 77
--------------------------------	--------	----------------	---------------

HSUPA Test Mode Settings

Radiobearer Setup = SRB 3.4 + HSPA

HSUPA Settings

TTI mode: 10ms

E-AGCH

Pattern Length: 1

AG Value: \*

Downlink Physical Channels

HSUPA Channels: On

E-AGCH: -6.0db

E-AGCH Chan. Code: 6

E-RGCH/E-HICH: -5.0db

E-RGCH Active: Off

E-RGCH/E-HICH Chan. Code: 6

\*Set according to each specific sub-test in table C.11.1.3 of 3GPP TS 34.121.

\*\* Set according to each specific sub-test in table 5.2B.2/3 of 3GPP TS 34.121.

## 5 Occupied Bandwidth

FCC 2.1049

### 5.1 Test Procedure

The transmitter output was connected to a calibrated coaxial cable and coupler, the other end of which was connected to a spectrum analyzer. The occupied bandwidth (defined as the 99% Power Bandwidth) was measured with the spectrum analyzer at the 3 frequencies in each band. The -26dB bandwidth was also measured and recorded.

#### Test Setup

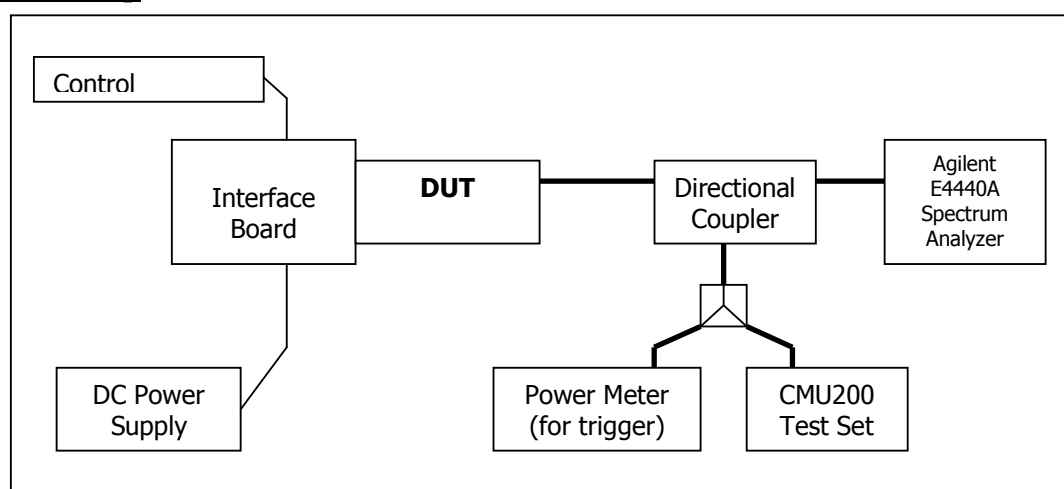

### 5.2 Test Results

The performance of the GSM 850 MHz Cellular band is shown in plots 5.3.1 to 5.3.6.

Performance of the GSM 1900 MHz PCS band is shown in plots 5.3.7 to 5.3.12.

Performance of the UMTS 850 Cellular band is shown in plots 5.3.13 to 5.3.15

Performance of the UMTS 1900 PCS band is shown in plots 5.3.16 to 5.3.18

Frequency (MHz)	Channel	99% Occupied Bandwidth (kHz)		-26dBc Occupied Bandwidth (kHz)	
		GMSK Mode	8-PSK Mode	GMSK Mode	8-PSK Mode
824.2	128	245.4	239.4	313.3	309.5
836.6	190	242.6	240.1	275.6	310.0
848.8	251	242.6	237.5	288.2	314.6
1850.2	512	246.5	236.1	292.3	301.9
1880.0	661	246.4	241.5	293.1	308.6
1909.8	810	246.0	243.1	294.8	309.5
Frequency (MHz)	Channel	99% Occupied Bandwidth (MHz)		-26dBc Occupied Bandwidth (MHz)	
826.4	4132	4.1686		4.5970	
836.4	4182	4.1649		4.6170	
846.6	4233	4.1502		4.6270	
1852.4	9262	4.1846		4.6360	
1880.0	9400	4.1787		4.6240	
1907.6	9538	4.1603		4.6190	

# SIERRA WIRELESS, INC.

## 5.3 Test Plots

### 5.3.1) GMSK Occupied Bandwidth, Cellular Low channel, 824.2 MHz, 99% bandwidth

Agilent 15:43:41 Nov 26, 2007

L

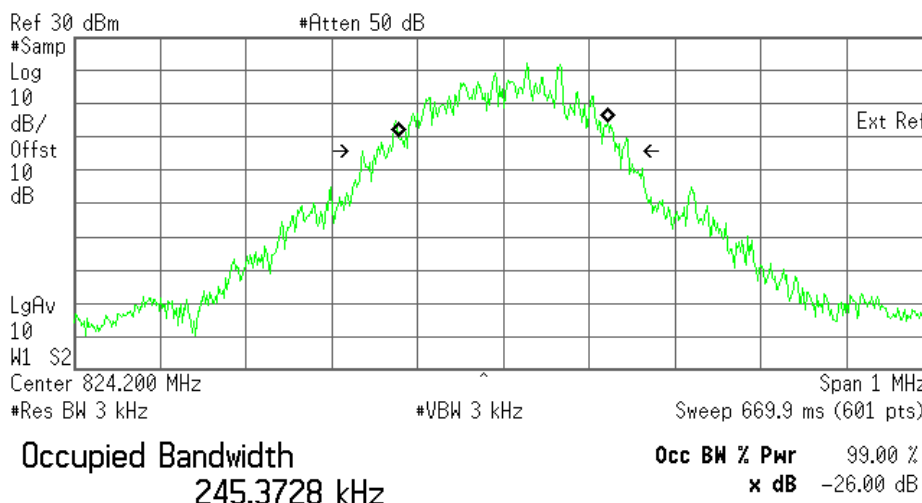

Transmit Freq Error -158.629 Hz  
 x dB Bandwidth 313.345 kHz\*

### 5.3.2) GMSK Occupied Bandwidth, Middle channel, 836.6 MHz, 99% bandwidth

Agilent 15:34:40 Nov 26, 2007

L

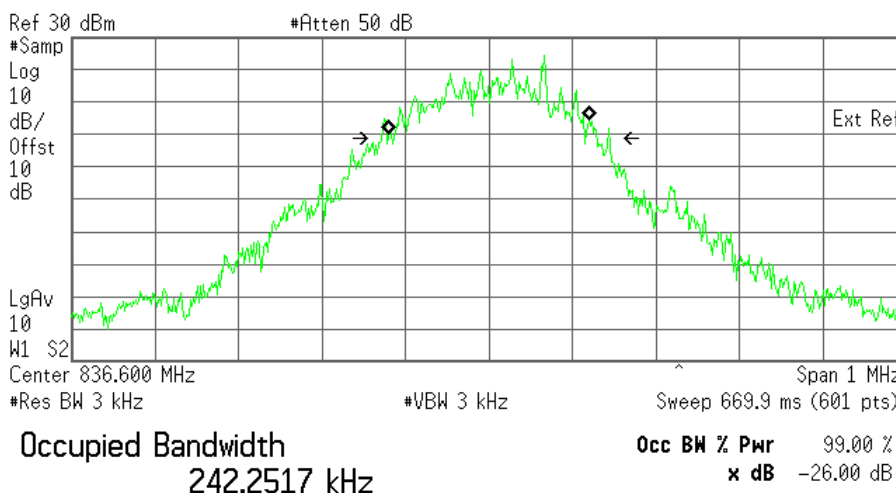

Transmit Freq Error 257.654 Hz  
 x dB Bandwidth 275.624 kHz\*

© 2008 Sierra Wireless, Inc.

The contents of this page are subject to the confidentiality information on page one.

**SIERRA WIRELESS, INC.**

**5.3.3) GMSK Occupied Bandwidth, High channel, 848.8 MHz, 99% bandwidth**

Agilent 15:39:26 Nov 26, 2007

L

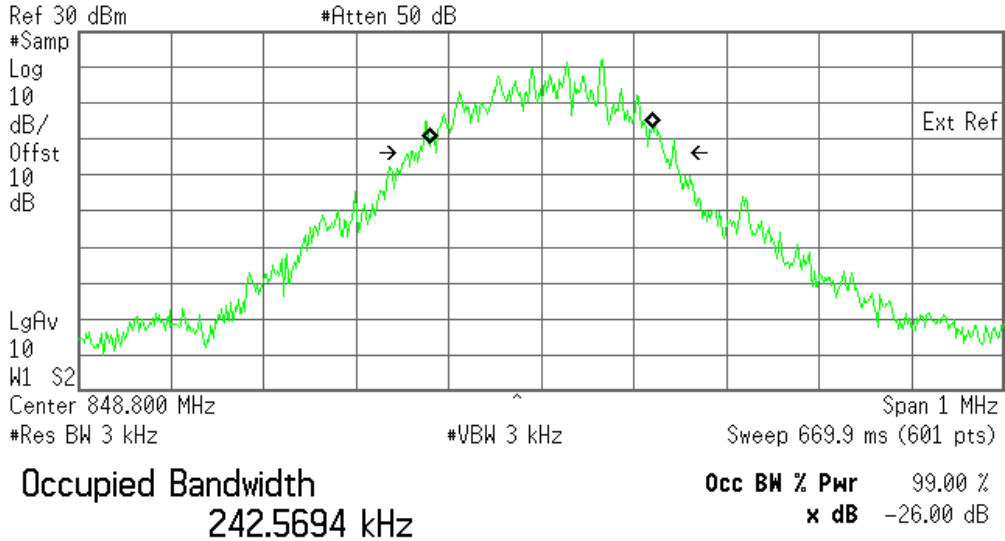

Transmit Freq Error 291.743 Hz  
x dB Bandwidth 288.182 kHz\*

**5.3.4) 8-PSK Occupied Bandwidth, Cellular Low channel, 824.2 MHz, 99% bandwidth**

Agilent 17:15:08 Nov 26, 2007

L

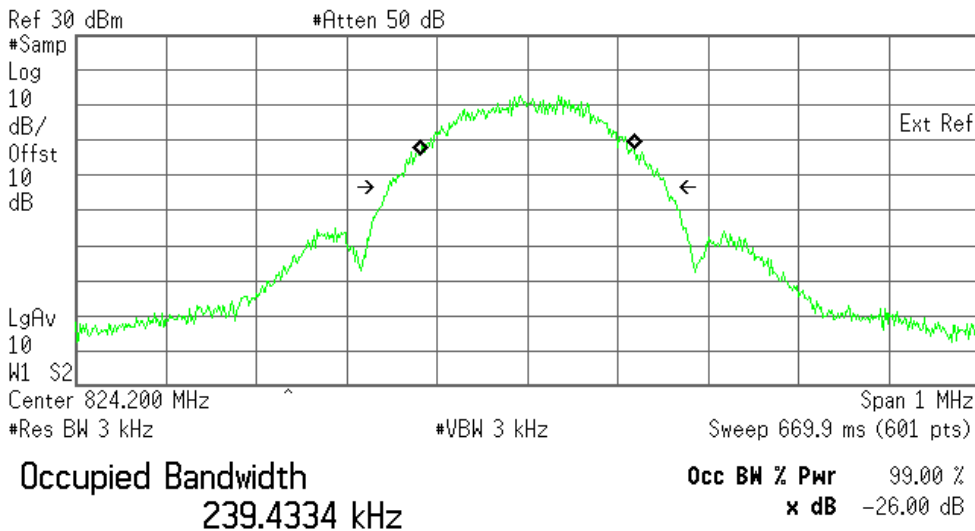

Transmit Freq Error 67.274 Hz  
x dB Bandwidth 309.526 kHz\*

© 2008 Sierra Wireless, Inc.

The contents of this page are subject to the confidentiality information on page one.



**SIERRA WIRELESS, INC.**

**5.3.5) 8-PSK Occupied Bandwidth, Middle channel, 836.6 MHz, 99% bandwidth**

\* Agilent 17:22:05 Nov 26, 2007

L

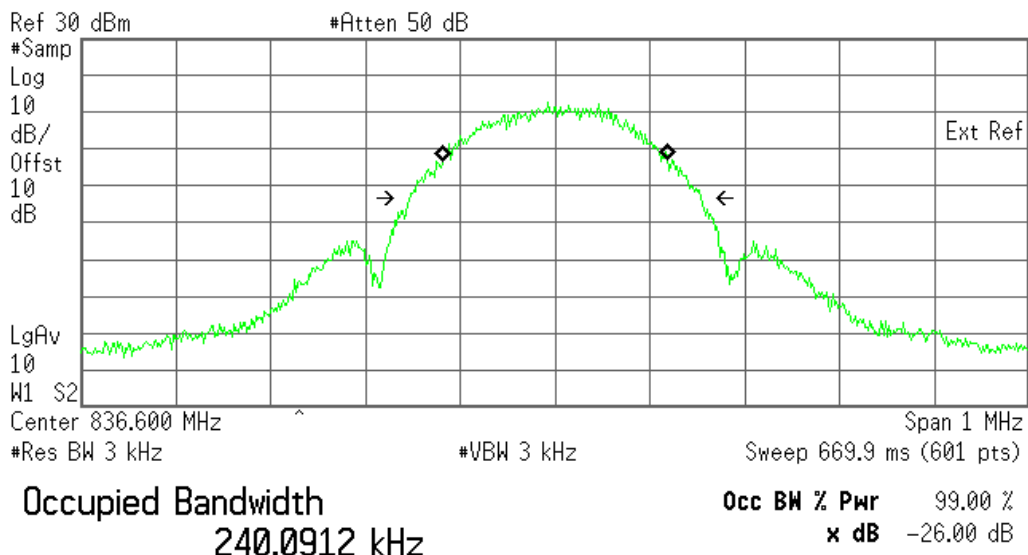

**Transmit Freq Error** 16.439 Hz  
**x dB Bandwidth** 309.958 kHz\*

**5.3.6) 8-PSK Occupied Bandwidth, High channel, 848.8 MHz, 99% bandwidth**

\* Agilent 17:32:34 Nov 26, 2007

L

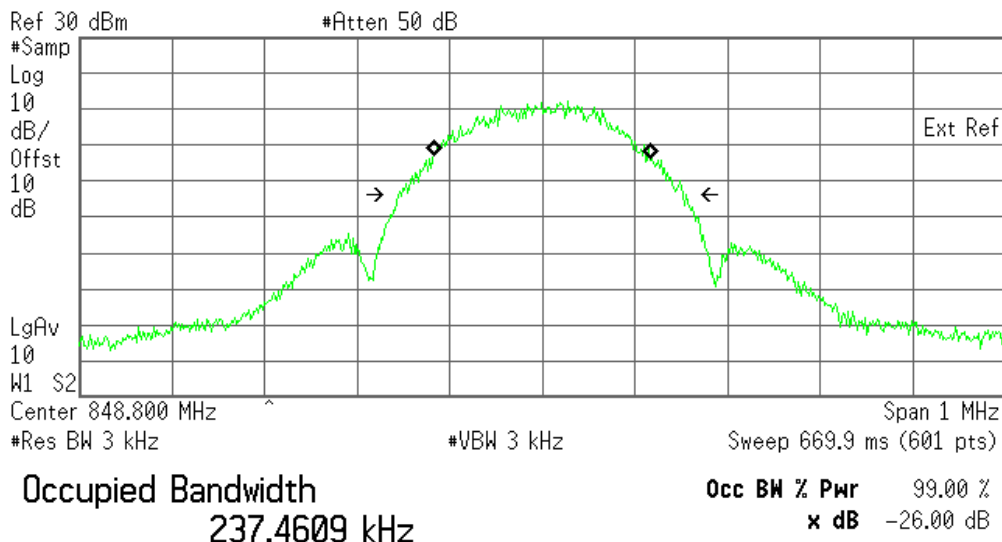

**Transmit Freq Error** 195.704 Hz  
**x dB Bandwidth** 314.572 kHz\*

© 2008 Sierra Wireless, Inc.

The contents of this page are subject to the confidentiality information on page one.

**SIERRA WIRELESS, INC.**

**5.3.7) GSMK Occupied Bandwidth, PCS Low channel, 1850.2 MHz, 99% bandwidth**

\* Agilent 15:51:15 Nov 26, 2007

L

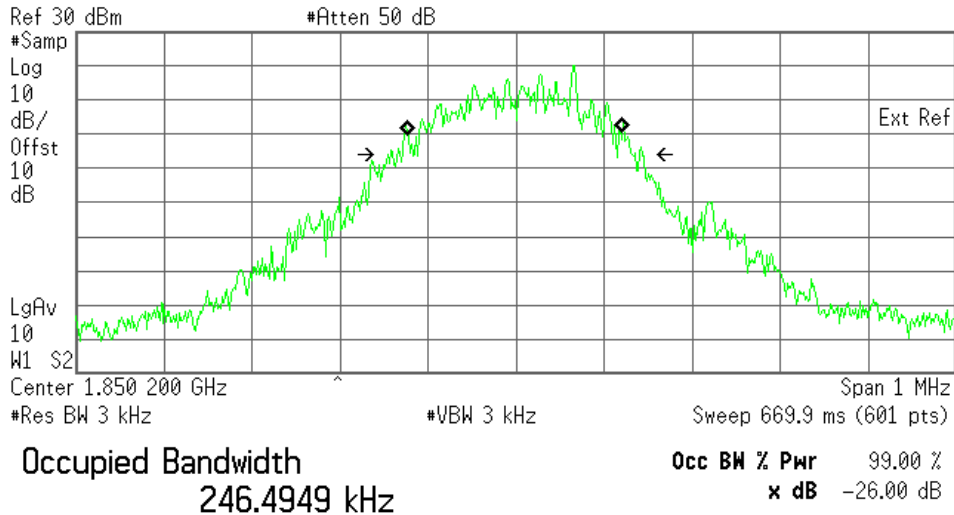

**Transmit Freq Error** -1.022 kHz  
**x dB Bandwidth** 292.278 kHz\*

**5.3.8) GSMK Occupied Bandwidth, PCS Middle channel, 1880.0 MHz, 99% bandwidth**

\* Agilent 15:55:37 Nov 26, 2007

L

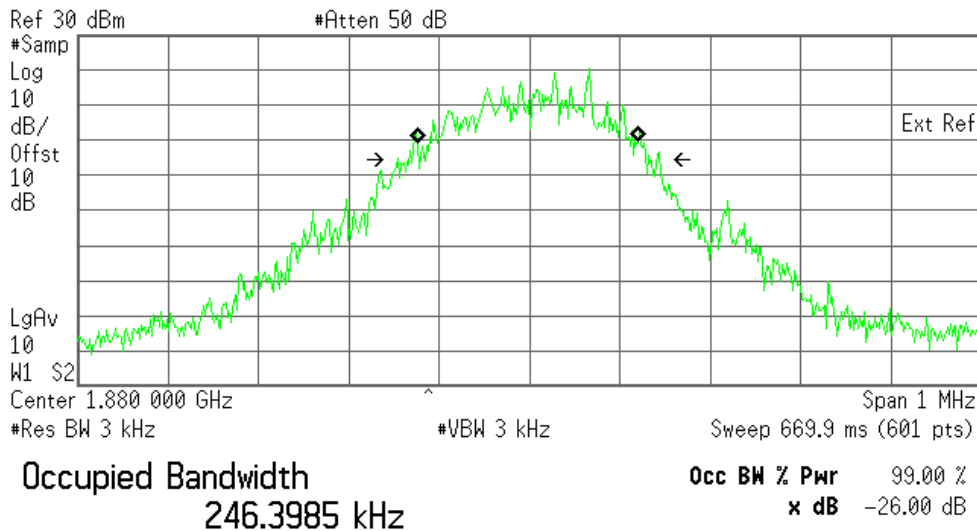

**Transmit Freq Error** -1.886 kHz  
**x dB Bandwidth** 293.063 kHz\*

© 2008 Sierra Wireless, Inc.

The contents of this page are subject to the confidentiality information on page one.

# SIERRA WIRELESS, INC.

### 5.3.9) GMSK Occupied Bandwidth, PCS High channel, 1909.8 MHz, 99% bandwidth

Agilent 16:32:54 Nov 26, 2007

L

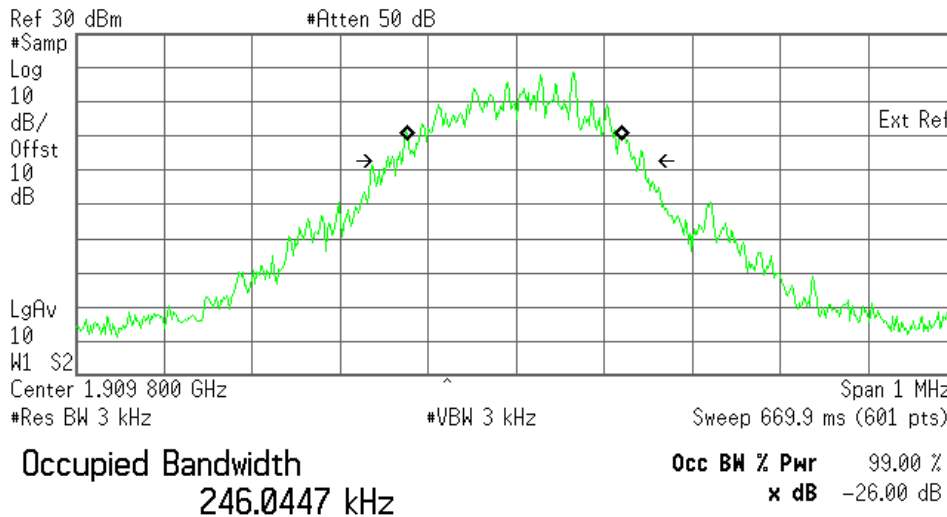

**Transmit Freq Error** -1.240 kHz  
**x dB Bandwidth** 294.816 kHz\*

### 5.3.10) 8-PSK Occupied Bandwidth, PCS Low channel, 1850.2 MHz, 99% bandwidth

Agilent 16:38:56 Nov 26, 2007

L

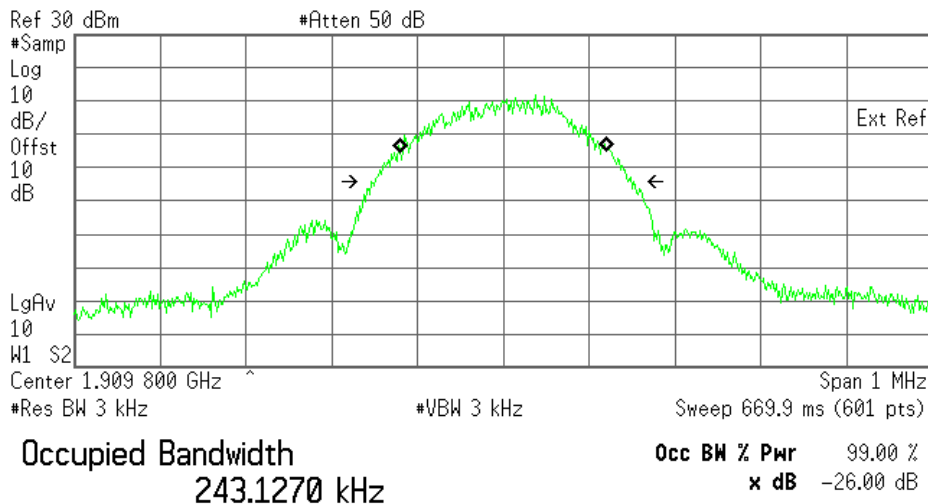

**Transmit Freq Error** 164.324 Hz  
**x dB Bandwidth** 309.501 kHz\*

© 2008 Sierra Wireless, Inc.

The contents of this page are subject to the confidentiality information on page one.

**SIERRA WIRELESS, INC.**

**5.3.11) 8-PSK Occupied Bandwidth, PCS Middle channel, 1880.0 MHz, 99% bandwidth**

\* Agilent 16:45:49 Nov 26, 2007

L

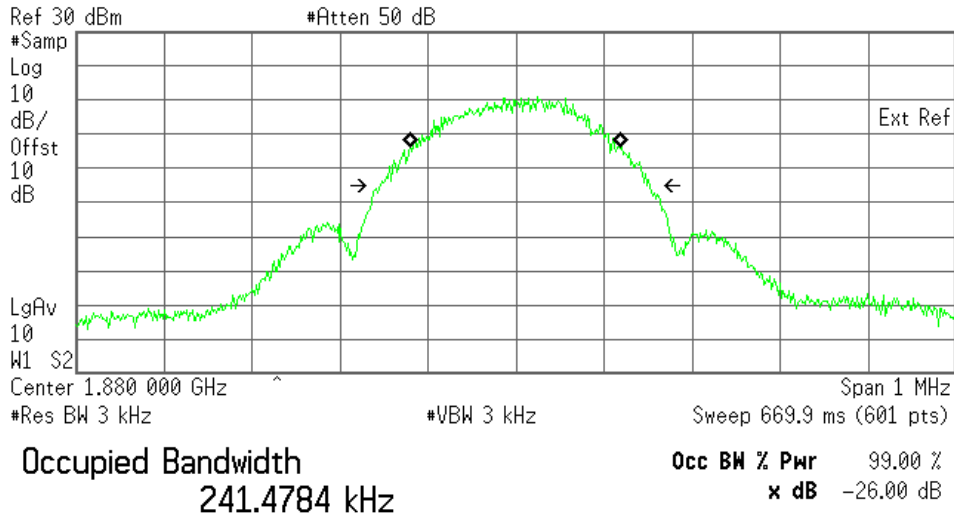

**Transmit Freq Error** -179.972 Hz  
**x dB Bandwidth** 308.569 kHz\*

**5.3.12) 8-PSK Occupied Bandwidth, PCS High channel, 1909.8 MHz, 99% bandwidth**

\* Agilent 16:53:47 Nov 26, 2007

L

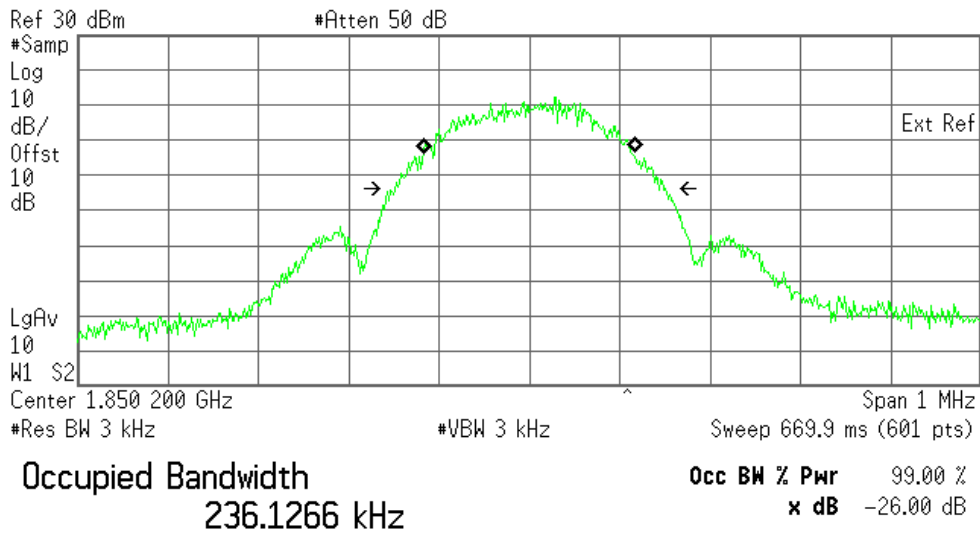

**Transmit Freq Error** -501.237 Hz  
**x dB Bandwidth** 301.855 kHz\*

© 2008 Sierra Wireless, Inc.

The contents of this page are subject to the confidentiality information on page one.

**SIERRA WIRELESS, INC.**

**5.3.13) WCDMA Occupied Bandwidth, Cellular Low channel, 826.4 MHz, 99% bandwidth**

\* Agilent 13:57:42 Nov 26, 2007

L

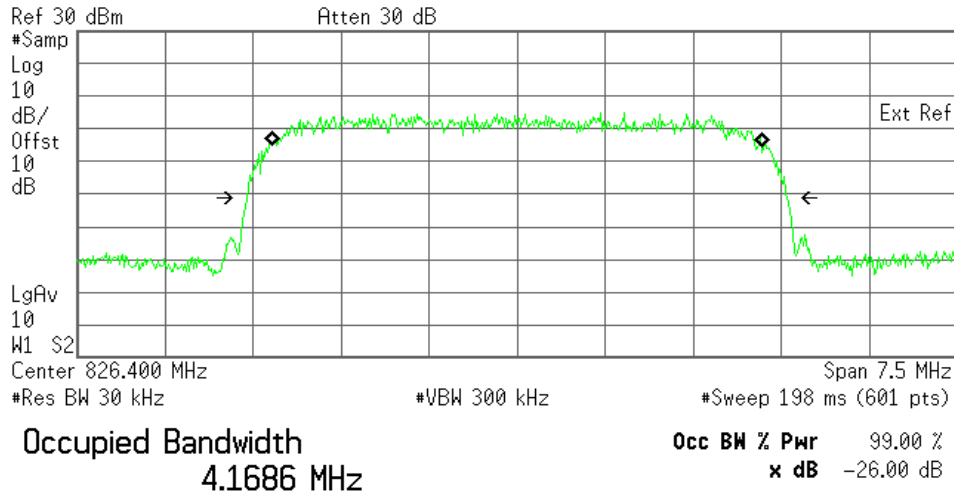

**Transmit Freq Error**      -1.192 kHz  
**x dB Bandwidth**            4.597 MHz\*

**5.3.14) WCDMA Occupied Bandwidth, Cellular Middle channel, 836.4 MHz, 99% bandwidth**

\* Agilent 13:58:42 Nov 26, 2007

L

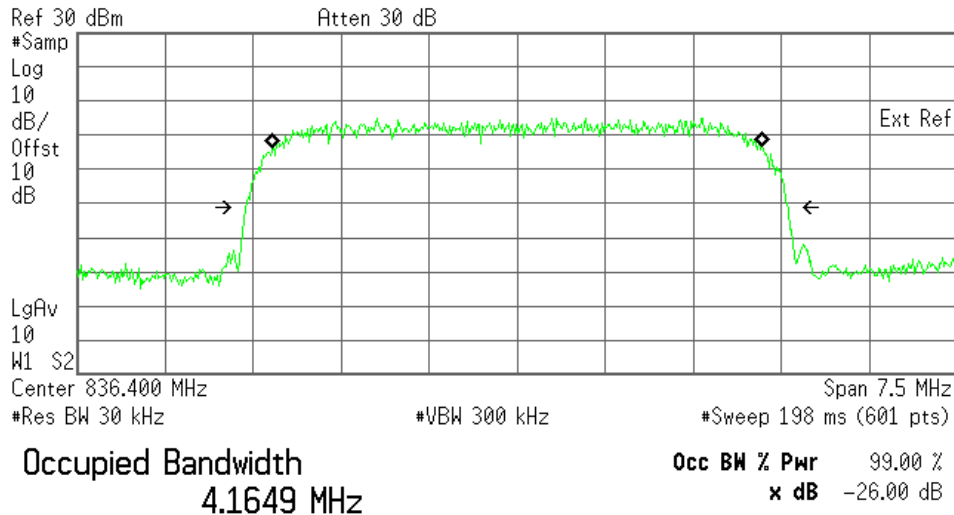

**Transmit Freq Error**      563.524 Hz  
**x dB Bandwidth**            4.617 MHz\*

© 2008 Sierra Wireless, Inc.

The contents of this page are subject to the confidentiality information on page one.

**SIERRA WIRELESS, INC.**

**5.3.15) WCDMA Occupied Bandwidth, Cellular High channel, 846.6 MHz, 99% bandwidth**

Agilent 14:00:02 Nov 26, 2007

L

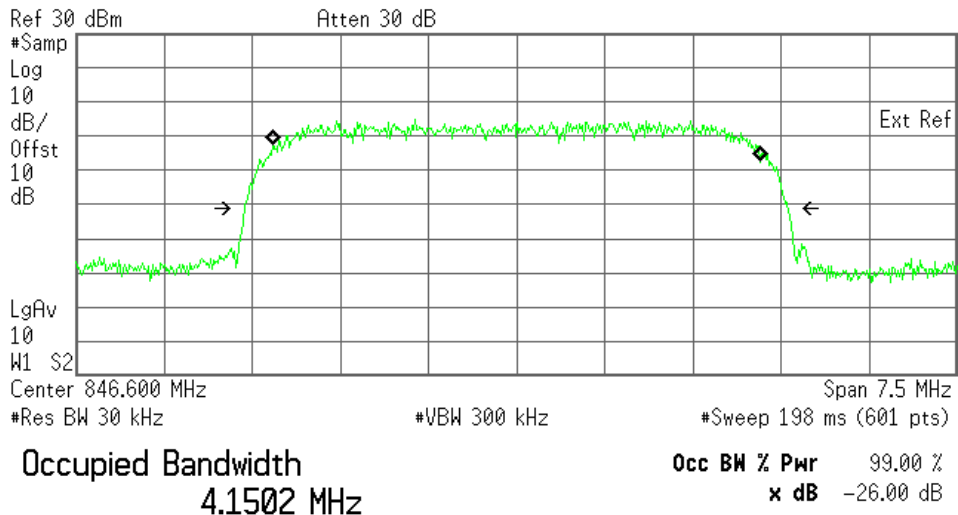

**Transmit Freq Error**      -1.421 kHz  
**x dB Bandwidth**        4.627 MHz\*

**5.3.16) WCDMA Occupied Bandwidth, PCS Low channel, 1852.4 MHz, 99% bandwidth**

Agilent 13:54:38 Nov 26, 2007

L

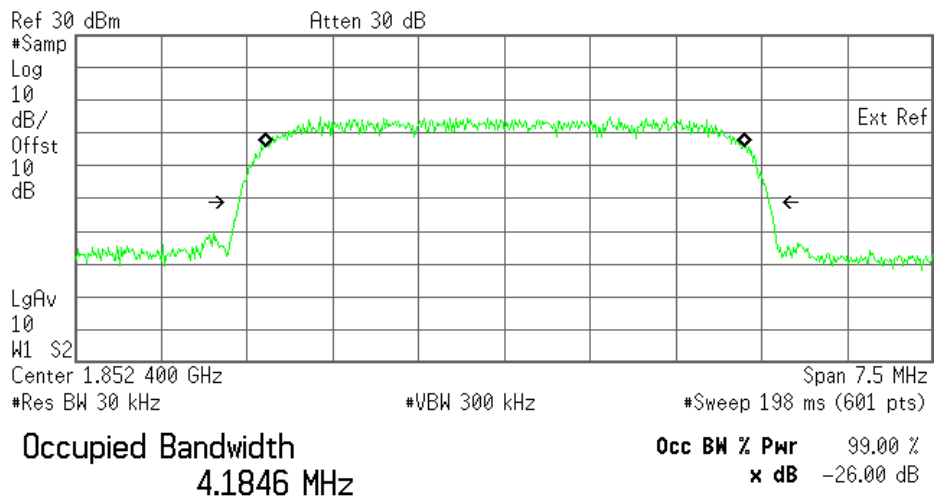

**Transmit Freq Error**      1.658 kHz  
**x dB Bandwidth**        4.636 MHz\*

© 2008 Sierra Wireless, Inc.

The contents of this page are subject to the confidentiality information on page one.

**SIERRA WIRELESS, INC.**

**5.3.17) WCDMA Occupied Bandwidth, PCS Middle channel, 1880 MHz, 99% bandwidth**

Agilent 13:56:23 Nov 26, 2007

L

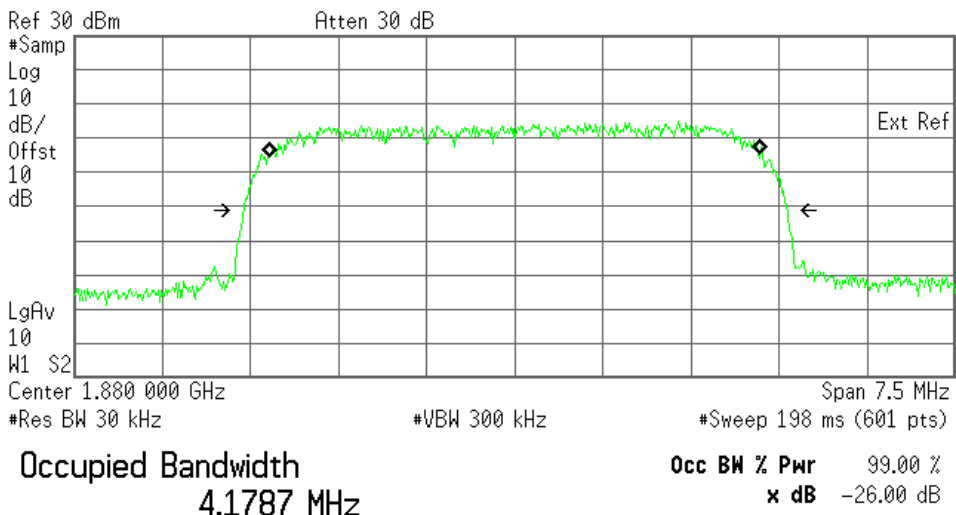

**Transmit Freq Error** 753.172 Hz  
**x dB Bandwidth** 4.624 MHz\*

**5.3.18) WCDMA Occupied Bandwidth, PCS High channel, 1907.6 MHz, 99% bandwidth**

Agilent 13:47:34 Nov 26, 2007

L

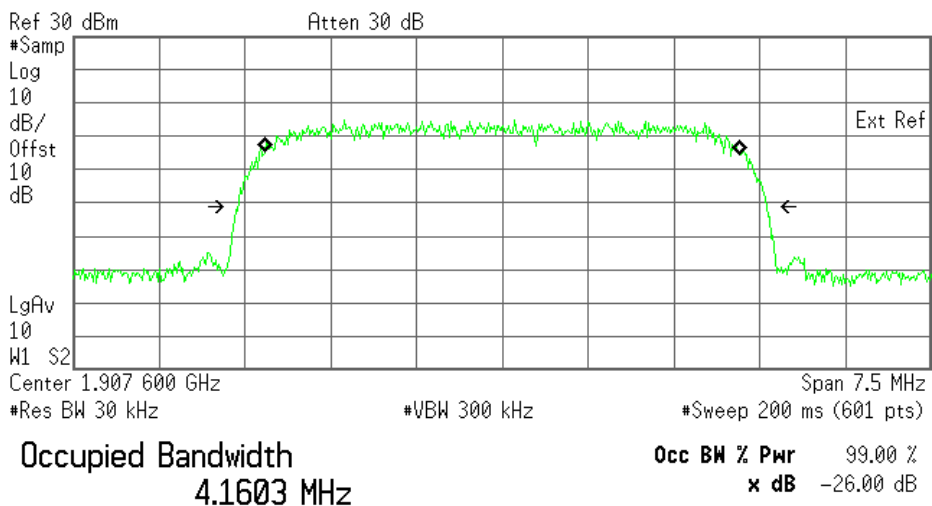

**Transmit Freq Error** 462.593 Hz  
**x dB Bandwidth** 4.619 MHz\*

© 2008 Sierra Wireless, Inc.

The contents of this page are subject to the confidentiality information on page one.

## SIERRA WIRELESS, INC.

### 6 Out of Band Emissions at Antenna Terminals

FCC 22.901(d), 22.917, 24.238(a)

#### Out of Band Emissions:

The mean power of emissions must be attenuated below the mean power of the unmodulated carrier (P) on any frequency outside the frequency band by at least  $(43 + 10 \log P)$  dB, in this case, -13dBm.

#### **6.1 Test Procedure**

The RF output of the transmitter was connected to a spectrum analyzer through a calibrated coaxial cable. Sufficient scans were taken to show the out-of-band Emissions, if any, up to 10<sup>th</sup> harmonic. The EUT was scanned for spurious emissions from 1MHz to 20GHz with sufficient bandwidth and video resolution. Data plots are included. The measurement cable path loss at 20GHz (including an attenuator) was 10dB. Multiple sweeps were recorded in maximum hold mode using a peak detector to ensure that the worst-case emissions were caught.

#### **Test Setup**

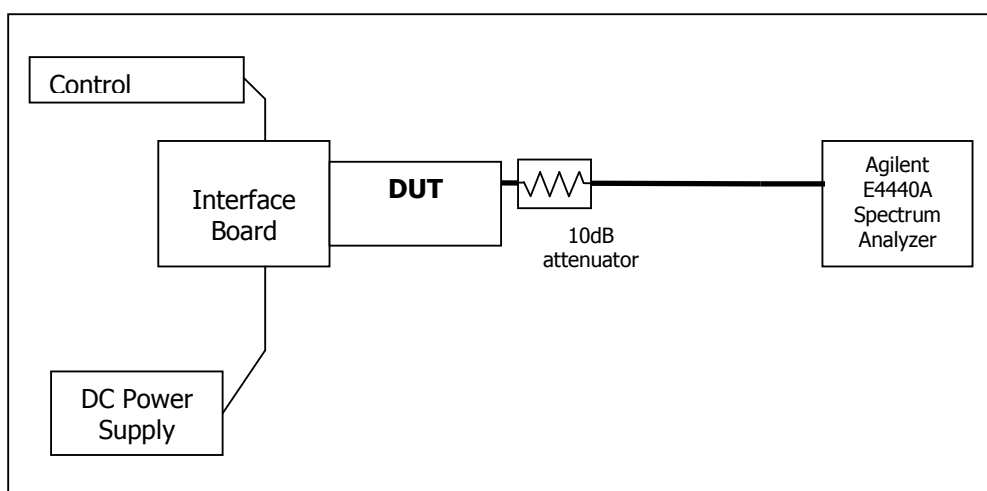

#### **6.2 Test Equipment**

EQUIPMENT	MANUFACTURER	MODEL NO.	SERIAL NO.	CAL. DATE
Control Computer	TC	Generic PC	100488	N/A
Wireless Test Set	Rohde & Schwarz	CMU200	111682	November 18, 2008
Spectrum Analyzer	Agilent	PSA E4440A	US41421268	March 11, 2008
DC Power Supply	HP	E3631A	3530A	N/A
Interface Board	Shop built	Minnow	N/A	N/A
Directional Coupler	Mini-Circuits	ZA3PD-2	N/A	N/A

#### **6.3 Test Results**

Refer to the following plots.

© 2008 Sierra Wireless, Inc.

The contents of this page are subject to the confidentiality information on page one.



## SIERRA WIRELESS, INC.

- **Cellular Band**

Plot Number	Description
6.4.1 – 6.4.3	GMSK Mode, Low channel, 824.20 MHz
6.4.4 – 6.4.6	GMSK Mode, Middle Channel, 836.6 MHz
6.4.7 – 6.4.9	GMSK Mode, High Channel, 848.8 MHz
6.4.10 – 6.4.12	8-PSK Mode, Low channel, 824.20 MHz
6.4.13 – 6.4.15	8-PSK Mode, Middle Channel, 836.6 MHz
6.4.16 – 6.4.18	8-PSK Mode, High Channel, 848.8 MHz

- **PCS Band**

Plot Number	Description
6.4.19 – 6.4.21	GMSK Mode, Low Channel, 1850.2 MHz
6.4.22 – 6.4.24	GMSK Mode, Middle Channel, 1880.0 MHz
6.4.25 – 6.4.27	GMSK Mode, High Channel, 1909.8 MHz
6.4.28 – 6.4.30	8-PSK, Mode, Low Channel, 1850.2 MHz
6.4.31 – 6.4.33	8-PSK Mode, Middle Channel, 1880.0 MHz
6.4.34 – 6.4.36	8-PSK Mode, High Channel, 1909.8 MHz

- **UMTS Cellular Band**

Plot Number	Description
6.4.37 – 6.4.39	WCDMA Mode, Low Channel, 826.4 MHz
6.4.40 – 6.4.42	WCDMA Mode, Middle Channel, 836.4 MHz
6.4.43 – 6.4.45	WCDMA Mode, High Channel, 846.6 MHz

- **UMTS PCS Band**

Plot Number	Description
6.4.46 – 6.4.48	WCDMA Mode, Low Channel, 1852.4 MHz
6.4.49 – 6.4.51	WCDMA Mode, Middle Channel, 1880.0 MHz
6.4.52 – 6.4.54	WCDMA Mode, High Channel, 1907.6 MHz

These plots show that the conducted emission limits requirements are met.

© 2008 Sierra Wireless, Inc.

The contents of this page are subject to the confidentiality information on page one.

# SIERRA WIRELESS, INC.

## 6.4 Test Plots

### Plot 6.4.1) Out of Band Emissions at Antenna Terminals

GMSK, Low channel, 824.200 MHz, 1 MHz to 1 GHz

Agilent 11:22:05 Nov 27, 2007

L

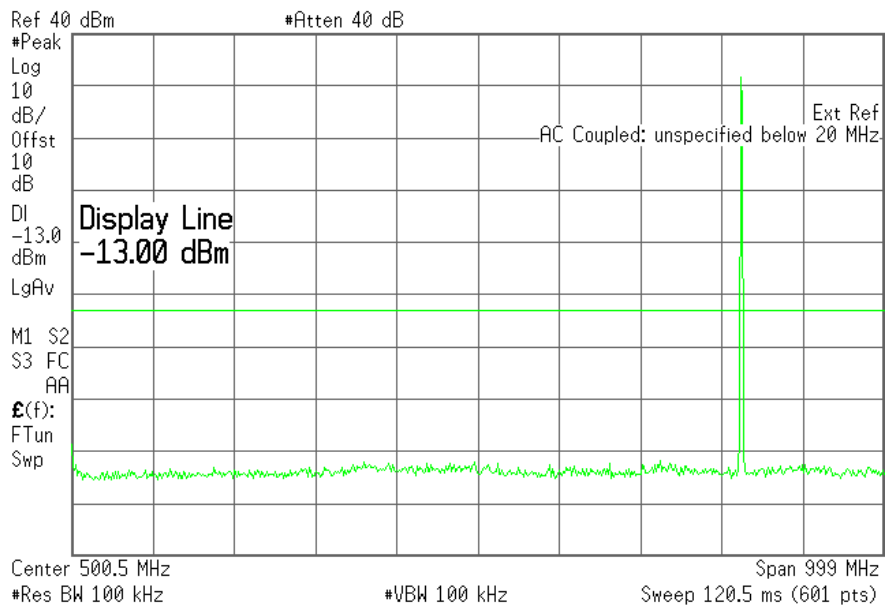

### Plot 6.4.2) Out of Band Emissions at Antenna Terminals

GMSK, Low channel, 824.200 MHz, TX signal +/- 20 MHz

Agilent 11:21:08 Nov 27, 2007

L

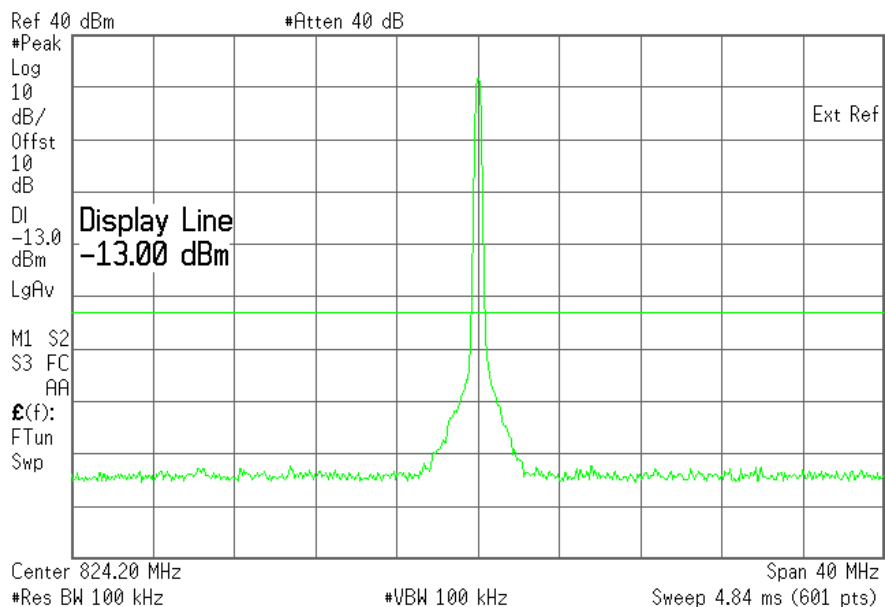

**The strong emission shown in each case is the carrier signal.**

© 2008 Sierra Wireless, Inc.

The contents of this page are subject to the confidentiality information on page one.

**SIERRA WIRELESS, INC.**

**Plot 6.4.3) Out of Band Emissions at Antenna Terminals**

GMSK, Low channel, 824.200 MHz, 1 GHz to 20 GHz

Agilent 11:26:59 Nov 27, 2007

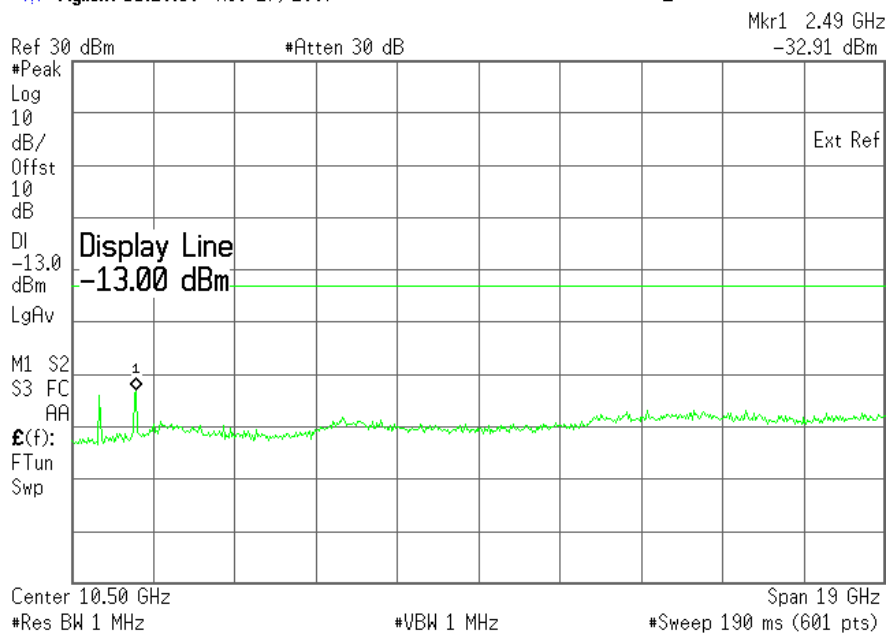

Cellular Harmonics for Ch. 128 (824.2 MHz)	Level (dBm)
<b>Second</b>	<b>-33.84 dBm</b>
<b>Third</b>	<b>-32.91 dBm</b>
<b>All others</b>	<b>&lt; -35 dBm up to 20GHz</b>

**SIERRA WIRELESS, INC.**

**Plot 6.4.4) Out of Band Emissions at Antenna Terminals**

GMSK, Mid Channel, 836.6 MHz, 1 MHz to 1 GHz

\* Agilent 11:37:02 Nov 27, 2007 L

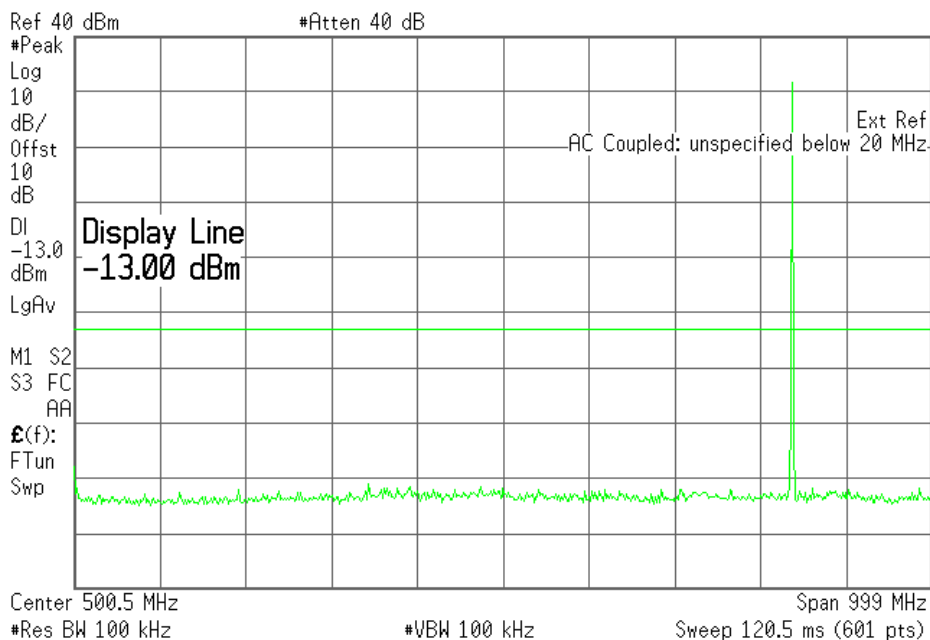

**Plot 6.4.5) Out of Band Emissions at Antenna Terminals**

GMSK, Mid Channel, 836.6 MHz, TX signal +/- 20 MHz

\* Agilent 11:35:09 Nov 27, 2007 L

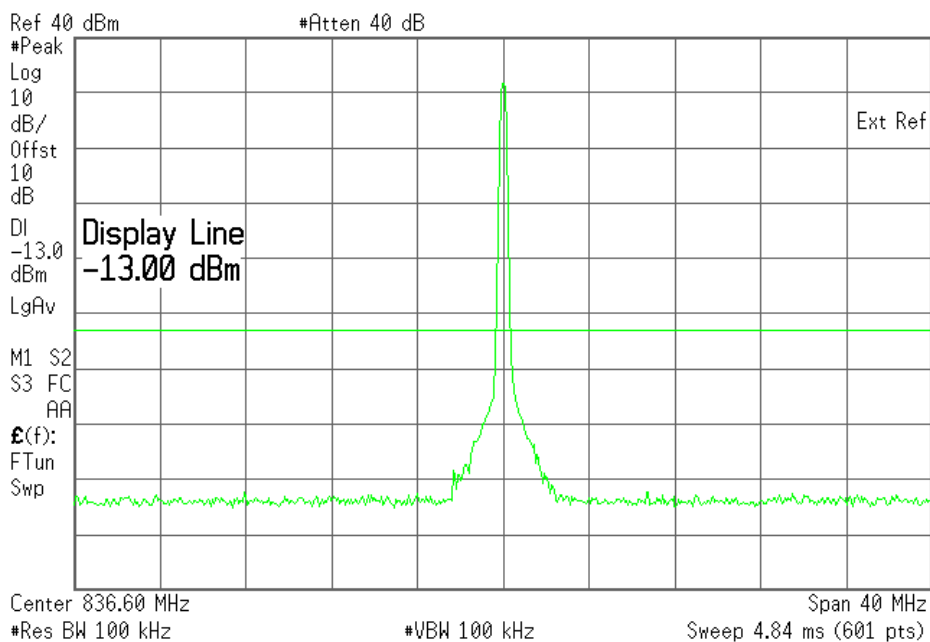

**The strong emission shown in each case is the carrier signal.**

© 2008 Sierra Wireless, Inc.

The contents of this page are subject to the confidentiality information on page one.

**SIERRA WIRELESS, INC.**

**Plot 6.4.6) Out of Band Emissions at Antenna Terminals**

GMSK, Mid Channel, 836.6 MHz, 1 GHz to 20 GHz

\* Agilent 11:31:47 Nov 27, 2007

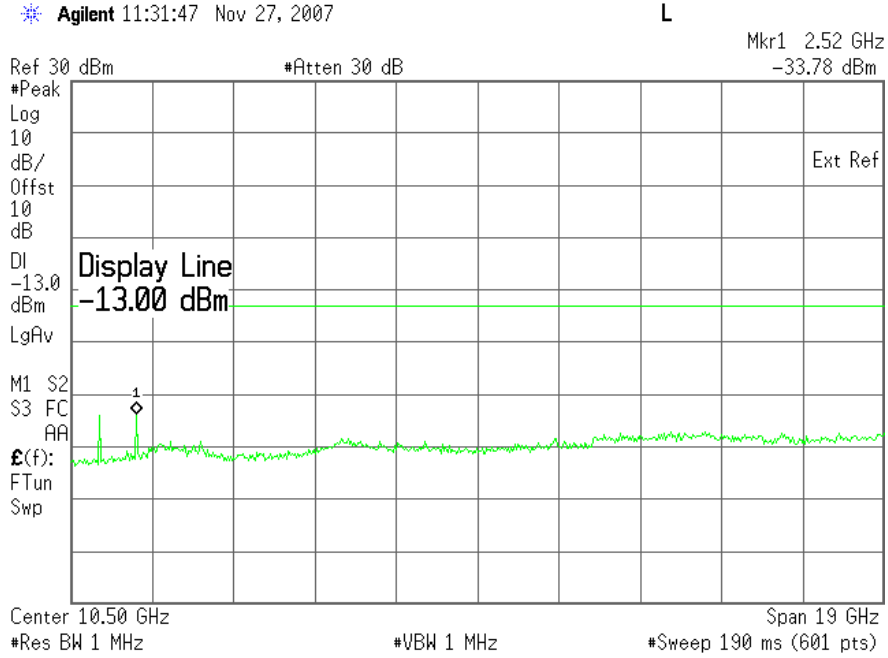

Cellular Harmonics for Ch. 190 (836.6 MHz)	Level (dBm)
<b>Second</b>	<b>-33.93 dBm</b>
<b>Third</b>	<b>-33.78 dBm</b>
<b>All others</b>	<b>&lt; -35 dBm up to 20GHz</b>

**SIERRA WIRELESS, INC.**

**Plot 6.4.7) Out of Band Emissions at Antenna Terminals**

GMSK, High Channel, 848.8 MHz, 1 MHz to 1 GHz

\* Agilent 11:40:08 Nov 27, 2007 L

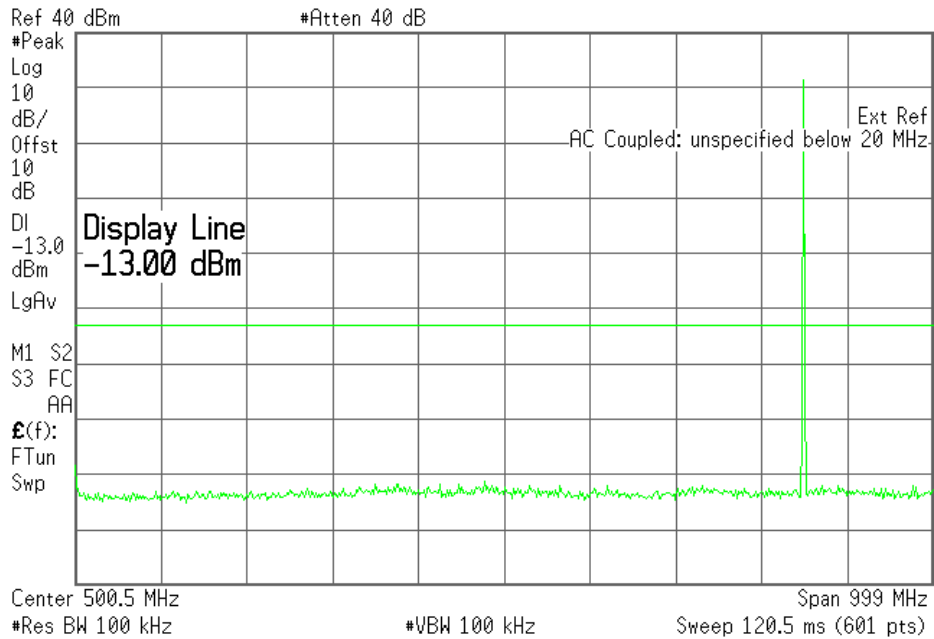

**Plot 6.4.8) Out of Band Emissions at Antenna Terminals**

GMSK, High Channel, 848.8 MHz, TX signal +/- 20 MHz

\* Agilent 11:41:45 Nov 27, 2007 L

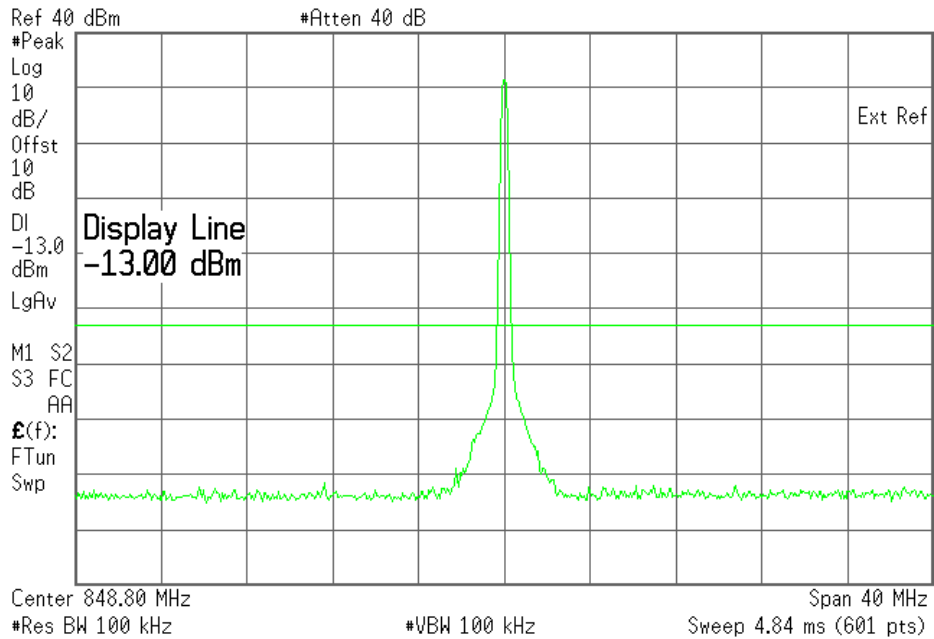

**The strong emission shown in each case is the carrier signal.**

© 2008 Sierra Wireless, Inc.

The contents of this page are subject to the confidentiality information on page one.

**SIERRA WIRELESS, INC.**

**Plot 6.4.9) Out of Band Emissions at Antenna Terminals**

GMSK, High Channel, 848.8 MHz, 1 GHz to 20 GHz

\* Agilent 11:44:31 Nov 27, 2007

L

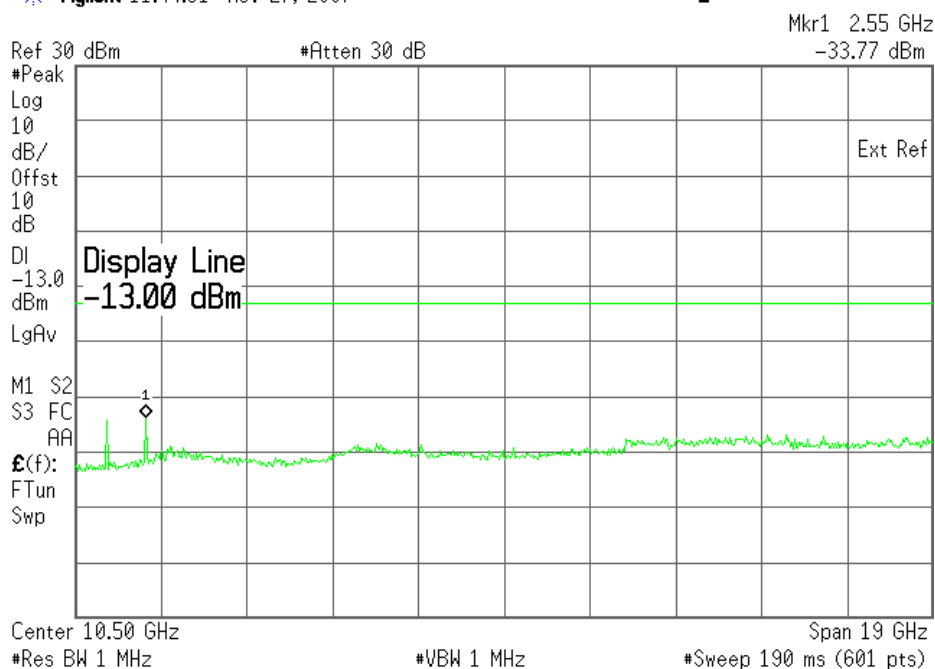

Cellular Harmonics for Ch. 251 (848.8 MHz)	Level (dBm)
Second	-34.30 dBm
Third	-33.77 dBm
All others	< -35 dBm up to 20GHz

**SIERRA WIRELESS, INC.**

**Plot 6.4.10) Out of Band Emissions at Antenna Terminals**

8-PSK, Low channel, 824.200 MHz, 1 MHz to 1 GHz

\* Agilent 11:52:26 Nov 27, 2007 L

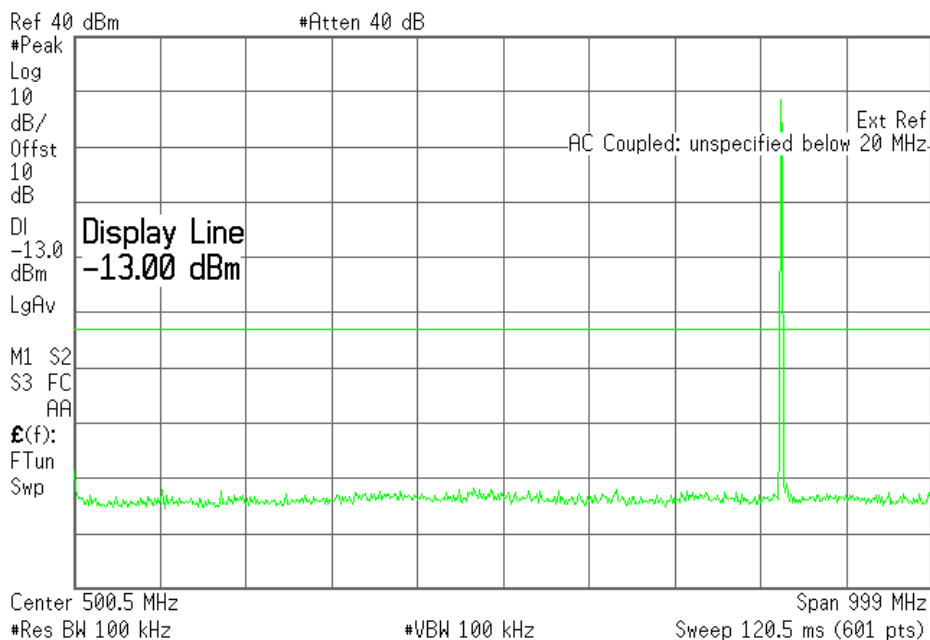

**Plot 6.4.11) Out of Band Emissions at Antenna Terminals**

8-PSK, Low channel, 824.200 MHz, TX signal +/- 20 MHz

\* Agilent 11:51:29 Nov 27, 2007 L

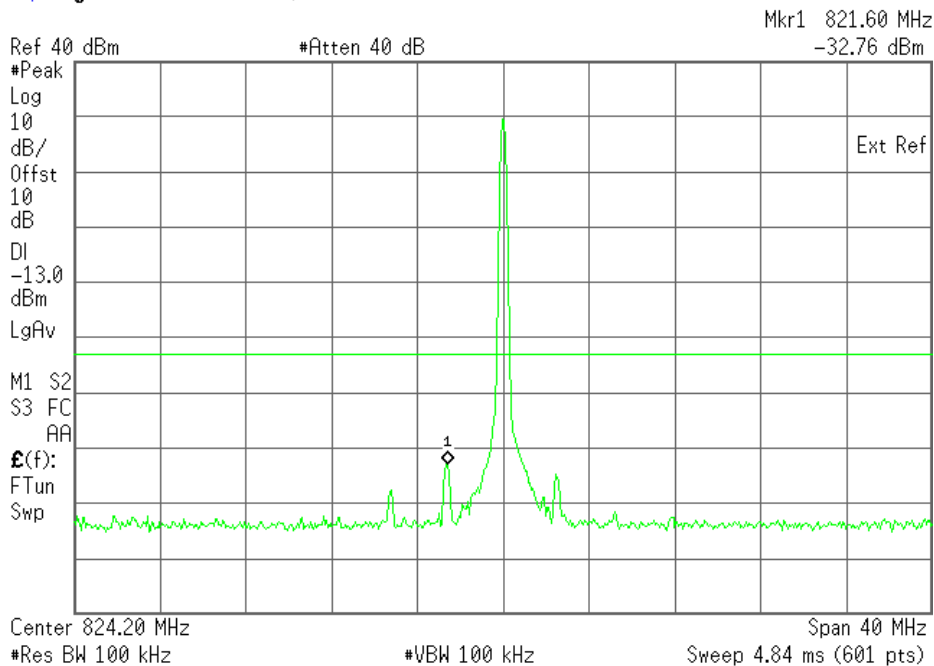

**The strong emission shown in each case is the carrier signal.**

© 2008 Sierra Wireless, Inc.

The contents of this page are subject to the confidentiality information on page one.



**SIERRA WIRELESS, INC.**

**Plot 6.4.12) Out of Band Emissions at Antenna Terminals**

8-PSK, Low channel, 824.200 MHz, 1 GHz to 20 GHz

Agilent 13:42:30 Nov 27, 2007

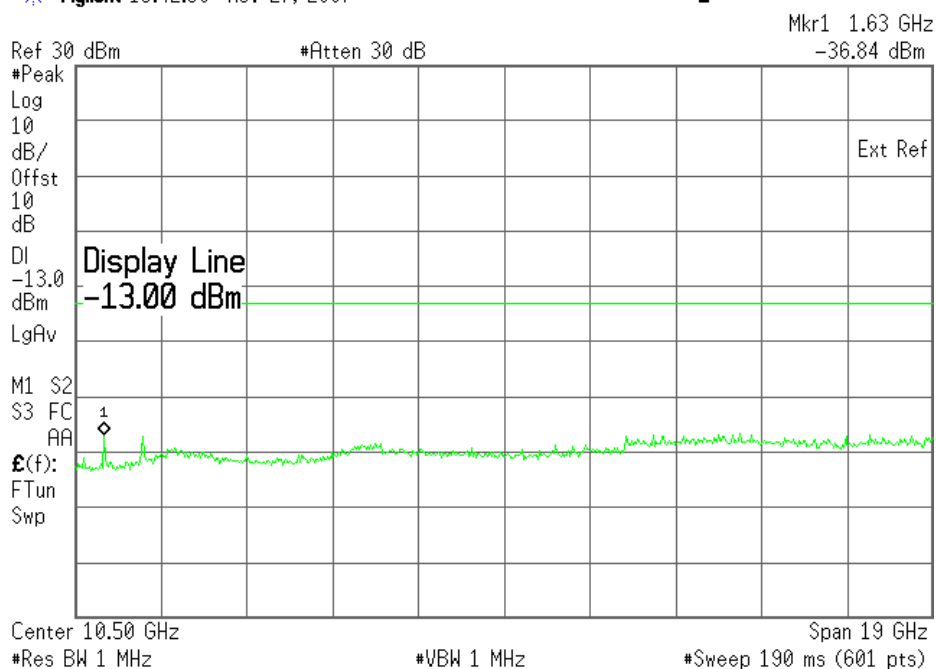

Cellular Harmonics for Ch. 128 (824.2 MHz)	Level (dBm)
Second	-36.84dBm
Third	-37.12 dBm
All others	< -35 dBm up to 20GHz

**SIERRA WIRELESS, INC.**

**Plot 6.4.13) Out of Band Emissions at Antenna Terminals**

8-PSK, Mid Channel, 836.6 MHz, 1 MHz to 1 GHz

Agilent 13:25:40 Nov 27, 2007

L

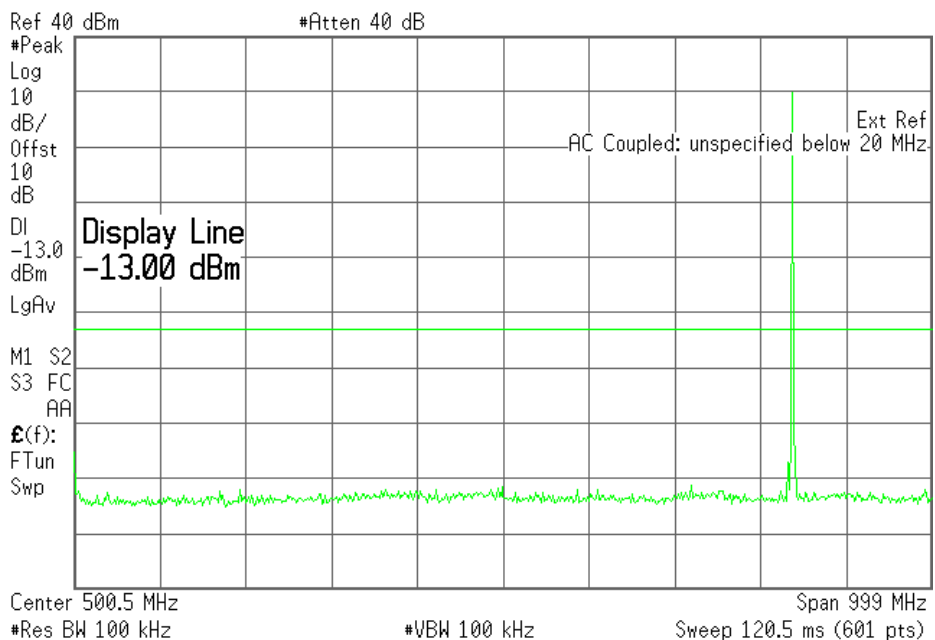

**Plot 6.4.14) Out of Band Emissions at Antenna Terminals**

8-PSK, Mid Channel, 836.6 MHz, TX signal +/- 20 MHz

Agilent 13:27:56 Nov 27, 2007

L

Mkr1 833.93 MHz  
-32.93 dBm

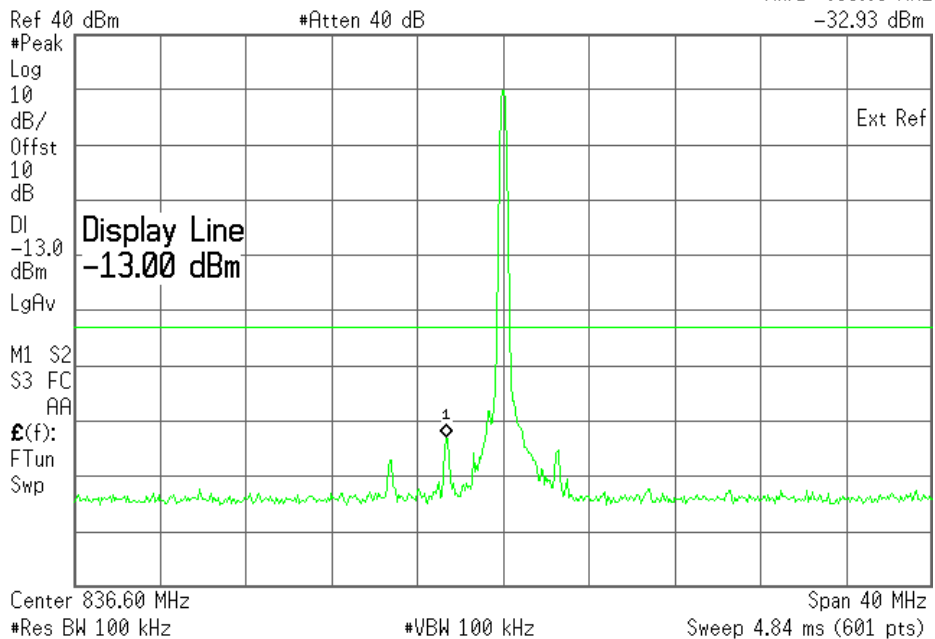

**The strong emission shown in each case is the carrier signal.**

© 2008 Sierra Wireless, Inc.

The contents of this page are subject to the confidentiality information on page one.

**SIERRA WIRELESS, INC.**

**Plot 6.4.15) Out of Band Emissions at Antenna Terminals**

8-PSK, Mid Channel, 836.6 MHz, 1 GHz to 20 GHz

Agilent 13:31:55 Nov 27, 2007

L

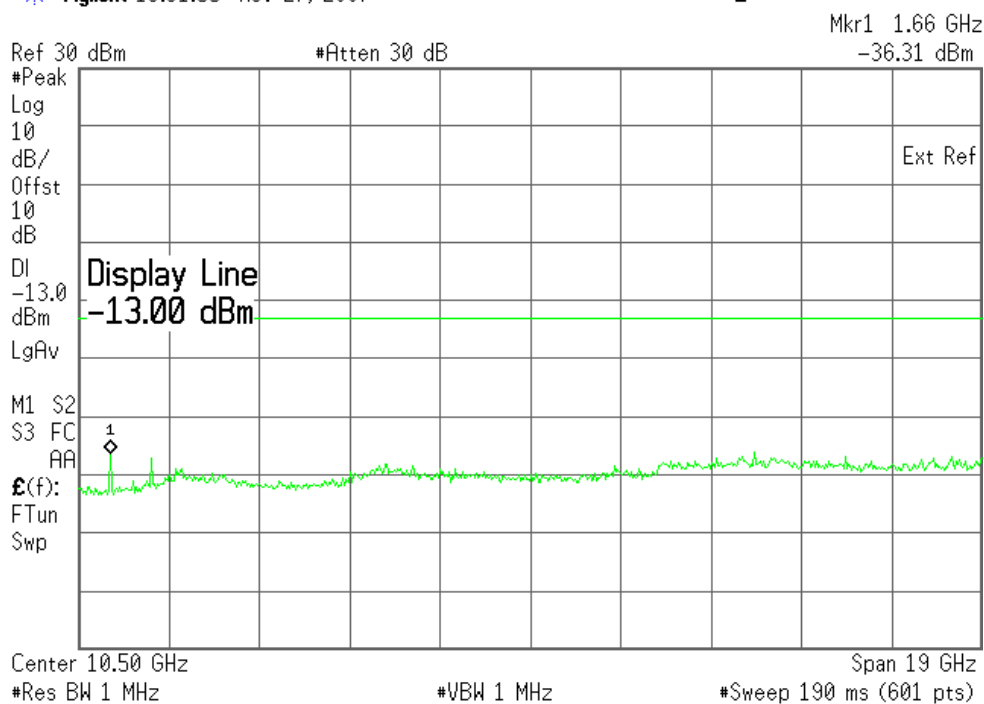

Cellular Harmonics for Ch. 190 (836.6 MHz)	Level (dBm)
Second	-36.31 dBm
Third	-37.11 dBm
All others	< -35 dBm up to 20GHz

**SIERRA WIRELESS, INC.**

**Plot 6.4.16) Out of Band Emissions at Antenna Terminals**  
 8-PSK, High Channel, 848.8 MHz, 1 MHz to 1 GHz

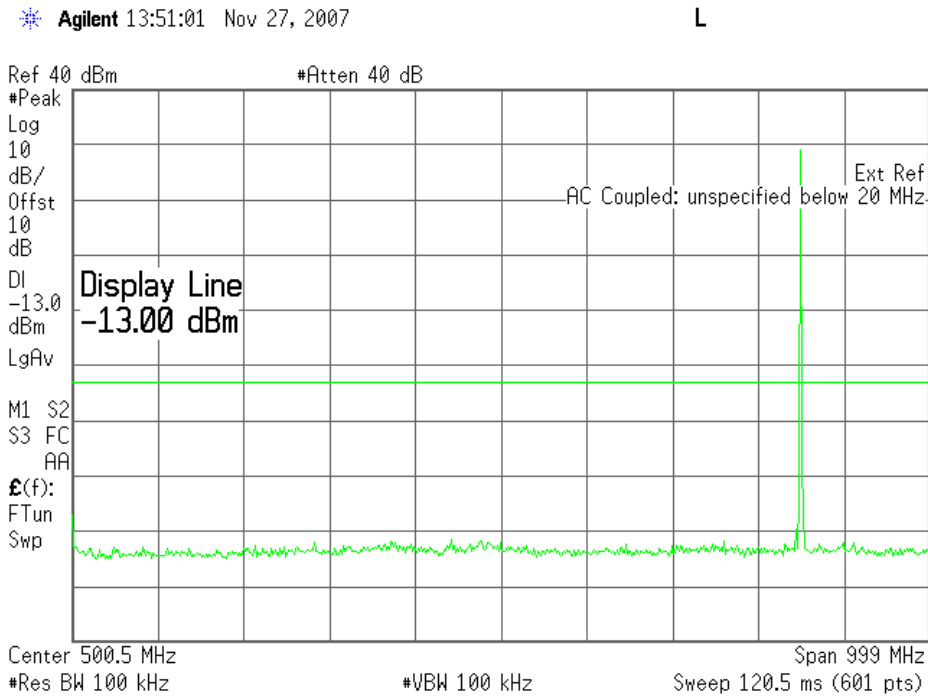

**Plot 6.4.17) Out of Band Emissions at Antenna Terminals**  
 8-PSK, High Channel, 848.8 MHz, TX signal +/- 20 MHz

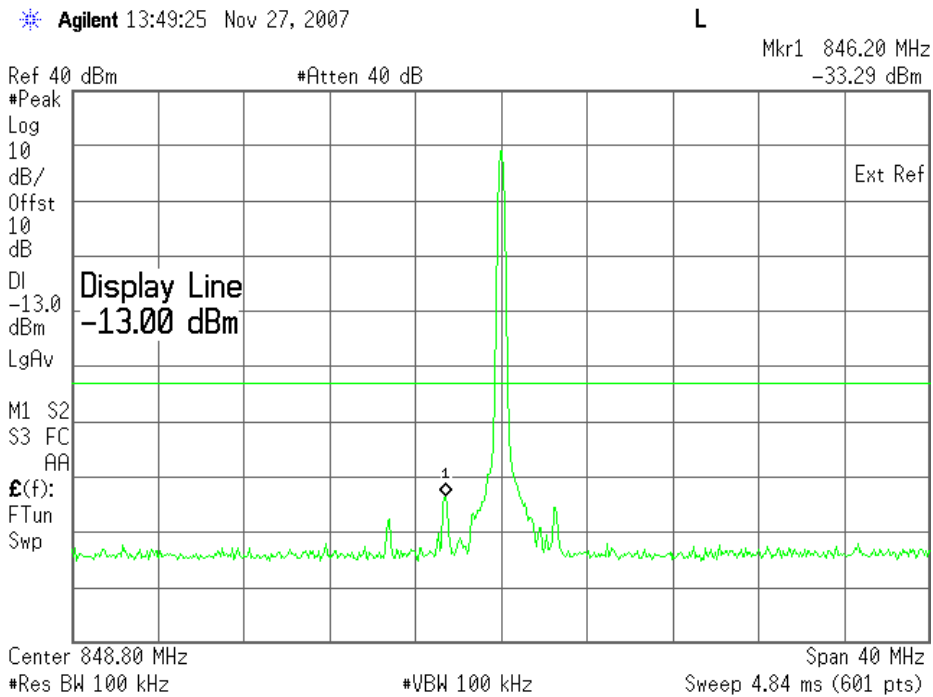

**The strong emission shown in each case is the carrier signal.**

© 2008 Sierra Wireless, Inc.

The contents of this page are subject to the confidentiality information on page one.

## SIERRA WIRELESS, INC.

### Plot 6.4.18) Out of Band Emissions at Antenna Terminals

8-PSK, High Channel, 848.8 MHz, 1 GHz to 20 GHz

Agilent 13:57:24 Nov 27, 2007

L

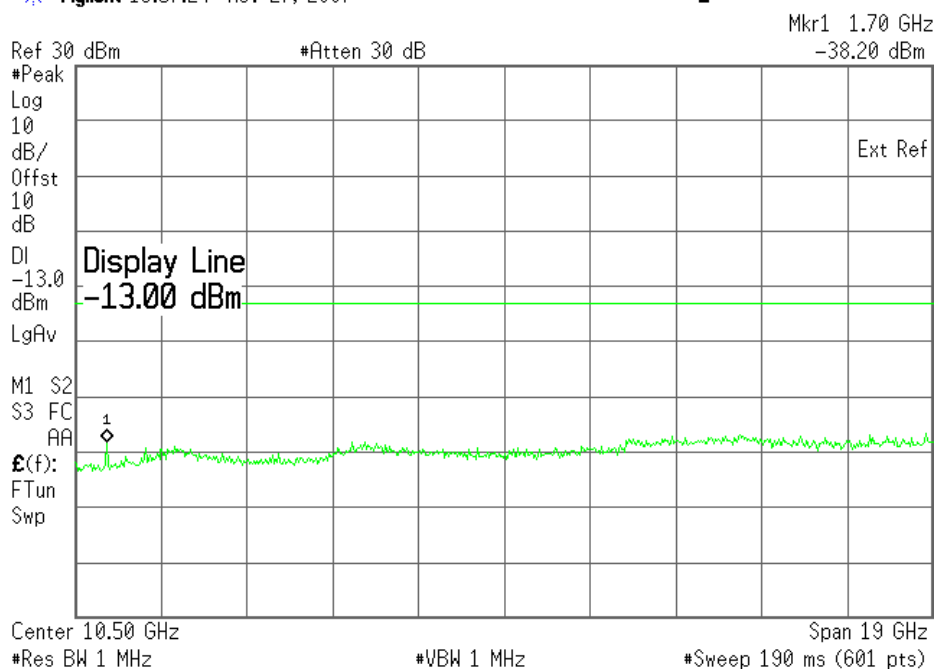

Cellular Harmonics for Ch. 251 (848.8 MHz)	Level (dBm)
Second	-38.20 dBm
Third	-38.60 dBm
All others	< -35 dBm up to 20GHz

SIERRA WIRELESS, INC.

**Plot 6.4.19) Out of Band Emissions at Antenna Terminals**

GMSK, Low channel, 1850.2 MHz, 1 MHz to 1 GHz

\* Agilent 14:07:01 Nov 27, 2007      L

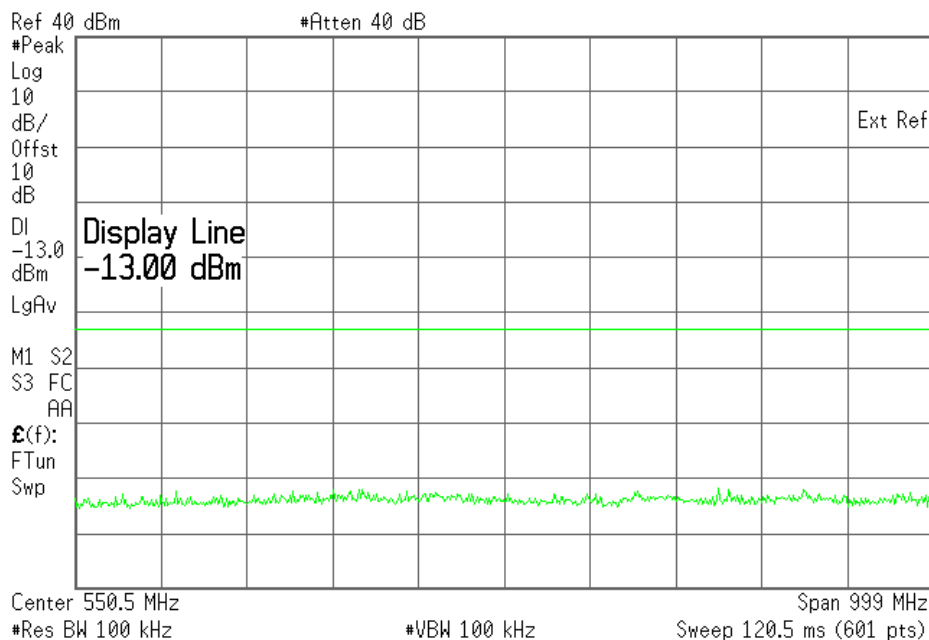

**Plot 6.4.20) Out of Band Emissions at Antenna Terminals**

GMSK, Low channel, 1850.2 MHz, TX signal +/- 20 MHz

\* Agilent 14:08:05 Nov 27, 2007      L

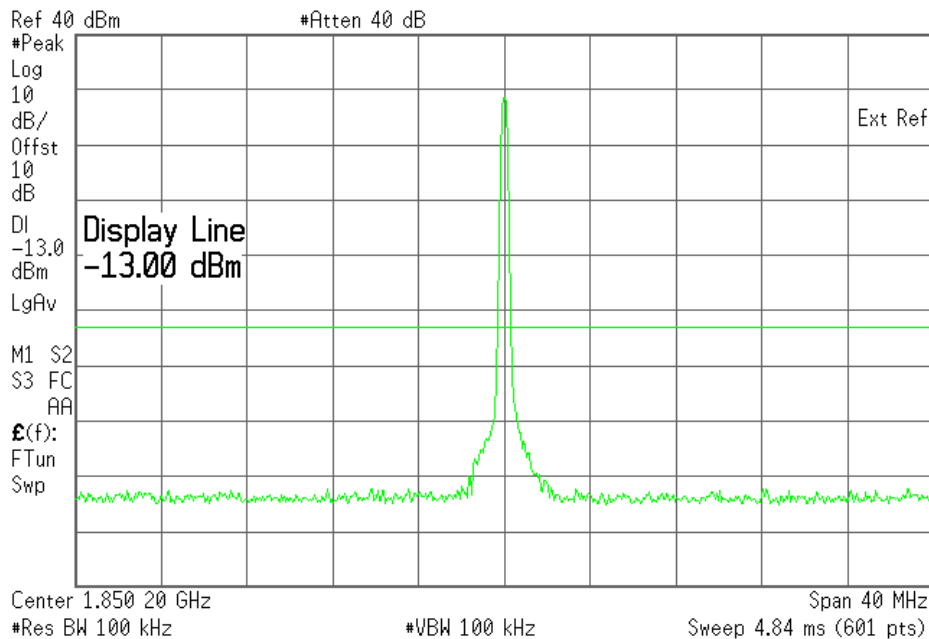

**The strong emission shown is the carrier signal.**

© 2008 Sierra Wireless, Inc.

The contents of this page are subject to the confidentiality information on page one.

SIERRA WIRELESS, INC.

**Plot 6.4.21) Out of Band Emissions at Antenna Terminals**

GMSK, Low channel, 1850.2 MHz, 1 GHz to 20 GHz

Agilent 14:17:01 Nov 27, 2007

L

Mkr1 5.56 GHz  
-38.04 dBm

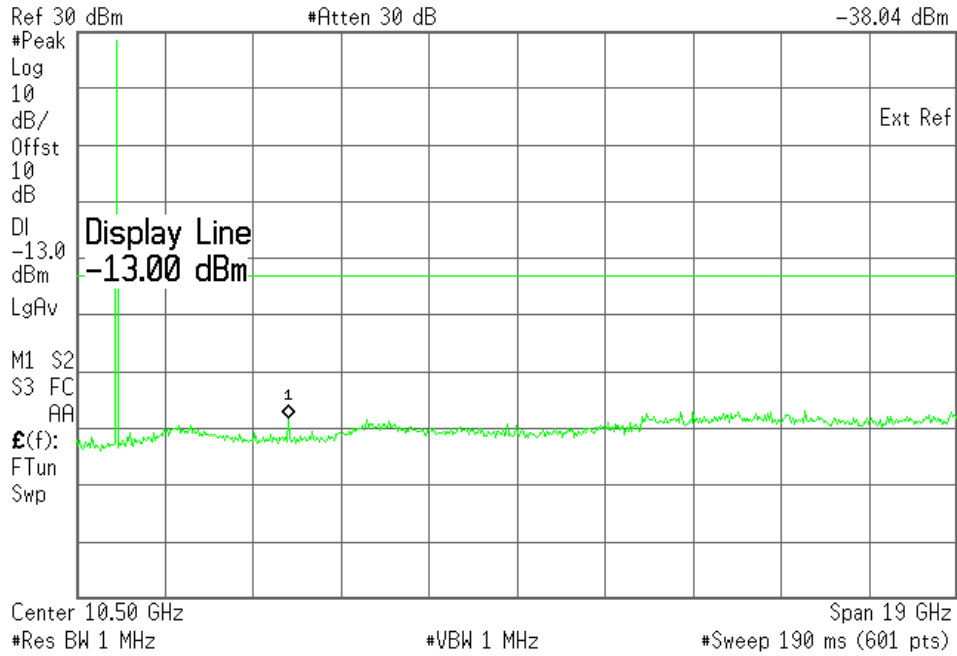

**The strong emission shown is the carrier signal.**

**SIERRA WIRELESS, INC.**

**Plot 6.4.22) Out of Band Emissions at Antenna Terminals**  
 GMSK, Middle channel, 1880.0 MHz, 1 MHz to 1 GHz

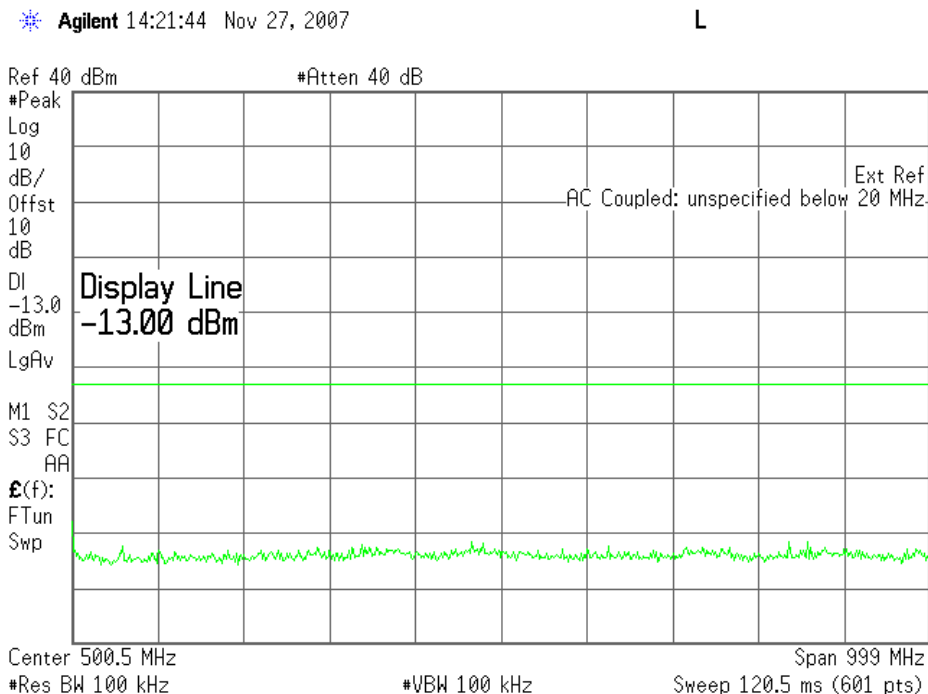

**Plot 6.4.23) Out of Band Emissions at Antenna Terminals**  
 GMSK, Middle channel, 1880.0 MHz, TX signal +/- 20 MHz

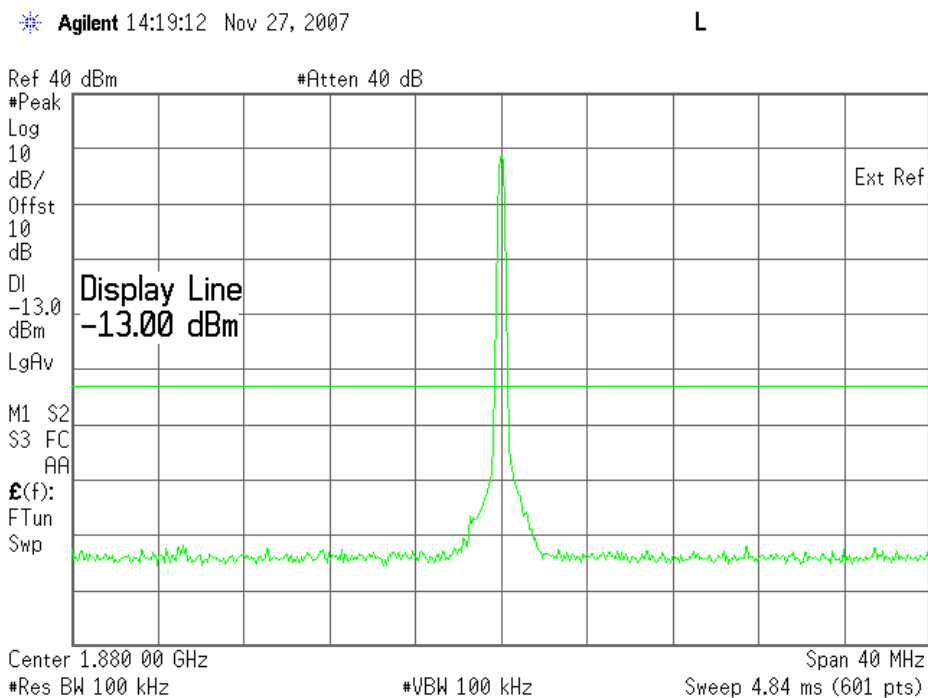

**The strong emission shown is the carrier signal.**

© 2008 Sierra Wireless, Inc.

The contents of this page are subject to the confidentiality information on page one.



SIERRA WIRELESS, INC.

**Plot 6.4.24) Out of Band Emissions at Antenna Terminals**

GMSK, Middle channel, 1880.0 MHz, 1 GHz to 20 GHz

Agilent 14:18:04 Nov 27, 2007

L

Mkr1 5.66 GHz  
-37.74 dBm

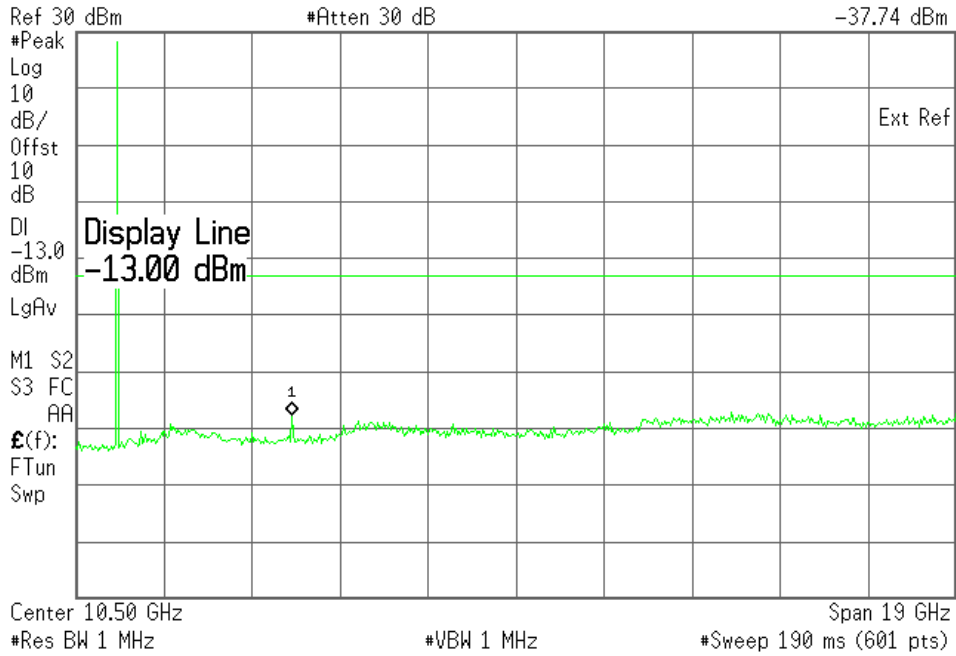

**The strong emission shown is the carrier signal.**

**SIERRA WIRELESS, INC.**

**Plot 6.4.25) Out of Band Emissions at Antenna Terminals**

GMSK, High channel, 1909.8 MHz, 1 MHz to 1 GHz

\* Agilent 14:22:58 Nov 27, 2007 L

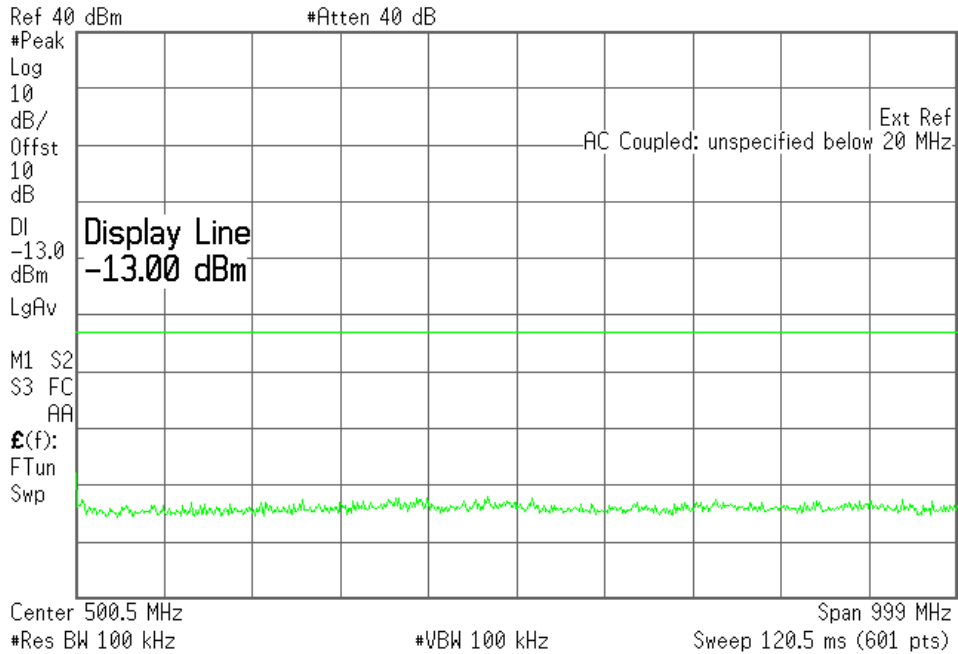

**Plot 6.4.26) Out of Band Emissions at Antenna Terminals**

GMSK, High channel, 1909.8 MHz, TX signal +/- 20 MHz

\* Agilent 14:23:49 Nov 27, 2007 L

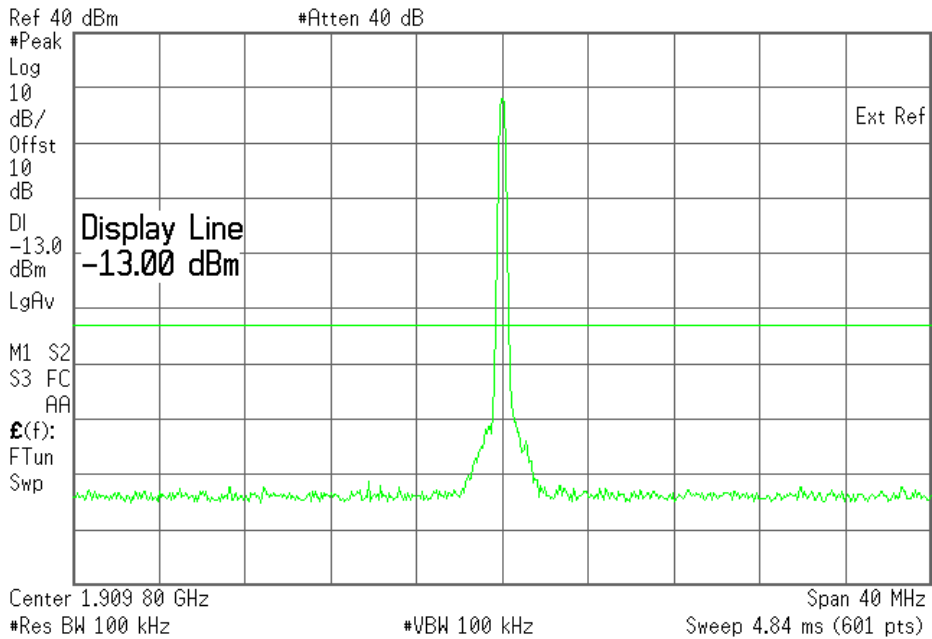

**The strong emission shown is the carrier signal.**

© 2008 Sierra Wireless, Inc.

The contents of this page are subject to the confidentiality information on page one.

SIERRA WIRELESS, INC.

**Plot 6.4.27) Out of Band Emissions at Antenna Terminals**

GMSK, High channel, 1909.8 MHz, 1 GHz to 20 GHz

Agilent 14:25:39 Nov 27, 2007

L

Mkr1 5.72 GHz  
-38.38 dBm

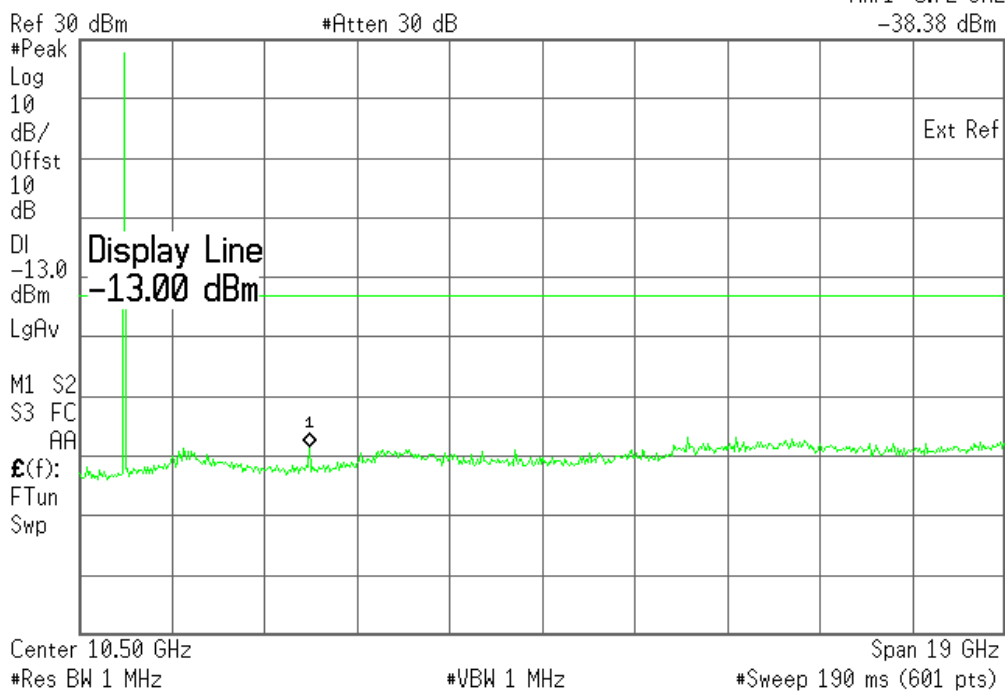

**The strong emission shown is the carrier signal.**

**SIERRA WIRELESS, INC.**

**Plot 6.4.28) Out of Band Emissions at Antenna Terminals**

8-PSK, Low channel, 1850.2 MHz, 1 MHz to 1 GHz

Agilent 15:27:22 Nov 27, 2007

L

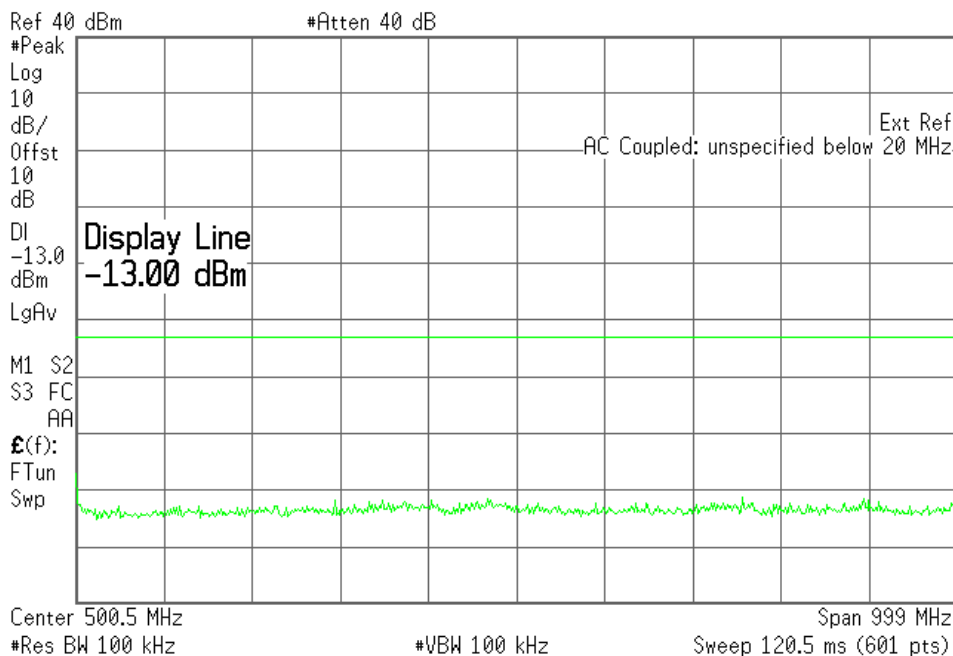

**Plot 6.4.29) Out of Band Emissions at Antenna Terminals**

8-PSK, Low channel, 1850.2 MHz, TX signal +/- 20 MHz

Agilent 15:25:56 Nov 27, 2007

L

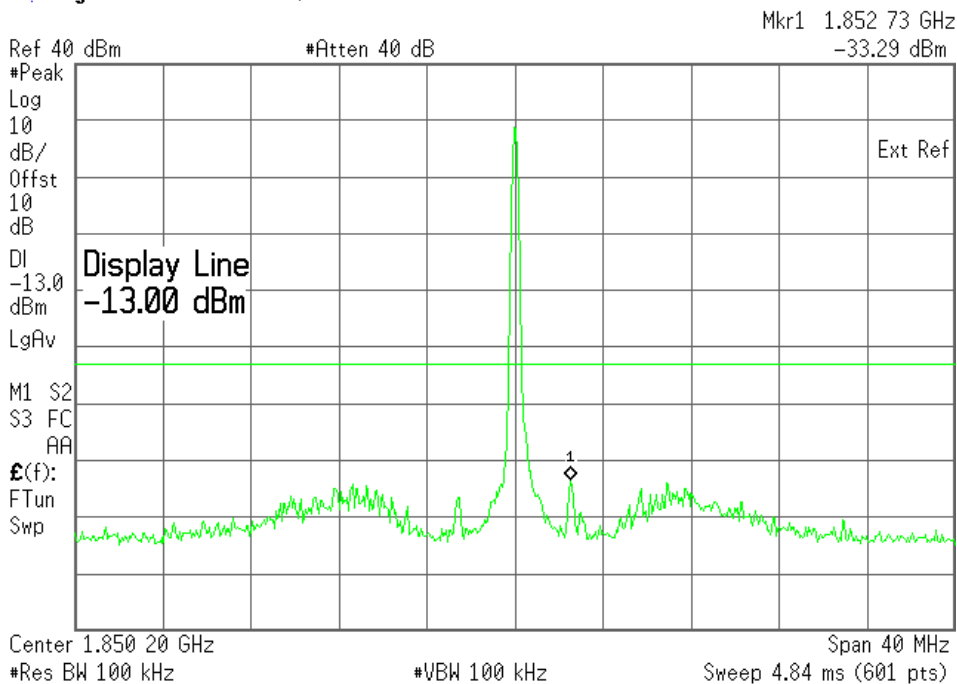

**The strong emission shown is the carrier signal.**

© 2008 Sierra Wireless, Inc.

The contents of this page are subject to the confidentiality information on page one.

SIERRA WIRELESS, INC.

**Plot 6.4.30) Out of Band Emissions at Antenna Terminals**

8-PSK, Low channel, 1850.2 MHz, 1 GHz to 20 GHz

Agilent 15:22:55 Nov 27, 2007

L

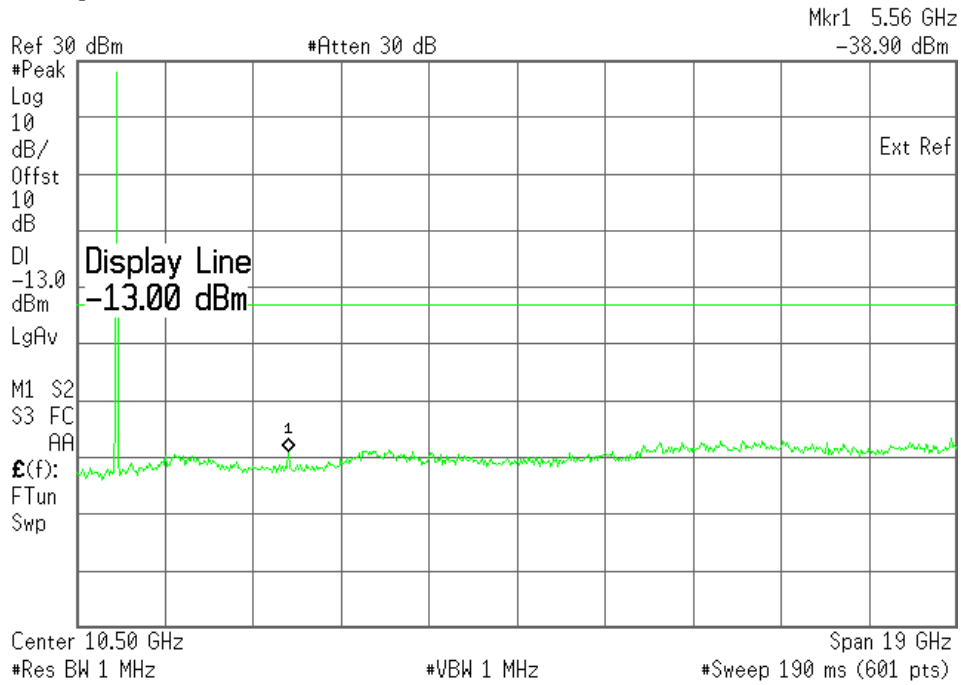

**The strong emission shown is the carrier signal.**

**SIERRA WIRELESS, INC.**

**Plot 6.4.31) Out of Band Emissions at Antenna Terminals**

8-PSK, Middle channel, 1880.0 MHz, 1 MHz to 1 GHz

Agilent 15:28:49 Nov 27, 2007

L

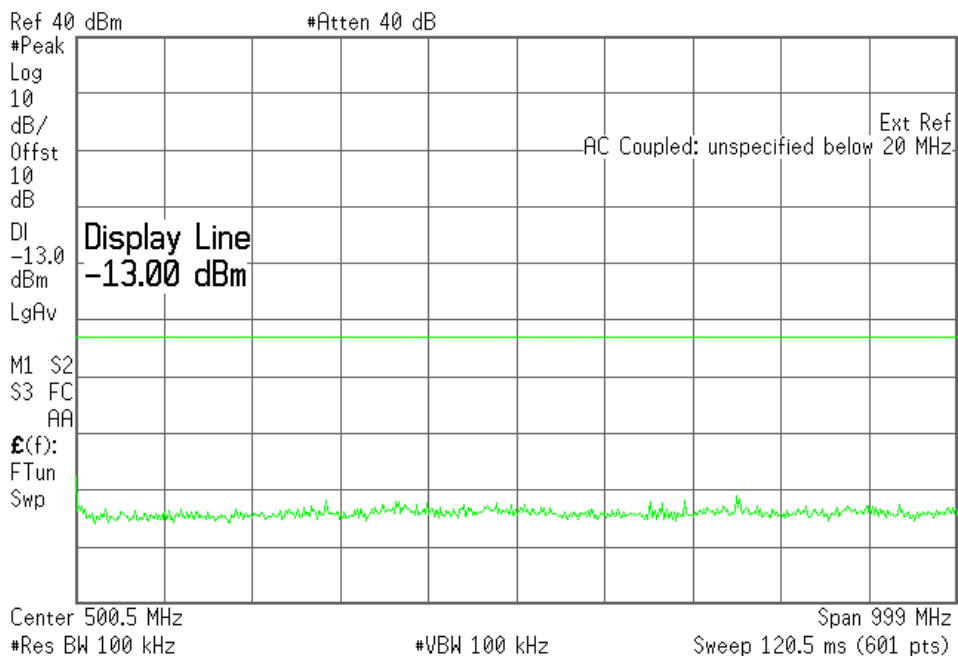

**Plot 6.4.32) Out of Band Emissions at Antenna Terminals**

8-PSK, Middle channel, 1880.0 MHz, TX signal +/- 20 MHz

Agilent 15:31:28 Nov 27, 2007

L

Mkr1 1.882 53 GHz  
-33.54 dBm

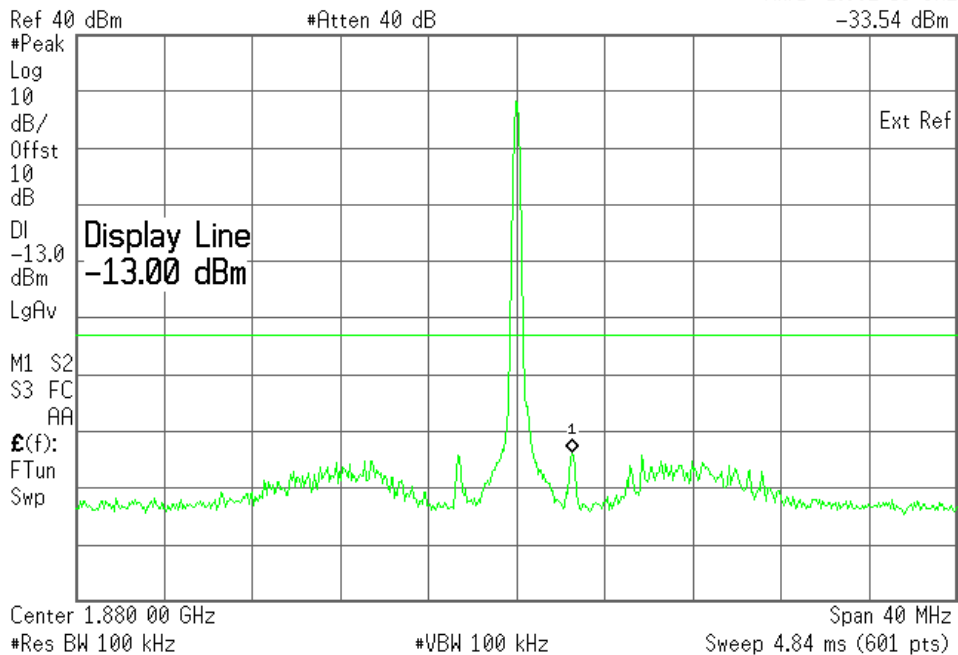

**The strong emission shown is the carrier signal.**

© 2008 Sierra Wireless, Inc.

The contents of this page are subject to the confidentiality information on page one.

SIERRA WIRELESS, INC.

**Plot 6.4.33) Out of Band Emissions at Antenna Terminals**

8-PSK, Middle channel, 1880.0 MHz, 1 GHz to 20 GHz

Agilent 16:02:36 Nov 27, 2007

L

Mkr1 5.66 GHz  
-37.69 dBm

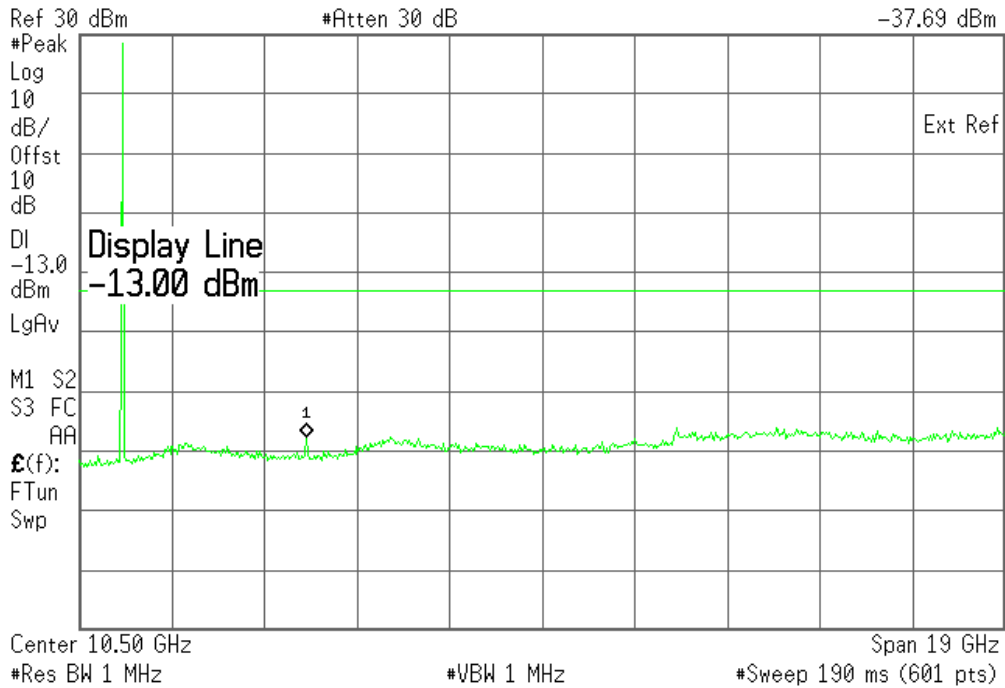

**The strong emission shown is the carrier signal.**

**SIERRA WIRELESS, INC.**

**Plot 6.4.34) Out of Band Emissions at Antenna Terminals**

8-PSK, High channel, 1909.8 MHz, 1 MHz to 1 GHz

Agilent 17:08:19 Nov 27, 2007

L

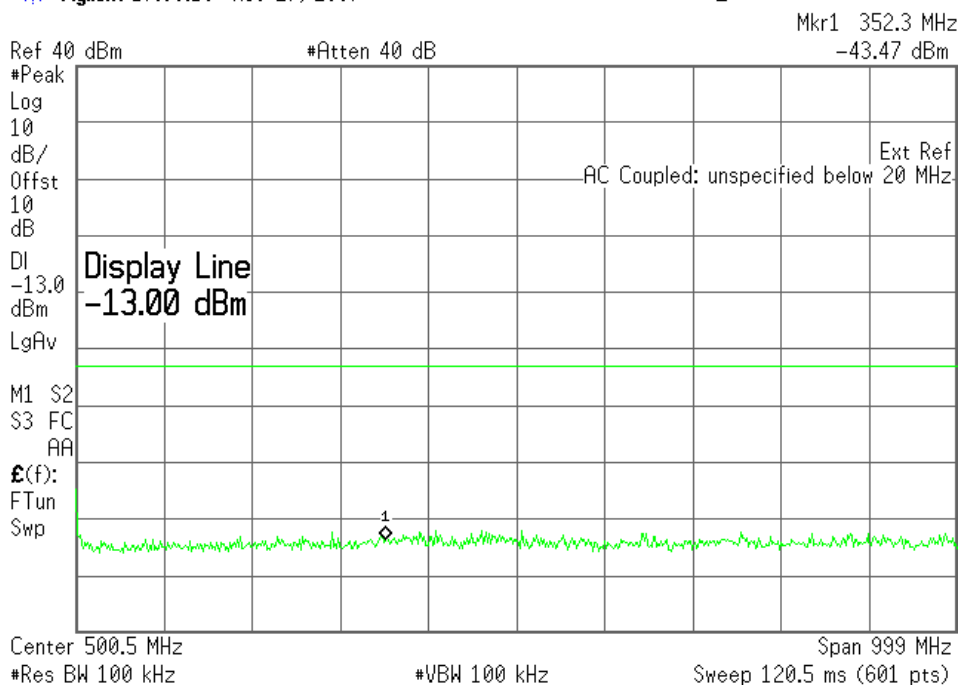

**Plot 6.4.35) Out of Band Emissions at Antenna Terminals**

8-PSK, High channel, 1909.8 MHz, TX signal +/- 20 MHz

Agilent 17:09:51 Nov 27, 2007

L

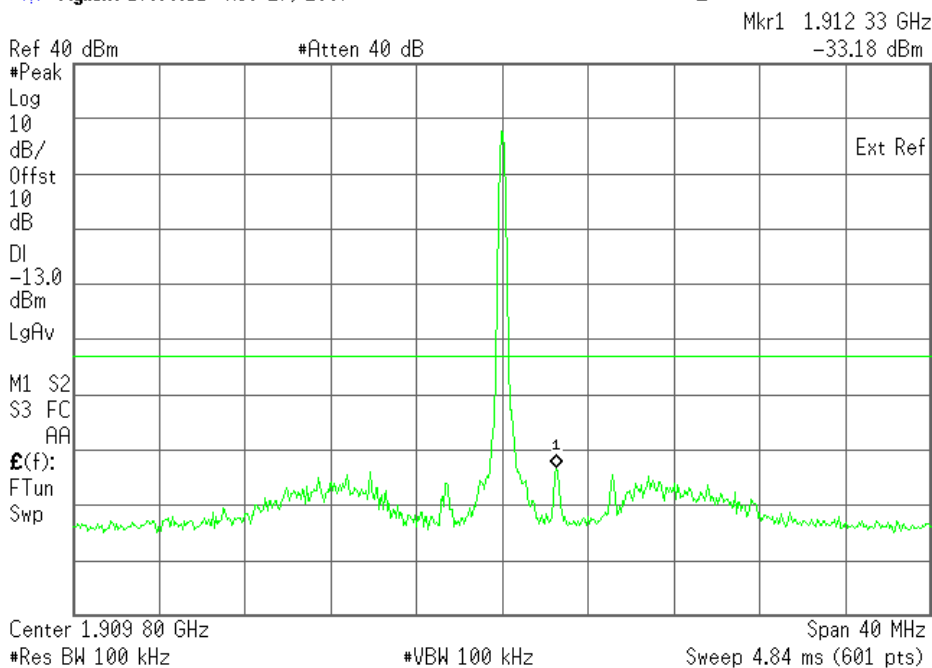

**The strong emission shown is the carrier signal.**

© 2008 Sierra Wireless, Inc.

The contents of this page are subject to the confidentiality information on page one.



**SIERRA WIRELESS, INC.**

Plot 6.4.36) Out of Band Emissions at Antenna Terminals  
8-PSK, High channel, 1909.8 MHz, 1 GHz to 20 GHz

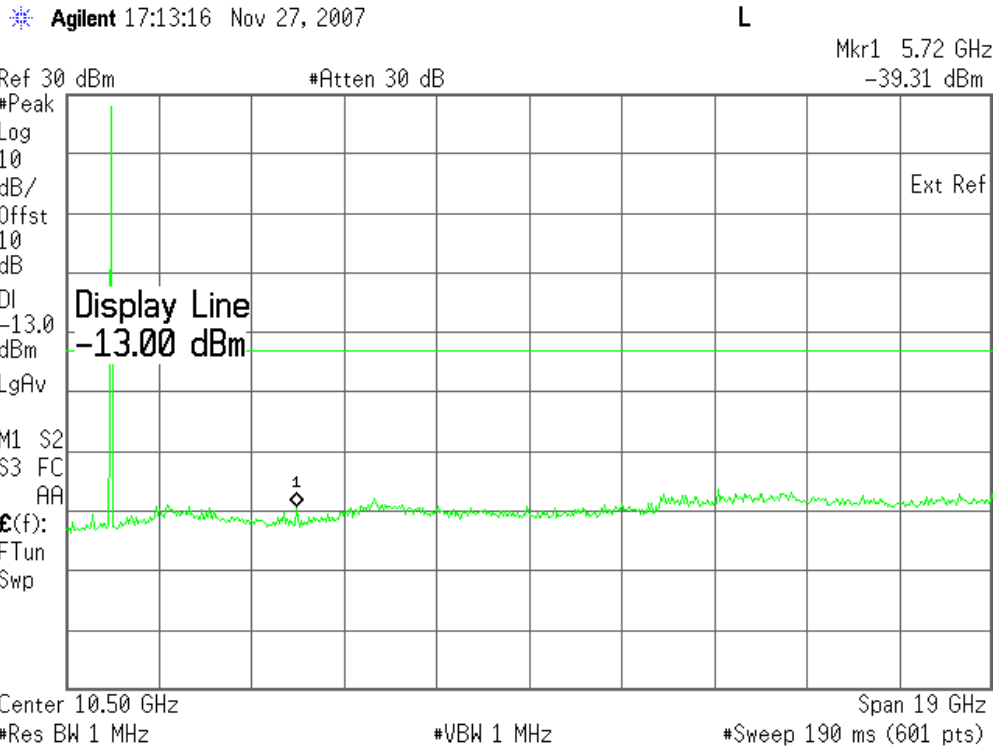

**The strong emission shown is the carrier signal.**

**SIERRA WIRELESS, INC.**

**Plot 6.4.37) Out of Band Emissions at Antenna Terminals**

WCDMA, Low channel, 826.4 MHz, 1 MHz to 1 GHz

Agilent 09:51:06 Nov 28, 2007

T

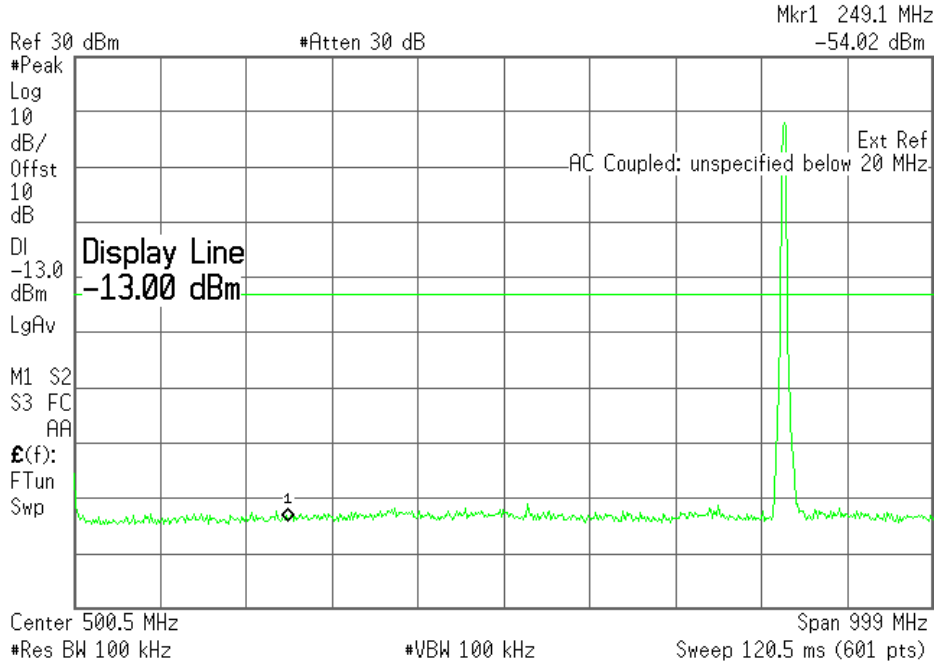

**Plot 6.4.38) Out of Band Emissions at Antenna Terminals**

WCDMA, Low channel, 826.4 MHz, TX signal +/- 20 MHz

Agilent 09:54:55 Nov 28, 2007

L

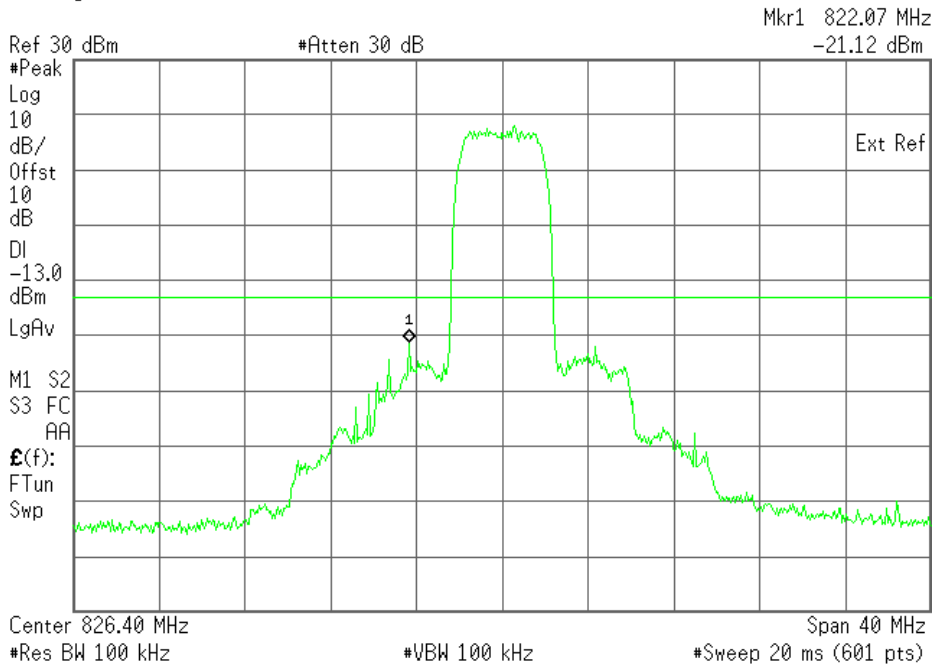

**The strong emission shown in each case is the carrier signal.**

© 2008 Sierra Wireless, Inc.

The contents of this page are subject to the confidentiality information on page one.

**SIERRA WIRELESS, INC.**

**Plot 6.4.39) Out of Band Emissions at Antenna Terminals**

WCDMA, Low channel, 826.4 MHz, 1 GHz to 20 GHz

Agilent 09:57:42 Nov 28, 2007

L

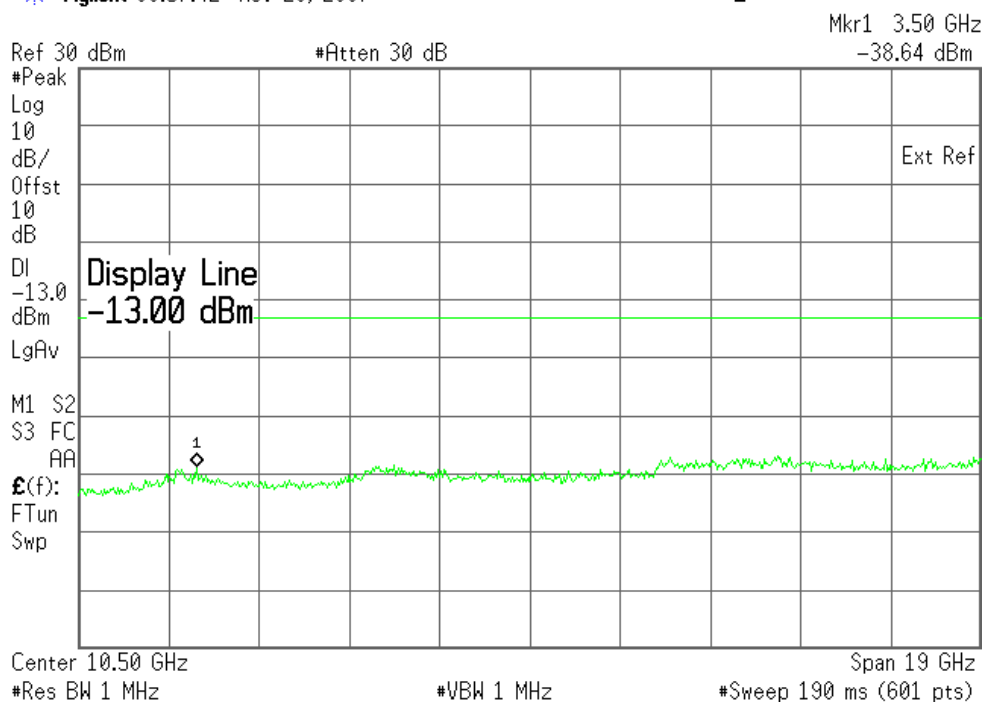

Cellular Harmonics for Ch. 4132 (826.4 MHz)	Level (dBm)
Second	--
Third	--
All others	< -35 dBm up to 20GHz

**SIERRA WIRELESS, INC.**

**Plot 6.4.40) Out of Band Emissions at Antenna Terminals**

WCDMA, Middle channel, 836.4 MHz, 1 MHz to 1 GHz

\* Agilent 10:08:13 Nov 28, 2007 L

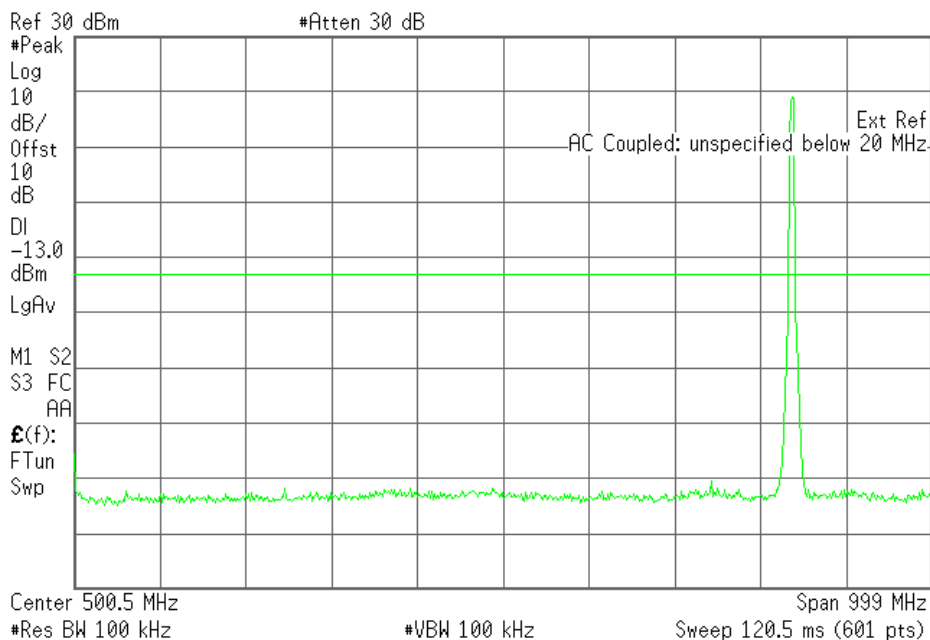

**Plot 6.4.41) Out of Band Emissions at Antenna Terminals**

WCDMA, Middle channel, 836.4 MHz, TX signal +/- 20 MHz

\* Agilent 10:04:46 Nov 28, 2007 L

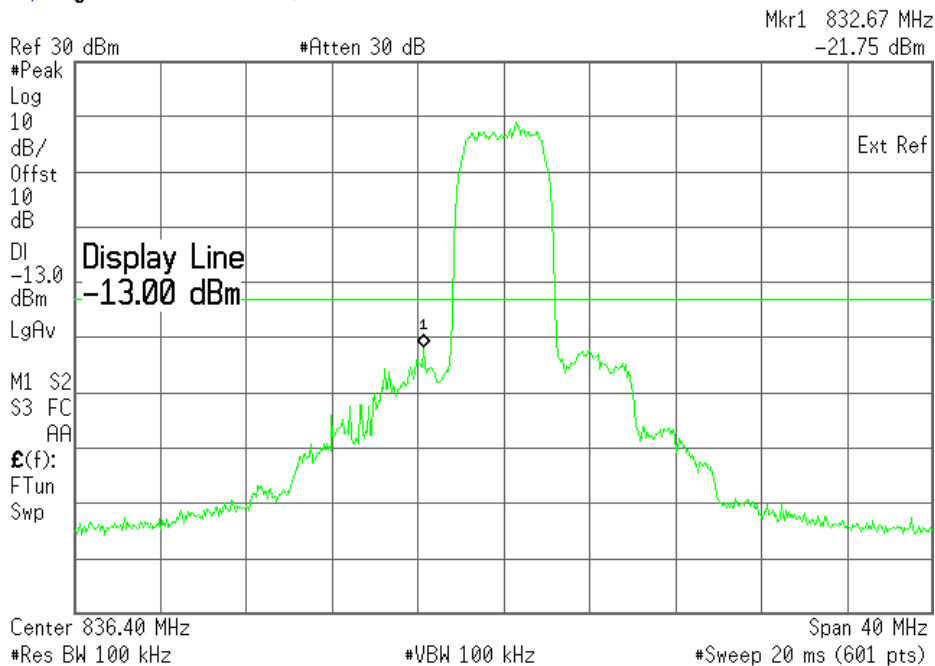

**The strong emission shown in each case is the carrier signal.**

© 2008 Sierra Wireless, Inc.

The contents of this page are subject to the confidentiality information on page one.

**SIERRA WIRELESS, INC.**

**Plot 6.4.42) Out of Band Emissions at Antenna Terminals**

WCDMA, Middle channel, 836.4 MHz, 1 GHz to 20 GHz

Agilent 10:02:32 Nov 28, 2007

L

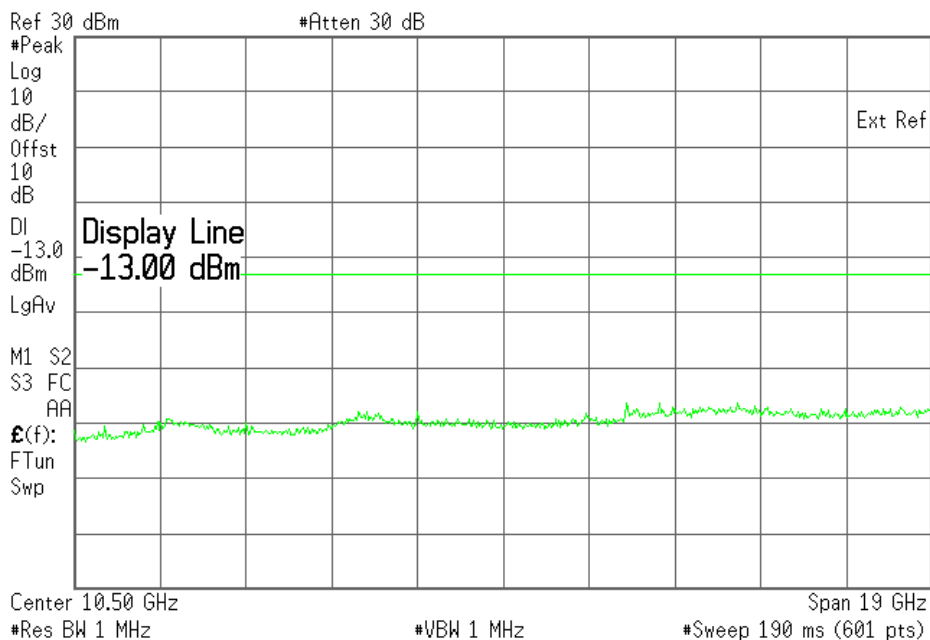

Cellular Harmonics for Ch. 4182 (836.4 MHz)	Level (dBm)
Second	--
Third	--
All others	< -35 dBm up to 20GHz

**SIERRA WIRELESS, INC.**

**Plot 6.4.43) Out of Band Emissions at Antenna Terminals**

WCDMA, High Channel, 846.6 MHz, 1 MHz to 1 GHz

Agilent 10:12:44 Nov 28, 2007 L

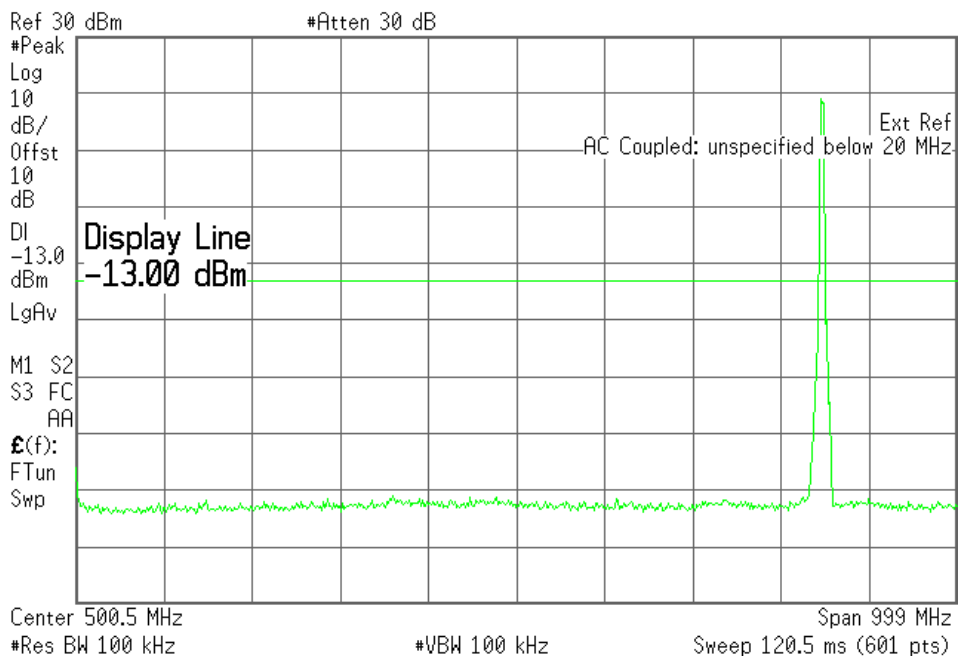

**Plot 6.4.44) Out of Band Emissions at Antenna Terminals**

WCDMA, High Channel, 846.6 MHz, TX signal +/- 20 MHz

Agilent 10:14:25 Nov 28, 2007 L

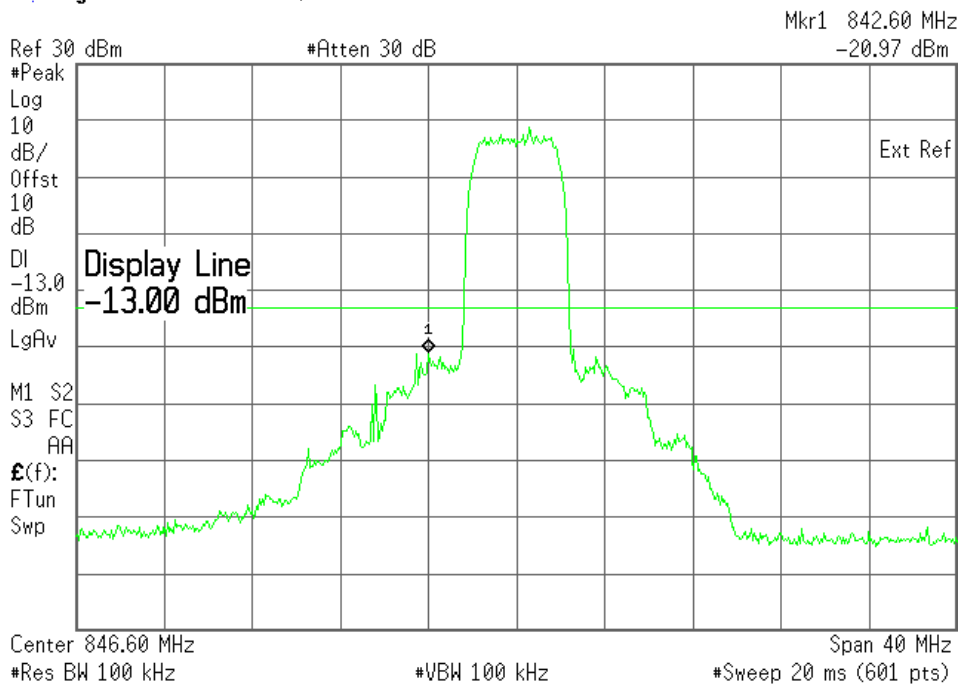

**The strong emission shown in each case is the carrier signal.**

© 2008 Sierra Wireless, Inc.

The contents of this page are subject to the confidentiality information on page one.

**SIERRA WIRELESS, INC.**

**Plot 6.4.45) Out of Band Emissions at Antenna Terminals**  
WCDMA, High Channel, 846.6 MHz, 1 GHz to 20 GHz

Agilent 10:15:58 Nov 28, 2007

L

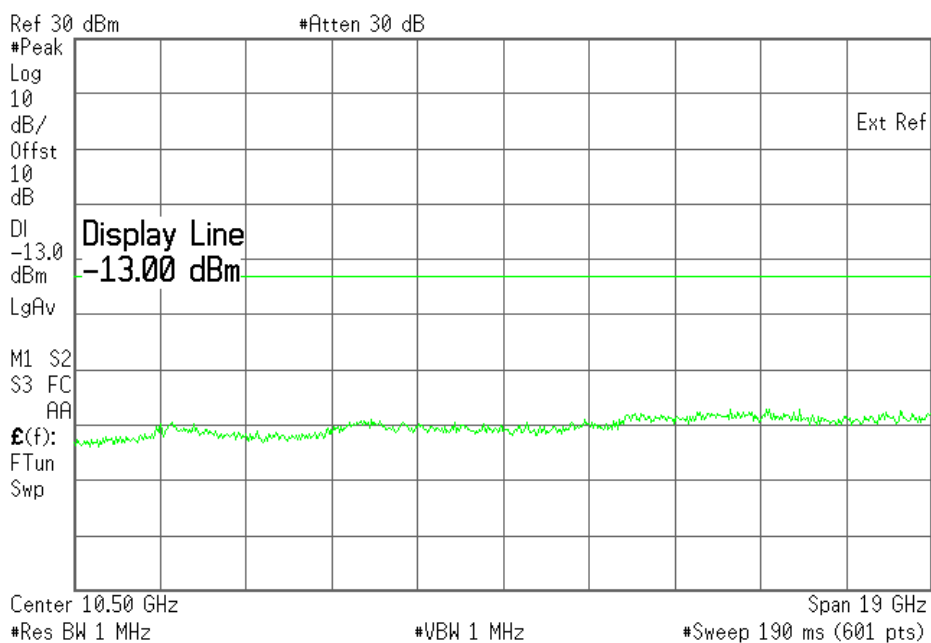

<b>Cellular Harmonics for Ch. 4233 (846.6 MHz)</b>	<b>Level (dBm)</b>
<b>Second</b>	--
<b>Third</b>	--
<b>All others</b>	<b>&lt; -35 dBm up to 20GHz</b>

**SIERRA WIRELESS, INC.**

**Plot 6.4.46) Out of Band Emissions at Antenna Terminals**  
WCDMA, Low channel, 1852.4 MHz, 1 MHz to 1 GHz

Agilent 10:23:06 Nov 28, 2007

L

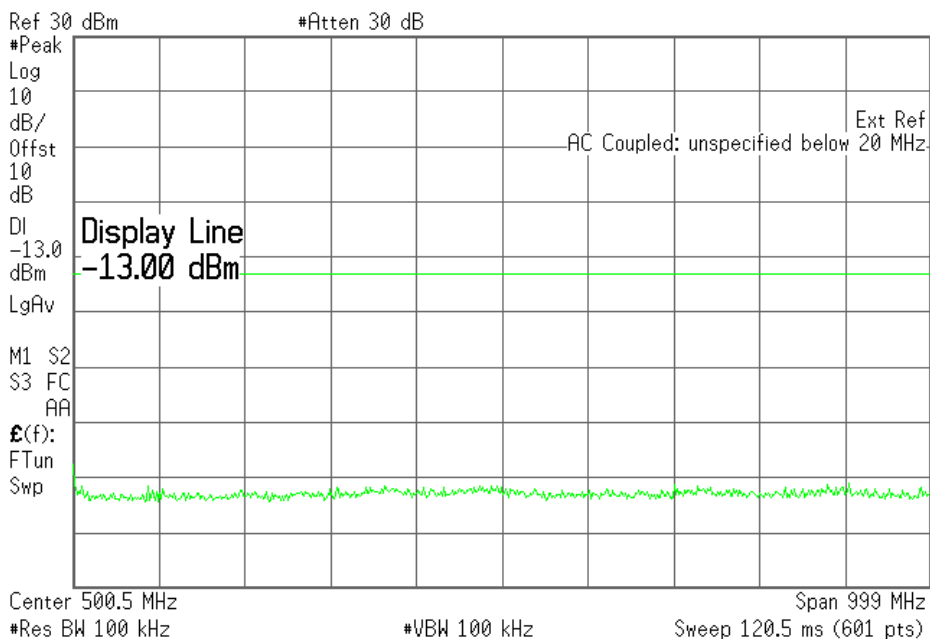

**Plot 6.4.47) Out of Band Emissions at Antenna Terminals**  
WCDMA, Low channel, 1852.4 MHz, TX signal +/- 20 MHz

Agilent 10:25:35 Nov 28, 2007

L

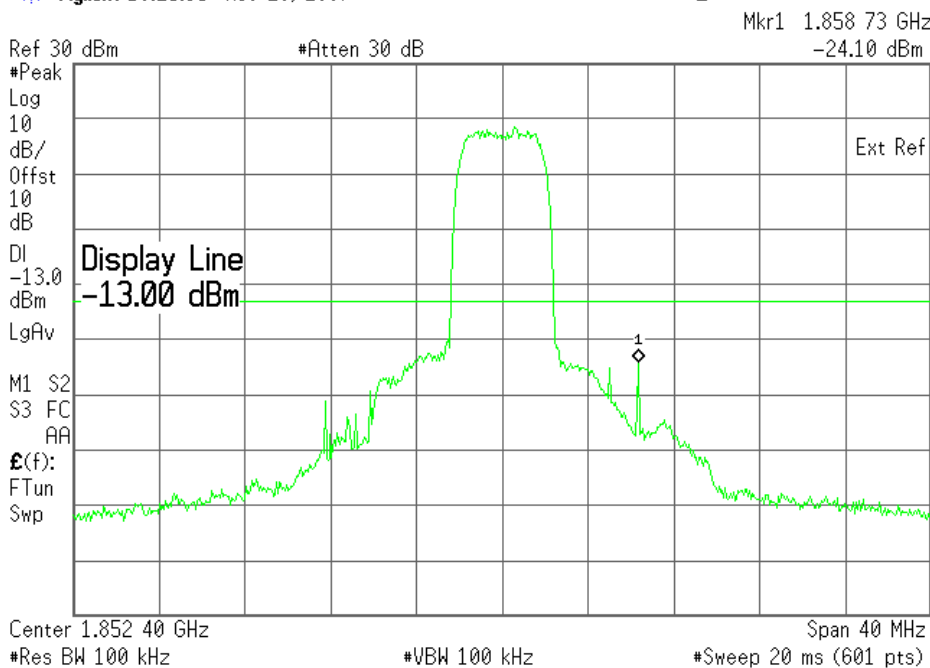

© 2008 Sierra Wireless, Inc.

The contents of this page are subject to the confidentiality information on page one.



**SIERRA WIRELESS, INC.**

**Plot 6.4.48) Out of Band Emissions at Antenna Terminals**

WCDMA, Low channel, 1852.4 MHz, 1 GHz to 20 GHz

\* Agilent 10:28:50 Nov 28, 2007

L

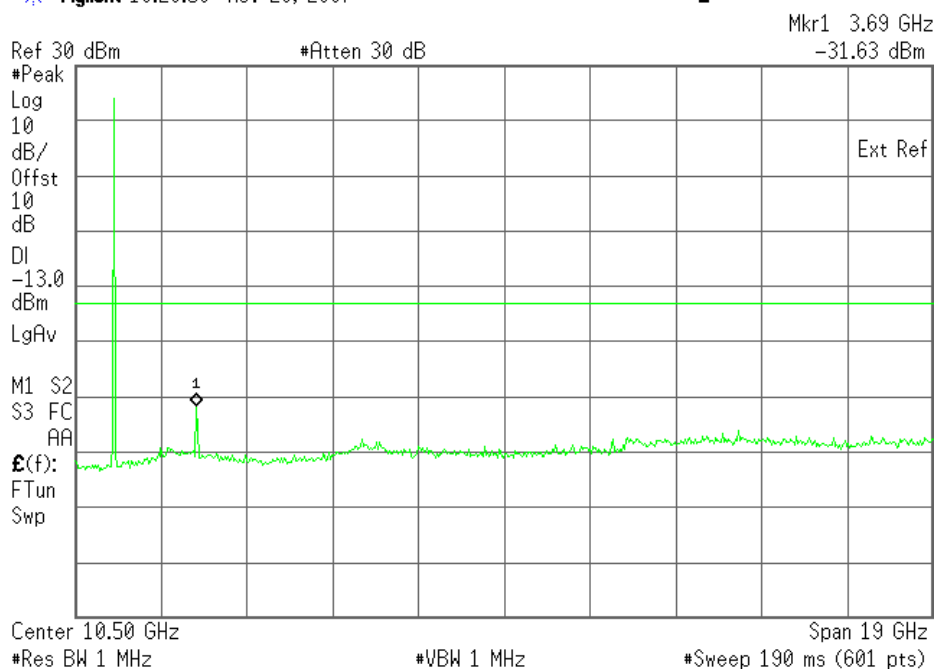

**The strong emission shown is the carrier signal.**

PCS Harmonics for Ch. 9262 (1852.4 MHz)	Level (dBm)
<b>Second</b>	<b>- 31.63 dBm</b>
<b>Third</b>	<b>--</b>
<b>All others</b>	<b>&lt; -35 dBm up to 20GHz</b>

SIERRA WIRELESS, INC.

**Plot 6.4.49) Out of Band Emissions at Antenna Terminals**

WCDMA, Middle channel, 1880 MHz, 1 MHz to 1 GHz

Agilent 10:39:09 Nov 28, 2007

L

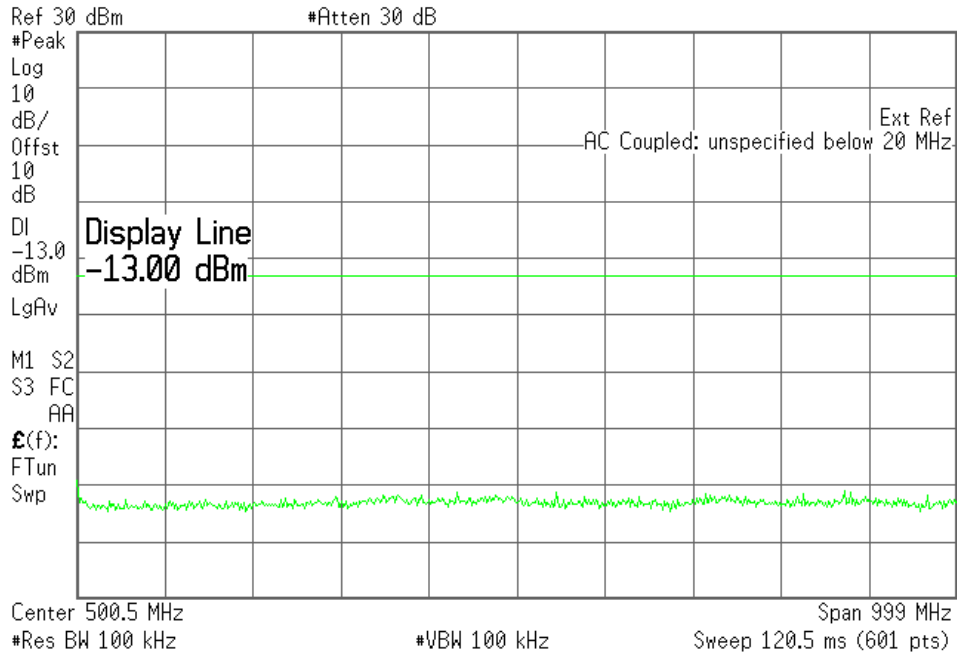

**Plot 6.4.50) Out of Band Emissions at Antenna Terminals**

WCDMA, Middle channel, 1880 MHz, TX signal +/- 20 MHz

Agilent 10:37:47 Nov 28, 2007

L

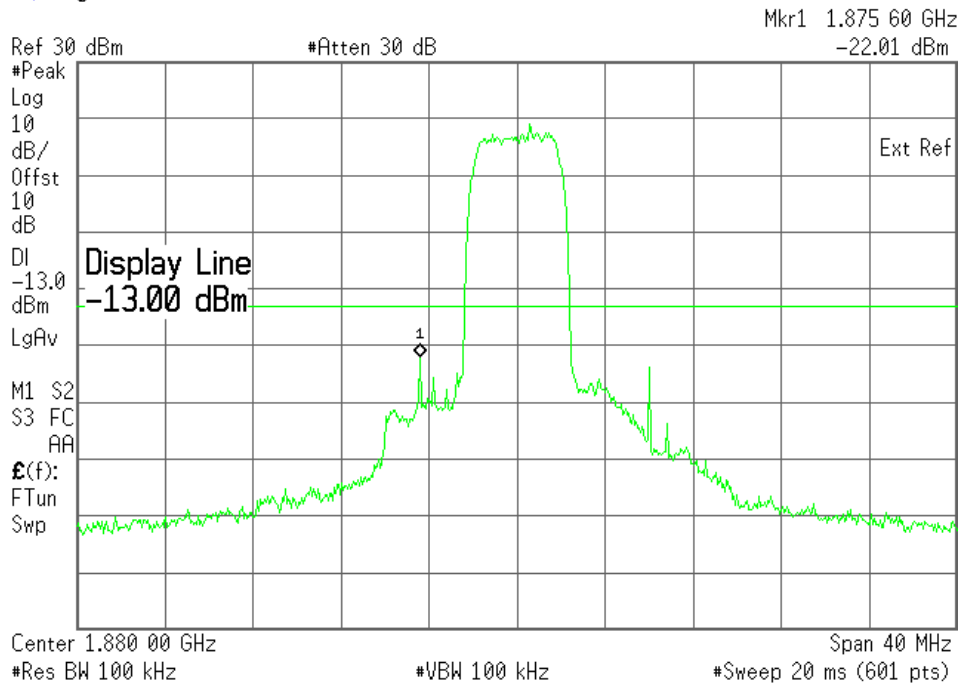

© 2008 Sierra Wireless, Inc.

The contents of this page are subject to the confidentiality information on page one.

**SIERRA WIRELESS, INC.**

**Plot 6.4.51) Out of Band Emissions at Antenna Terminals**

WCDMA, Middle channel, 1880 MHz, 1 GHz to 20 GHz

\* Agilent 10:33:17 Nov 28, 2007

L

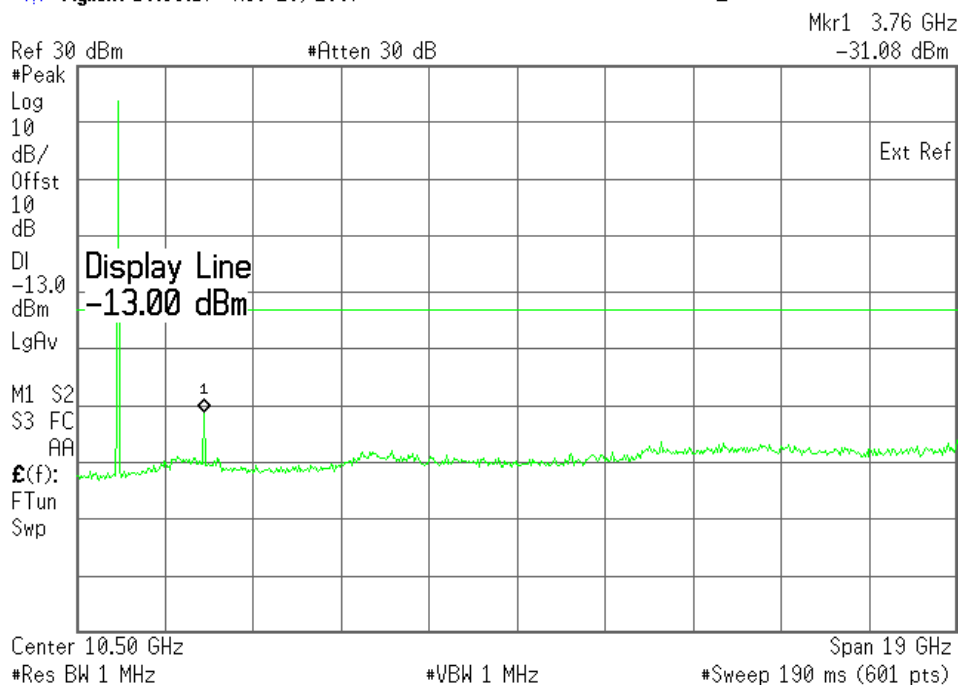

**The strong emission shown is the carrier signal.**

PCS Harmonics for Ch. 9400 (1880.0 MHz)	Level (dBm)
Second	- 31.08 dBm
Third	--
All others	< -35 dBm up to 20GHz

**SIERRA WIRELESS, INC.**

**Plot 6.4.52) Out of Band Emissions at Antenna Terminals**

WCDMA, High channel, 1907.6 MHz, 1 MHz to 1 GHz

\* Agilent 10:42:04 Nov 28, 2007

L

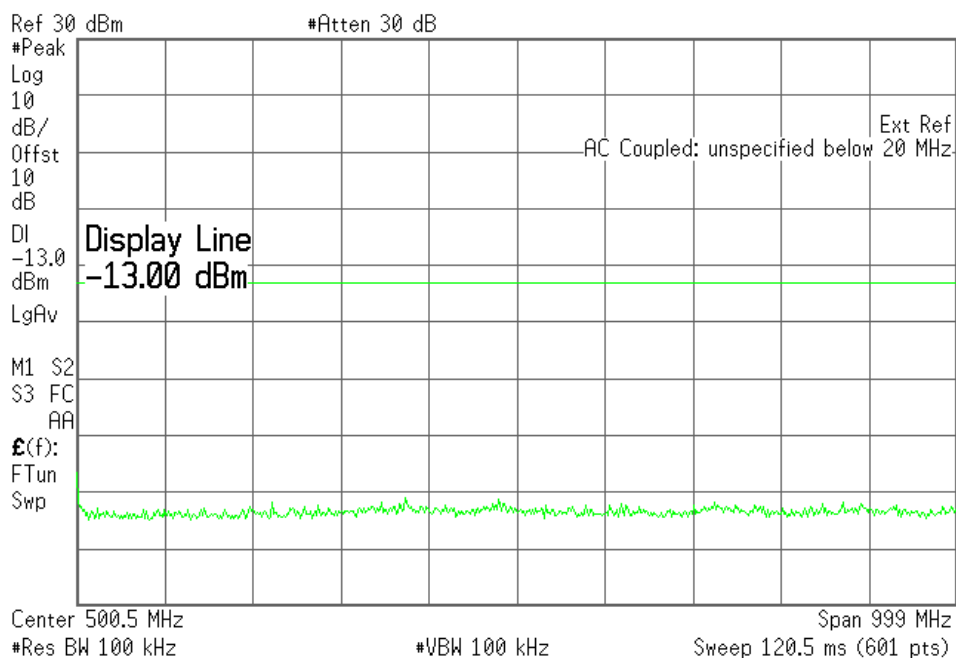

**Plot 6.4.53) Out of Band Emissions at Antenna Terminals**

WCDMA, High channel, 1907.6 MHz, TX signal +/- 20 MHz

\* Agilent 10:44:26 Nov 28, 2007

L

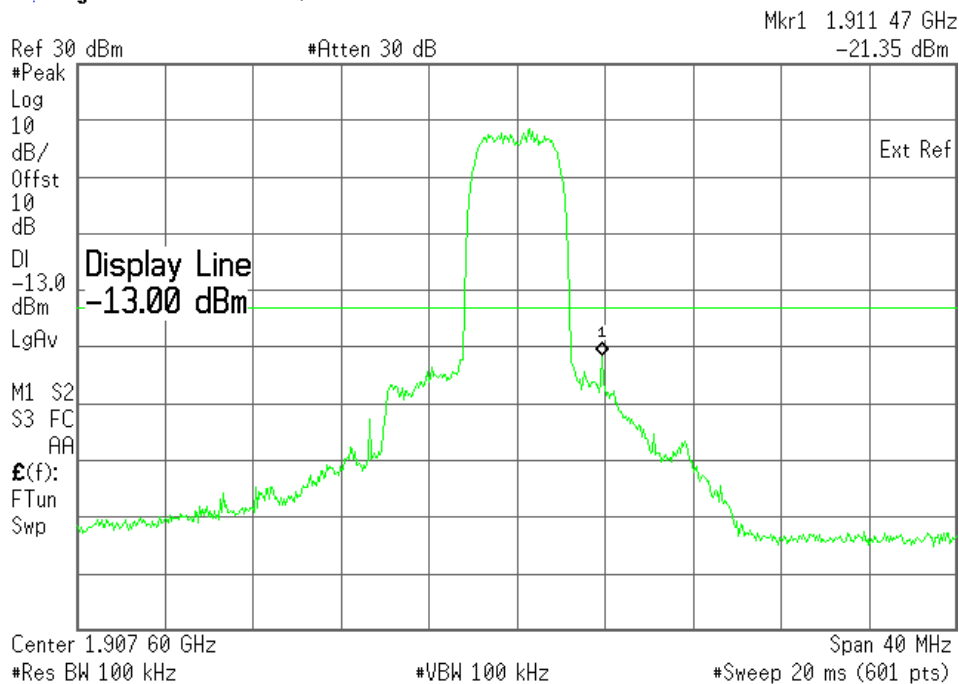

© 2008 Sierra Wireless, Inc.

The contents of this page are subject to the confidentiality information on page one.

**SIERRA WIRELESS, INC.**

**Plot 6.4.54) Out of Band Emissions at Antenna Terminals**

WCDMA, High channel, 1907.6 MHz, 1 GHz to 20 GHz

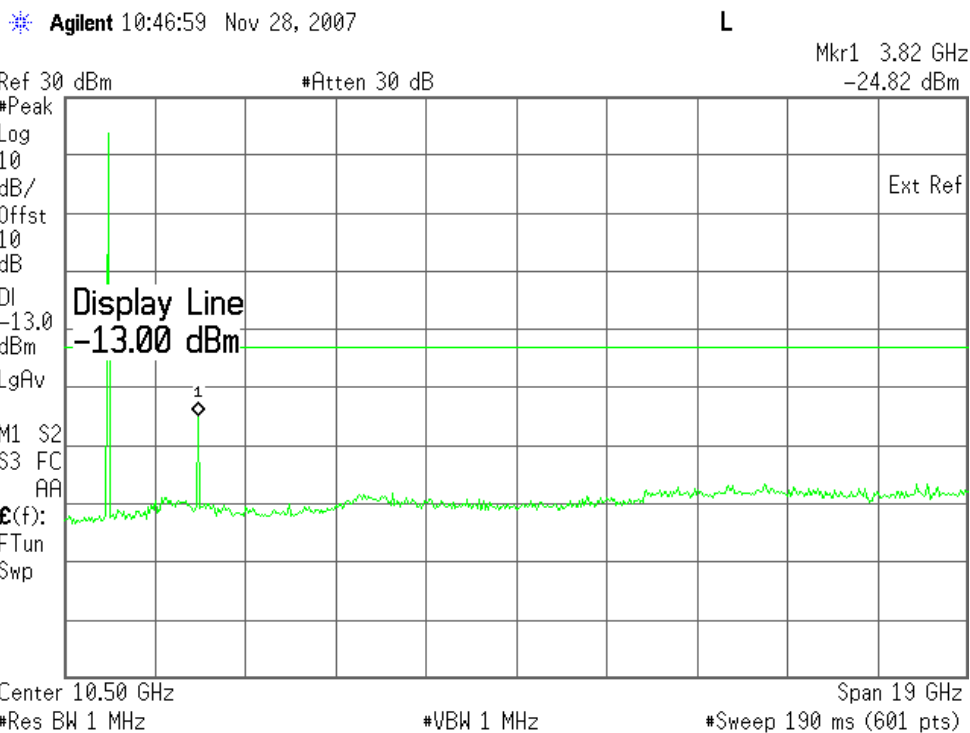

**The strong emission shown is the carrier signal.**

PCS Harmonics for Ch. 9538 (1907.6 MHz)	Level (dBm)
Second	- 24.82 dBm
Third	--
All others	< -35 dBm up to 20GHz

# SIERRA WIRELESS, INC.

## 7 Block Edge Compliance

FCC Part 22H/24E

### 7.1 Test Procedure

The transmitter output was connected to a Rohde & Schwarz CMU200 Test Set and configured to operate at maximum power. The block edge emissions were measured at the required operating frequencies in each band on the Spectrum Analyzer.

#### Test Setup

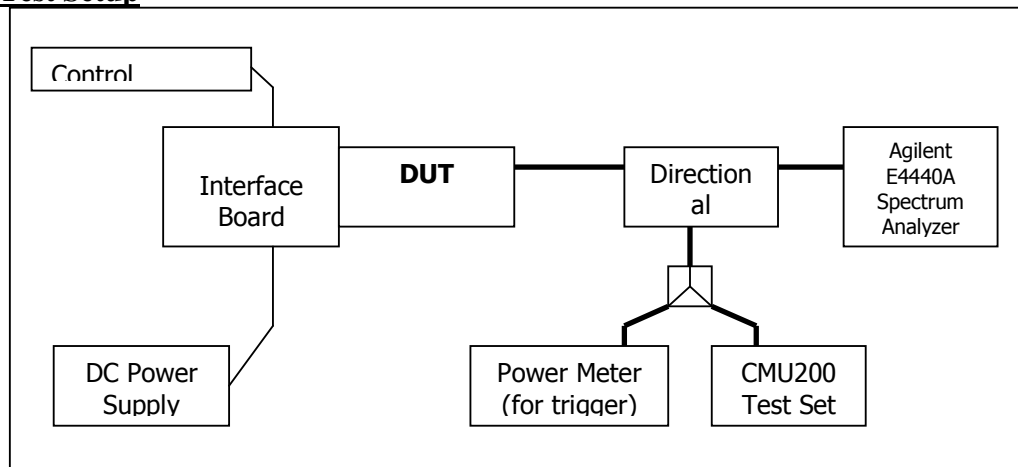

### 7.2 Test Equipment

#### Instrument List

EQUIPMENT	MANUFACTURER	MODEL NO.	SERIAL NO.	CAL. DATE
Control Computer	TC	Generic PC	100488	N/A
Wireless Test Set	Rohde & Schwarz	CMU200	111682	November 18, 2008
Spectrum Analyzer	Agilent	PSA E4440A	US41421268	March 11, 2008
DC Power Supply	HP	6632A	3530A	N/A
Interface Board	Shop built	Minnow	N/A	N/A
Directional Coupler	Mini-Circuits	ZA3PD-2	N/A	N/A

### 7.3 Test Results

Block Test	Frequency Boundaries (MHz)	Channels Tested	Corresponding Plots	Result
1	GMSK: Below 824 MHz, above 849 MHz	128, 251	7.4.1, 7.4.2	Complies
2	8PSK: Below 824 MHz, above 849 MHz	128, 251	7.4.3, 7.4.4	Complies
3	GMSK: Below 1850MHz, above 1910MHz	512, 810	7.4.5, 7.4.6	Complies
4	8PSK: Below 1850MHz, above 1910MHz	512, 810	7.4.7, 7.4.8	Complies
Block Test	Frequency Boundaries (MHz)	Channels Tested	Corresponding Plots	Result
1	WCDMA: Below 824MHz, above 849MHz	4132, 4233	7.4.9, 7.4.10	Complies
2	WCDMA: Below 1850MHz, above 1910MHz	9262, 9538	7.4.11, 7.4.12	Complies

© 2008 Sierra Wireless, Inc.

The contents of this page are subject to the confidentiality information on page one.

SIERRA WIRELESS, INC.

7.4 Test Plots

Plot 7.4.1) GSMK; Cellular low channel, below 824 MHz

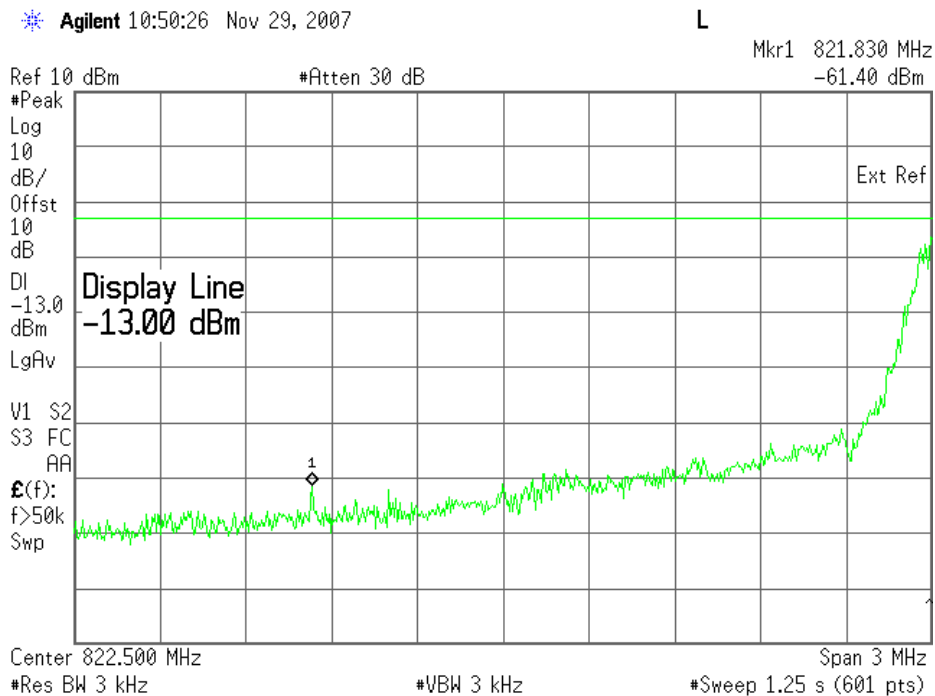

Plot 7.4.2) GSMK; Cellular high channel, above 849 MHz

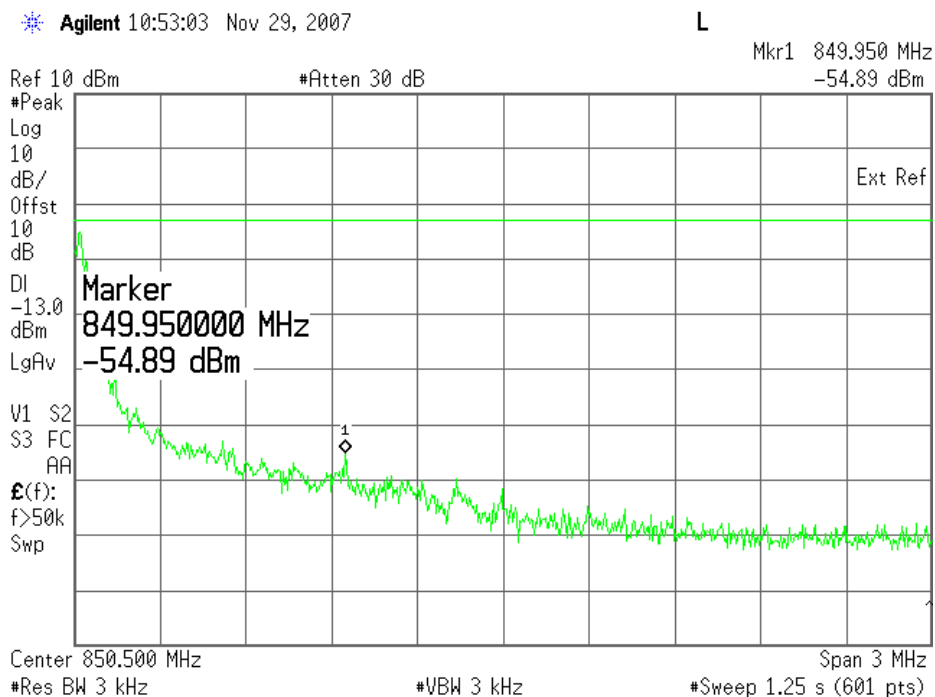

© 2008 Sierra Wireless, Inc.

The contents of this page are subject to the confidentiality information on page one.

# SIERRA WIRELESS, INC.

## Plot 7.4.3) 8-PSK; Cellular low channel, below 824 MHz



## Plot 7.4.4) 8-PSK; Cellular high channel, above 849 MHz



© 2008 Sierra Wireless, Inc.

The contents of this page are subject to the confidentiality information on page one.



**SIERRA WIRELESS, INC.**

**Plot 7.4.5) GMSK; PCS low channel, below 1850 MHz**

Agilent 11:15:55 Nov 29, 2007

L

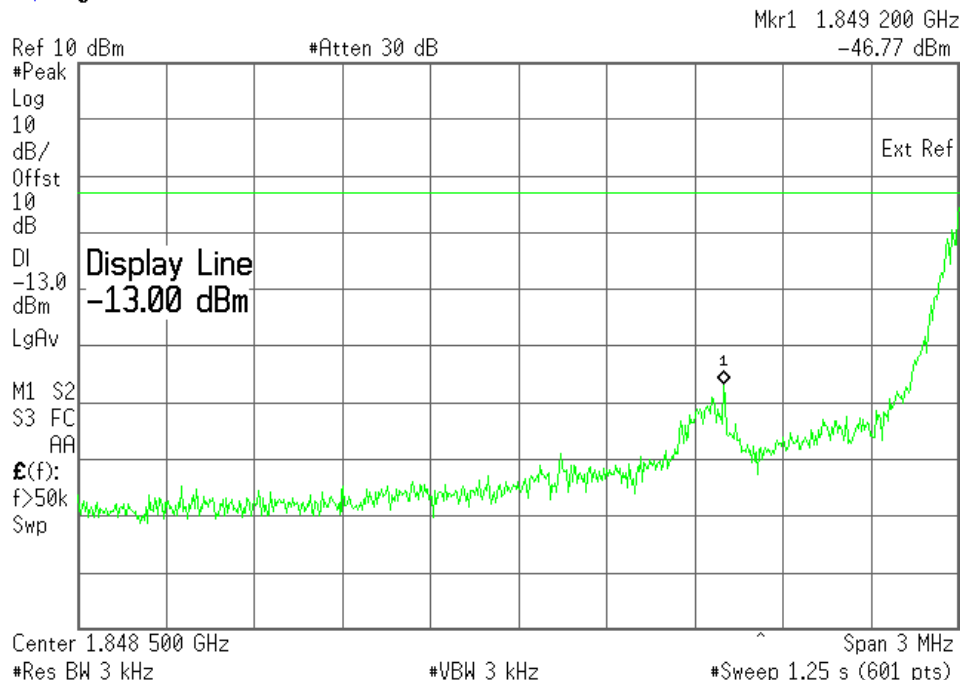

**Plot 7.4.6) GMSK; PCS high channel, above 1910 MHz**

Agilent 11:17:45 Nov 29, 2007

L

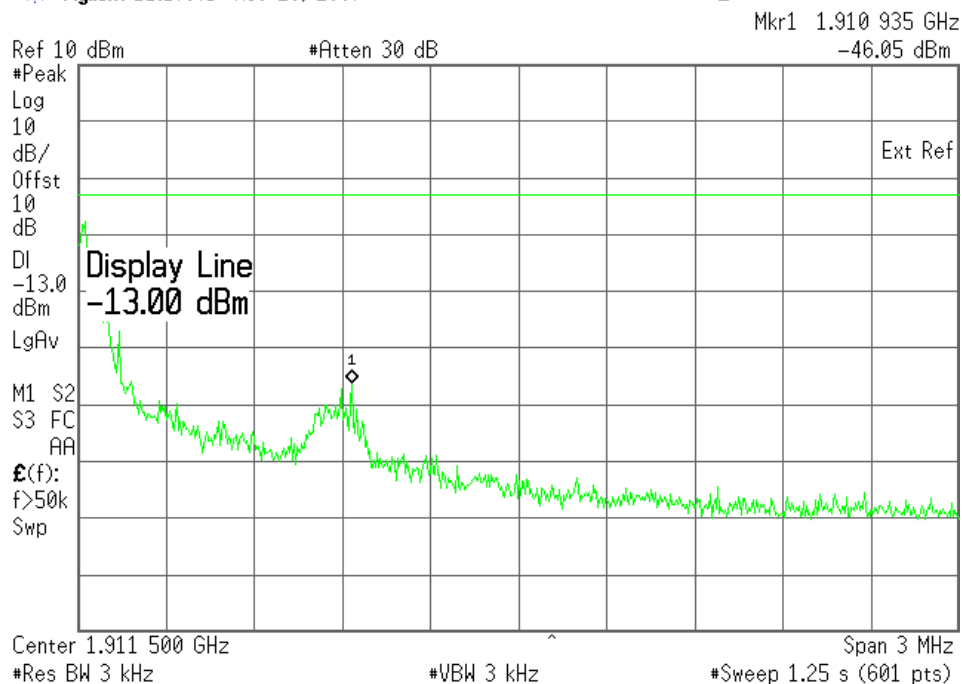

© 2008 Sierra Wireless, Inc.

The contents of this page are subject to the confidentiality information on page one.

**SIERRA WIRELESS, INC.**

**Plot 7.4.7) 8-PSK; PCS low channel, below 1850 MHz**

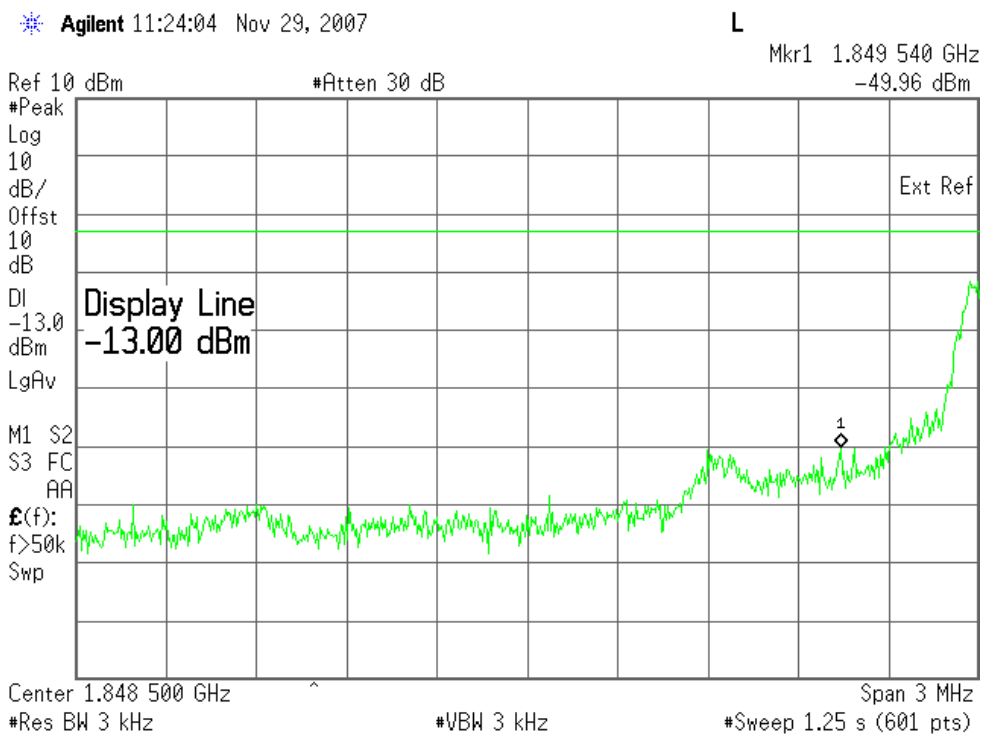

**Plot 7.4.8) 8-PSK; PCS high channel, above 1910 MHz**



© 2008 Sierra Wireless, Inc.

The contents of this page are subject to the confidentiality information on page one.

**SIERRA WIRELESS, INC.**

**Plot 7.4.9) WCDMA; Cellular low channel, below 824 MHz**

Agilent 10:27:34 Nov 29, 2007

L

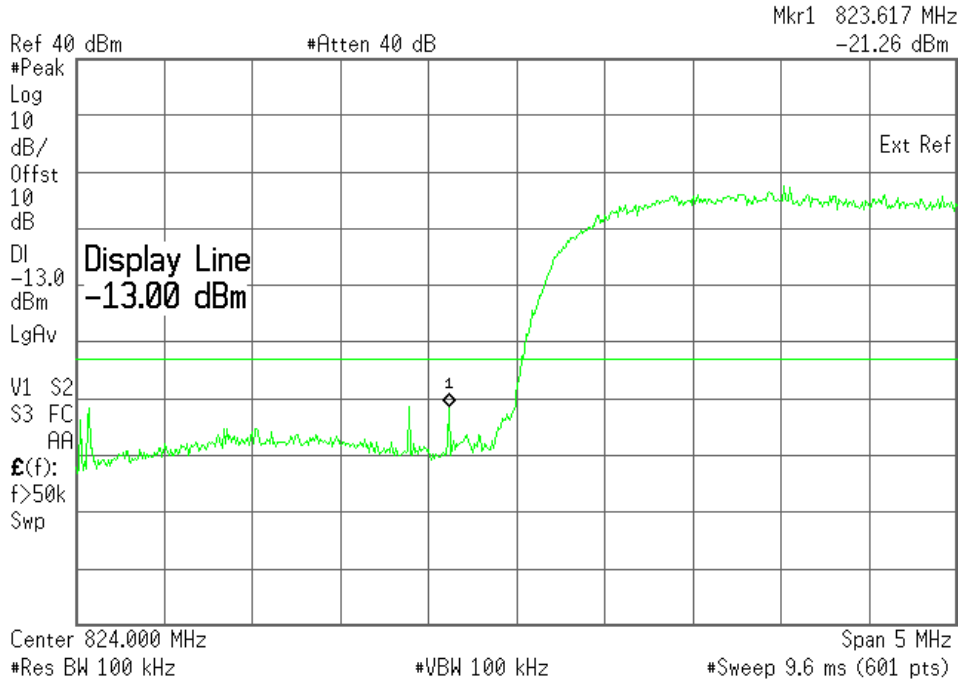

**Plot 7.4.10) WCDMA; Cellular high channel, above 849 MHz**

Agilent 10:30:58 Nov 29, 2007

L

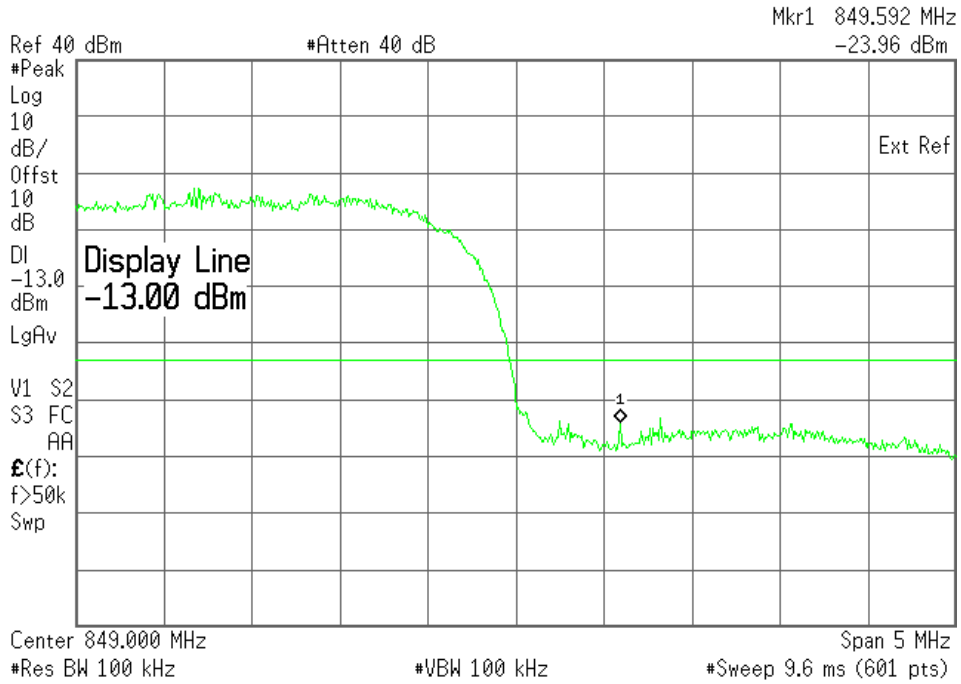

© 2008 Sierra Wireless, Inc.

The contents of this page are subject to the confidentiality information on page one.

**SIERRA WIRELESS, INC.**

**Plot 7.4.11) WCDMA; PCS low channel, below 1850 MHz**

Agilent 10:34:13 Nov 29, 2007

L

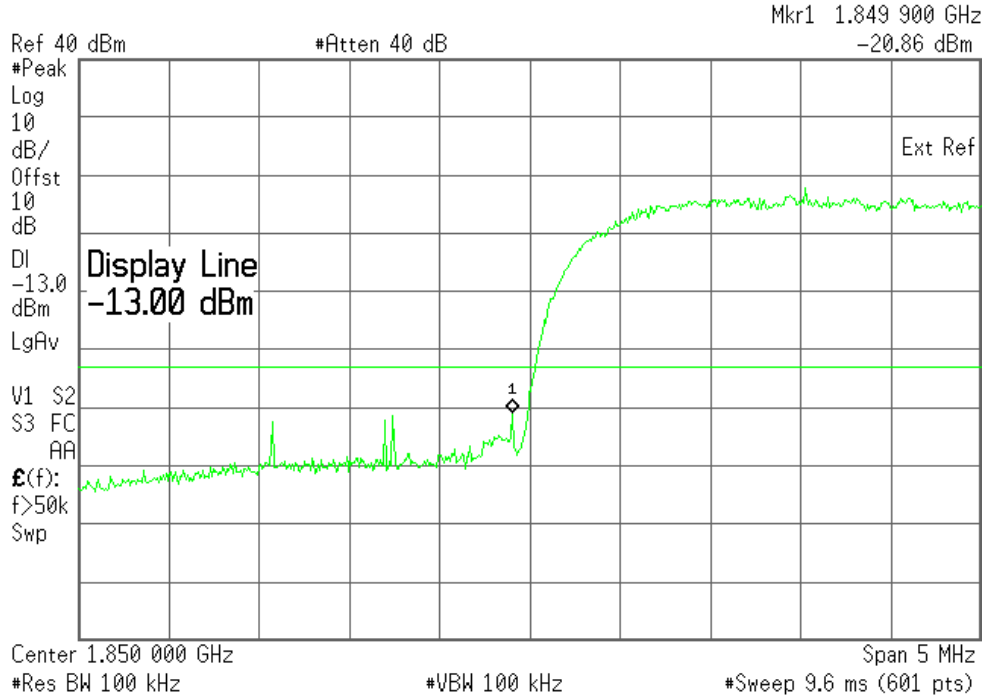

**Plot 7.4.12) WCDMA; PCS high channel, above 1910 MHz**

Agilent 10:39:34 Nov 29, 2007

L

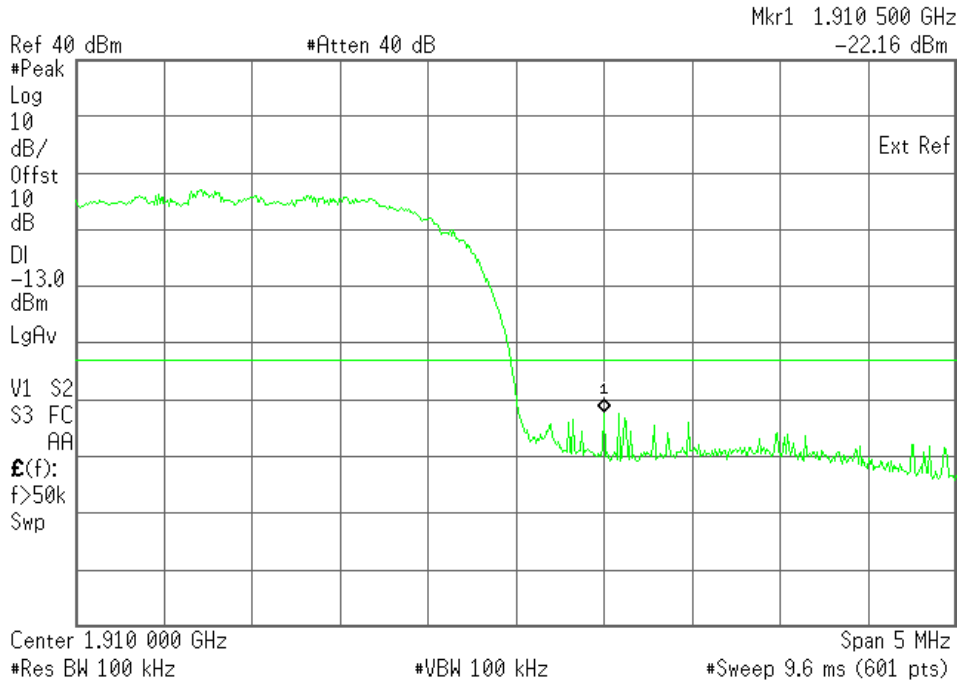

© 2008 Sierra Wireless, Inc.

The contents of this page are subject to the confidentiality information on page one.

# SIERRA WIRELESS, INC.

## 8 Frequency Stability Versus Temperature

### FCC 2.1055

#### 8.1 Summary of Results

The MC8790 Frequency Stability versus temperature meets the requirement of being within  $\pm 0.1$ ppm of the received base station frequency.

#### 8.2 Test Procedure

The MC8790 was placed inside the temperature chamber. The transmitting frequency error is measured at 25 degrees C, then the temperature is set to +50 degrees C and allowed to stabilize. After sufficient soak time, the transmitting frequency error is measured. The temperature is decreased by 10 degrees, allowed to stabilize and soak, then the measurement is repeated. This is repeated until -30 degrees C is completed. The process is then repeated back up to +50 degrees C. Frequency metering included internal averaging of the CMU200 to stabilize the reading. Reference power supply voltage for these tests is 3.3 volts.

#### Test Setup

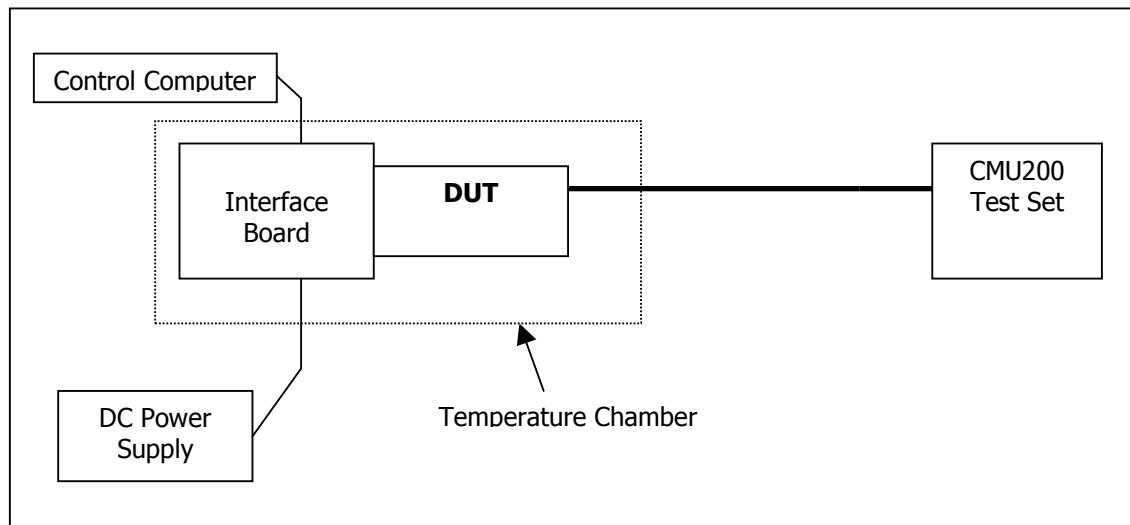

#### 8.3 Test Equipment

EQUIPMENT	MANUFACTURER	MODEL NO.	SERIAL NO.	CAL. DATE
Control Computer	TC	Generic PC	100488	N/A
Wireless Test Set	Rohde & Schwarz	CMU200	111682	November 18, 2008
Spectrum Analyzer	Agilent	PSA E4440A	US41421268	March 11, 2008
DC Power Supply	HP	6632A	3530A	N/A
Interface Board	Shop built	Minnow	N/A	N/A
Directional Coupler	Mini-Circuits	ZA3PD-2	N/A	N/A

© 2008 Sierra Wireless, Inc.

The contents of this page are subject to the confidentiality information on page one.

# SIERRA WIRELESS, INC.

## 8.4 Test Results

### Low to High Temperature Frequency Error

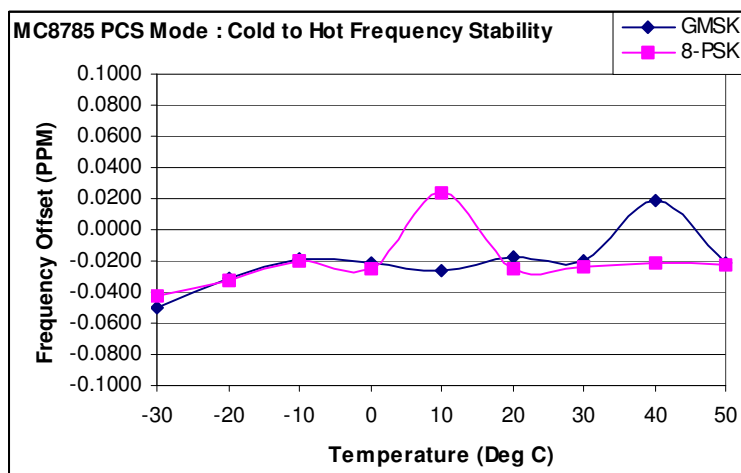
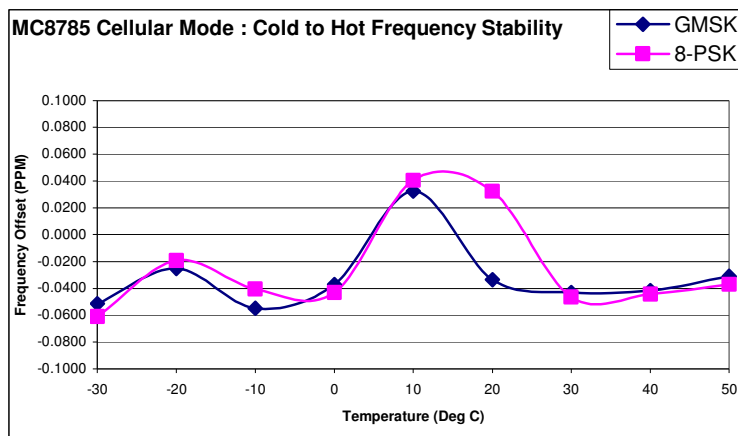

### Low to High Temperature Tabular Readings

Temp.(C)	Cellular Mode: 824MHz to 848MHz				PCS Mode: 1850MHz to 1909MHz			
	GMSK Mode		8-PSK Mode		GMSK Mode		8-PSK Mode	
	Offset (Hz)	Offset (ppm)	Offset (Hz)	Offset (ppm)	Offset (Hz)	Offset (ppm)	Offset (Hz)	Offset (ppm)
-30	-43	-0.0514	-51	-0.0610	-94	-0.0500	-79	-0.0420
-20	-21	-0.0251	-16	-0.0191	-59	-0.0314	-60	-0.0319
-10	-46	-0.0550	-34	-0.0406	-35	-0.0186	-37	-0.0197
0	-31	-0.0371	-36	-0.0430	-41	-0.0218	-48	-0.0255
10	27	0.0323	34	0.0406	-49	-0.0261	44	0.0234
20	-28	-0.0335	27	0.0323	-34	-0.0181	-47	-0.0250
30	-36	-0.0430	-39	-0.0466	-38	-0.0202	-44	-0.0234
40	-35	-0.0418	-37	-0.0442	36	0.0191	-41	-0.0218
50	-26	-0.0311	-31	-0.0371	-39	-0.0207	-42	-0.0223

**SIERRA WIRELESS, INC.**

Low to High Temperature Frequency Error

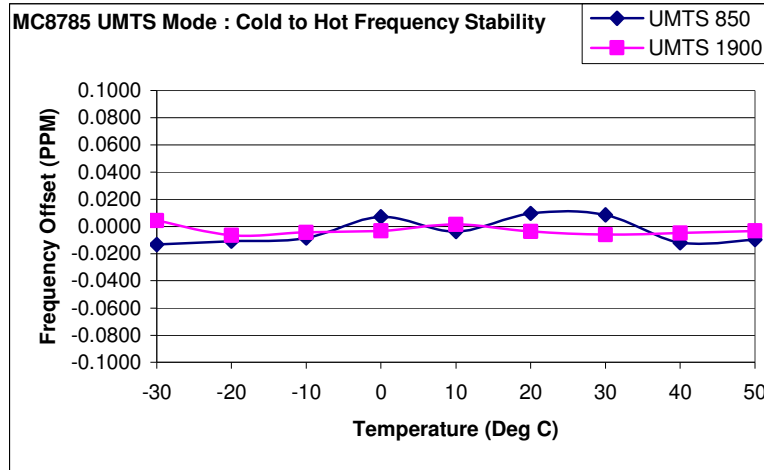

Low to High Temperature Tabular Readings

Temp.(C)	UMTS Mode: 826MHz to 846MHz		UMTS Mode: 1850MHz to 1909MHz	
	Offset (Hz)	Offset (ppm)	Offset (Hz)	Offset (ppm)
-30	-11	-0.0132	8	0.0043
-20	-9	-0.0108	-12	-0.0064
-10	-7	-0.0084	-8	-0.0043
0	6	0.0072	-6	-0.0032
10	-3	-0.0036	3	0.0016
20	8	0.0096	-7	-0.0037
30	7	0.0084	-11	-0.0059
40	-10	-0.0120	-9	-0.0048
50	-8	-0.0096	-6	-0.0032

# SIERRA WIRELESS, INC.

## High to Low Temperature Frequency Error

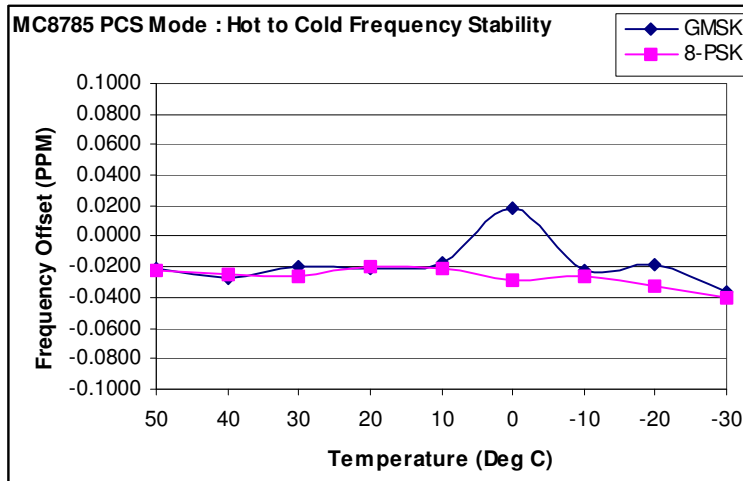
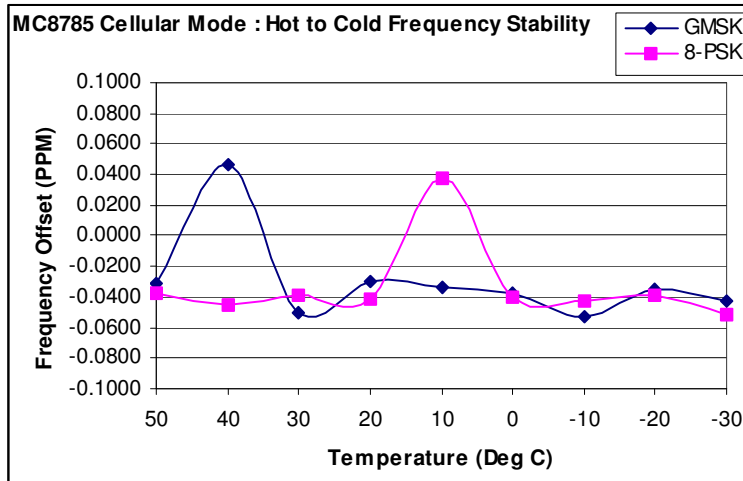

## High to Low Temperature Tabular Readings

Temp.(C)	Cellular Mode: 824MHz to 848MHz				PCS Mode: 1850MHz to 1909MHz			
	GSMK Mode		8-PSK Mode		GSMK Mode		8-PSK Mode	
	Offset (Hz)	Offset (ppm)	Offset (Hz)	Offset (ppm)	Offset (Hz)	Offset (ppm)	Offset (Hz)	Offset (ppm)
50	-26	-0.0311	-31	-0.0371	-39	-0.0207	-42	-0.0223
40	39	0.0466	-38	-0.0454	-52	-0.0277	-46	-0.0245
30	-42	-0.0502	-32	-0.0383	-37	-0.0197	-49	-0.0261
20	-25	-0.0299	-35	-0.0418	-39	-0.0207	-37	-0.0197
10	-28	-0.0335	31	0.0371	-32	-0.0170	-39	-0.0207
0	-31	-0.0371	-34	-0.0406	36	0.0191	-53	-0.0282
-10	-44	-0.0526	-36	-0.0430	-42	-0.0223	-50	-0.0266
-20	-29	-0.0347	-33	-0.0394	-35	-0.0186	-61	-0.0324
-30	-36	-0.0430	-43	-0.0514	-68	-0.0362	-75	-0.0399



**SIERRA WIRELESS, INC.**

High to Low Temperature Frequency Error

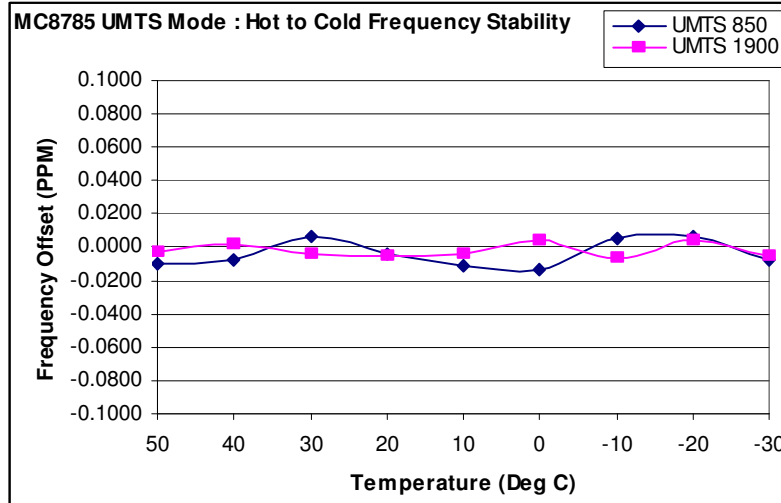

High to Low Temperature Tabular Readings

Temp.(C)	UMTS Mode: 826MHz to 846MHz		UMTS Mode: 1850MHz to 1909MHz	
	Offset (Hz)	Offset (Hz)	Offset (ppm)	Offset (ppm)
50	-8	-0.0096	-6	-0.0032
40	-6	-0.0072	4	0.0021
30	5	0.0060	-8	-0.0043
20	-3	-0.0036	-10	-0.0053
10	-9	-0.0108	-8	-0.0043
0	-11	-0.0132	7	0.0037
-10	4	0.0048	-12	-0.0064
-20	5	0.0060	8	0.0043
-30	-6	-0.0072	-9	-0.0048

## 9 Frequency Stability Versus Voltage

### FCC 2.1055

#### 9.1 Summary of Results

The EUT is specified to operate with a supply voltage of between 2.9 VDC and 3.6 VDC with a nominal voltage of 3.3 VDC. It meets the frequency stability limit of less than 0.1ppm when supply voltage varies within the specified limits. Operation is prohibited by firmware while the DC supply voltage is out of the specified range.

#### 9.2 Test Procedure

The MC8790 was connected to a DC Power Supply and a UMTS test set (CMU 200) with frequency error measurement capability. The power supply output is adjusted to the test voltage as measured at the input terminals to the module while transmitting. A voltmeter was used to confirm the terminal voltage. The peak frequency error is recorded (worst case). The test voltages are 2.9 volts to 3.6 volts.

#### Test Setup

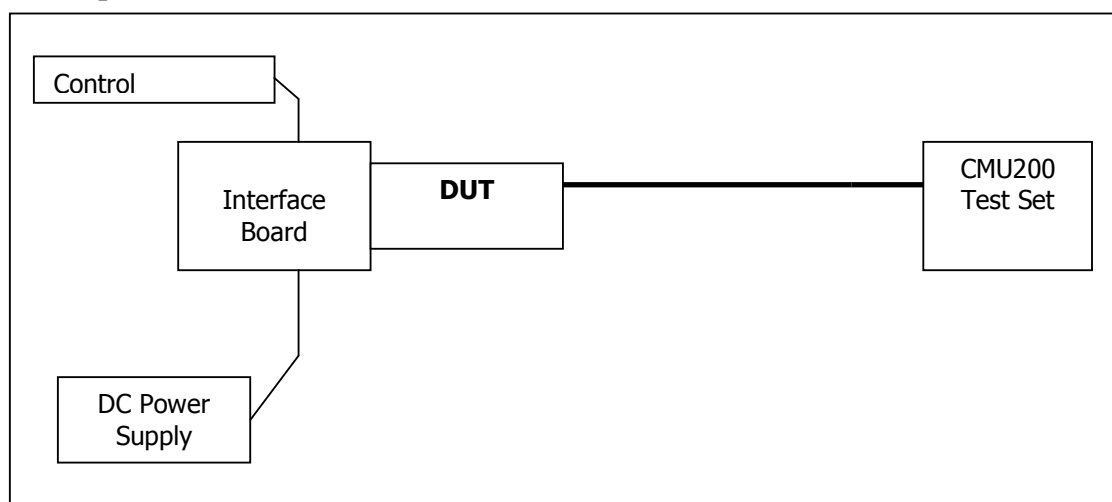

#### 9.3 Test Equipment

EQUIPMENT	MANUFACTURER	MODEL NO.	SERIAL NO.	CAL. DATE
Control Computer	TC	Generic PC	100488	N/A
Wireless Test Set	Rohde & Schwarz	CMU200	111682	November 18, 2008
Spectrum Analyzer	Agilent	PSA E4440A	US41421268	March 11, 2008
DC Power Supply	HP	6632A	3530A	N/A
Interface Board	Shop built	Minnow	N/A	N/A
Directional Coupler	Mini-Circuits	ZA3PD-2	N/A	N/A

SIERRA WIRELESS, INC.

9.4 Test Results

Frequency Error Over Voltage

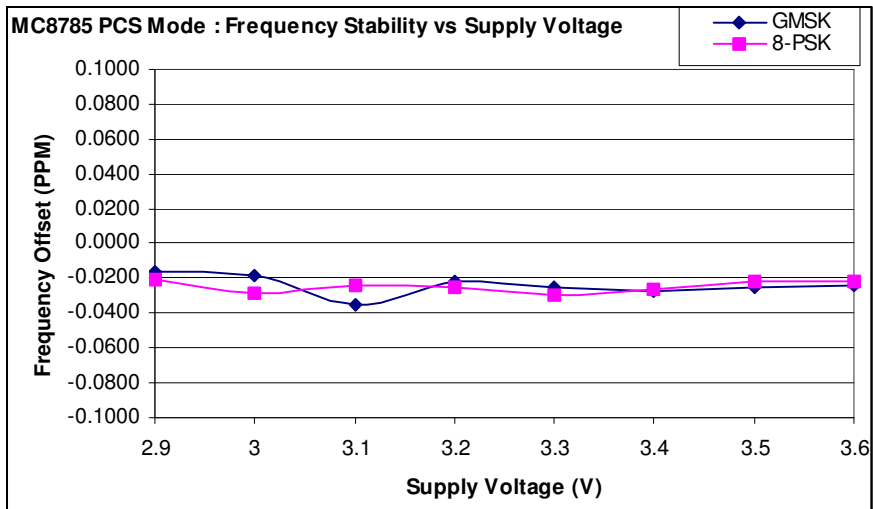
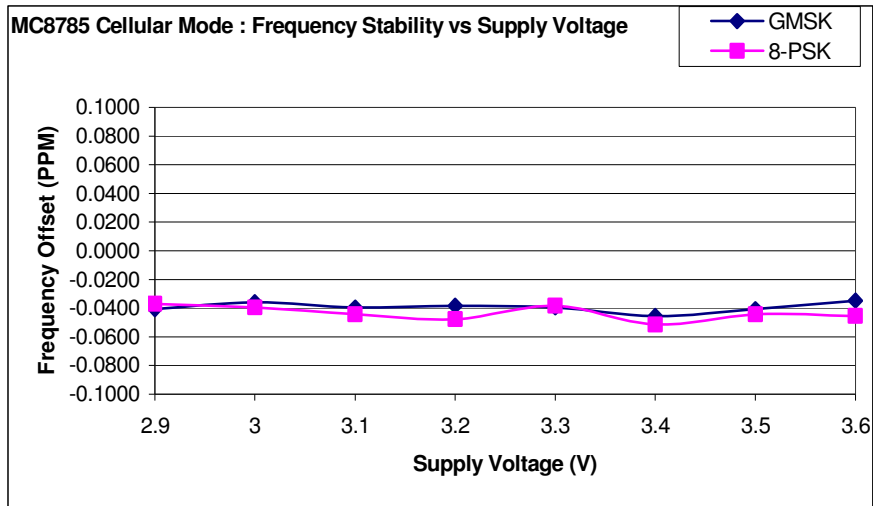

**SIERRA WIRELESS, INC.**

GSM Frequency Error Over Voltage Tabular Data

Supply (V)	Cellular Mode: 824MHz to 848MHz				PCS Mode: 1850MHz to 1909MHz			
	GMSK Mode		8-PSK Mode		GMSK Mode		8-PSK Mode	
	Offset (Hz)	Offset (ppm)	Offset (Hz)	Offset (ppm)	Offset (Hz)	Offset (ppm)	Offset (Hz)	Offset (ppm)
2.9	-34	-0.0406	-31	-0.0371	-31	-0.0165	-39	-0.0207
3.0	-30	-0.0359	-33	-0.0394	-34	-0.0181	-53	-0.0282
3.1	-33	-0.0394	-37	-0.0442	-67	-0.0356	-45	-0.0239
3.2	-32	-0.0383	-40	-0.0478	-42	-0.0223	-48	-0.0255
3.3	-33	-0.0394	-32	-0.0383	-48	-0.0255	-55	-0.0293
3.4	-38	-0.0454	-43	-0.0514	-51	-0.0271	-49	-0.0261
3.5	-34	-0.0406	-37	-0.0442	-47	-0.0250	-41	-0.0218
3.6	-29	-0.0347	-38	-0.0454	-45	-0.0239	-42	-0.0223

**SIERRA WIRELESS, INC.**

UMTS Frequency Error Over Voltage, Tabular Data

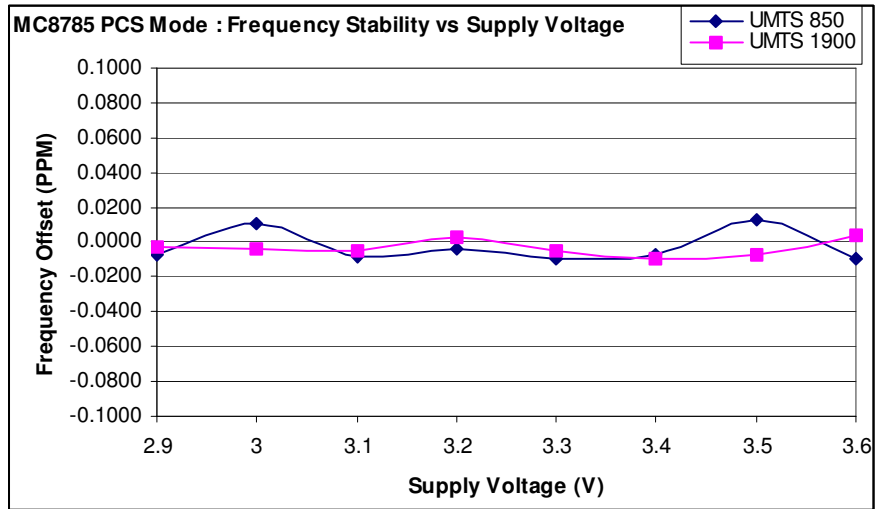

Supply (V)	UMTS Mode			
	850MHz		1900MHz	
	Offset (Hz)	Offset (ppm)	Offset (Hz)	Offset (ppm)
2.9	-6	-0.0072	-5	-0.0027
3.0	9	0.0108	-7	-0.0037
3.1	-7	-0.0084	-9	-0.0048
3.2	-3	-0.0036	6	0.0032
3.3	-8	-0.0096	-10	-0.0053
3.4	-6	-0.0072	-17	-0.0090
3.5	11	0.0132	-14	-0.0074
3.6	-8	-0.0096	7	0.0037