



FCC RF Test Report

APPLICANT : DAP Technologies
EQUIPMENT : Tablet PC
BRAND NAME : DAP Technologies
MODEL NAME : MT1010
FCC ID : T5M -M1010WBWW
STANDARD : FCC 47 CFR Part 2, 22(H), 24(E), 27(L)
CLASSIFICATION : PCS Licensed Transmitter (PCB)

The product was received on Jan. 28, 2013 and completely tested on Mar. 04, 2013. We, SPORTON INTERNATIONAL INC., would like to declare that the tested sample has been evaluated in accordance with the procedures given in ANSI / TIA / EIA-603-C-2004 and shown compliance with the applicable technical standards.

The test results in this report apply exclusively to the tested model / sample. Without written approval of SPORTON INTERNATIONAL INC., the test report shall not be reproduced except in full.

Reviewed by: Joseph Lin / Supervisor

Approved by: Jones Tsai / Manager



SPORTON INTERNATIONAL INC.

No. 52, Hwa Ya 1st Rd., Hwa Ya Technology Park, Kwei-Shan Hsiang, Tao Yuan Hsien, Taiwan, R.O.C.

SPORTON INTERNATIONAL INC.

TEL : 886-3-327-3456

FAX : 886-3-328-4978

FCC ID : T5M -M1010WBWW

Page Number : 1 of 114

Report Issued Date : Mar. 15, 2013

Report Version : Rev. 01



TABLE OF CONTENTS

REVISION HISTORY..... 3

SUMMARY OF TEST RESULT 4

1 GENERAL DESCRIPTION 5

 1.1 Applicant..... 5

 1.2 Manufacturer 5

 1.3 Feature of Equipment Under Test..... 6

 1.4 Product Specification of Equipment Under Test 6

 1.5 Maximum ERP/EIRP Power, Frequency Tolerance, and Emission Designator 7

 1.6 Testing Site..... 7

 1.7 Applied Standards 8

2 TEST CONFIGURATION OF EQUIPMENT UNDER TEST 9

 2.1 Test Mode..... 9

 2.2 Connection Diagram of Test System 11

 2.3 Support Unit used in test configuration and system 11

 2.4 Measurement Results Explanation Example 12

3 TEST RESULT 13

 3.1 Conducted Output Power Measurement and ERP/EIRP Measurement..... 13

 3.2 Peak-to-Average Ratio 16

 3.3 Occupied Bandwidth and 26dB Bandwidth Measurement 32

 3.4 Band Edge Measurement..... 56

 3.5 Conducted Spurious Emission Measurement 71

 3.6 Field Strength of Spurious Radiation Measurement 90

 3.7 Frequency Stability Measurement..... 107

4 LIST OF MEASURING EQUIPMENTS..... 113

5 UNCERTAINTY OF EVALUATION 114

APPENDIX A. PHOTOGRAPHS OF EUT

APPENDIX B. SETUP PHOTOGRAPHS



SUMMARY OF TEST RESULT

Report Section	FCC Rule	IC Rule	Description	Limit	Result	Remark
3.1	§2.1046	RSS-132 (5.4) RSS-133 (6.4) RSS-139 (6.4)	Conducted Output Power	Reporting Only	PASS	-
3.1	§22.913(a)(2)	RSS-132(5.4) SRSP-503(5.1.3)	Effective Radiated Power	< 7 Watts	PASS	-
3.1	§24.232(c)	RSS-133 (6.4) SRSP-510(5.1.2)	Equivalent Isotropic Radiated Power	< 2 Watts	PASS	-
3.1	§27.50(d)(4)	RSS-139 (6.4) SRSP-513(5.1.2)	Equivalent Isotropic Radiated Power	< 1 Watts	PASS	-
3.2	§24.232(d) §27.50(d)(5)	RSS-132 (5.4) RSS-133(6.4) RSS-139 (6.4)	Peak-to-Average Ratio	< 13 dB	PASS	-
3.3	§2.1049 §22.917(a) §24.238(a) §27.53(g)	RSS-GEN(4.6.1) RSS-133(6.5) RSS-139 (6.5)	Occupied Bandwidth	Reporting Only	PASS	-
3.4	§2.1051 §22.917(a) §24.238(a) §27.53(g)	RSS-132 (5.5) RSS-133 (6.5) RSS-139 (6.5)	Band Edge Measurement	< 43+10log10(P[Watts])	PASS	-
3.5	§2.1051 §22.917(a) §24.238(a) §27.53(g)	RSS-132 (5.5) RSS-133 (6.5) RSS-139 (6.5)	Conducted Emission	< 43+10log10(P[Watts])	PASS	-
3.6	§2.1053 §22.917(a) §24.238(a) §27.53(g)	RSS-132 (5.5) RSS-133 (6.5) RSS-139 (6.5)	Field Strength of Spurious Radiation	< 43+10log10(P[Watts])	PASS	Under limit 23.04 dB at 5644.000 MHz
3.7	§2.1055 §22.355 §24.235 §27.54	RSS-132 (5.3) RSS-133 (6.3) RSS-139 (6.3)	Frequency Stability for Temperature & Voltage	< 2.5 ppm	PASS	-



1 General Description

1.1 Applicant

DAP Technologies

4535 Wilfrid Hamel Blvd., Suite 100, Quebec City, QC Canada G1P 2J7

1.2 Manufacturer

Pegatron Corporation

NO. 5, Shing Yeh St., Kwei Shan Hsiang Toayuan Hsien, TAIWAN (R.O.C.)

1.3 Feature of Equipment Under Test

Product Feature	
Equipment	Tablet PC
Brand Name	DAP Technologies
Model Name	MT1010
Integrated Module	Brand name: Sierra Wireless Inc. Model name: MC7355
FCC ID	T5M -M1010WBWW
EUT supports Radios application	CDMA/EV-DO/GSM/EGPRS/WCDMA/HSPA/ WLAN 11abgn / Bluetooth 2.1/4.0
EUT Stage	Identical Prototype

Remark: The above EUT's information was declared by manufacturer. Please refer to the specifications or user's manual for more detailed description.

1.4 Product Specification of Equipment Under Test

Product Specification subjective to this standard	
Tx Frequency	GSM850: 824.2 MHz ~ 848.8 MHz GSM1900: 1850.2 MHz ~ 1909.8MHz WCDMA Band V: 826.4 MHz ~ 846.6 MHz WCDMA Band IV : 1712.4 MHz ~ 1752.6 MHz WCDMA Band II: 1852.4 MHz ~ 1907.6 MHz
Rx Frequency	GSM850: 869.2 MHz ~ 893.8 MHz GSM1900: 1930.2 MHz ~ 1989.8 MHz WCDMA Band V: 871.4 MHz ~ 891.6 MHz WCDMA Band IV : 2112.4 MHz ~ 2152.6 MHz WCDMA Band II : 1932.4 MHz ~ 1987.6 MHz
Maximum Output Power to Antenna	GSM850 : 32.19 dBm GSM1900 : 29.36 dBm WCDMA Band V : 22.60 dBm WCDMA Band IV : 22.58 dBm WCDMA Band II : 22.63 dBm
Antenna Type	PIFA Antenna
Antenna Gain	GSM850: -0.52 dBi GSM1900: 2.43 dBi WCDMA Band V: -0.52 dBi WCDMA Band IV : 2.43 dBi WCDMA Band II : 2.43 dBi
Type of Modulation	GSM: GMSK GPRS: GMSK EDGE: GMSK / 8PSK WCDMA: QPSK (Uplink) HSDPA: QPSK (Uplink) HSUPA: QPSK (Uplink)

1.5 Maximum ERP/EIRP Power, Frequency Tolerance, and Emission Designator

FCC Rule	System	Type of Modulation	Maximum ERP/EIRP (W)	Frequency Tolerance (% , Hz, ppm)	Emission Designator
Part 22	GSM850 GPRS class 8	GMSK	0.895	0.02 ppm	246KGXW
Part 22	GSM850 EDGE class 10	8PSK	0.259	0.05 ppm	246KG7W
Part 22	WCDMA Band V RMC 12.2Kbps	QPSK	0.098	0.01 ppm	4M16F9W
Part 24	GSM1900 GPRS class 8	GMSK	1.510	0.01 ppm	246KGXW
Part 24	GSM1900 EDGE class 8	8PSK	0.630	0.02 ppm	248KG7W
Part 24	WCDMA Band II RMC 12.2Kbps	QPSK	0.321	0.01 ppm	4M18F9W
Part 27	WCDMA Band IV RMC 12.2Kbps	QPSK	0.317	0.01 ppm	4M18F9W

1.6 Testing Site

Test Site	SPORTON INTERNATIONAL INC.		
Test Site Location	No. 52, Hwa Ya 1 st Rd., Hwa Ya Technology Park, Kwei-Shan Hsiang, Tao Yuan Hsien, Taiwan, R.O.C. TEL: +886-3-327-3456 FAX: +886-3-328-4978		
Test Site No.	Sporton Site No.		FCC/IC Registration No.
	TH02-HY	03CH07-HY	722060/4086B-1



1.7 Applied Standards

According to the specifications of the manufacturer, the EUT must comply with the requirements of the following standards:

- ♦ Preliminary Guidance for Receiving Applications for Certification of 3G Device. May 9, 2006.
- ♦ 47 CFR Part 2, 22(H), 24(E), 27(L)
- ♦ ANSI / TIA / EIA-603-C-2004
- ♦ FCC KDB 412172 D01 Determining ERP and ERIP v01
- ♦ IC RSS-132 Issue 3
- ♦ IC RSS-133 Issue 6
- ♦ IC RSS-139 Issue 2
- ♦ IC RSS-Gen Issue 3
- ♦ NOTICE 2012-DRS0126

Remark:

1. All test items were verified and recorded according to the standards and without any deviation during the test.
2. Per the section 2.2.3 of Notice of 2012-DRS0126, " Receivers Excluded from Industry Canada Requirements", only radiocommunication receivers operating in stand-alone mode within the band 30-960 MHz and scanner receivers are subject to Industry Canada requirements.

2 Test Configuration of Equipment Under Test

2.1 Test Mode

During all testing, EUT is in link mode with base station emulator at maximum power level. The spurious emission measurements were carried out in semi-anechoic chamber with 3-meter test range, and EUT is rotated on three test planes to find out the worst emission.

Frequency range investigated for radiated emission is as follows:

1. 30 MHz to 9000 MHz for GSM850 and WCDMA Band V.
2. 30 MHz to 18000 MHz for WCDMA Band IV.
3. 30 MHz to 19000 MHz for GSM1900 and WCDMA Band II.

Test Modes		
Band	Radiated TCs	Conducted TCs
GSM 850	<ul style="list-style-type: none"> ■ GPRS class 8 Link ■ EDGE class 10 Link 	<ul style="list-style-type: none"> ■ GPRS class 8 Link ■ EDGE class 10 Link
GSM 1900	<ul style="list-style-type: none"> ■ GPRS class 8 Link ■ EDGE class 8 Link 	<ul style="list-style-type: none"> ■ GPRS class 8 Link ■ EDGE class 8 Link
WCDMA Band V	<ul style="list-style-type: none"> ■ RMC 12.2Kbps Link 	<ul style="list-style-type: none"> ■ RMC 12.2Kbps Link
WCDMA Band IV	<ul style="list-style-type: none"> ■ RMC 12.2Kbps Link 	<ul style="list-style-type: none"> ■ RMC 12.2Kbps Link
WCDMA Band II	<ul style="list-style-type: none"> ■ RMC 12.2Kbps Link 	<ul style="list-style-type: none"> ■ RMC 12.2Kbps Link

Note:

1. The maximum power levels are GPRS multi-slot class 8 mode for GSM 850 GMSK link, GPRS multi-slot class 8 mode for GSM 1900 GMSK link, EDGE multi-slot class 10 mode for GSM 850 8PSK link, EDGE multi-slot class 8 mode for GSM 1900 8PSK link, RMC 12.2Kbps mode for WCDMA band V, RMC 12.2Kbps mode for WCDMA band IV, and RMC 12.2Kbps mode for WCDMA band II, only these modes were used for all tests.
2. Because there are individual antennas for each WWAN, WLAN, and Bluetooth, the co-location test modes are not required.



The conducted power tables are as follows:

Conducted Power (*Unit: dBm)						
Band	GSM850			GSM1900		
Channel	128	189	251	512	661	810
Frequency	824.2	836.4	848.8	1850.2	1880	1909.8
GPRS class 8	32.14	32.19	32.17	29.20	29.33	29.36
GPRS class 10	31.51	31.53	31.49	29.04	29.18	29.28
EGPRS class 8	26.70	26.76	26.58	25.40	25.56	25.53
EGPRS class 10	26.54	26.60	26.81	25.33	25.48	25.52
EGPRS class 12	26.02	26.23	26.32	25.04	25.21	25.27

Conducted Power (*Unit: dBm)									
Band	WCDMA Band V			WCDMA Band II			WCDMA Band IV		
Tx Channel	4132	4182	4233	9262	9400	9538	1312	1413	1513
Rx Channel	4357	4408	4458	9662	9800	9938	1537	1638	1738
Frequency	826.4	836.4	846.6	1852.4	1880	1907.6	1712.4	1732.6	1752.6
RMC 12.2K	22.60	22.49	22.46	22.63	22.57	22.59	22.58	22.56	22.54
HSDPA Subtest-1	22.10	22.06	21.98	22.18	22.17	22.23	22.12	22.05	22.05
HSDPA Subtest-2	22.07	22.05	21.92	22.15	22.14	22.15	22.10	22.02	21.99
HSDPA Subtest-3	21.65	21.58	21.45	21.63	21.61	21.68	21.57	21.56	21.43
HSDPA Subtest-4	21.64	21.60	21.45	21.61	21.58	21.64	21.53	21.49	21.46
HSUPA Subtest-1	22.08	22.06	22.03	22.13	22.02	22.03	21.70	21.73	21.69
HSUPA Subtest-2	20.70	20.63	20.75	20.58	20.71	20.65	20.60	20.80	20.67
HSUPA Subtest-3	21.56	21.51	21.64	21.48	21.63	21.57	20.67	20.88	20.72
HSUPA Subtest-4	20.50	20.46	20.32	20.66	20.80	20.67	20.65	20.88	20.75
HSUPA Subtest-5	22.03	22.02	22.06	22.05	22.10	22.03	22.22	22.19	22.08

2.2 Connection Diagram of Test System

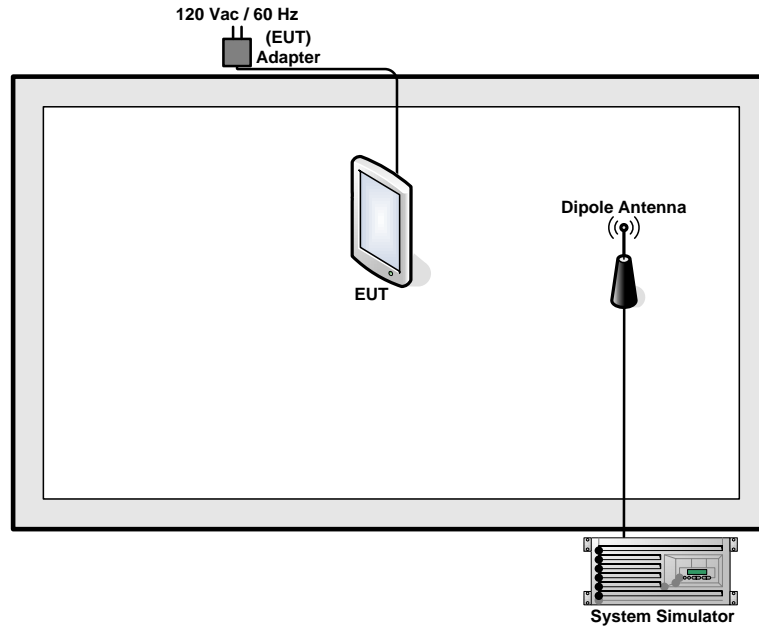

2.3 Support Unit used in test configuration and system

Item	Equipment	Trade Name	Model No.	FCC ID	Data Cable	Power Cord
1.	System Simulator	R&S	CMU200	N/A	N/A	Unshielded, 1.8 m



2.4 Measurement Results Explanation Example

For all conducted test items:

The offset level is set in the spectrum analyzer to compensate the RF cable loss and attenuator factor between EUT conducted output port and spectrum analyzer. With the offset compensation, the spectrum analyzer reading level is exactly the EUT RF output level.

The spectrum analyzer offset is derived from RF cable loss and attenuator factor.

Offset = RF cable loss + attenuator factor.

Following shows an offset computation example with cable loss 4.2 dB and 10dB attenuator.

Example :

$$\begin{aligned} \text{Offset(dB)} &= \text{RF cable loss(dB)} + \text{attenuator factor(dB)}. \\ &= 4.2 + 10 = 14.2 \text{ (dB)} \end{aligned}$$

3 Test Result

3.1 Conducted Output Power Measurement and ERP/EIRP Measurement

3.1.1 Description of the Conducted Output Power and ERP/EIRP Measurement

A base station simulator was used to establish communication with the EUT. Its parameters were set to transmit the maximum power on the EUT. The measured power in the radio frequency on the transmitter output terminals shall be reported.

The ERP of mobile transmitters must not exceed 7 Watts and the EIRP of mobile transmitters are limited to 2 Watts. According to KDB 412172 D01 Power Approach,

$EIRP = P_T + G_T - L_C$, $ERP = EIRP - 2.15$, where

P_T = transmitter output power in dBm

G_T = gain of the transmitting antenna in dBi

L_C = signal attenuation in the connecting cable between the transmitter and antenna in dB

3.1.2 Measuring Instruments

See list of measuring instruments of this test report.

3.1.3 Test Procedures

1. The transmitter output port was connected to base station.
2. The RF output of EUT was connected to the spectrum analyzer by RF cable and attenuator. The path loss was compensated to the results for each measurement.
3. Set EUT at maximum power through base station.
4. Select lowest, middle, and highest channels for each band and different modulation.
5. Measure the maximum burst average power for GSM and maximum average power for GSM and WCDMA modes.
6. The procedure section 2.0 of FCC KDB 412172 is used to determine the Radiated Power Measurement.

3.1.4 Test Setup

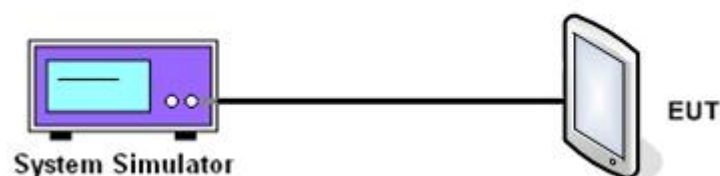

3.1.5 Test Result of Conducted Output Power

Cellular Band ($G_T - L_C = -0.52$ dB)									
Modes	GSM850 (GPRS class 8)			GSM850 (EDGE class 10)			WCDMA Band V (RMC 12.2Kbps)		
Channel	128 (Low)	189 (Mid)	251 (High)	128 (Low)	189 (Mid)	251 (High)	4132 (Low)	4182 (Mid)	4233 (High)
Frequency (MHz)	824.2	836.4	848.8	824.2	836.4	848.8	826.4	836.4	846.6
Conducted Power (dBm)	32.14	32.19	32.17	26.54	26.60	26.81	22.60	22.49	22.46
Conducted Power (Watts)	1.64	1.66	1.65	0.45	0.46	0.48	0.18	0.18	0.18
ERP(dBm)	29.47	29.52	29.50	23.87	23.93	24.14	19.93	19.82	19.79
ERP(Watts)	0.885	0.895	0.891	0.244	0.247	0.259	0.098	0.096	0.095

PCS Band ($G_T - L_C = 2.43$ dB)									
Modes	GSM1900 (GPRS class 8)			GSM1900 (EDGE class 8)			WCDMA Band II (RMC 12.2Kbps)		
Channel	512 (Low)	661 (Mid)	810 (High)	512 (Low)	661 (Mid)	810 (High)	9262 (Low)	9400 (Mid)	9538 (High)
Frequency (MHz)	1850.2	1880	1909.8	1850.2	1880	1909.8	1852.4	1880	1907.6
Conducted Power (dBm)	29.2	29.33	29.36	25.4	25.56	25.53	22.63	22.57	22.59
Conducted Power (Watts)	0.83	0.86	0.86	0.35	0.36	0.36	0.18	0.18	0.18
EIRP(dBm)	31.63	31.76	31.79	27.83	27.99	27.96	25.06	25	25.02
EIRP(Watts)	1.455	1.500	1.510	0.607	0.630	0.625	0.321	0.316	0.318



AWS Band ($G_T - L_C = 2.43$ dB)			
Modes	WCDMA Band IV (RMC 12.2Kbps)		
Channel	1312(Low)	1413 (Mid)	1513 (High)
Frequency (MHz)	1712.4	1732.6	1752.6
Conducted Power (dBm)	22.58	22.56	22.54
Conducted Power (Watts)	0.18	0.18	0.18
EIRP(dBm)	25.01	24.99	24.97
EIRP(Watts)	0.317	0.316	0.314

Note: maximum burst average power for GSM, and maximum average power for WCDMA.

$EIRP = P_T + G_T - L_C$, $ERP = EIRP - 2.15$, where

P_T = transmitter output power in dBm

G_T = gain of the transmitting antenna in dBi

L_C = signal attenuation in the connecting cable between the transmitter and antenna in dB

3.2 Peak-to-Average Ratio

3.2.1 Description of the PAR Measurement

The peak-to-average ratio (PAR) of the transmission may not exceed 13 dB.

3.2.2 Measuring Instruments

See list of measuring instruments of this test report.

3.2.3 Test Procedures

1. The EUT was connected to Spectrum Analyzer and System Simulator via power divider.
2. For GSM/EGPRS operating modes:
 - a. Set EUT in maximum power output.
 - b. Set the RBW = 1MHz, VBW = 3MHz, Peak detector in spectrum analyzer for first trace.
 - c. Set the RBW = 1MHz, VBW = 3MHz, RMS detector in spectrum analyzer for second trace.
 - d. The wanted burst signal is triggered by spectrum analyzer, and measured respectively the peak level and Mean level without burst-off time, after system simulator synchronized with the spectrum analyzer.
3. For UMTS operating modes:
 - a. Set the CCDF (Complementary Cumulative Distribution Function) option in spectrum analyzer.
 - b. The highest RF powers were measured and recorded the maximum PAPR level associated with a probability of 0.1 %.
4. Record the deviation as Peak to Average Ratio.

3.2.4 Test Setup

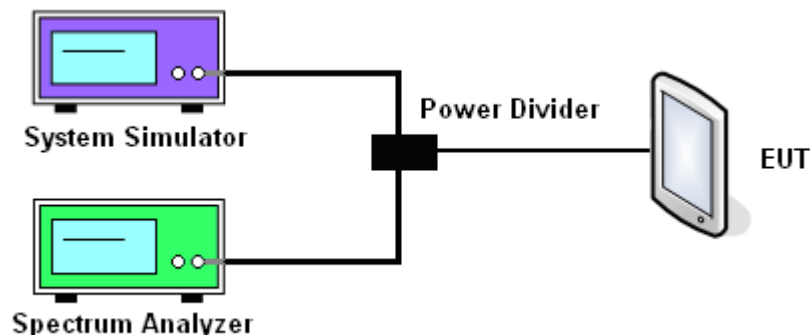

3.2.5 Test Result of Peak-to-Average Ratio

Cellular Band									
Modes	GSM850 (GPRS class 8)			GSM850 (EDGE class 10)			WCDMA Band V (RMC 12.2Kbps)		
Channel	128 (Low)	189 (Mid)	251 (High)	128 (Low)	189 (Mid)	251 (High)	4132 (Low)	4182 (Mid)	4233 (High)
Frequency (MHz)	824.2	836.4	848.8	824.2	836.4	848.8	826.4	836.4	846.6
Peak-to-Average Ratio (dB)	0.20	0.21	0.23	2.39	2.46	2.60	3.32	3.40	3.36

PCS Band									
Modes	GSM1900 (GPRS class 8)			GSM1900 (EDGE class 8)			WCDMA Band II (RMC 12.2Kbps)		
Channel	512 (Low)	661 (Mid)	810 (High)	512 (Low)	661 (Mid)	810 (High)	9262 (Low)	9400 (Mid)	9538 (High)
Frequency (MHz)	1850.2	1880	1909.8	1850.2	1880	1909.8	1852.4	1880	1907.6
Peak-to-Average Ratio (dB)	0.26	0.25	0.28	2.78	2.37	2.58	3.44	3.32	3.44

AWS Band			
Modes	WCDMA Band IV (RMC 12.2Kbps)		
Channel	1312(Low)	1413 (Mid)	1513 (High)
Frequency (MHz)	1712.4	1732.6	1752.6
Peak-to-Average Ratio (dB)	3.36	3.52	3.36



3.2.6 Test Result (Plots) of Peak-to-Average Ratio

Band :	GSM 850	Test Mode :	GPRS class 8 Link (GMSK)
--------	---------	-------------	--------------------------

Peak-to-Average Ratio on Channel 128 (824.2 MHz)

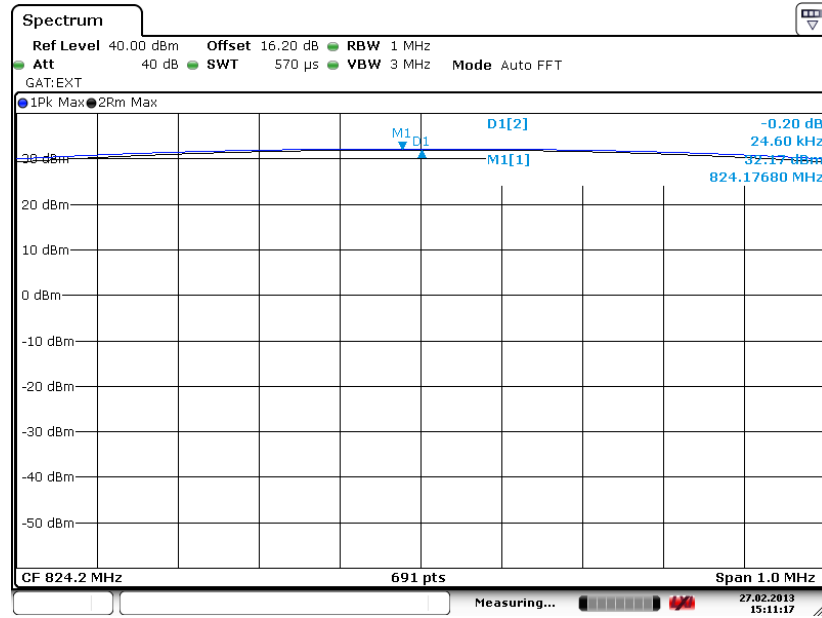

Date: 27.FEB.2013 15:11:17

Peak-to-Average Ratio on Channel 189 (836.4 MHz)

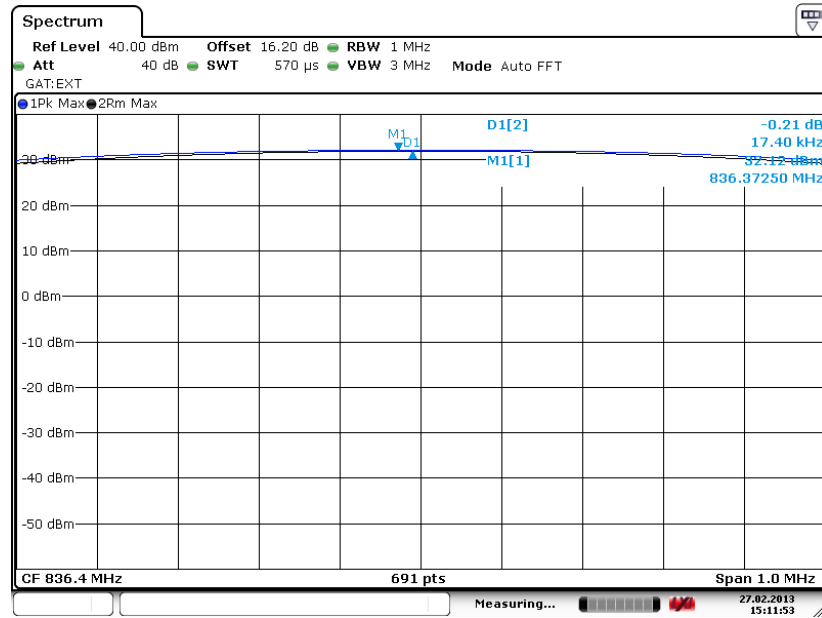

Date: 27.FEB.2013 15:11:54



Peak-to-Average Ratio on Channel 251 (848.8 MHz)

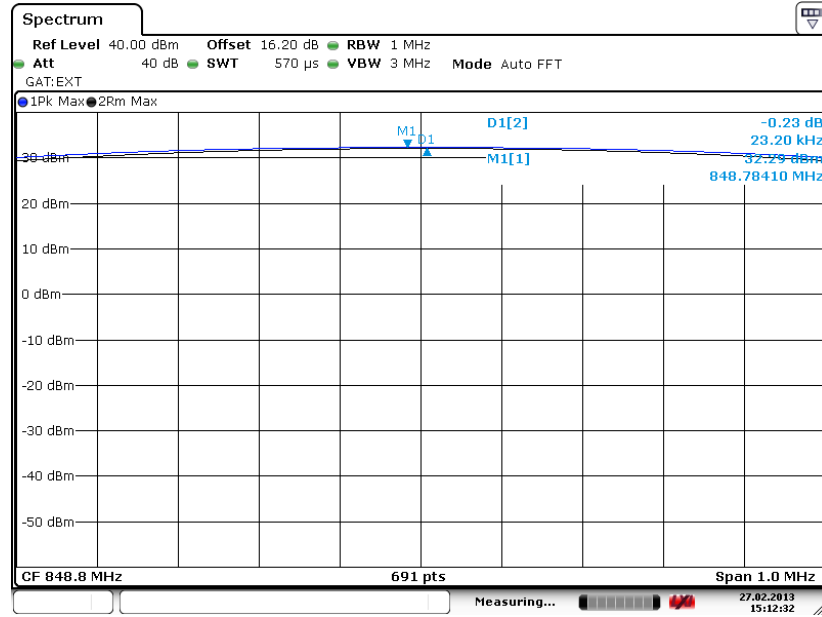

Date: 27.FEB.2013 15:12:32



Band :	GSM 850	Test Mode :	EDGE class 10 Link (8PSK)
---------------	---------	--------------------	---------------------------

Peak-to-Average Ratio on Channel 128 (824.2 MHz)

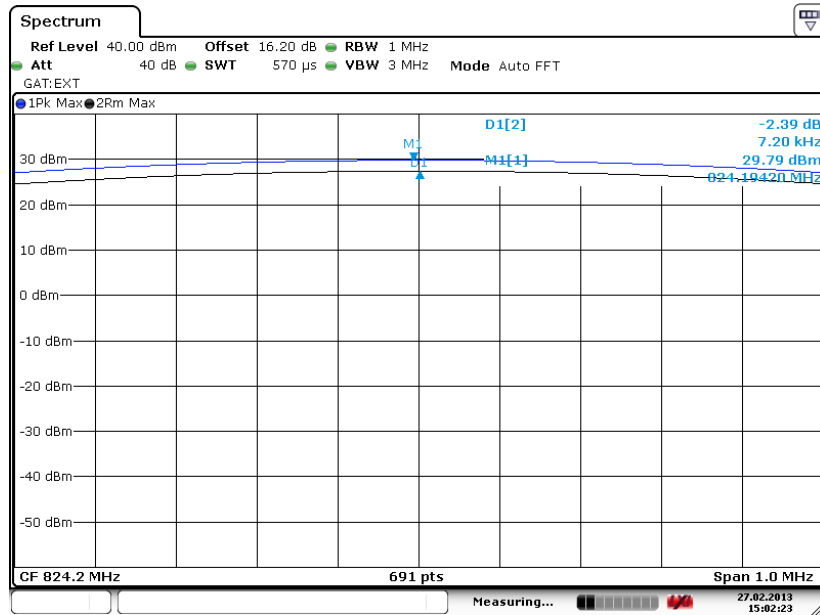

Date: 27.FEB.2013 15:02:23

Peak-to-Average Ratio on Channel 189 (836.4 MHz)

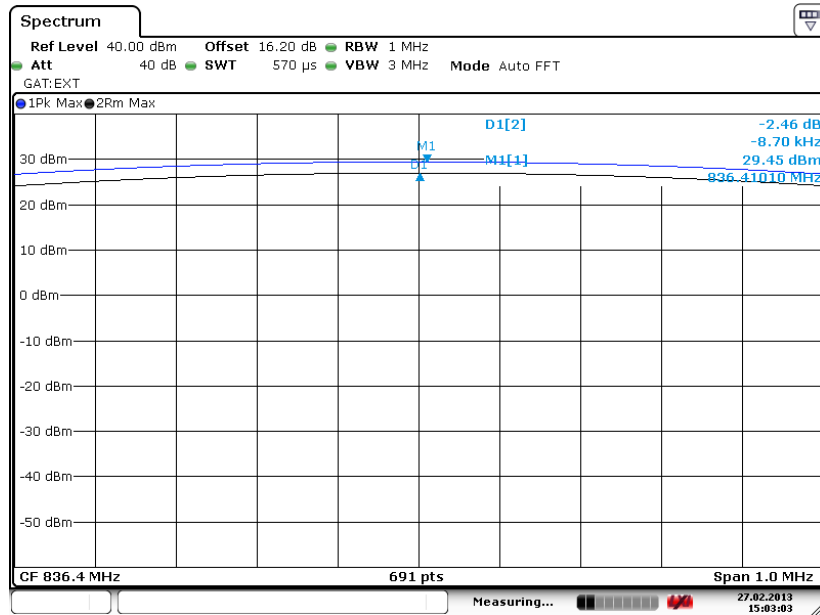

Date: 27.FEB.2013 15:03:03



Peak-to-Average Ratio on Channel 251 (848.8 MHz)

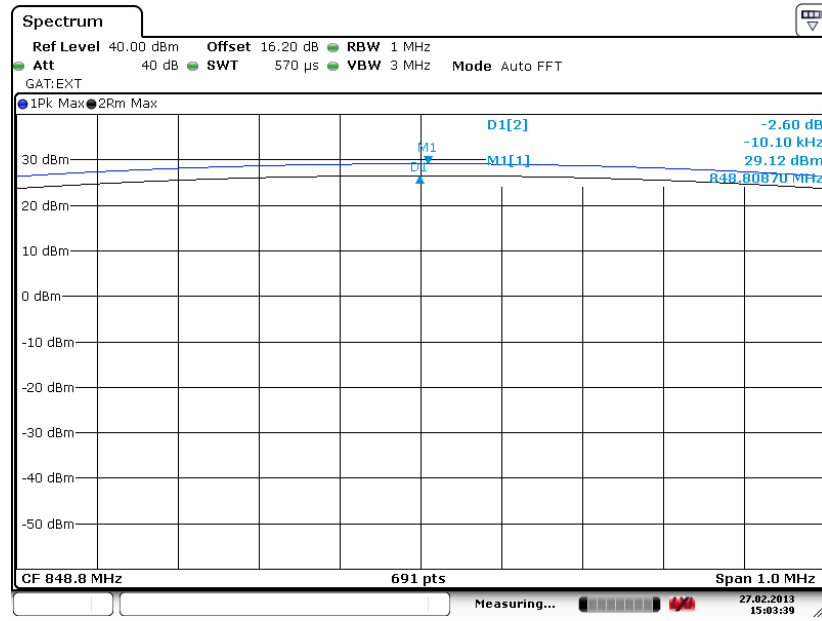

Date: 27.FEB.2013 15:03:40



Band :	GSM 1900	Test Mode :	GPRS class 8 Link (GMSK)
--------	----------	-------------	--------------------------

Peak-to-Average Ratio on Channel 512 (1850.2 MHz)

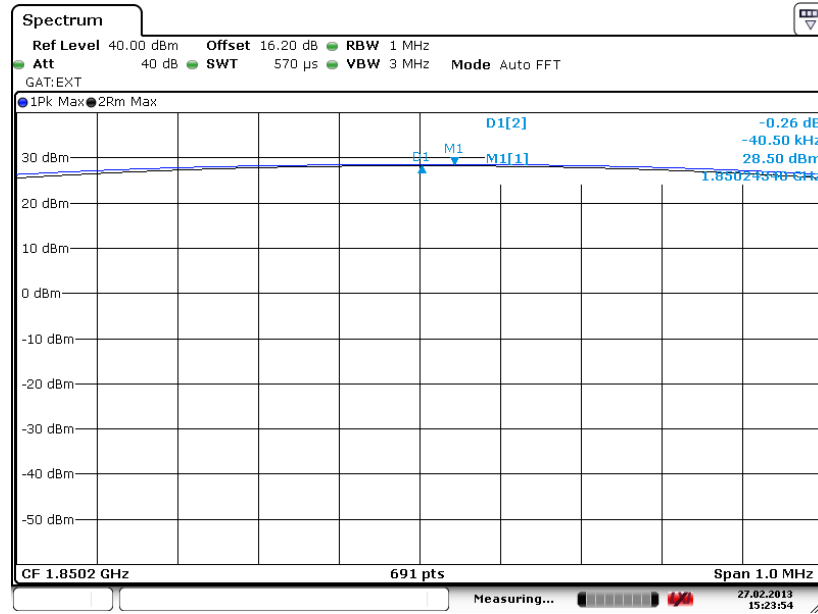

Date: 27.FEB.2013 15:23:54

Peak-to-Average Ratio on Channel 661 (1880.0 MHz)

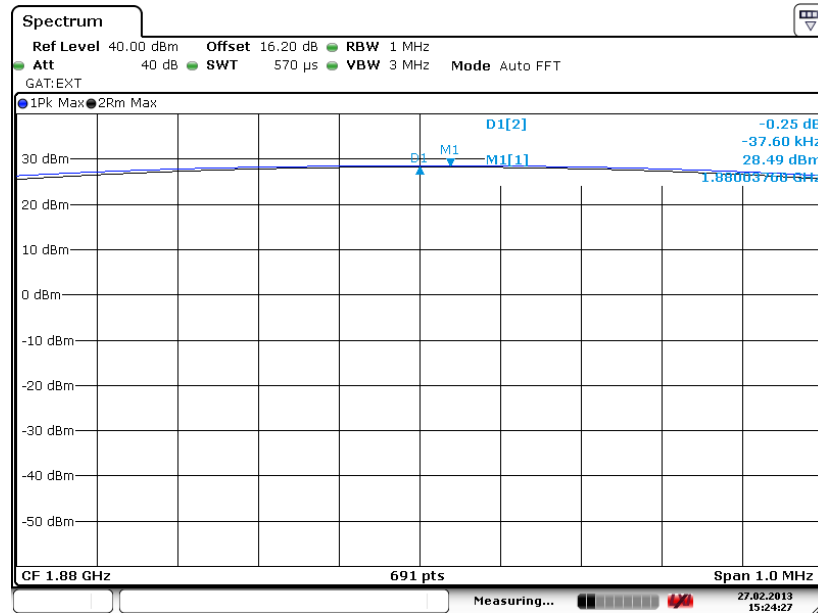

Date: 27.FEB.2013 15:24:27



Peak-to-Average Ratio on Channel 810 (1909.8 MHz)

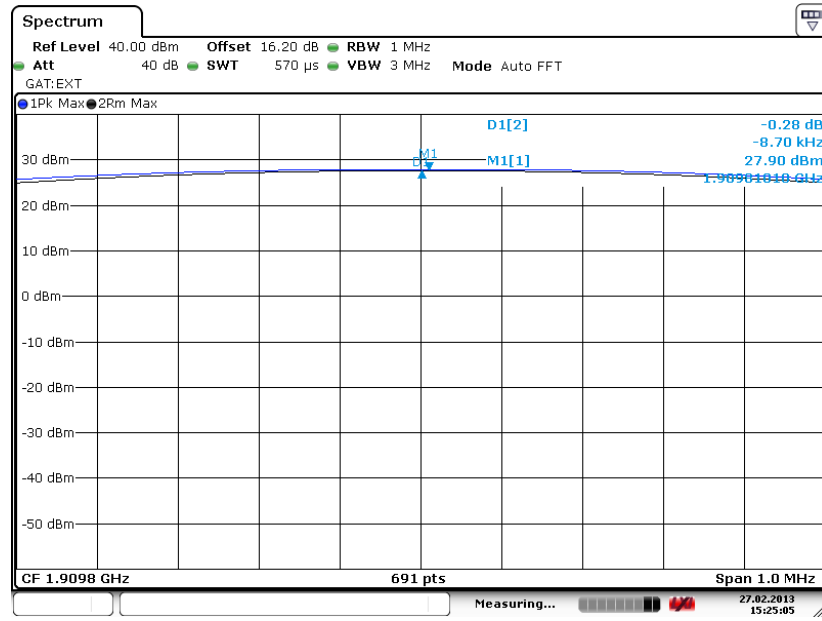

Date: 27.FEB.2013 15:25:05



Band :	GSM 1900	Test Mode :	EDGE class 8 Link (8PSK)
--------	----------	-------------	--------------------------

Peak-to-Average Ratio on Channel 512 (1850.2 MHz)

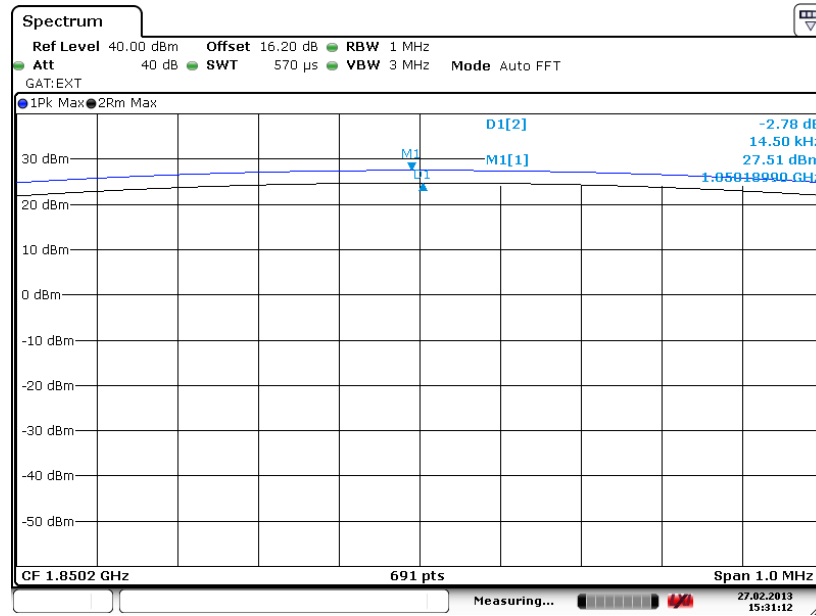

Date: 27.FEB.2013 15:31:13

Peak-to-Average Ratio on Channel 661 (1880.0 MHz)

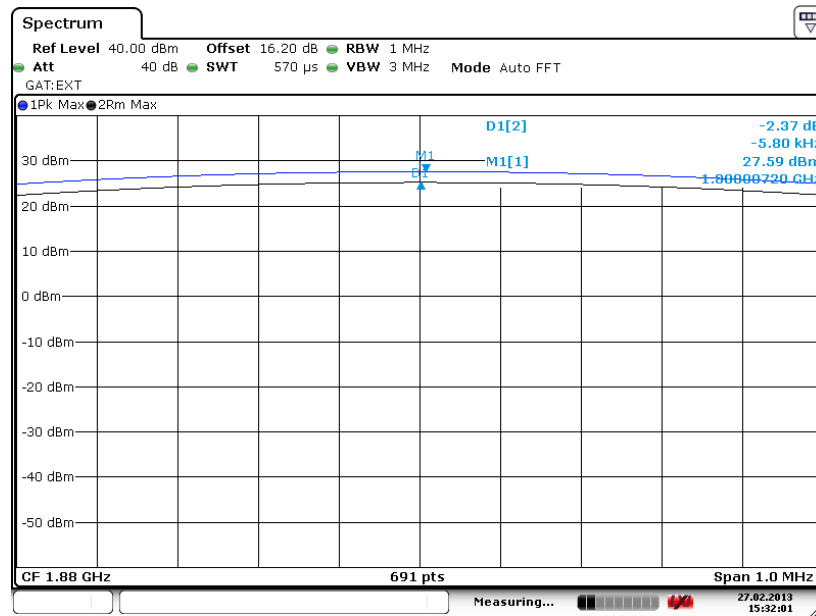

Date: 27.FEB.2013 15:32:01



Peak-to-Average Ratio on Channel 810 (1909.8 MHz)

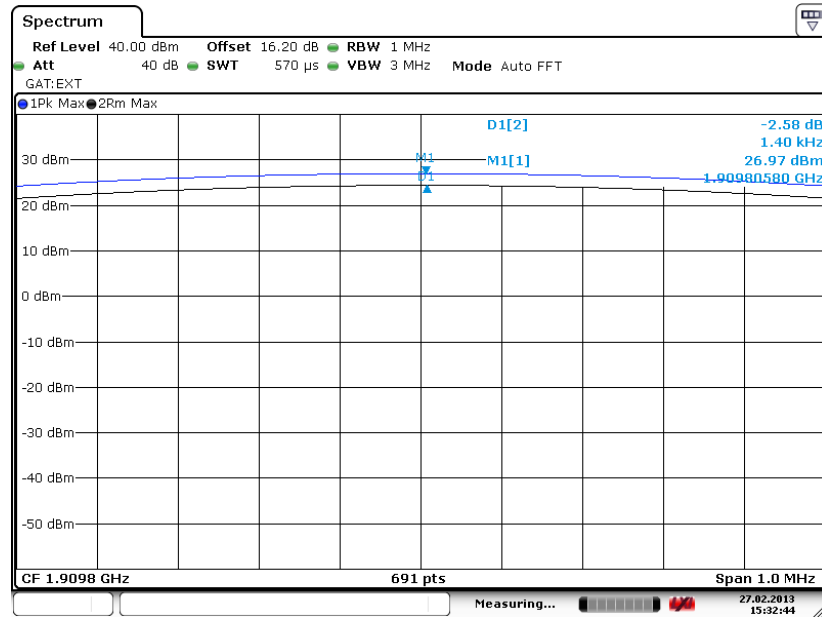

Date: 27.FEB.2013 15:32:44



Band :	WCDMA Band V	Test Mode :	RMC 12.2Kbps Link (QPSK)
---------------	--------------	--------------------	--------------------------

Peak-to-Average Ratio on Channel 4132 (826.4 MHz)

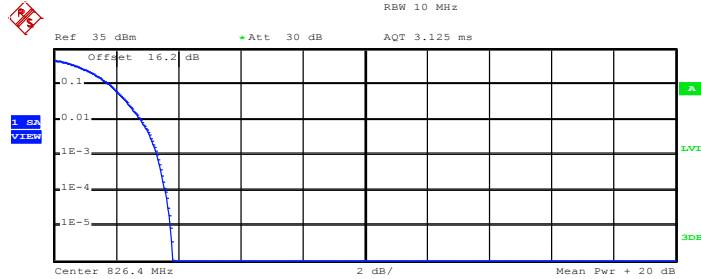

Complementary Cumulative Distribution Function (100000 samples)

Trace 1

Mean	22.47 dBm
Peak	26.29 dBm
Crest	3.82 dB
10 %	1.80 dB
1 %	2.80 dB
.1 %	3.32 dB
.01 %	3.60 dB

Date: 28.FEB.2013 02:07:07

Peak-to-Average Ratio on Channel 4182 (836.4 MHz)

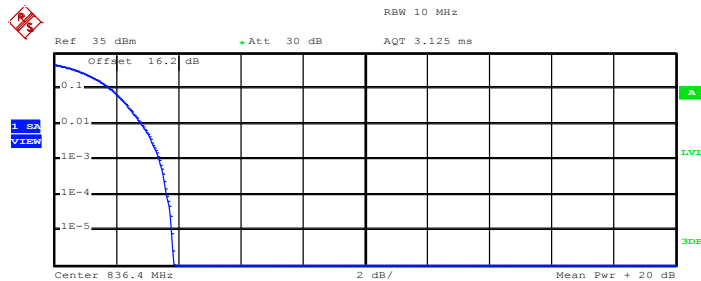

Complementary Cumulative Distribution Function (100000 samples)

Trace 1

Mean	22.51 dBm
Peak	26.36 dBm
Crest	3.85 dB
10 %	1.84 dB
1 %	2.84 dB
.1 %	3.40 dB
.01 %	3.64 dB

Date: 28.FEB.2013 02:07:53



Peak-to-Average Ratio on Channel 4233 (846.6 MHz)

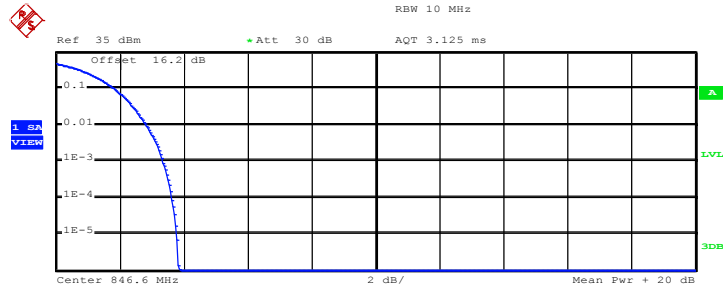

Complementary Cumulative Distribution Function (100000 samples)

Trace 1	
Mean	22.38 dBm
Peak	26.22 dBm
Crest	3.84 dB
10 %	1.84 dB
1 %	2.84 dB
.1 %	3.36 dB
.01 %	3.64 dB

Date: 28.FEB.2013 02:08:36



Band :	WCDMA Band IV	Test Mode :	RMC 12.2Kbps Link (QPSK)
---------------	---------------	--------------------	--------------------------

Peak-to-Average Ratio on Channel 1312 (1712.4 MHz)

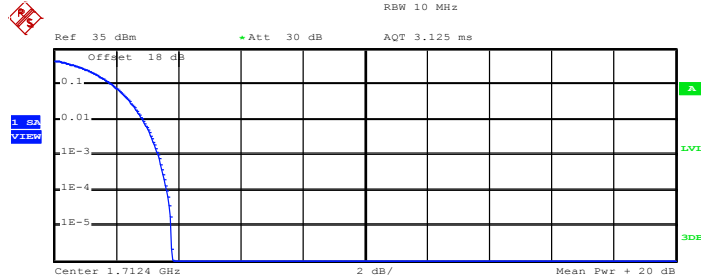

Complementary Cumulative Distribution Function (100000 samples)

Trace 1

Mean	22.85 dBm
Peak	26.65 dBm
Crest	3.80 dB
10 %	1.88 dB
1 %	2.88 dB
.1 %	3.36 dB
.01 %	3.64 dB

Date: 28.FEB.2013 21:24:22

Peak-to-Average Ratio on Channel 1413 (1732.6 MHz)

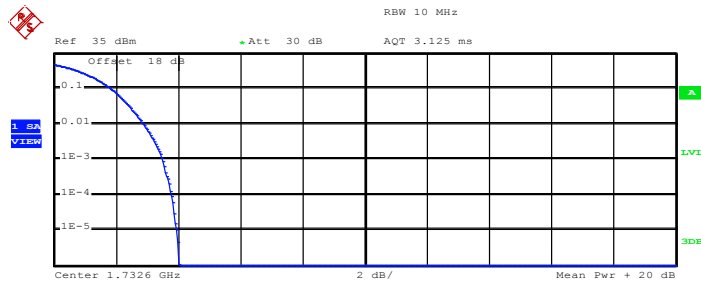

Complementary Cumulative Distribution Function (100000 samples)

Trace 1

Mean	22.76 dBm
Peak	26.79 dBm
Crest	4.03 dB
10 %	1.84 dB
1 %	2.88 dB
.1 %	3.52 dB
.01 %	3.80 dB

Date: 28.FEB.2013 21:23:23



Peak-to-Average Ratio on Channel 1513 (1752.6 MHz)

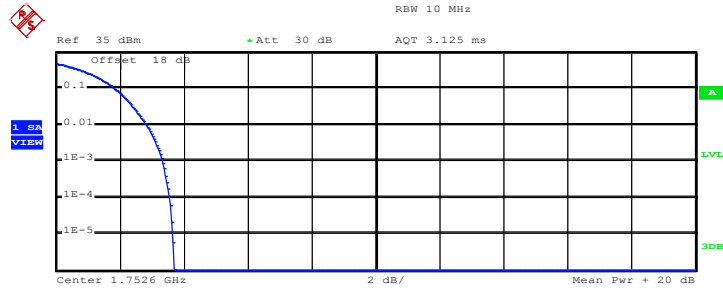

Complementary Cumulative Distribution Function (100000 samples)

Trace 1	
Mean	23.07 dBm
Peak	26.78 dBm
Crest	3.72 dB
10 %	1.88 dB
1 %	2.84 dB
.1 %	3.36 dB
.01 %	3.56 dB

Date: 4.MAR.2013 05:50:12



Band :	WCDMA Band II	Test Mode :	RMC 12.2Kbps Link (QPSK)
---------------	---------------	--------------------	--------------------------

Peak-to-Average Ratio on Channel 9262 (1852.4 MHz)

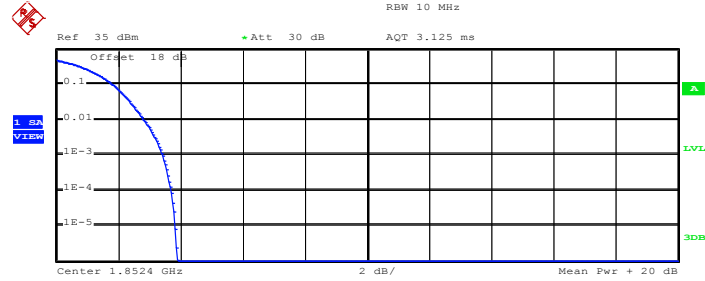

Complementary Cumulative Distribution Function (100000 samples)

Trace 1

Mean	19.58 dBm
Peak	23.47 dBm
Crest	3.89 dB
10 %	1.84 dB
1 %	2.84 dB
.1 %	3.44 dB
.01 %	3.72 dB

Date: 28.FEB.2013 02:42:01

Peak-to-Average Ratio on Channel 9400 (1880.0 MHz)

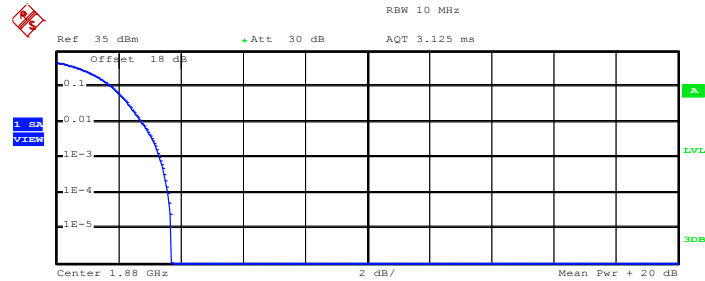

Complementary Cumulative Distribution Function (100000 samples)

Trace 1

Mean	19.62 dBm
Peak	23.33 dBm
Crest	3.71 dB
10 %	1.80 dB
1 %	2.76 dB
.1 %	3.32 dB
.01 %	3.60 dB

Date: 28.FEB.2013 02:41:20



Peak-to-Average Ratio on Channel 9538 (1907.6 MHz)

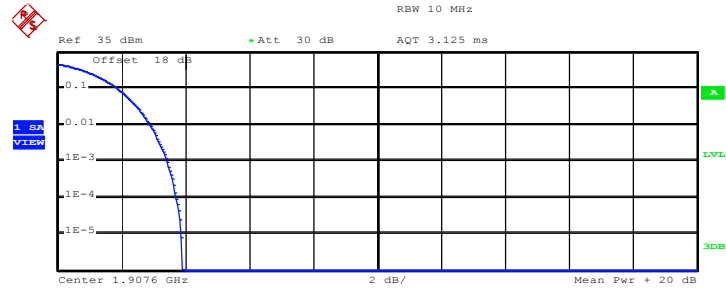

Complementary Cumulative Distribution Function (100000 samples)

Trace 1	
Mean	19.36 dBm
Peak	23.26 dBm
Crest	3.89 dB
10 %	1.88 dB
1 %	2.92 dB
.1 %	3.44 dB
.01 %	3.72 dB

Date: 28.FEB.2013 02:40:35

3.3 Occupied Bandwidth and 26dB Bandwidth Measurement

3.3.1 Description of Occupied Bandwidth and 26dB Bandwidth Measurement

The occupied bandwidth is the width of a frequency band such that, below the lower and above the upper frequency limits, the mean powers emitted are each equal to a specified percentage 0.5% of the total mean transmitted power.

The emission bandwidth is defined as the width of the signal between two points, located at the 2 sides of the carrier frequency, outside of which all emissions are attenuated at least 26 dB below the transmitter power.

3.3.2 Measuring Instruments

See list of measuring instruments of this test report.

3.3.3 Test Procedures

1. The EUT was connected to Spectrum Analyzer and Base Station via power divider.
2. The RF output of EUT was connected to the spectrum analyzer by RF cable and attenuator. The path loss was compensated to the results for each measurement.
3. The 99% occupied bandwidth and 26 dB bandwidth of the middle channel for the highest RF powers were measured.

3.3.4 Test Setup

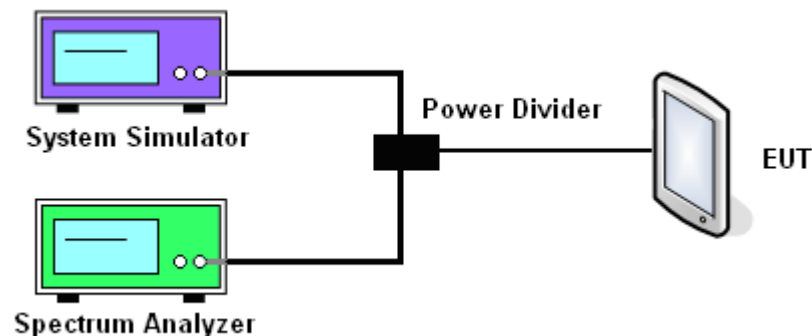



3.3.5 Test Result of Occupied Bandwidth and 26dB Bandwidth

Cellular Band						
Modes	GSM850 (GPRS class 8)			GSM850 (EDGE class 10)		
Channel	128 (Low)	189 (Mid)	251 (High)	128 (Low)	189 (Mid)	251 (High)
Frequency (MHz)	824.2	836.4	848.8	824.2	836.4	848.8
99% OBW (KHz)	246.00	244.00	242.00	246.00	244.00	246.00
26dB BW (KHz)	318.00	318.00	310.00	314.00	308.00	316.00

PCS Band						
Modes	GSM1900 (GPRS class 8)			GSM1900 (EDGE class 8)		
Channel	512 (Low)	661 (Mid)	810 (High)	512 (Low)	661 (Mid)	810 (High)
Frequency (MHz)	1850.2	1880	1909.8	1850.2	1880	1909.8
99% OBW (KHz)	246.00	246.00	246.00	246.00	244.00	248.00
26dB BW (KHz)	318.00	320.00	314.00	316.00	314.00	306.00

Cellular Band			
Modes	WCDMA Band V (RMC 12.2Kbps)		
Channel	4132 (Low)	4182 (Mid)	4233 (High)
Frequency (MHz)	826.4	836.4	846.6
99% OBW (MHz)	4.16	4.14	4.16
26dB BW (MHz)	4.68	4.68	4.66

AWS Band			
Modes	WCDMA Band IV (RMC 12.2Kbps)		
Channel	1312(Low)	1413 (Mid)	1513 (High)
Frequency (MHz)	1712.4	1732.6	1752.6
99% OBW (MHz)	4.16	4.18	4.18
26dB BW (MHz)	4.68	4.68	4.68



PCS Band			
Modes	WCDMA Band II (RMC 12.2Kbps)		
Channel	9262 (Low)	9400 (Mid)	9538 (High)
Frequency (MHz)	1852.4	1880	1907.6
99% OBW (MHz)	4.18	4.16	4.16
26dB BW (MHz)	4.68	4.68	4.68



3.3.6 Test Result (Plots) of Occupied Bandwidth and 26dB Bandwidth

Band :	GSM 850	Test Mode :	GPRS class 8 Link (GMSK)
--------	---------	-------------	--------------------------

99% Occupied Bandwidth Plot on Channel 128 (824.2 MHz)

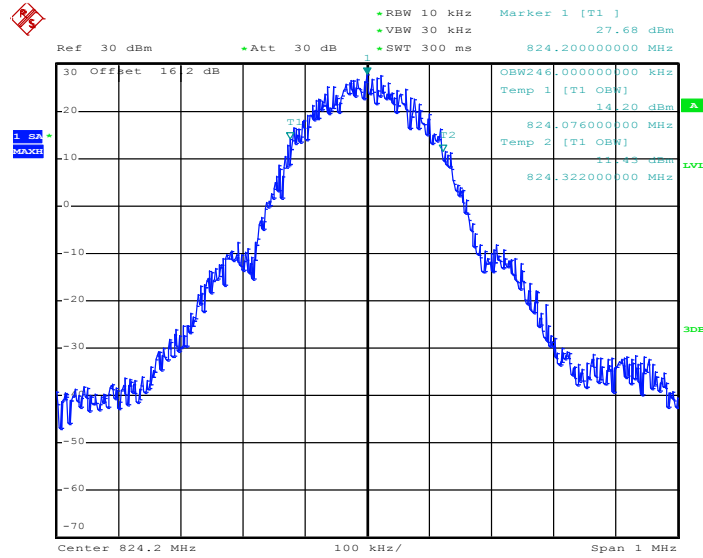

Date: 27.FEB.2013 22:40:21

26dB Bandwidth Plot on Channel 128 (824.2 MHz)

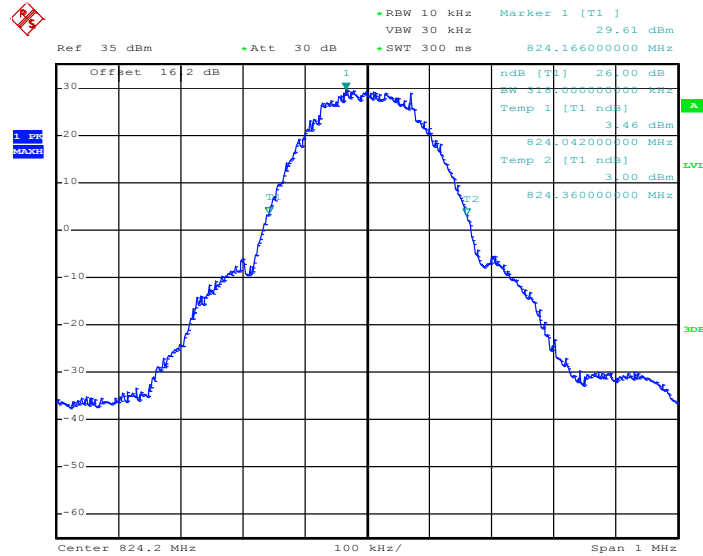

Date: 27.FEB.2013 22:46:02



99% Occupied Bandwidth Plot on Channel 189 (836.4 MHz)

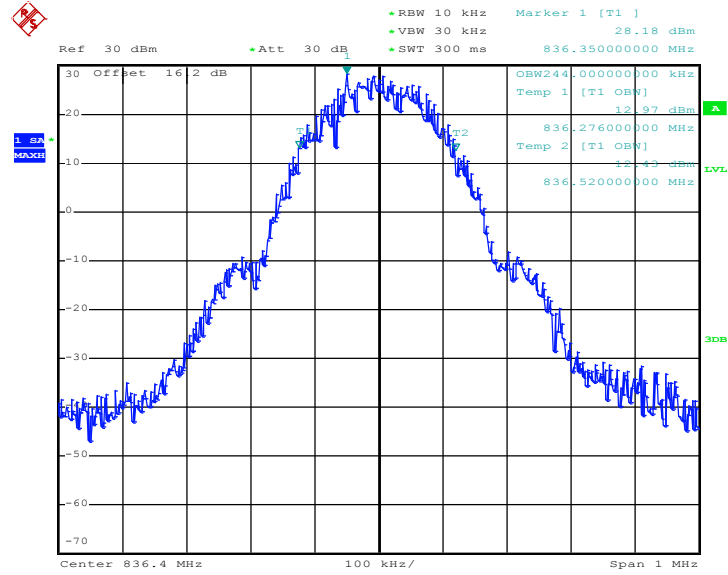

Date: 27.FEB.2013 22:40:47

26dB Bandwidth Plot on Channel 189 (836.4 MHz)

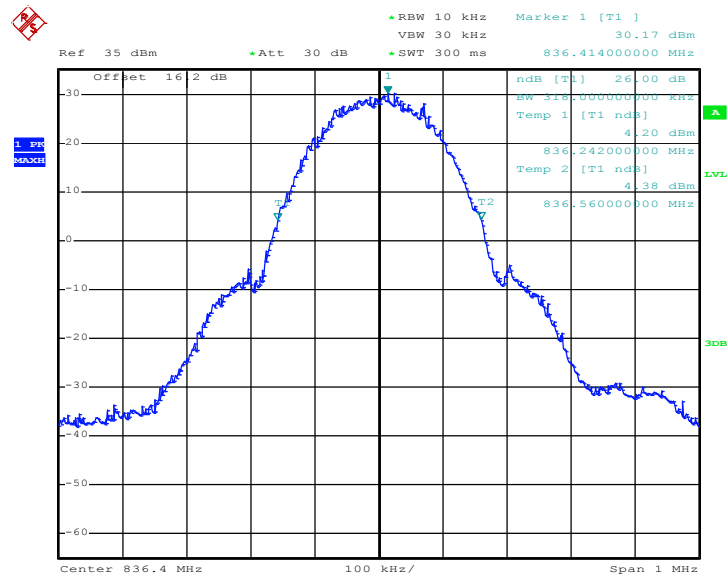

Date: 27.FEB.2013 22:45:05



99% Occupied Bandwidth Plot on Channel 251 (848.8 MHz)

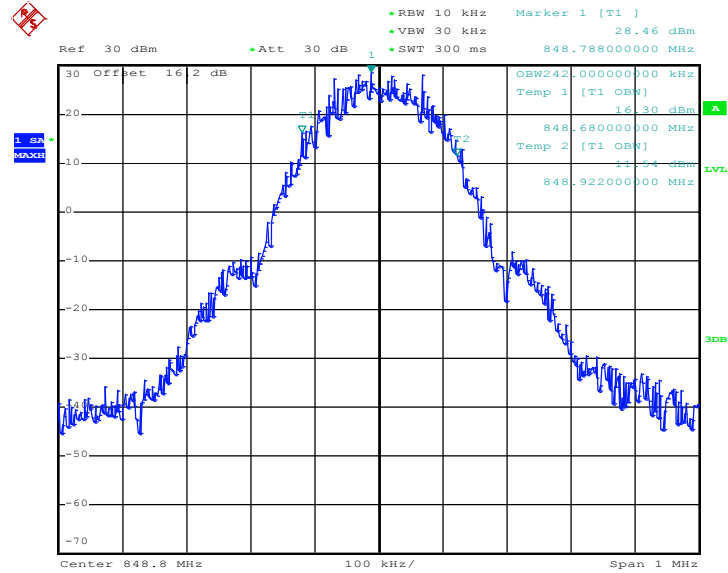

Date: 27.FEB.2013 22:41:13

26dB Bandwidth Plot on Channel 251 (848.8 MHz)

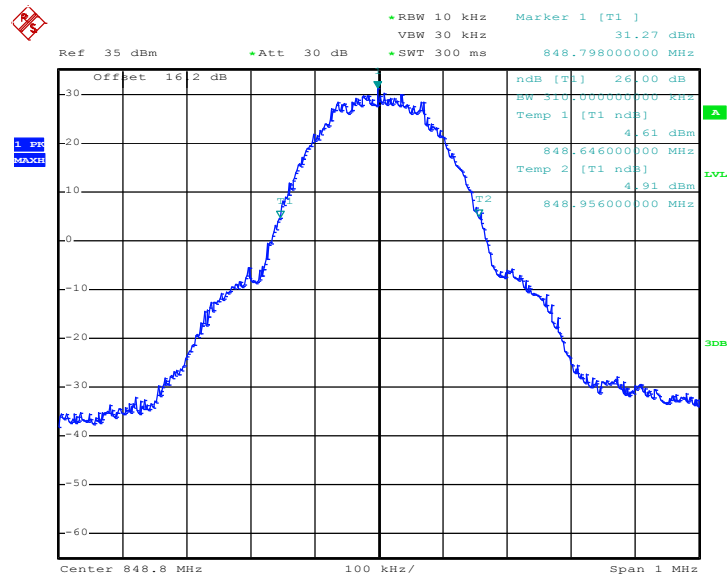

Date: 27.FEB.2013 22:44:07



Band :	GSM 850	Test Mode :	EDGE class 10 Link (8PSK)
---------------	---------	--------------------	---------------------------

99% Occupied Bandwidth Plot on Channel 128 (824.2 MHz)

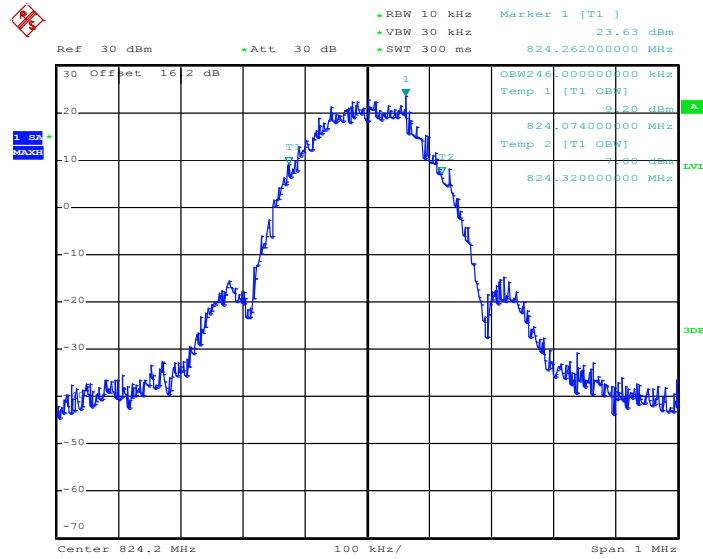

Date: 27.FEB.2013 23:31:49

26dB Bandwidth Plot on Channel 128 (824.2 MHz)

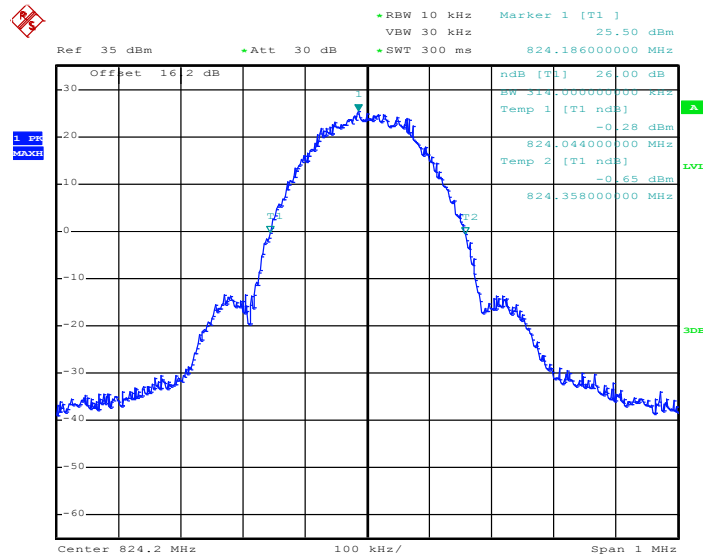

Date: 27.FEB.2013 23:11:13



99% Occupied Bandwidth Plot on Channel 189 (836.4 MHz)

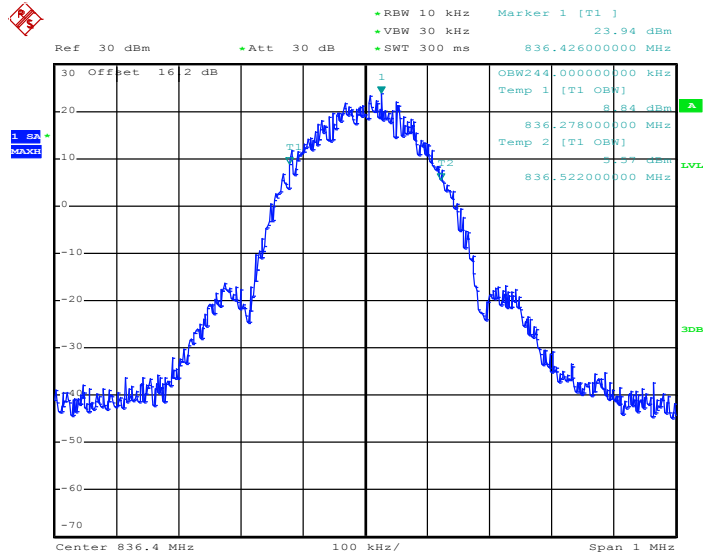

Date: 27.FEB.2013 23:32:14

26dB Bandwidth Plot on Channel 189 (836.4 MHz)

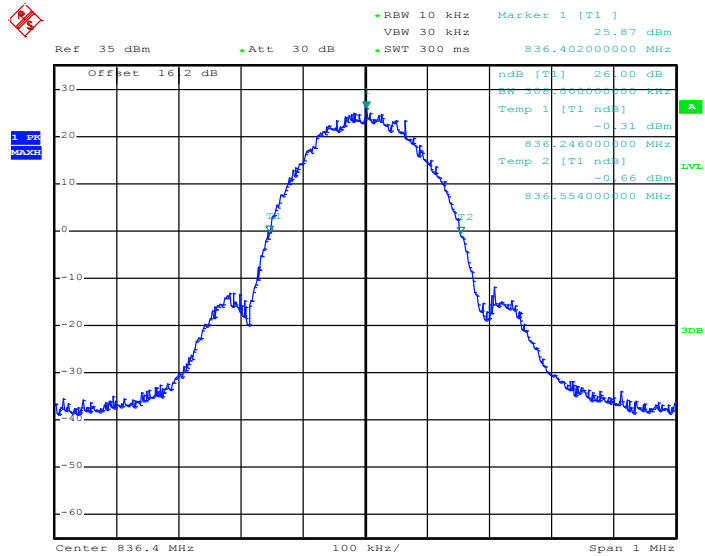

Date: 27.FEB.2013 23:12:10



Band :	GSM 1900	Test Mode :	GPRS class 8 Link (GMSK)
--------	----------	-------------	--------------------------

99% Occupied Bandwidth Plot on Channel 512 (1850.2 MHz)

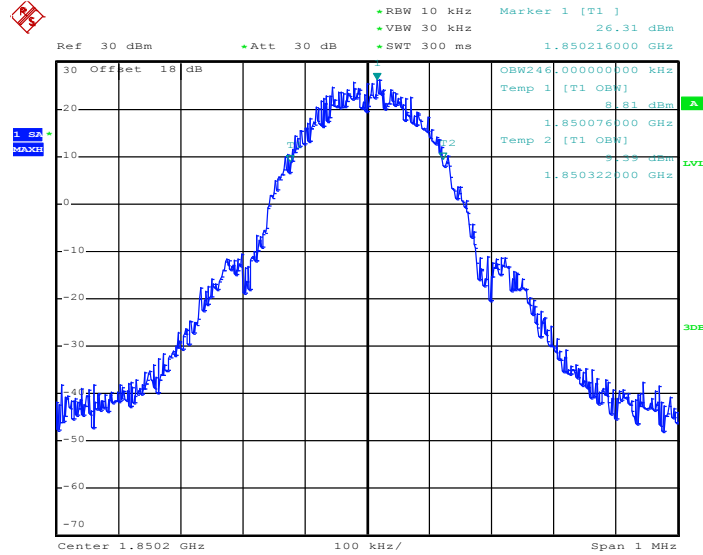

Date: 28.FEB.2013 01:17:10

26dB Bandwidth Plot on Channel 512 (1850.2 MHz)

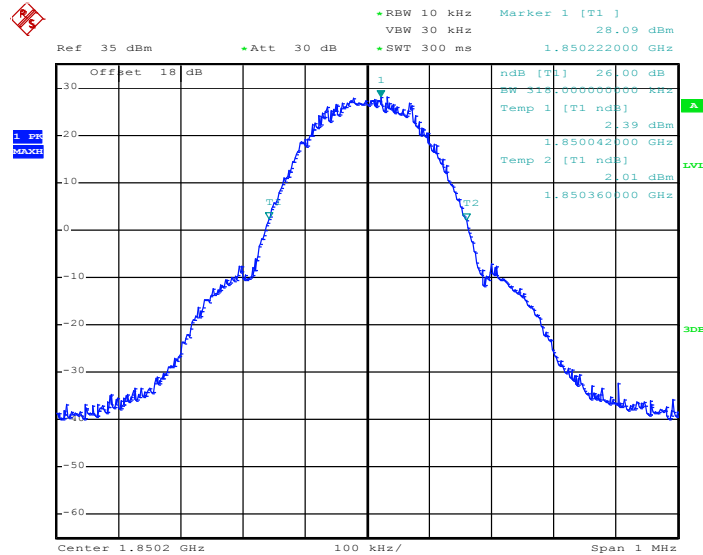

Date: 28.FEB.2013 01:04:55



99% Occupied Bandwidth Plot on Channel 661 (1880.0 MHz)

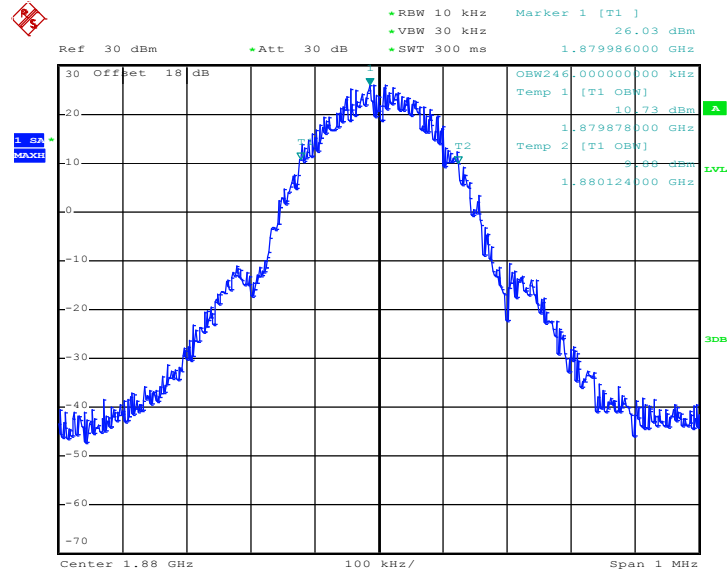

Date: 28.FEB.2013 01:17:36

26dB Bandwidth Plot on Channel 661 (1880.0 MHz)

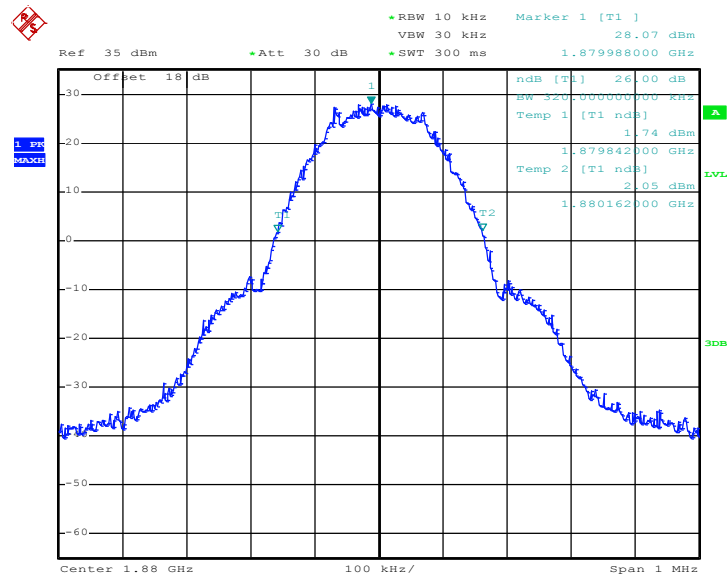

Date: 28.FEB.2013 01:05:50



99% Occupied Bandwidth Plot on Channel 810 (1909.8 MHz)

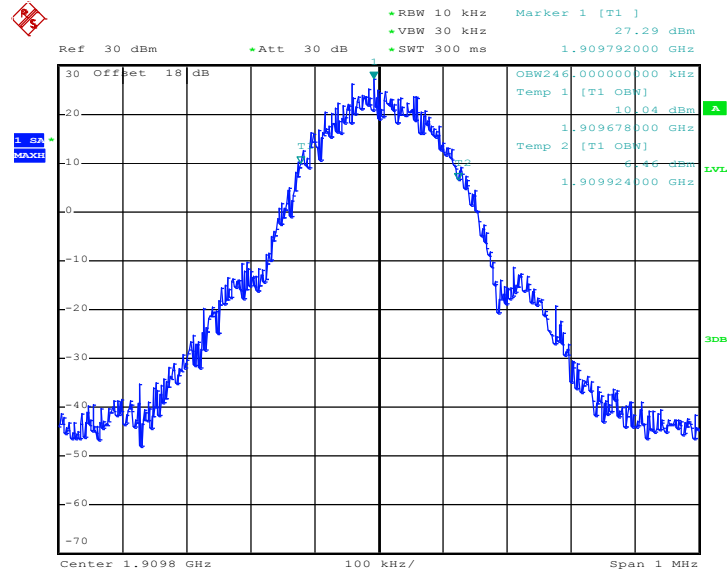

Date: 28.FEB.2013 01:18:02

26dB Bandwidth Plot on Channel 810 (1909.8 MHz)

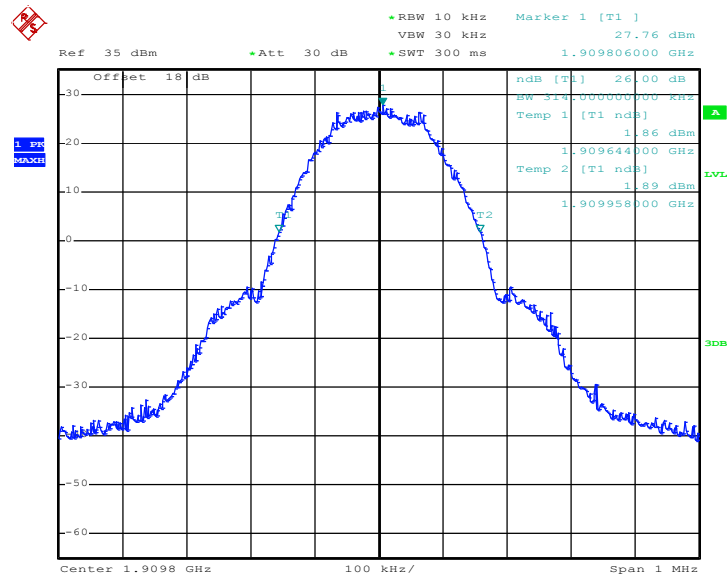

Date: 28.FEB.2013 01:06:56



Band :	GSM 1900	Test Mode :	EDGE class 8 Link (8PSK)
---------------	----------	--------------------	--------------------------

99% Occupied Bandwidth Plot on Channel 512 (1850.2 MHz)

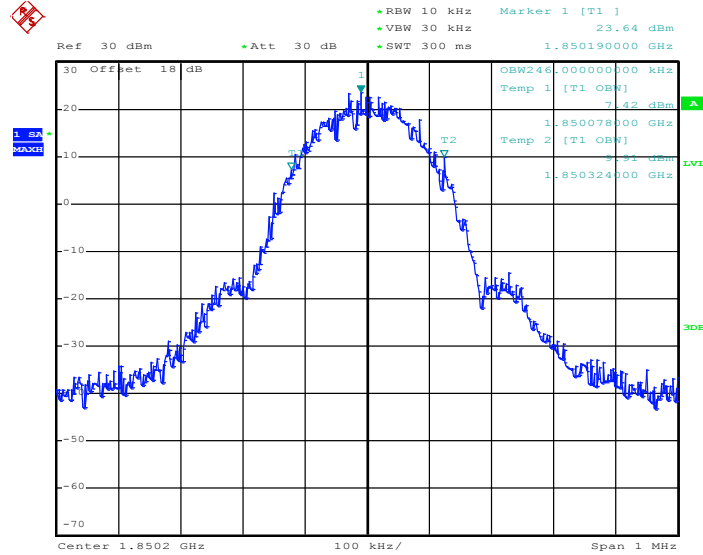

Date: 28.FEB.2013 00:32:27

26dB Bandwidth Plot on Channel 512 (1850.2 MHz)

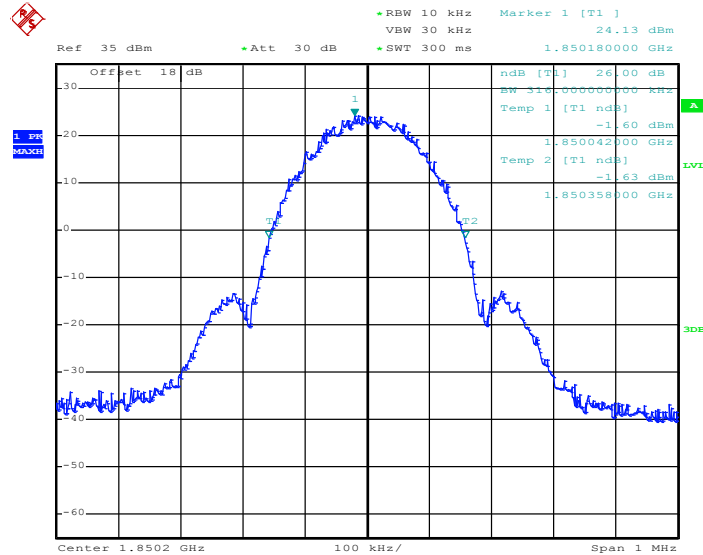

Date: 28.FEB.2013 00:49:51



99% Occupied Bandwidth Plot on Channel 661 (1880.0 MHz)

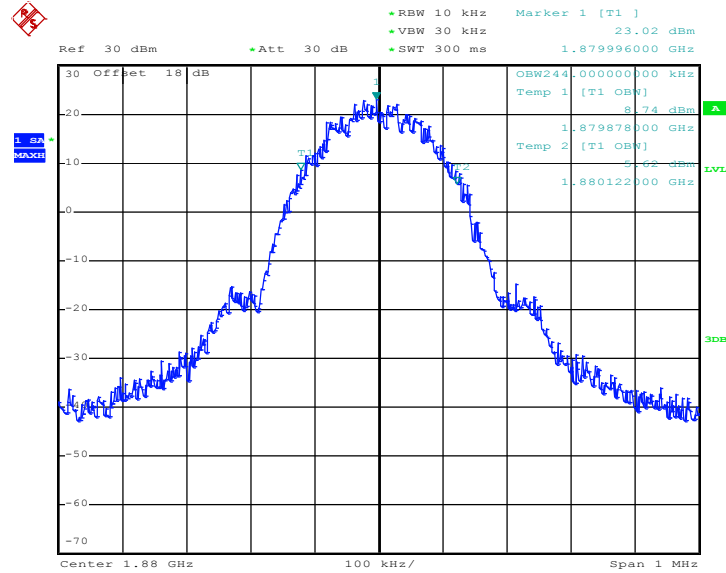

Date: 28.FEB.2013 00:32:53

26dB Bandwidth Plot on Channel 661 (1880.0 MHz)

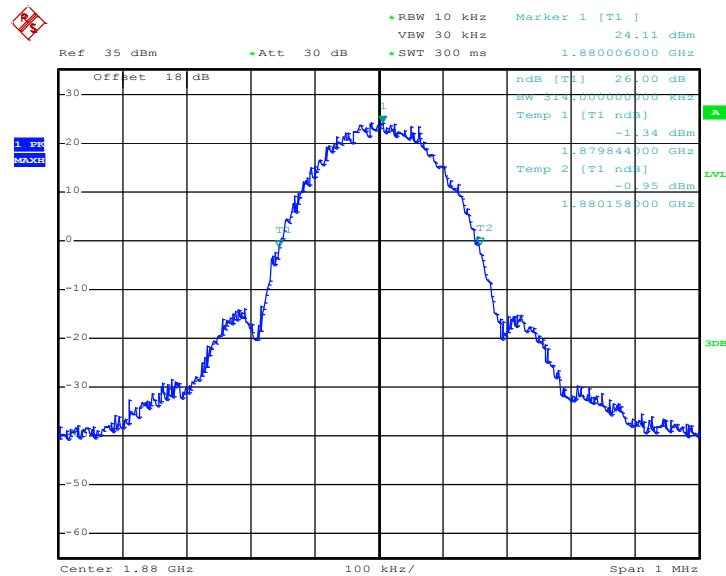

Date: 28.FEB.2013 00:48:50



99% Occupied Bandwidth Plot on Channel 810 (1909.8 MHz)

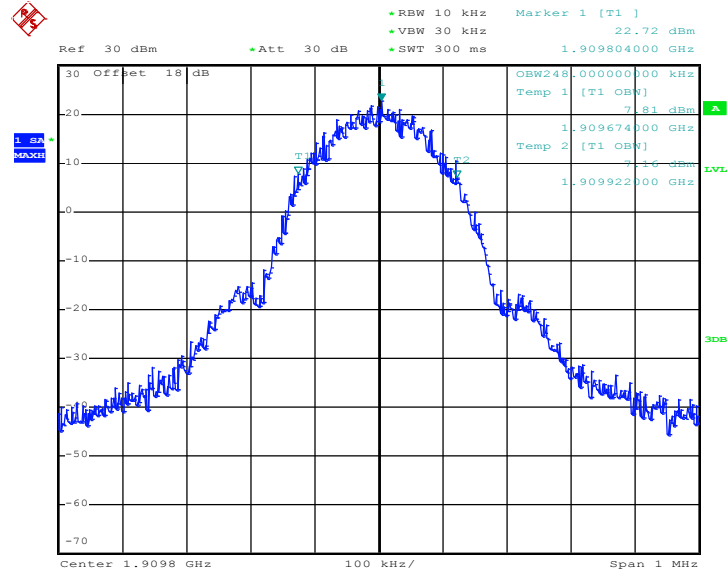

Date: 28.FEB.2013 00:33:19

26dB Bandwidth Plot on Channel 810 (1909.8 MHz)

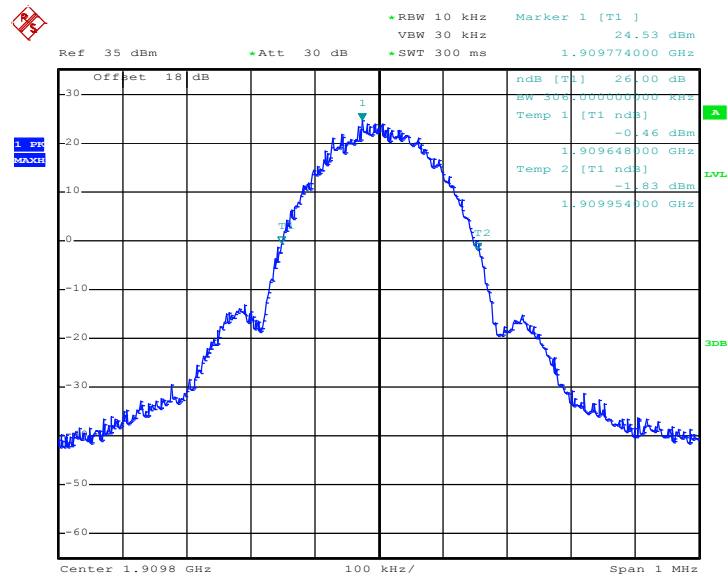

Date: 28.FEB.2013 00:46:26



Band :	WCDMA Band V	Test Mode :	RMC 12.2Kbps Link (QPSK)
---------------	--------------	--------------------	--------------------------

99% Occupied Bandwidth Plot on Channel 4132 (826.4 MHz)

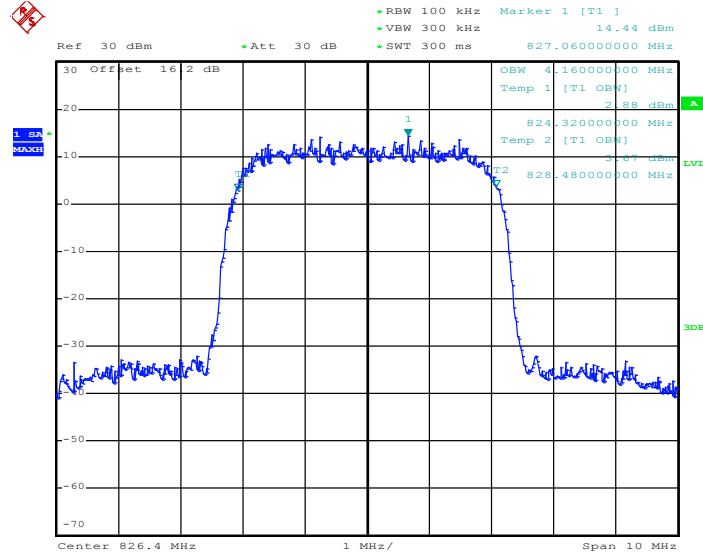

Date: 28.FEB.2013 02:24:14

26dB Bandwidth Plot on Channel 4132 (826.4 MHz)

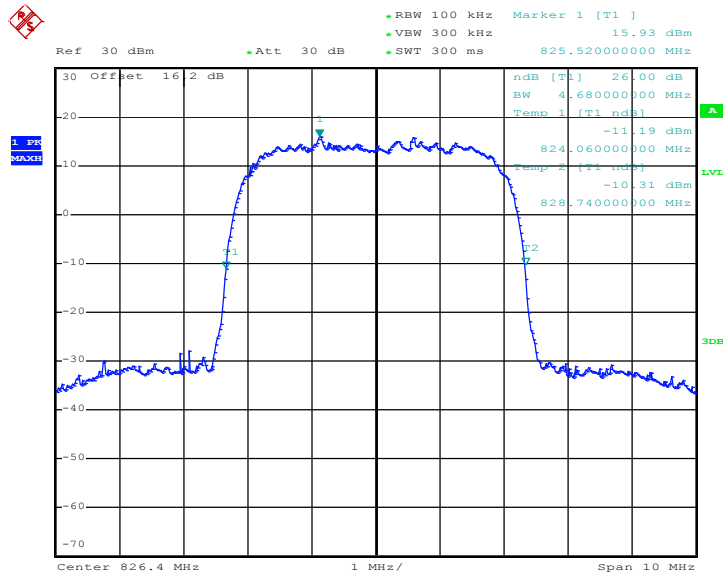

Date: 28.FEB.2013 02:29:08



99% Occupied Bandwidth Plot on Channel 4182 (836.4 MHz)

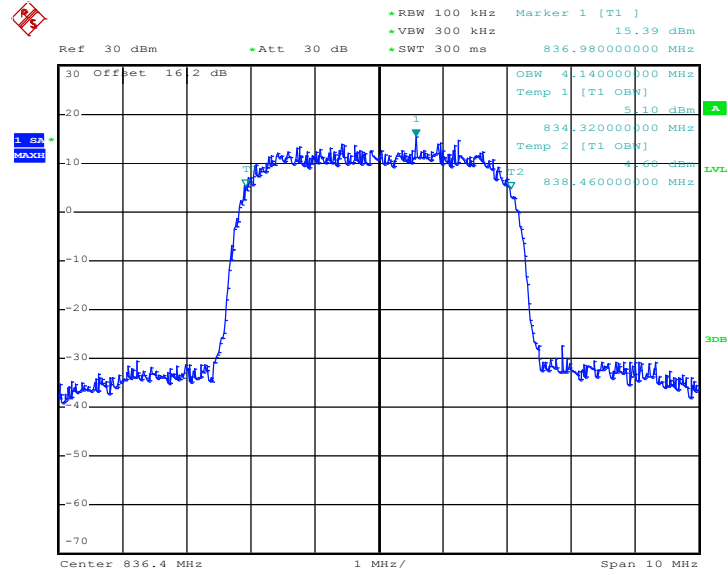

Date: 28.FEB.2013 02:24:40

26dB Bandwidth Plot on Channel 4182 (836.4 MHz)

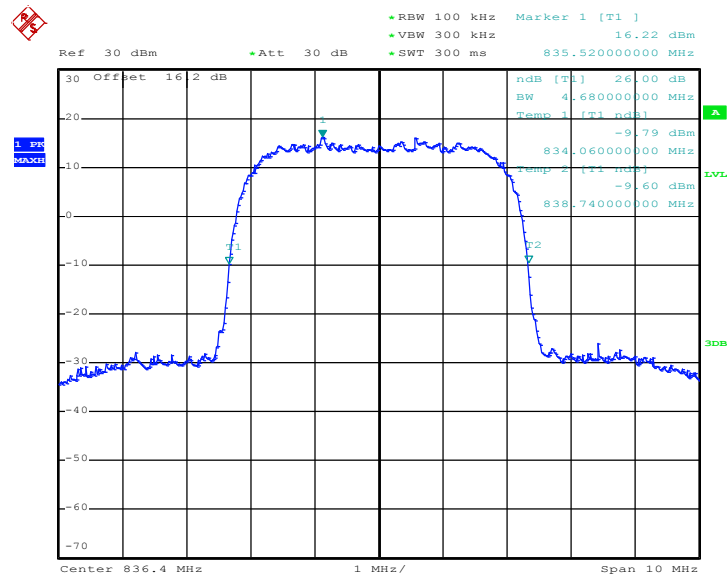

Date: 28.FEB.2013 02:29:34



99% Occupied Bandwidth Plot on Channel 4233 (846.6 MHz)

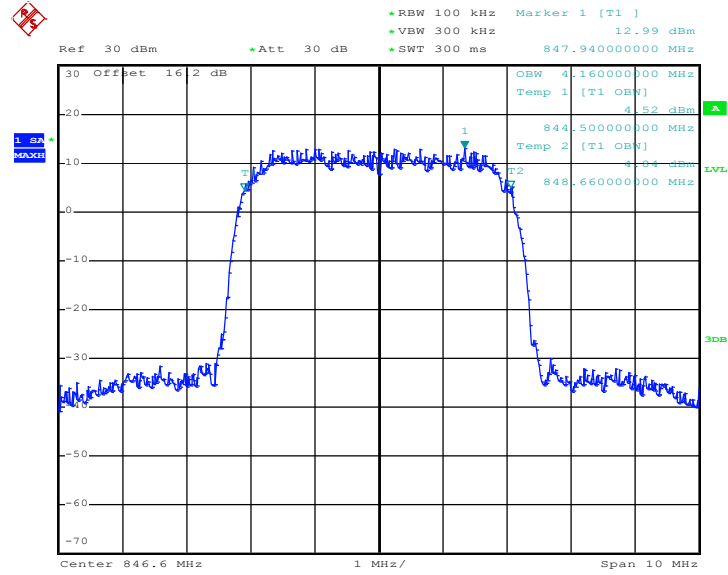

Date: 28.FEB.2013 02:25:06

26dB Bandwidth Plot on Channel 4233 (846.6 MHz)

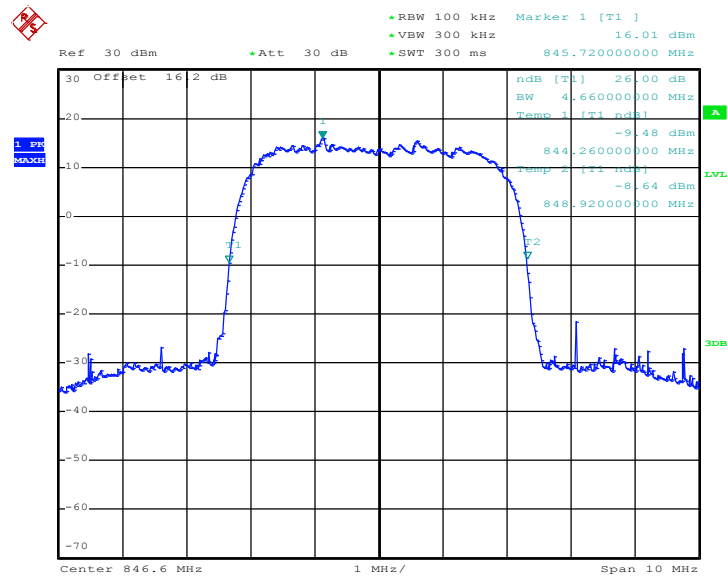

Date: 28.FEB.2013 02:30:00



Band :	WCDMA Band IV	Test Mode :	RMC 12.2Kbps Link (QPSK)
--------	---------------	-------------	--------------------------

99% Occupied Bandwidth Plot on Channel 1312 (1712.4 MHz)

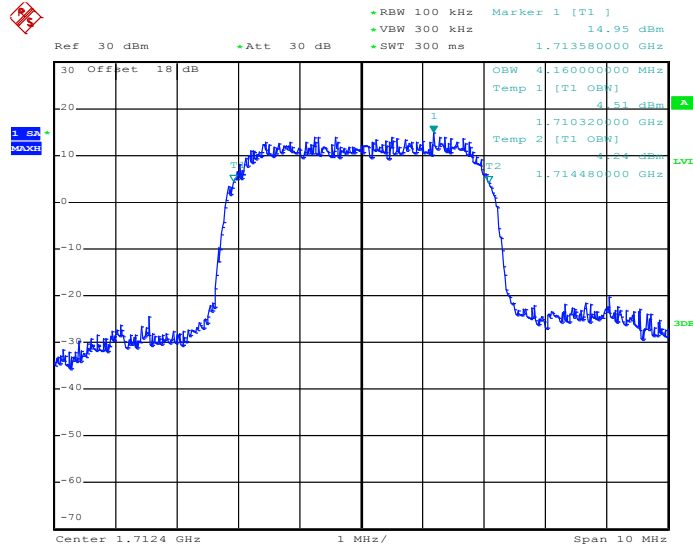

Date: 28.FEB.2013 21:28:35

26dB Bandwidth Plot on Channel 1312 (1712.4 MHz)

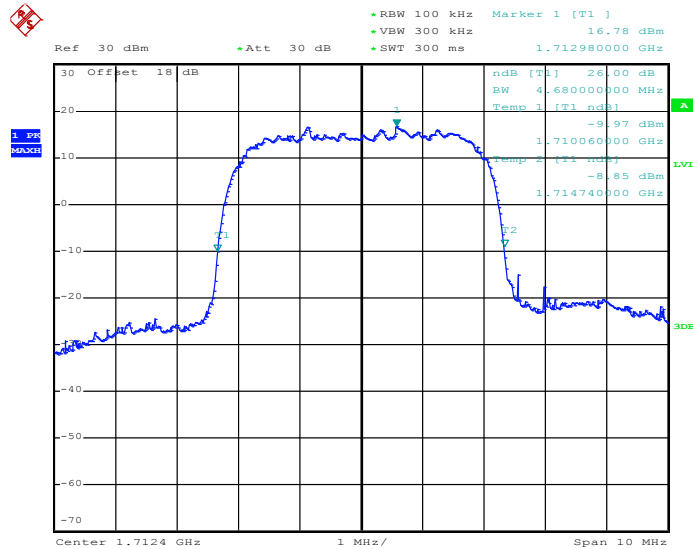

Date: 28.FEB.2013 21:27:16



99% Occupied Bandwidth Plot on Channel 1413 (1732.6 MHz)

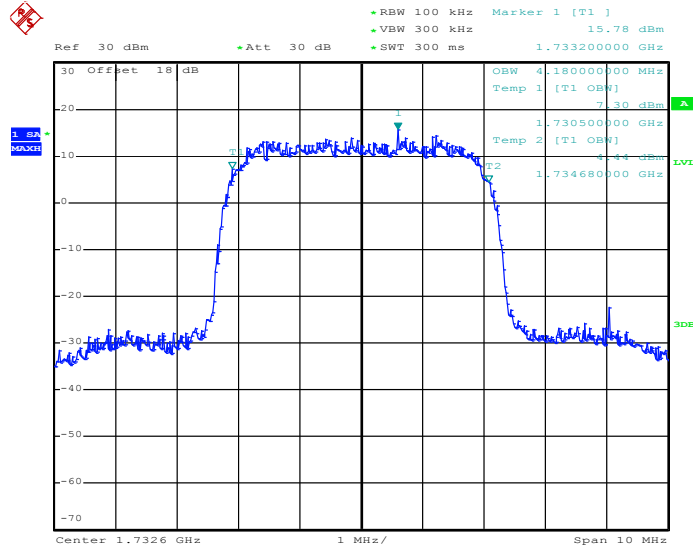

Date: 28.FEB.2013 21:29:01

26dB Bandwidth Plot on Channel 1413 (1732.6 MHz)

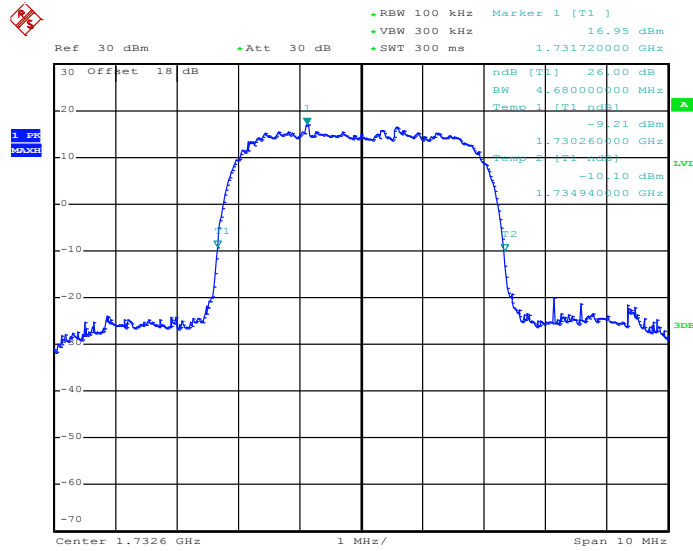

Date: 28.FEB.2013 21:27:43



99% Occupied Bandwidth Plot on Channel 1513 (1752.6 MHz)

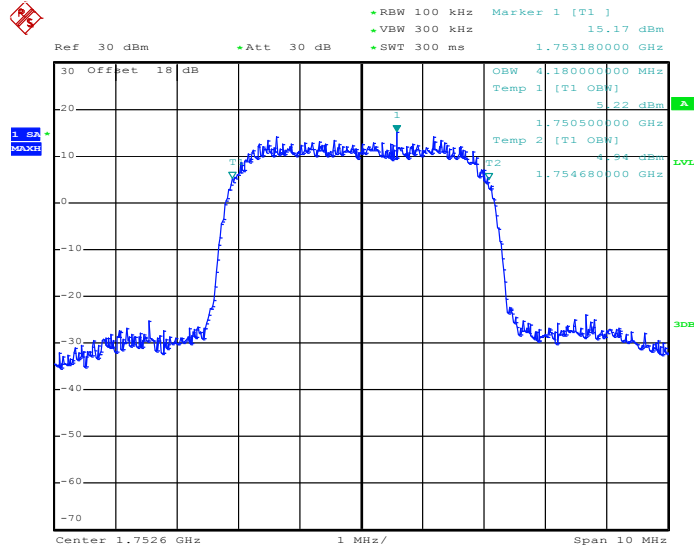

Date: 28.FEB.2013 21:29:27

26dB Bandwidth Plot on Channel 1513 (1752.6 MHz)

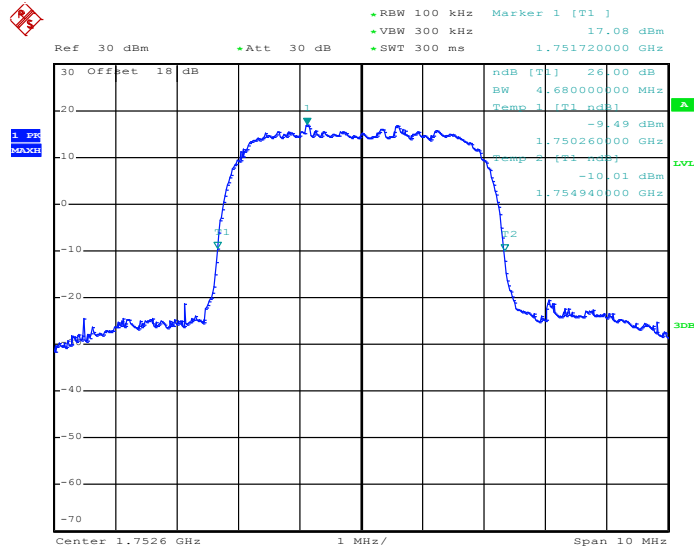

Date: 28.FEB.2013 21:28:09



Band :	WCDMA Band II	Test Mode :	RMC 12.2Kbps Link (QPSK)
---------------	---------------	--------------------	--------------------------

99% Occupied Bandwidth Plot on Channel 9262 (1852.4 MHz)

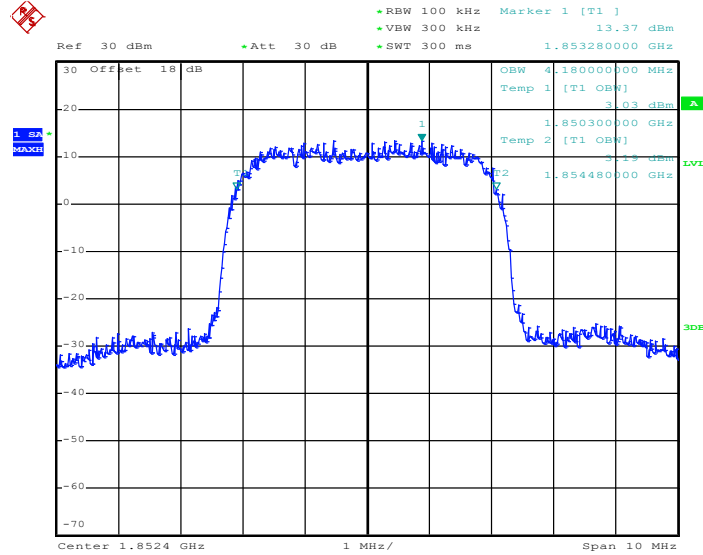

Date: 28.FEB.2013 01:53:55

26dB Bandwidth Plot on Channel 9262 (1852.4 MHz)

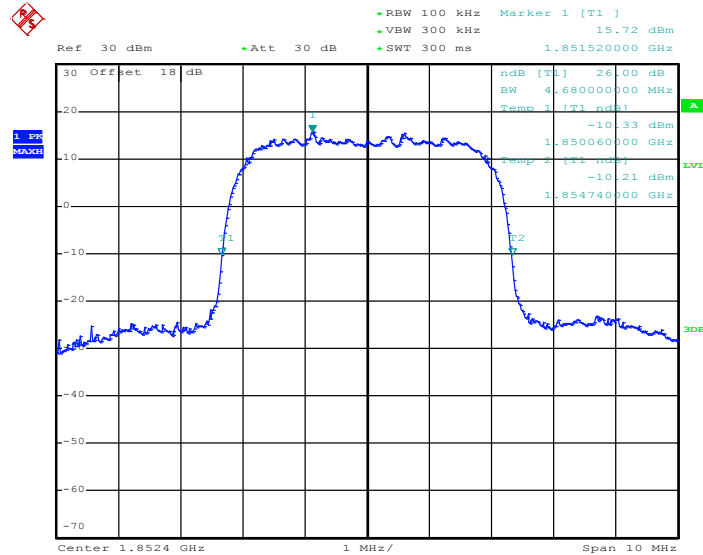

Date: 28.FEB.2013 01:52:36



99% Occupied Bandwidth Plot on Channel 9400 (1880.0 MHz)

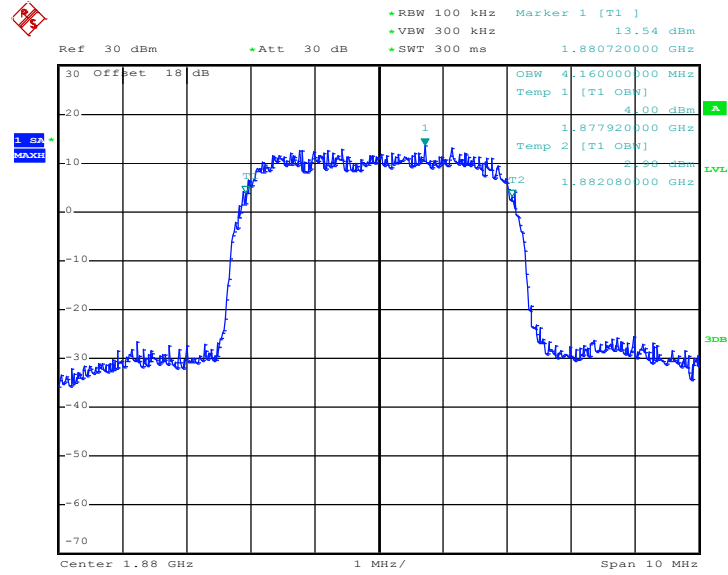

Date: 28.FEB.2013 01:54:21

26dB Bandwidth Plot on Channel 9400 (1880.0 MHz)

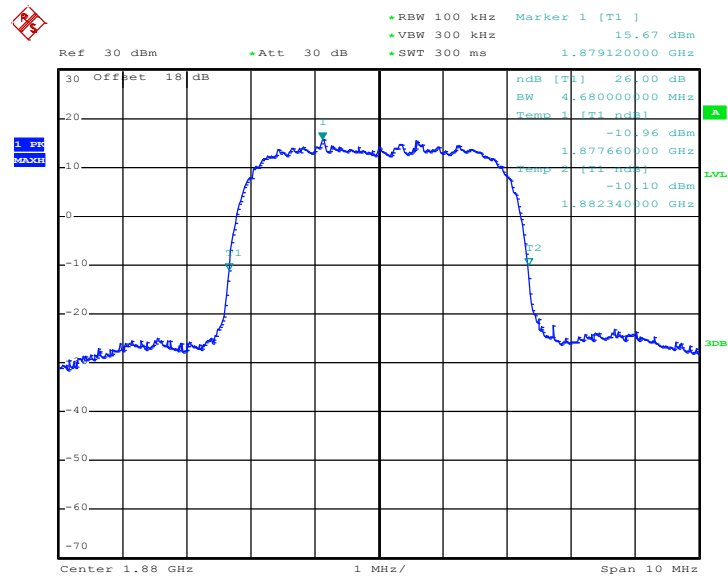

Date: 28.FEB.2013 01:53:02



99% Occupied Bandwidth Plot on Channel 9538 (1907.6 MHz)

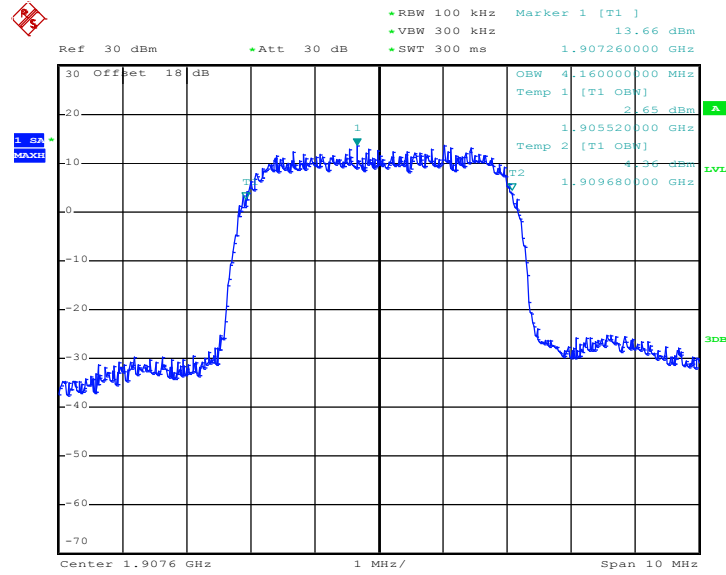

Date: 28.FEB.2013 01:54:47

26dB Bandwidth Plot on Channel 9538 (1907.6 MHz)

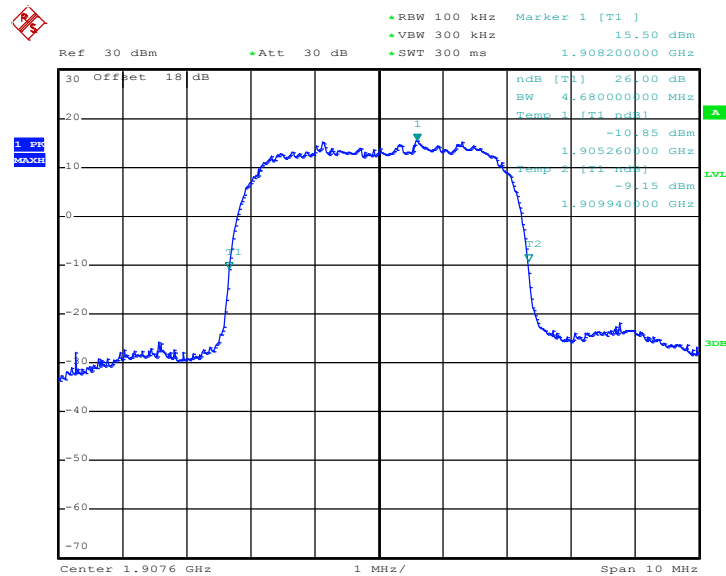

Date: 28.FEB.2013 01:53:28

3.4 Band Edge Measurement

3.4.1 Description of Band Edge Measurement

The power of any emission outside of the authorized operating frequency ranges must be lower than the transmitter power (P) by a factor of at least $43 + 10 \log (P)$ dB.

3.4.2 Measuring Instruments

See list of measuring instruments of this test report.

3.4.3 Test Procedures

1. The EUT was connected to Spectrum Analyzer and Base Station via power divider.
2. The RF output of EUT was connected to the spectrum analyzer by RF cable and attenuator. The path loss was compensated to the results for each measurement.
3. The band edges of low and high channels for the highest RF powers were measured. Setting RBW as roughly $BW/100$.
4. The RF fundamental frequency should be excluded against the limit line in the operating frequency band.
5. The limit line is derived from $43 + 10\log(P)$ dB below the transmitter power P(Watts)

$$= P(W) - [43 + 10\log(P)] \text{ (dB)}$$

$$= [30 + 10\log(P)] \text{ (dBm)} - [43 + 10\log(P)] \text{ (dB)}$$

$$= -13\text{dBm}.$$

3.4.4 Test Setup

<Conducted Band Edge >

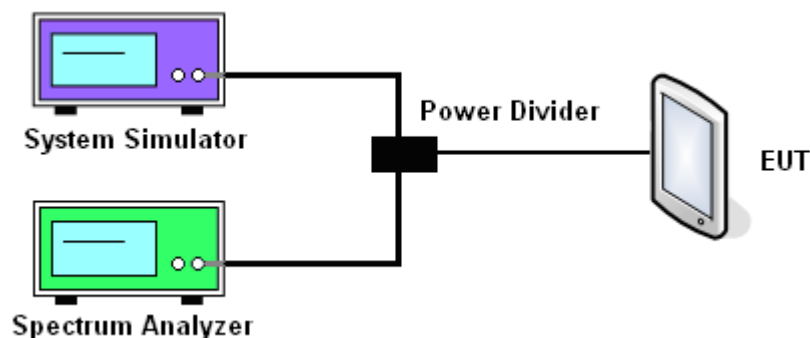

3.4.5 Test Result (Plots) of Conducted Band Edge

Band :	GSM850	Test Mode :	GPRS class 8 Link (GMSK)
Correction Factor :	0.25dB	Maximum 26dB Bandwidth :	0.318MHz
Band Edge :	-18.30dBm	Measurement Value :	-18.55dBm

Lower Band Edge Plot on Channel 128 (824.2 MHz)

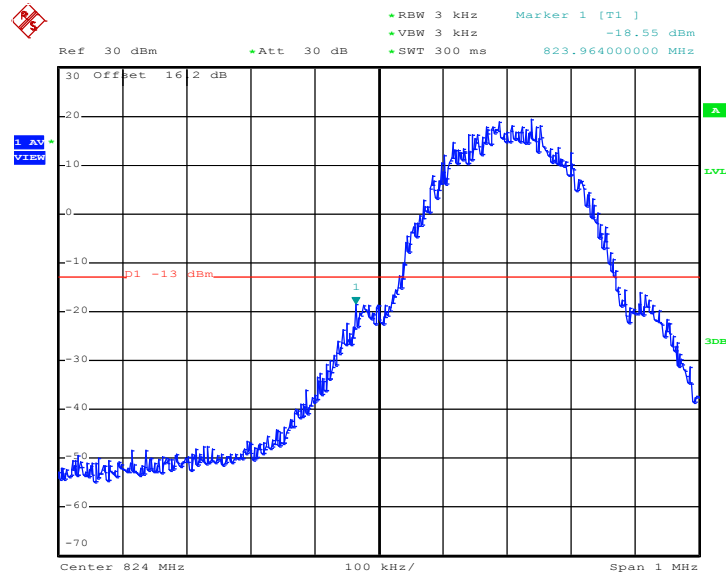

Date: 27.FEB.2013 22:38:13

1. Correction Factor(dB)= $10\log(1\% \text{ Emission BW/RBW})$
2. Band Edge= Measurement Value + Correction Factor(dB)



Band :	GSM850	Test Mode :	GPRS class 8 Link (QPSK)
Correction Factor :	0.25dB	Maximum 26dB Bandwidth :	0.318MHz
Band Edge :	-17.18dBm	Measurement Value :	-17.43dBm

Higher Band Edge Plot on Channel 251 (848.8 MHz)

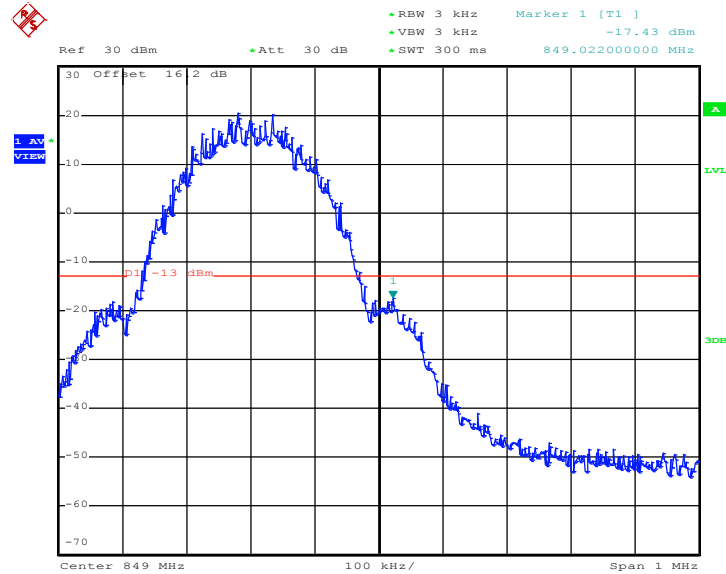

Date: 27.FEB.2013 22:38:39

1. Correction Factor(dB)= $10\log(1\% \text{ Emission BW/RBW})$
2. Band Edge= Measurement Value + Correction Factor(dB)



Band :	GSM850	Test Mode :	EDGE class 10 Link (8PSK)
Correction Factor :	0.23dB	Maximum 26dB Bandwidth :	0.316MHz
Band Edge :	-22.40dBm	Measurement Value :	-22.63dBm

Lower Band Edge Plot on Channel 128 (824.2 MHz)

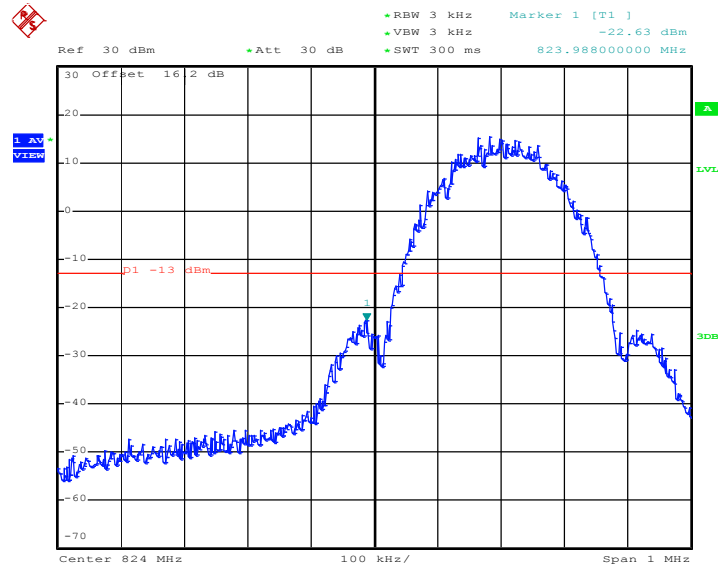

Date: 27.FEB.2013 23:33:07

1. Correction Factor(dB)= $10\log(1\% \text{ Emission BW/RBW})$
2. Band Edge= Measurement Value + Correction Factor(dB)



Band :	GSM850	Test Mode :	EDGE class 10 Link (8PSK)
Correction Factor :	0.23dB	Maximum 26dB Bandwidth :	0.316MHz
Band Edge :	-24.21dBm	Measurement Value :	-24.44dBm

Higher Band Edge Plot on Channel 251 (848.8 MHz)

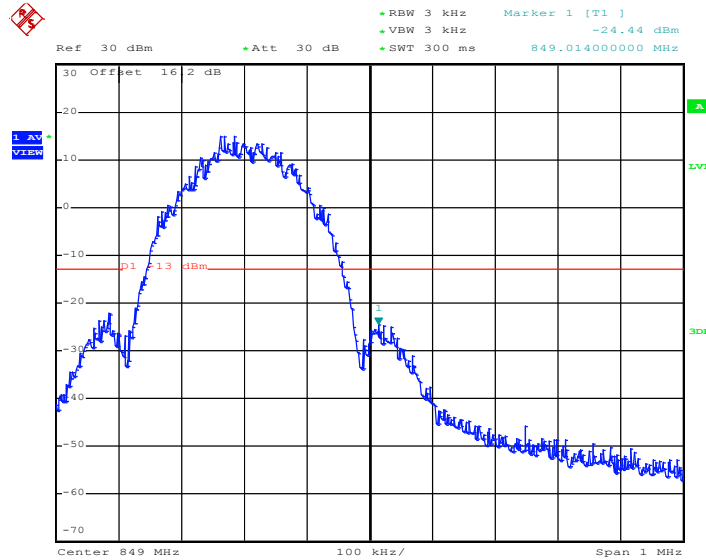

Date: 27.FEB.2013 23:33:33

1. Correction Factor(dB)= $10\log(1\% \text{ Emission BW/RBW})$
2. Band Edge= Measurement Value + Correction Factor(dB)



Band :	GSM1900	Test Mode :	GPRS class 8 Link (GMSK)
Correction Factor :	0.28dB	Maximum 26dB Bandwidth :	0.320MHz
Band Edge :	-19.58dBm	Measurement Value :	-19.86dBm

Lower Band Edge Plot on Channel 512 (1850.2 MHz)

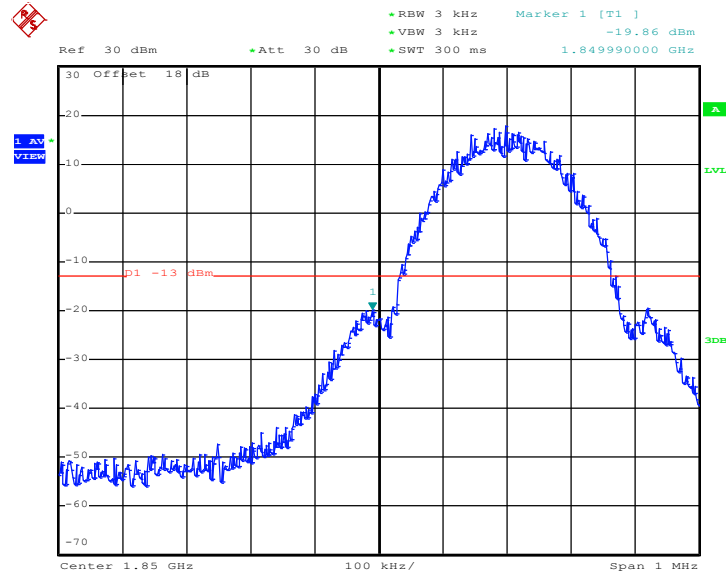

Date: 28.FEB.2013 01:26:29

1. Correction Factor(dB)= 10log(1% Emission BW/RBW)
2. Band Edge= Measurement Value + Correction Factor(dB)



Band :	GSM1900	Test Mode :	GPRS class 8 Link (GMSK)
Correction Factor :	0.28dB	Maximum 26dB Bandwidth :	0.320MHz
Band Edge :	-21.22dBm	Measurement Value :	-21.50dBm

Higher Band Edge Plot on Channel 810 (1909.8 MHz)

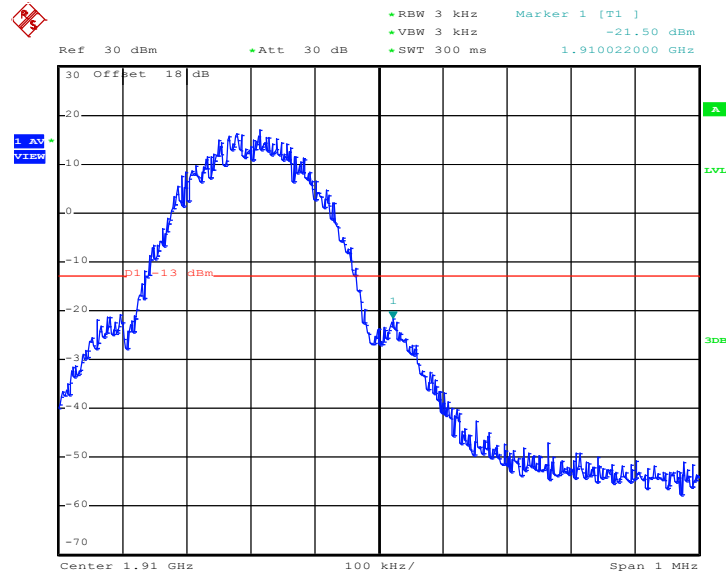

Date: 28.FEB.2013 01:26:55

1. Correction Factor(dB)= $10\log(1\% \text{ Emission BW/RBW})$
2. Band Edge= Measurement Value + Correction Factor(dB)



Band :	GSM1900	Test Mode :	EDGE class 8 Link (8PSK)
Correction Factor :	0.23dB	Maximum 26dB Bandwidth :	0.316MHz
Band Edge :	-22.92dBm	Measurement Value :	-23.15dBm

Lower Band Edge Plot on Channel 512 (1850.2 MHz)

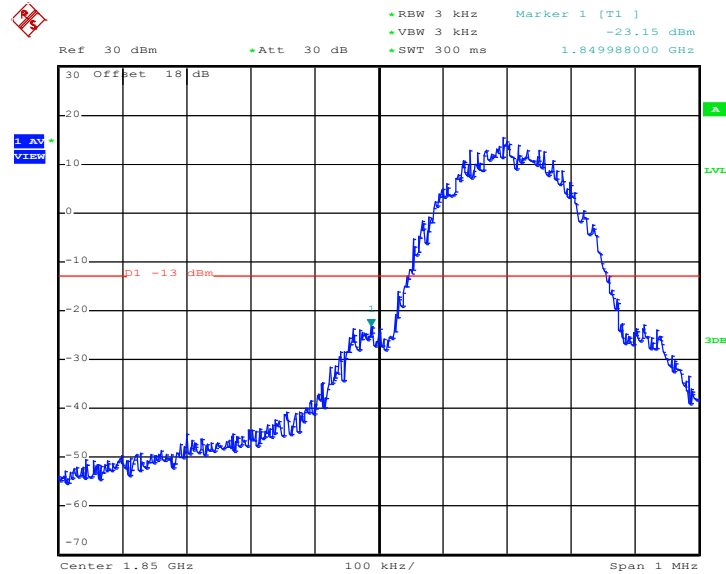

Date: 28.FEB.2013 00:33:46

1. Correction Factor(dB)= $10\log(1\% \text{ Emission BW/RBW})$
2. Band Edge= Measurement Value + Correction Factor(dB)



Band :	GSM1900	Test Mode :	EDGE class 8 Link (8PSK)
Correction Factor :	0.23dB	Maximum 26dB Bandwidth :	0.316MHz
Band Edge :	-24.89dBm	Measurement Value :	-25.12dBm

Higher Band Edge Plot on Channel 810 (1909.8 MHz)

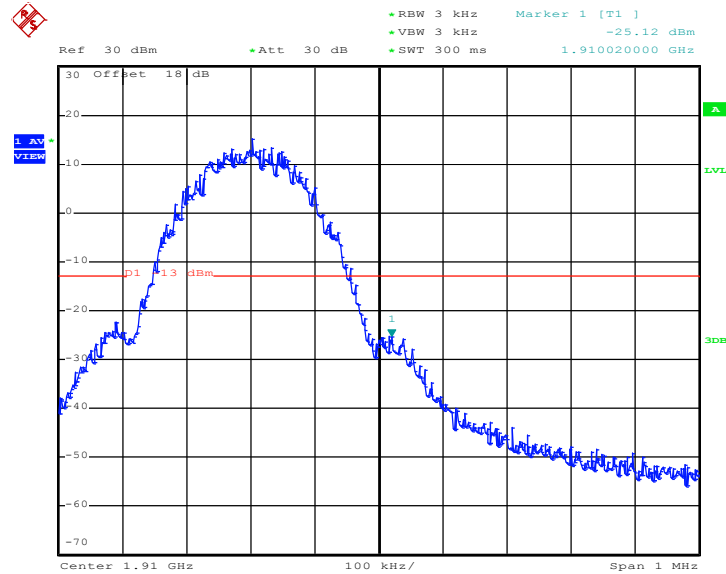

Date: 28.FEB.2013 00:34:12

1. Correction Factor(dB)= $10\log(1\% \text{ Emission BW/RBW})$
2. Band Edge= Measurement Value + Correction Factor(dB)



Band :	WCDMA Band V	Test Mode :	RMC 12.2Kbps Link (QPSK)
Correction Factor :	-3.30dB	Maximum 26dB Bandwidth :	4.680MHz
Band Edge :	-33.90dBm	Measurement Value :	-30.60dBm

Lower Band Edge Plot on Channel 4132 (826.4 MHz)

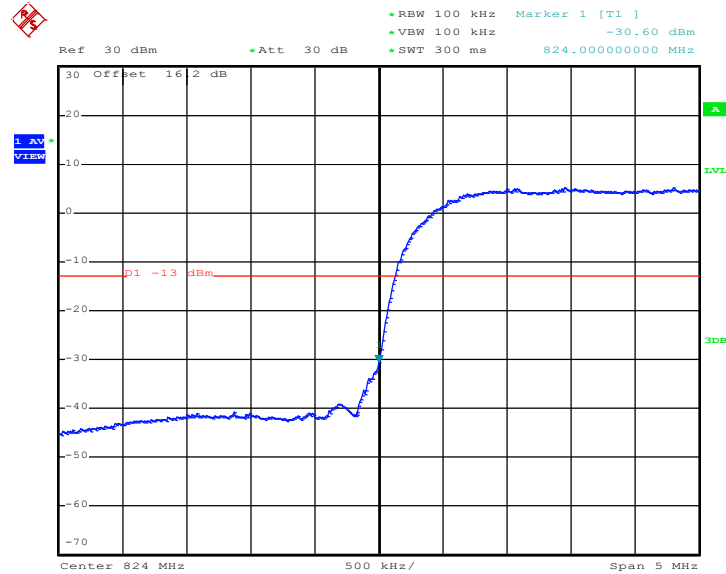

Date: 28.FEB.2013 02:25:33

1. Correction Factor(dB)= 10log(1% Emission BW/RBW)
2. Band Edge= Measurement Value + Correction Factor(dB)



Band :	WCDMA Band V	Test Mode :	RMC 12.2Kbps Link (QPSK)
Correction Factor :	-3.30B	Maximum 26dB Bandwidth :	4.680MHz
Band Edge :	-33.60dBm	Measurement Value :	-30.30dBm

Higher Band Edge Plot on Channel 4233 (846.6 MHz)

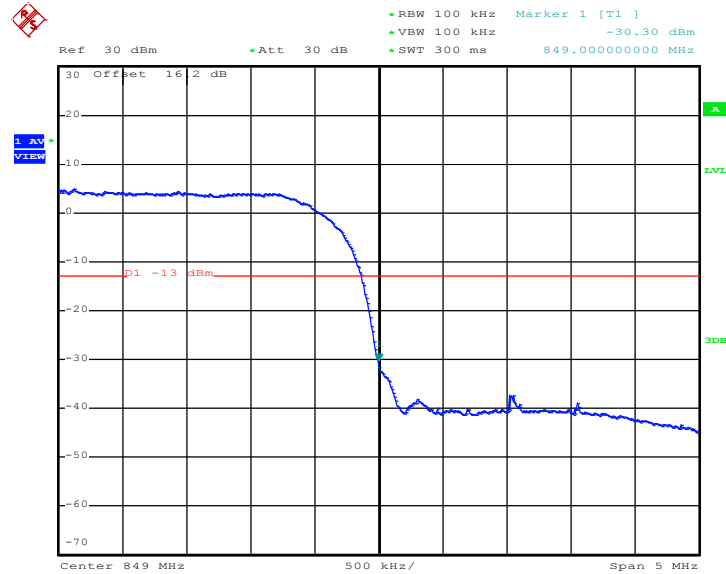

Date: 28.FEB.2013 02:25:59

1. Correction Factor(dB)= $10\log(1\% \text{ Emission BW/RBW})$
2. Band Edge= Measurement Value + Correction Factor(dB)



Band :	WCDMA Band IV	Test Mode :	RMC 12.2Kbps Link (QPSK)
Correction Factor :	-3.30dB	Maximum 26dB Bandwidth :	4.680MHz
Band Edge :	-31.11dBm	Measurement Value :	-27.81dBm

Lower Band Edge Plot on Channel 1312 (1712.4 MHz)

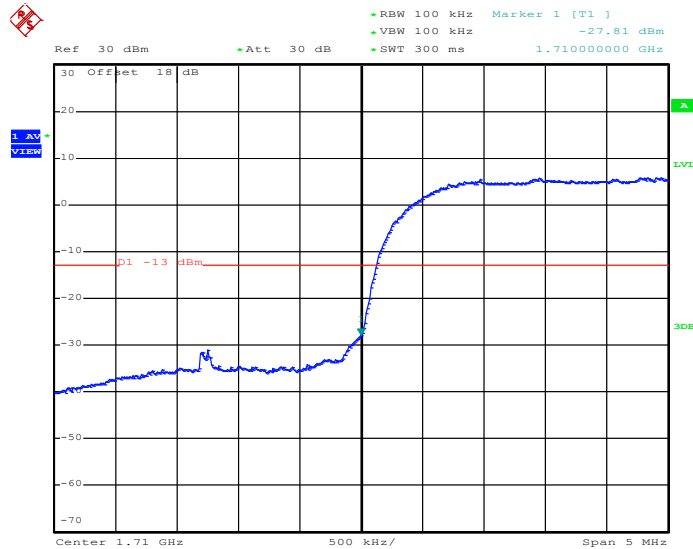

Date: 28.FEB.2013 21:29:54

1. Correction Factor(dB)= $10\log(1\% \text{ Emission BW/RBW})$
2. Band Edge= Measurement Value + Correction Factor(dB)



Band :	WCDMA Band IV	Test Mode :	RMC 12.2Kbps Link (QPSK)
Correction Factor :	-3.30dB	Maximum 26dB Bandwidth :	4.680MHz
Band Edge :	-31.13dBm	Measurement Value :	-27.83dBm

Higher Band Edge Plot on Channel 1513 (1752.6 MHz)

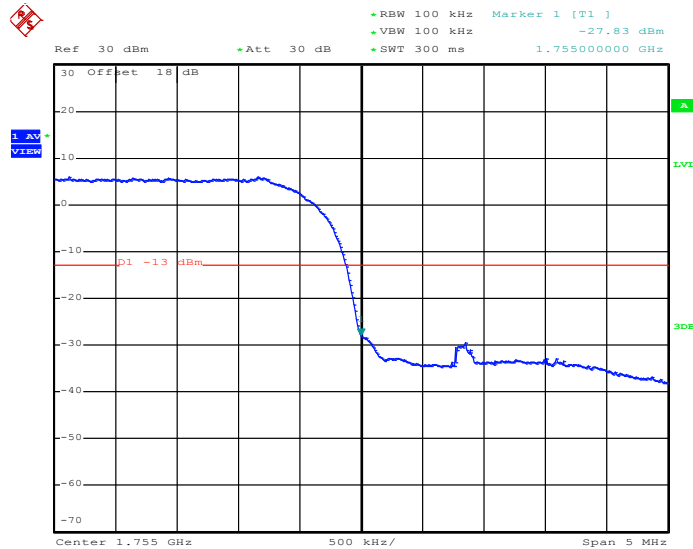

Date: 28.FEB.2013 21:30:20

1. Correction Factor(dB)= $10\log(1\% \text{ Emission BW/RBW})$
2. Band Edge= Measurement Value + Correction Factor(dB)



Band :	WCDMA Band II	Test Mode :	RMC 12.2Kbps Link (QPSK)
Correction Factor :	-3.30dB	Maximum 26dB Bandwidth :	4.680MHz
Band Edge :	-31.92dBm	Measurement Value :	-28.62dBm

Lower Band Edge Plot on Channel 9262 (1852.4 MHz)

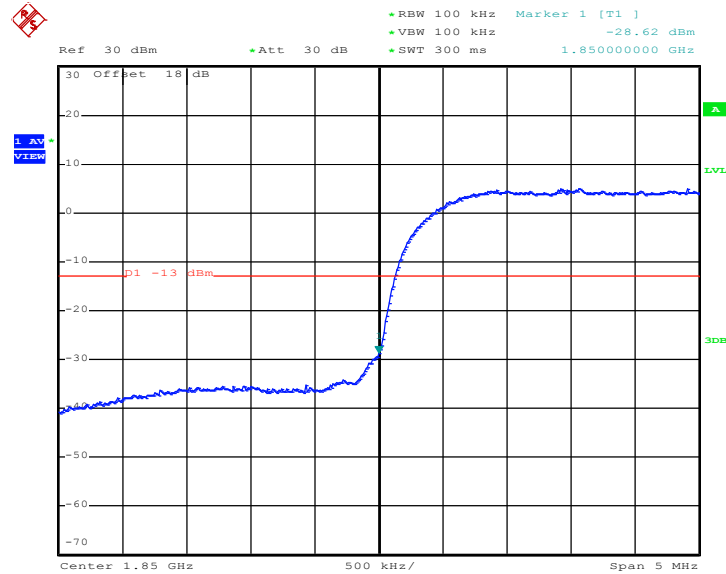

Date: 28.FEB.2013 01:55:13

1. Correction Factor(dB)= 10log(1% Emission BW/RBW)
2. Band Edge= Measurement Value + Correction Factor(dB)

3.5 Conducted Spurious Emission Measurement

3.5.1 Description of Conducted Spurious Emission Measurement

The power of any emission outside of the authorized operating frequency ranges must be lower than the transmitter power (P) by a factor of at least $43 + 10 \log (P)$ dB.

It is measured by means of a calibrated spectrum analyzer and scanned from 30 MHz up to a frequency including its 10th harmonic.

3.5.2 Measuring Instruments

See list of measuring instruments of this test report.

3.5.3 Test Procedures

1. The EUT was connected to spectrum analyzer and base station via power divider.
2. The RF output of EUT was connected to the spectrum analyzer by RF cable and attenuator. The path loss was compensated to the results for each measurement.
3. The middle channel for the highest RF power within the transmitting frequency was measured.
4. The conducted spurious emission for the whole frequency range was taken.
5. The RF fundamental frequency should be excluded against the limit line in the operating frequency band.
6. The limit line is derived from $43 + 10\log(P)$ dB below the transmitter power P(Watts)
 $= P(W) - [43 + 10\log(P)]$ (dB)
 $= [30 + 10\log(P)]$ (dBm) - $[43 + 10\log(P)]$ (dB)
 $= -13\text{dBm}$.

3.5.4 Test Setup

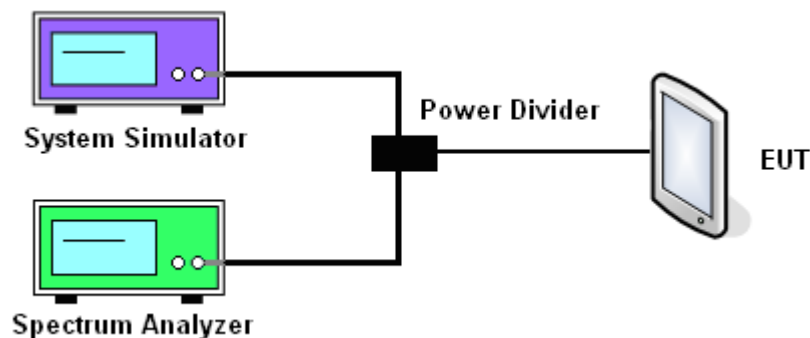



3.5.5 Test Result (Plots) of Conducted Emission

Band :	GSM850	Channel :	CH189
Test Mode :	GPRS class 8 Link (GMSK)	Frequency :	836.4 MHz

Conducted Spurious Emission Plot between 30MHz ~ 1GHz

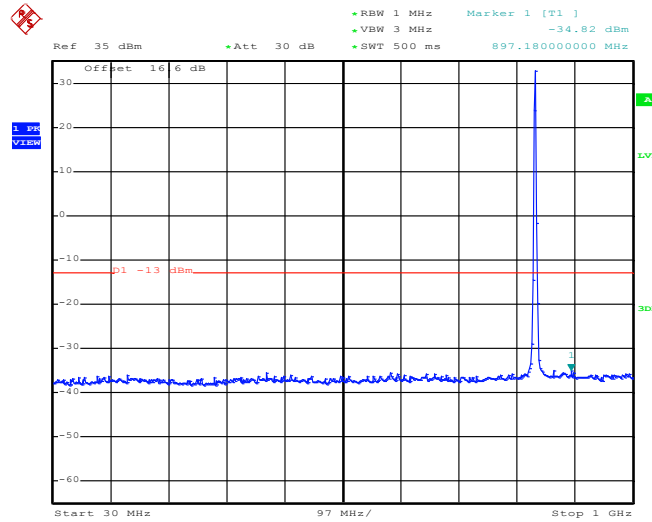

Date: 27.FEB.2013 22:17:50

Conducted Spurious Emission Plot between 1GHz ~ 3GHz

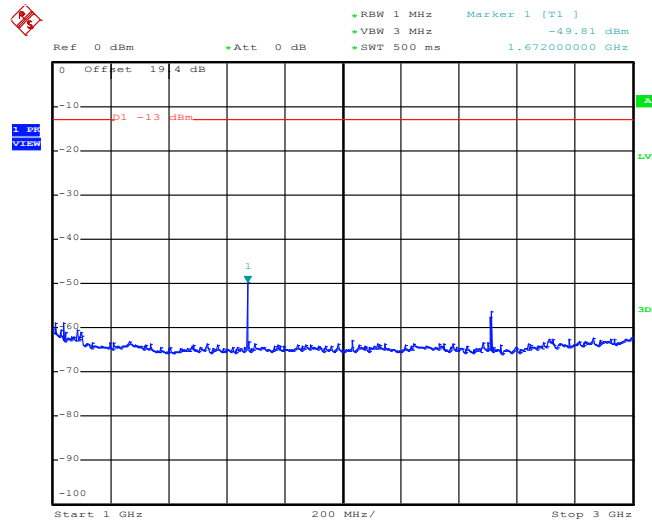

Date: 27.FEB.2013 22:18:08



Conducted Spurious Emission Plot between 3GHz ~ 7GHz

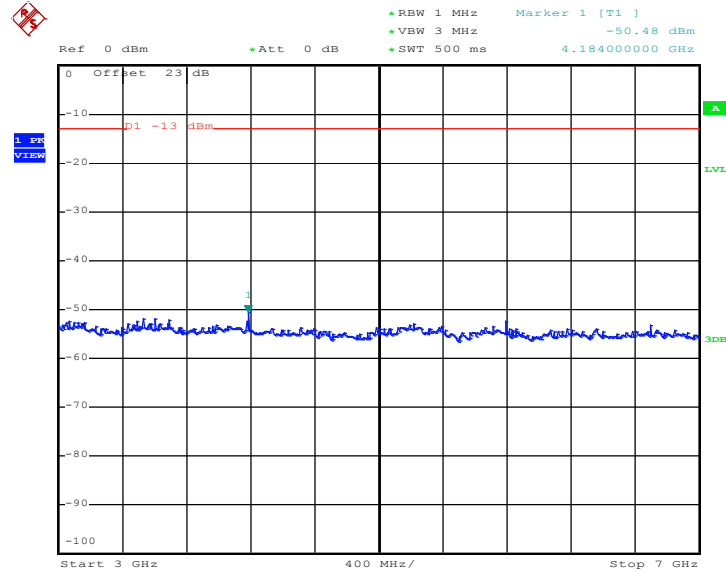

Date: 27.FEB.2013 22:18:21

Conducted Spurious Emission Plot between 7GHz ~ 9GHz

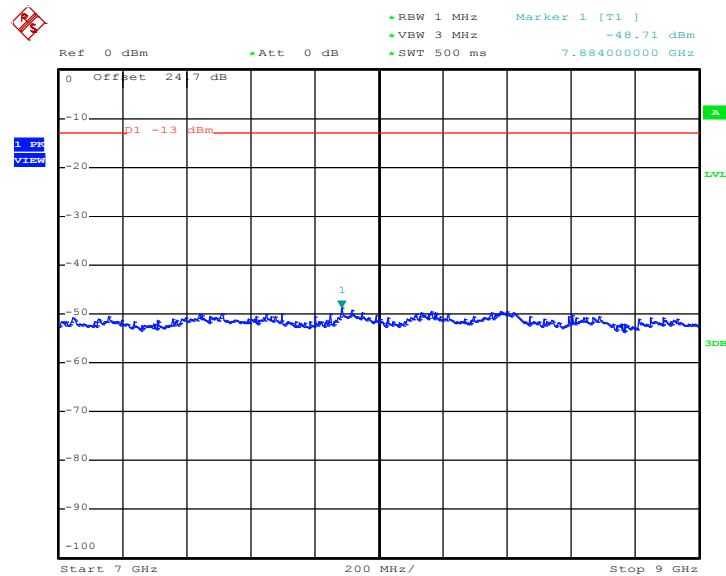

Date: 27.FEB.2013 22:18:33



Conducted Spurious Emission Plot between 3GHz ~ 7GHz

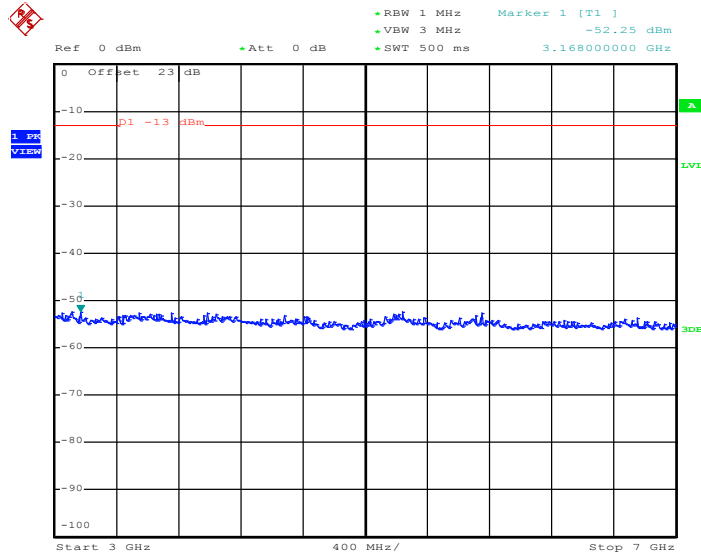

Date: 27.FEB.2013 23:40:21

Conducted Spurious Emission Plot between 7GHz ~ 9GHz

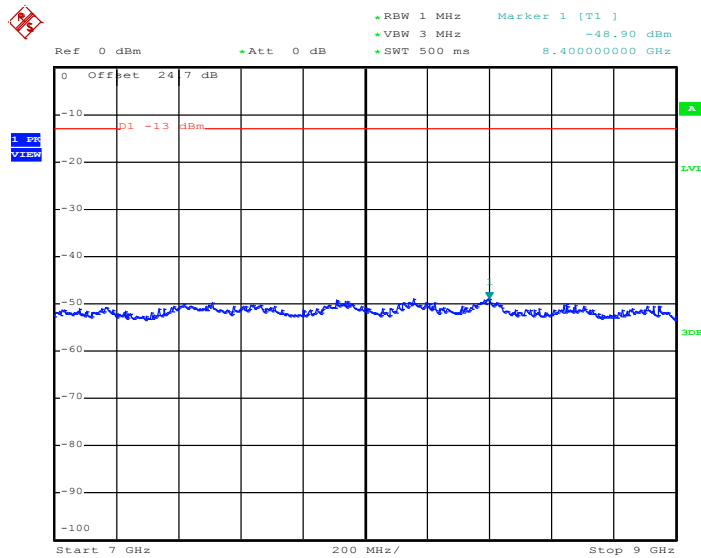

Date: 27.FEB.2013 23:40:33



Band :	GSM1900	Channel :	CH661
Test Mode :	GPRS class 8 Link (GMSK)	Frequency :	1880.0 MHz

Conducted Spurious Emission Plot between 30MHz ~ 1GHz

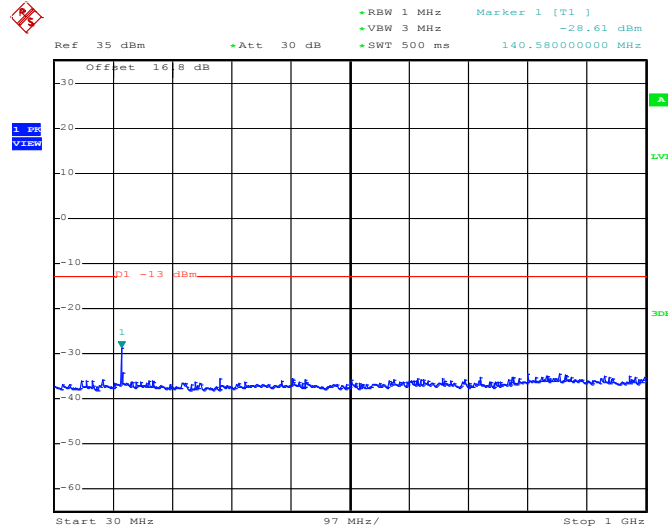

Date: 28.FEB.2013 01:15:27

Conducted Spurious Emission Plot between 1GHz ~ 3GHz

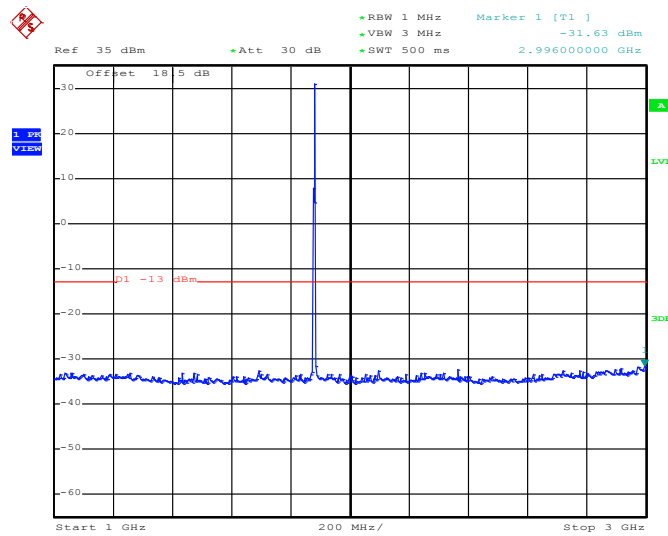

Date: 28.FEB.2013 01:15:39



Conducted Spurious Emission Plot between 3GHz ~ 7GHz

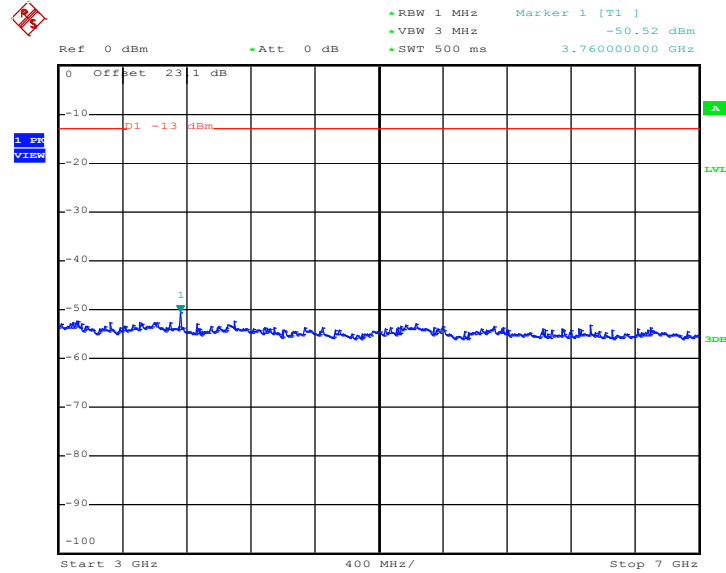

Date: 28.FEB.2013 01:15:56

Conducted Spurious Emission Plot between 7GHz ~ 13.6G

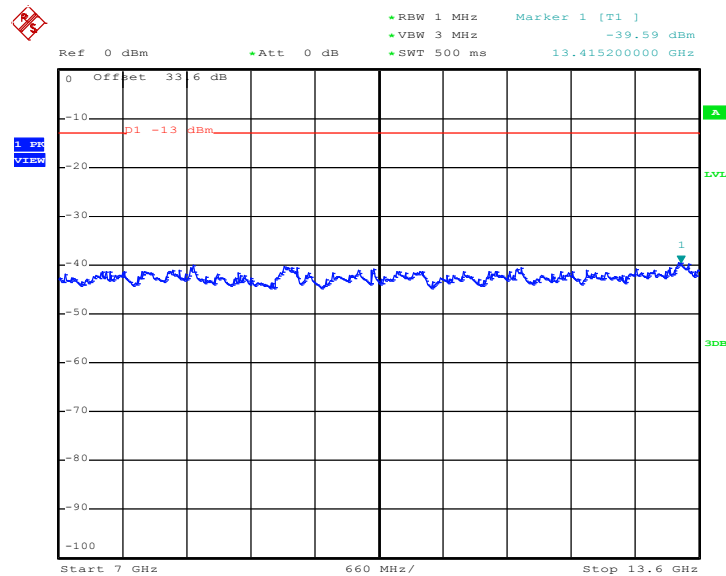

Date: 28.FEB.2013 01:16:09



Conducted Spurious Emission Plot between 13.6GHz ~ 19.1GHz

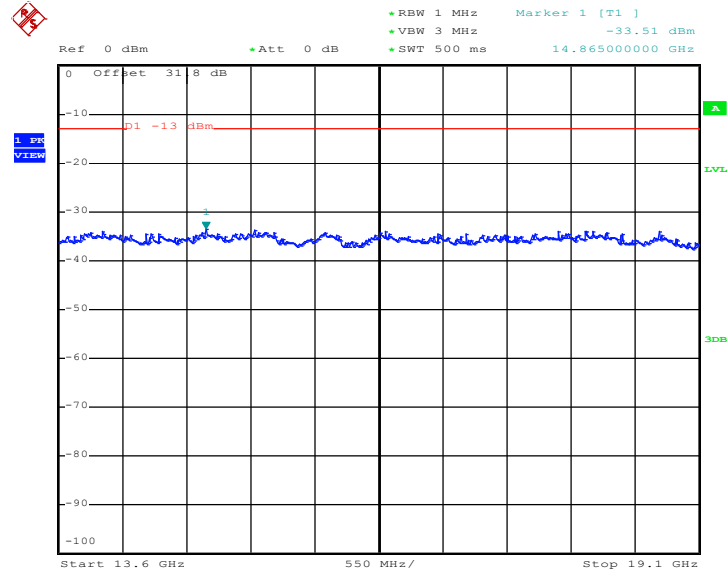

Date: 28.FEB.2013 01:16:21



Band :	GSM1900	Channel :	CH661
Test Mode :	EDGE class 8 Link (8PSK)	Frequency :	1880.0 MHz

Conducted Spurious Emission Plot between 30MHz ~ 1GHz

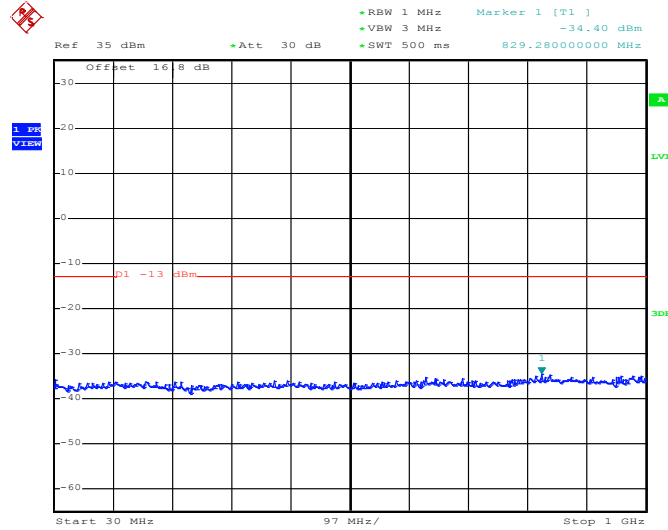

Date: 27.FEB.2013 23:52:12

Conducted Spurious Emission Plot between 1GHz ~ 3GHz

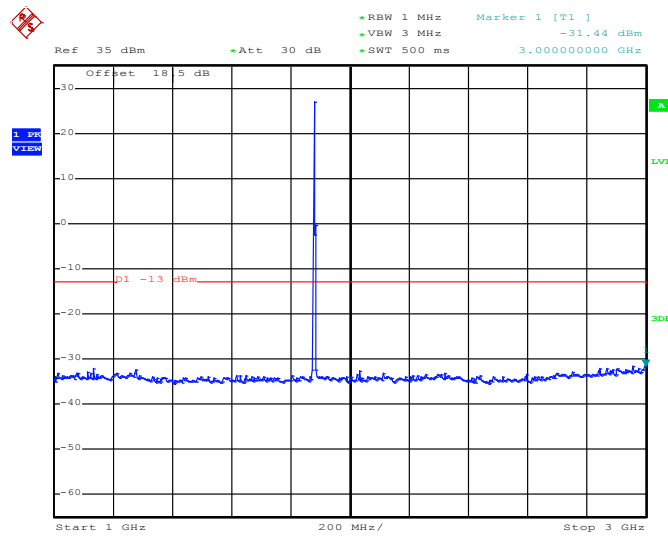

Date: 27.FEB.2013 23:52:25



Conducted Spurious Emission Plot between 3GHz ~ 7GHz

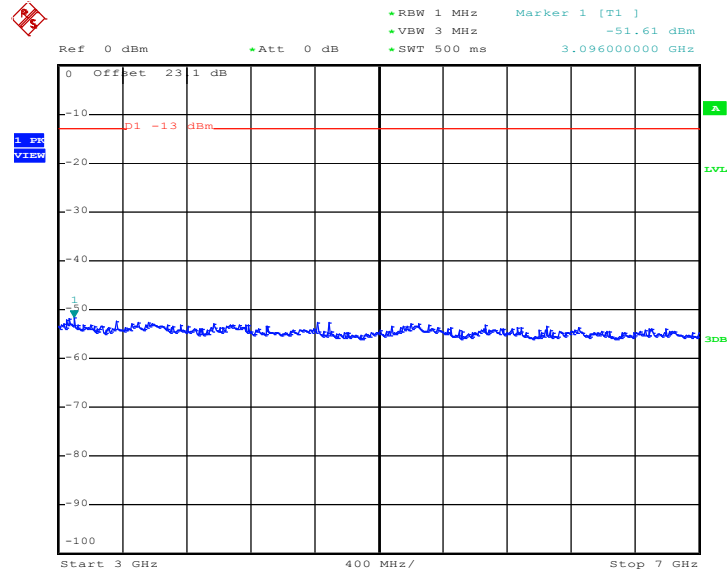

Date: 27.FEB.2013 23:52:41

Conducted Spurious Emission Plot between 7GHz ~ 13.6GHz

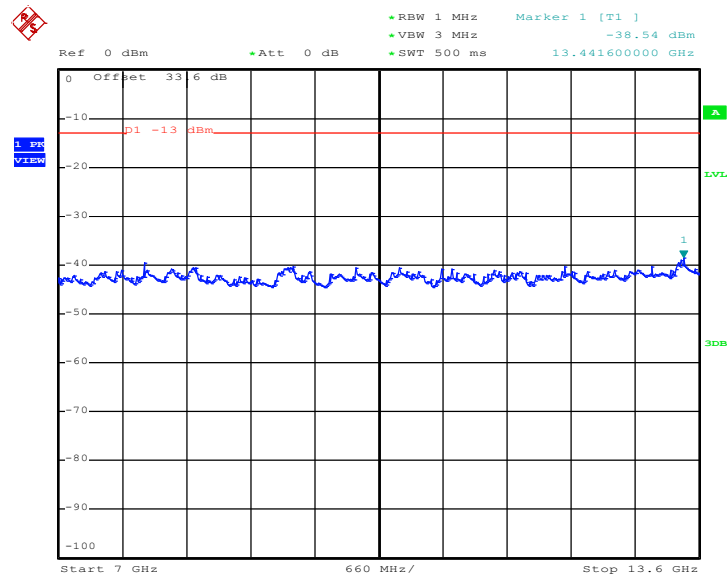

Date: 27.FEB.2013 23:52:54



Conducted Spurious Emission Plot between 13.6GHz ~ 19.1GHz

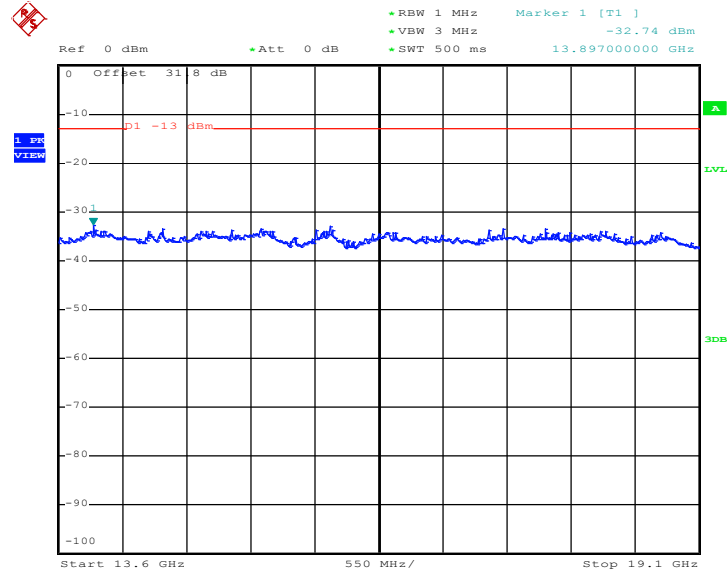

Date: 27.FEB.2013 23:53:06



Band :	WCDMA Band V	Channel :	CH4182
Test Mode :	RMC 12.2Kbps Link (QPSK)	Frequency :	836.4 MHz

Conducted Spurious Emission Plot between 30MHz ~ 1GHz

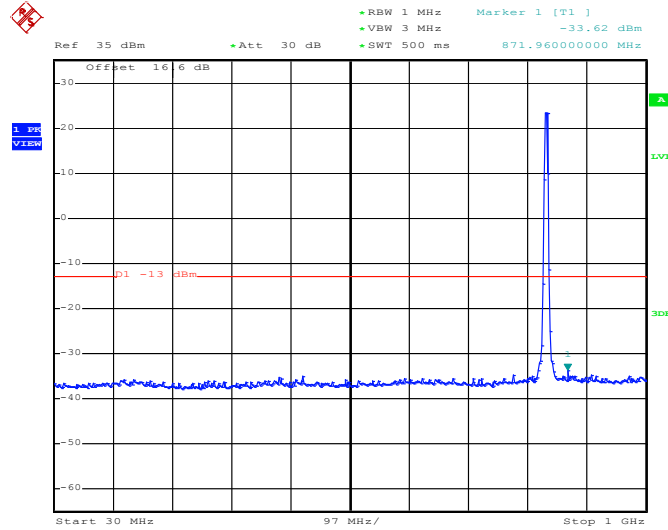

Date: 28.FEB.2013 02:20:26

Conducted Spurious Emission Plot between 1GHz ~ 3GHz

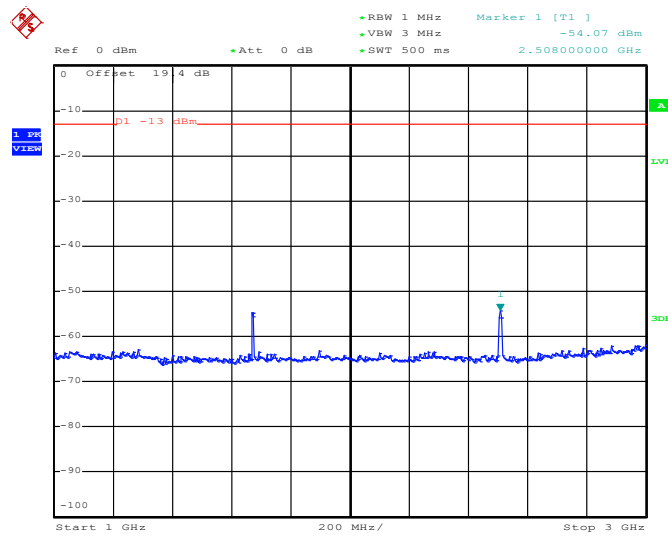

Date: 28.FEB.2013 02:11:57



Conducted Spurious Emission Plot between 3GHz ~ 7GHz

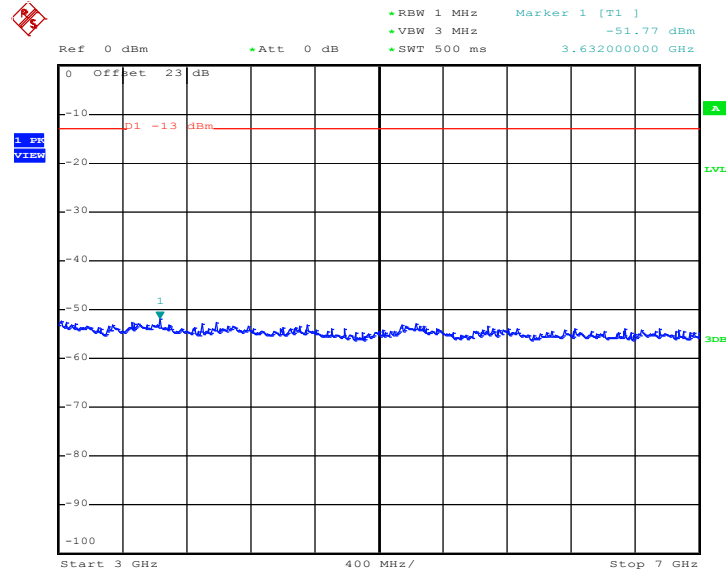

Date: 28.FEB.2013 02:12:10

Conducted Spurious Emission Plot between 7GHz ~ 9GHz

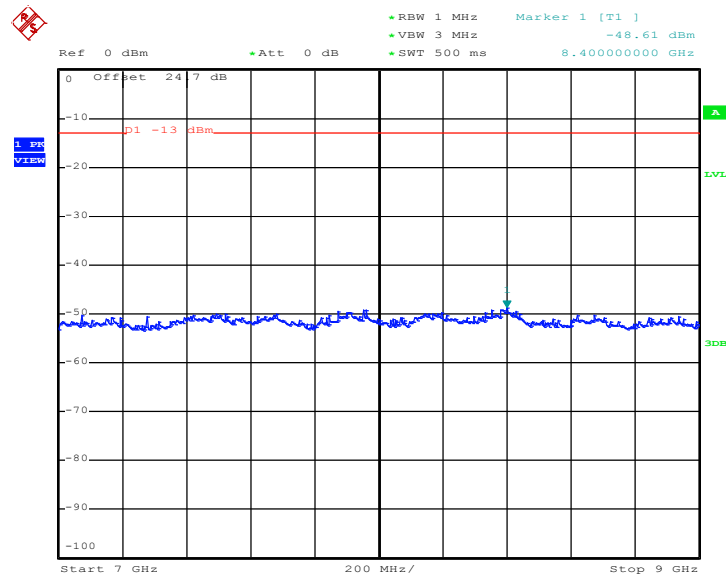

Date: 28.FEB.2013 02:12:22



Band :	WCDMA Band IV	Channel :	CH1413
Test Mode :	RMC 12.2Kbps Link (QPSK)	Frequency :	1732.6 MHz

Conducted Spurious Emission Plot between 30MHz ~ 1GHz

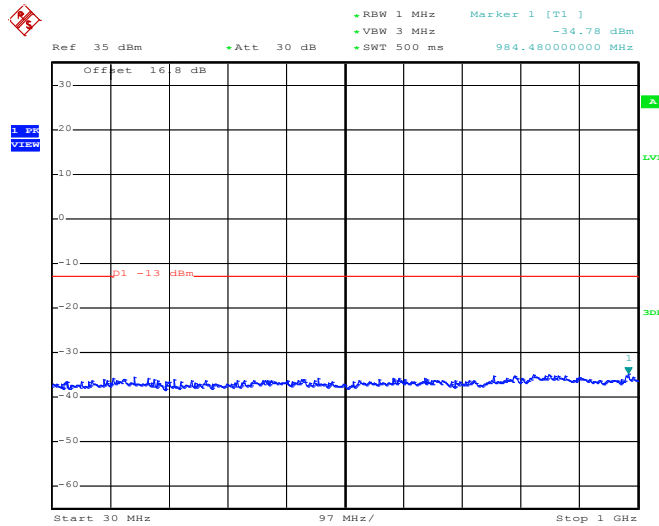

Date: 28.FEB.2013 21:20:18

Conducted Spurious Emission Plot between 1GHz ~ 3GHz

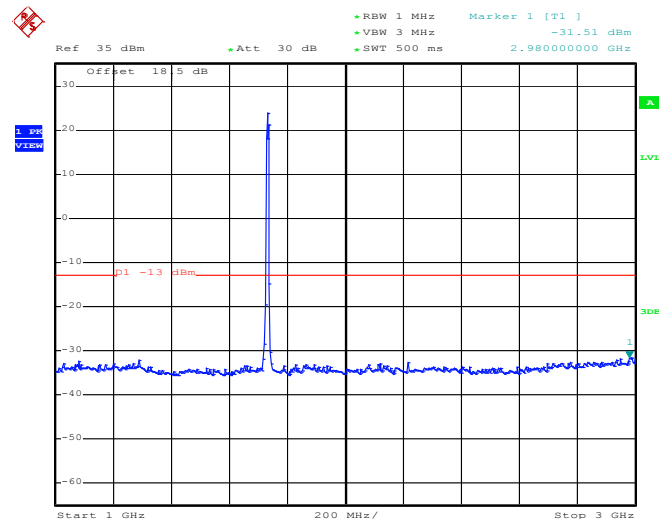

Date: 28.FEB.2013 21:20:30



Conducted Spurious Emission Plot between 3GHz ~ 7GHz

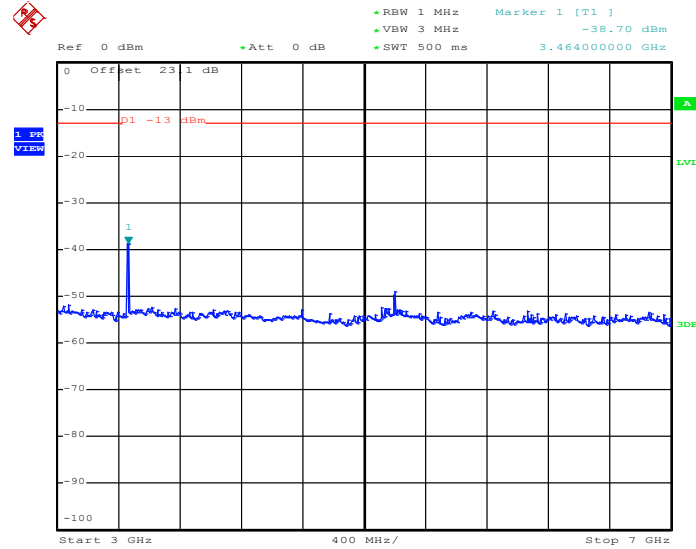

Date: 28.FEB.2013 21:20:48

Conducted Spurious Emission Plot between 7GHz ~ 13.6GHz

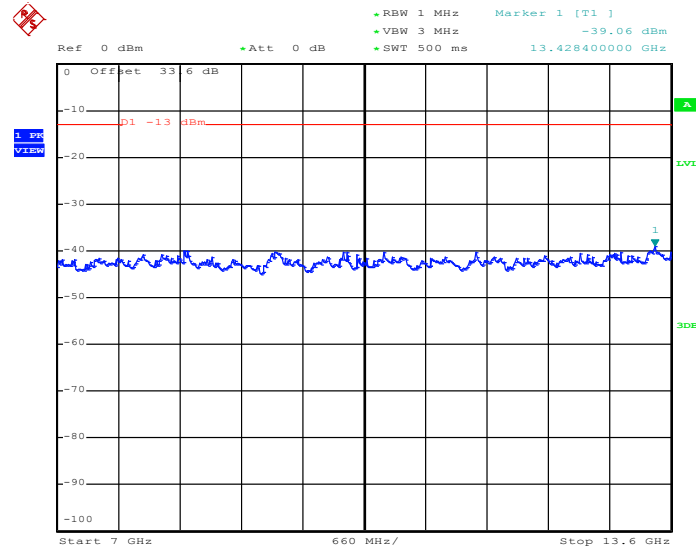

Date: 28.FEB.2013 21:21:00



Conducted Spurious Emission Plot between 13.6GHz ~ 18GHz

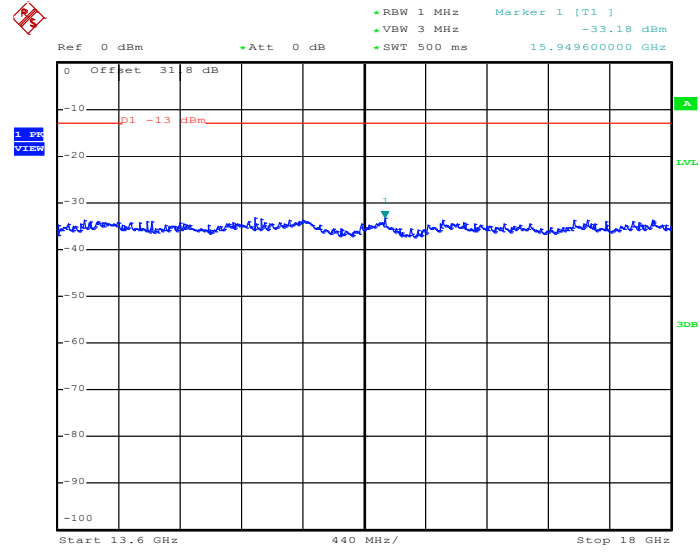

Date: 28.FEB.2013 21:21:12



Band :	WCDMA Band II	Channel :	CH9400
Test Mode :	RMC 12.2Kbps Link (QPSK)	Frequency :	1880.0 MHz

Conducted Spurious Emission Plot between 30MHz ~ 1GHz

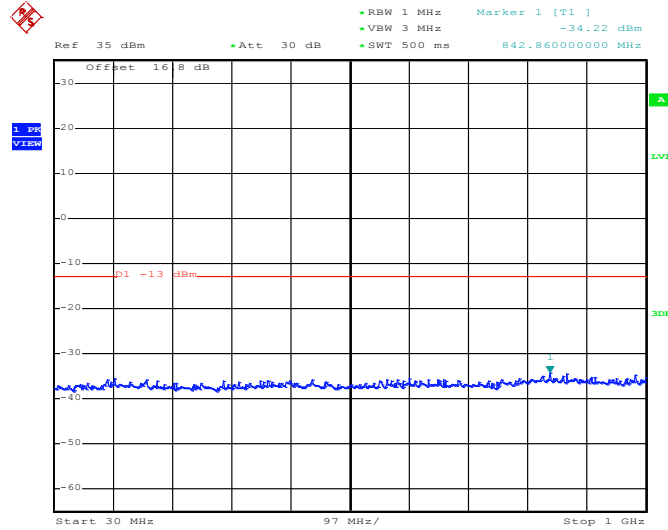

Date: 28.FEB.2013 01:50:23

Conducted Spurious Emission Plot between 1GHz ~ 3GHz

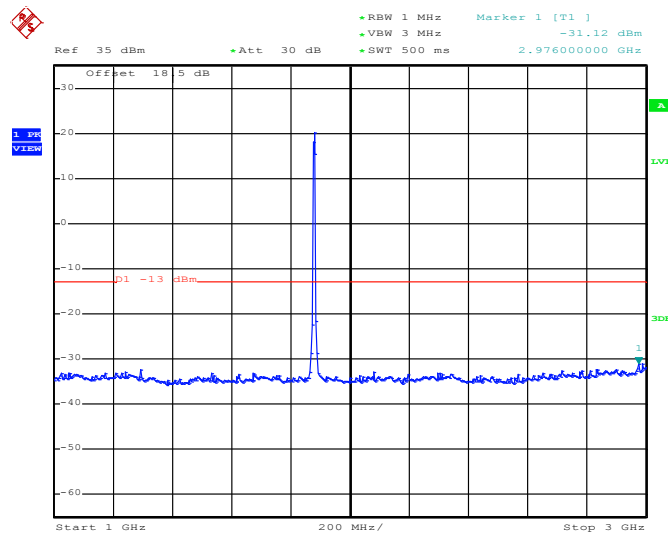

Date: 28.FEB.2013 01:50:35



Conducted Spurious Emission Plot between 3GHz ~ 7GHz

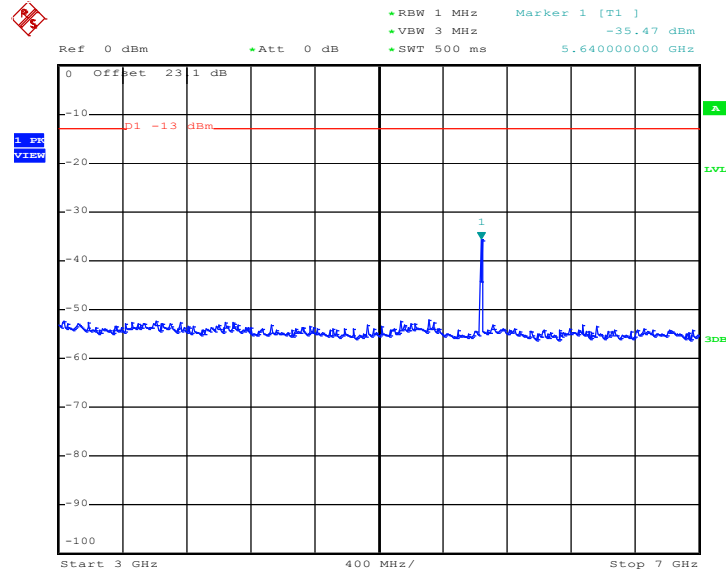

Date: 28.FEB.2013 01:50:51

Conducted Spurious Emission Plot between 7GHz ~ 13.6GHz

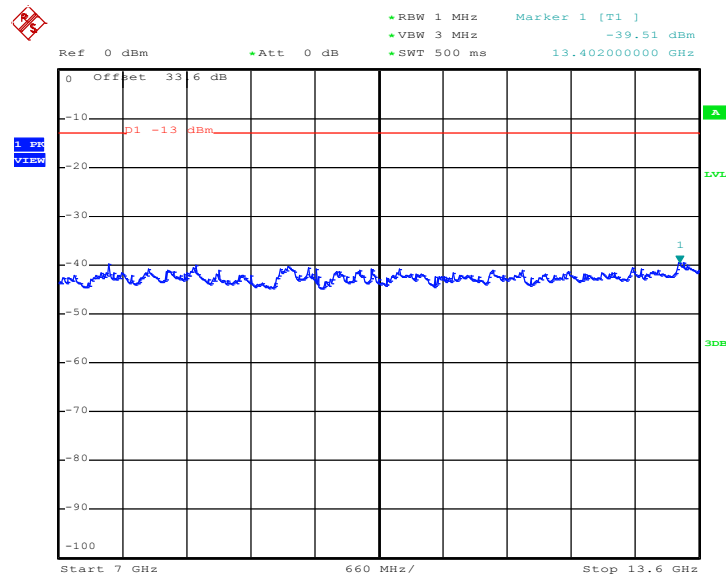

Date: 28.FEB.2013 01:51:04



Conducted Spurious Emission Plot between 13.6GHz ~ 19.1GHz

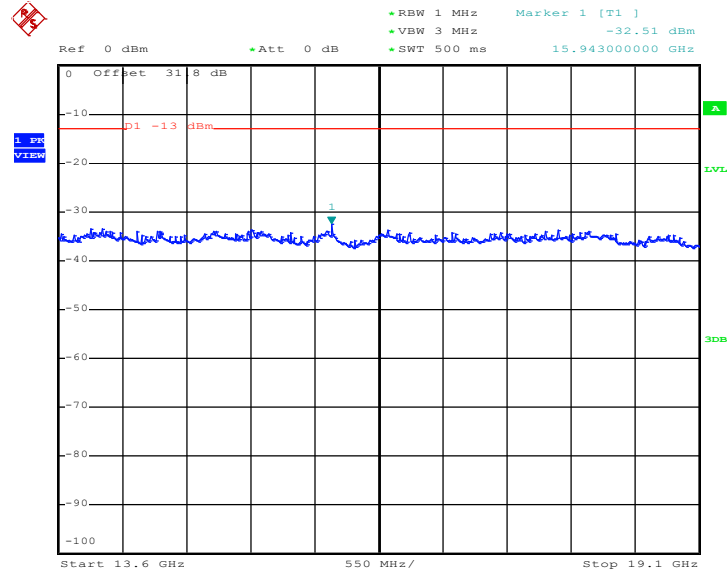

Date: 28.FEB.2013 01:51:16

3.6 Field Strength of Spurious Radiation Measurement

3.6.1 Description of Field Strength of Spurious Radiated Measurement

The power of any emission outside of the authorized operating frequency ranges must be attenuated below the transmitter power (P) by a factor of at least $43 + 10 \log(P)$ dB. The spectrum is scanned from 30 MHz up to a frequency including its 10th harmonic.

3.6.2 Measuring Instruments

See list of measuring instruments of this test report.

3.6.3 Test Procedures

1. The EUT was placed on a rotatable wooden table with 0.8 meter above ground.
2. The EUT was set 3 meters from the receiving antenna, which was mounted on the antenna tower.
3. The table was rotated 360 degrees to determine the position of the highest spurious emission.
4. The height of the receiving antenna is varied between one meter and four meters to search the maximum spurious emission for both horizontal and vertical polarizations.
5. Make the measurement with the spectrum analyzer's RBW = 1MHz, VBW = 3MHz, taking the record of maximum spurious emission.
6. A horn antenna was substituted in place of the EUT and was driven by a signal generator.
7. Tune the output power of signal generator to the same emission level with EUT maximum spurious emission.
8. Taking the record of output power at antenna port.
9. Repeat step 7 to step 8 for another polarization.
10. The RF fundamental frequency should be excluded against the limit line in the operating frequency band.
11. The limit line is derived from $43 + 10\log(P)$ dB below the transmitter power P(Watts)
 $= P(W) - [43 + 10\log(P)]$ (dB)
 $= [30 + 10\log(P)]$ (dBm) - $[43 + 10\log(P)]$ (dB)
 $= -13\text{dBm}$.
12. $\text{EIRP (dBm)} = \text{S.G. Power} - \text{Tx Cable Loss} + \text{Tx Antenna Gain}$
13. $\text{ERP (dBm)} = \text{EIRP} - 2.15$

3.6.4 Test Setup

For radiated emissions below 30MHz

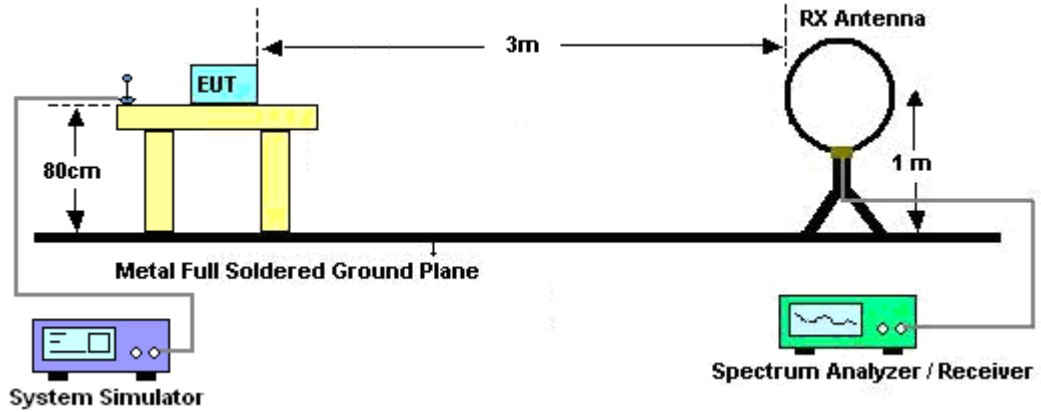

For radiated emissions from 30MHz to 1GHz

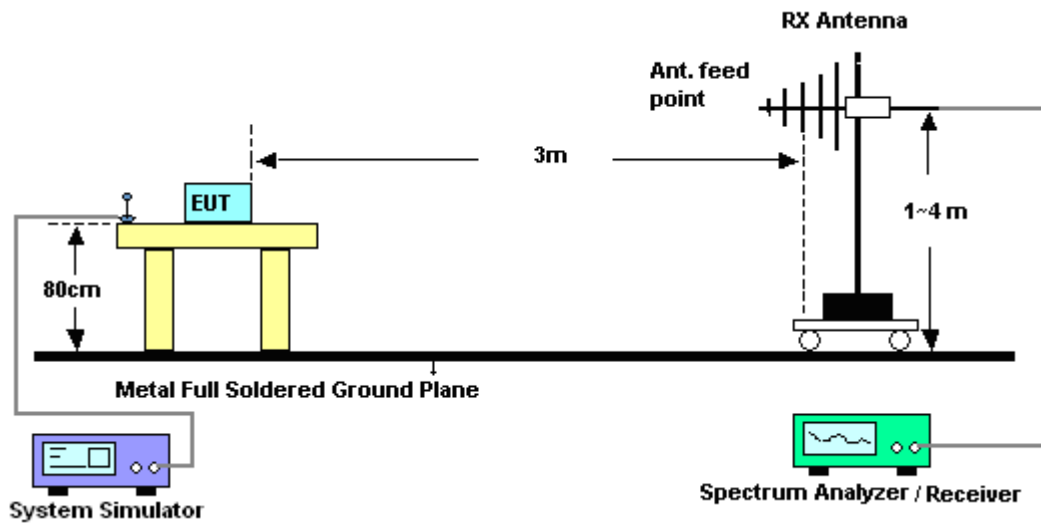

For radiated emissions above 1GHz

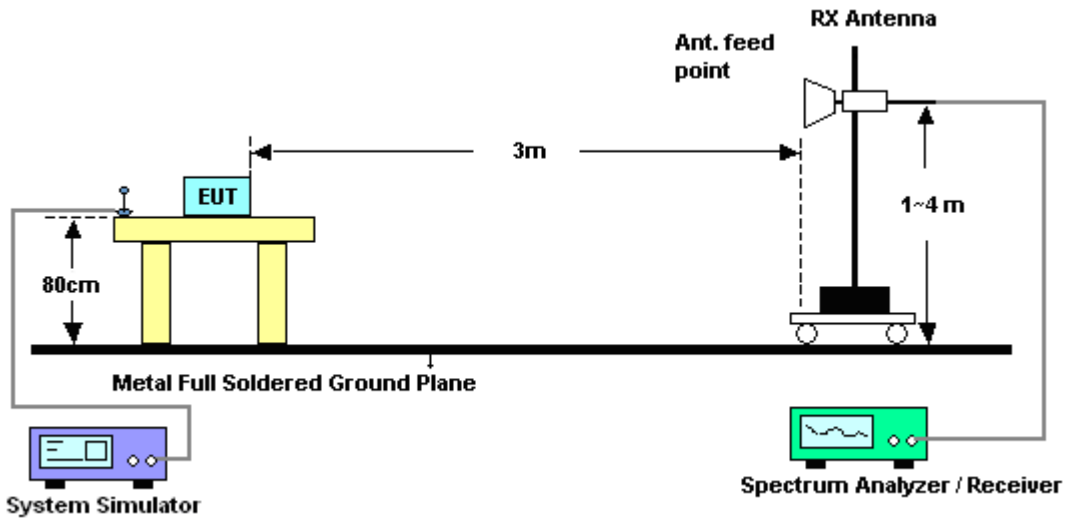

3.6.5 Test Results of Radiated Emissions (9 KHz ~ 30 MHz)

The low frequency, which started from 9 KHz to 30MHz, was pre-scanned and the result which was 20dB lower than the limit line was not reported.



3.6.6 Test Result of Field Strength of Spurious Radiated

Band :	GSM850	Temperature :	21~24°C
Test Mode :	GPRS class 8 Link (GMSK)	Relative Humidity :	51~53%
Test Engineer :	Bear Chang and Marlboro Hsu	Polarization :	Horizontal
Remark :	Spurious emissions within 30-1000MHz were found more than 20dB below limit line.		

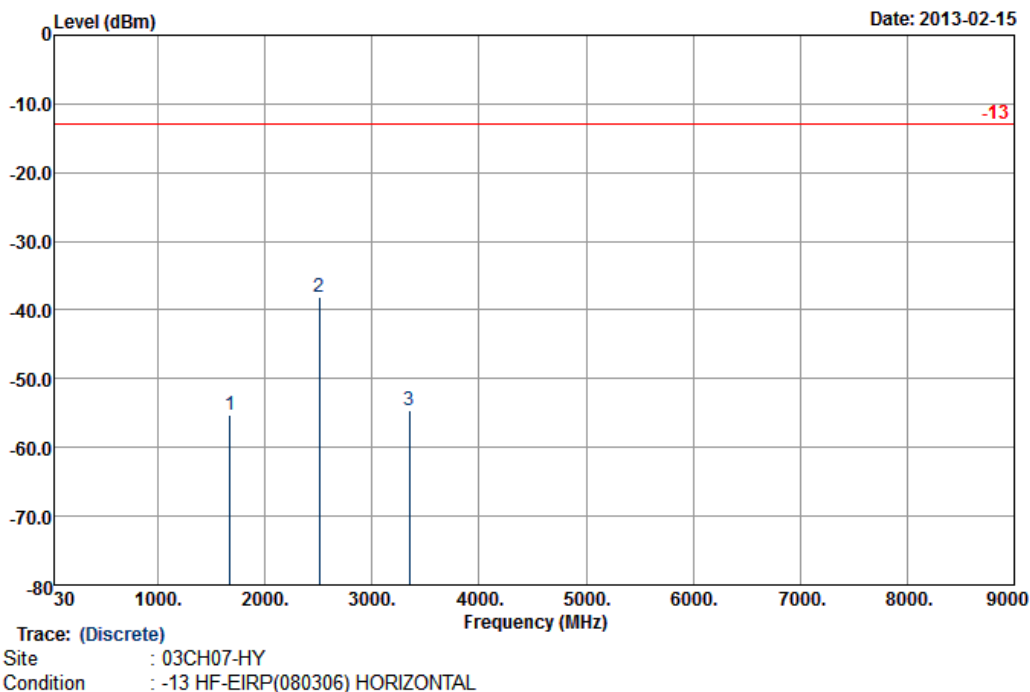

Frequency (MHz)	ERP (dBm)	Limit (dBm)	Over Limit (dB)	SPA Reading (dBm)	S.G. Power (dBm)	TX Cable loss (dB)	TX Antenna Gain (dBi)	Polarization (H/V)	Result
1672	-55.34	-13	-42.34	-64.24	-57.06	1.62	5.49	H	Pass
2509	-38.00	-13	-25.00	-51.31	-39.97	2.1	6.22	H	Pass
3346	-54.53	-13	-41.53	-68.68	-57.42	3.03	8.07	H	Pass



Band :	GSM850	Temperature :	21~24°C
Test Mode :	GPRS class 8 Link (GMSK)	Relative Humidity :	51~53%
Test Engineer :	Bear Chang and Marlboro Hsu	Polarization :	Vertical
Remark :	Spurious emissions within 30-1000MHz were found more than 20dB below limit line.		

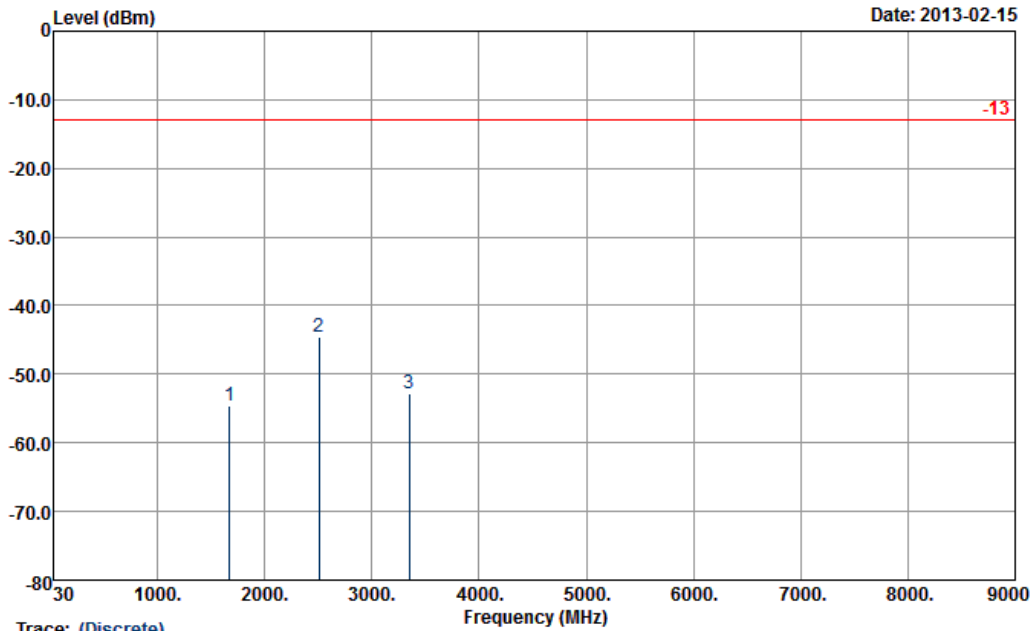

Trace: (Discrete)
 Site : 03CH07-HY
 Condition : -13 HF-EIRP(080306) VERTICAL

Frequency (MHz)	ERP (dBm)	Limit (dBm)	Over Limit (dB)	SPA Reading (dBm)	S.G. Power (dBm)	TX Cable loss (dB)	TX Antenna Gain (dBi)	Polarization (H/V)	Result
1672	-54.67	-13	-41.67	-65.8	-56.39	1.62	5.49	V	Pass
2509	-44.66	-13	-31.66	-58.37	-46.63	2.1	6.22	V	Pass
3346	-52.82	-13	-39.82	-68.39	-55.71	3.03	8.07	V	Pass



Band :	GSM850	Temperature :	21~24°C
Test Mode :	EDGE class 10 Link (8PSK)	Relative Humidity :	51~53%
Test Engineer :	Bear Chang and Marlboro Hsu	Polarization :	Horizontal
Remark :	Spurious emissions within 30-1000MHz were found more than 20dB below limit line.		

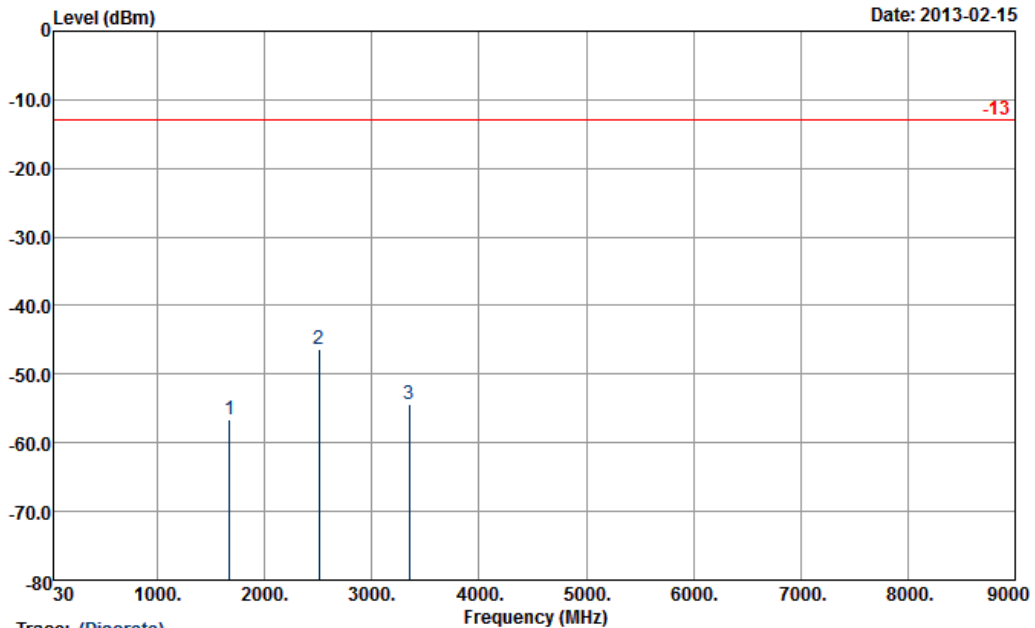

Trace: (Discrete)
 Site : 03CH07-HY
 Condition : -13 HF-EIRP(080306) HORIZONTAL

Frequency (MHz)	ERP (dBm)	Limit (dBm)	Over Limit (dB)	SPA Reading (dBm)	S.G. Power (dBm)	TX Cable loss (dB)	TX Antenna Gain (dBi)	Polarization (H/V)	Result
1672	-56.50	-13	-43.50	-65.43	-58.22	1.62	5.49	H	Pass
2509	-46.44	-13	-33.44	-59.73	-48.41	2.1	6.22	H	Pass
3346	-54.47	-13	-41.47	-68.56	-57.36	3.03	8.07	H	Pass



Band :	GSM850	Temperature :	21~24°C
Test Mode :	EDGE class 10 Link (8PSK)	Relative Humidity :	51~53%
Test Engineer :	Bear Chang and Marlboro Hsu	Polarization :	Vertical
Remark :	Spurious emissions within 30-1000MHz were found more than 20dB below limit line.		

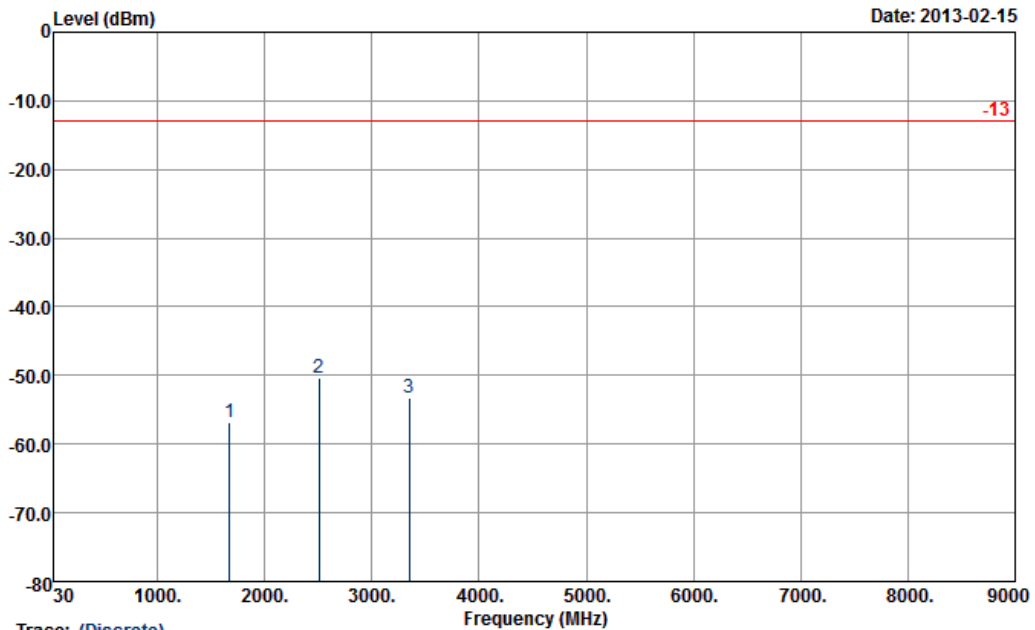

Trace: (Discrete)
 Site : 03CH07-HY
 Condition : -13 HF-EIRP(080306) VERTICAL

Frequency (MHz)	ERP (dBm)	Limit (dBm)	Over Limit (dB)	SPA Reading (dBm)	S.G. Power (dBm)	TX Cable loss (dB)	TX Antenna Gain (dBi)	Polarization (H/V)	Result
1672	-56.87	-13	-43.87	-68.05	-58.59	1.62	5.49	V	Pass
2509	-50.37	-13	-37.37	-64.09	-52.34	2.1	6.22	V	Pass
3346	-53.22	-13	-40.22	-68.82	-56.11	3.03	8.07	V	Pass



Band :	GSM1900	Temperature :	21~24°C
Test Mode :	GPRS class 8 Link (GMSK)	Relative Humidity :	51~53%
Test Engineer :	Bear Chang and Marlboro Hsu	Polarization :	Horizontal
Remark :	Spurious emissions within 30-1000MHz were found more than 20dB below limit line.		

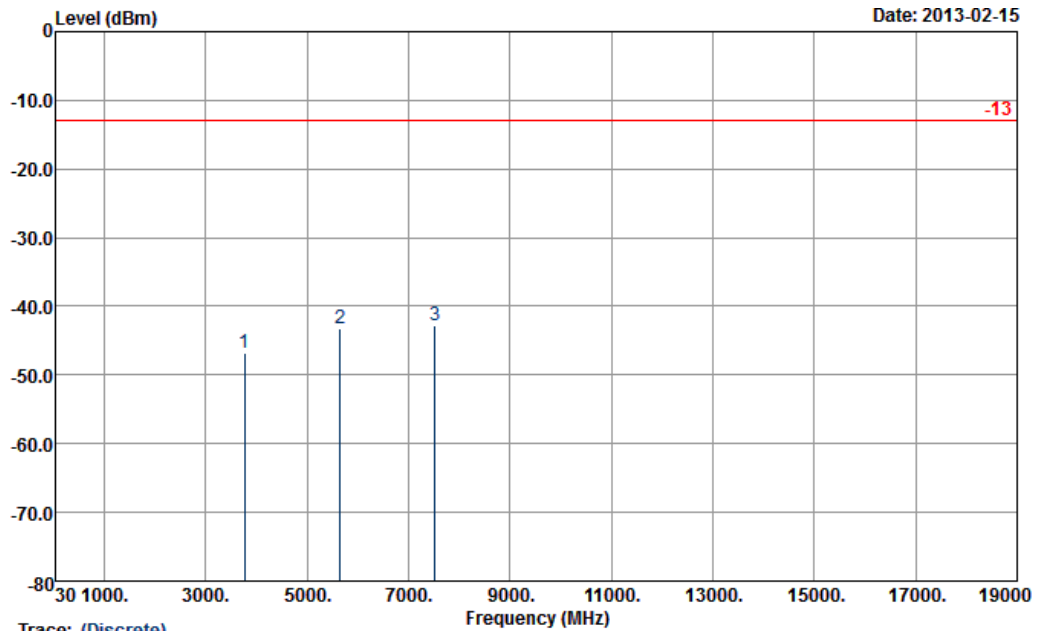

Trace: (Discrete)
 Site : 03CH07-HY
 Condition : -13 HF-EIRP(080306) HORIZONTAL

Frequency (MHz)	EIRP (dBm)	Limit (dBm)	Over Limit (dB)	SPA Reading (dBm)	S.G. Power (dBm)	TX Cable loss (dB)	TX Antenna Gain (dBi)	Polarization (H/V)	Result
3760	-46.70	-13	-33.70	-62.23	-53	2.51	8.81	H	Pass
5640	-43.29	-13	-30.29	-63.34	-51	2.99	10.70	H	Pass
7520	-42.77	-13	-29.77	-69.8	-51.3	3.59	12.12	H	Pass



Band :	GSM1900	Temperature :	21~24°C
Test Mode :	GPRS class 8 Link (GMSK)	Relative Humidity :	51~53%
Test Engineer :	Bear Chang and Marlboro Hsu	Polarization :	Vertical
Remark :	Spurious emissions within 30-1000MHz were found more than 20dB below limit line.		

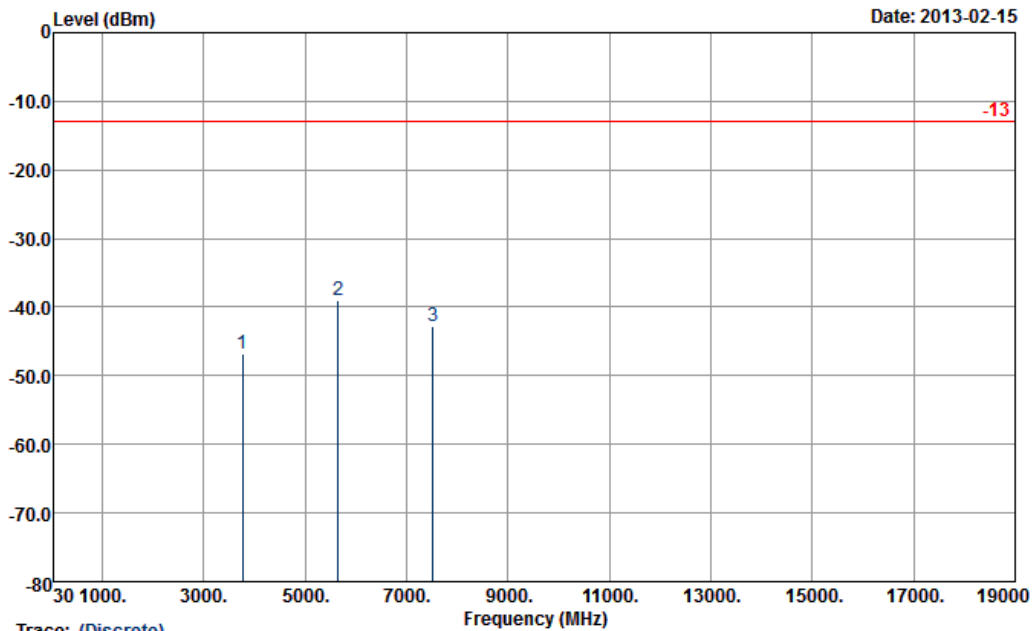

Trace: (Discrete)
 Site : 03CH07-HY
 Condition : -13 HF-EIRP(080306) VERTICAL

Frequency (MHz)	EIRP (dBm)	Limit (dBm)	Over Limit (dB)	SPA Reading (dBm)	S.G. Power (dBm)	TX Cable loss (dB)	TX Antenna Gain (dBi)	Polarization (H/V)	Result
3760	-46.80	-13	-33.80	-62.57	-53.1	2.51	8.81	V	Pass
5640	-38.99	-13	-25.99	-59.1	-46.7	2.99	10.70	V	Pass
7520	-42.87	-13	-29.87	-69.18	-51.4	3.59	12.12	V	Pass



Band :	GSM1900	Temperature :	21~24°C
Test Mode :	EDGE class 8 Link (8PSK)	Relative Humidity :	51~53%
Test Engineer :	Bear Chang and Marlboro Hsu	Polarization :	Horizontal
Remark :	Spurious emissions within 30-1000MHz were found more than 20dB below limit line.		

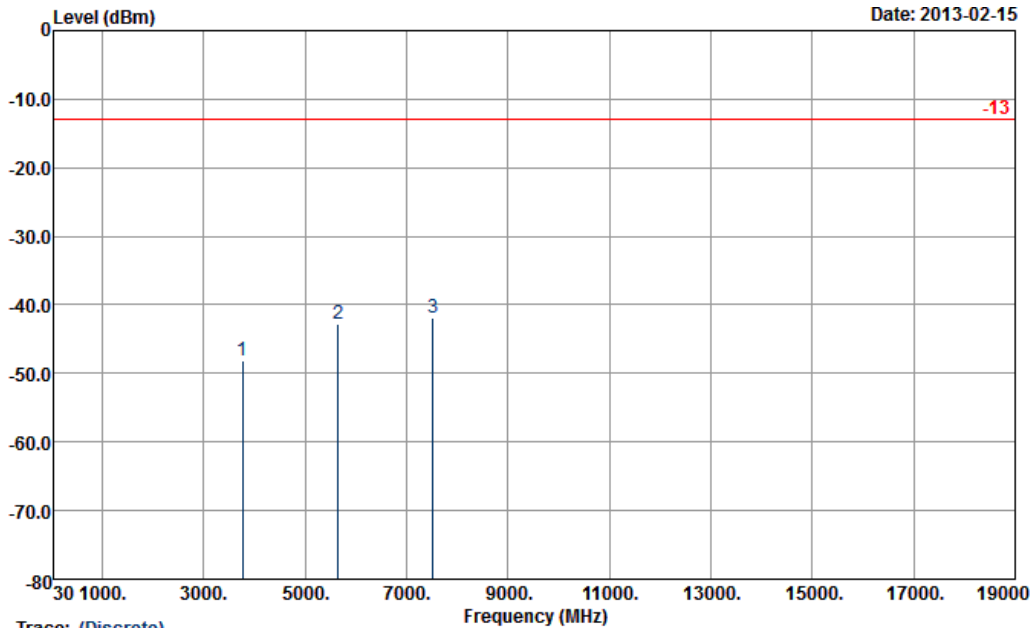

Trace: (Discrete)
 Site : 03CH07-HY
 Condition : -13 HF-EIRP(080306) HORIZONTAL

Frequency (MHz)	EIRP (dBm)	Limit (dBm)	Over Limit (dB)	SPA Reading (dBm)	S.G. Power (dBm)	TX Cable loss (dB)	TX Antenna Gain (dBi)	Polarization (H/V)	Result
3760	-48.07	-13	-35.07	-63.38	-54.37	2.51	8.81	H	Pass
5640	-42.71	-13	-29.71	-63.47	-50.42	2.99	10.70	H	Pass
7520	-41.90	-13	-28.90	-69.16	-50.43	3.59	12.12	H	Pass



Band :	GSM1900	Temperature :	21~24°C
Test Mode :	EDGE class 8 Link (8PSK)	Relative Humidity :	51~53%
Test Engineer :	Bear Chang and Marlboro Hsu	Polarization :	Vertical
Remark :	Spurious emissions within 30-1000MHz were found more than 20dB below limit line.		

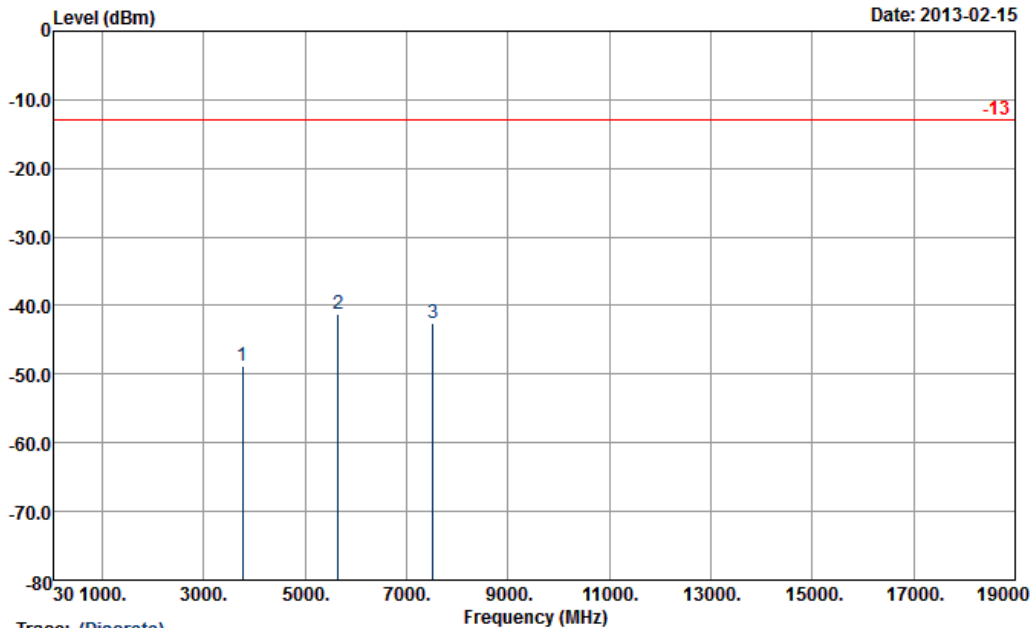

Trace: (Discrete)
 Site : 03CH07-HY
 Condition : -13 HF-EIRP(080306) VERTICAL

Frequency (MHz)	EIRP (dBm)	Limit (dBm)	Over Limit (dB)	SPA Reading (dBm)	S.G. Power (dBm)	TX Cable loss (dB)	TX Antenna Gain (dBi)	Polarization (H/V)	Result
3760	-48.70	-13	-35.70	-65	-55	2.51	8.81	V	Pass
5640	-41.17	-13	-28.17	-61.72	-48.88	2.99	10.70	V	Pass
7520	-42.62	-13	-29.62	-69.68	-51.15	3.59	12.12	V	Pass



Band :	WCDMA Band V	Temperature :	21~24°C
Test Mode :	RMC 12.2Kbps Link (QPSK)	Relative Humidity :	51~53%
Test Engineer :	Bear Chang and Marlboro Hsu	Polarization :	Horizontal
Remark :	Spurious emissions within 30-1000MHz were found more than 20dB below limit line.		

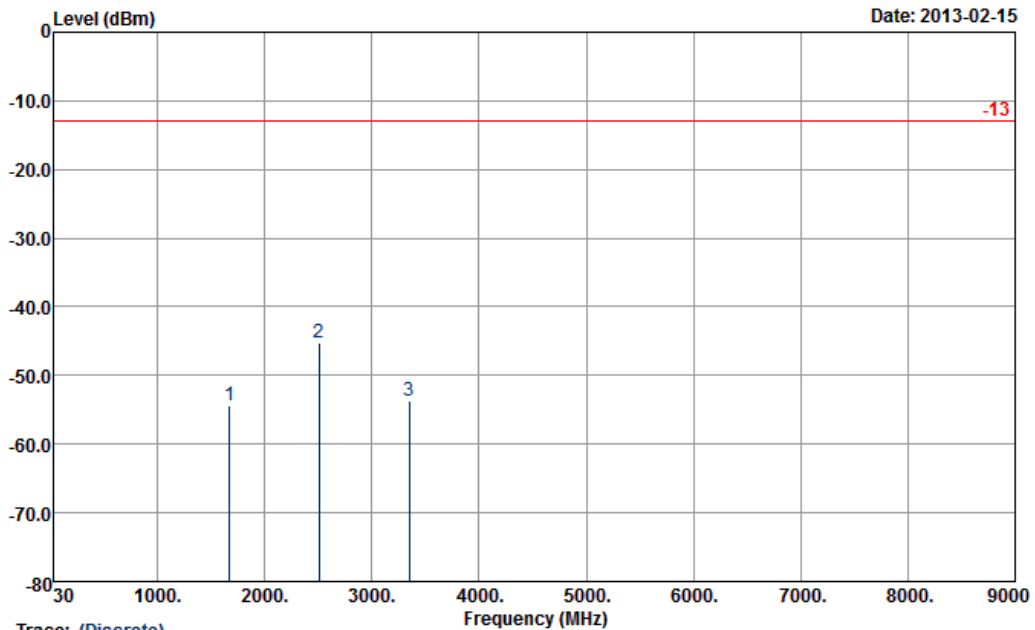

Trace: (Discrete)
 Site : 03CH07-HY
 Condition : -13 HF-EIRP(080306) HORIZONTAL

Frequency (MHz)	ERP (dBm)	Limit (dBm)	Over Limit (dB)	SPA Reading (dBm)	S.G. Power (dBm)	TX Cable loss (dB)	TX Antenna Gain (dBi)	Polarization (H/V)	Result
1675	-54.33	-13	-41.33	-63.25	-56.05	1.62	5.49	H	Pass
2506	-45.14	-13	-32.14	-58.41	-47.11	2.1	6.22	H	Pass
3346	-53.68	-13	-40.68	-67.75	-56.57	3.03	8.07	H	Pass



Band :	WCDMA Band V	Temperature :	21~24°C
Test Mode :	RMC 12.2Kbps Link (QPSK)	Relative Humidity :	51~53%
Test Engineer :	Bear Chang and Marlboro Hsu	Polarization :	Vertical
Remark :	Spurious emissions within 30-1000MHz were found more than 20dB below limit line.		

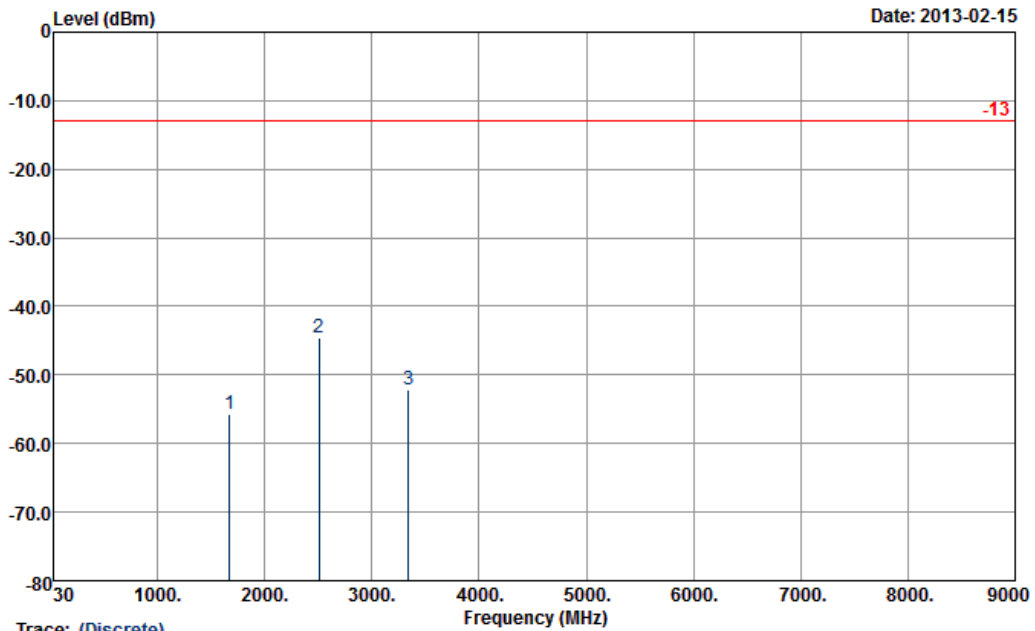

Trace: (Discrete)
 Site : 03CH07-HY
 Condition : -13 HF-EIRP(080306) VERTICAL

Frequency (MHz)	ERP (dBm)	Limit (dBm)	Over Limit (dB)	SPA Reading (dBm)	S.G. Power (dBm)	TX Cable loss (dB)	TX Antenna Gain (dBi)	Polarization (H/V)	Result
1672	-55.61	-13	-42.61	-66.78	-57.33	1.62	5.49	V	Pass
2506	-44.55	-13	-31.55	-58.32	-46.52	2.1	6.22	V	Pass
3345	-52.24	-13	-39.24	-67.81	-55.13	3.03	8.07	V	Pass



Band :	WCDMA Band IV	Temperature :	21~24°C
Test Mode :	RMC 12.2Kbps Link (QPSK)	Relative Humidity :	51~53%
Test Engineer :	Bear Chang and Marlboro Hsu	Polarization :	Horizontal
Remark :	Spurious emissions within 30-1000MHz were found more than 20dB below limit line.		

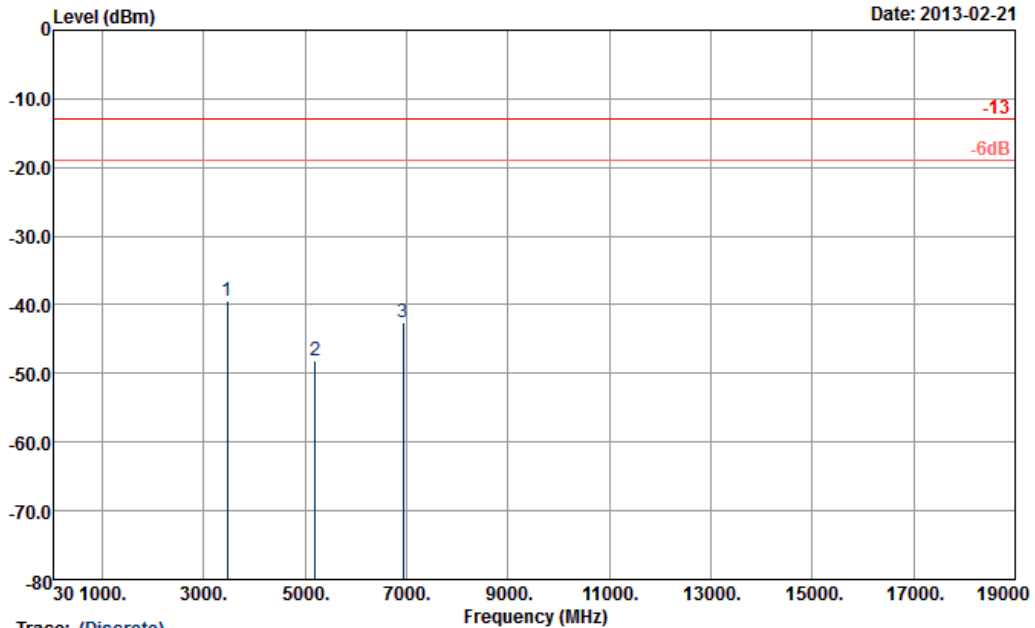

Trace: (Discrete)
 Site : 03CH07-HY
 Condition : -13 HF-EIRP(080306) HORIZONTAL

Frequency (MHz)	EIRP (dBm)	Limit (dBm)	Over Limit (dB)	SPA Reading (dBm)	S.G. Power (dBm)	TX Cable loss (dB)	TX Antenna Gain (dBi)	Polarization (H/V)	Result
3468	-39.42	-13	-26.42	-53.79	-43.25	4.48	8.31	H	Pass
5196	-48.15	-13	-35.15	-66.8	-52.79	5.332	9.98	H	Pass
6932	-42.60	-13	-29.60	-68.75	-47.84	6.1	11.34	H	Pass



Band :	WCDMA Band IV	Temperature :	21~24°C
Test Mode :	RMC 12.2Kbps Link (QPSK)	Relative Humidity :	51~53%
Test Engineer :	Bear Chang and Marlboro Hsu	Polarization :	Vertical
Remark :	Spurious emissions within 30-1000MHz were found more than 20dB below limit line.		

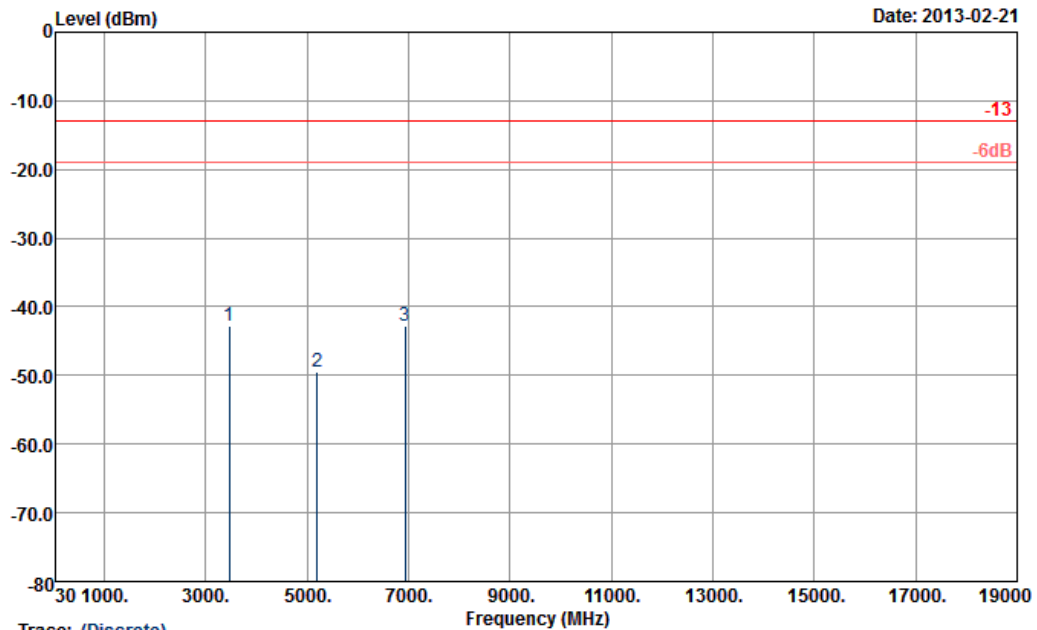

Trace: (Discrete)
 Site : 03CH07-HY
 Condition : -13 HF-EIRP(080306) VERTICAL

Frequency (MHz)	EIRP (dBm)	Limit (dBm)	Over Limit (dB)	SPA Reading (dBm)	S.G. Power (dBm)	TX Cable loss (dB)	TX Antenna Gain (dBi)	Polarization (H/V)	Result
3468	-42.88	-13	-29.88	-58.49	-46.71	4.48	8.31	V	Pass
5196	-49.49	-13	-36.49	-68.39	-54.13	5.332	9.98	V	Pass
6932	-42.85	-13	-29.85	-68.3	-48.09	6.1	11.34	V	Pass



Band :	WCDMA Band II	Temperature :	21~24°C
Test Mode :	RMC 12.2Kbps Link (QPSK)	Relative Humidity :	51~53%
Test Engineer :	Bear Chang and Marlboro Hsu	Polarization :	Horizontal
Remark :	Spurious emissions within 30-1000MHz were found more than 20dB below limit line.		

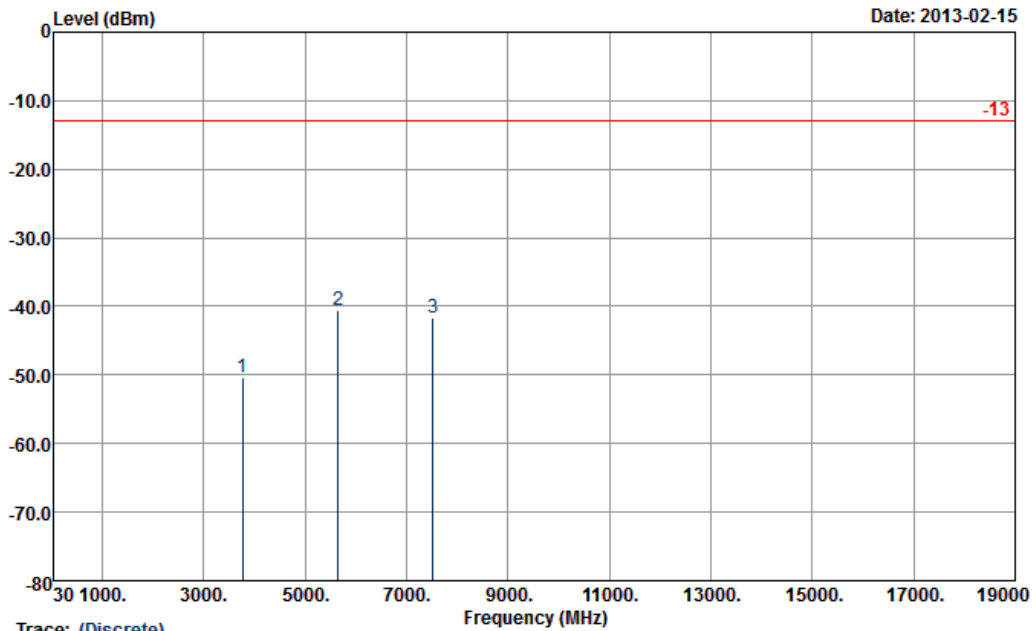

Site : 03CH07-HY
 Condition : -13 HF-EIRP(080306) HORIZONTAL

Frequency (MHz)	EIRP (dBm)	Limit (dBm)	Over Limit (dB)	SPA Reading (dBm)	S.G. Power (dBm)	TX Cable loss (dB)	TX Antenna Gain (dBi)	Polarization (H/V)	Result
3760	-50.34	-13	-37.34	-65.67	-56.64	2.51	8.81	H	Pass
5644	-40.60	-13	-27.60	-61.35	-48.31	2.99	10.70	H	Pass
7520	-41.74	-13	-28.74	-68.97	-50.27	3.59	12.12	H	Pass



Band :	WCDMA Band II	Temperature :	21~24°C
Test Mode :	RMC 12.2Kbps Link (QPSK)	Relative Humidity :	51~53%
Test Engineer :	Bear Chang and Marlboro Hsu	Polarization :	Vertical
Remark :	Spurious emissions within 30-1000MHz were found more than 20dB below limit line.		

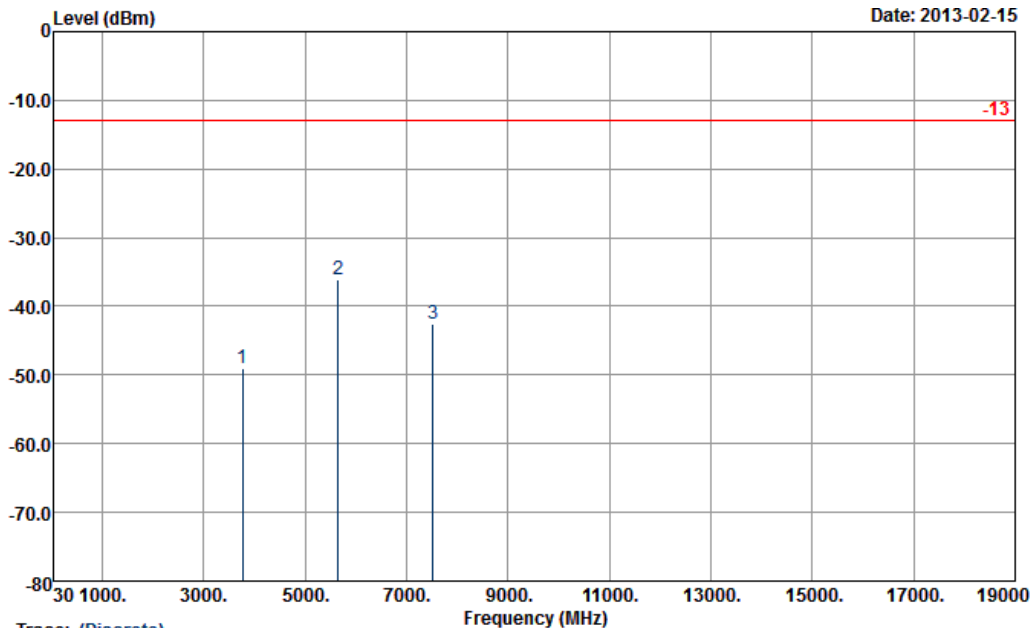

Trace: (Discrete)
 Site : 03CH07-HY
 Condition : -13 HF-EIRP(080306) VERTICAL

Frequency (MHz)	EIRP (dBm)	Limit (dBm)	Over Limit (dB)	SPA Reading (dBm)	S.G. Power (dBm)	TX Cable loss (dB)	TX Antenna Gain (dBi)	Polarization (H/V)	Result
3760	-48.92	-13	-35.92	-65.23	-55.22	2.51	8.81	V	Pass
5644	-36.04	-13	-23.04	-56.59	-43.75	2.99	10.70	V	Pass
7520	-42.66	-13	-29.66	-69.74	-51.19	3.59	12.12	V	Pass



3.7 Frequency Stability Measurement

3.7.1 Description of Frequency Stability Measurement

The frequency stability shall be measured by variation of ambient temperature and variation of primary supply voltage to ensure that the fundamental emission stays within the authorized frequency block. The frequency stability of the transmitter shall be maintained within $\pm 0.00025\%$ ($\pm 2.5\text{ppm}$) of the center frequency.

3.7.2 Measuring Instruments

See list of measuring instruments of this test report.

3.7.3 Test Procedures for Temperature Variation

1. The EUT was set up in the thermal chamber and connected with the base station.
2. With power OFF, the temperature was decreased to -30°C and the EUT was stabilized before testing. Power was applied and the maximum change in frequency was recorded within one minute.
3. With power OFF, the temperature was raised in 10°C step up to 50°C . The EUT was stabilized at each step for at least half an hour. Power was applied and the maximum frequency change was recorded within one minute.
4. If the EUT cannot be turned on at -30°C , the testing lowest temperature will be raised in 10°C step until the EUT can be turned on.

3.7.4 Test Procedures for Voltage Variation

1. The EUT was placed in a temperature chamber at $25\pm 5^{\circ}\text{C}$ and connected with the base station.
2. The power supply voltage to the EUT was varied from BEP to 115% of the nominal value measured at the input to the EUT.
3. The variation in frequency was measured for the worst case.

3.7.5 Test Setup

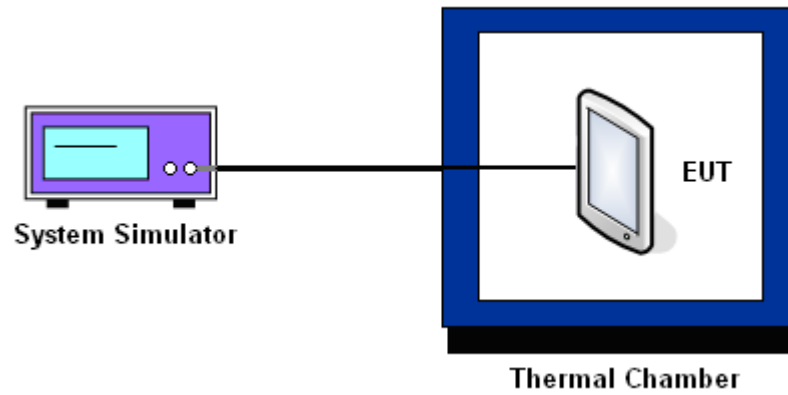

3.7.6 Test Result of Temperature Variation

Band :	GSM 850	Channel :	189
Limit (ppm) :	2.5	Frequency :	836.4 MHz

Temperature (°C)	GPRS class 8		EDGE class 10		Result
	Freq. Dev. (Hz)	Deviation (ppm)	Freq. Dev. (Hz)	Deviation (ppm)	
-30	8	0.01	-30	-0.04	PASS
-20	10	0.01	-31	-0.04	
-10	9	0.01	-31	-0.04	
0	12	0.01	-32	-0.04	
10	13	0.02	-35	-0.04	
20	12	0.01	-40	-0.05	
30	14	0.02	-38	-0.04	
40	15	0.02	-42	-0.05	
50	17	0.02	-45	-0.05	

Band :	GSM 1900	Channel :	661
Limit (ppm) :	2.5	Frequency :	1880.0 MHz

Temperature (°C)	GPRS class 8		EDGE class 8		Result
	Freq. Dev. (Hz)	Deviation (ppm)	Freq. Dev. (Hz)	Deviation (ppm)	
-30	17	0.01	28	0.01	PASS
-20	19	0.01	27	0.01	
-10	18	0.01	29	0.02	
0	20	0.01	28	0.01	
10	19	0.01	35	0.02	
20	20	0.01	34	0.02	
30	21	0.01	38	0.02	
40	24	0.01	42	0.02	
50	28	0.01	43	0.02	



Band :	WCDMA Band V	Channel :	4182
Limit (ppm) :	2.5	Frequency :	836.4 MHz

Temperature (°C)	RMC 12.2Kbps		Result
	Freq. Dev. (Hz)	Deviation (ppm)	
-30	3	0.00	PASS
-20	4	0.00	
-10	-5	-0.01	
0	-4	0.00	
10	6	0.01	
20	-5	-0.01	
30	8	0.01	
40	-9	-0.01	
50	-12	-0.01	

Band :	WCDMA Band IV	Channel :	1413
Limit (ppm) :	2.5	Frequency :	1732.6 MHz

Temperature (°C)	RMC 12.2Kbps		Result
	Freq. Dev. (Hz)	Deviation (ppm)	
-30	7	0.00	PASS
-20	6	0.00	
-10	9	0.01	
0	10	0.01	
10	9	0.01	
20	12	0.01	
30	14	0.01	
40	13	0.01	
50	15	0.01	



Band :	WCDMA Band II	Channel :	9400
Limit (ppm) :	2.5	Frequency :	836.4 MHz

Temperature (°C)	RMC 12.2Kbps		Result
	Freq. Dev. (Hz)	Deviation (ppm)	
-30	-14	-0.01	PASS
-20	-16	-0.01	
-10	-15	-0.01	
0	-17	-0.01	
10	-18	-0.01	
20	-17	-0.01	
30	-18	-0.01	
40	-19	-0.01	
50	-21	-0.01	



3.7.7 Test Result of Voltage Variation

Band & Channel	Mode	Voltage (Volt)	Freq. Dev. (Hz)	Deviation (ppm)	Limit (ppm)	Result
GSM 850 CH189	GPRS class 8	12	13	0.02	2.5	PASS
		BEP	11	0.01		
		12.6	14	0.02		
	EDGE class 10	12	-31	-0.04		
		BEP	-30	-0.04		
		12.6	-34	-0.04		
GSM 1900 CH661	GPRS class 8	12	22	0.01		
		BEP	19	0.01		
		12.6	23	0.01		
	EDGE class 8	12	31	0.02		
		BEP	29	0.02		
		12.6	35	0.02		
WCDMA Band V CH4182	RMC 12.2Kbps	12	-6	-0.01		
		BEP	-5	-0.01		
		12.6	-8	-0.01		
WCDMA Band IV CH1413	RMC 12.2Kbps	12	7	0.00		
		BEP	6	0.00		
		12.6	8	0.00		
WCDMA Band II CH9400	RMC 12.2Kbps	12	-16	-0.01		
		BEP	-15	-0.01		
		12.6	-18	-0.01		

Note:

1. Normal Voltage = 12V.
2. Battery End Point (BEP) = 11.4 V.



4 List of Measuring Equipments

Instrument	Manufacturer	Model No.	Serial No.	Characteristics	Calibration Date	Test Date	Due Date	Remark
System Simulator	R&S	CMU200	117995	N/A	Jul. 30, 2012	Feb. 27, 2013 ~ Mar. 04, 2013	Jul. 29, 2013	Conducted (TH02-HY)
Spectrum Analyzer	R&S	FSP40	100055	9kHz~40GHz	Jun. 06, 2012	Feb. 27, 2013 ~ Mar. 04, 2013	Jun. 05, 2013	Conducted (TH02-HY)
Thermal Chamber	Ten Billion	TTH-D3SP	TBN-930701	N/A	Jul. 23, 2012	Feb. 27, 2013 ~ Mar. 04, 2013	Jul. 22, 2013	Conducted (TH02-HY)
Bilog Antenna	Schaffner	CBL6111C	2726	30MHz ~ 1GHz	Oct. 06, 2012	Feb. 15, 2013 ~ Feb. 21, 2013	Oct. 05, 2013	Radiation (03CH07-HY)
Spectrum Analyzer	Rohde & Schwarz	FSP30	101067	9KHz ~ 30GHz	Nov. 30, 2012	Feb. 15, 2013 ~ Feb. 21, 2013	Nov. 29, 2013	Radiation (03CH07-HY)
Double Ridge Horn Antenna	ESCO	3117	00075962	1GHz ~ 18GHz	Aug. 22, 2012	Feb. 15, 2013 ~ Feb. 21, 2013	Aug. 21, 2013	Radiation (03CH07-HY)
Preamplifier	Agilent	8449B	3008A02362	1GHz~ 26.5GHz	Dec. 01, 2012	Feb. 15, 2013 ~ Feb. 21, 2013	Nov. 30, 2013	Radiation (03CH07-HY)
Pre Amplifier	MITEQ	AMF-7D-00 101800-30-1	159088	1GHz ~ 18GHz	Mar. 10, 2012	Feb. 15, 2013 ~ Feb. 21, 2013	Mar. 09, 2013	Radiation (03CH07-HY)
Pre Amplifier	COM-POWER	PA-103A	161241	10-1000MHZ. 32dB.GAIN	Feb. 27, 2012	Feb. 15, 2013 ~ Feb. 21, 2013	Feb. 26, 2013	Radiation (03CH07-HY)
EMI Test Receiver	Rohde & Schwarz	ESCI 7	100724	9kHz~7GHz	Sep. 03, 2012	Feb. 15, 2013 ~ Feb. 21, 2013	Sep. 02, 2013	Radiation (03CH07-HY)
SHF-EHF Horn Antenna	SCHWARZBECK	BBHA 9170	BBHA9170251	15GHz ~ 40GHz	Sep. 28, 2012	Feb. 15, 2013 ~ Feb. 21, 2013	Sep. 27, 2013	Radiation (03CH07-HY)
Loop Antenna	R&S	HFH2-Z2	860004/001	9KHz ~ 30MHz	Jul. 03, 2012	Feb. 15, 2013 ~ Feb. 21, 2013	Jul. 02, 2013	Radiation (03CH07-HY)
System Simulator	R&S	CMU200	117997	N/A	Aug. 22, 2011	Feb. 15, 2013 ~ Feb. 21, 2013	Aug. 21, 2013	Radiation (03CH07-HY)



5 Uncertainty of Evaluation

Uncertainty of Radiated Emission Measurement (30 MHz ~ 1000 MHz)

Measuring Uncertainty for a Level of Confidence of 95% ($U = 2Uc(y)$)	2.54
---	------

Uncertainty of Radiated Emission Measurement (1 GHz ~ 40 GHz)

Measuring Uncertainty for a Level of Confidence of 95% ($U = 2Uc(y)$)	4.72
---	------



Appendix A. Photographs of EUT

Please refer to Sporton report number EP312810 as below.