

FCC Radio Test Report

FCC ID: T58WF2780FR

This report concerns (check one): Original Grant Class I Change Class II Change

Project No. : 1607C232
Equipment : AC1200 WIRELESS DUAL BAND GIGABIT FIBER ROUTER
Model Name : WF2780F
Applicant : NETIS SYSTEMS CO., LTD
Address : 4F&5F R&D Building, Oriental Cyberport, High-Tech Industrial Park, Nanshan, Shenzhen, China.

Date of Receipt : Jul. 22, 2016
Date of Test : Jul. 22, 2016 ~ Nov. 03, 2016
Issued Date : Nov. 04, 2016
Tested by : BTL Inc.

Testing Engineer : Shawn Xiao
(Shawn Xiao)

Technical Manager : David Mao
(David Mao)

Authorized Signatory : Steven Lu
(Steven Lu)

B T L I N C .

No.3, Jinshagang 1st Road, Shixia, Dalang Town, Dongguan, Guangdong, China.

TEL: +86-769-8318-3000 FAX: +86-769-8319-6000

Declaration

BTL represents to the client that testing is done in accordance with standard procedures as applicable and that test instruments used has been calibrated with standards traceable to international standard(s) and/or national standard(s).

BTL's reports apply only to the specific samples tested under conditions. It is manufacture's responsibility to ensure that additional production units of this model are manufactured with the identical electrical and mechanical components. **BTL** shall have no liability for any declarations, inferences or generalizations drawn by the client or others from **BTL** issued reports.

BTL's report must not be used by the client to claim product certification, approval, or endorsement by NVLAP, NIST, or any agency of the Federal Government.

This report is the confidential property of the client. As a mutual protection to the clients, the public and **BTL-self**, extracts from the test report shall not be reproduced except in full with **BTL's** authorized written approval.

BTL's laboratory quality assurance procedures are in compliance with the **ISO Guide 17025** requirements, and accredited by the conformity assessment authorities listed in this test report.

Limitation

For the use of the authority's logo is limited unless the Test Standard(s)/Scope(s)/Item(s) mentioned in this test report is (are) included in the conformity assessment authorities acceptance respective.

Table of Contents	Page
1 . CERTIFICATION	6
2 . SUMMARY OF TEST RESULTS	7
2.1 TEST FACILITY	8
2.2 MEASUREMENT UNCERTAINTY	8
3 . GENERAL INFORMATION	9
3.1 GENERAL DESCRIPTION OF EUT	9
3.2 DESCRIPTION OF TEST MODES	11
3.3 TABLE OF PARAMETERS OF TEST SOFTWARE SETTING	12
3.4 BLOCK DIAGRAM SHOWING THE CONFIGURATION OF SYSTEM TESTED	13
3.5 DESCRIPTION OF SUPPORT UNITS	13
4 . EMC EMISSION TEST	14
4.1 CONDUCTED EMISSION MEASUREMENT	14
4.1.1 POWER LINE CONDUCTED EMISSION	14
4.1.2 TEST PROCEDURE	14
4.1.3 DEVIATION FROM TEST STANDARD	14
4.1.4 TEST SETUP	15
4.1.5 EUT OPERATING CONDITIONS	15
4.1.6 EUT TEST CONDITIONS	15
4.1.7 TEST RESULTS	15
4.2 RADIATED EMISSION MEASUREMENT	16
4.2.1 RADIATED EMISSION LIMITS	16
4.2.2 TEST PROCEDURE	17
4.2.3 DEVIATION FROM TEST STANDARD	17
4.2.4 TEST SETUP	17
4.2.5 EUT OPERATING CONDITIONS	18
4.2.6 EUT TEST CONDITIONS	18
4.2.7 TEST RESULTS (9K TO 30MHz)	19
4.2.8 TEST RESULTS (BETWEEN 30 TO 1000 MHz)	19
4.2.9 TEST RESULTS (ABOVE 1000 MHz)	19
5 . 26dB SPECTRUM BANDWIDTH	20
5.1 APPLIED PROCEDURES / LIMIT	20
5.1.1 TEST PROCEDURE	20
5.1.2 DEVIATION FROM STANDARD	20
5.1.3 TEST SETUP	20
5.1.4 EUT OPERATION CONDITIONS	20
5.1.5 EUT TEST CONDITIONS	20
5.1.6 TEST RESULTS	20
6 . MAXIMUM CONDUCTED OUTPUT POWER	21

Table of Contents	Page
6.1 APPLIED PROCEDURES / LIMIT	21
6.1.1 TEST PROCEDURE	21
6.1.2 DEVIATION FROM STANDARD	21
6.1.3 TEST SETUP	21
6.1.4 EUT OPERATION CONDITIONS	22
6.1.5 EUT TEST CONDITIONS	22
6.1.6 TEST RESULTS	22
7 . POWER SPECTRAL DENSITY TEST	23
7.1 APPLIED PROCEDURES / LIMIT	23
8.1.1 TEST PROCEDURE	23
7.1.1 DEVIATION FROM STANDARD	24
7.1.2 TEST SETUP	24
7.1.3 EUT OPERATION CONDITIONS	24
7.1.4 EUT TEST CONDITIONS	24
7.1.5 TEST RESULTS	24
8 . FREQUENCY STABILITY MEASUREMENT	25
8.1 APPLIED PROCEDURES / LIMIT	25
8.1.1 TEST PROCEDURE	25
8.1.2 DEVIATION FROM STANDARD	25
8.1.3 TEST SETUP	26
8.1.4 EUT OPERATION CONDITIONS	26
8.1.5 EUT TEST CONDITIONS	26
8.1.6 TEST RESULTS	26
9 . MEASUREMENT INSTRUMENTS LIST	27
10 . EUT TEST PHOTOS	29
ATTACHMENT A - CONDUCTED EMISSION	33
ATTACHMENT B - RADIATED EMISSION (9KHZ TO 30MHZ)	36
ATTACHMENT C - RADIATED EMISSION (30MHZ TO 1000MHZ)	41
ATTACHMENT D - RADIATED EMISSION (ABOVE 1000MHZ)	54
ATTACHMENT E - BANDWIDTH	173
ATTACHMENT F - MAXIMUM OUTPUT POWER	196
ATTACHMENT H - POWER SPECTRAL DENSITY	209
ATTACHMENT H - FREQUENCY STABILITY	266

REPORT ISSUED HISTORY

Issued No.	Description	Issued Date
BTL-FCCP-2-1607C232	Original Issue.	Nov. 04, 2016

1. CERTIFICATION

Equipment : AC1200 WIRELESS DUAL BAND GIGABIT FIBER ROUTER
Brand Name : netis
Model Name : WF2780F
Applicant : NETIS SYSTEMS CO., LTD
Manufacturer : Shenzhen Netcore Industrial Ltd.
Address : 4F&5F R&D Building, Oriental Cyberport, High-Tech Industrial Park, Nanshan, Shenzhen, China.
Factory : Dongguan City Netcore Network Technology Co.,Ltd.
Address : No.10-1,Sankeng Road,Qinghutou,Tangxia Town,Dongguan City
Date of Test : Jul. 22, 2016 ~ Nov. 03, 2016
Test Sample : Engineering Sample
Standard(s) : FCC Part15, Subpart E(15.407) / ANSI C63.10-2013

The above equipment has been tested and found compliance with the requirement of the relative standards by BTL Inc.

The test data, data evaluation, and equipment configuration contained in our test report (Ref No. BTL-FCCP-2-1607C232) were obtained utilizing the test procedures, test instruments, test sites that has been accredited by the Authority of TAF according to the ISO-17025 quality assessment standard and technical standard(s).

Test results included in this report is only for the RLAN 5GHz UNII-1 & UNII-3 part.

2. SUMMARY OF TEST RESULTS

Test procedures according to the technical standard(s):

FCC Part15, Subpart E			
Standard(s) Section	Test Item	Judgment	Remark
15.207	AC Power Line Conducted Emissions	PASS	
15.407(a)	26dB Spectrum Bandwidth	PASS	
15.407(a)	Maximum Conducted Output Power	PASS	
15.407(a)	Power Spectral Density	PASS	
15.407(a)	Radiated Emissions	PASS	
15.407(b)	Band Edge Emissions	PASS	
15.407(g)	Frequency Stability	PASS	
15.203	Antenna Requirements	PASS	

NOTE:

(1) "N/A" denotes test is not applicable in this test report.

2.1 TEST FACILITY

The test facilities used to collect the test data in this report is at the location of No.3,Jinshagang 1st Road, Shixia, Dalang Town, Dongguan, Guangdong, China.

BTL's test firm number for FCC: 319330

2.2 MEASUREMENT UNCERTAINTY

Where relevant, the following measurement uncertainty levels have been estimated for tests performed on the EUT as specified in CISPR 16-4-2. The BTL measurement uncertainty is less than the CISPR 16-4-2 U_{CISPR} requirement.

The reported uncertainty of measurement $y \pm U$, where expanded uncertainty U is based on a standard uncertainty multiplied by a coverage factor of $k=2$, providing a level of confidence of approximately 95 %.

A. Conducted Measurement:

Test Site	Method	Measurement Frequency Range	U, (dB)
DG-C02	CISPR	150 KHz ~ 30MHz	1.94

B. Radiated Measurement:

Test Site	Method	Measurement Frequency Range	Ant. H / V	U, (dB)
DG-CB03	CISPR	9kHz~30MHz	V	3.79
		9kHz~30MHz	H	3.57
		30MHz ~ 200MHz	V	3.82
		30MHz ~ 200MHz	H	3.60
		200MHz ~ 1,000MHz	V	3.86
		200MHz ~ 1,000MHz	H	3.94
		1GHz~18GHz	V	3.12
		1GHz~18GHz	H	3.68
		18GHz~40GHz	V	4.15
		18GHz~40GHz	H	4.14

Note: Unless specifically mentioned, the uncertainty of measurement has not been taken into account to declare the compliance or non-compliance to the specification.

3. GENERAL INFORMATION

3.1 GENERAL DESCRIPTION OF EUT

Equipment	AC1200 WIRELESS DUAL BAND GIGABIT FIBER ROUTER	
Brand Name	netis	
Model Name	WF2780F	
Mode Different	N/A	
Product Description	Operation Frequency	UNII-1: 5150-5250MHz UNII-3: 5725-5850MHz
	Modulation Type	OFDM
	Bit Rate of Transmitter	867Mbps
Power Source	DC voltage supplied from AC/DC adapter. Manufacturer: ShenZhen TOPOW Electronics Co., Ltd. Model Name: NTT101120100UL	
Power Rating	I/P: 100-240V~0.5A 50/60Hz O/P:12V --- 1A	
Output Power	Output Power (Max.)for UNII-1	802.11a: 13.79dBm 802.11n (20M): 12.81dBm 802.11n (40M): 12.74dBm 802.11ac (20M): 12.84dBm 802.11ac (40M): 12.66dBm 802.11ac (80M): 12.79dBm
	Output Power (Max.)for UNII-3	802.11a: 13.82dBm 802.11n (20M): 12.83dBm 802.11n (40M): 12.88dBm 802.11ac (20M): 12.85dBm 802.11ac (40M): 12.75dBm 802.11ac (80M): 12.84dBm

Note:

- For a more detailed features description, please refer to the manufacturer's specifications or the User's Manual.
- Channel List:

802.11a / 802.11n(20 MHz) / 802.11ac(20 MHz)		802.11n(40 MHz) / 802.11ac(40 MHz)		802.11ac(80 MHz)	
UNII-1		UNII-1		UNII-1	
Channel	Frequency (MHz)	Channel	Frequency (MHz)	Channel	Frequency (MHz)
36	5180	38	5190	42	5210
40	5200	46	5230		
44	5220				
48	5240				
UNII-3		UNII-3		UNII-3	
Channel	Frequency (MHz)	Channel	Frequency (MHz)	Channel	Frequency (MHz)
149	5745	151	5755	155	5775
153	5765	159	5795		
157	5785				
161	5805				
165	5825				

3. Antenna Specification:

Ant.	Brand	Model Name	Antenna Type	Connector	Gain (dBi)
1	N/A	N/A	Dipole	N/A	5
2	N/A	N/A	Dipole	N/A	5

Note: The EUT incorporates a MIMO function. Physically, the EUT provides two completed transmitters and receivers (2T2R).

4.

Operating Mode	2TX
TX Mode	
802.11a	V (ANT 1+ANT 2)
802.11n (20MHz)	V (ANT 1+ANT 2)
802.11n (40MHz)	V (ANT 1+ANT 2)
802.11ac (20MHz)	V (ANT 1+ANT 2)
802.11ac (40MHz)	V (ANT 1+ANT 2)
802.11ac (80MHz)	V (ANT 1+ANT 2)

3.2 DESCRIPTION OF TEST MODES

To investigate the maximum EMI emission characteristics generates from EUT, the test system was pre-scanning tested base on the consideration of following EUT operation mode or test configuration mode which possible have effect on EMI emission level. Each of these EUT operation mode(s) or test configuration mode(s) mentioned above was evaluated respectively.

Pretest Mode	Description
Mode 1	TX A Mode / CH36, CH40, CH48 (UNII-1)
Mode 2	TX N20 Mode / CH36, CH40, CH48 (UNII-1)
Mode 3	TX N40 Mode / CH38, CH46 (UNII-1)
Mode 4	TX AC20 Mode / CH36, CH40, CH48 (UNII-1)
Mode 5	TX AC40 Mode / CH38, CH46 (UNII-1)
Mode 6	TX AC80 Mode / CH42 (UNII-1)
Mode 7	TX A Mode / CH149,CH157,CH165 (UNII-3)
Mode 8	TX N20 Mode / CH149,CH157,CH165 (UNII-3)
Mode 9	TX N40 Mode / CH151,CH159 (UNII-3)
Mode 10	TX AC20 Mode / CH149,CH157,CH165 (UNII-3)
Mode 11	TX AC40 Mode / CH151,CH159 (UNII-3)
Mode 12	TX AC80 Mode / CH155 (UNII-3)
Mode 13	TX Mode

The EUT system operated these modes were found to be the worst case during the pre-scanning test as following:

For Conducted Test	
Final Test Mode	Description
Mode 13	TX Mode

For Radiated Test	
Final Test Mode	Description
Mode 1	TX A Mode / CH36, CH40, CH48 (UNII-1)
Mode 2	TX N20 Mode / CH36, CH40, CH48 (UNII-1)
Mode 3	TX N40 Mode / CH38, CH46 (UNII-1)
Mode 4	TX AC20 Mode / CH36, CH40, CH48 (UNII-1)
Mode 5	TX AC40 Mode / CH38, CH46 (UNII-1)
Mode 6	TX AC80 Mode / CH42 (UNII-1)
Mode 7	TX A Mode / CH149,CH157,CH165 (UNII-3)
Mode 8	TX N20 Mode / CH149,CH157,CH165 (UNII-3)
Mode 9	TX N40 Mode / CH151,CH159 (UNII-3)
Mode 10	TX AC20 Mode / CH149,CH157,CH165 (UNII-3)
Mode 11	TX AC40 Mode / CH151,CH159 (UNII-3)
Mode 12	TX AC80 Mode / CH155 (UNII-3)

Note:

(1) For radiated below 1GHz test, the 802.11a mode is found to be the worst case and recorded.

3.3 TABLE OF PARAMETERS OF TEST SOFTWARE SETTING

During testing channel & power controlling software provided by the customer was used to control the operating channel as well as the output power level. The RF output power selection is for the setting of RF output power expected by the customer and is going to be fixed on the firmware of the final end product

UNII-1			
Test Software Version	MP_TOOL		
Frequency (MHz)	5180	5200	5240
A Mode	33	33	30
Frequency (MHz)	5180	5200	5240
N20 Mode	30	30	29
Frequency (MHz)	5190	5230	
N40 Mode	33	31	

UNII-3			
Test Software Version	MP_TOOL		
Frequency (MHz)	5745	5785	5825
A Mode	42	42	42
Frequency (MHz)	5745	5785	5825
N20 Mode	41	40	40
Frequency (MHz)	5755	5795	
N40 Mode	41	41	

UNII-1			
Test Software Version	MP_TOOL		
Frequency (MHz)	5180	5200	5240
AC20 Mode	31	31	30
Frequency (MHz)	5190	5230	
AC40 Mode	33	31	
Frequency (MHz)	5210		
AC80 Mode	31		

UNII-3			
Test Software Version	MP_TOOL		
Frequency (MHz)	5745	5785	5825
AC20 Mode	40	39	38
Frequency (MHz)	5755	5795	
AC40 Mode	42	41	
Frequency (MHz)	5775		
AC80 Mode	42		

3.4 BLOCK DIAGRAM SHOWING THE CONFIGURATION OF SYSTEM TESTED

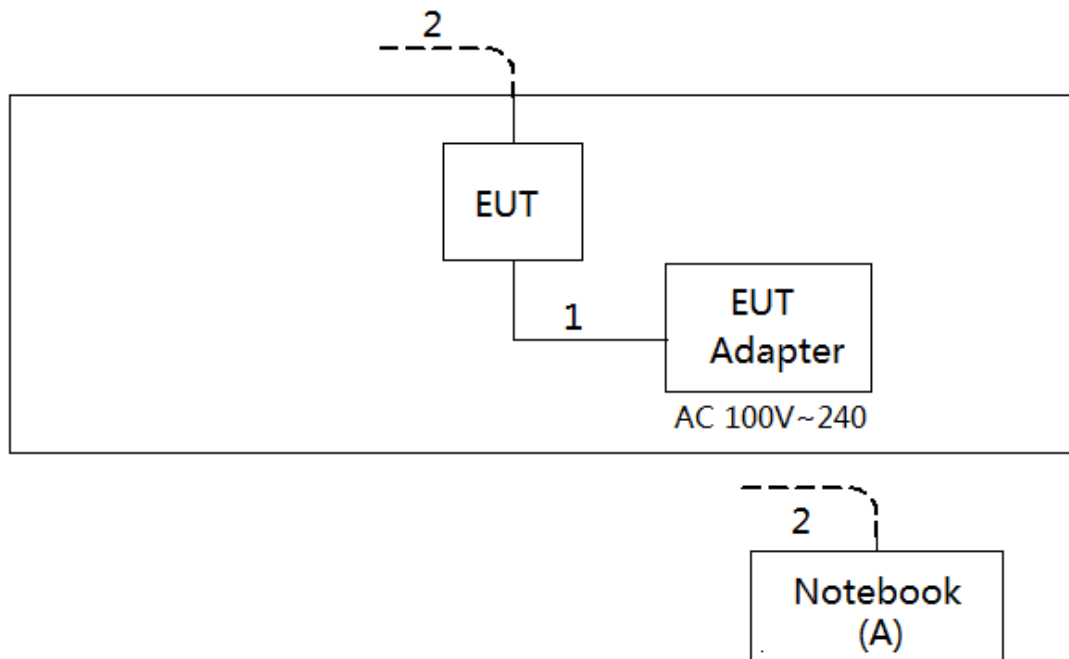

3.5 DESCRIPTION OF SUPPORT UNITS

The EUT has been tested as an independent unit together with other necessary accessories or support units. The following support units or accessories were used to form a representative test configuration during the tests.

Item	Equipment	Mfr/Brand	Model/Type No.	FCC ID	Series No.
A	NOTEBOOK	Dell	DCSM 745	DOC	G7K832X

Item	Shielded Type	Ferrite Core	Length	Note
1	NO	NO	1.8m	Power Cable
2	NO	NO	10m	RJ45 Cable

4. EMC EMISSION TEST

4.1 CONDUCTED EMISSION MEASUREMENT

4.1.1 POWER LINE CONDUCTED EMISSION (Frequency Range 150kHz-30MHz)

FREQUENCY (MHz)	Class A (dBuV)		Class B (dBuV)	
	Quasi-peak	Average	Quasi-peak	Average
0.15 -0.5	79.00	66.00	66 - 56 *	56 - 46 *
0.50 -5.0	73.00	60.00	56.00	46.00
5.0 -30.0	73.00	60.00	60.00	50.00

Note:

- (1) The tighter limit applies at the band edges.
- (2) The limit of " * " marked band means the limitation decreases linearly with the logarithm of the frequency in the range.

4.1.2 TEST PROCEDURE

- a. The EUT was placed 0.8 meters from the horizontal ground plane with EUT being connected to the power mains through a line impedance stabilization network (LISN). All other support equipment powered from additional LISN(s). The LISN provide 50 Ohm/ 50uH of coupling impedance for the measuring instrument.
- b. Interconnecting cables that hang closer than 40 cm to the ground plane shall be folded back and forth in the center forming a bundle 30 to 40 cm long.
- c. I/O cables that are not connected to a peripheral shall be bundled in the center. The end of the cable may be terminated, if required, using the correct terminating impedance. The overall length shall not exceed 1 m.
- d. LISN at least 80 cm from nearest part of EUT chassis.
- e. For the actual test configuration, please refer to the related Item –EUT Test Photos.

4.1.3 DEVIATION FROM TEST STANDARD

No deviation

4.1.4 TEST SETUP

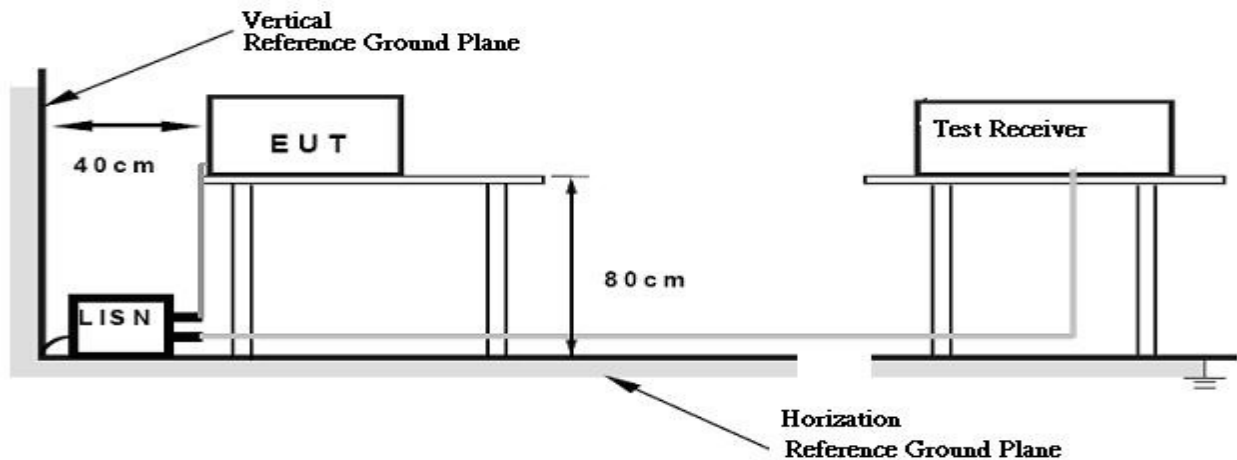

4.1.5 EUT OPERATING CONDITIONS

The EUT was configured for testing in a typical fashion (as a customer would normally use it). The EUT has been programmed to continuously transmit during test. This operating condition was tested and used to collect the included data.

The EUT was programmed to be in continuously transmitting/TX Mode mode.

4.1.6 EUT TEST CONDITIONS

Temperature: 25°C Relative Humidity: 53% Test Voltage: AC 120V/60Hz

4.1.7 TEST RESULTS

Please refer to the Attachment A.

Remark:

- (1) All readings are QP Mode value unless otherwise stated AVG in column of『Note』. If the QP Mode Measured value compliance with the QP Limits and lower than AVG Limits, the EUT shall be deemed to meet both QP & AVG Limits and then only QP Mode was measured, but AVG Mode didn't perform. In this case, a “ * ” marked in AVG Mode column of Interference Voltage Measured.
- (2) Measuring frequency range from 150kHz to 30MHz.

4.2 RADIATED EMISSION MEASUREMENT

4.2.1 RADIATED EMISSION LIMITS

20dBc in any 100 kHz bandwidth outside the operating frequency band. In case the emission fall within the restricted band specified on 15.205(a), then the 15.209(a) limit in the table below has to be followed.

Frequencies (MHz)	Field Strength (microrvolts/meter)	Measurement Distance (meters)
0.009~0.490	2400/F(kHz)	300
0.490~1.705	24000/F(kHz)	30
1.705~30.0	30	30
30~88	100	3
88~216	150	3
216~960	200	3
Above 960	500	3

Frequencies (MHz)	EIRP Limit (dBm)	Band edge at 3m (dBμV/m)	Harmonic at 1.5m (dBμV/m)
5150-5250	-27	68.3	74.3 (Note 3)
5250-5350	-27	68.3	74.3 (Note 3)
5470-5725	-27	68.3	74.3 (Note 3)
5725-5850	-27(Note 2)	68.3	74.3 (Note 3)
	10(Note 2)	105.3	111.3(Note 3)
	15.6(Note 2)	110.9	116.9(Note 3)
	27(Note 2)	122.3	128.3(Note 3)

Note:

- The following formula is used to convert the equipment isotropic radiated power (eirp) to field strength: $E = \frac{1000000\sqrt{30P}}{3} \mu\text{V/m}$, where P is the eirp (Watts)
- According to FCC 16-24, All emissions shall be limited to a level of -27 dBm/MHz at 75 MHz or more above or below the band edge increasing linearly to 10 dBm/MHz at 25 MHz above or below the band edge, and from 25MHz above or below the band edge increasing linearly to a level of 15.6 dBm/MHz at 5 MHz above or below the band edge, and from 5 MHz above or below the band edge increasing linearly to a level of 27dBm/MHz at the band edge.

$$FS_{\text{limit}} = FS_{\text{max}} - 20 \log \left(\frac{d_{\text{limit}}}{d_{\text{measure}}} \right)$$

3. $20 \log d_{\text{limit}}/d_{\text{measure}} = 20 \log 3/1.5 = 6 \text{dB}$.

4.2.2 TEST PROCEDURE

- a. The measuring distance of 3 m shall be used for measurements. The EUT was placed on the top of a rotating table 0.8 meter above the ground at a 3 meter semi-anechoic chamber. The table was rotated 360 degrees to determine the position of the highest radiation.(below 1GHz)
- b. The measuring distance of 3 m or 1.5m shall be used for measurements. The EUT was placed on the top of a rotating table 1.5 meter above the ground at a 3 meter semi-anechoic chamber. The table was rotated 360 degrees to determine the position of the highest radiation.(above 1GHz)
- c. The height of the equipment or of the substitution antenna shall be 0.8m or 1.5m; the height of the test antenna shall vary between 1 m to 4 m. Both horizontal and vertical polarizations of the antenna are set to make the measurement.
- d. For each suspected emission, the EUT was arranged to its worst case and then the antenna was tuned to heights find the maximum reading (used Bore sight function).
- e. The receiver system was set to peak and average detect function and specified bandwidth with maximum hold mode when the test frequency is above 1GHz.
- f. The initial step in collecting radiated emission data is a receiver peak detector mode pre-scanning the measurement frequency range. Significant peaks are then marked and then Quasi Peak detector mode re-measured.
- g. All readings are Peak unless otherwise stated QP in column of Note. Peak denotes that the Peak reading compliance with the QP Limits and then QP Mode measurement didn't perform. (below 1GHz)
- h. All readings are Peak Mode value unless otherwise stated AVG in column of Note. If the Peak Mode Measured value compliance with the Peak Limits and lower than AVG Limits, the EUT shall be deemed to meet both Peak & AVG Limits and then only Peak Mode was measured, but AVG Mode didn't perform. (above 1GHz)
- i. For the actual test configuration, please refer to the related Item –EUT Test Photos.

4.2.3 DEVIATION FROM TEST STANDARD

No deviation

4.2.4 TEST SETUP

(A) Radiated Emission Test Set-Up Frequency Below 1GHz

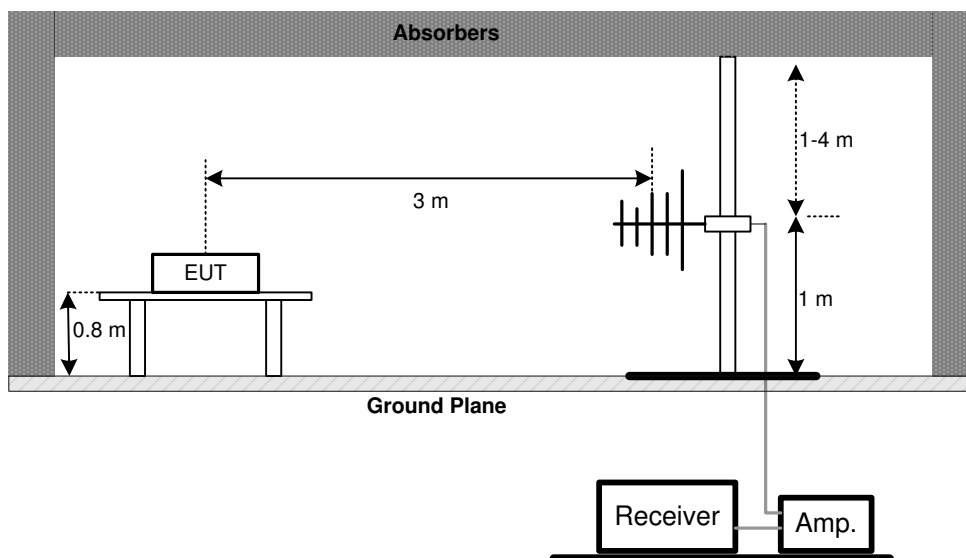

(B) Radiated Emission Test Set-Up Frequency Above 1 GHz

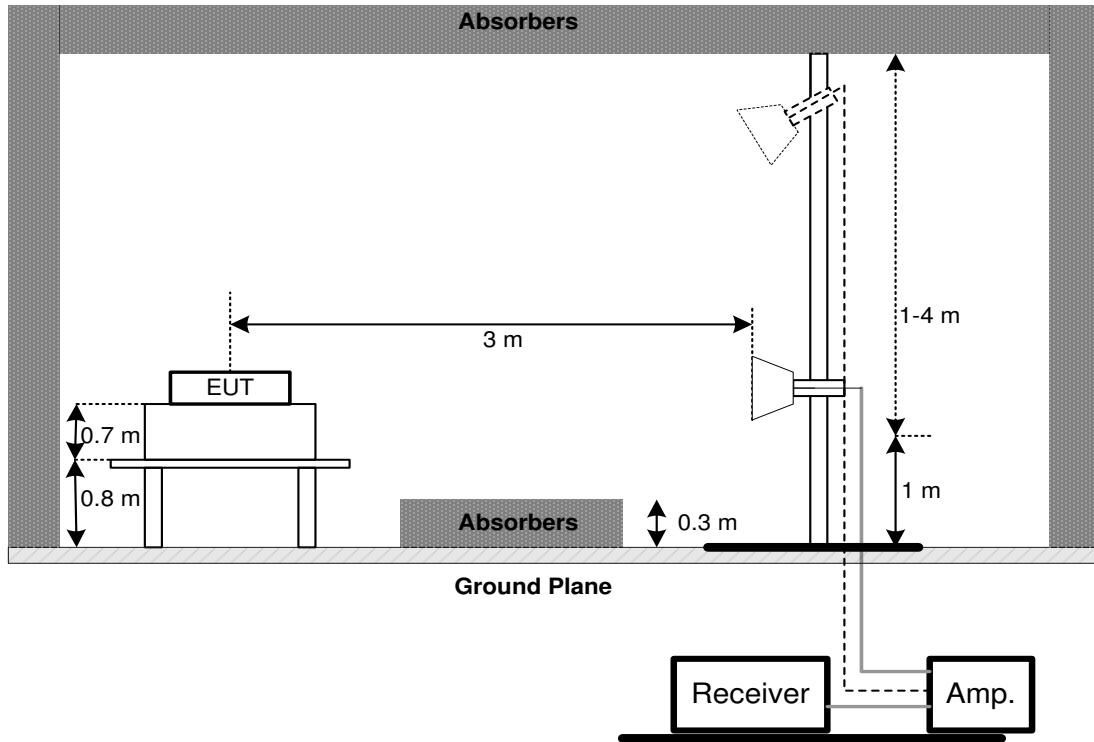

(C) Radiated Emissions Below 30MHz

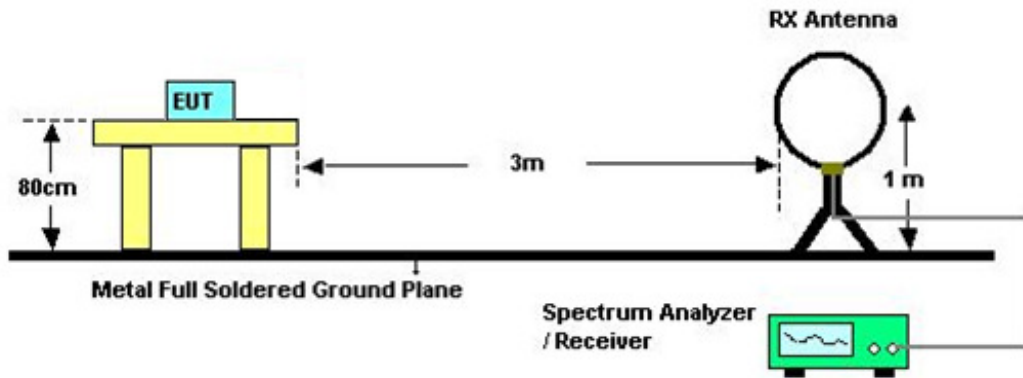

4.2.5 EUT OPERATING CONDITIONS

The EUT tested system was configured as the statements of 4.1.5 unless otherwise a special operating condition is specified in the follows during the testing.

4.2.6 EUT TEST CONDITIONS

Temperature: 25°C Relative Humidity: 60% Test Voltage: AC 120V/60Hz

4.2.7 TEST RESULTS (9KHz TO 30MHz)

Please refer to the Attachment B

Remark:

- (1) The amplitude of spurious emissions which are attenuated by more than 20 dB below the permissible value has no need to be reported.
- (2) Distance extrapolation factor = $40 \log(\text{specific distance} / \text{test distance})$ (dB);
- (3) Limit line = specific limits (dBuV) + distance extrapolation factor.

4.2.8 TEST RESULTS (30MHz TO 1000MHz)

Please refer to the Attachment C.

4.2.9 TEST RESULTS (ABOVE 1000MHz)

Please refer to the Attachment D.

Remark:

- (1) No limit: This is fundamental signal, the judgment is not applicable.
For fundamental signal judgment was referred to Peak output test.

5. 26dB SPECTRUM BANDWIDTH

5.1 APPLIED PROCEDURES / LIMIT

FCC Part15, Subpart E			
Test Item	Limit	Frequency Range (MHz)	Result
Bandwidth	26 dB Bandwidth	5150-5250	PASS
	Minimum 500kHz 6dB Bandwidth	5725-5850	PASS

5.1.1 TEST PROCEDURE

a. The EUT was directly connected to the spectrum analyzer and antenna output port as show in the block diagram below,

b.

Spectrum Parameters	Setting
Attenuation	Auto
Span Frequency	> 26dB Bandwidth
RBW	300 kHz
VBW	1000 kHz
Detector	Peak
Trace	Max Hold
Sweep Time	Auto

c. Measured the spectrum width with power higher than 26dB below carrier

5.1.2 DEVIATION FROM STANDARD

No deviation.

5.1.3 TEST SETUP



5.1.4 EUT OPERATION CONDITIONS

The EUT tested system was configured as the statements of 4.1.5 unless otherwise a special operating condition is specified in the follows during the testing.

5.1.5 EUT TEST CONDITIONS

Temperature: 25°C Relative Humidity: 60% Test Voltage: AC 120V/60Hz

5.1.6 TEST RESULTS

Please refer to the Attachment E.

6. MAXIMUM CONDUCTED OUTPUT POWER

6.1 APPLIED PROCEDURES / LIMIT

FCC Part15, Subpart E			
Test Item	Limit	Frequency Range (MHz)	Result
Conducted Output Power	Fixed:1 Watt (30dBm) Mobile and portable: 250mW (24dBm)	5150-5250	PASS
	1 Watt (30dBm)	5725-5850	PASS

Note: The maximum e.i.r.p at any elevation angle above 30 degrees as measured from the horizon must not exceed 125mW(21dBm)

6.1.1 TEST PROCEDURE

- a. The EUT was directly connected to the power meter and antenna output port as show in the block diagram below,
- b.

Spectrum Parameter	Setting
Attenuation	Auto
Span Frequency	Encompass the entire emissions bandwidth (EBW) of the signal
RBW	= 1MHz.
VBW	\geq 3MHz.
Detector	RMS
Trace	Max Hold
Sweep Time	auto

- c. Test was performed in accordance with method of KDB 789033 D02.

6.1.2 DEVIATION FROM STANDARD

No deviation.

6.1.3 TEST SETUP

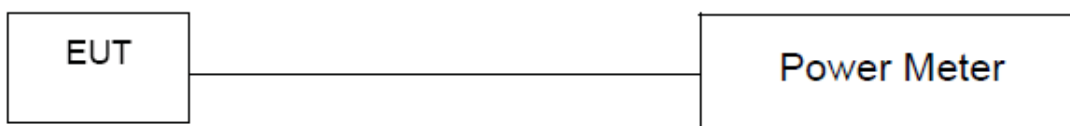

6.1.4 EUT OPERATION CONDITIONS

The EUT tested system was configured as the statements of 4.1.5 unless otherwise a special operating condition is specified in the follows during the testing.

6.1.5 EUT TEST CONDITIONS

Temperature: 25°C Relative Humidity: 60% Test Voltage: AC 120V/60Hz

6.1.6 TEST RESULTS

Please refer to the Attachment F.

7. POWER SPECTRAL DENSITY TEST

7.1 APPLIED PROCEDURES / LIMIT

FCC Part15, Subpart E			
Test Item	Limit	Frequency Range (MHz)	Result
Power Spectral Density	Other then Mobile and portable:17dBm/MHz Mobile and portable:11dBm/MHz	5150-5250	PASS
	30dBm/500kHz	5725-5850	PASS

8.1.1 TEST PROCEDURE

a. The EUT was directly connected to the spectrum analyzer and antenna output port as show in the block diagram below,

b.

Spectrum Parameter	Setting
Attenuation	Auto
Span Frequency	Encompass the entire emissions bandwidth (EBW) of the signal
RBW	= 1MHz.
VBW	≥ 3MHz.
Detector	RMS
Trace average	100 trace
Sweep Time	Auto

Note:

- For UNII-3, according to KDB publication 789033 D02 General UNII Test Procedures New Rules v01r02, section II.F.5., it is acceptable to set RBW at 1MHz and VBW at 3MHz if the spectrum analyzer does not have 500kHz RBW.
- The value measured with RBW=1MHz is to be added with $10\log(500\text{kHz}/1\text{MHz})$ which is -3dB. For example, if the measured value is +10dBm using RBW=1MHz (that is +10dBm/MHz), then the converted value will be +7dBm/500kHz.

7.1.1 DEVIATION FROM STANDARD

No deviation.

7.1.2 TEST SETUP

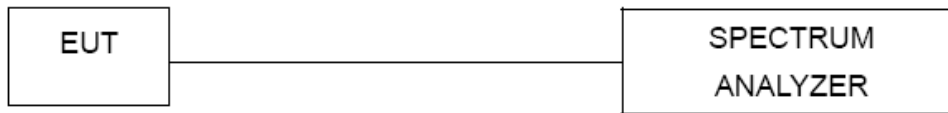

7.1.3 EUT OPERATION CONDITIONS

The EUT tested system was configured as the statements of 4.1.5 unless otherwise a special operating condition is specified in the follows during the testing.

7.1.4 EUT TEST CONDITIONS

Temperature: 25°C Relative Humidity: 60% Test Voltage: AC 120V/60Hz

7.1.5 TEST RESULTS

Please refer to the Attachment H.

8. FREQUENCY STABILITY MEASUREMENT

8.1 APPLIED PROCEDURES / LIMIT

FCC Part15, Subpart E			
Test Item	Limit	Frequency Range (MHz)	Result
Specified in the user's manual Specified in the user's manual Frequency Stability	Specified in the user's manual	5150-5250	PASS
		5725-5850	PASS

8.1.1 TEST PROCEDURE

a. The EUT was directly connected to the spectrum analyzer and antenna output port as show in the block diagram below,

b.

Spectrum Parameter	Setting
Attenuation	Auto
Span Frequency	Entire absence of modulation emissions bandwidth
RBW	10 kHz
VBW	10 kHz
Sweep Time	Auto

c. The test extreme voltage is to change the primary supply voltage from 85 to 115 percent of the nominal value.

d. User manual temperature is 0°C~40°C.

8.1.2 DEVIATION FROM STANDARD

No deviation.

8.1.3 TEST SETUP

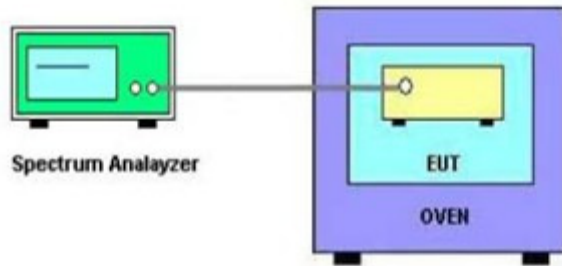

8.1.4 EUT OPERATION CONDITIONS

The EUT tested system was configured as the statements of 4.1.5 unless otherwise a special operating condition is specified in the follows during the testing.

8.1.5 EUT TEST CONDITIONS

Temperature: 25°C Relative Humidity: 55% Test Voltage: AC 120V/60Hz

8.1.6 TEST RESULTS

Please refer to the Attachment I.

9. MEASUREMENT INSTRUMENTS LIST

Conducted Emission Measurement					
Item	Kind of Equipment	Manufacturer	Type No.	Serial No.	Calibrated until
1	LISN	EMCO	3816/2	0052765	Mar. 27, 2017
2	LISN	R&S	ENV216	101447	Mar. 27, 2017
3	Test Cable	emci	RG223(9KHz-30MHz)	C_17	Mar. 10, 2017
4	EMI Test Receiver	R&S	ESCI	100382	Mar. 27, 2017
5	50Ω Terminator	SHX	TF2-3G-A	08122901	Mar. 27, 2017
6	Measurement Software	Farad	EZ-EMC Ver.NB-03A1-01	N/A	N/A

Radiated Emission Measurement					
Item	Kind of Equipment	Manufacturer	Type No.	Serial No.	Calibrated until
1	Antenna	Schwarbeck	VULB9160	9160-3232	Mar. 27, 2017
2	Amplifier	HP	8447D	2944A09673	Nov. 09, 2016
3	Receiver	AGILENT	N9038A	MY52130039	Sep. 04, 2017
4	Test Cable	emci	LMR-400(30MHz-1GHz)	C-01	Jun. 26, 2017
5	Control	CT	SC100	N/A	N/A
6	Position Control	MF	MF-7802	MF780208416	N/A
7	Antenna	ETS	3115	00075789	Mar. 27, 2017
8	Amplifier	Agilent	8449B	3008A02274	Nov. 01, 2017
9	Test Cable	emci	EMC104-SM-S M-10000(1GHz-26.5GHz)	C-68	Jun. 26, 2017
10	Controller	CT	SC100	N/A	N/A
11	Broad-Band Horn Antenna	Schwarzbeck	BBHA 9170	9170319	Apr. 23, 2017
12	Microwave Preamplifier With Adaptor	EMC INSTRUMENT	EMC2654045	980039 & HA01	Mar. 27, 2017
13	Active Loop Antenna	R&S	HFH2-Z2	830749/020	Sep. 06, 2017
14	Measurement Software	Farad	EZ-EMC Ver.NB-03A1-01	N/A	N/A

Spectrum Bandwidth Measurement					
Item	Kind of Equipment	Manufacturer	Type No.	Serial No.	Calibrated until
1	Spectrum Analyzer	R&S	FSP 40	100185	Sep. 04, 2017

Maximum Conducted Output Power Measurement					
Item	Kind of Equipment	Manufacturer	Type No.	Serial No.	Calibrated until
1	P-series Power meter	Agilent	N1911A	MY45100473	Sep. 04, 2017
2	Wireband Power sensor	Agilent	N1921A	MY51100041	Sep. 04, 2017

Power Spectral Density Measurement					
Item	Kind of Equipment	Manufacturer	Type No.	Serial No.	Calibrated until
1	Spectrum Analyzer	R&S	FSP 40	100185	Sep. 04, 2017

Frequency Stability Measurement					
Item	Kind of Equipment	Manufacturer	Type No.	Serial No.	Calibrated until
1	Spectrum Analyzer	R&S	FSP 40	100185	Sep. 04, 2017
2	Precision Oven Tester	HOLINK	H-T-1F-D	BA03101701	May 22, 2017

Remark: "N/A" denotes no model name, serial no. or calibration specified.
 All calibration period of equipment list is one year.

10. EUT TEST PHOTOS

Conducted Measurement Photos



Radiated Measurement Photos

9KHz to 30MHz



Radiated Measurement Photos

30MHz to 1000MHz

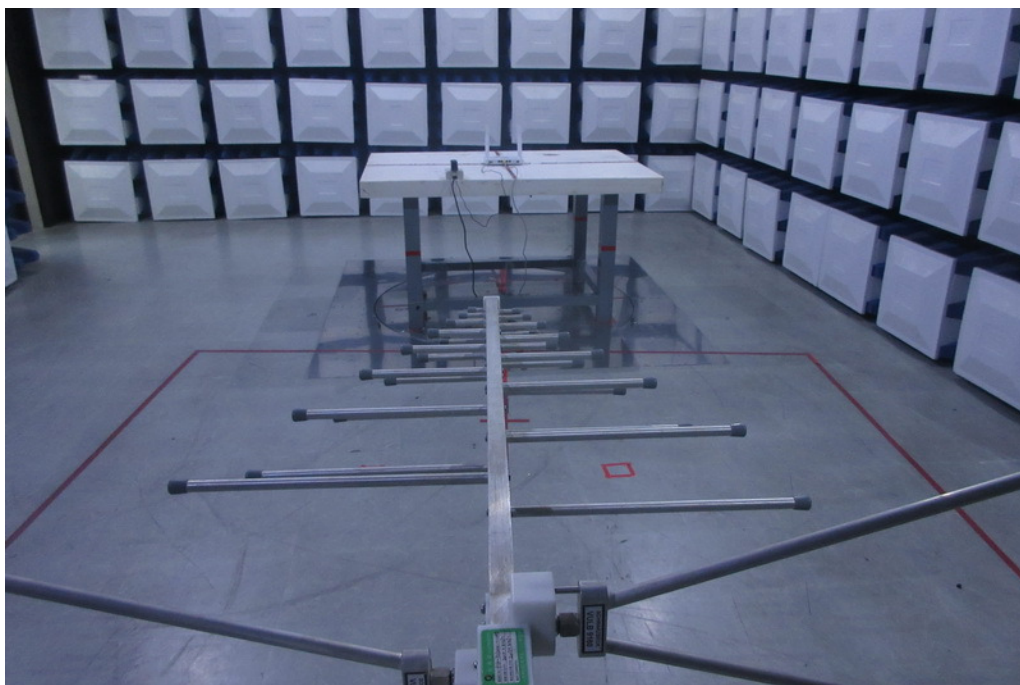
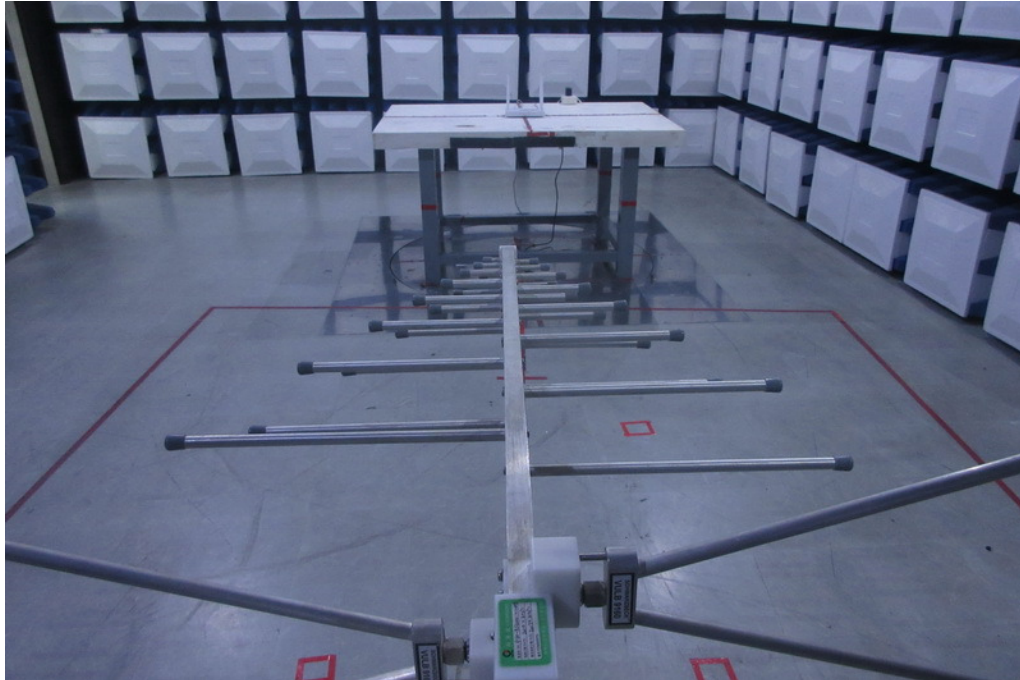

Radiated Measurement Photos

Above 1000MHz

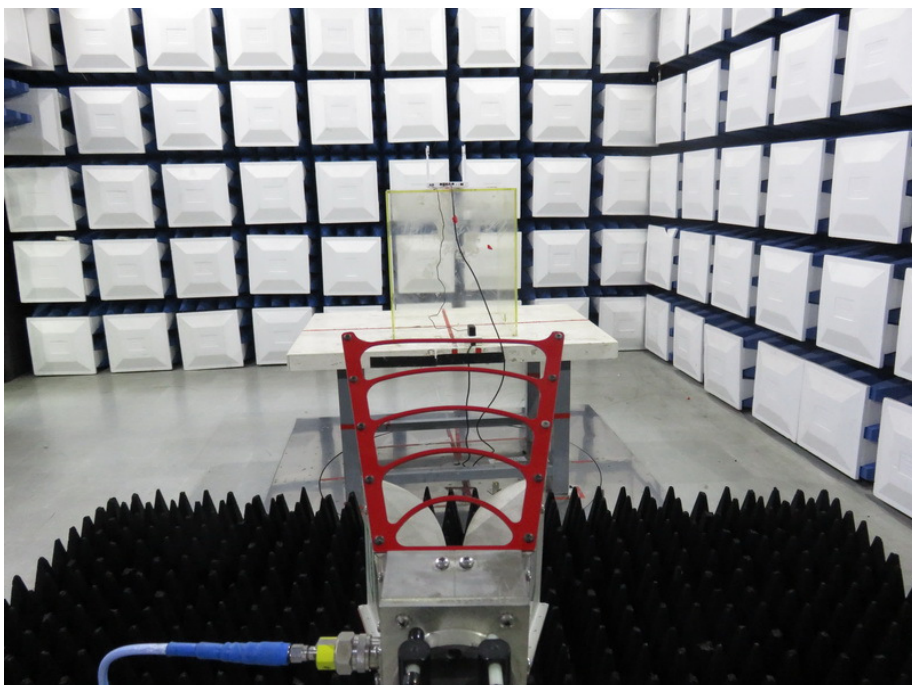
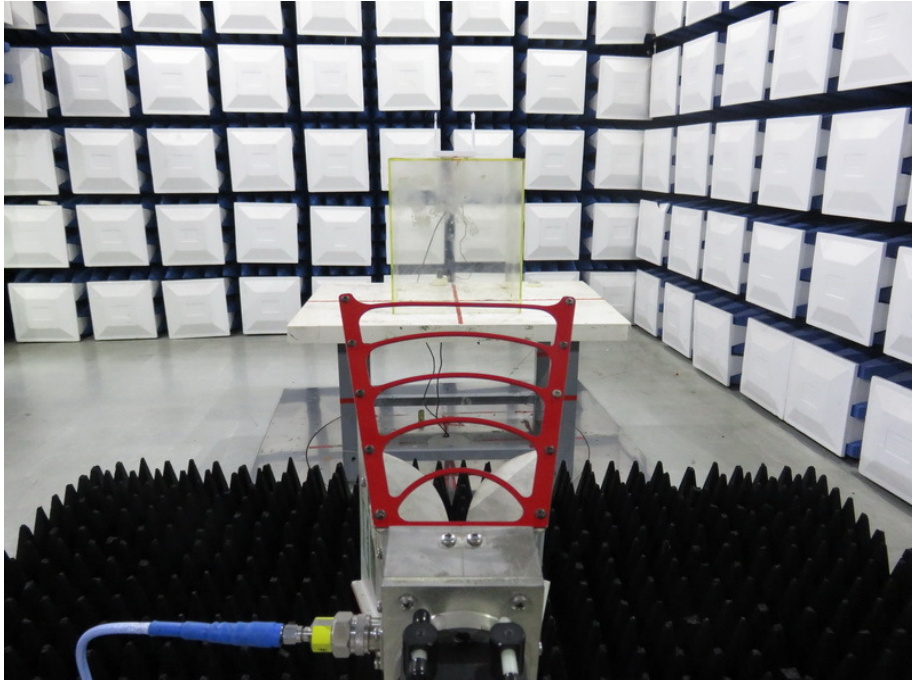

ATTACHMENT A - CONDUCTED EMISSION

Test Mode: TX MODE

Line

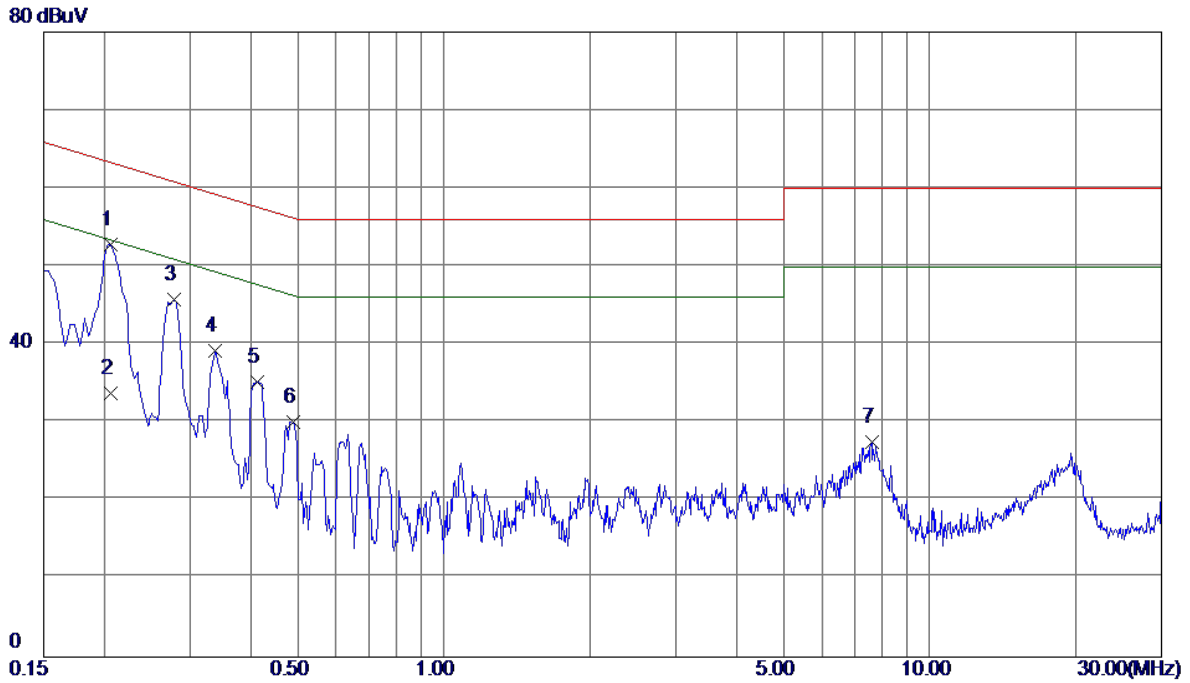

No.	Freq. MHz	Reading Level dBuV	Correct Factor dB	Measure ment dBuV	Limit dBuV	Margin dB	Detector	Comment
1 *	0.2060	43.33	9.53	52.86	63.37	-10.51	Peak	
2	0.2060	24.20	9.53	33.73	53.37	-19.64	AVG	
3	0.2779	36.21	9.53	45.74	60.88	-15.14	Peak	
4	0.3379	29.60	9.53	39.13	59.25	-20.12	Peak	
5	0.4140	25.67	9.55	35.22	57.57	-22.35	Peak	
6	0.4900	20.47	9.63	30.10	56.17	-26.07	Peak	
7	7.5980	17.37	10.17	27.54	60.00	-32.46	Peak	

Note : The test result has included the cable loss.

Test Mode: TX MODE

Neutral

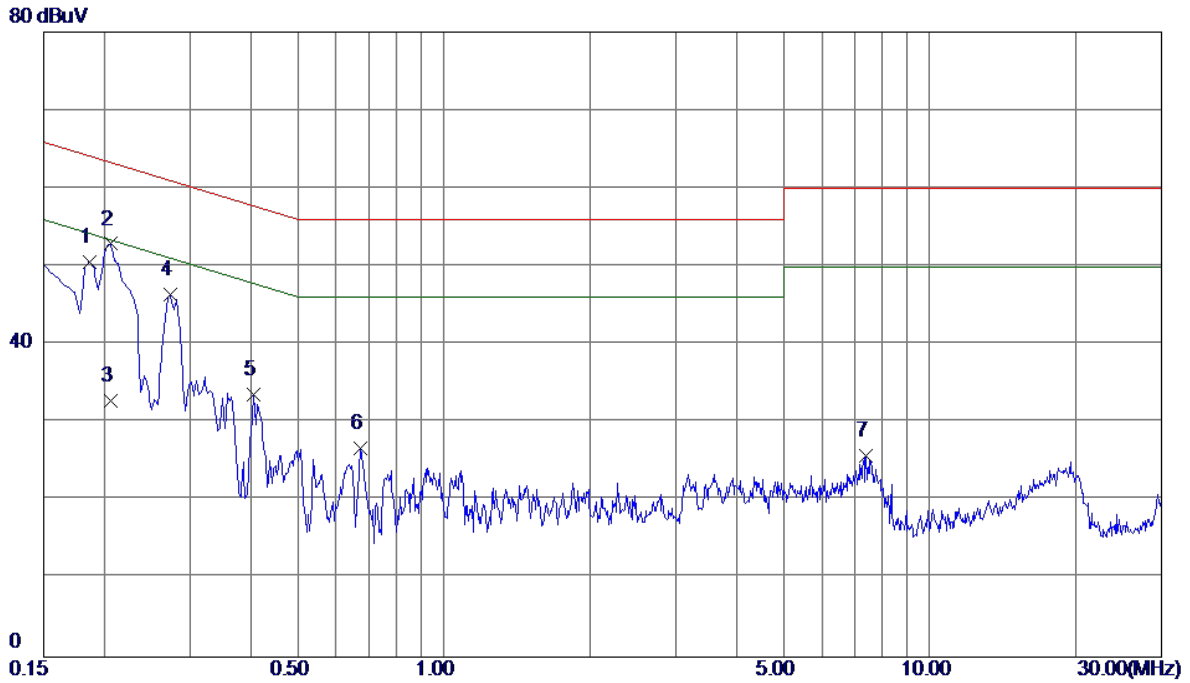

No.	Freq. MHz	Reading Level dBuV	Correct Factor dB	Measure ment dBuV	Limit dBuV	Margin dB	Detector	Comment
1	0.1860	41.12	9.48	50.60	64.21	-13.61	Peak	
2 *	0.2060	43.35	9.53	52.88	63.37	-10.49	Peak	
3	0.2060	23.30	9.53	32.83	53.37	-20.54	AVG	
4	0.2740	36.84	9.53	46.37	61.00	-14.63	Peak	
5	0.4060	24.16	9.44	33.60	57.73	-24.13	Peak	
6	0.6740	17.30	9.45	26.75	56.00	-29.25	Peak	
7	7.3900	15.75	10.00	25.75	60.00	-34.25	Peak	

Note : The test result has included the cable loss.

ATTACHMENT B - RADIATED EMISSION (9KHZ TO 30MHZ)

Test Mode: TX MODE

Ant 0°

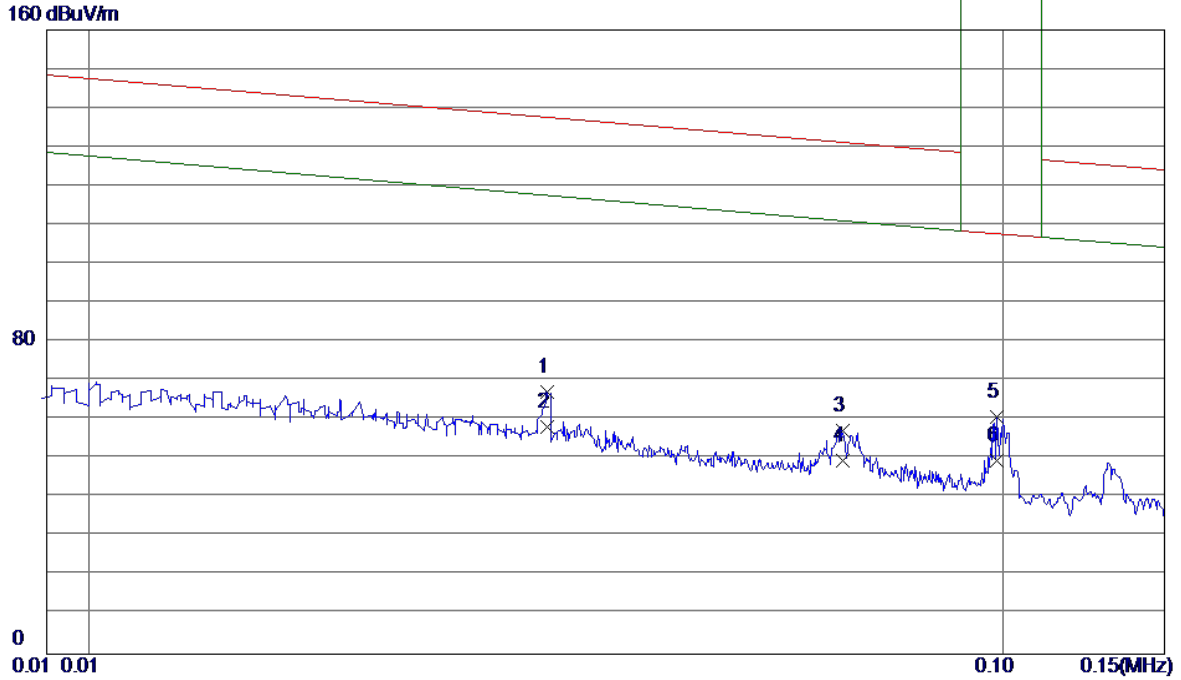

No.	Freq. MHz	Reading Level dBuV/m	Correct Factor dB	Measure ment dBuV/m	Limit dBuV/m	Margin dB	Detector	Comment
1	0.0317	45.15	22.08	67.23	142.89	-75.66	Peak	
2	0.0317	36.21	22.08	58.29	122.89	-64.60	AVG	
3	0.0667	37.71	19.63	57.34	134.25	-76.91	Peak	
4	0.0667	30.02	19.63	49.65	114.25	-64.60	AVG	
5 *	0.0984	42.16	18.50	60.66	107.78	-47.12	Peak	
6	0.0984	31.21	18.50	49.71	999.00	-949.29	AVG	

Test Mode: TX MODE

Ant 0°

160 dBuV/m

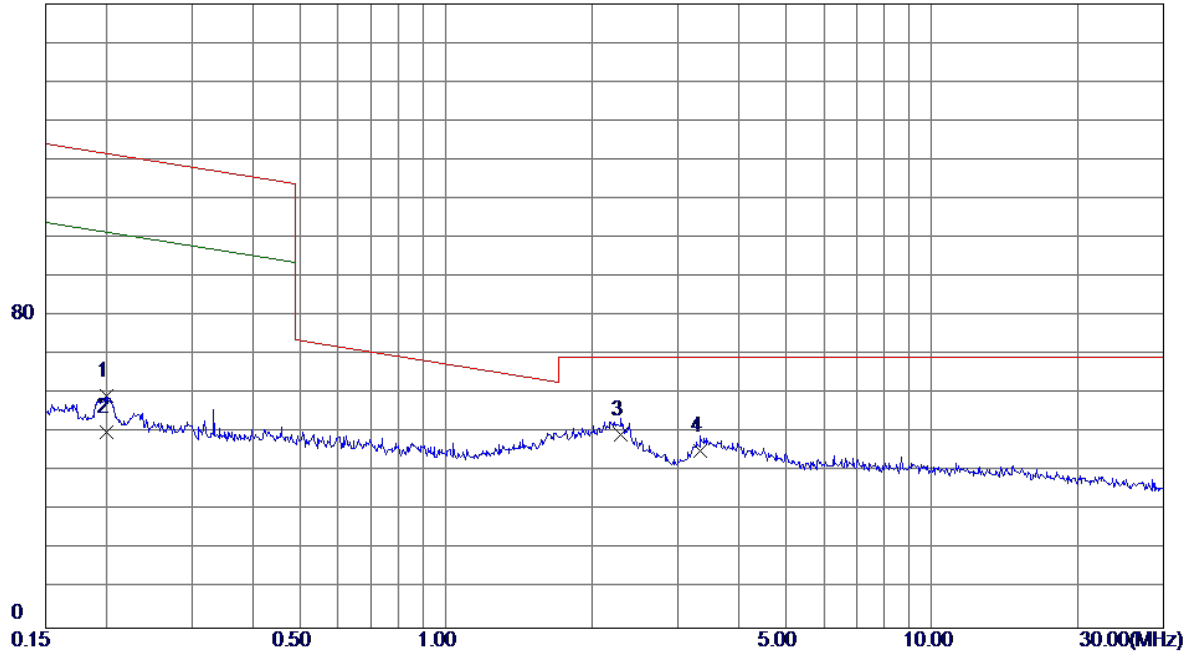

No.	Freq. MHz	Reading Level dBuV/m	Correct Factor dB	Measure ment dBuV/m	Limit dBuV/m	Margin dB	Detector	Comment
1	0.2007	40.68	18.69	59.37	123.68	-64.31	Peak	
2	0.2007	31.57	18.69	50.26	103.68	-53.42	AVG	
3 *	2.2967	32.11	17.53	49.64	69.54	-19.90	QP	
4	3.3458	28.02	17.36	45.38	69.54	-24.16	QP	

Test Mode: TX MODE

Ant 90°

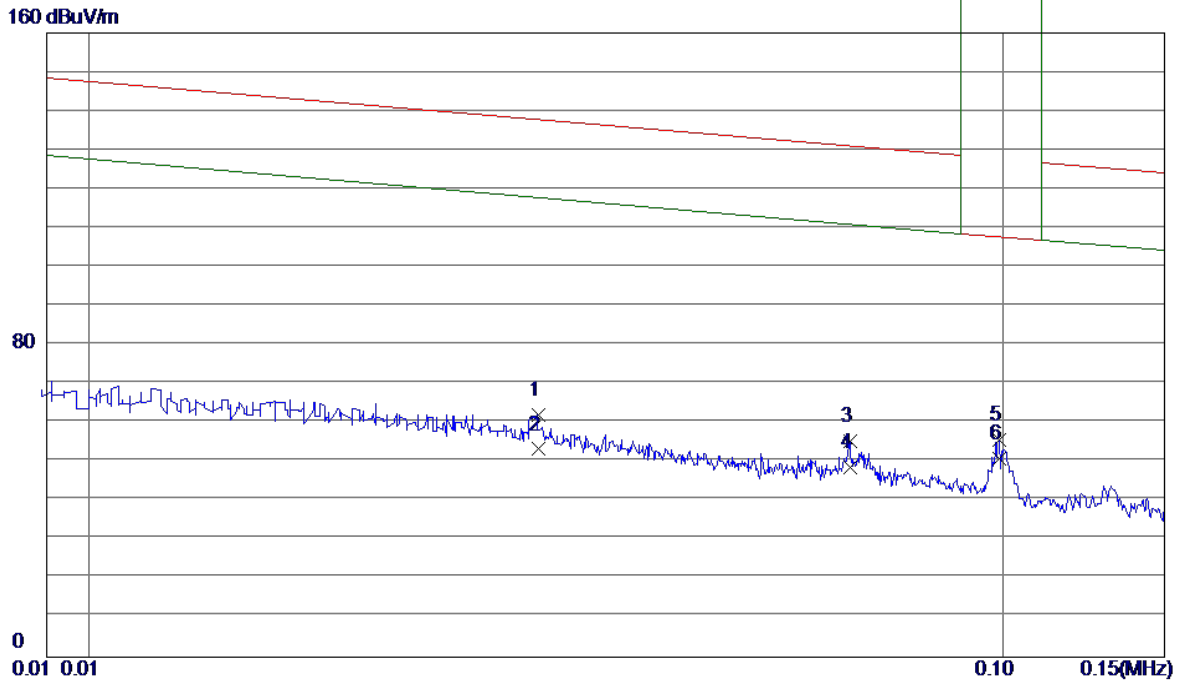

No.	Freq. MHz	Reading Level dBuV/m	Correct Factor dB	Measure ment dBuV/m	Limit dBuV/m	Margin dB	Detector	Comment
1	0.0310	39.93	22.17	62.10	143.06	-80.96	Peak	
2	0.0310	31.11	22.17	53.28	123.06	-69.78	AVG	
3	0.0680	35.70	19.61	55.31	133.93	-78.62	Peak	
4	0.0680	29.11	19.61	48.72	113.93	-65.21	AVG	
5 *	0.0990	37.28	18.47	55.75	107.73	-51.98	Peak	
6	0.0990	32.54	18.47	51.01	999.00	-947.99	AVG	

Test Mode: TX MODE

Ant 90°

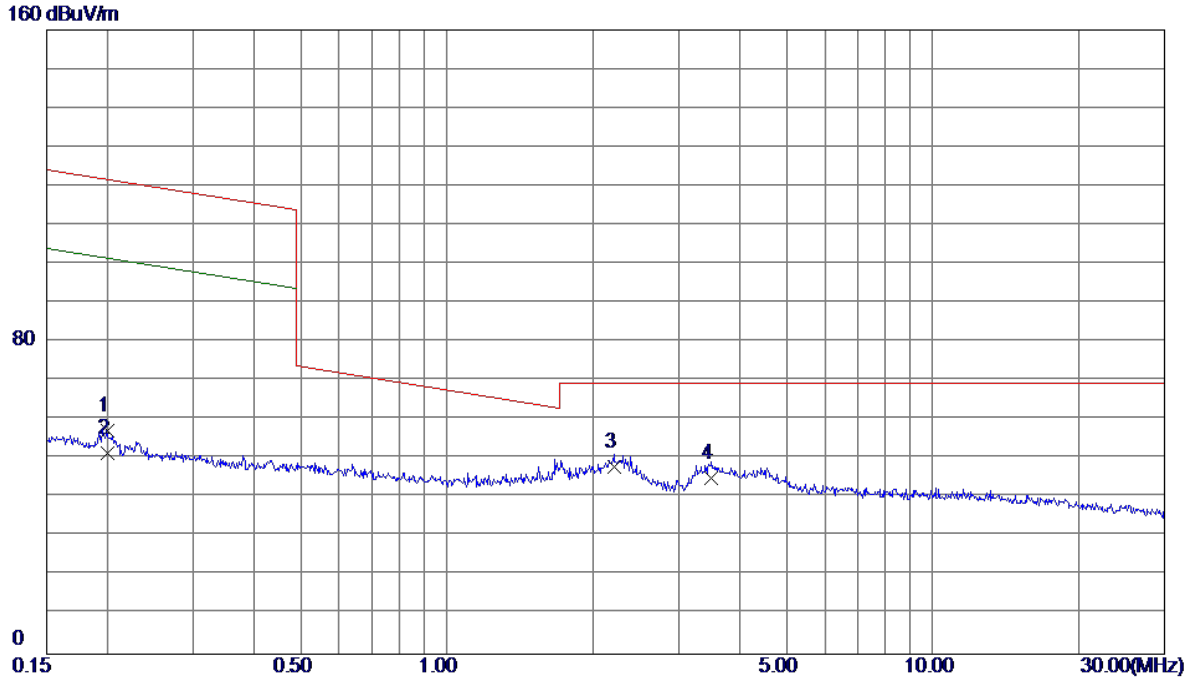

No.	Freq. MHz	Reading Level dBuV/m	Correct Factor dB	Measure ment dBuV/m	Limit dBuV/m	Margin dB	Detector	Comment
1	0.1996	38.53	18.69	57.22	123.72	-66.50	Peak	
2	0.1996	32.87	18.69	51.56	103.72	-52.16	AVG	
3 *	2.2131	30.51	17.63	48.14	69.54	-21.40	QP	
4	3.5091	27.45	17.71	45.16	69.54	-24.38	QP	

ATTACHMENT C - RADIATED EMISSION (30MHZ TO 1000MHZ)

Test Mode: UNII-1/TX A Mode 5180MHz

Vertical

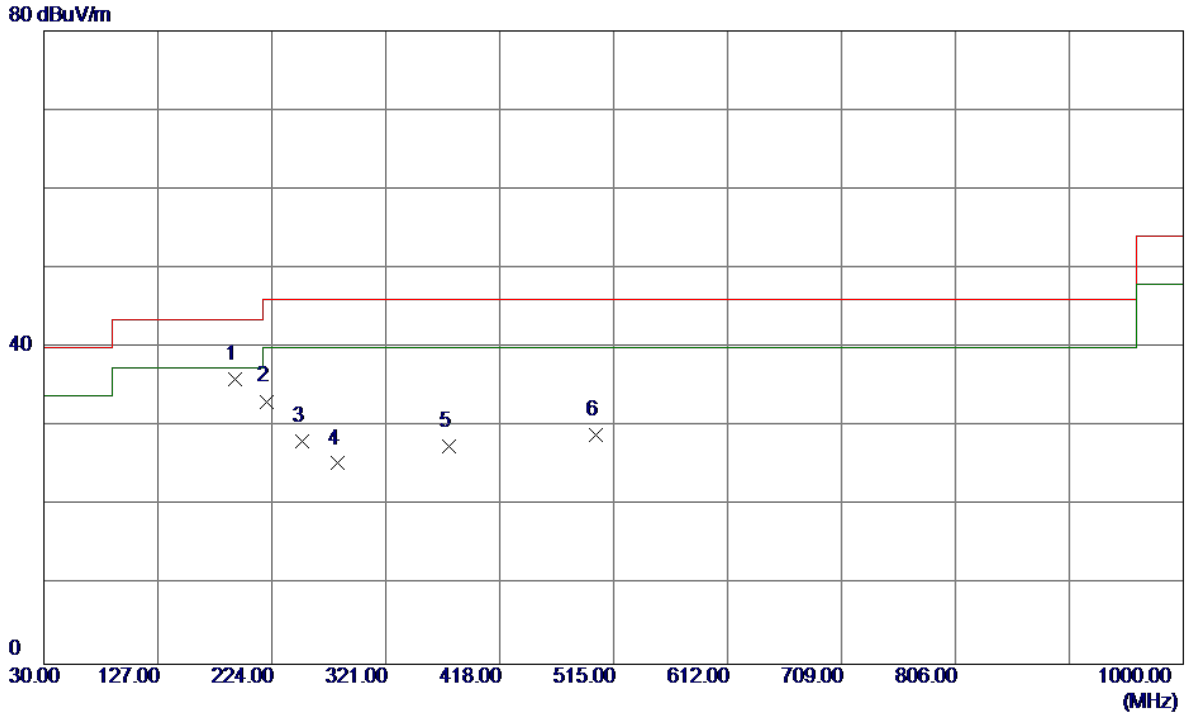

No.	Freq. MHz	Reading Level dBuV/m	Correct Factor dB	Measure ment dBuV/m	Limit dBuV/m	Margin dB	Detector	Comment
1 *	192.4750	50.01	-14.06	35.95	43.50	-7.55	Peak	
2	220.1200	47.45	-14.25	33.20	46.00	-12.80	Peak	
3	250.1900	42.40	-14.20	28.20	46.00	-17.80	Peak	
4	280.2600	37.37	-12.01	25.36	46.00	-20.64	Peak	
5	374.8350	37.08	-9.51	27.57	46.00	-18.43	Peak	
6	499.9650	38.68	-9.72	28.96	46.00	-17.04	Peak	

Test Mode: UNII-1/TX A Mode 5180MHz

Horizontal

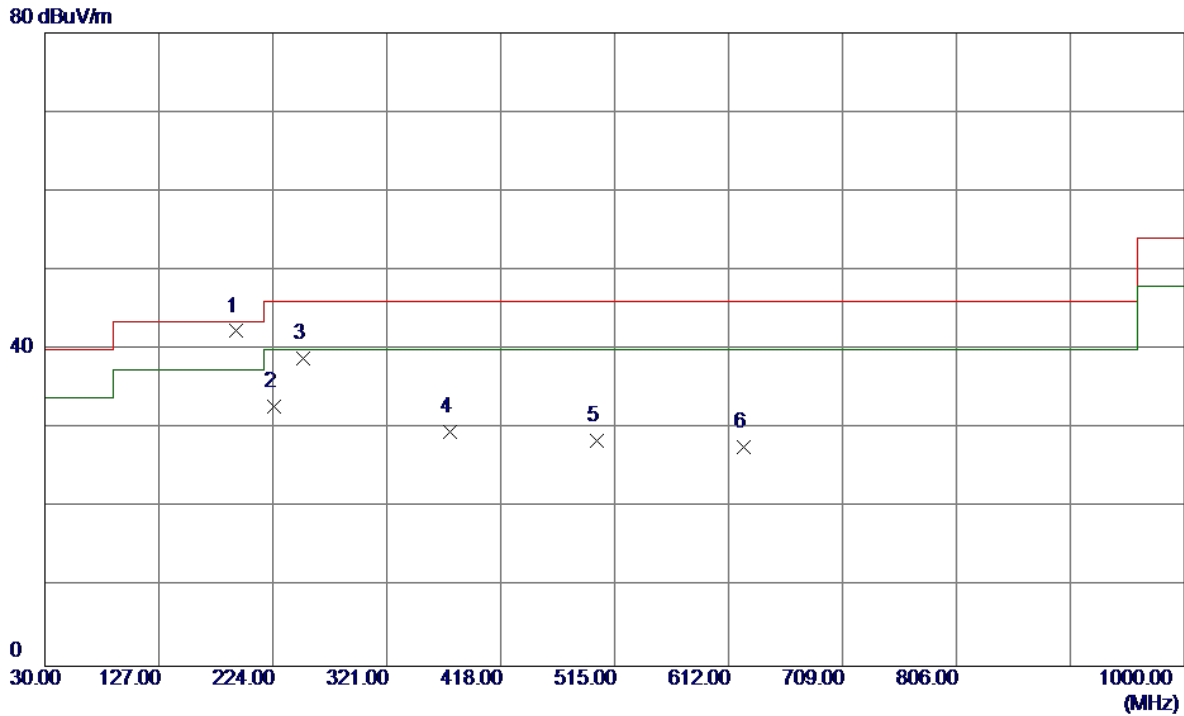

No.	Freq. MHz	Reading Level dBuV/m	Correct Factor dB	Measure ment dBuV/m	Limit dBuV/m	Margin dB	Detector	Comment
1 *	192.4750	56.38	-14.06	42.32	43.50	-1.18	QP	
2	224.9700	46.63	-13.82	32.81	46.00	-13.19	Peak	
3	250.1900	53.10	-14.20	38.90	46.00	-7.10	Peak	
4	374.8350	39.17	-9.51	29.66	46.00	-16.34	Peak	
5	499.9650	38.26	-9.72	28.54	46.00	-17.46	Peak	
6	625.0949	33.36	-5.61	27.75	46.00	-18.25	Peak	

Test Mode: UNII-1/TX A Mode 5200MHz

Vertical

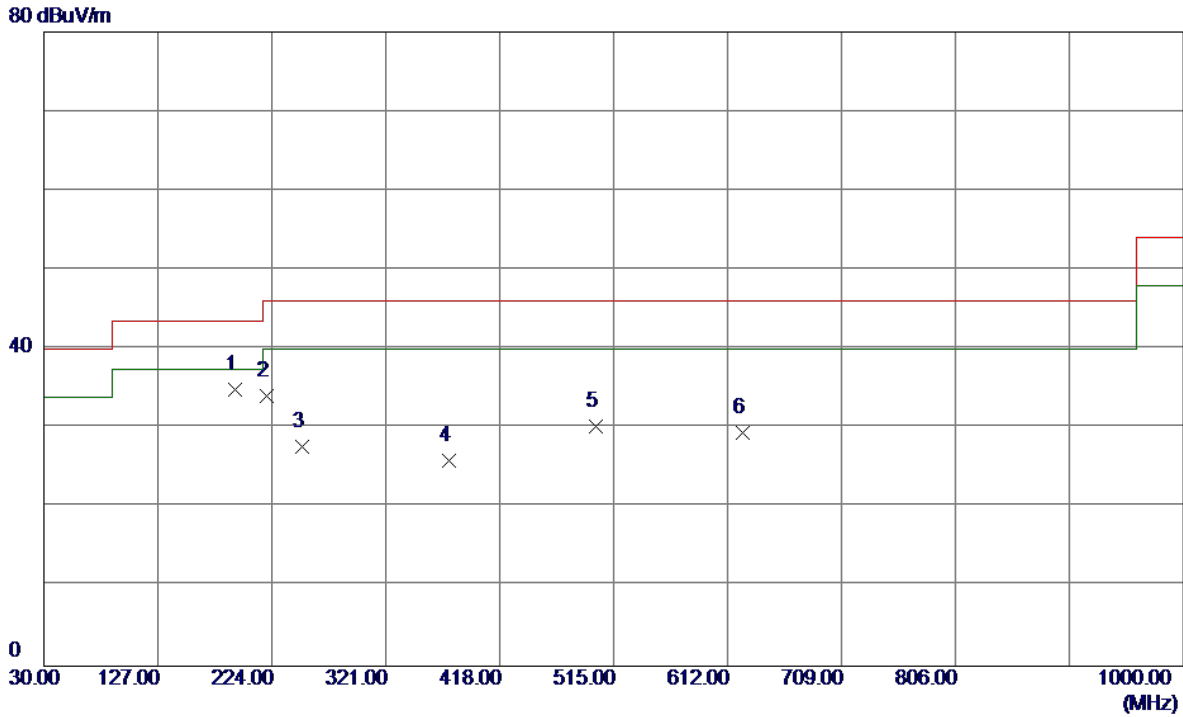

No.	Freq. MHz	Reading Level dBuV/m	Correct Factor dB	Measure ment dBuV/m	Limit dBuV/m	Margin dB	Detector	Comment
1 *	192.4750	48.91	-14.06	34.85	43.50	-8.65	Peak	
2	220.1200	48.28	-14.25	34.03	46.00	-11.97	Peak	
3	250.1900	41.86	-14.20	27.66	46.00	-18.34	Peak	
4	374.8350	35.50	-9.51	25.99	46.00	-20.01	Peak	
5	499.9650	39.94	-9.72	30.22	46.00	-15.78	Peak	
6	625.0949	35.11	-5.61	29.50	46.00	-16.50	Peak	

Test Mode: UNII-1/TX A Mode 5200MHz

Horizontal

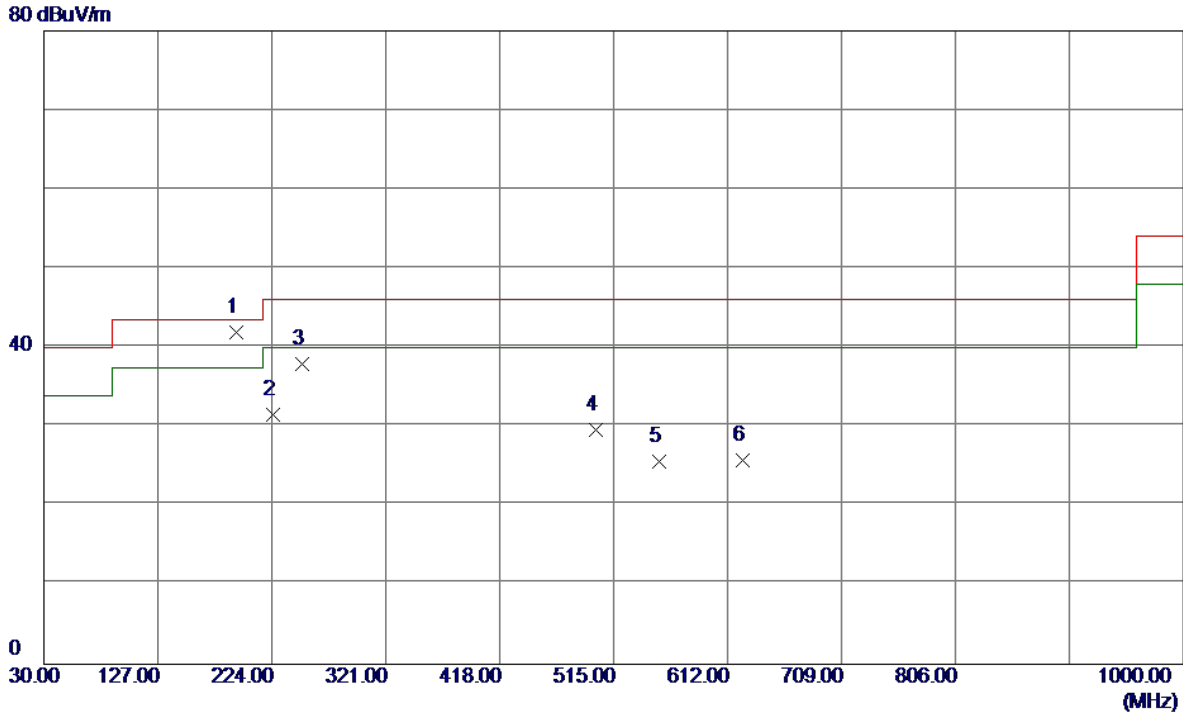

No.	Freq. MHz	Reading Level dBuV/m	Correct Factor dB	Measure ment dBuV/m	Limit dBuV/m	Margin dB	Detector	Comment
1 *	193.9299	56.12	-14.13	41.99	43.50	-1.51	QP	
2	224.9700	45.33	-13.82	31.51	46.00	-14.49	Peak	
3	250.1900	52.12	-14.20	37.92	46.00	-8.08	Peak	
4	499.9650	39.32	-9.72	29.60	46.00	-16.40	Peak	
5	553.8000	30.27	-4.73	25.54	46.00	-20.46	Peak	
6	625.0949	31.33	-5.61	25.72	46.00	-20.28	Peak	

Test Mode: UNII-1/TX A Mode 5240MHz

Vertical

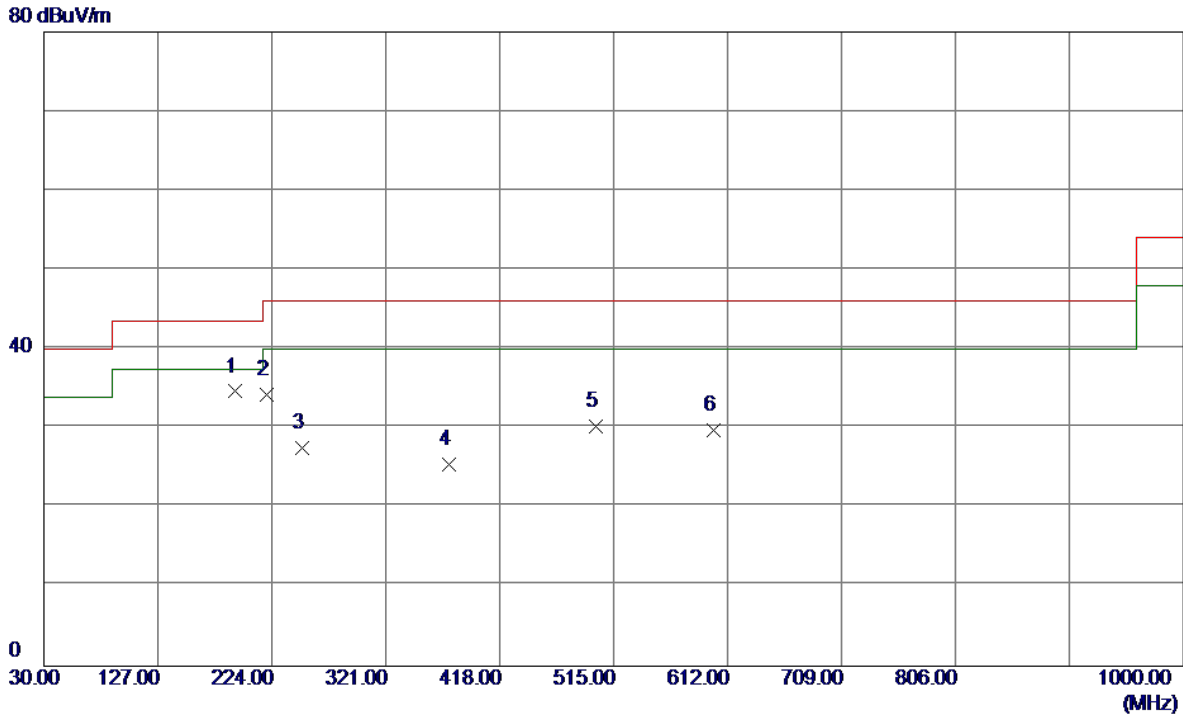

No.	Freq. MHz	Reading Level dBuV/m	Correct Factor dB	Measure ment dBuV/m	Limit dBuV/m	Margin dB	Detector	Comment
1 *	192.4750	48.70	-14.06	34.64	43.50	-8.86	Peak	
2	220.1200	48.48	-14.25	34.23	46.00	-11.77	Peak	
3	250.1900	41.66	-14.20	27.46	46.00	-18.54	Peak	
4	374.8350	35.02	-9.51	25.51	46.00	-20.49	Peak	
5	499.9650	39.93	-9.72	30.21	46.00	-15.79	Peak	
6	599.8750	36.86	-7.05	29.81	46.00	-16.19	Peak	

Test Mode: UNII-1/TX A Mode 5240MHz

Horizontal

80 dBuV/m

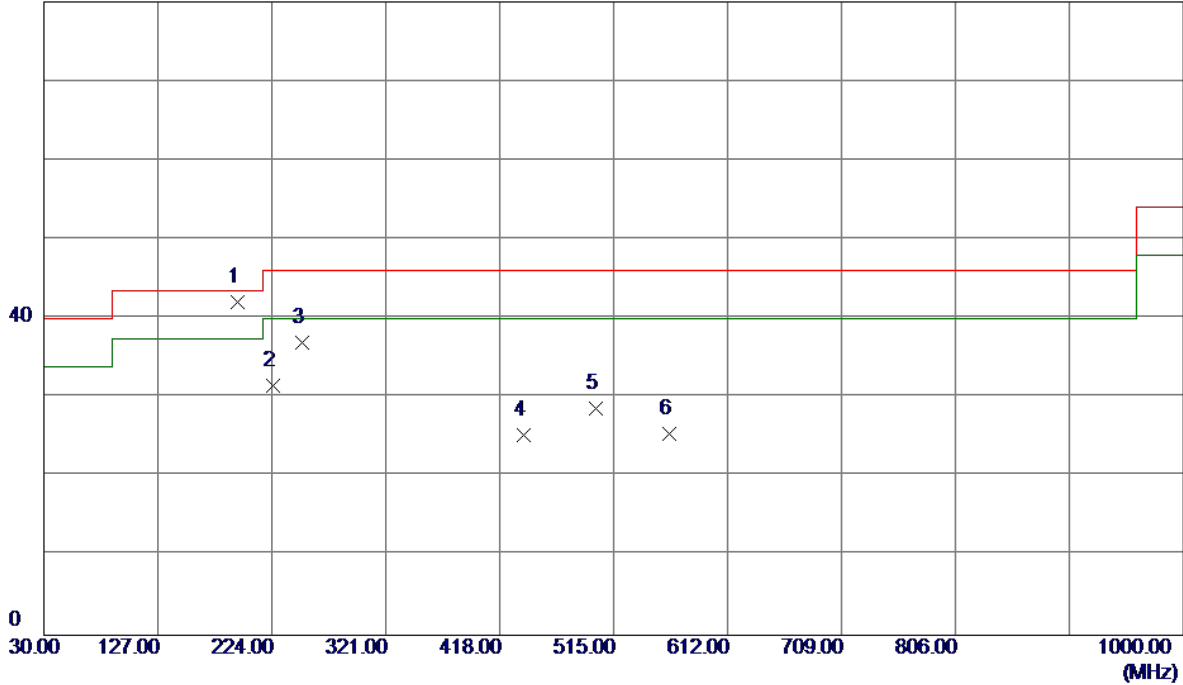

No.	Freq. MHz	Reading Level dBuV/m	Correct Factor dB	Measure ment dBuV/m	Limit dBuV/m	Margin dB	Detector	Comment
1 *	194.9000	56.25	-14.18	42.07	43.50	-1.43	QP	
2	224.9700	45.33	-13.82	31.51	46.00	-14.49	Peak	
3	250.1900	51.12	-14.20	36.92	46.00	-9.08	Peak	
4	438.3700	33.26	-7.95	25.31	46.00	-20.69	Peak	
5	499.9650	38.32	-9.72	28.60	46.00	-17.40	Peak	
6	562.0450	30.53	-5.15	25.38	46.00	-20.62	Peak	

Test Mode: UNII-3/TX A Mode 5745MHz

Vertical

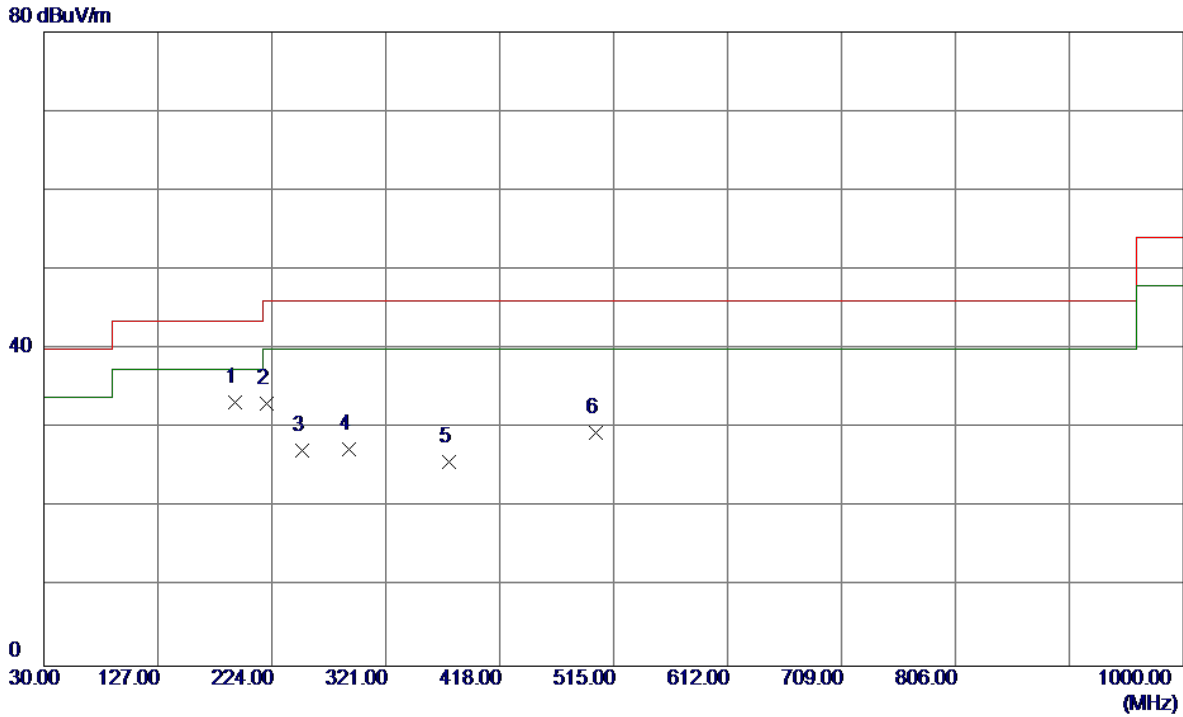

No.	Freq. MHz	Reading Level dBuV/m	Correct Factor dB	Measure ment dBuV/m	Limit dBuV/m	Margin dB	Detector	Comment
1 *	192.4750	47.34	-14.06	33.28	43.50	-10.22	Peak	
2	220.1200	47.35	-14.25	33.10	46.00	-12.90	Peak	
3	250.1900	41.33	-14.20	27.13	46.00	-18.87	Peak	
4	289.9600	38.57	-11.25	27.32	46.00	-18.68	Peak	
5	374.8350	35.25	-9.51	25.74	46.00	-20.26	Peak	
6	499.9650	39.22	-9.72	29.50	46.00	-16.50	Peak	

Test Mode: UNII-3/TX A Mode 5745MHz

Horizontal

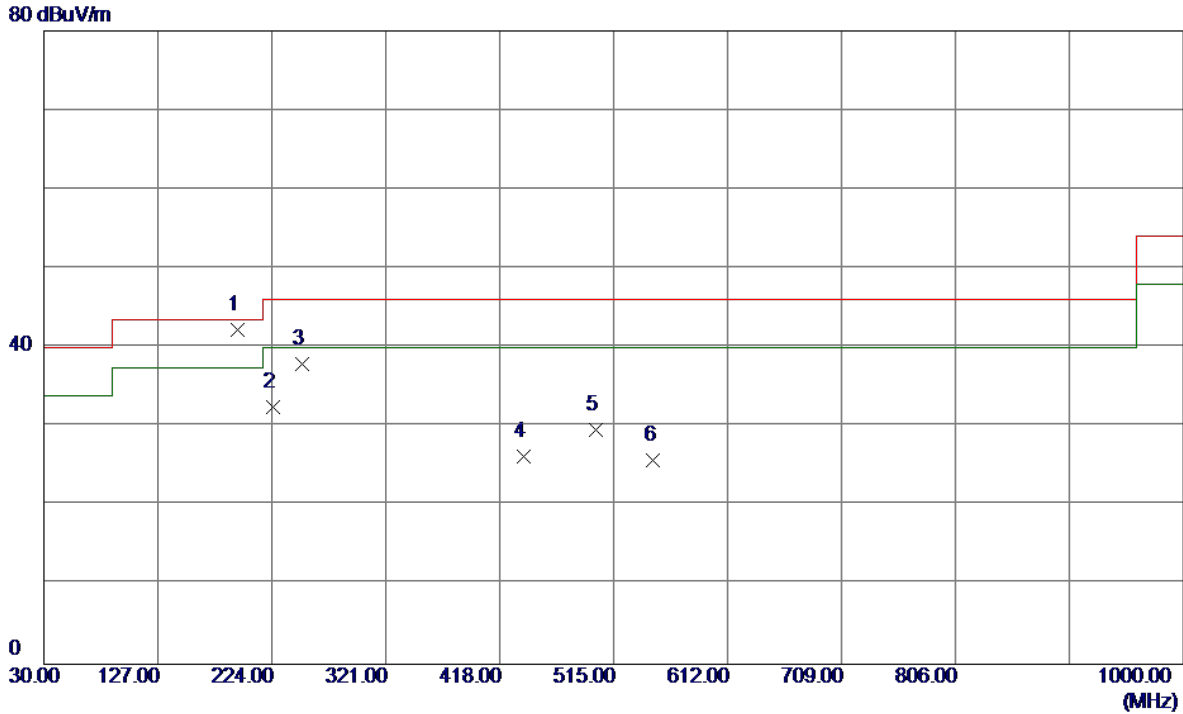

No.	Freq. MHz	Reading Level dBuV/m	Correct Factor dB	Measure ment dBuV/m	Limit dBuV/m	Margin dB	Detector	Comment
1 *	194.9000	56.41	-14.18	42.23	43.50	-1.27	QP	
2	224.9700	46.33	-13.82	32.51	46.00	-13.49	Peak	
3	250.1900	52.12	-14.20	37.92	46.00	-8.08	Peak	
4	438.3700	34.26	-7.95	26.31	46.00	-19.69	Peak	
5	499.9650	39.32	-9.72	29.60	46.00	-16.40	Peak	
6	548.9500	30.47	-4.65	25.82	46.00	-20.18	Peak	

Test Mode: UNII-3/TX A Mode 5785MHz

Vertical

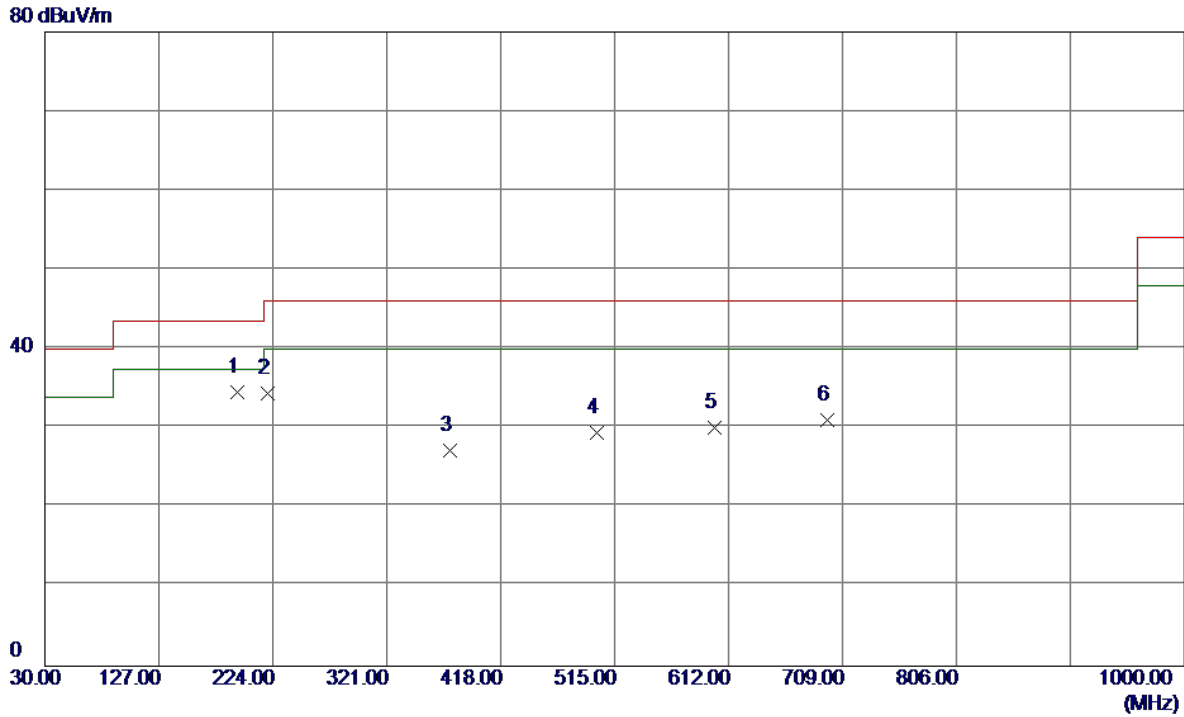

No.	Freq. MHz	Reading Level dBuV/m	Correct Factor dB	Measure ment dBuV/m	Limit dBuV/m	Margin dB	Detector	Comment
1 *	193.4450	48.61	-14.10	34.51	43.50	-8.99	Peak	
2	220.1200	48.67	-14.25	34.42	46.00	-11.58	Peak	
3	374.8350	36.72	-9.51	27.21	46.00	-18.79	Peak	
4	499.9650	39.15	-9.72	29.43	46.00	-16.57	Peak	
5	599.8750	37.16	-7.05	30.11	46.00	-15.89	Peak	
6	696.3900	33.34	-2.25	31.09	46.00	-14.91	Peak	

Test Mode: UNII-3/TX A Mode 5785MHz

Horizontal

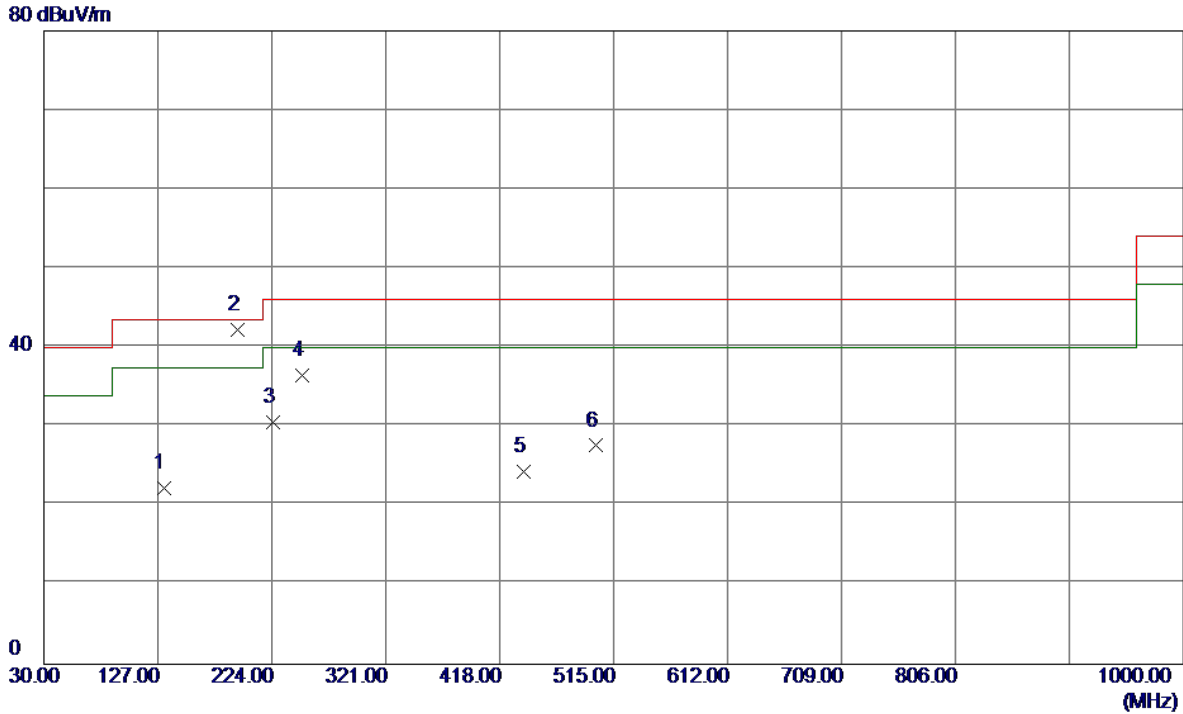

No.	Freq. MHz	Reading Level dBuV/m	Correct Factor dB	Measure ment dBuV/m	Limit dBuV/m	Margin dB	Detector	Comment
1	131.8500	34.89	-12.61	22.28	43.50	-21.22	Peak	
2 *	194.9000	56.43	-14.18	42.25	43.50	-1.25	QP	
3	224.9700	44.33	-13.82	30.51	46.00	-15.49	Peak	
4	250.1900	50.62	-14.20	36.42	46.00	-9.58	Peak	
5	438.3700	32.26	-7.95	24.31	46.00	-21.69	Peak	
6	499.9650	37.32	-9.72	27.60	46.00	-18.40	Peak	

Test Mode: UNII-3/TX A Mode 5825MHz

Vertical

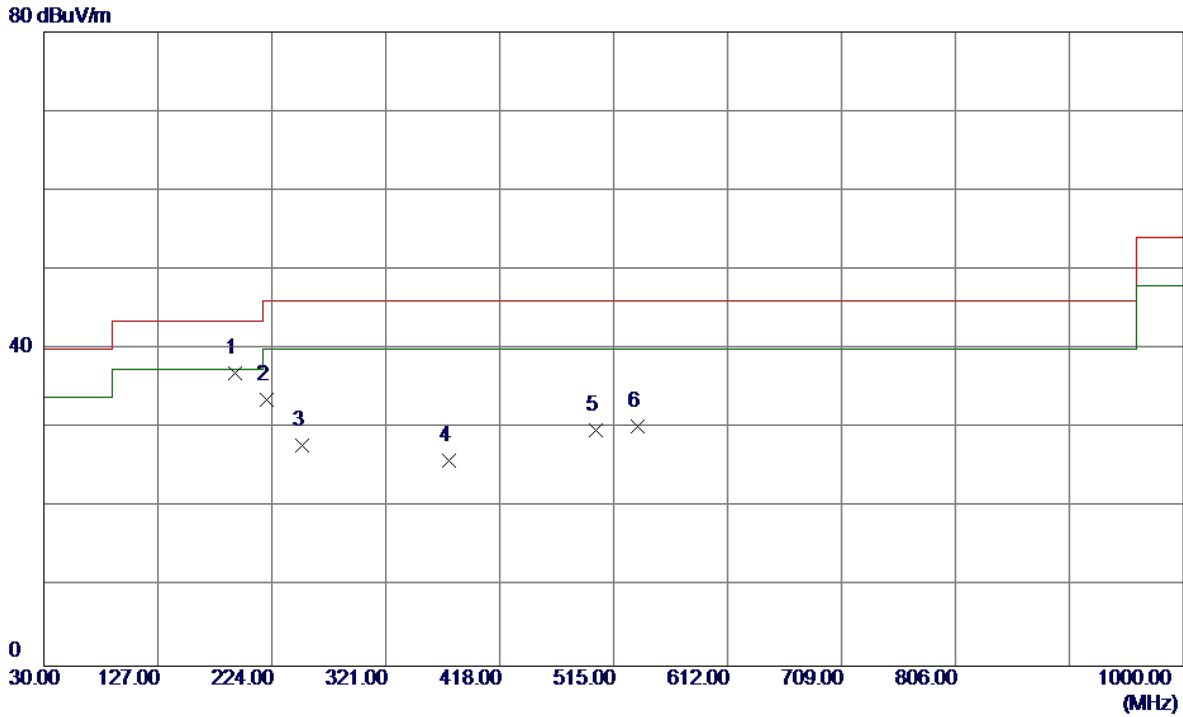

No.	Freq. MHz	Reading Level dBuV/m	Correct Factor dB	Measure ment dBuV/m	Limit dBuV/m	Margin dB	Detector	Comment
1 *	192.4750	51.08	-14.06	37.02	43.50	-6.48	Peak	
2	220.1200	47.89	-14.25	33.64	46.00	-12.36	Peak	
3	250.1900	42.01	-14.20	27.81	46.00	-18.19	Peak	
4	374.8350	35.43	-9.51	25.92	46.00	-20.08	Peak	
5	499.9650	39.42	-9.72	29.70	46.00	-16.30	Peak	
6	535.8550	36.19	-6.01	30.18	46.00	-15.82	Peak	

Test Mode: UNII-3/TX A Mode 5825MHz

Horizontal

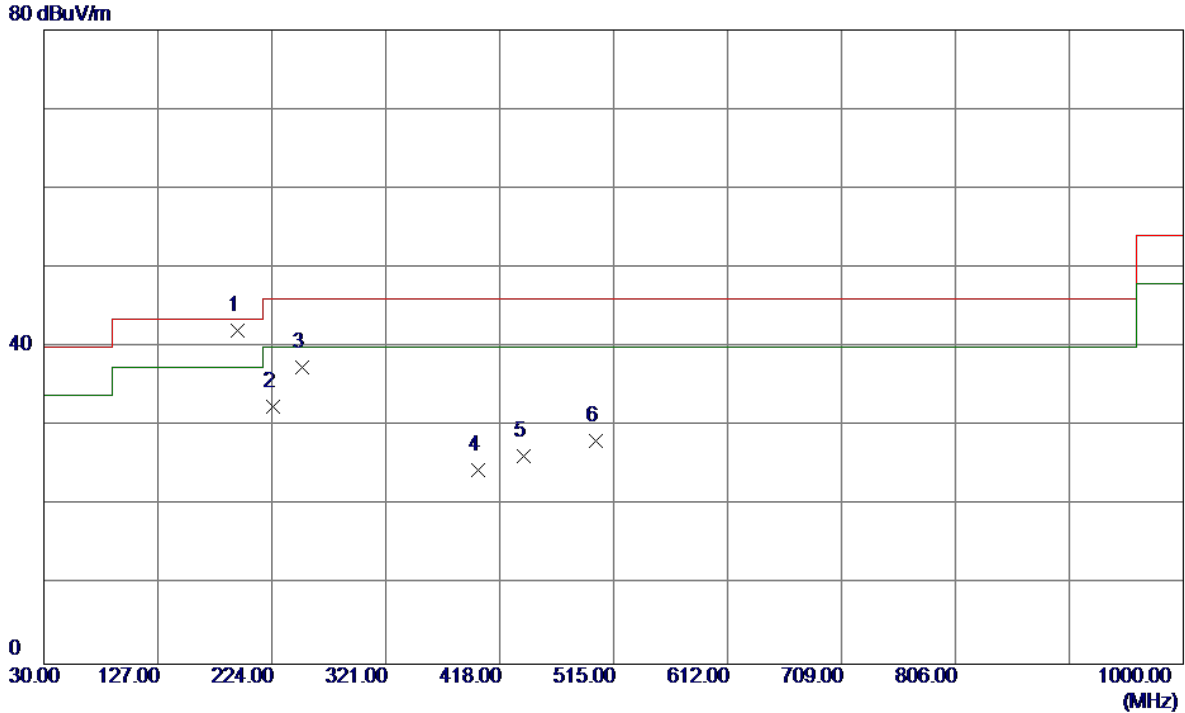

No.	Freq. MHz	Reading Level dBuV/m	Correct Factor dB	Measure ment dBuV/m	Limit dBuV/m	Margin dB	Detector	Comment
1 *	194.9000	56.29	-14.18	42.11	43.50	-1.39	QP	
2	224.9700	46.33	-13.82	32.51	46.00	-13.49	Peak	
3	250.1900	51.62	-14.20	37.42	46.00	-8.58	Peak	
4	400.0550	32.28	-7.78	24.50	46.00	-21.50	Peak	
5	438.3700	34.26	-7.95	26.31	46.00	-19.69	Peak	
6	499.9650	37.82	-9.72	28.10	46.00	-17.90	Peak	

ATTACHMENT D - RADIATED EMISSION (ABOVE 1000MHZ)

Orthogonal Axis:	X
Test Mode:	UNII-1/ TX A Mode 5180MHz

Vertical

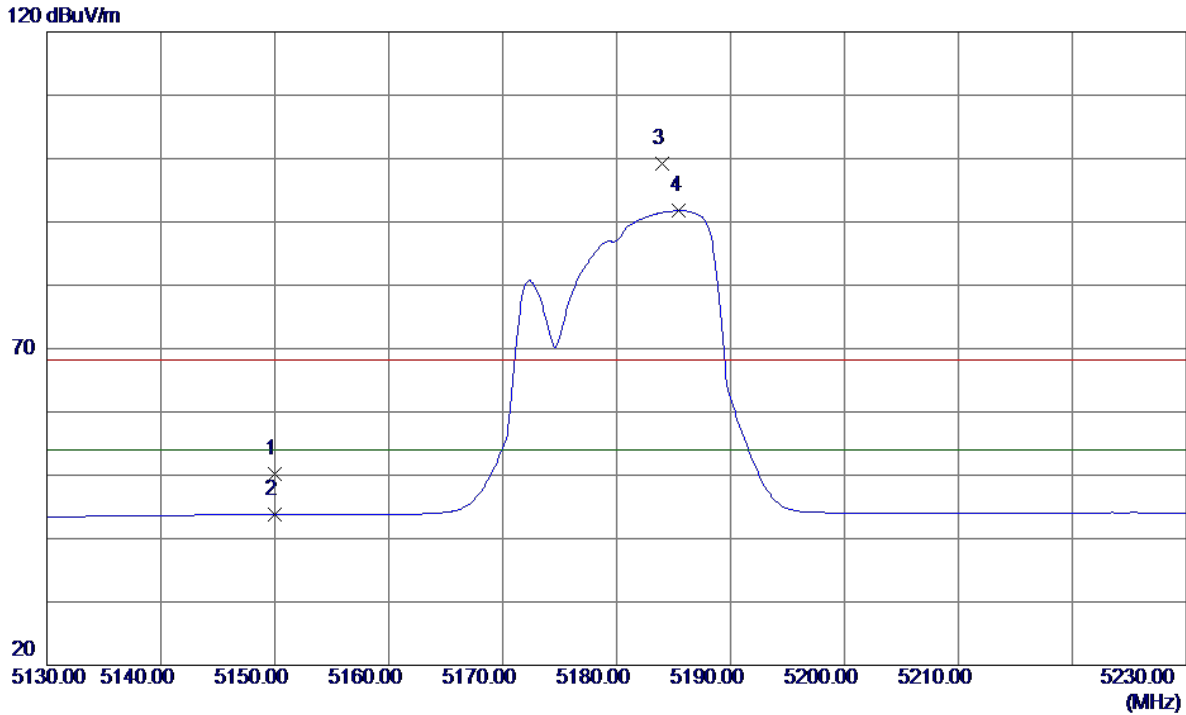

No.	Freq. MHz	Reading Level dBuV/m	Correct Factor dB	Measure ment dBuV/m	Limit dBuV/m	Margin dB	Detector	Comment
1	5150.0000	8.85	41.35	50.20	68.30	-18.10	Peak	
2	5150.0000	2.39	41.35	43.74	54.00	-10.26	AVG	
3	5184.0000	57.72	41.46	99.18	68.30	30.88	Peak	No Limit
4 *	5185.5000	50.27	41.47	91.74	54.00	37.74	AVG	No Limit

Orthogonal Axis:	X
Test Mode:	UNII-1/ TX A Mode 5180MHz

Vertical

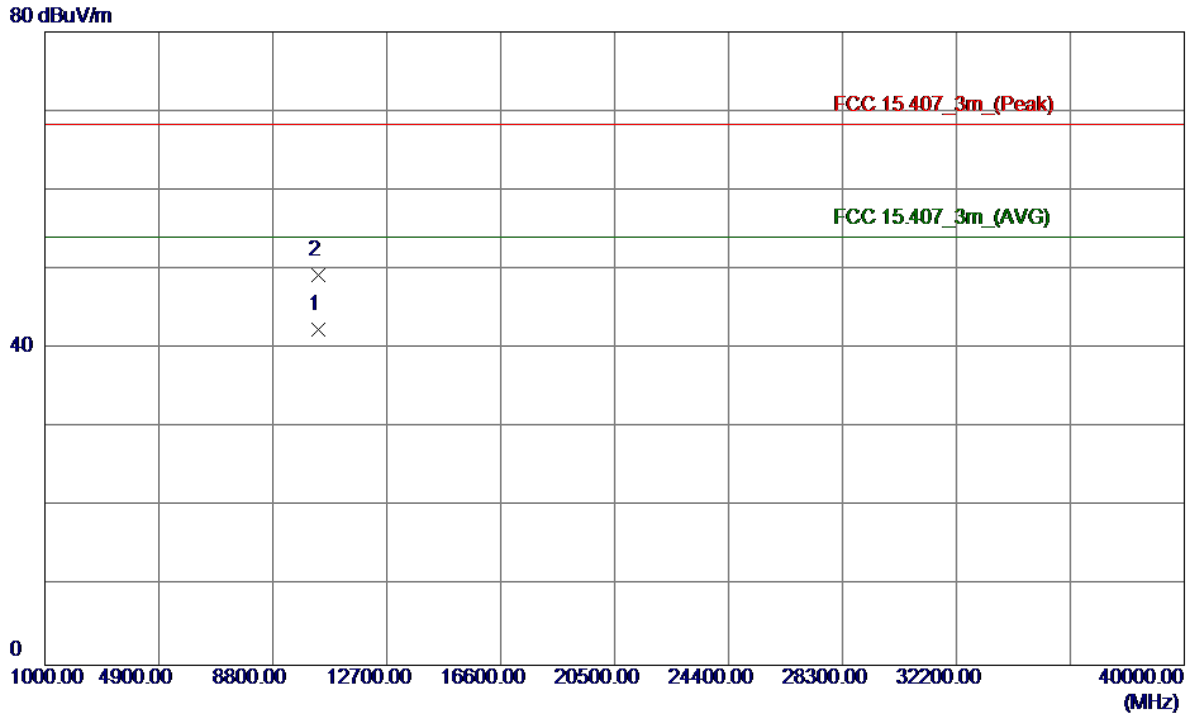

No.	Freq. MHz	Reading Level dBuV/m	Correct Factor dB	Measure ment dBuV/m	Limit dBuV/m	Margin dB	Detector	Comment
1	10360.0050	26.01	16.36	42.37	68.30	-25.93	Peak	
2 *	10360.0750	32.91	16.36	49.27	68.30	-19.03	Peak	

Orthogonal Axis:	X
Test Mode:	UNII-1/ TX A Mode 5180MHz

Horizontal

120 dBuV/m

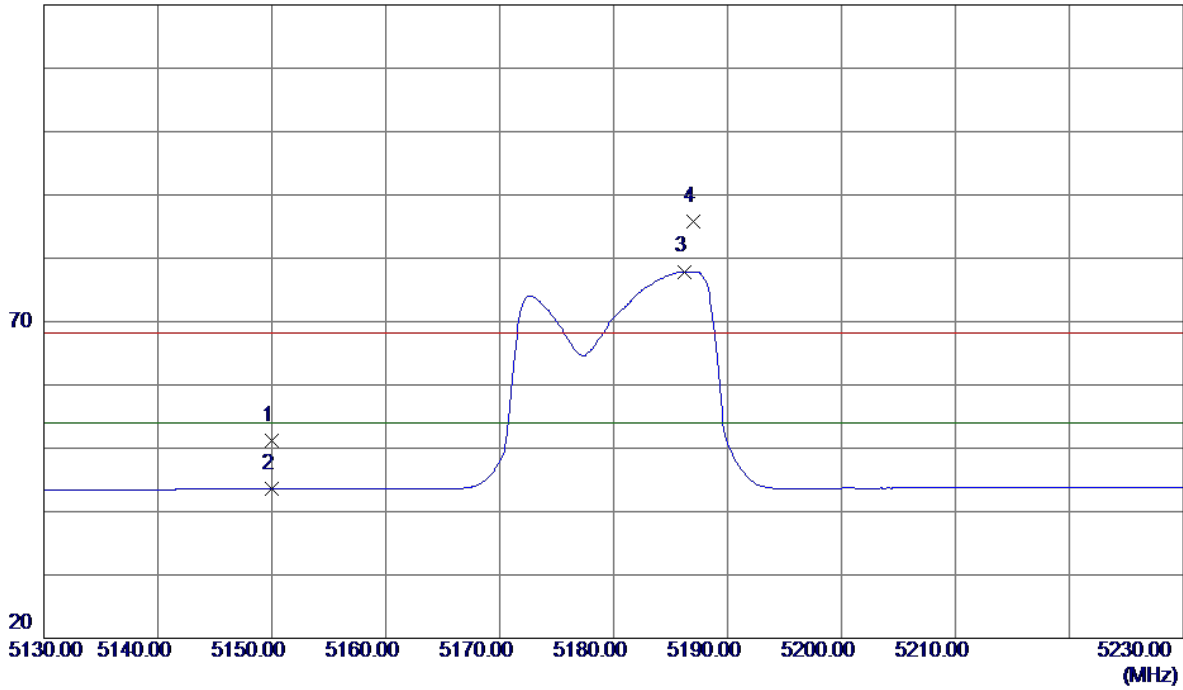

No.	Freq. MHz	Reading Level dBuV/m	Correct Factor dB	Measure ment dBuV/m	Limit dBuV/m	Margin dB	Detector	Comment
1	5150.0000	9.92	41.35	51.27	68.30	-17.03	Peak	
2	5150.0000	2.22	41.35	43.57	54.00	-10.43	AVG	
3 *	5186.2000	36.43	41.47	77.90	54.00	23.90	AVG	No Limit
4	5187.0000	44.28	41.47	85.75	68.30	17.45	Peak	No Limit

Orthogonal Axis:	X
Test Mode:	UNII-1/ TX A Mode 5180MHz

Horizontal

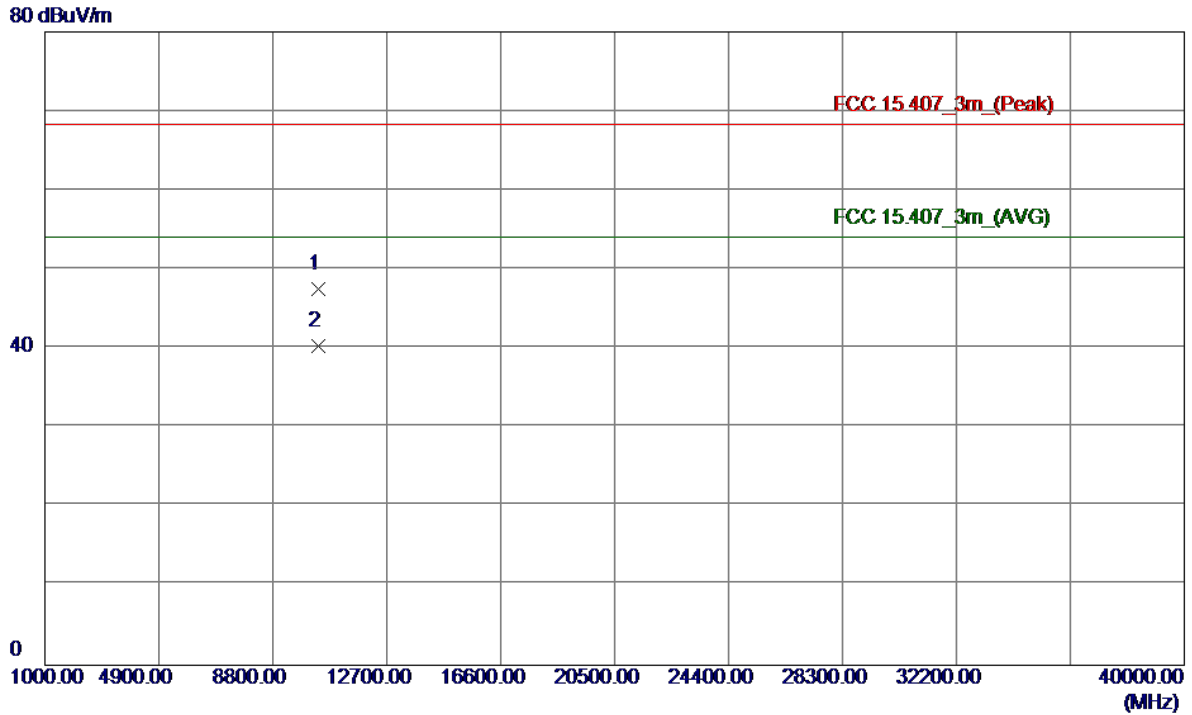

No.	Freq. MHz	Reading Level dBuV/m	Correct Factor dB	Measure ment dBuV/m	Limit dBuV/m	Margin dB	Detector	Comment
1	10360.0750	31.16	16.36	47.52	68.30	-20.78	Peak	
2 *	10360.1750	23.98	16.36	40.34	54.00	-13.66	AVG	

Orthogonal Axis:	X
Test Mode:	UNII-1/ TX A Mode 5200MHz

Vertical

120 dBuV/m

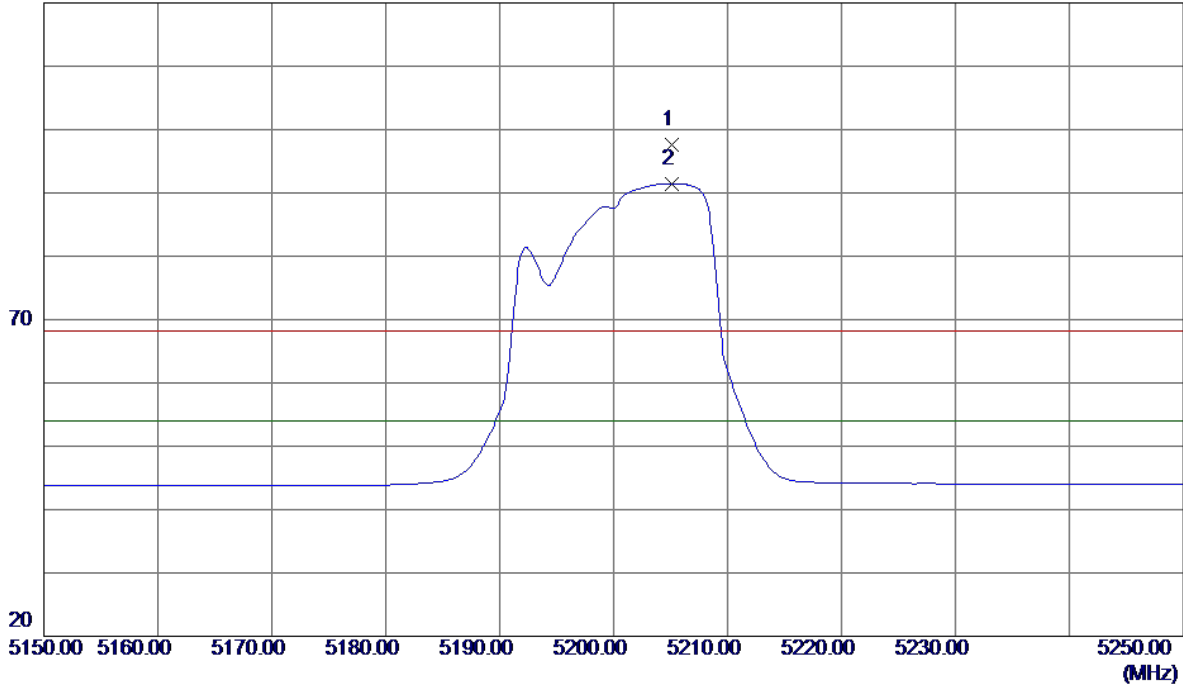

No.	Freq. MHz	Reading Level dBuV/m	Correct Factor dB	Measure ment dBuV/m	Limit dBuV/m	Margin dB	Detector	Comment
1	5205.1000	56.00	41.53	97.53	68.30	29.23	Peak	No Limit
2 *	5205.1000	49.95	41.53	91.48	54.00	37.48	AVG	No Limit

Orthogonal Axis:	X
Test Mode:	UNII-1/ TX A Mode 5200MHz

Vertical

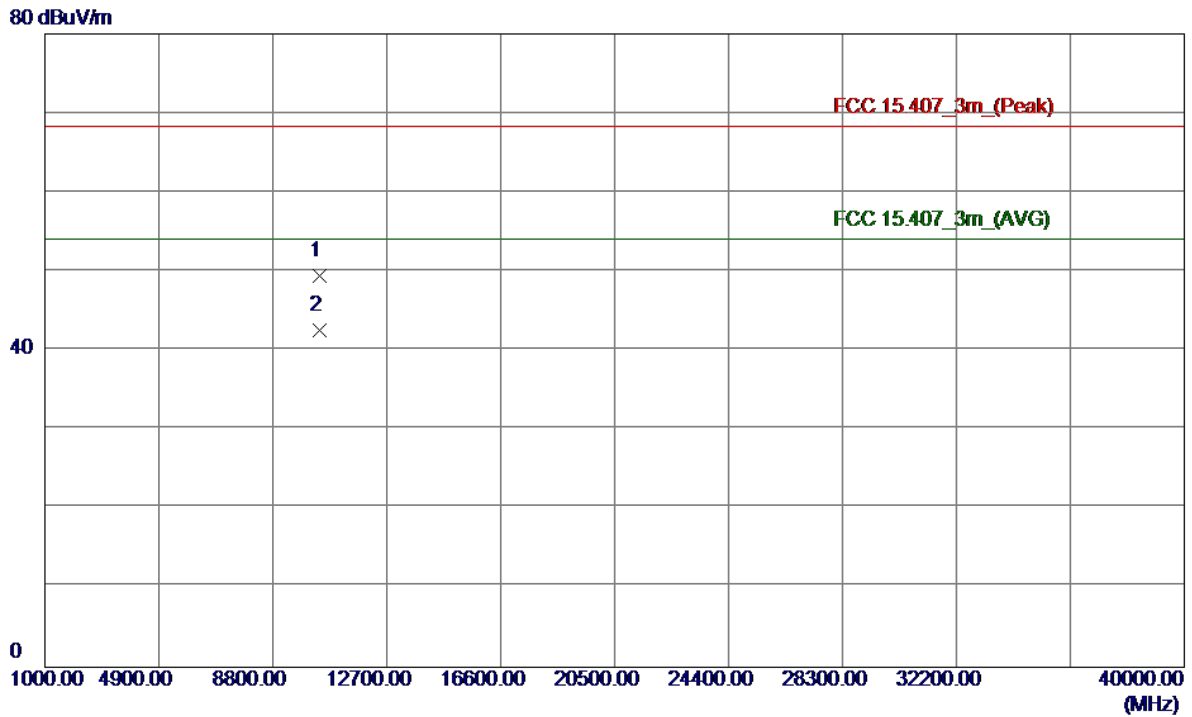

No.	Freq. MHz	Reading Level dBuV/m	Correct Factor dB	Measure ment dBuV/m	Limit dBuV/m	Margin dB	Detector	Comment
1	10400.0150	32.97	16.45	49.42	68.30	-18.88	Peak	
2 *	10400.0050	26.11	16.45	42.56	54.00	-11.44	AVG	

Orthogonal Axis:	X
Test Mode:	UNII-1/ TX A Mode 5200MHz

Horizontal

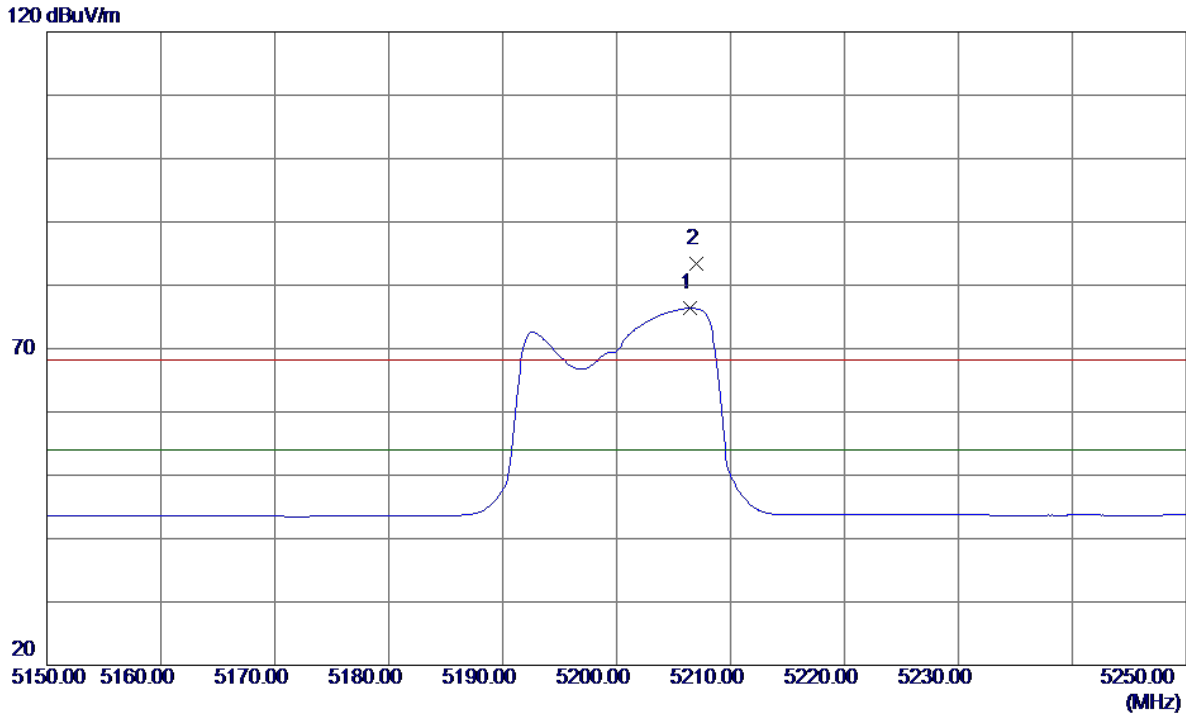

No.	Freq. MHz	Reading Level dBuV/m	Correct Factor dB	Measure ment dBuV/m	Limit dBuV/m	Margin dB	Detector	Comment
1 *	5206.4000	34.83	41.54	76.37	54.00	22.37	AVG	No Limit
2	5207.0000	41.84	41.54	83.38	68.30	15.08	Peak	No Limit

Orthogonal Axis:	X
Test Mode:	UNII-1/ TX A Mode 5200MHz

Horizontal

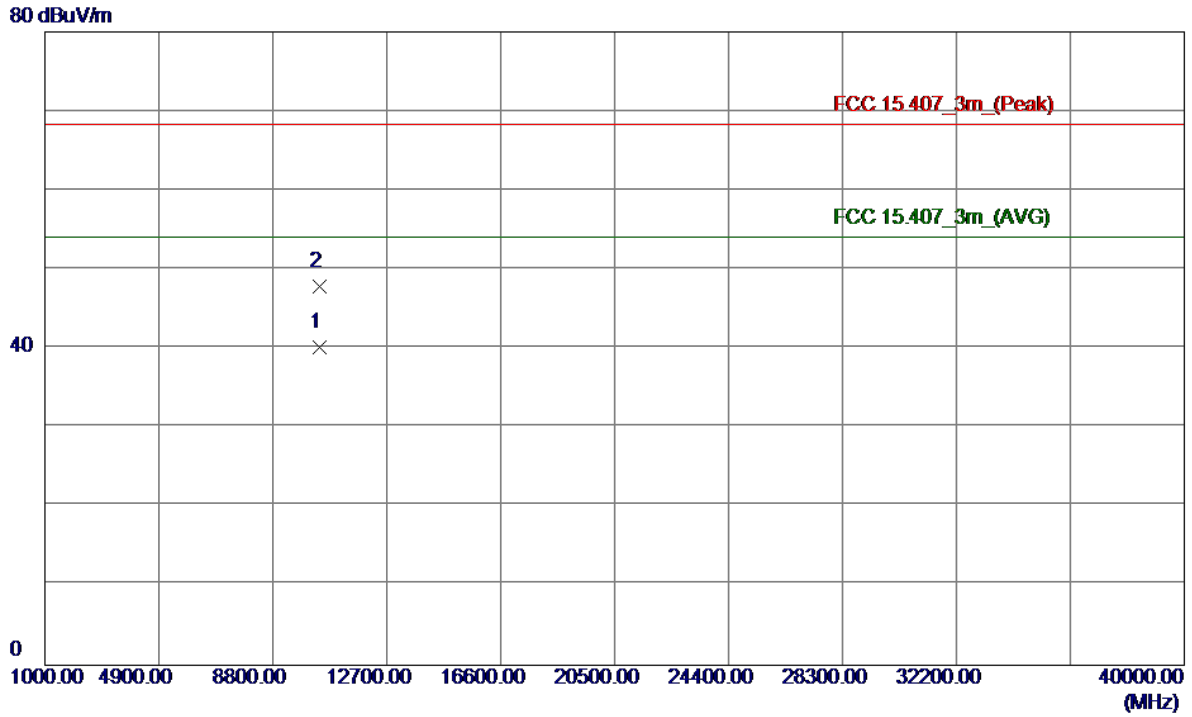

No.	Freq. MHz	Reading Level dBuV/m	Correct Factor dB	Measure ment dBuV/m	Limit dBuV/m	Margin dB	Detector	Comment
1 *	10400.0050	23.65	16.45	40.10	54.00	-13.90	AVG	
2	10400.0250	31.41	16.45	47.86	68.30	-20.44	Peak	

Orthogonal Axis:	X
Test Mode:	UNII-1/ TX A Mode 5240MHz

Vertical

120 dBuV/m

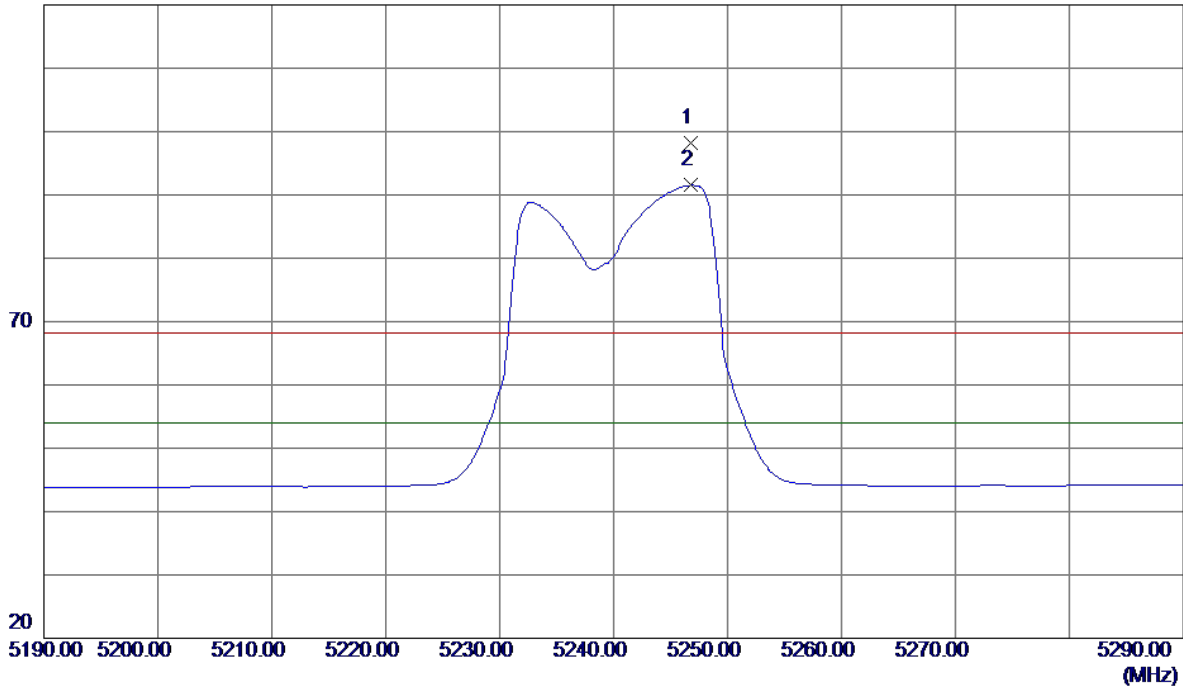

No.	Freq. MHz	Reading Level dBuV/m	Correct Factor dB	Measure ment dBuV/m	Limit dBuV/m	Margin dB	Detector	Comment
1	5246.8000	56.61	41.67	98.28	68.30	29.98	Peak	No Limit
2 *	5246.8000	49.84	41.67	91.51	54.00	37.51	AVG	No Limit

Orthogonal Axis:	X
Test Mode:	UNII-1/ TX A Mode 5240MHz

Vertical

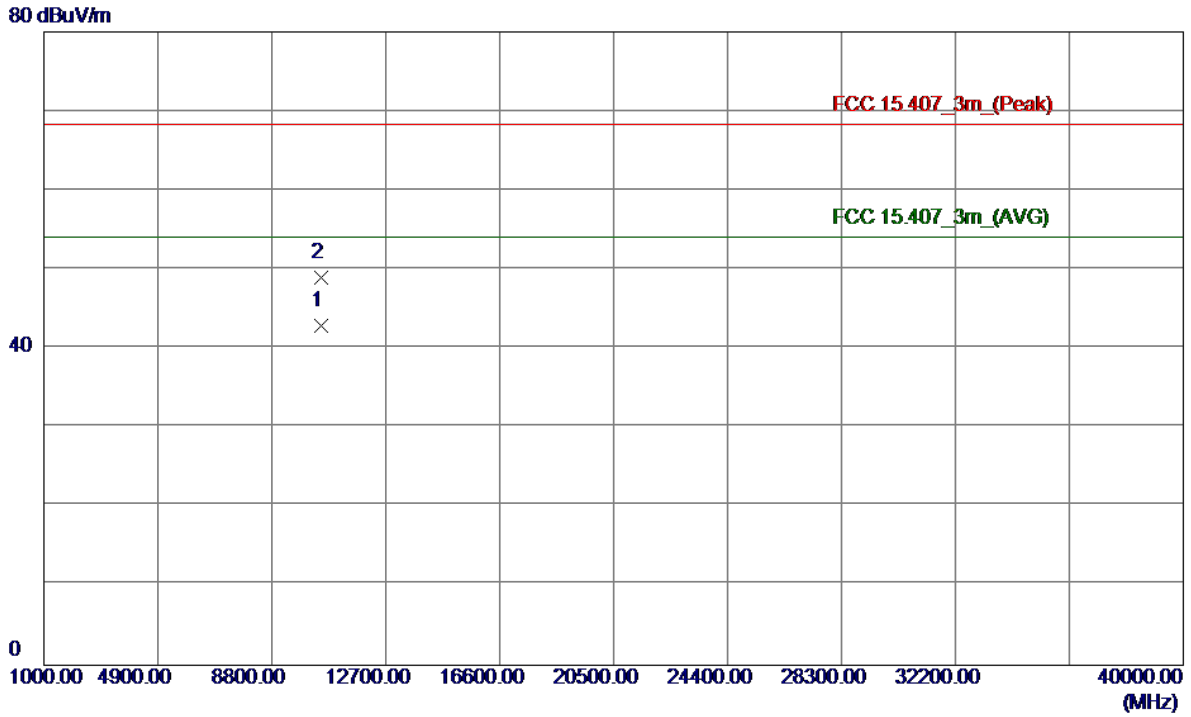

No.	Freq. MHz	Reading Level dBuV/m	Correct Factor dB	Measure ment dBuV/m	Limit dBuV/m	Margin dB	Detector	Comment
1 *	10480.0250	26.19	16.63	42.82	54.00	-11.18	AVG	
2	10480.1750	32.40	16.63	49.03	68.30	-19.27	Peak	

Orthogonal Axis:	X
Test Mode:	UNII-1/ TX A Mode 5240MHz

Horizontal

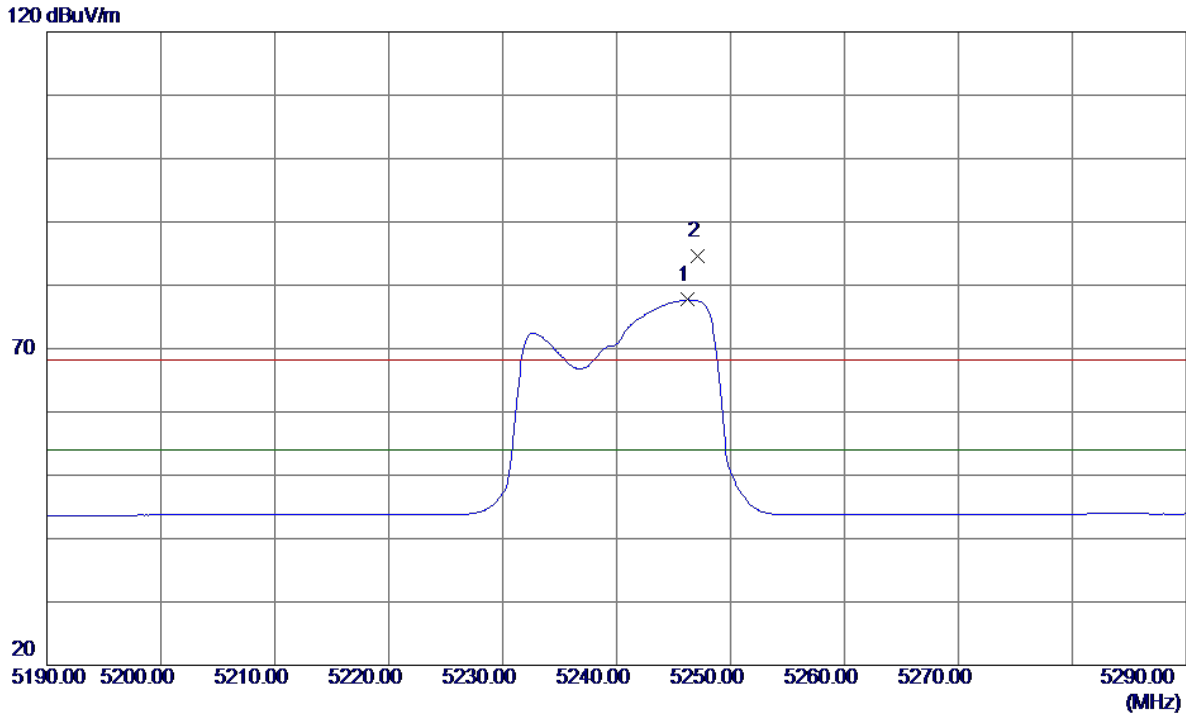

No.	Freq. MHz	Reading Level dBuV/m	Correct Factor dB	Measure ment dBuV/m	Limit dBuV/m	Margin dB	Detector	Comment
1 *	5246.2000	36.03	41.67	77.70	54.00	23.70	AVG	No Limit
2	5247.1000	42.92	41.68	84.60	68.30	16.30	Peak	No Limit

Orthogonal Axis:	X
Test Mode:	UNII-1/ TX A Mode 5240MHz

Horizontal

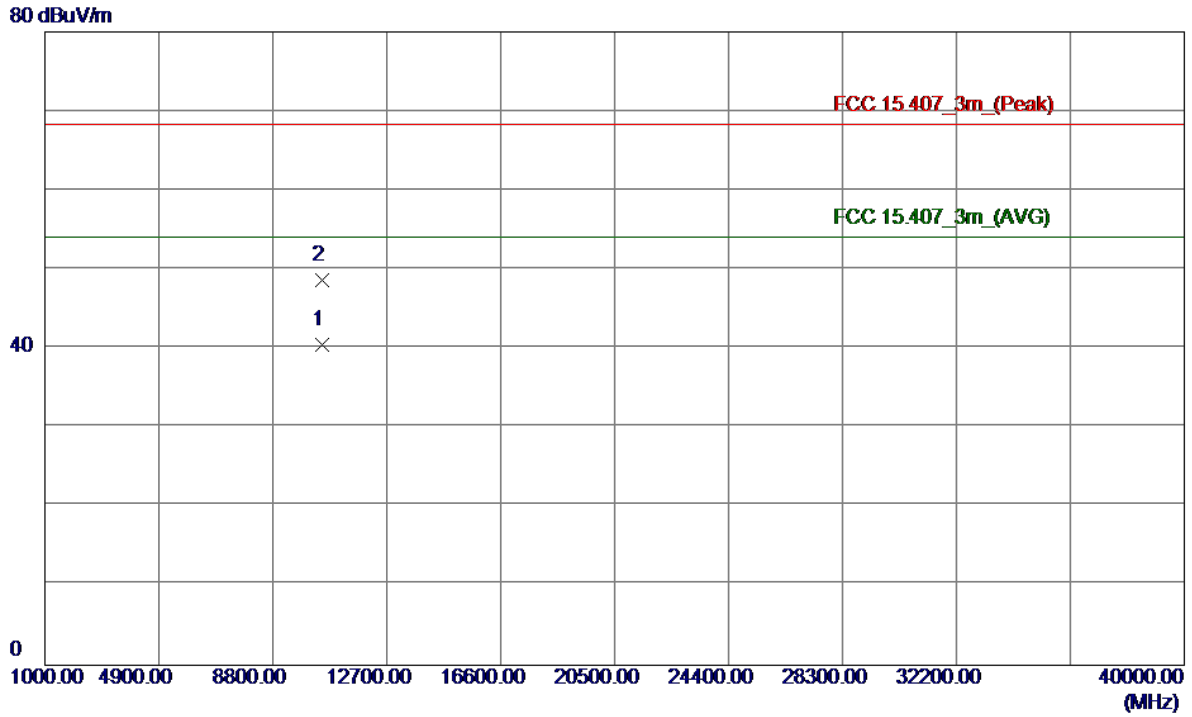

No.	Freq. MHz	Reading Level dBuV/m	Correct Factor dB	Measure ment dBuV/m	Limit dBuV/m	Margin dB	Detector	Comment
1 *	10480.0000	23.83	16.63	40.46	54.00	-13.54	AVG	
2	10480.1250	31.99	16.63	48.62	68.30	-19.68	Peak	

Orthogonal Axis:	X
Test Mode:	UNII-1/ TX N20 Mode 5180MHz

Vertical

120 dBuV/m

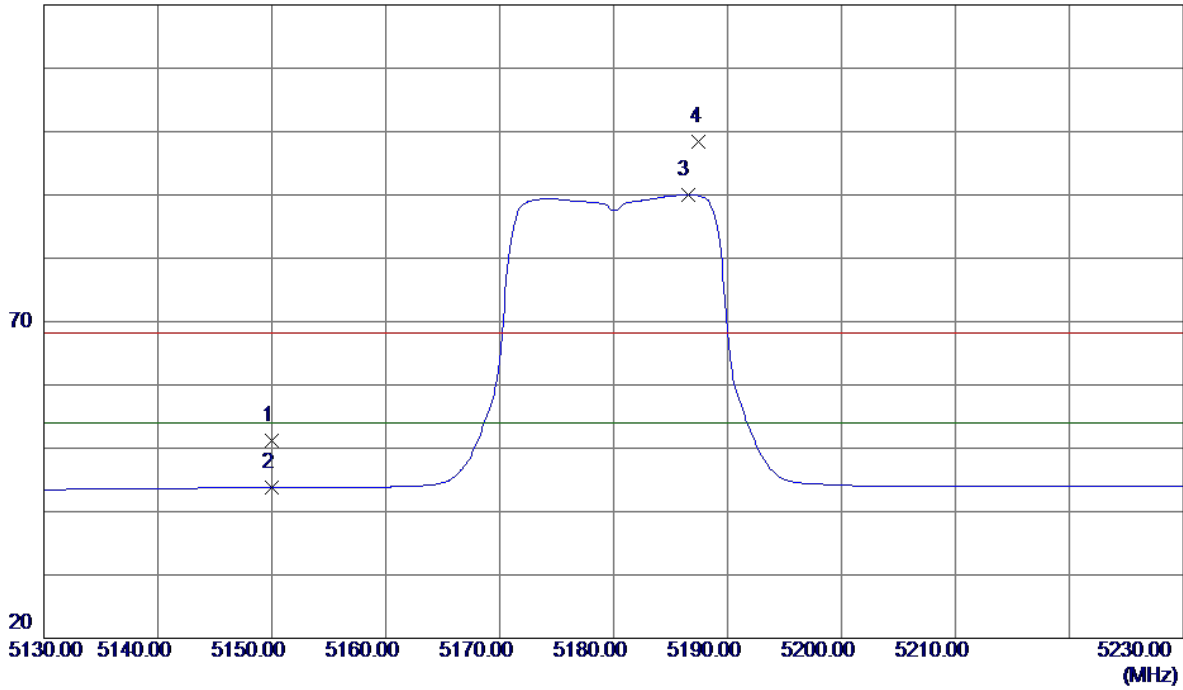

No.	Freq. MHz	Reading Level dBuV/m	Correct Factor dB	Measure ment dBuV/m	Limit dBuV/m	Margin dB	Detector	Comment
1	5150.0000	9.78	41.35	51.13	68.30	-17.17	Peak	
2	5150.0000	2.40	41.35	43.75	54.00	-10.25	AVG	
3 *	5186.5000	48.55	41.47	90.02	54.00	36.02	AVG	No Limit
4	5187.5000	56.89	41.47	98.36	68.30	30.06	Peak	No Limit

Orthogonal Axis:	X
Test Mode:	UNII-1/ TX N20 Mode 5180MHz

Vertical

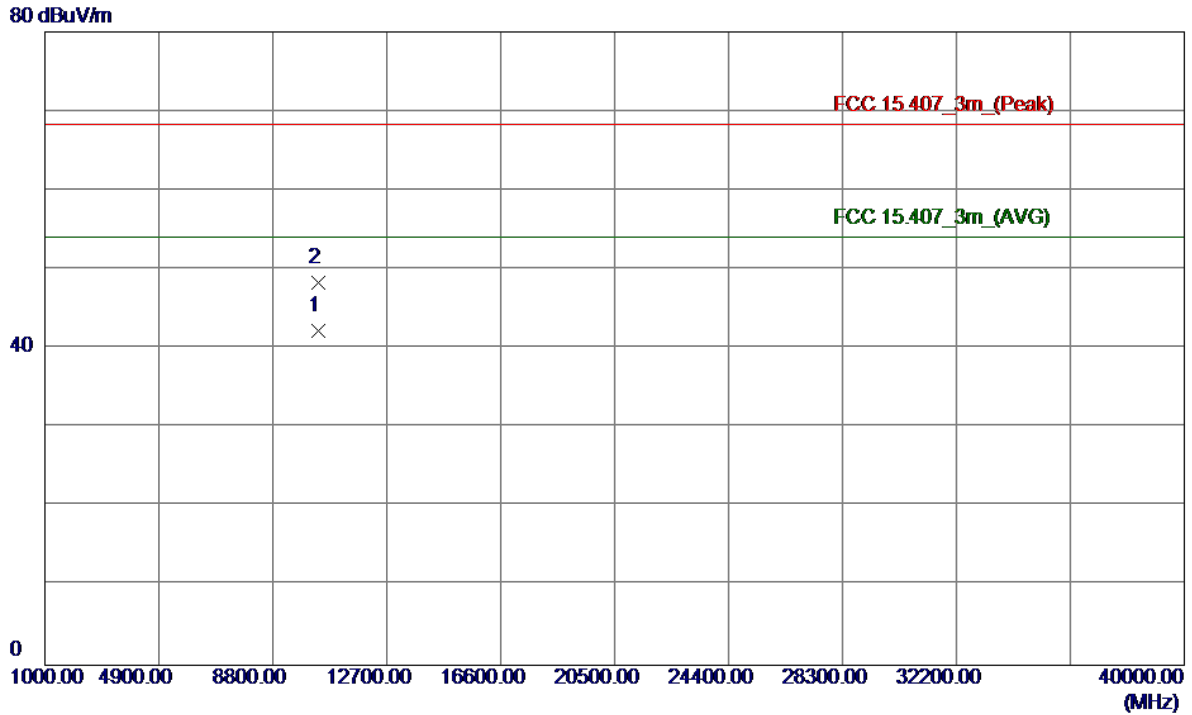

No.	Freq. MHz	Reading Level dBuV/m	Correct Factor dB	Measure ment dBuV/m	Limit dBuV/m	Margin dB	Detector	Comment
1 *	10360.1300	25.92	16.36	42.28	54.00	-11.72	AVG	
2	10360.3250	32.01	16.36	48.37	68.30	-19.93	Peak	

Orthogonal Axis:	X
Test Mode:	UNII-1/ TX N20 Mode 5180MHz

Horizontal

120 dBuV/m

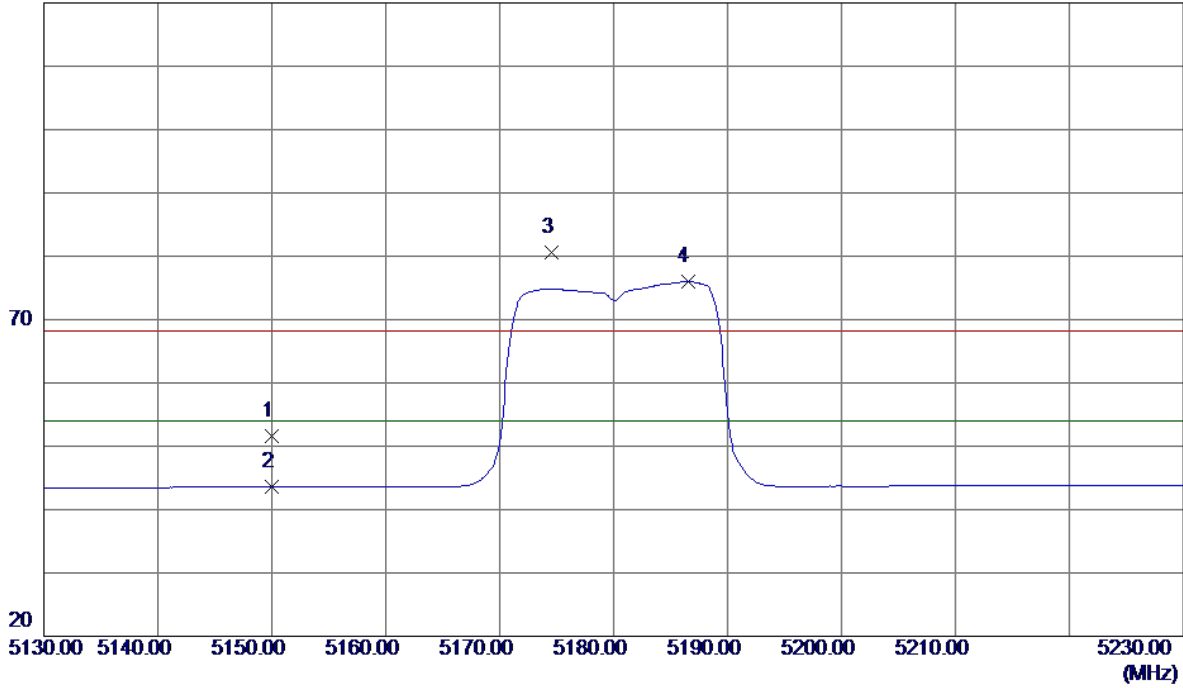

No.	Freq. MHz	Reading Level dBuV/m	Correct Factor dB	Measure ment dBuV/m	Limit dBuV/m	Margin dB	Detector	Comment
1	5150.0000	10.18	41.35	51.53	68.30	-16.77	Peak	
2	5150.0000	2.25	41.35	43.60	54.00	-10.40	AVG	
3	5174.6000	39.14	41.43	80.57	68.30	12.27	Peak	No Limit
4 *	5186.5000	34.48	41.47	75.95	54.00	21.95	AVG	No Limit

Orthogonal Axis:	X
Test Mode:	UNII-1/ TX N20 Mode 5180MHz

Horizontal

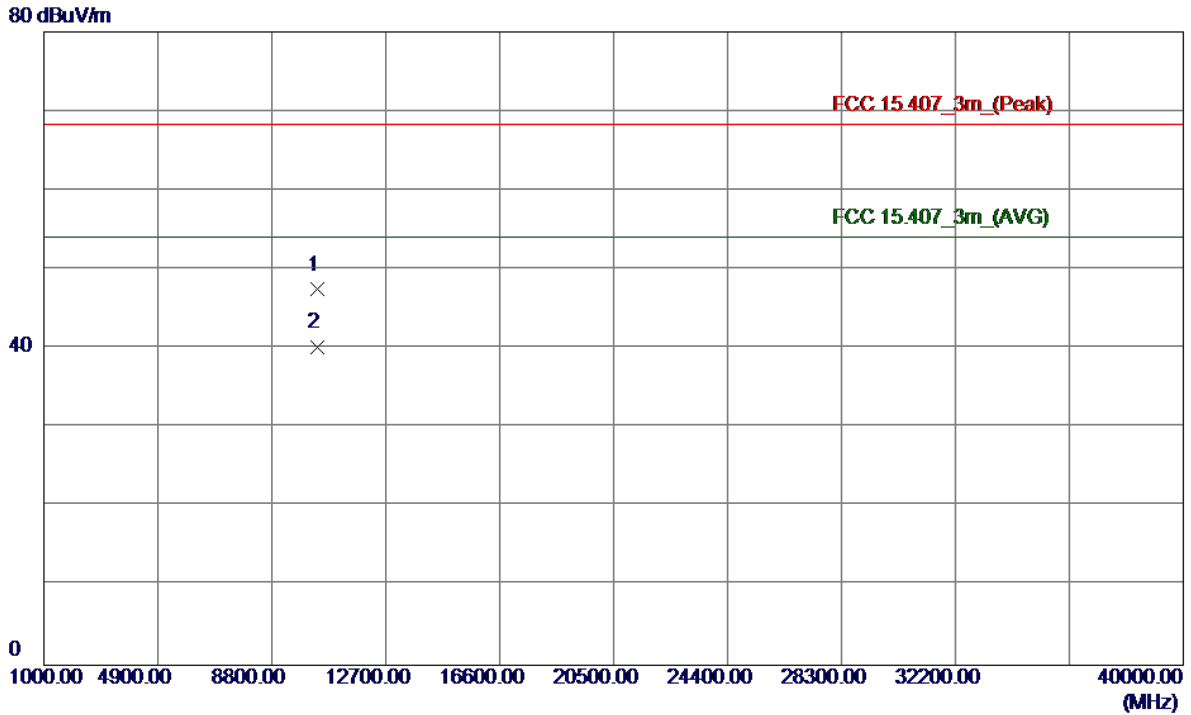

No.	Freq. MHz	Reading Level dBuV/m	Correct Factor dB	Measure ment dBuV/m	Limit dBuV/m	Margin dB	Detector	Comment
1	10360.1750	31.08	16.36	47.44	68.30	-20.86	Peak	
2 *	10360.0750	23.78	16.36	40.14	54.00	-13.86	AVG	

Orthogonal Axis:	X
Test Mode:	UNII-1/ TX N20 Mode 5200MHz

Vertical

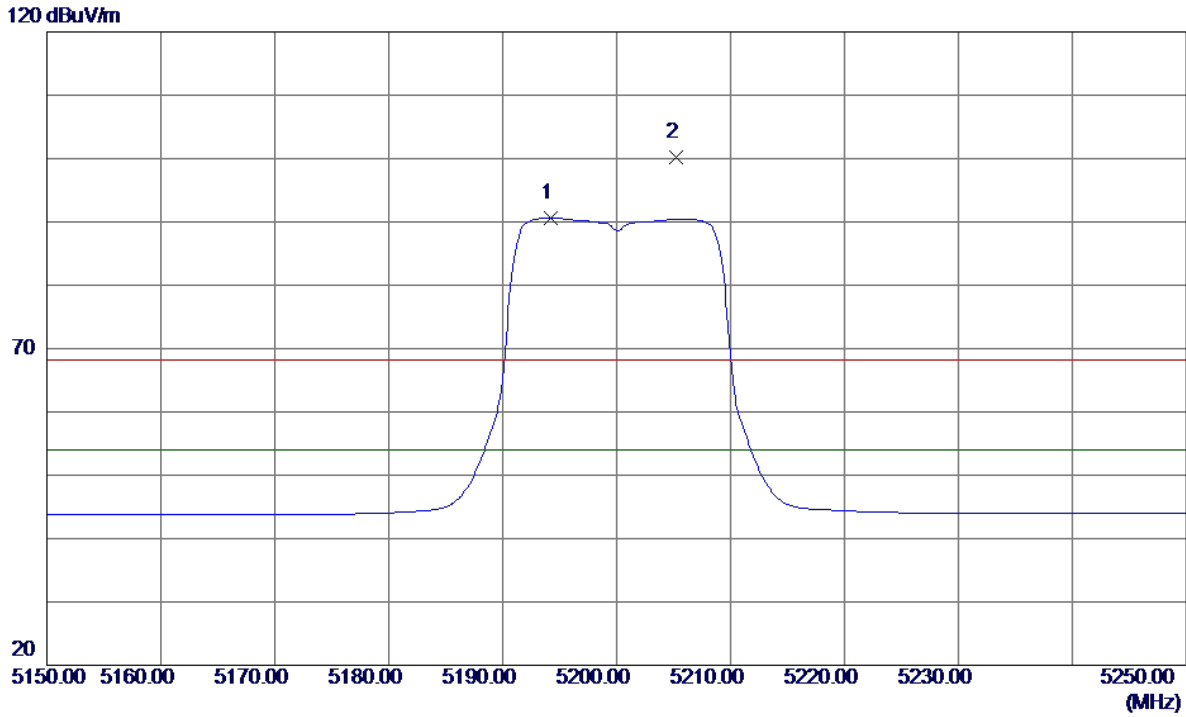

No.	Freq. MHz	Reading Level dBuV/m	Correct Factor dB	Measure ment dBuV/m	Limit dBuV/m	Margin dB	Detector	Comment
1 *	5194.2000	49.12	41.50	90.62	54.00	36.62	AVG	No Limit
2	5205.2000	58.64	41.53	100.17	68.30	31.87	Peak	No Limit

Orthogonal Axis:	X
Test Mode:	UNII-1/ TX N20 Mode 5200MHz

Vertical

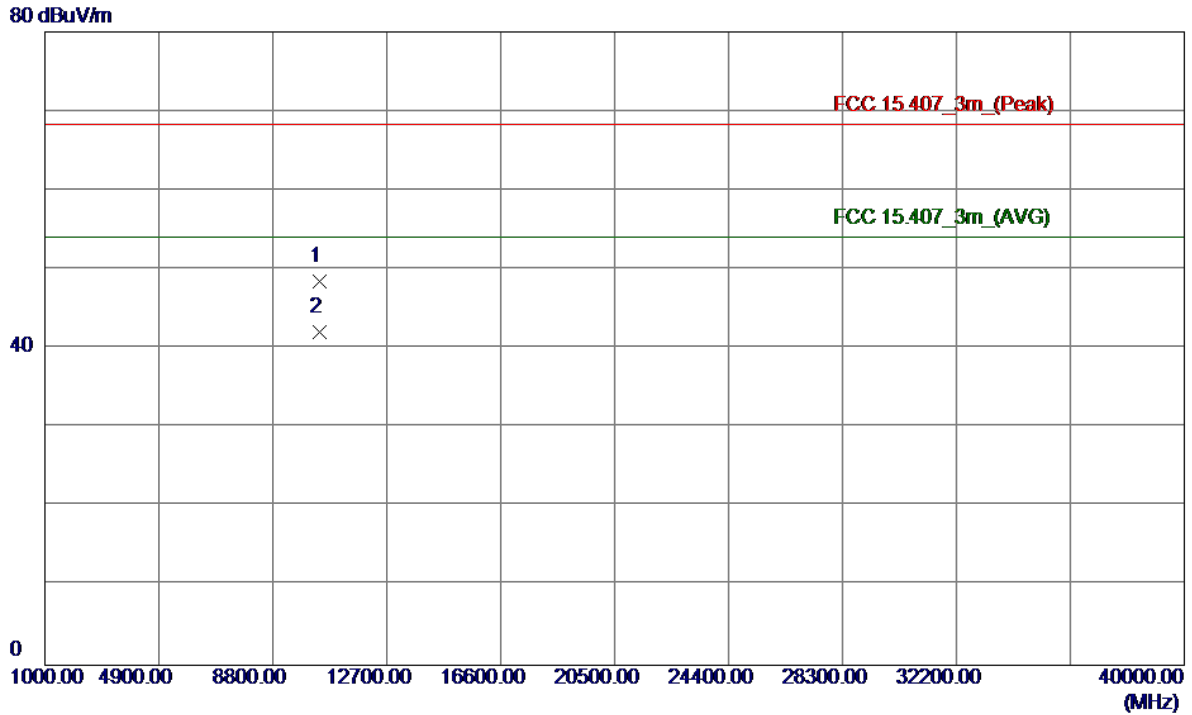

No.	Freq. MHz	Reading Level dBuV/m	Correct Factor dB	Measure ment dBuV/m	Limit dBuV/m	Margin dB	Detector	Comment
1	10400.1050	31.97	16.45	48.42	68.30	-19.88	Peak	
2 *	10400.0050	25.66	16.45	42.11	54.00	-11.89	AVG	

Orthogonal Axis:	X
Test Mode:	UNII-1/ TX N20 Mode 5200MHz

Horizontal

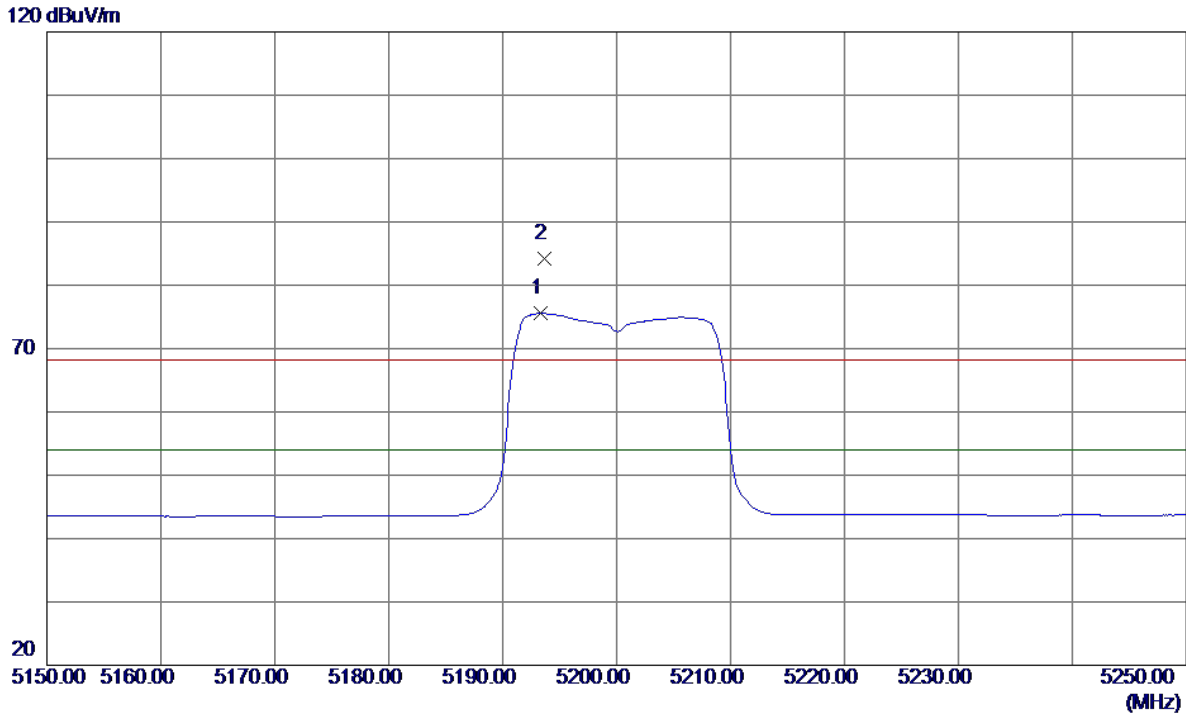

No.	Freq. MHz	Reading Level dBuV/m	Correct Factor dB	Measure ment dBuV/m	Limit dBuV/m	Margin dB	Detector	Comment
1 *	5193.3000	34.06	41.49	75.55	54.00	21.55	AVG	No Limit
2	5193.7000	42.68	41.49	84.17	68.30	15.87	Peak	No Limit

Orthogonal Axis:	X
Test Mode:	UNII-1/ TX N20 Mode 5200MHz

Horizontal

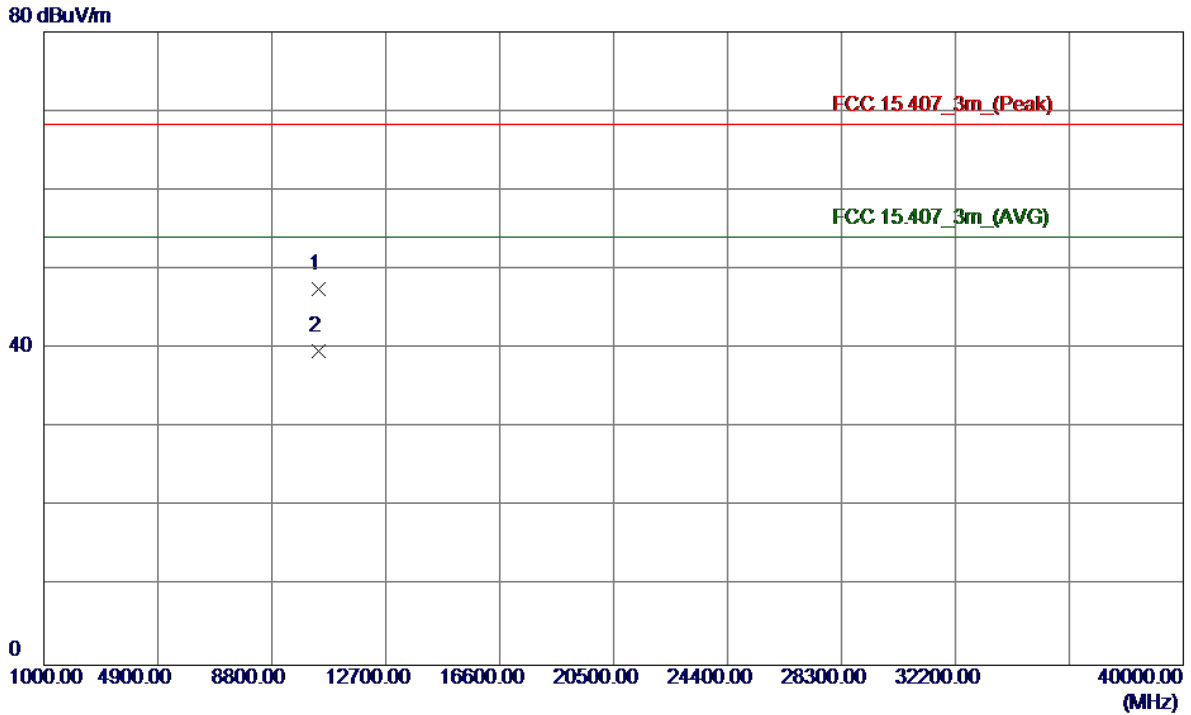

No.	Freq. MHz	Reading Level dBuV/m	Correct Factor dB	Measure ment dBuV/m	Limit dBuV/m	Margin dB	Detector	Comment
1	10400.0250	31.11	16.45	47.56	68.30	-20.74	Peak	
2 *	10400.0050	23.17	16.45	39.62	54.00	-14.38	AVG	

Orthogonal Axis:	X
Test Mode:	UNII-1/ TX N20 Mode 5240MHz

Vertical

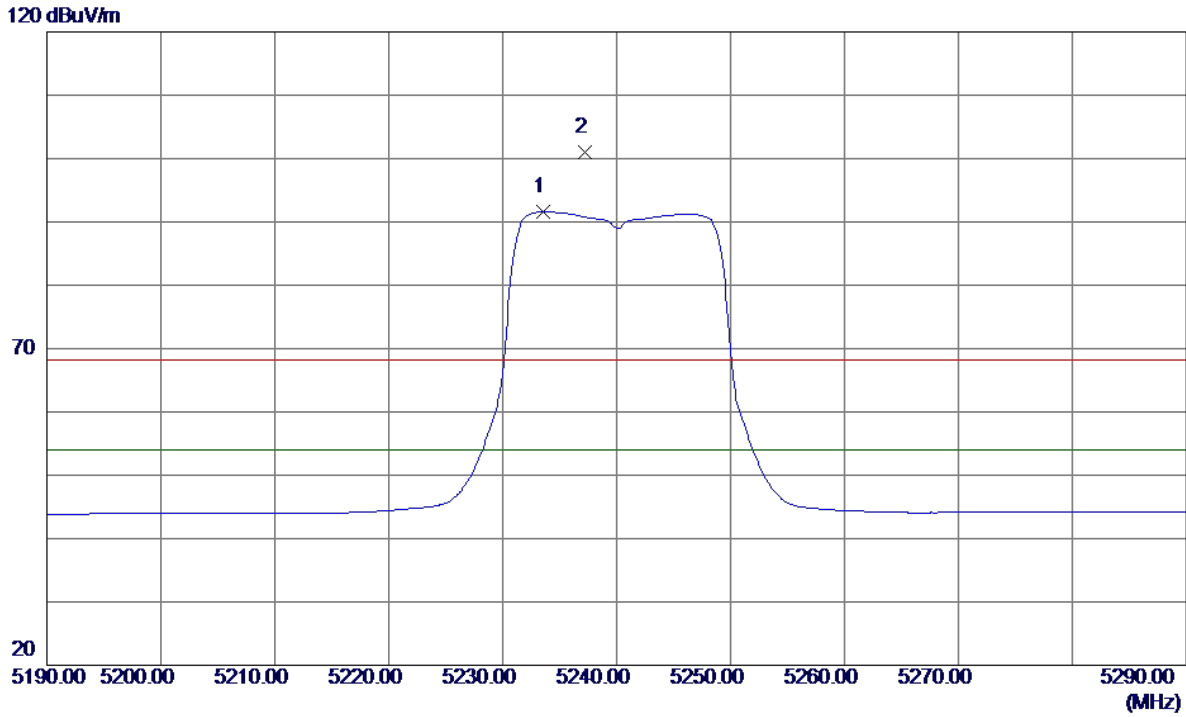

No.	Freq. MHz	Reading Level dBuV/m	Correct Factor dB	Measure ment dBuV/m	Limit dBuV/m	Margin dB	Detector	Comment
1 *	5233.6000	49.97	41.63	91.60	54.00	37.60	AVG	No Limit
2	5237.2000	59.35	41.64	100.99	68.30	32.69	Peak	No Limit

Orthogonal Axis:	X
Test Mode:	UNII-1/ TX N20 Mode 5240MHz

Vertical

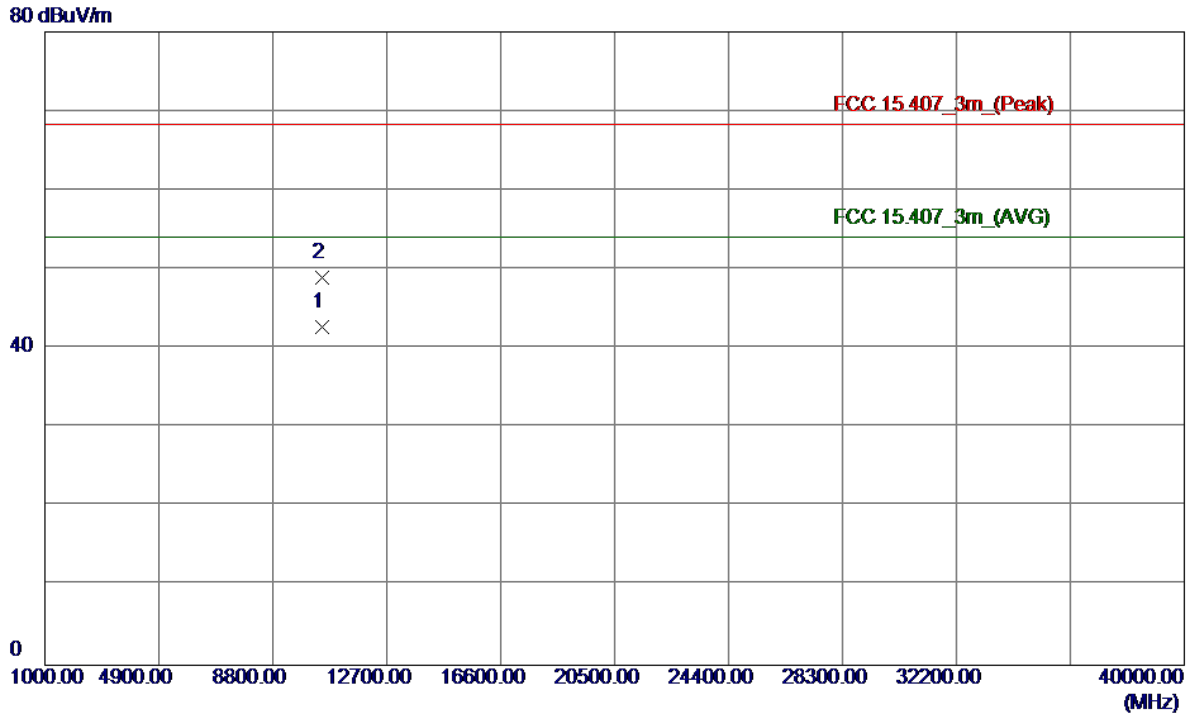

No.	Freq. MHz	Reading Level dBuV/m	Correct Factor dB	Measure ment dBuV/m	Limit dBuV/m	Margin dB	Detector	Comment
1 *	10480.0150	26.13	16.63	42.76	54.00	-11.24	AVG	
2	10480.2550	32.40	16.63	49.03	68.30	-19.27	Peak	

Orthogonal Axis:	X
Test Mode:	UNII-1/ TX N20 Mode 5240MHz

Horizontal

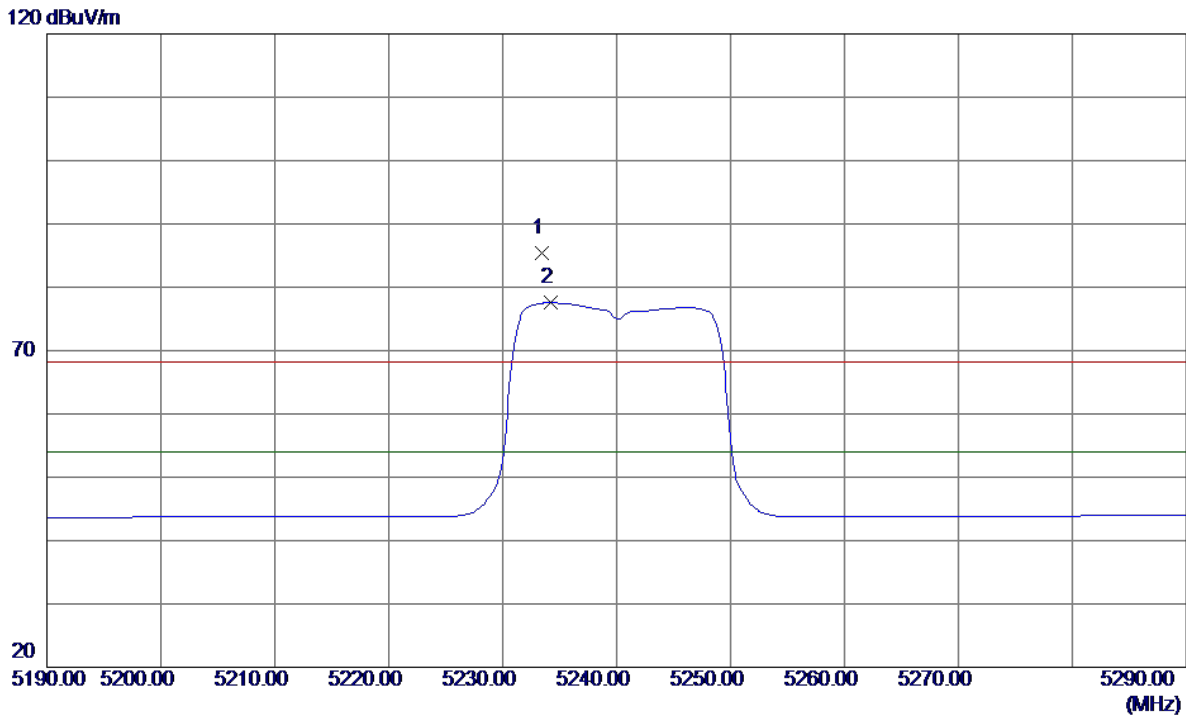

No.	Freq. MHz	Reading Level dBuV/m	Correct Factor dB	Measure ment dBuV/m	Limit dBuV/m	Margin dB	Detector	Comment
1	5233.4000	43.79	41.63	85.42	68.30	17.12	Peak	No Limit
2 *	5234.2000	35.93	41.63	77.56	54.00	23.56	AVG	No Limit

Orthogonal Axis:	X
Test Mode:	UNII-1/ TX N20 Mode 5240MHz

Horizontal

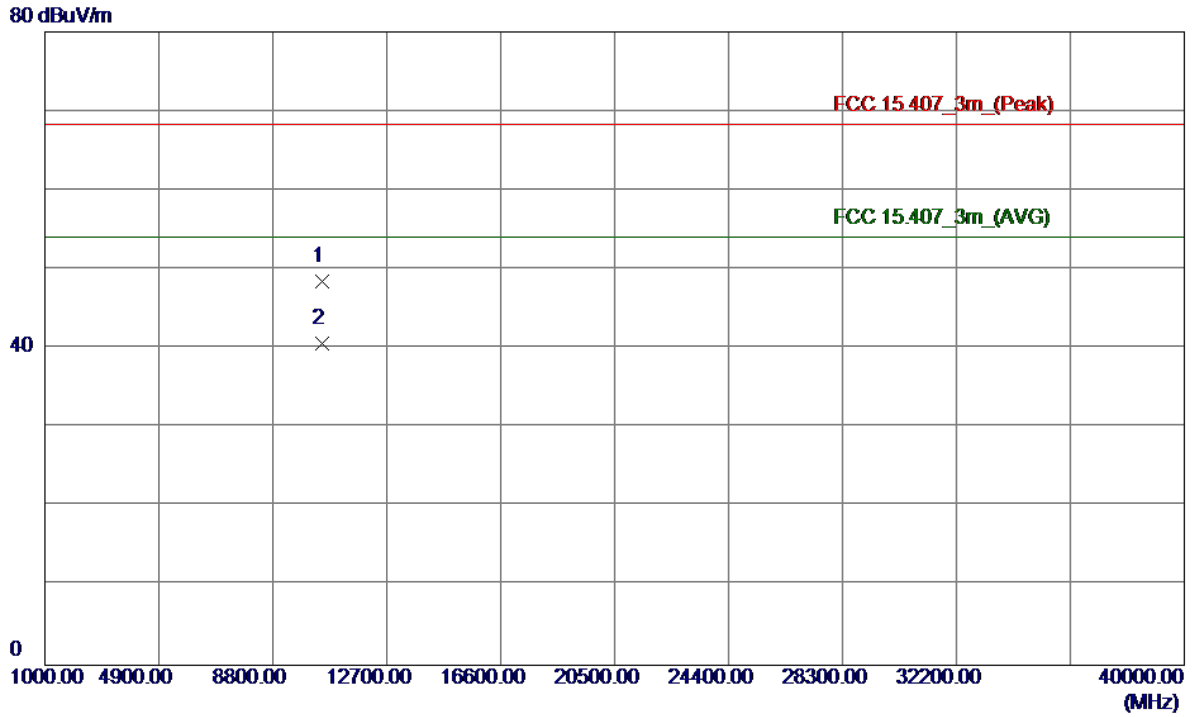

No.	Freq. MHz	Reading Level dBuV/m	Correct Factor dB	Measure ment dBuV/m	Limit dBuV/m	Margin dB	Detector	Comment
1	10480.0250	31.83	16.63	48.46	68.30	-19.84	Peak	
2 *	10480.0000	23.99	16.63	40.62	54.00	-13.38	AVG	

Orthogonal Axis:	X
Test Mode:	UNII-1/ TX N40 Mode 5190MHz

Vertical

120 dBuV/m

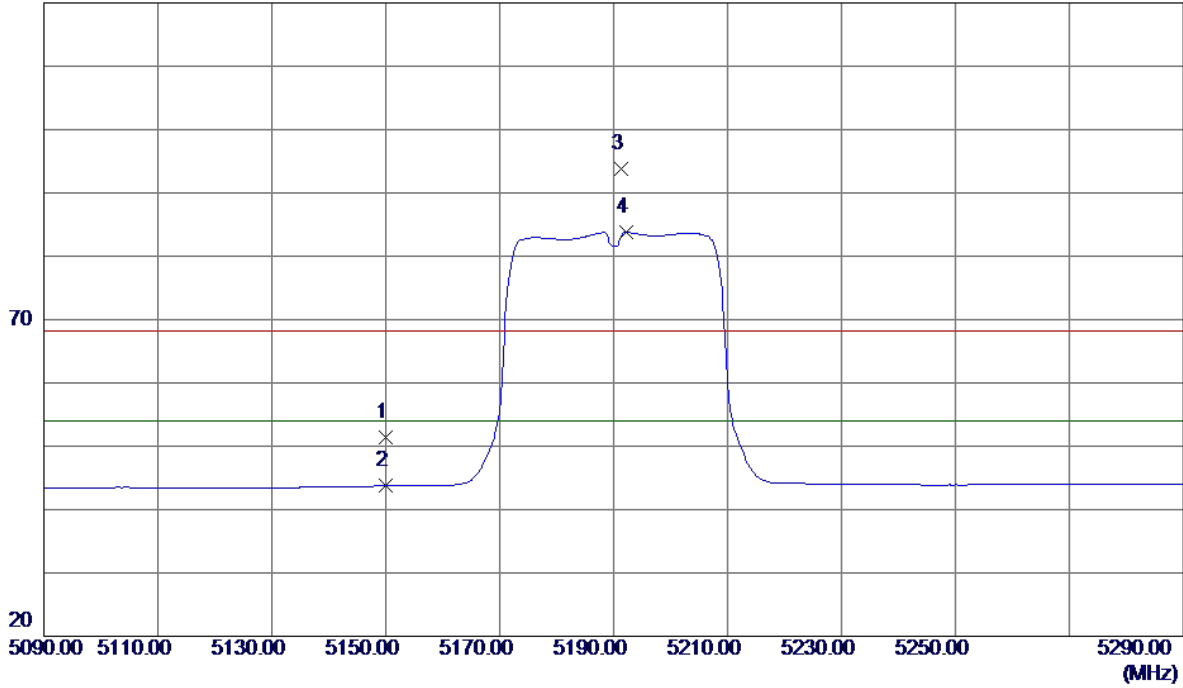

No.	Freq. MHz	Reading Level dBuV/m	Correct Factor dB	Measure ment dBuV/m	Limit dBuV/m	Margin dB	Detector	Comment
1	5150.0000	9.99	41.35	51.34	68.30	-16.96	Peak	
2	5150.0000	2.36	41.35	43.71	54.00	-10.29	AVG	
3	5191.4000	52.36	41.49	93.85	68.30	25.55	Peak	No Limit
4 *	5192.2000	42.30	41.49	83.79	54.00	29.79	AVG	No Limit

Orthogonal Axis:	X
Test Mode:	UNII-1/ TX N40 Mode 5190MHz

Vertical

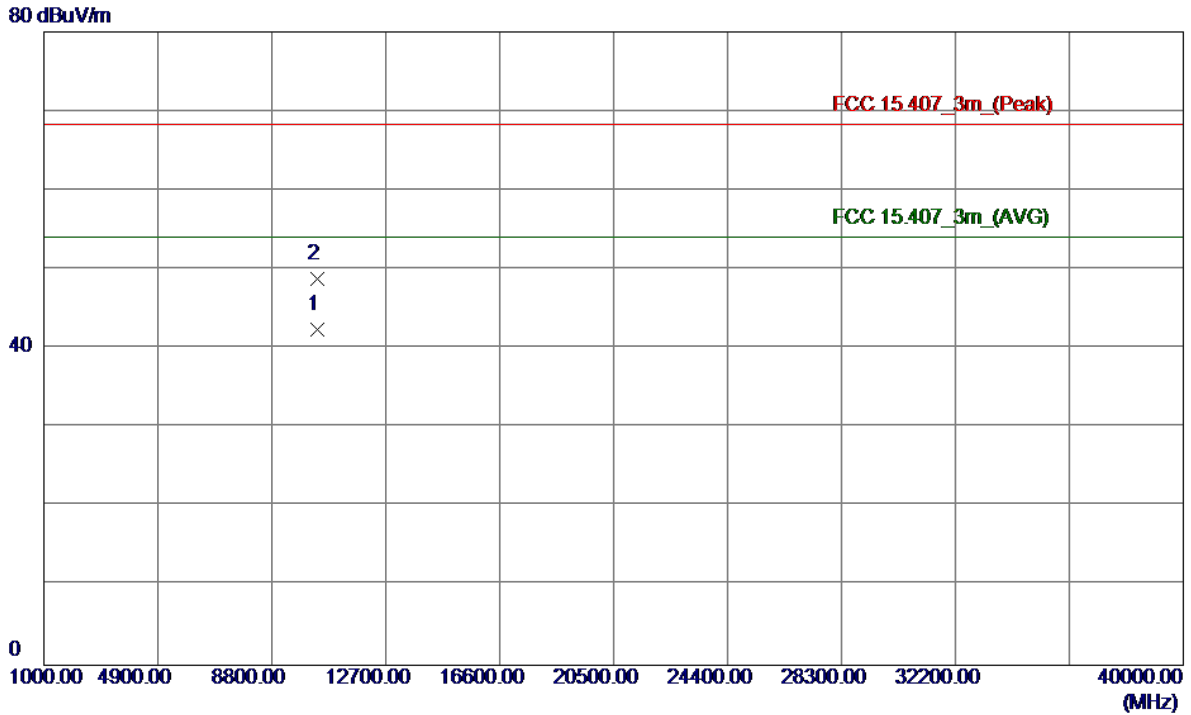

No.	Freq. MHz	Reading Level dBuV/m	Correct Factor dB	Measure ment dBuV/m	Limit dBuV/m	Margin dB	Detector	Comment
1 *	10380.1000	26.01	16.40	42.41	54.00	-11.59	AVG	
2	10380.1449	32.42	16.40	48.82	68.30	-19.48	Peak	

Orthogonal Axis:	X
Test Mode:	UNII-1/ TX N40 Mode 5190MHz

Horizontal

120 dBuV/m

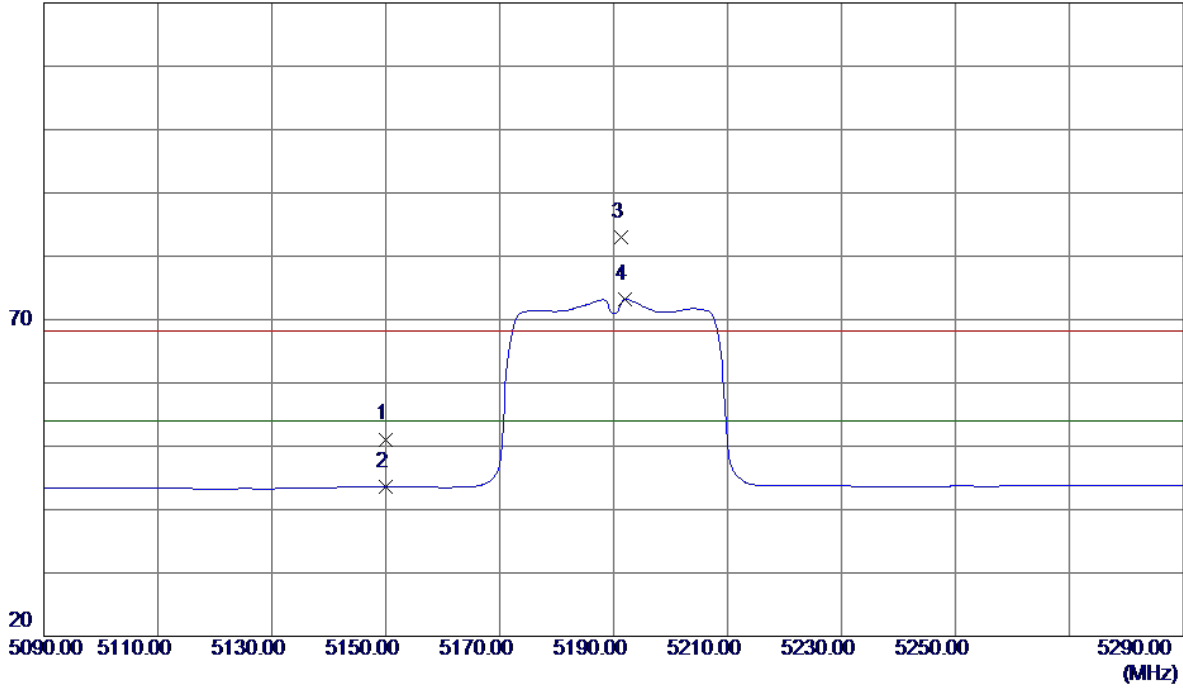

No.	Freq. MHz	Reading Level dBuV/m	Correct Factor dB	Measure ment dBuV/m	Limit dBuV/m	Margin dB	Detector	Comment
1	5150.0000	9.75	41.35	51.10	68.30	-17.20	Peak	
2	5150.0000	2.19	41.35	43.54	54.00	-10.46	AVG	
3	5191.4000	41.55	41.49	83.04	68.30	14.74	Peak	No Limit
4 *	5192.0000	31.73	41.49	73.22	54.00	19.22	AVG	No Limit

Orthogonal Axis:	X
Test Mode:	UNII-1/ TX N40 Mode 5190MHz

Horizontal

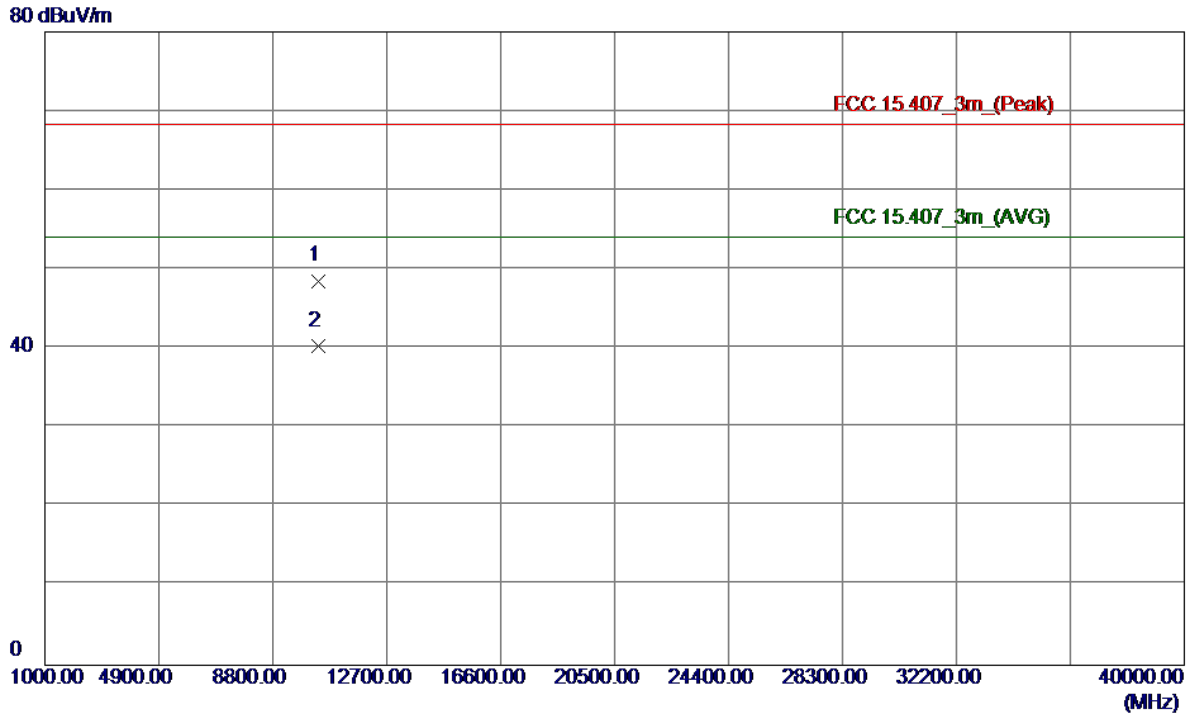

No.	Freq. MHz	Reading Level dBuV/m	Correct Factor dB	Measure ment dBuV/m	Limit dBuV/m	Margin dB	Detector	Comment
1	10380.1449	32.16	16.40	48.56	68.30	-19.74	Peak	
2 *	10380.1000	23.99	16.40	40.39	54.00	-13.61	AVG	

Orthogonal Axis:	X
Test Mode:	UNII-1/ TX N40 Mode 5230MHz

Vertical

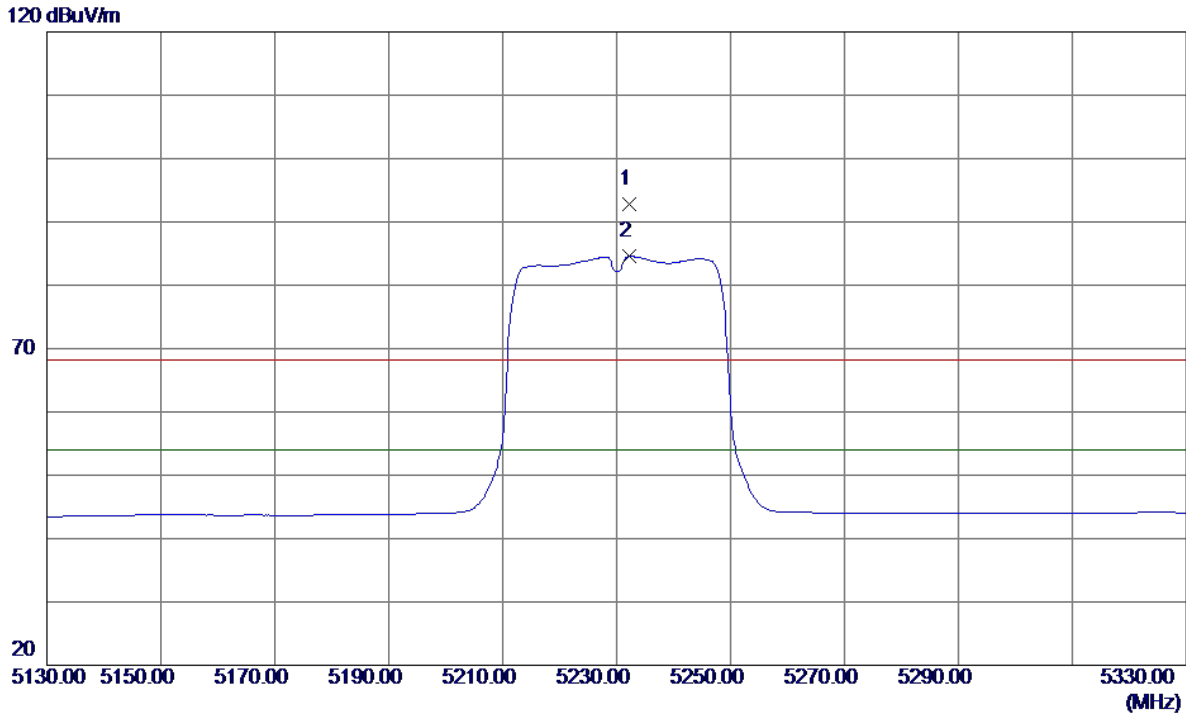

No.	Freq. MHz	Reading Level dBuV/m	Correct Factor dB	Measure ment dBuV/m	Limit dBuV/m	Margin dB	Detector	Comment
1	5232.2000	51.22	41.62	92.84	68.30	24.54	Peak	No Limit
2 *	5232.2000	42.96	41.62	84.58	54.00	30.58	AVG	No Limit

Orthogonal Axis:	X
Test Mode:	UNII-1/ TX N40 Mode 5230MHz

Vertical

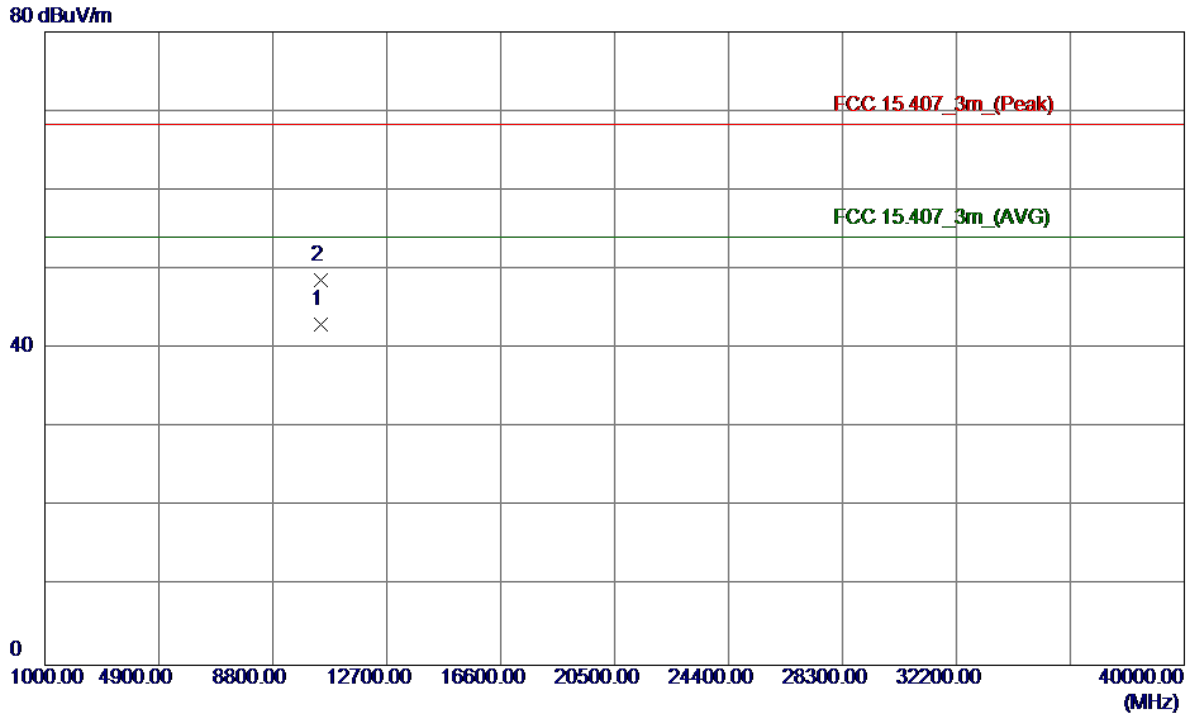

No.	Freq. MHz	Reading Level dBuV/m	Correct Factor dB	Measure ment dBuV/m	Limit dBuV/m	Margin dB	Detector	Comment
1 *	10460.0550	26.45	16.58	43.03	54.00	-10.97	AVG	
2	10460.1550	32.00	16.58	48.58	68.30	-19.72	Peak	

Orthogonal Axis:	X
Test Mode:	UNII-1/ TX N40 Mode 5230MHz

Horizontal

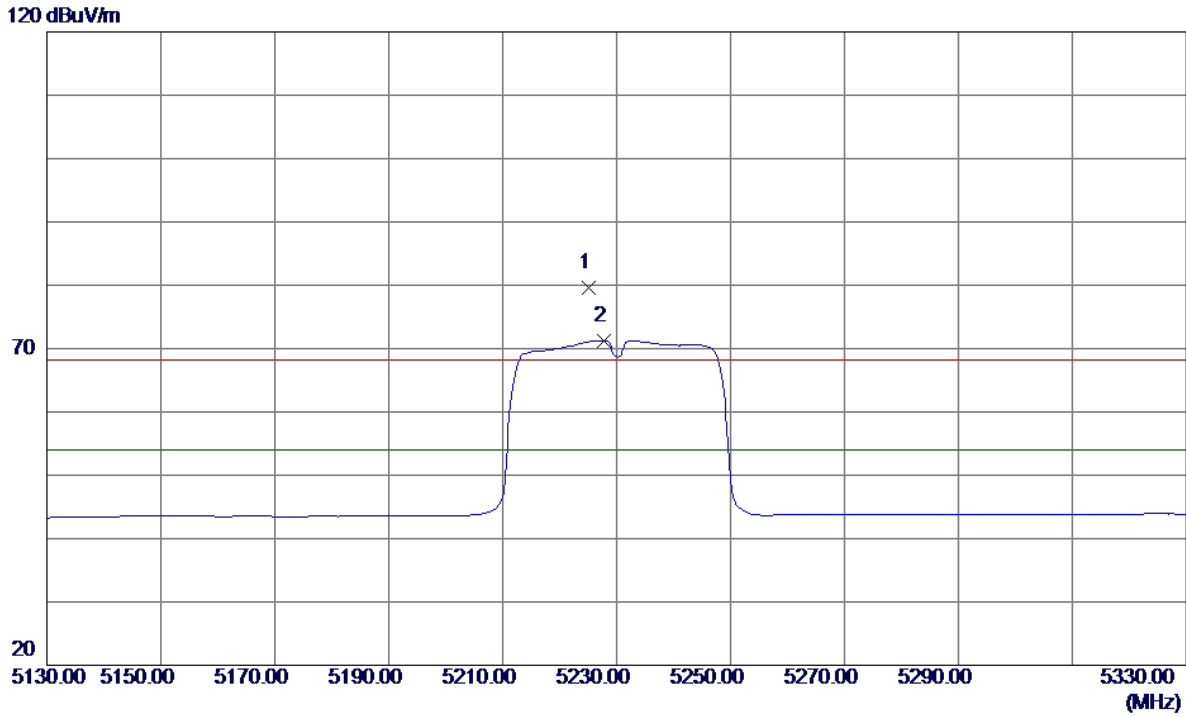

No.	Freq. MHz	Reading Level dBuV/m	Correct Factor dB	Measure ment dBuV/m	Limit dBuV/m	Margin dB	Detector	Comment
1	5225.2000	37.96	41.60	79.56	68.30	11.26	Peak	No Limit
2 *	5227.8000	29.67	41.61	71.28	54.00	17.28	AVG	No Limit

Orthogonal Axis:	X
Test Mode:	UNII-1/ TX N40 Mode 5230MHz

Horizontal

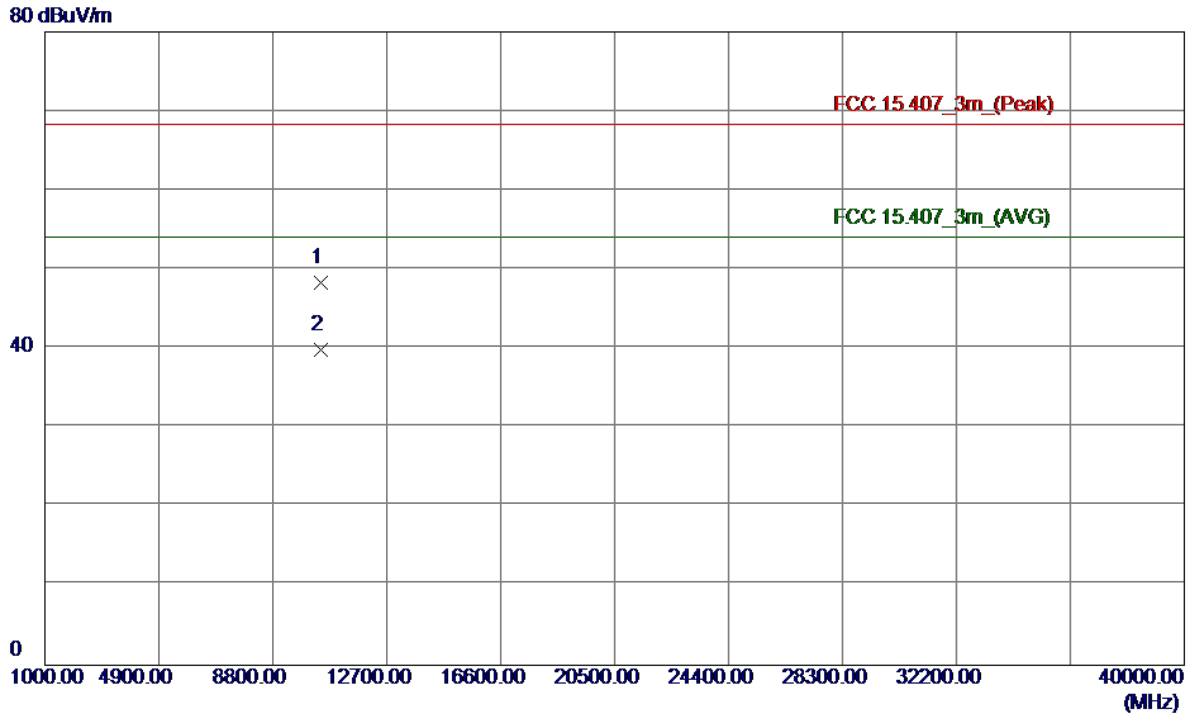

No.	Freq. MHz	Reading Level dBuV/m	Correct Factor dB	Measure ment dBuV/m	Limit dBuV/m	Margin dB	Detector	Comment
1	10460.2550	31.80	16.58	48.38	68.30	-19.92	Peak	
2 *	10460.1550	23.31	16.58	39.89	54.00	-14.11	AVG	

Orthogonal Axis:	X
Test Mode:	UNII-3/TX A Mode 5745MHz

Vertical

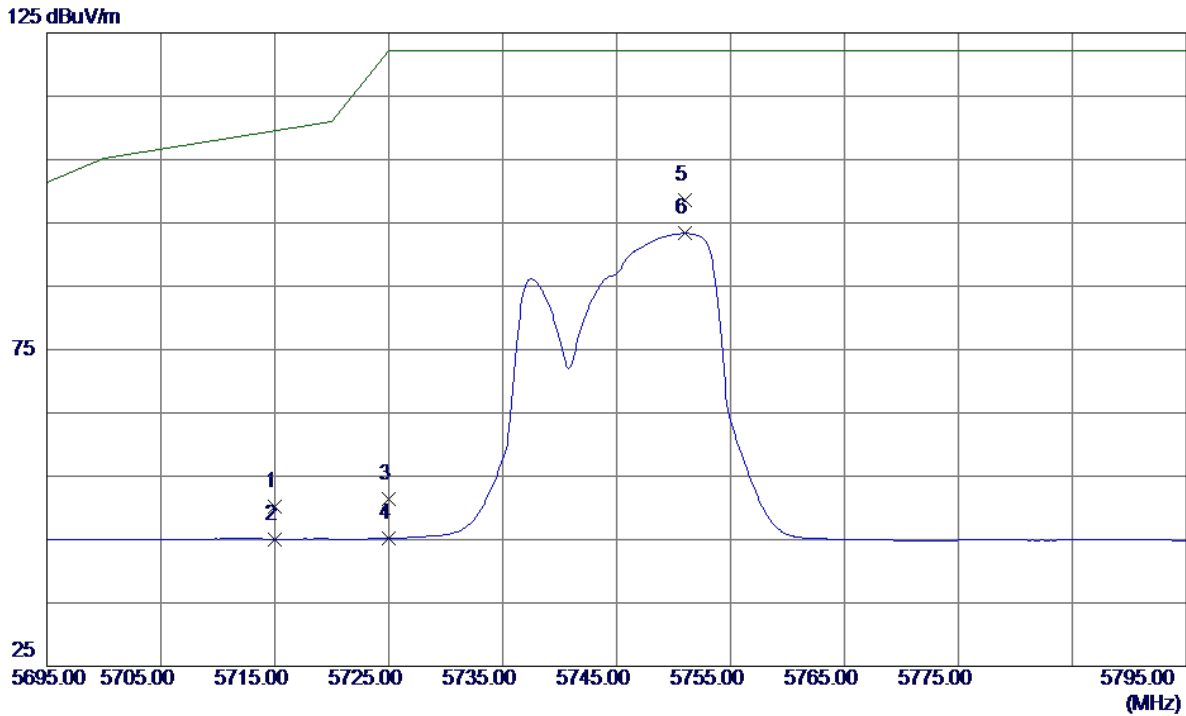

No.	Freq. MHz	Reading Level dBuV/m	Correct Factor dB	Measure ment dBuV/m	Limit dBuV/m	Margin dB	Detector	Comment
1	5715.0000	7.51	42.72	50.23	109.50	-59.27	Peak	
2	5715.0000	2.37	42.72	45.09	109.50	-64.41	AVG	
3	5725.0000	8.70	42.73	51.43	122.30	-70.87	Peak	
4	5725.0000	2.44	42.73	45.17	122.30	-77.13	AVG	
5 *	5751.0000	55.90	42.75	98.65	122.30	-23.65	Peak	
6	5751.0000	50.58	42.75	93.33	122.30	-28.97	AVG	

Orthogonal Axis:	X
Test Mode:	UNII-3/TX A Mode 5745MHz

Vertical

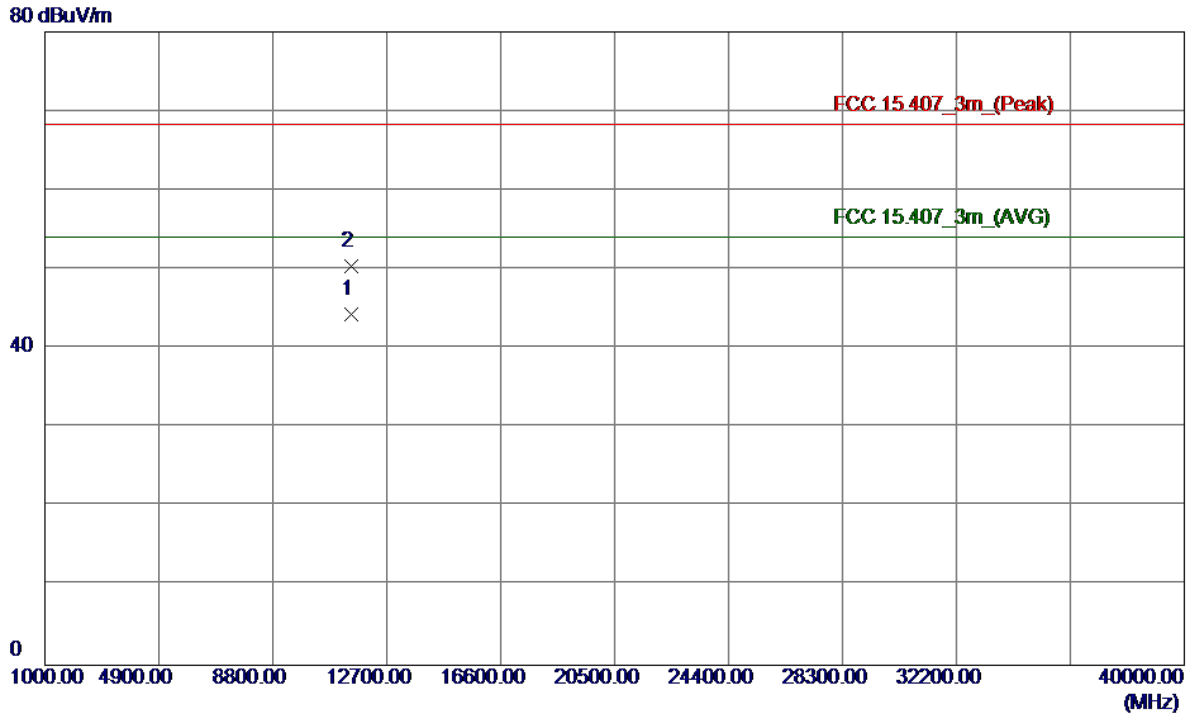

No.	Freq. MHz	Reading Level dBuV/m	Correct Factor dB	Measure ment dBuV/m	Limit dBuV/m	Margin dB	Detector	Comment
1 *	11489.9950	26.36	17.89	44.25	54.00	-9.75	AVG	
2	11489.9700	32.47	17.89	50.36	68.30	-17.94	Peak	

Orthogonal Axis:	X
Test Mode:	UNII-3/TX A Mode 5745MHz

Horizontal

125 dBuV/m

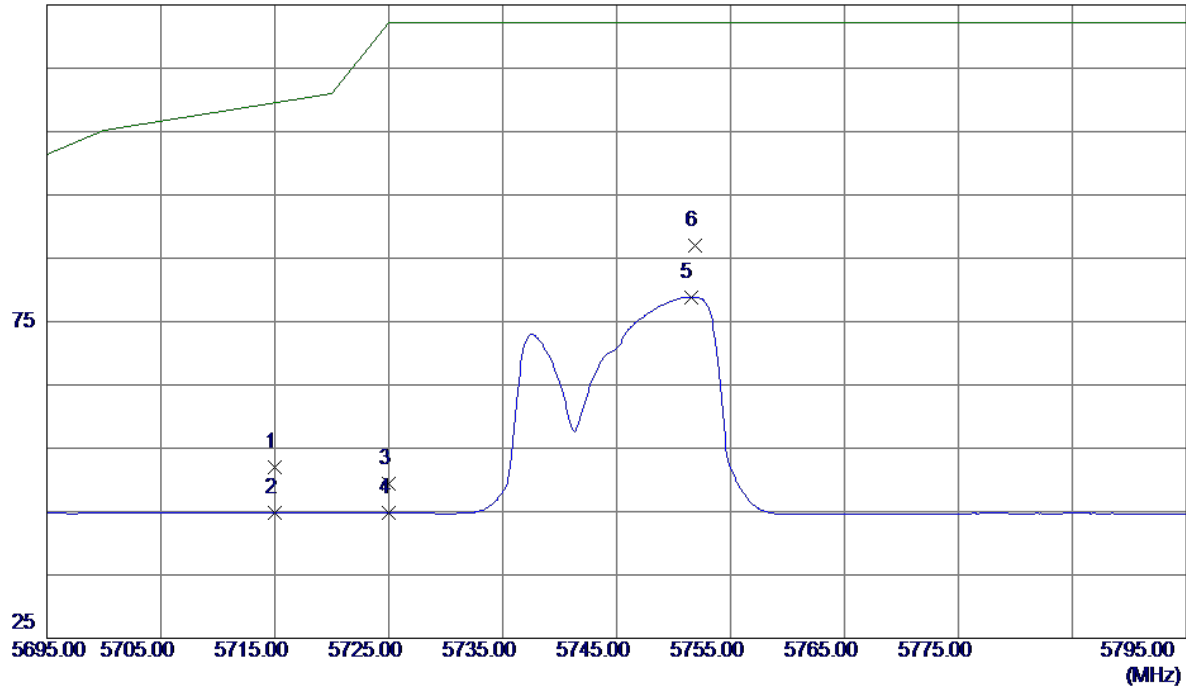

No.	Freq. MHz	Reading Level dBuV/m	Correct Factor dB	Measure ment dBuV/m	Limit dBuV/m	Margin dB	Detector	Comment
1	5715.0000	9.25	42.72	51.97	109.50	-57.53	Peak	
2	5715.0000	2.15	42.72	44.87	109.50	-64.63	AVG	
3	5725.0000	6.63	42.73	49.36	122.30	-72.94	Peak	
4	5725.0000	2.05	42.73	44.78	122.30	-77.52	AVG	
5	5751.5000	36.14	42.75	78.89	122.30	-43.41	AVG	
6 *	5751.9000	44.31	42.75	87.06	122.30	-35.24	Peak	

Orthogonal Axis:	X
Test Mode:	UNII-3/TX A Mode 5745MHz

Horizontal

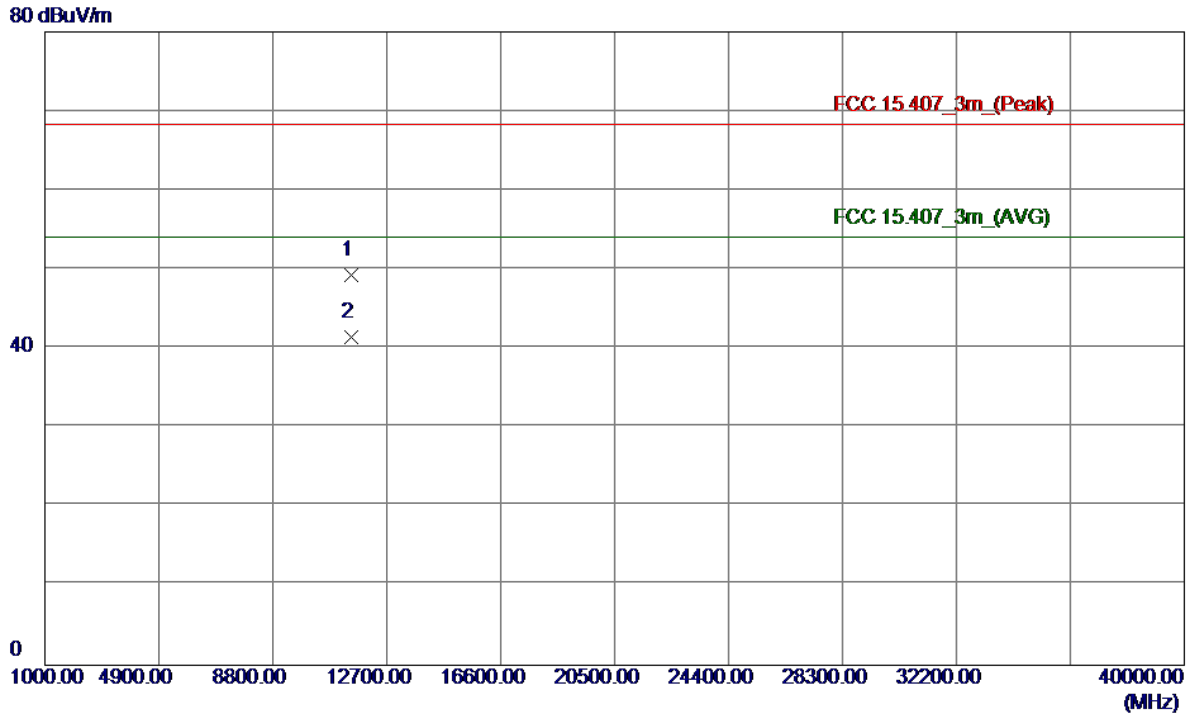

No.	Freq. MHz	Reading Level dBuV/m	Correct Factor dB	Measure ment dBuV/m	Limit dBuV/m	Margin dB	Detector	Comment
1	11490.0100	31.41	17.89	49.30	68.30	-19.00	Peak	
2 *	11489.9950	23.48	17.89	41.37	54.00	-12.63	AVG	

Orthogonal Axis:	X
Test Mode:	UNII-3/TX A Mode 5785MHz

Vertical

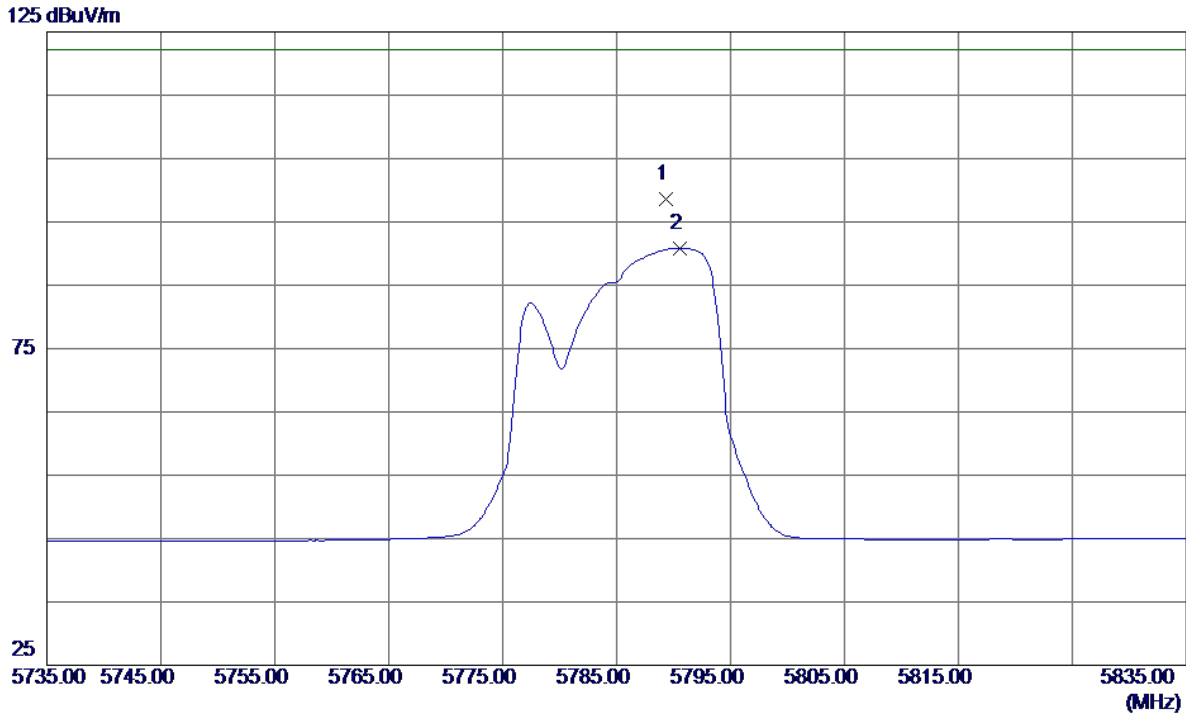

No.	Freq. MHz	Reading Level dBuV/m	Correct Factor dB	Measure ment dBuV/m	Limit dBuV/m	Margin dB	Detector	Comment
1 *	5789.3000	55.84	42.78	98.62	122.30	-23.68	Peak	
2	5790.6000	48.08	42.79	90.87	122.30	-31.43	AVG	

Orthogonal Axis:	X
Test Mode:	UNII-3/TX A Mode 5785MHz

Vertical

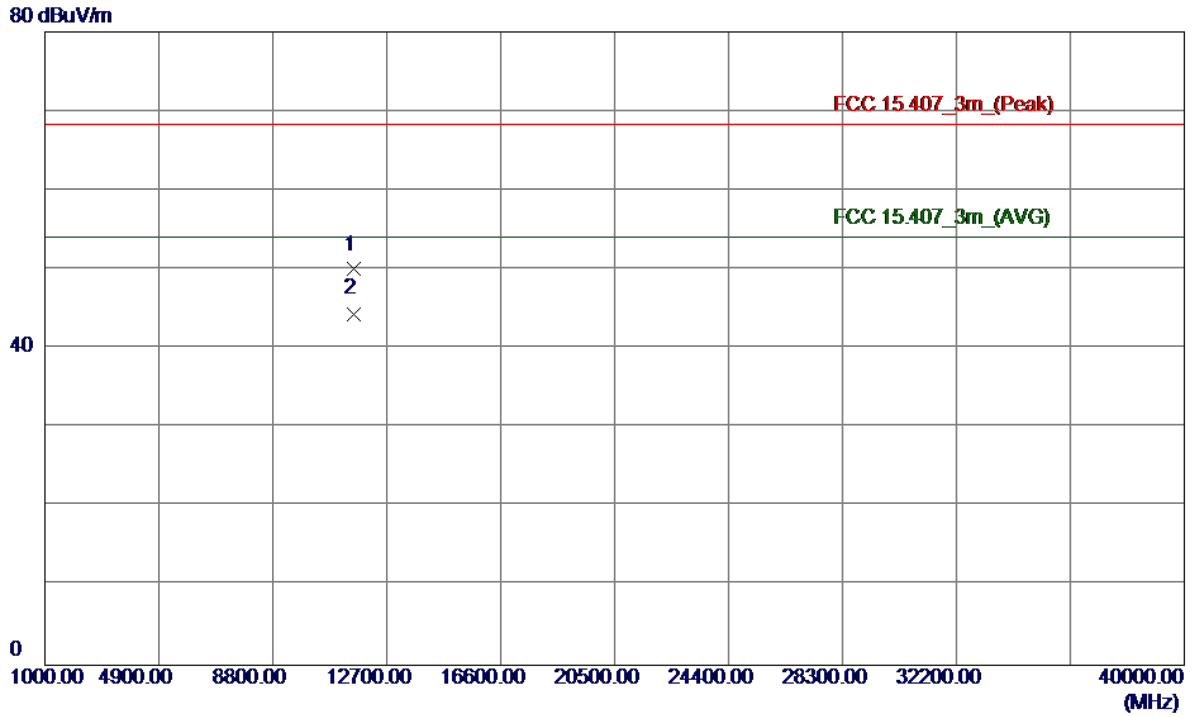

No.	Freq. MHz	Reading Level dBuV/m	Correct Factor dB	Measure ment dBuV/m	Limit dBuV/m	Margin dB	Detector	Comment
1	11570.1200	32.15	17.85	50.00	68.30	-18.30	Peak	
2 *	11570.0199	26.55	17.85	44.40	54.00	-9.60	AVG	

Orthogonal Axis:	X
Test Mode:	UNII-3/TX A Mode 5785MHz

Horizontal

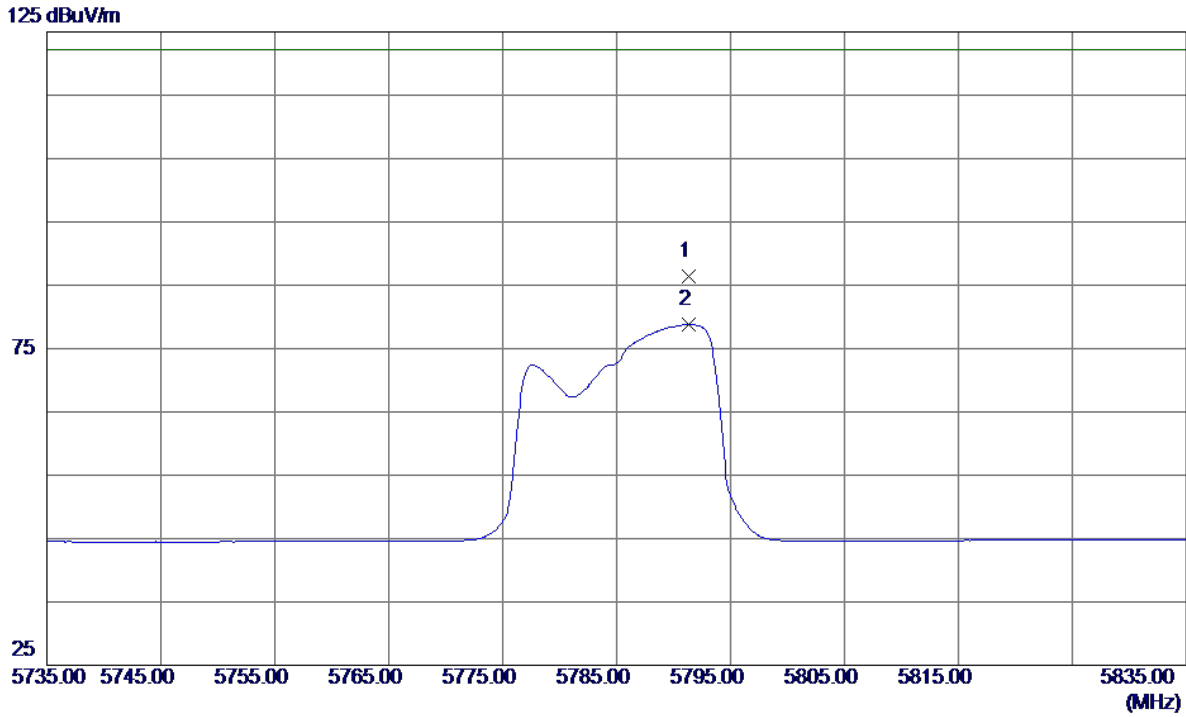

No.	Freq. MHz	Reading Level dBuV/m	Correct Factor dB	Measure ment dBuV/m	Limit dBuV/m	Margin dB	Detector	Comment
1 *	5791.3000	43.55	42.79	86.34	122.30	-35.96	Peak	
2	5791.3000	35.98	42.79	78.77	122.30	-43.53	AVG	

Orthogonal Axis:	X
Test Mode:	UNII-3/TX A Mode 5785MHz

Horizontal

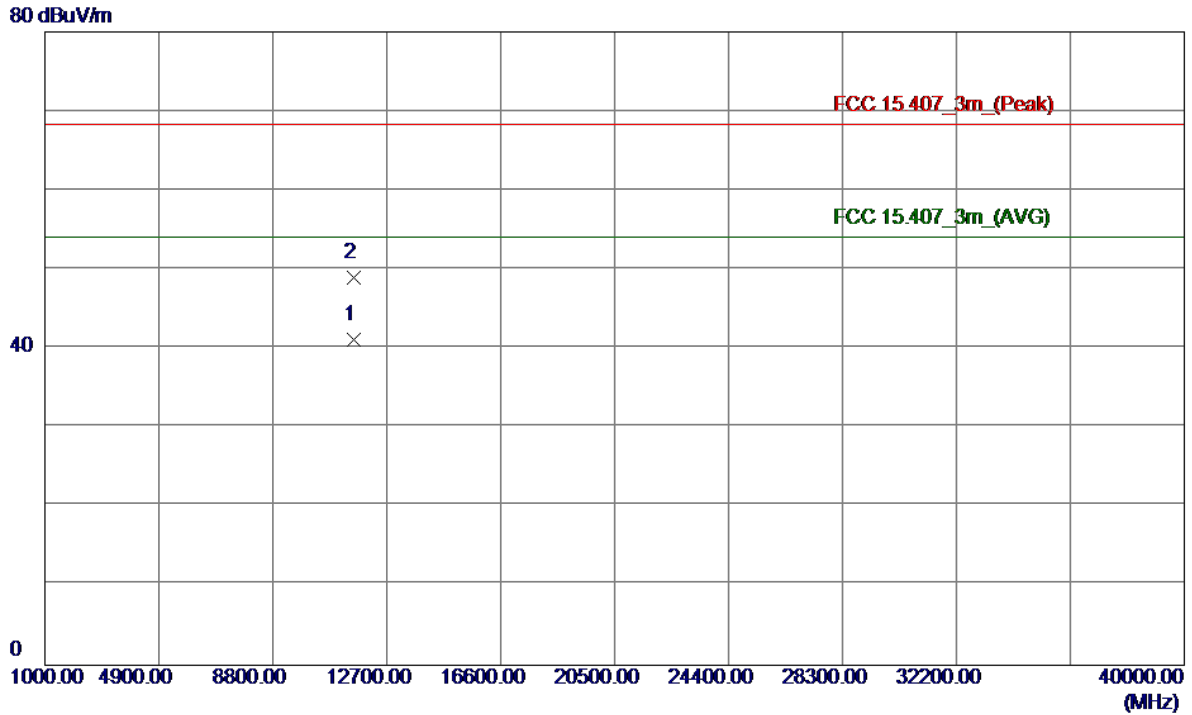

No.	Freq. MHz	Reading Level dBuV/m	Correct Factor dB	Measure ment dBuV/m	Limit dBuV/m	Margin dB	Detector	Comment
1 *	11570.0199	23.29	17.85	41.14	54.00	-12.86	AVG	
2	11570.1200	31.16	17.85	49.01	68.30	-19.29	Peak	

Orthogonal Axis:	X
Test Mode:	UNII-3/TX A Mode 5825MHz

Vertical

125 dBuV/m

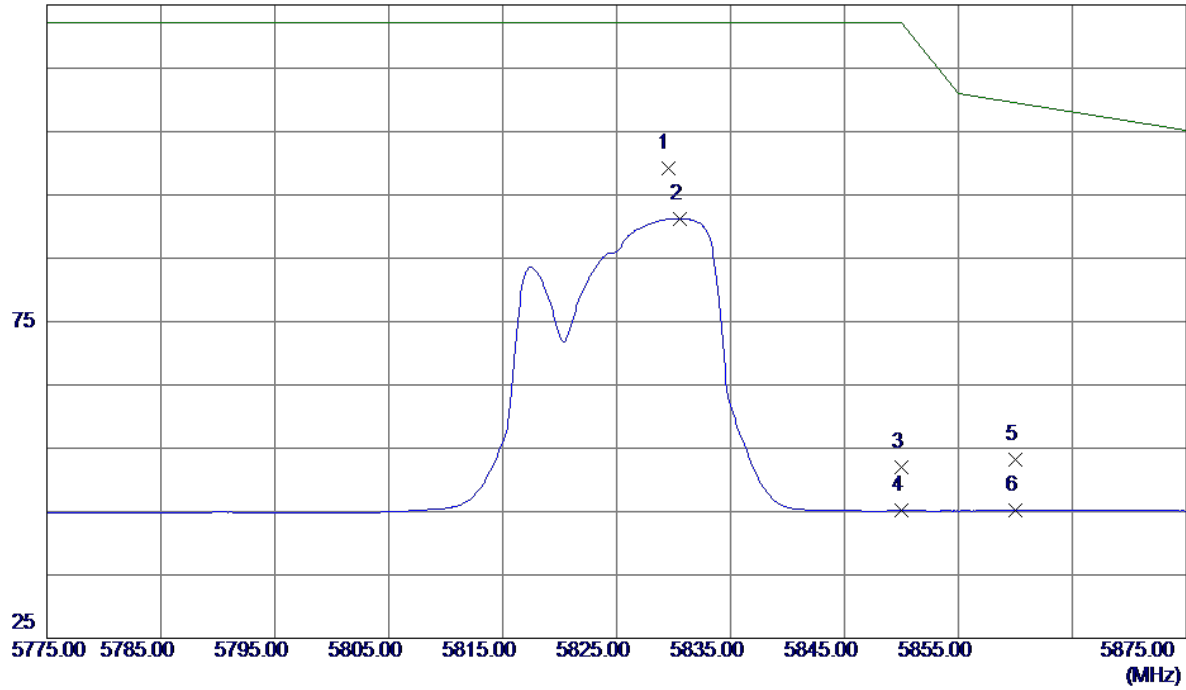

No.	Freq. MHz	Reading Level dBuV/m	Correct Factor dB	Measure ment dBuV/m	Limit dBuV/m	Margin dB	Detector	Comment
1 *	5829.5000	56.30	42.82	99.12	122.30	-23.18	Peak	
2	5830.6000	48.47	42.82	91.29	122.30	-31.01	AVG	
3	5850.0000	9.22	42.84	52.06	122.30	-70.24	Peak	
4	5850.0000	2.27	42.84	45.11	122.30	-77.19	AVG	
5	5860.0000	10.40	42.85	53.25	109.50	-56.25	Peak	
6	5860.0000	2.29	42.85	45.14	109.50	-64.36	AVG	

Orthogonal Axis:	X
Test Mode:	UNII-3/TX A Mode 5825MHz

Vertical

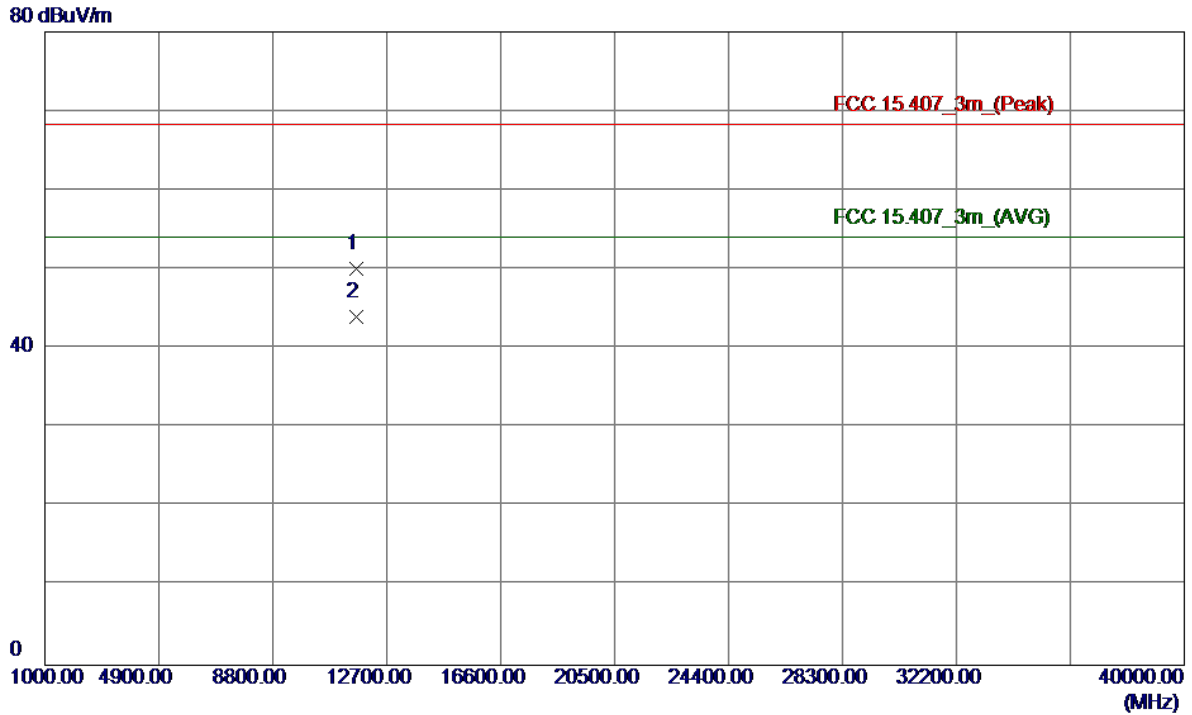

No.	Freq. MHz	Reading Level dBuV/m	Correct Factor dB	Measure ment dBuV/m	Limit dBuV/m	Margin dB	Detector	Comment
1	11649.6800	32.24	17.79	50.03	68.30	-18.27	Peak	
2 *	11649.7800	26.26	17.79	44.05	54.00	-9.95	AVG	

Orthogonal Axis:	X
Test Mode:	UNII-3/TX A Mode 5825MHz

Horizontal

125 dBuV/m

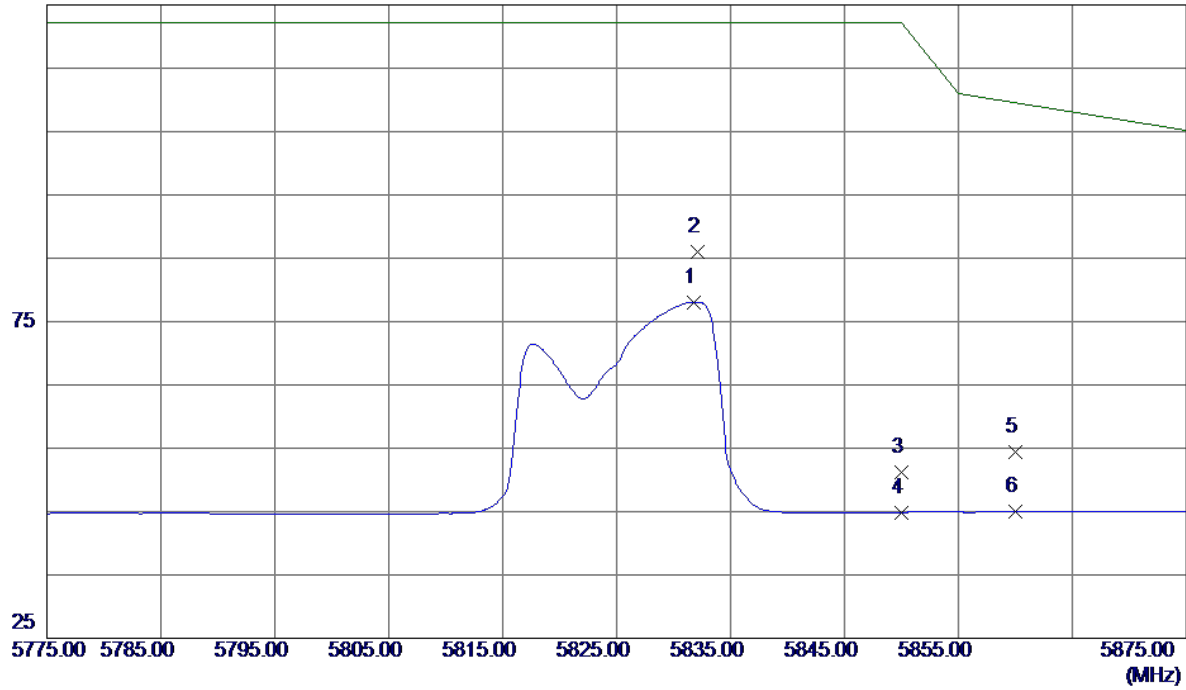

No.	Freq. MHz	Reading Level dBuV/m	Correct Factor dB	Measure ment dBuV/m	Limit dBuV/m	Margin dB	Detector	Comment
1	5831.8000	35.26	42.82	78.08	122.30	-44.22	AVG	
2 *	5832.1000	43.21	42.82	86.03	122.30	-36.27	Peak	
3	5850.0000	8.31	42.84	51.15	122.30	-71.15	Peak	
4	5850.0000	2.04	42.84	44.88	122.30	-77.42	AVG	
5	5860.0000	11.50	42.85	54.35	109.50	-55.15	Peak	
6	5860.0000	2.10	42.85	44.95	109.50	-64.55	AVG	

Orthogonal Axis:	X
Test Mode:	UNII-3/TX A Mode 5825MHz

Horizontal

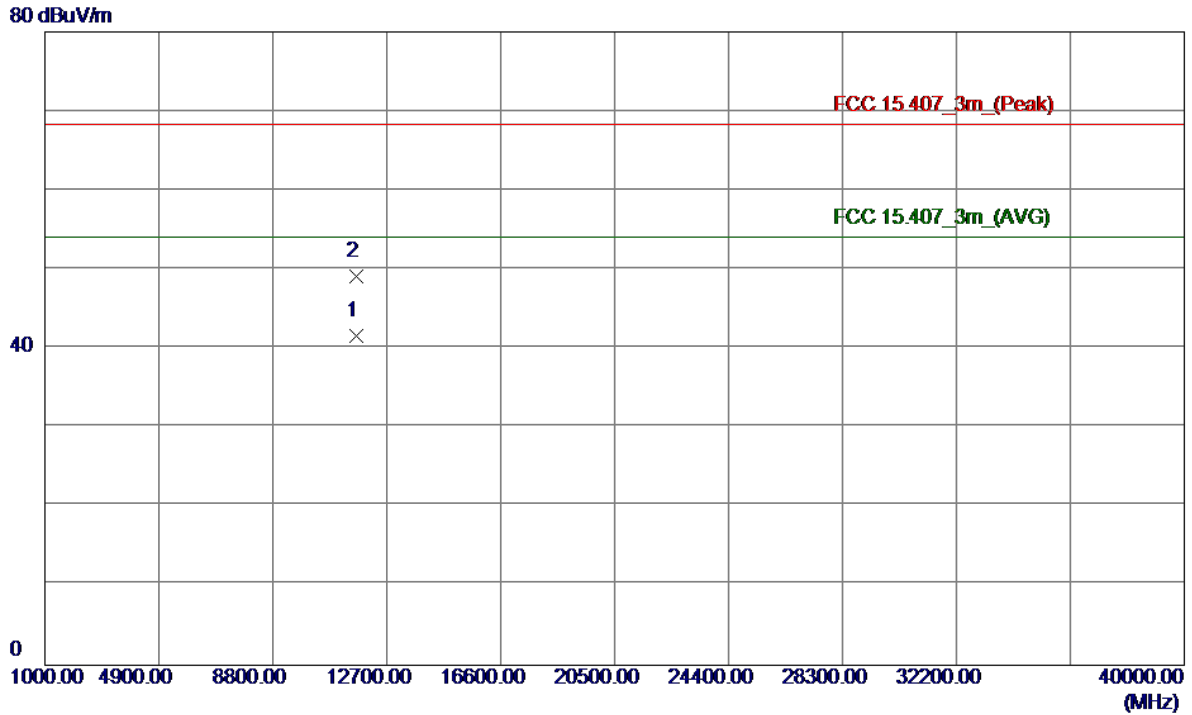

No.	Freq. MHz	Reading Level dBuV/m	Correct Factor dB	Measure ment dBuV/m	Limit dBuV/m	Margin dB	Detector	Comment
1 *	11649.6800	23.74	17.79	41.53	54.00	-12.47	AVG	
2	11649.7850	31.35	17.79	49.14	68.30	-19.16	Peak	

Orthogonal Axis:	X
Test Mode:	UNII-3/TX N20 Mode 5745MHz

Vertical

125 dBuV/m

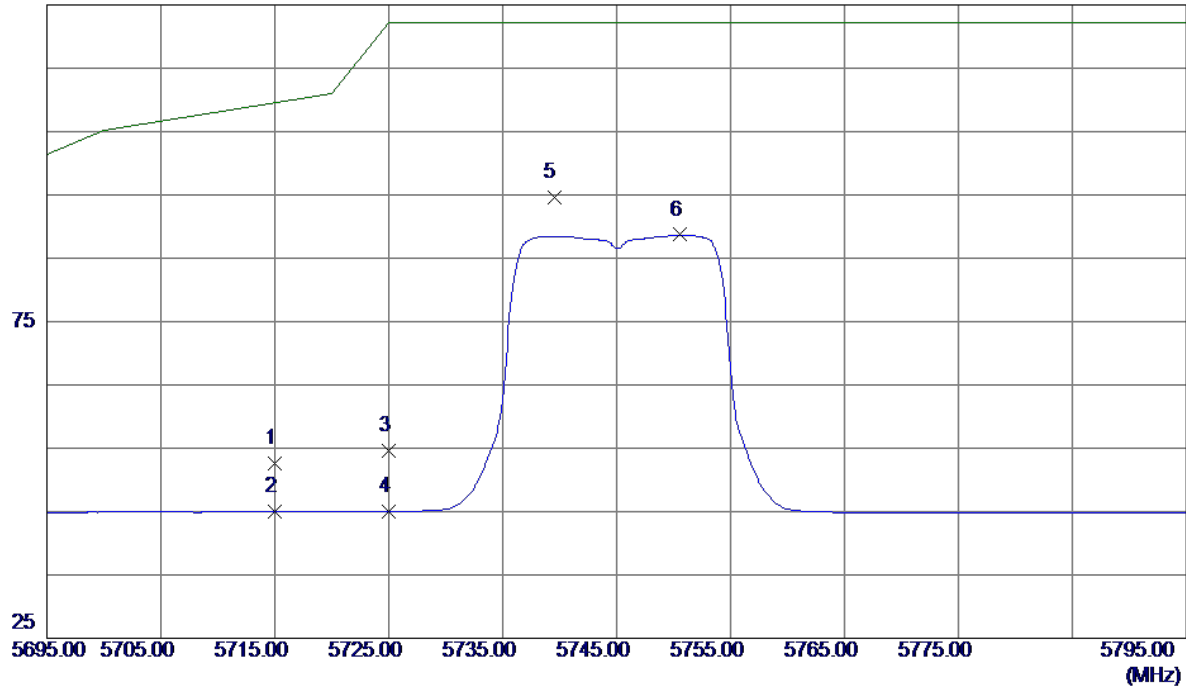

No.	Freq. MHz	Reading Level dBuV/m	Correct Factor dB	Measure ment dBuV/m	Limit dBuV/m	Margin dB	Detector	Comment
1	5715.0000	9.85	42.72	52.57	109.50	-56.93	Peak	
2	5715.0000	2.25	42.72	44.97	109.50	-64.53	AVG	
3	5725.0000	11.80	42.73	54.53	122.30	-67.77	Peak	
4	5725.0000	2.27	42.73	45.00	122.30	-77.30	AVG	
5 *	5739.5000	51.82	42.74	94.56	122.30	-27.74	Peak	
6	5750.6000	45.95	42.75	88.70	122.30	-33.60	AVG	

Orthogonal Axis:	X
Test Mode:	UNII-3/TX N20 Mode 5745MHz

Vertical

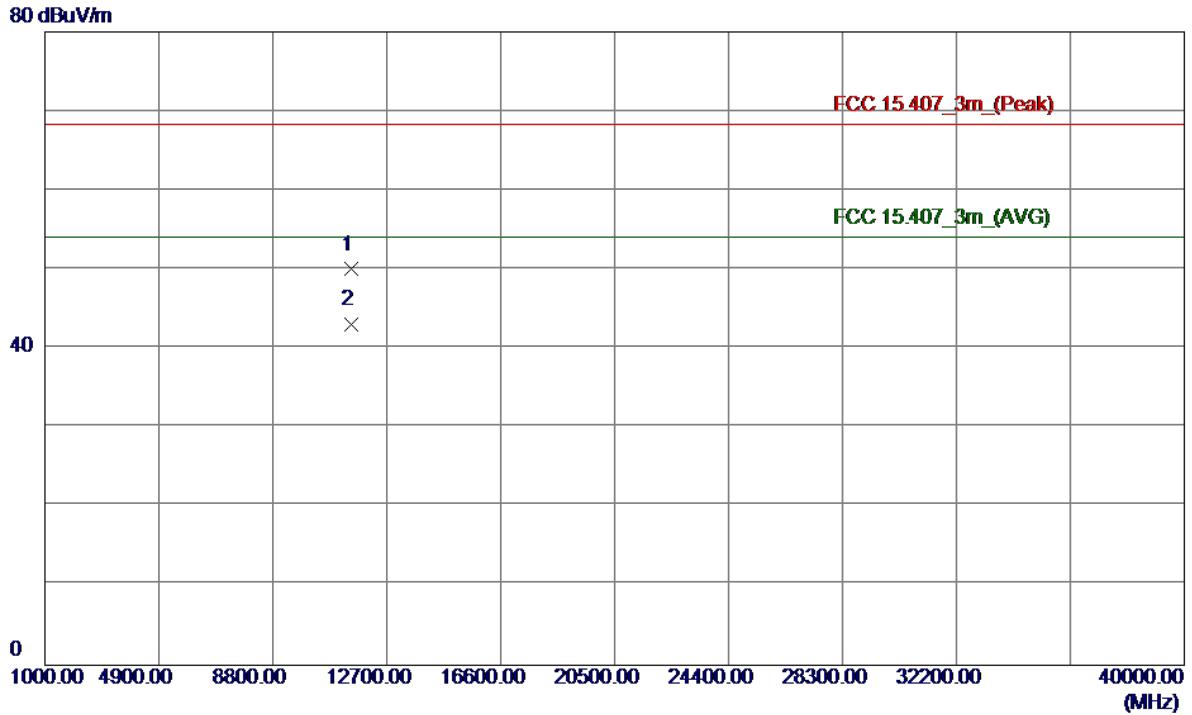

No.	Freq. MHz	Reading Level dBuV/m	Correct Factor dB	Measure ment dBuV/m	Limit dBuV/m	Margin dB	Detector	Comment
1	11490.1000	32.11	17.89	50.00	68.30	-18.30	Peak	
2 *	11489.9950	25.13	17.89	43.02	54.00	-10.98	AVG	

Orthogonal Axis:	X
Test Mode:	UNII-3/TX N20 Mode 5745MHz

Horizontal

125 dBuV/m

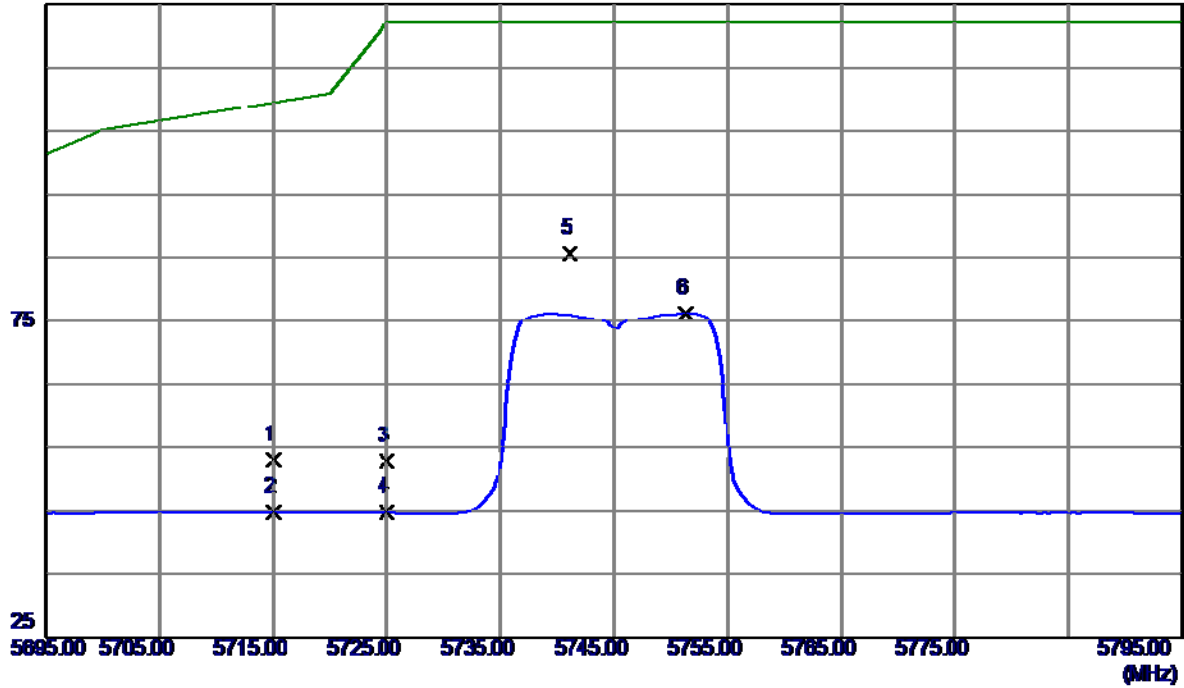

No.	Freq. MHz	Reading Level dBuV/m	Correct Factor dB	Measure ment dBuV/m	Limit dBuV/m	Margin dB	Detector	Comment
1	5715.0000	10.25	42.72	52.97	109.50	-56.53	Peak	
2	5715.0000	2.11	42.72	44.83	109.50	-64.67	AVG	
3	5725.0000	10.12	42.73	52.85	122.30	-69.45	Peak	
4	5725.0000	2.01	42.73	44.74	122.30	-77.56	AVG	
5 *	5741.1000	42.86	42.74	85.60	122.30	-36.70	Peak	
6	5751.3000	33.50	42.75	76.25	122.30	-46.05	AVG	

Orthogonal Axis:	X
Test Mode:	UNII-3/TX N20 Mode 5745MHz

Horizontal

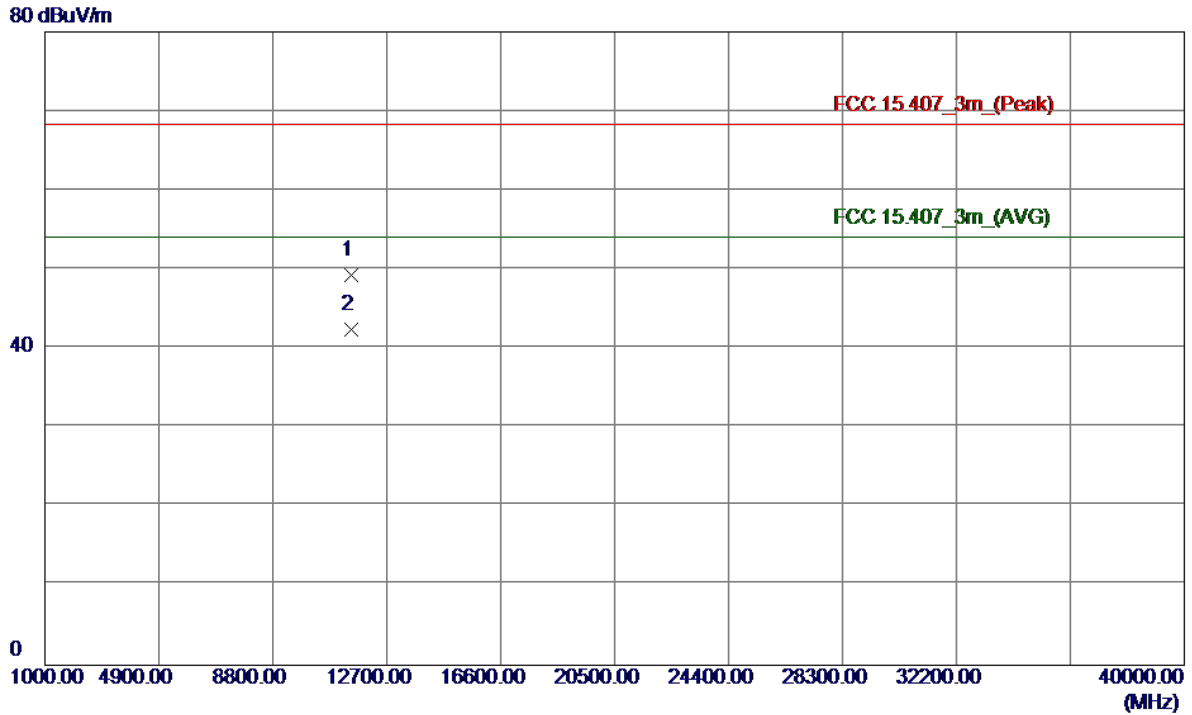

No.	Freq. MHz	Reading Level dBuV/m	Correct Factor dB	Measure ment dBuV/m	Limit dBuV/m	Margin dB	Detector	Comment
1	11489.9800	31.41	17.89	49.30	68.30	-19.00	Peak	
2 *	11489.9950	24.48	17.89	42.37	54.00	-11.63	AVG	

Orthogonal Axis:	X
Test Mode:	UNII-3/TX N20 Mode 5785MHz

Vertical

125 dBuV/m

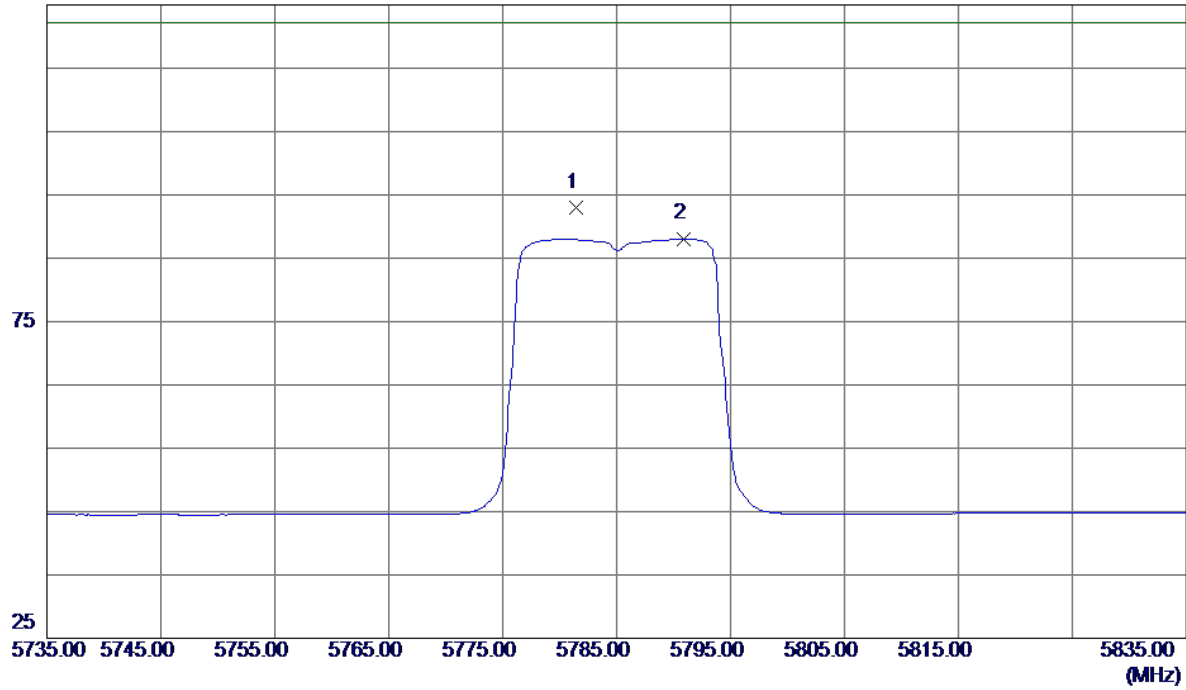

No.	Freq. MHz	Reading Level dBuV/m	Correct Factor dB	Measure ment dBuV/m	Limit dBuV/m	Margin dB	Detector	Comment
1 *	5781.4000	50.18	42.78	92.96	122.30	-29.34	Peak	
2	5790.9000	45.31	42.79	88.10	122.30	-34.20	AVG	

Orthogonal Axis:	X
Test Mode:	UNII-3/TX N20 Mode 5785MHz

Vertical

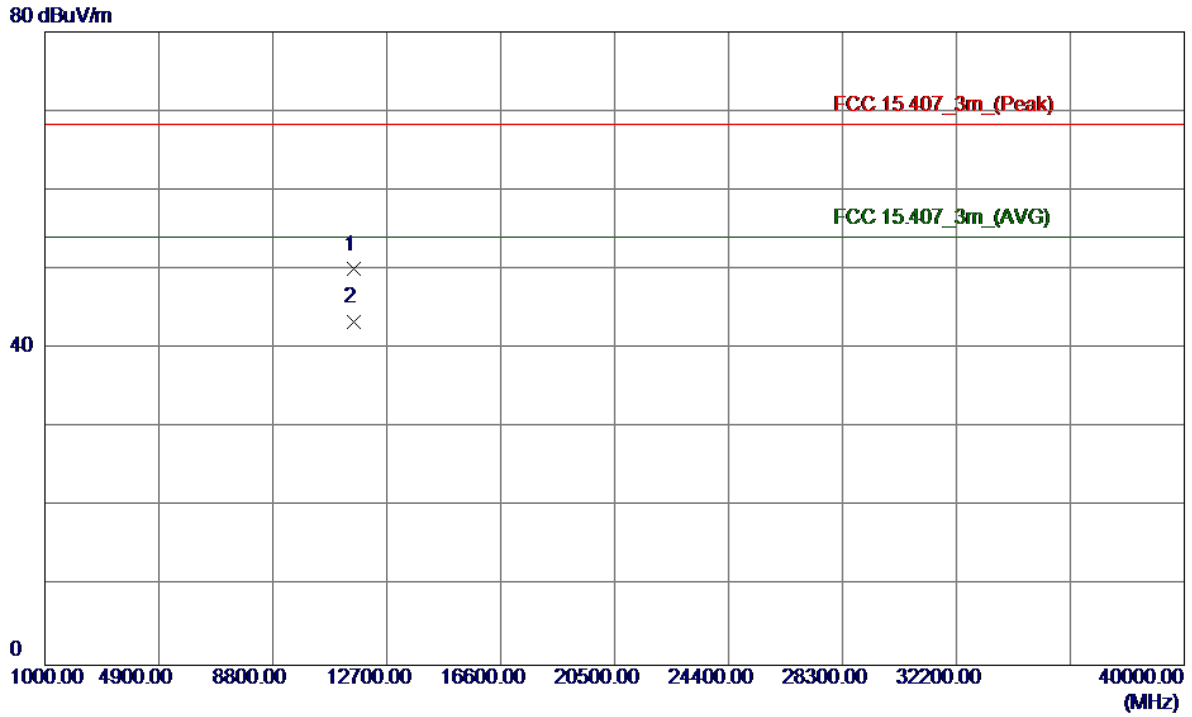

No.	Freq. MHz	Reading Level dBuV/m	Correct Factor dB	Measure ment dBuV/m	Limit dBuV/m	Margin dB	Detector	Comment
1	11570.1200	32.15	17.85	50.00	68.30	-18.30	Peak	
2 *	11570.0199	25.55	17.85	43.40	54.00	-10.60	AVG	

Orthogonal Axis:	X
Test Mode:	UNII-3/TX N20 Mode 5785MHz

Horizontal

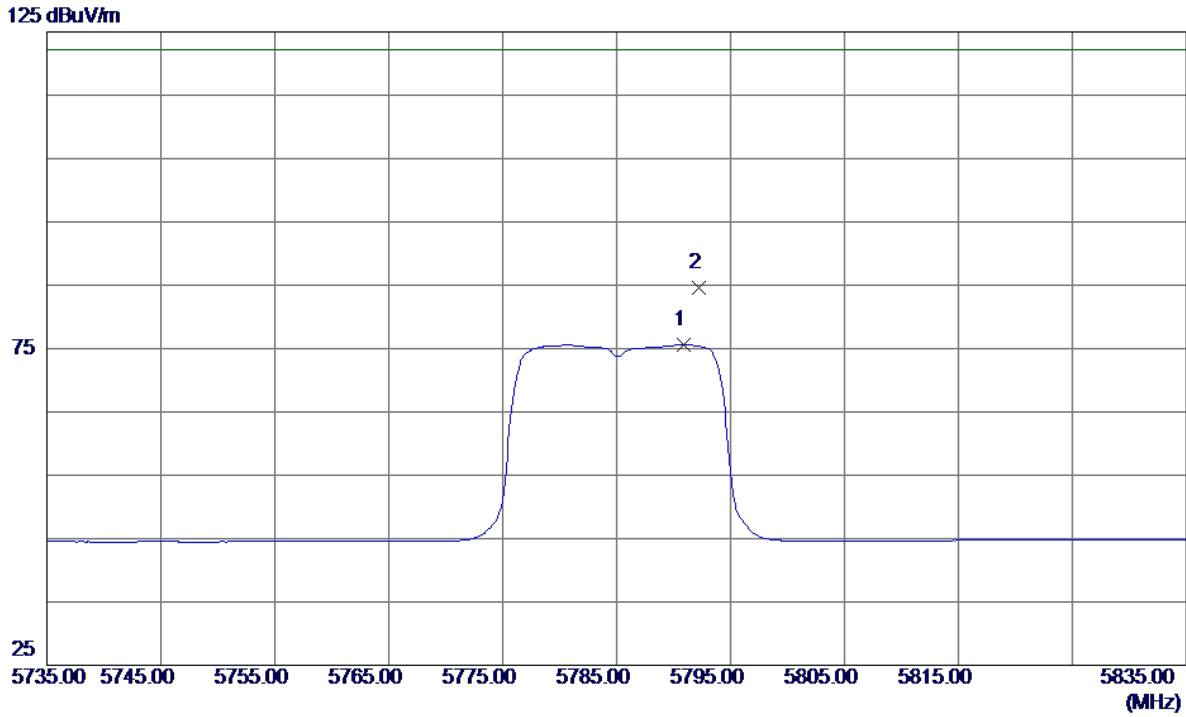

No.	Freq. MHz	Reading Level dBuV/m	Correct Factor dB	Measure ment dBuV/m	Limit dBuV/m	Margin dB	Detector	Comment
1	5790.9000	32.81	42.79	75.60	122.30	-46.70	AVG	
2 *	5792.2000	41.86	42.79	84.65	122.30	-37.65	Peak	

Orthogonal Axis:	X
Test Mode:	UNII-3/TX N20 Mode 5785MHz

Horizontal

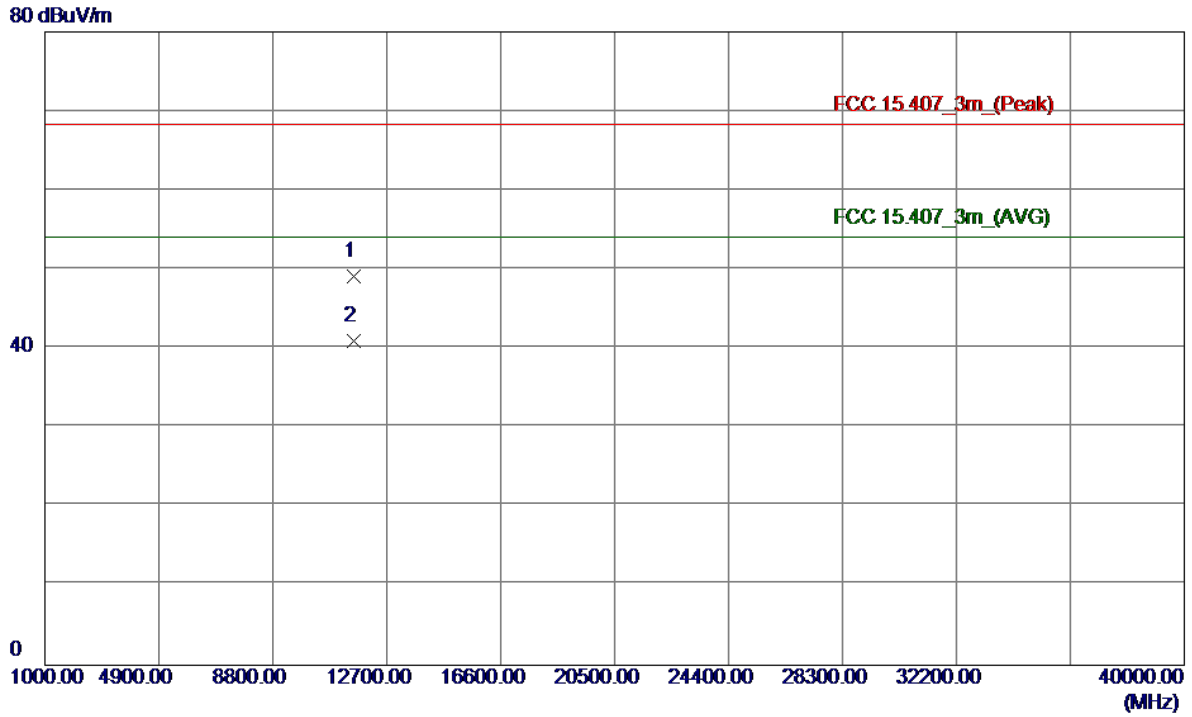

No.	Freq. MHz	Reading Level dBuV/m	Correct Factor dB	Measure ment dBuV/m	Limit dBuV/m	Margin dB	Detector	Comment
1	11570.1200	31.29	17.85	49.14	68.30	-19.16	Peak	
2 *	11570.0199	23.16	17.85	41.01	54.00	-12.99	AVG	

Orthogonal Axis:	X
Test Mode:	UNII-3/TX N20 Mode 5825MHz

Vertical

125 dBuV/m

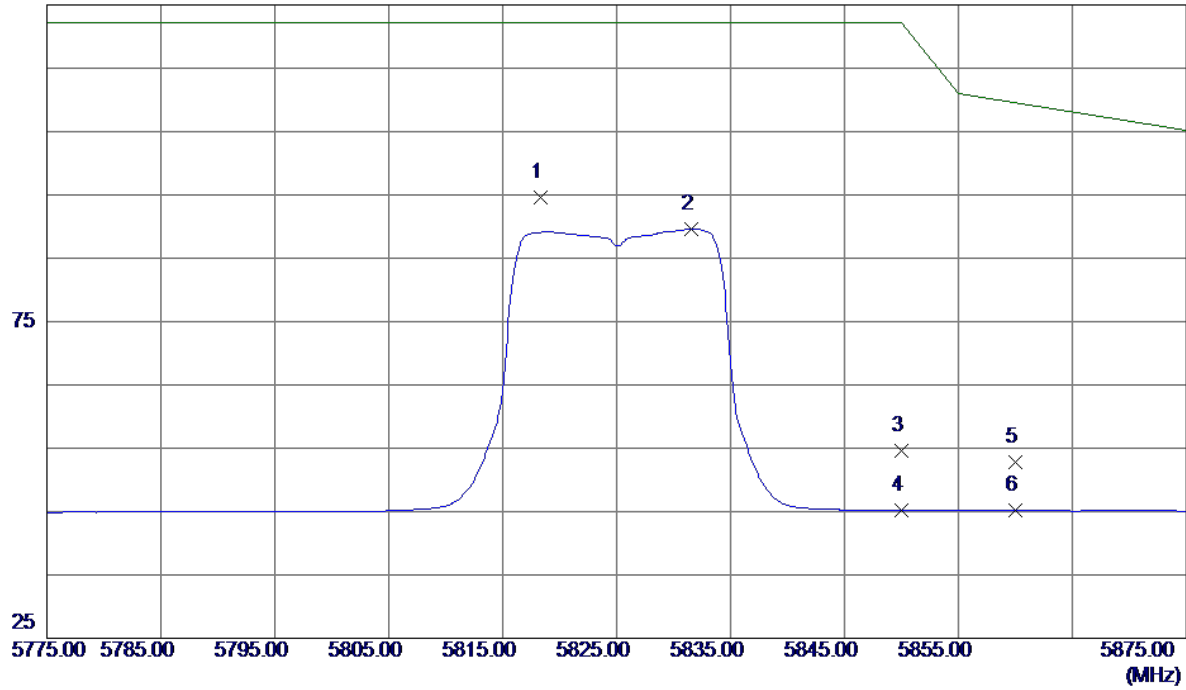

No.	Freq. MHz	Reading Level dBuV/m	Correct Factor dB	Measure ment dBuV/m	Limit dBuV/m	Margin dB	Detector	Comment
1 *	5818.3000	51.84	42.81	94.65	122.30	-27.65	Peak	
2	5831.6000	46.75	42.82	89.57	122.30	-32.73	AVG	
3	5850.0000	11.72	42.84	54.56	122.30	-67.74	Peak	
4	5850.0000	2.32	42.84	45.16	122.30	-77.14	AVG	
5	5860.0000	9.88	42.85	52.73	109.50	-56.77	Peak	
6	5860.0000	2.30	42.85	45.15	109.50	-64.35	AVG	

Orthogonal Axis:	X
Test Mode:	UNII-3/TX N20 Mode 5825MHz

Vertical

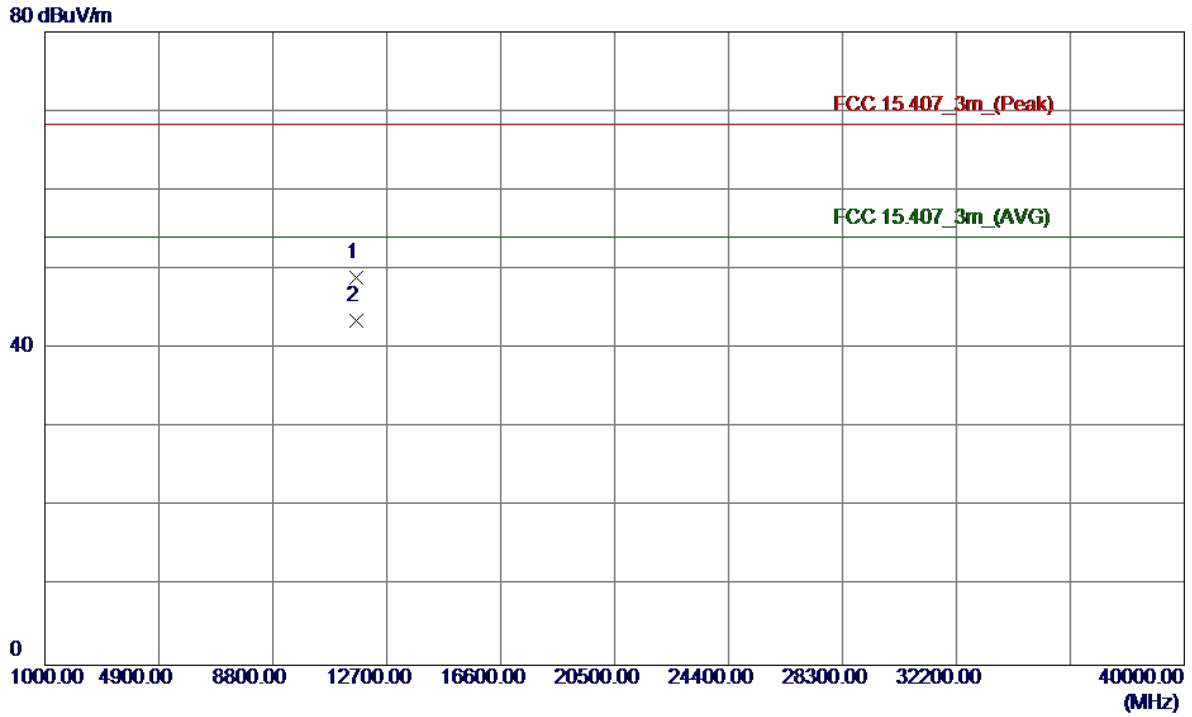

No.	Freq. MHz	Reading Level dBuV/m	Correct Factor dB	Measure ment dBuV/m	Limit dBuV/m	Margin dB	Detector	Comment
1	11649.6800	31.24	17.79	49.03	68.30	-19.27	Peak	
2 *	11649.7800	25.76	17.79	43.55	54.00	-10.45	AVG	

Orthogonal Axis:	X
Test Mode:	UNII-3/TX N20 Mode 5825MHz

Horizontal

125 dBuV/m

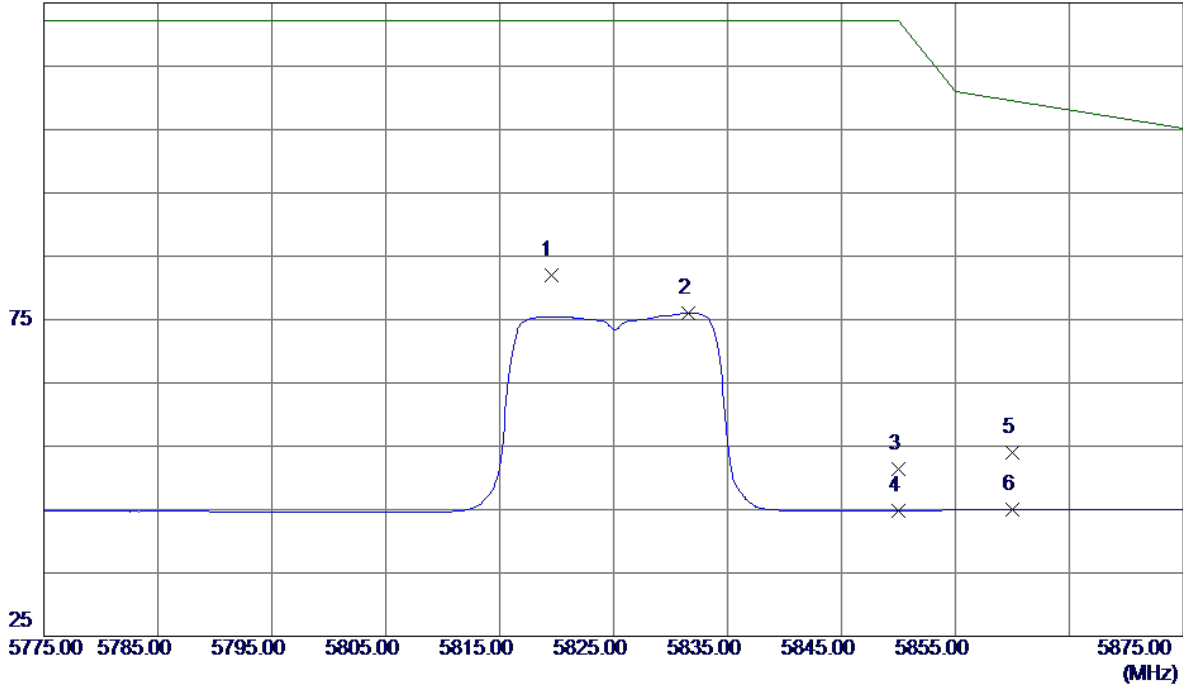

No.	Freq. MHz	Reading Level dBuV/m	Correct Factor dB	Measure ment dBuV/m	Limit dBuV/m	Margin dB	Detector	Comment
1 *	5819.5000	39.15	42.81	81.96	122.30	-40.34	Peak	
2	5831.6000	33.21	42.82	76.03	122.30	-46.27	AVG	
3	5850.0000	8.61	42.84	51.45	122.30	-70.85	Peak	
4	5850.0000	2.05	42.84	44.89	122.30	-77.41	AVG	
5	5860.0000	11.08	42.85	53.93	109.50	-55.57	Peak	
6	5860.0000	2.12	42.85	44.97	109.50	-64.53	AVG	

Orthogonal Axis:	X
Test Mode:	UNII-3/TX N20 Mode 5825MHz

Horizontal

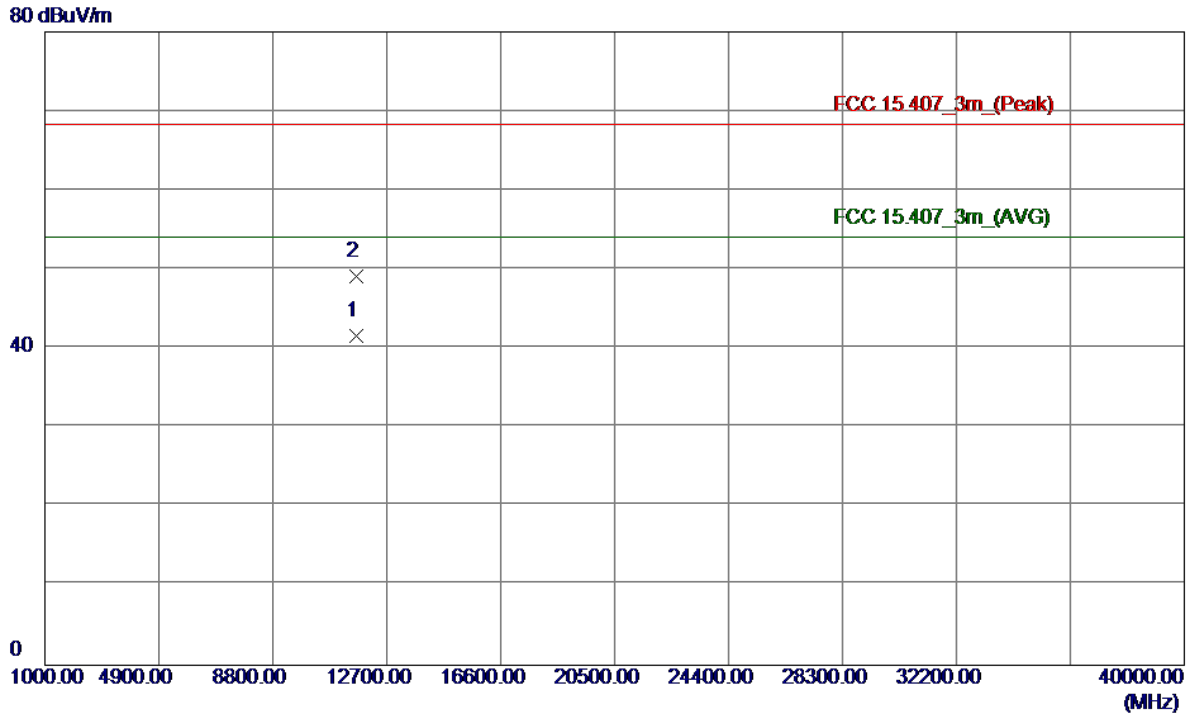

No.	Freq. MHz	Reading Level dBuV/m	Correct Factor dB	Measure ment dBuV/m	Limit dBuV/m	Margin dB	Detector	Comment
1 *	11649.7800	23.74	17.79	41.53	54.00	-12.47	AVG	
2	11649.6800	31.35	17.79	49.14	68.30	-19.16	Peak	

Orthogonal Axis:	X
Test Mode:	UNII-3/TX N40 Mode 5755MHz

Vertical

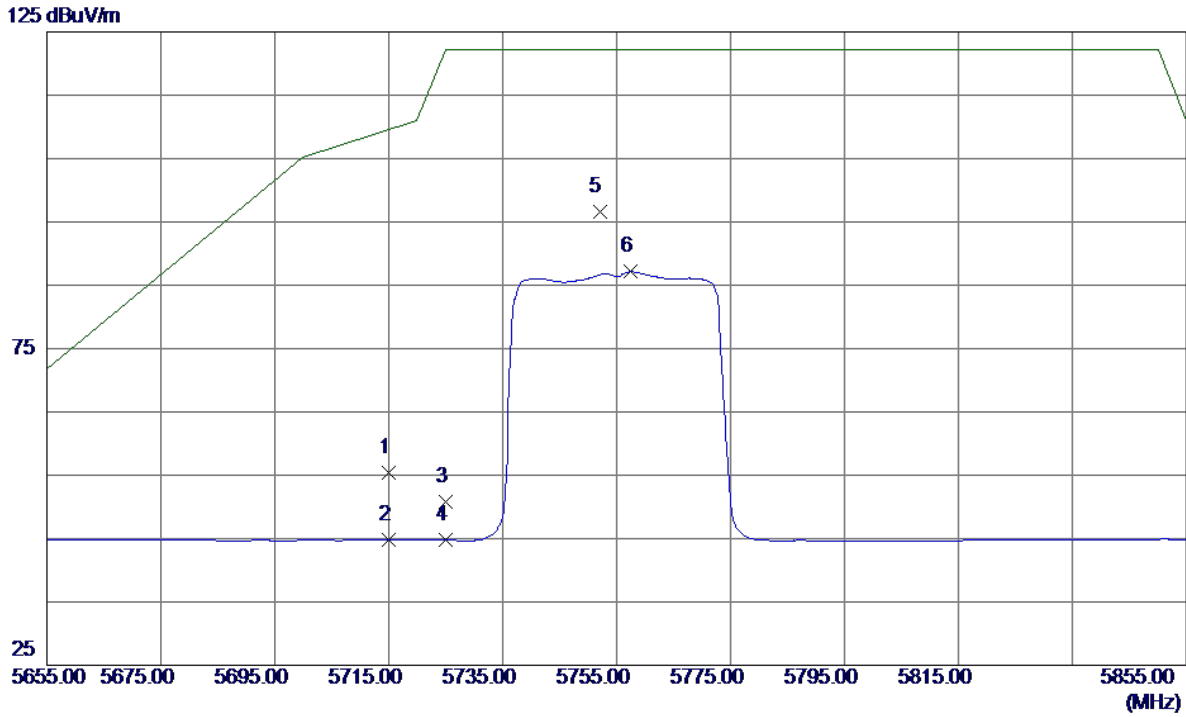

No.	Freq. MHz	Reading Level dBuV/m	Correct Factor dB	Measure ment dBuV/m	Limit dBuV/m	Margin dB	Detector	Comment
1	5715.0000	12.60	42.72	55.32	109.50	-54.18	Peak	
2	5715.0000	2.15	42.72	44.87	109.50	-64.63	AVG	
3	5725.0000	8.14	42.73	50.87	122.30	-71.43	Peak	
4	5725.0000	2.00	42.73	44.73	122.30	-77.57	AVG	
5 *	5752.0000	53.88	42.75	96.63	122.30	-25.67	Peak	
6	5757.4000	44.37	42.76	87.13	122.30	-35.17	AVG	

Orthogonal Axis:	X
Test Mode:	UNII-3/TX N40 Mode 5755MHz

Vertical

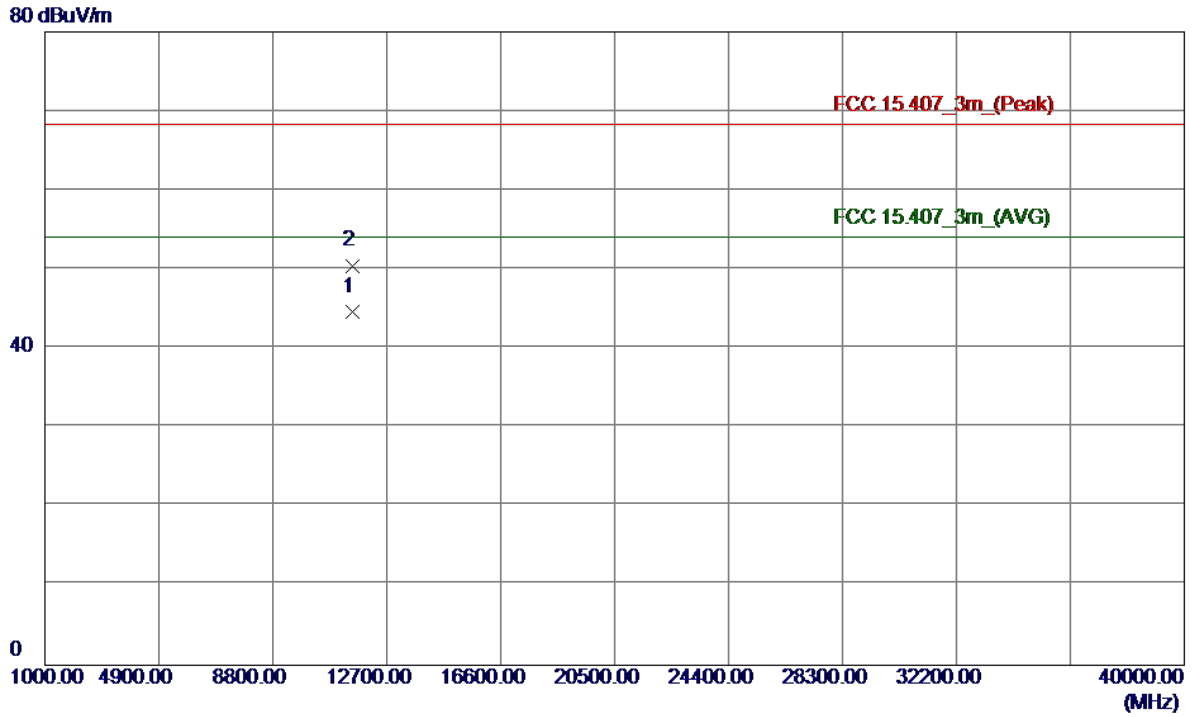

No.	Freq. MHz	Reading Level dBuV/m	Correct Factor dB	Measure ment dBuV/m	Limit dBuV/m	Margin dB	Detector	Comment
1 *	11509.9550	26.68	17.90	44.58	54.00	-9.42	AVG	
2	11509.8550	32.58	17.90	50.48	68.30	-17.82	Peak	

Orthogonal Axis:	X
Test Mode:	UNII-3/TX N40 Mode 5755MHz

Horizontal

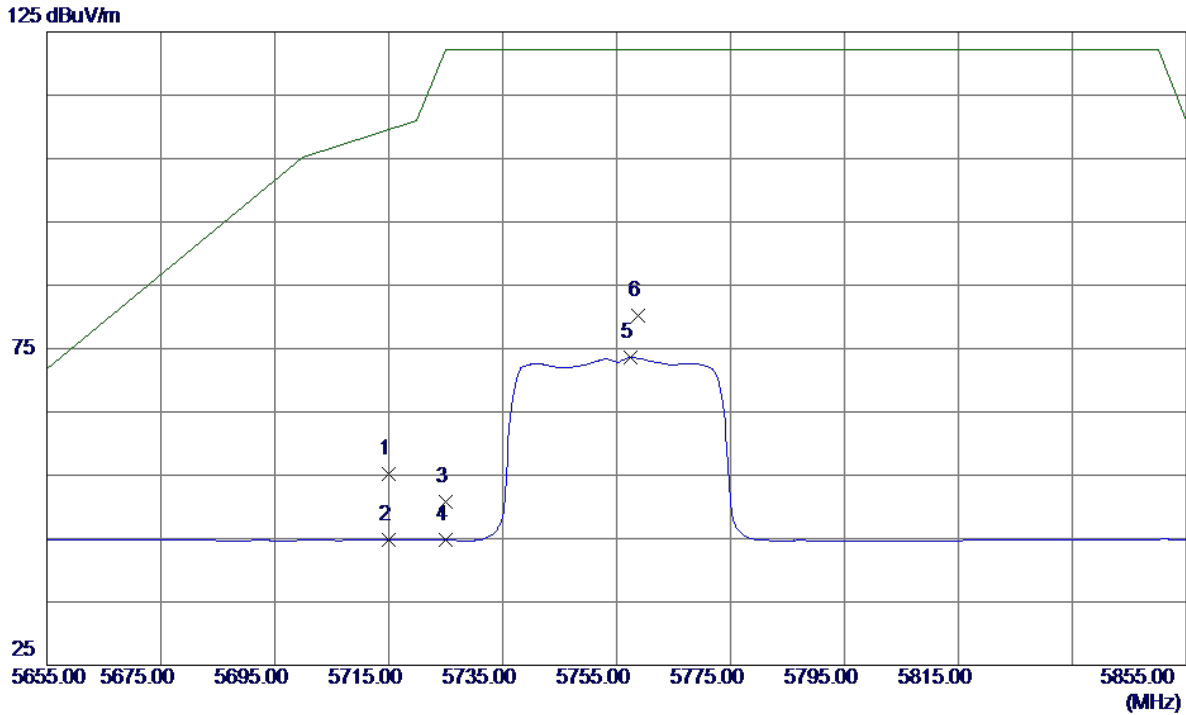

No.	Freq. MHz	Reading Level dBuV/m	Correct Factor dB	Measure ment dBuV/m	Limit dBuV/m	Margin dB	Detector	Comment
1	5715.0000	12.50	42.72	55.22	109.50	-54.28	Peak	
2	5715.0000	2.13	42.72	44.85	109.50	-64.65	AVG	
3	5725.0000	8.13	42.73	50.86	122.30	-71.44	Peak	
4	5725.0000	2.00	42.73	44.73	122.30	-77.57	AVG	
5	5757.4000	30.87	42.76	73.63	122.30	-48.67	AVG	
6 *	5758.8000	37.40	42.76	80.16	122.30	-42.14	Peak	

Orthogonal Axis:	X
Test Mode:	UNII-3/TX N40 Mode 5755MHz

Horizontal

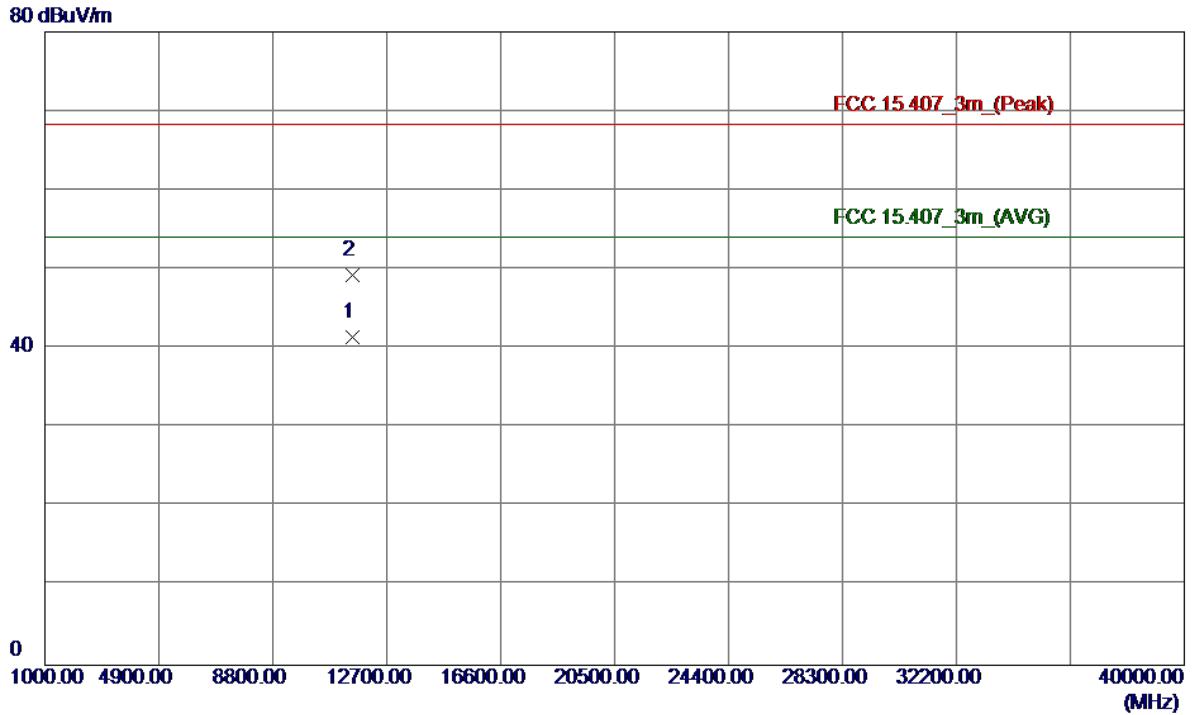

No.	Freq. MHz	Reading Level dBuV/m	Correct Factor dB	Measure ment dBuV/m	Limit dBuV/m	Margin dB	Detector	Comment
1 *	11509.9550	23.58	17.90	41.48	54.00	-12.52	AVG	
2	11509.8550	31.43	17.90	49.33	68.30	-18.97	Peak	

Orthogonal Axis:	X
Test Mode:	UNII-3/TX N40 Mode 5795MHz

Vertical

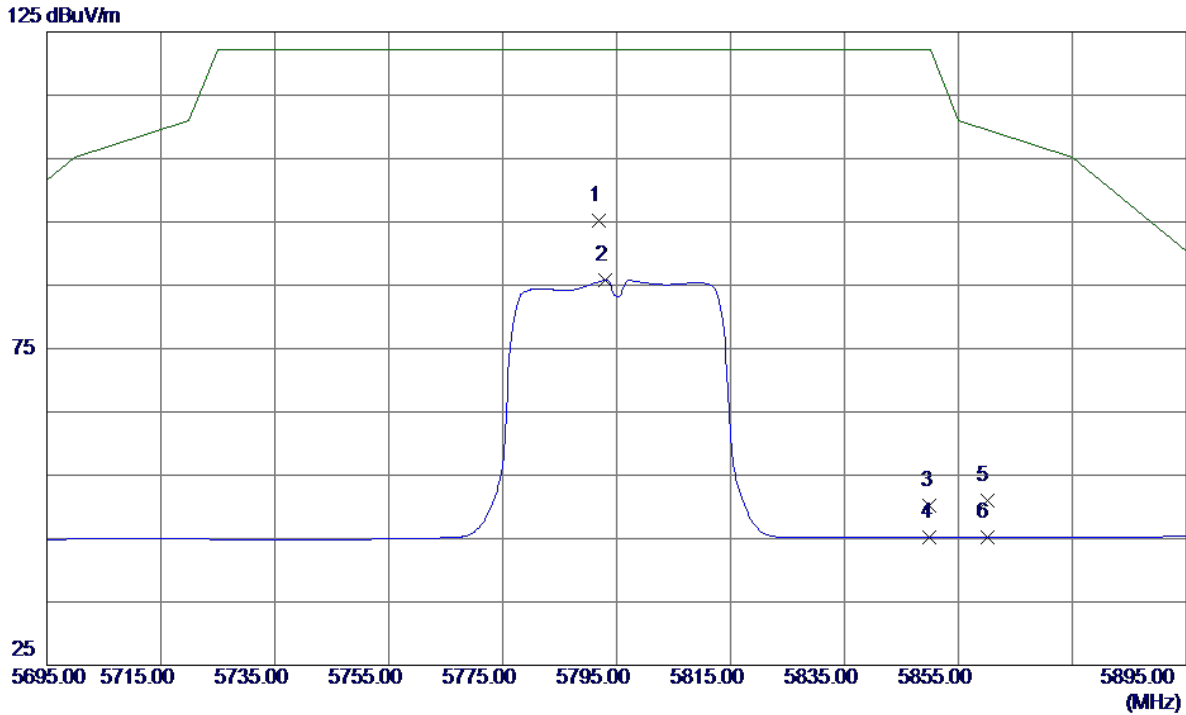

No.	Freq. MHz	Reading Level dBuV/m	Correct Factor dB	Measure ment dBuV/m	Limit dBuV/m	Margin dB	Detector	Comment
1 *	5791.8000	52.44	42.79	95.23	122.30	-27.07	Peak	
2	5793.0000	42.97	42.79	85.76	122.30	-36.54	AVG	
3	5850.0000	7.32	42.84	50.16	122.30	-72.14	Peak	
4	5850.0000	2.34	42.84	45.18	122.30	-77.12	AVG	
5	5860.0000	8.21	42.85	51.06	109.50	-58.44	Peak	
6	5860.0000	2.33	42.85	45.18	109.50	-64.32	AVG	

Orthogonal Axis:	X
Test Mode:	UNII-3/TX N40 Mode 5795MHz

Vertical

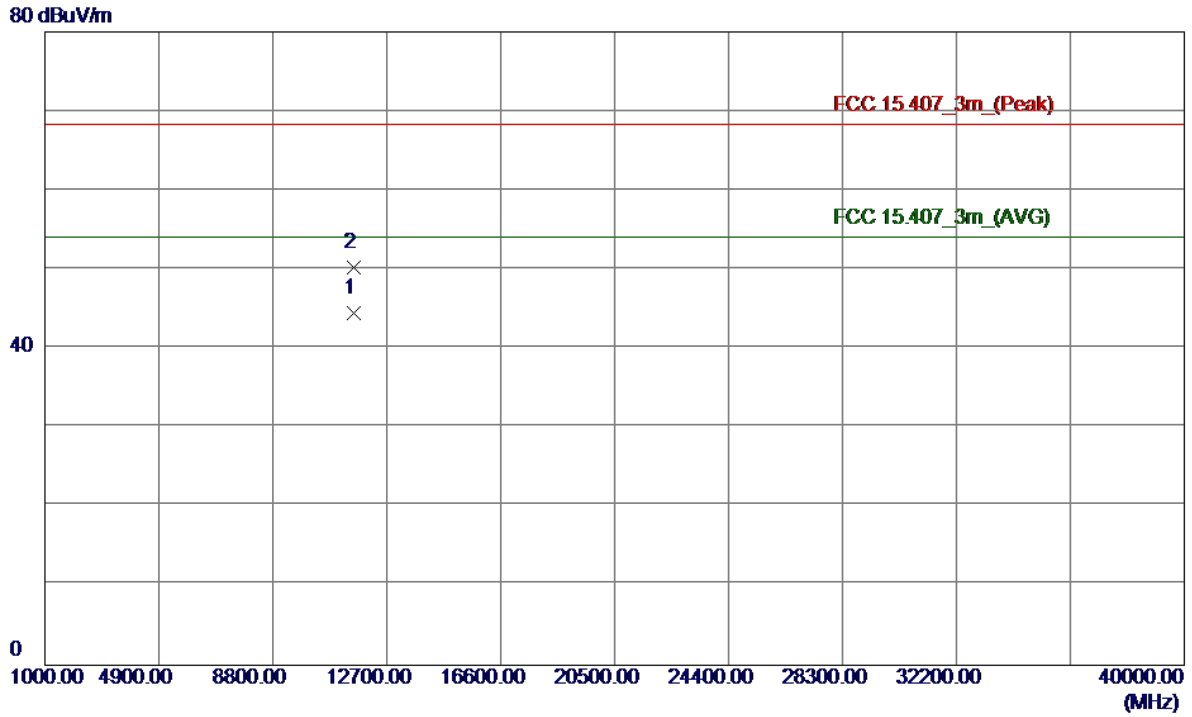

No.	Freq. MHz	Reading Level dBuV/m	Correct Factor dB	Measure ment dBuV/m	Limit dBuV/m	Margin dB	Detector	Comment
1 *	11589.9750	26.62	17.83	44.45	54.00	-9.55	AVG	
2	11589.8750	32.40	17.83	50.23	68.30	-18.07	Peak	

Orthogonal Axis:	X
Test Mode:	UNII-3/TX N40 Mode 5795MHz

Horizontal

125 dBuV/m

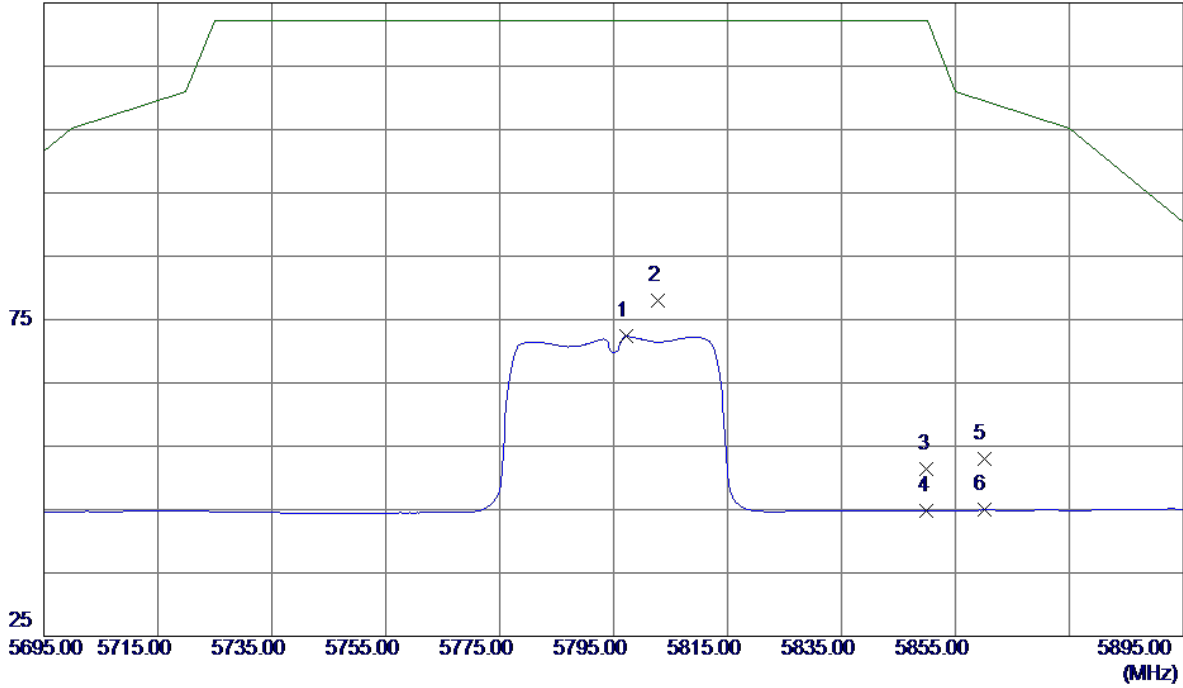

No.	Freq. MHz	Reading Level dBuV/m	Correct Factor dB	Measure ment dBuV/m	Limit dBuV/m	Margin dB	Detector	Comment
1	5797.2000	29.57	42.79	72.36	122.30	-49.94	AVG	
2 *	5802.8000	35.26	42.80	78.06	122.30	-44.24	Peak	
3	5850.0000	8.54	42.84	51.38	122.30	-70.92	Peak	
4	5850.0000	2.00	42.84	44.84	122.30	-77.46	AVG	
5	5860.0000	10.20	42.85	53.05	109.50	-56.45	Peak	
6	5860.0000	2.06	42.85	44.91	109.50	-64.59	AVG	

Orthogonal Axis:	X
Test Mode:	UNII-3/TX N40 Mode 5795MHz

Horizontal

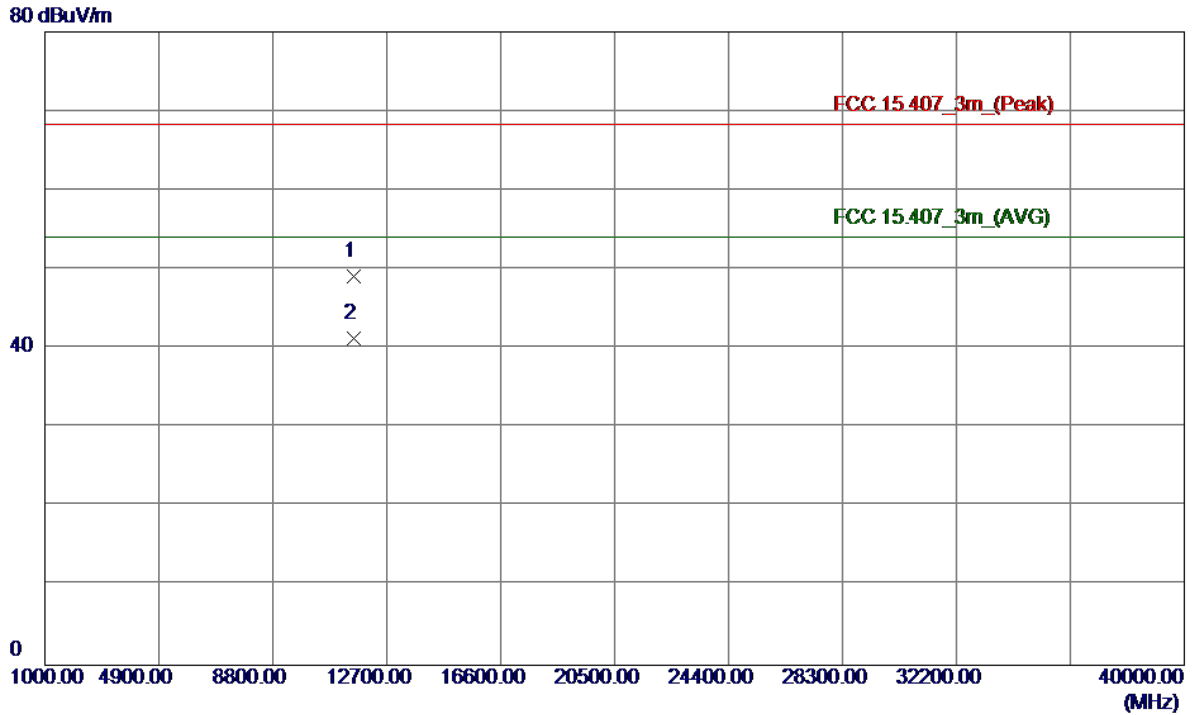

No.	Freq. MHz	Reading Level dBuV/m	Correct Factor dB	Measure ment dBuV/m	Limit dBuV/m	Margin dB	Detector	Comment
1	11589.9750	31.35	17.83	49.18	68.30	-19.12	Peak	
2 *	11589.9850	23.44	17.83	41.27	54.00	-12.73	AVG	

Orthogonal Axis:	X
Test Mode:	UNII-1/ TX AC20 Mode 5180MHz

Vertical

120 dBuV/m

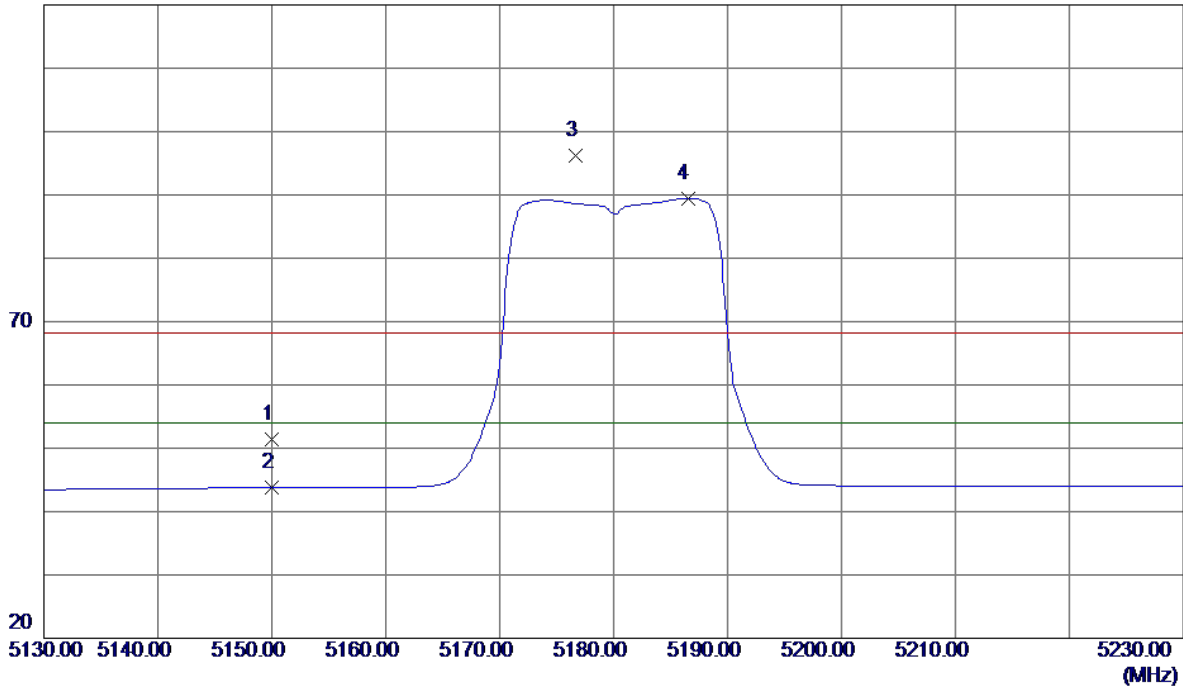

No.	Freq. MHz	Reading Level dBuV/m	Correct Factor dB	Measure ment dBuV/m	Limit dBuV/m	Margin dB	Detector	Comment
1	5150.0000	10.02	41.35	51.37	68.30	-16.93	Peak	
2	5150.0000	2.37	41.35	43.72	54.00	-10.28	AVG	
3	5176.7000	54.72	41.44	96.16	68.30	27.86	Peak	No Limit
4 *	5186.5000	47.99	41.47	89.46	54.00	35.46	AVG	No Limit

Orthogonal Axis:	X
Test Mode:	UNII-1/ TX AC20 Mode 5180MHz

Vertical

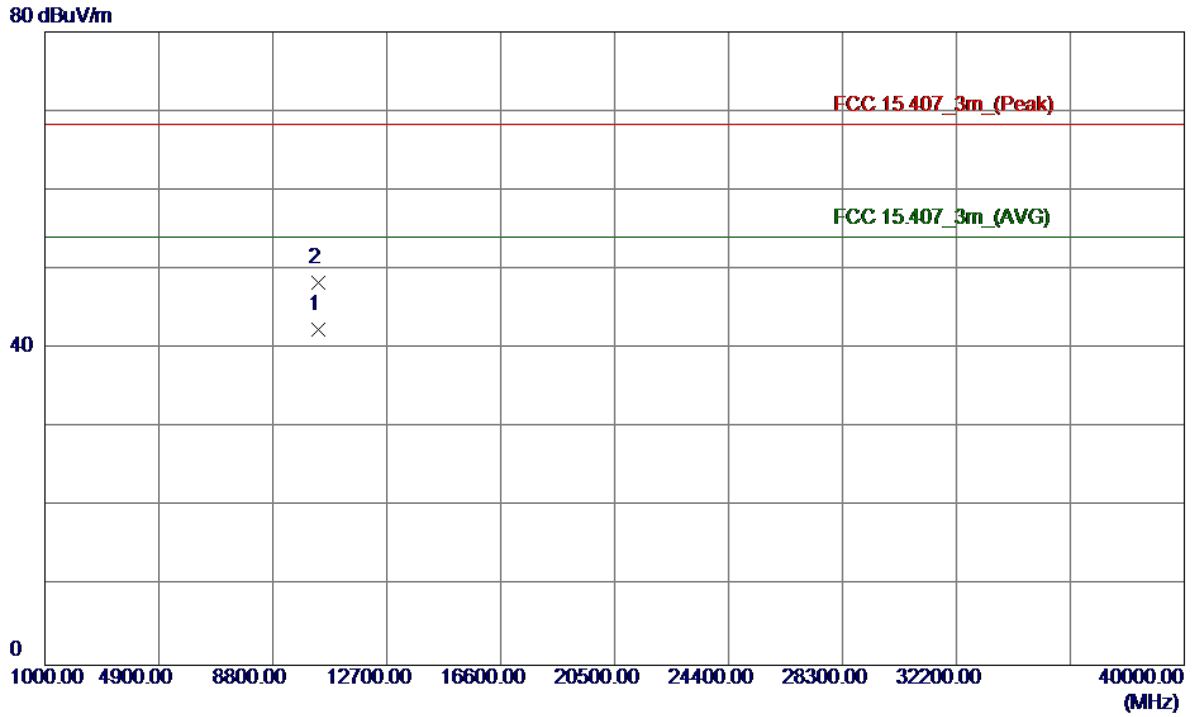

No.	Freq. MHz	Reading Level dBuV/m	Correct Factor dB	Measure ment dBuV/m	Limit dBuV/m	Margin dB	Detector	Comment
1 *	10360.0300	26.01	16.36	42.37	54.00	-11.63	AVG	
2	10360.1750	31.91	16.36	48.27	68.30	-20.03	Peak	

Orthogonal Axis:	X
Test Mode:	UNII-1/ TX AC20 Mode 5180MHz

Horizontal

120 dBuV/m

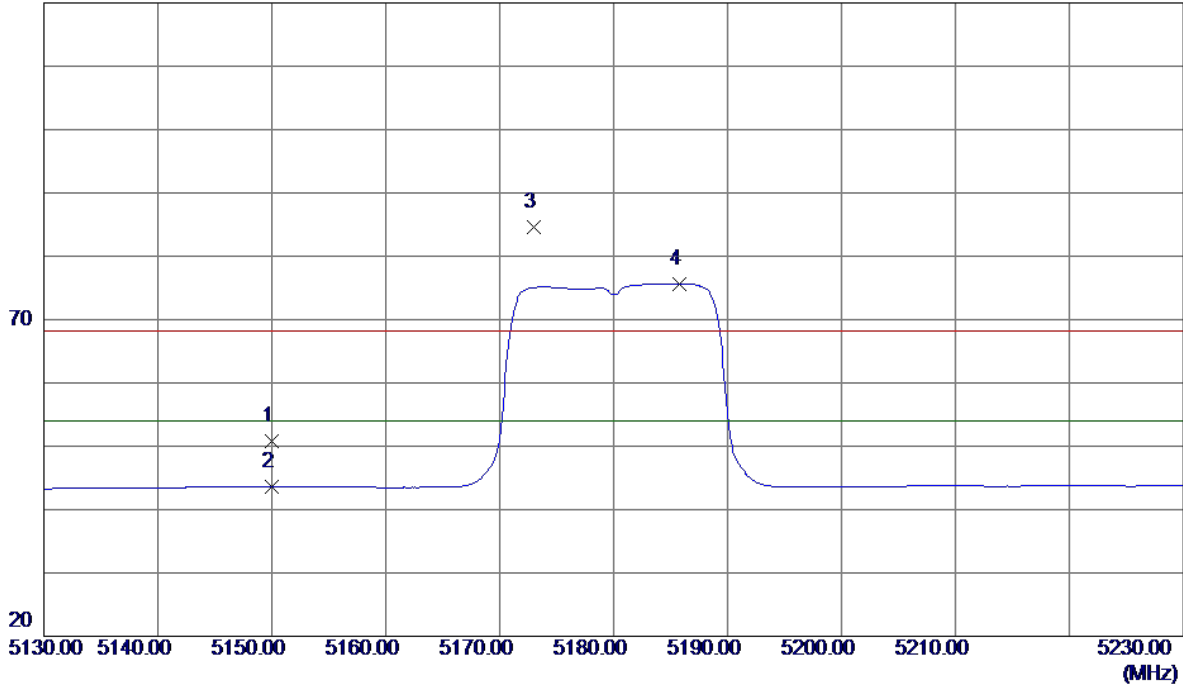

No.	Freq. MHz	Reading Level dBuV/m	Correct Factor dB	Measure ment dBuV/m	Limit dBuV/m	Margin dB	Detector	Comment
1	5150.0000	9.49	41.35	50.84	68.30	-17.46	Peak	
2	5150.0000	2.20	41.35	43.55	54.00	-10.45	AVG	
3	5173.0000	43.14	41.42	84.56	68.30	16.26	Peak	No Limit
4 *	5185.8000	34.22	41.47	75.69	54.00	21.69	AVG	No Limit

Orthogonal Axis:	X
Test Mode:	UNII-1/ TX AC20 Mode 5180MHz

Horizontal

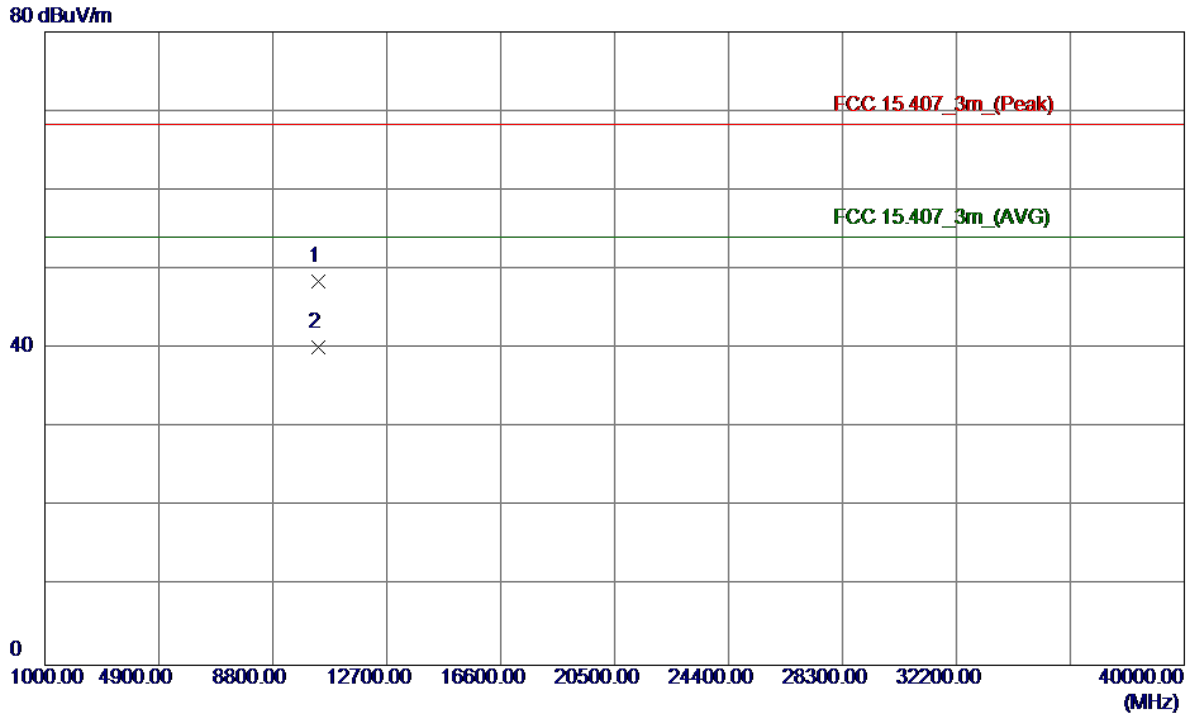

No.	Freq. MHz	Reading Level dBuV/m	Correct Factor dB	Measure ment dBuV/m	Limit dBuV/m	Margin dB	Detector	Comment
1	10360.1750	32.08	16.36	48.44	68.30	-19.86	Peak	
2 *	10360.0750	23.78	16.36	40.14	54.00	-13.86	AVG	

Orthogonal Axis:	X
Test Mode:	UNII-1/ TX AC20 Mode 5200MHz

Vertical

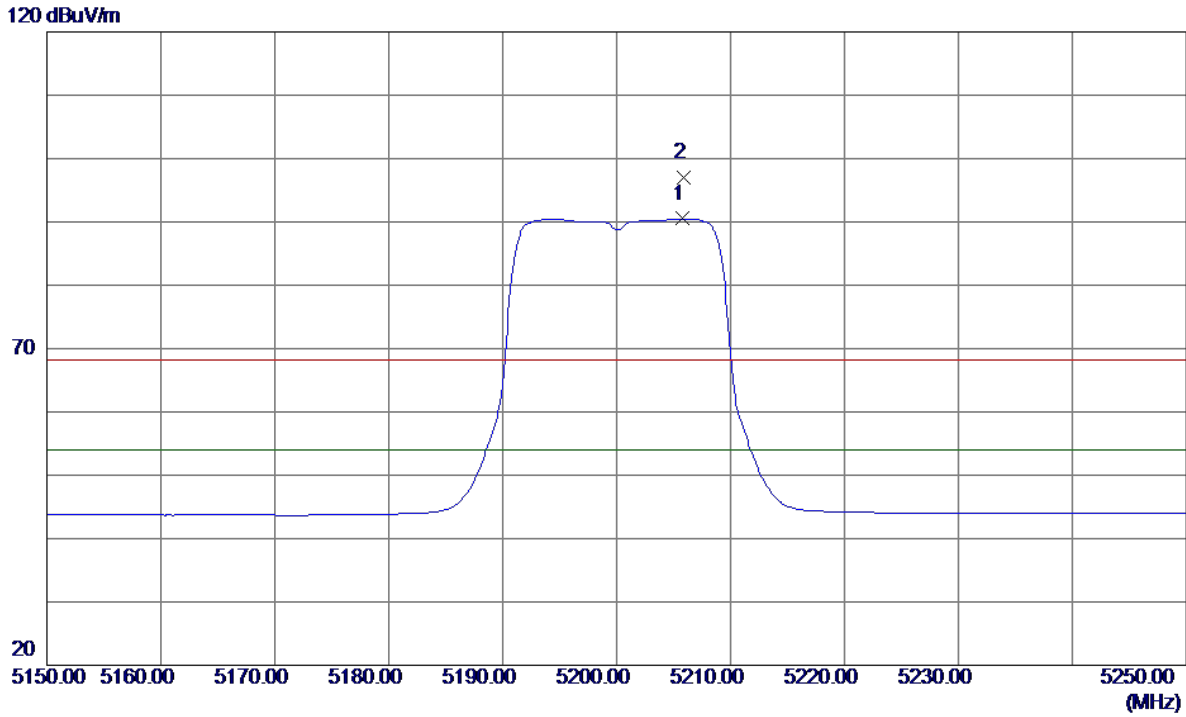

No.	Freq. MHz	Reading Level dBuV/m	Correct Factor dB	Measure ment dBuV/m	Limit dBuV/m	Margin dB	Detector	Comment
1 *	5205.8000	48.96	41.54	90.50	54.00	36.50	AVG	No Limit
2	5205.9000	55.39	41.54	96.93	68.30	28.63	Peak	No Limit

Orthogonal Axis:	X
Test Mode:	UNII-1/ TX AC20 Mode 5200MHz

Vertical

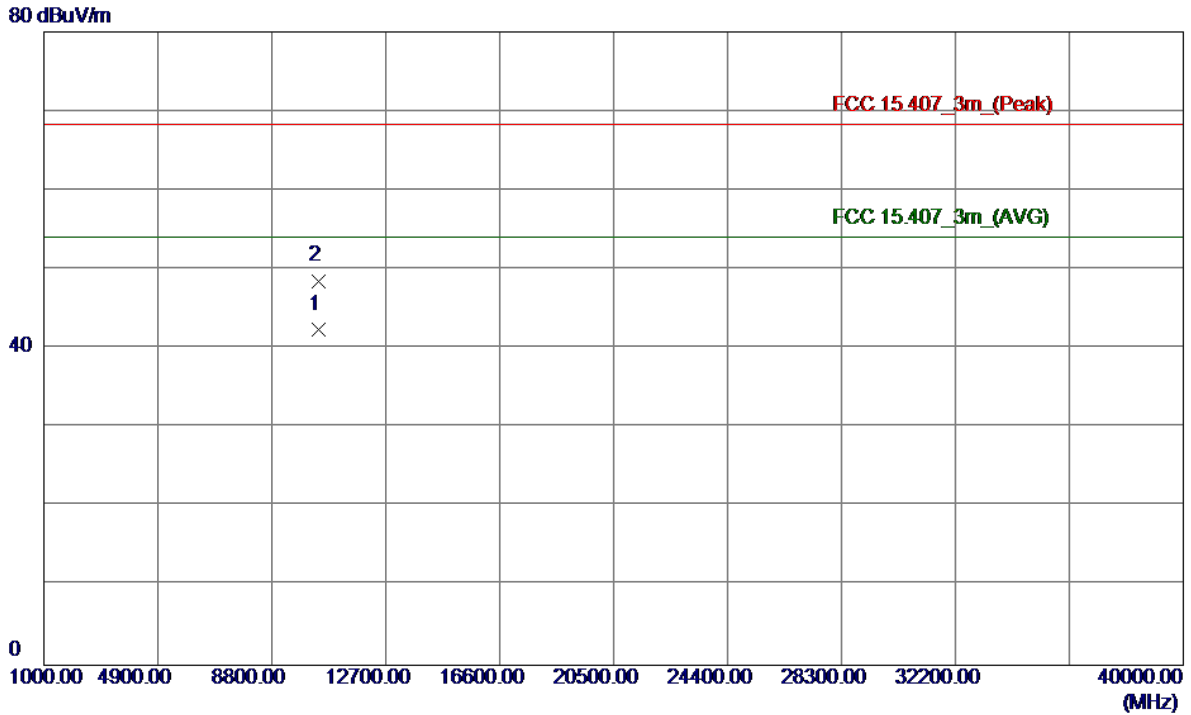

No.	Freq. MHz	Reading Level dBuV/m	Correct Factor dB	Measure ment dBuV/m	Limit dBuV/m	Margin dB	Detector	Comment
1 *	10400.0150	25.97	16.45	42.42	54.00	-11.58	AVG	
2	10400.1050	32.11	16.45	48.56	68.30	-19.74	Peak	

Orthogonal Axis:	X
Test Mode:	UNII-1/ TX AC20 Mode 5200MHz

Horizontal

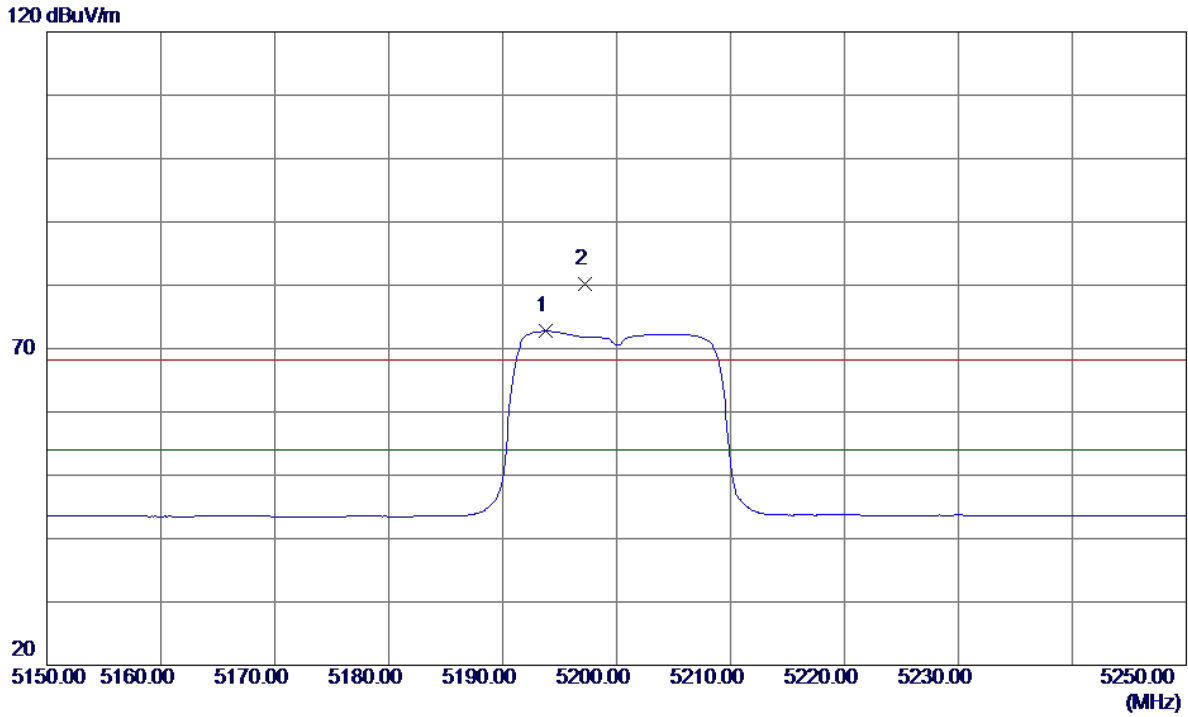

No.	Freq. MHz	Reading Level dBuV/m	Correct Factor dB	Measure ment dBuV/m	Limit dBuV/m	Margin dB	Detector	Comment
1 *	5193.8000	31.25	41.49	72.74	54.00	18.74	AVG	No Limit
2	5197.2000	38.68	41.51	80.19	68.30	11.89	Peak	No Limit

Orthogonal Axis:	X
Test Mode:	UNII-1/ TX AC20 Mode 5200MHz

Horizontal

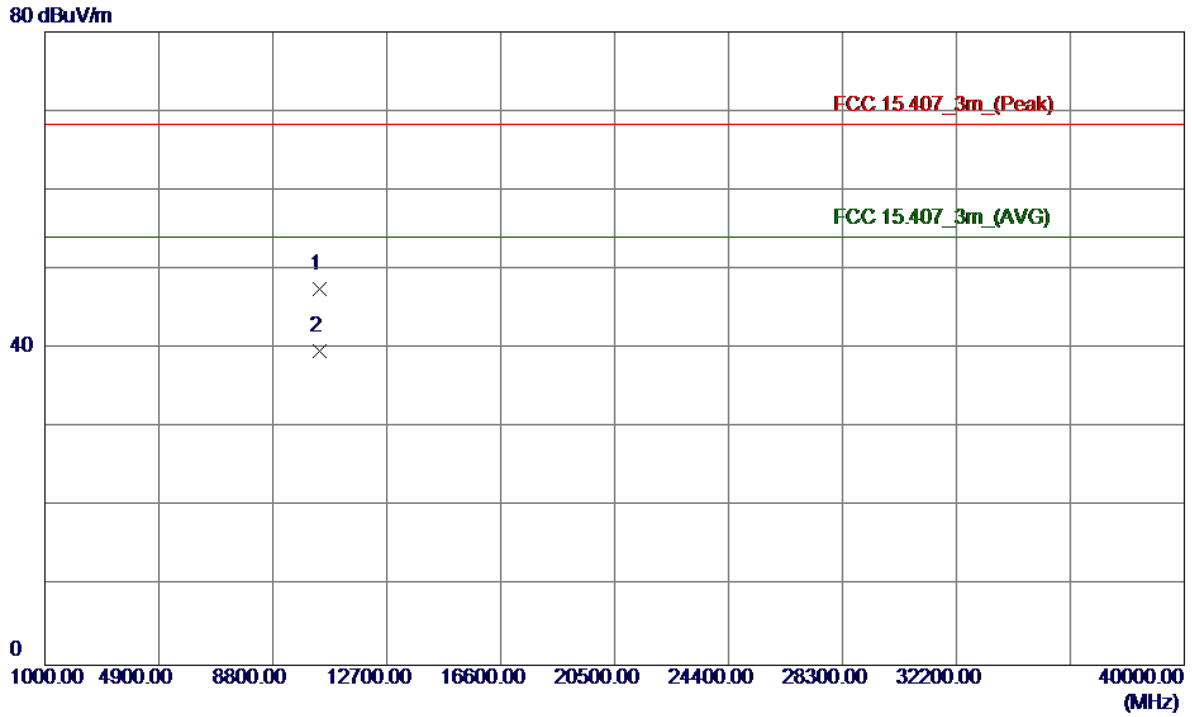

No.	Freq. MHz	Reading Level dBuV/m	Correct Factor dB	Measure ment dBuV/m	Limit dBuV/m	Margin dB	Detector	Comment
1	10400.3050	31.11	16.45	47.56	68.30	-20.74	Peak	
2 *	10400.0250	23.17	16.45	39.62	54.00	-14.38	AVG	

Orthogonal Axis:	X
Test Mode:	UNII-1/ TX AC20 Mode 5240MHz

Vertical

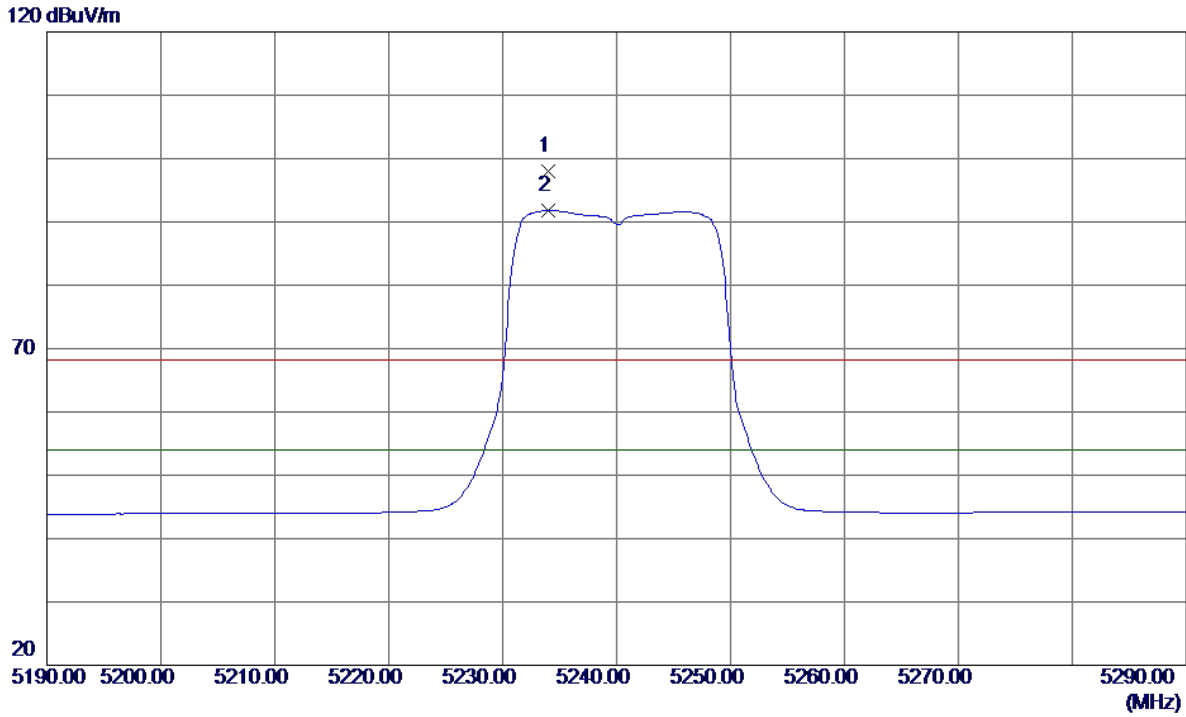

No.	Freq. MHz	Reading Level dBuV/m	Correct Factor dB	Measure ment dBuV/m	Limit dBuV/m	Margin dB	Detector	Comment
1	5234.0000	56.44	41.63	98.07	68.30	29.77	Peak	No Limit
2 *	5234.0000	50.16	41.63	91.79	54.00	37.79	AVG	No Limit

Orthogonal Axis:	X
Test Mode:	UNII-1/ TX AC20 Mode 5240MHz

Vertical

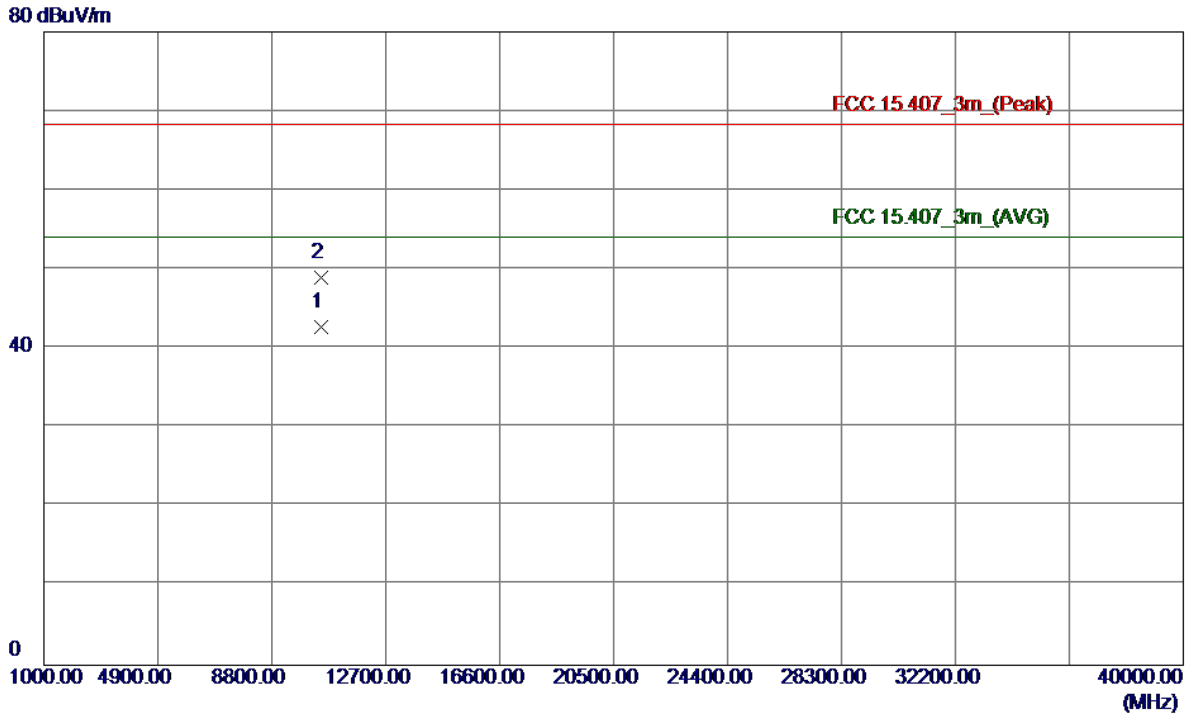

No.	Freq. MHz	Reading Level dBuV/m	Correct Factor dB	Measure ment dBuV/m	Limit dBuV/m	Margin dB	Detector	Comment
1 *	10480.2500	26.13	16.63	42.76	54.00	-11.24	AVG	
2	10480.4100	32.40	16.63	49.03	68.30	-19.27	Peak	

Orthogonal Axis:	X
Test Mode:	UNII-1/ TX AC20 Mode 5240MHz

Horizontal

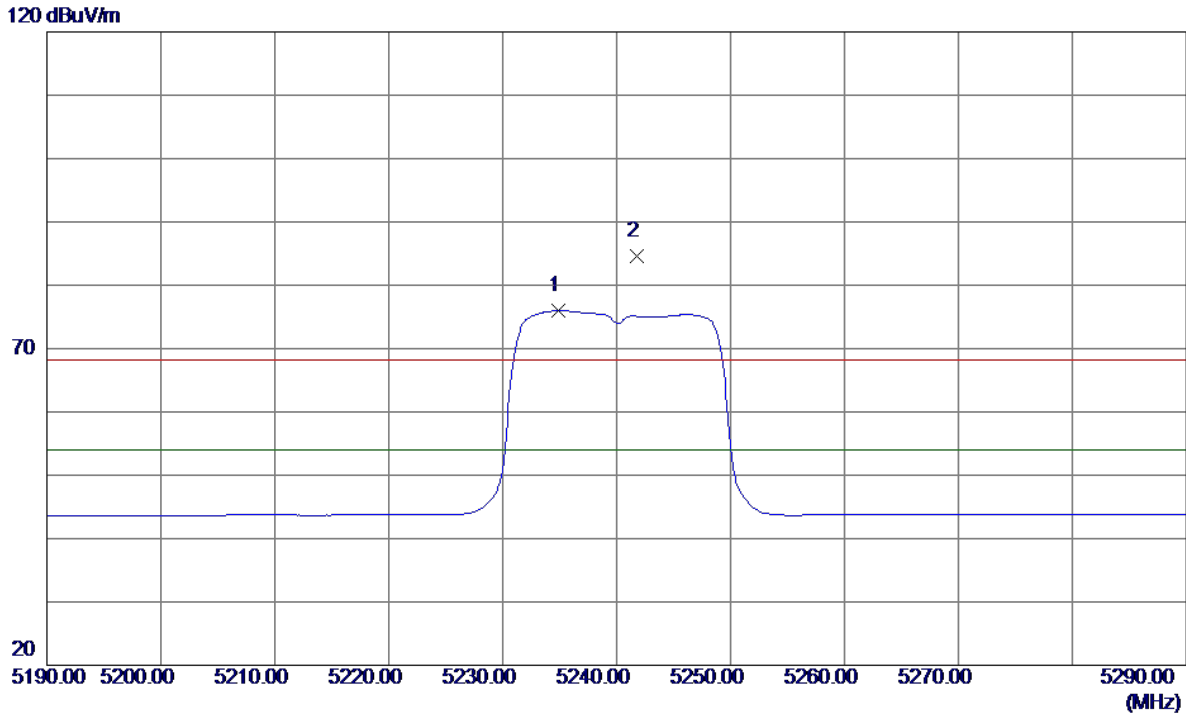

No.	Freq. MHz	Reading Level dBuV/m	Correct Factor dB	Measure ment dBuV/m	Limit dBuV/m	Margin dB	Detector	Comment
1 *	5234.9000	34.33	41.63	75.96	54.00	21.96	AVG	No Limit
2	5241.8000	43.02	41.66	84.68	68.30	16.38	Peak	No Limit

Orthogonal Axis:	X
Test Mode:	UNII-1/ TX AC20 Mode 5240MHz

Horizontal

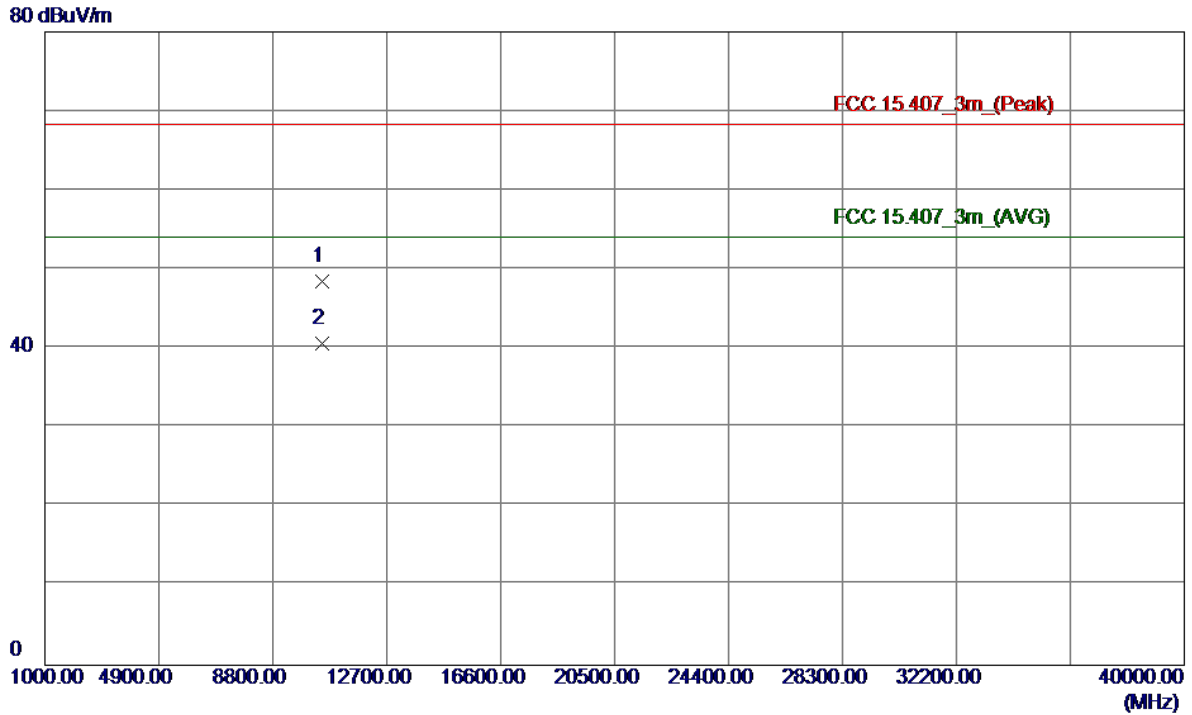

No.	Freq. MHz	Reading Level dBuV/m	Correct Factor dB	Measure ment dBuV/m	Limit dBuV/m	Margin dB	Detector	Comment
1	10480.0100	31.83	16.63	48.46	68.30	-19.84	Peak	
2 *	10480.0050	23.99	16.63	40.62	54.00	-13.38	AVG	

Orthogonal Axis:	X
Test Mode:	UNII-1/ TX AC40 Mode 5190MHz

Vertical

120 dBuV/m

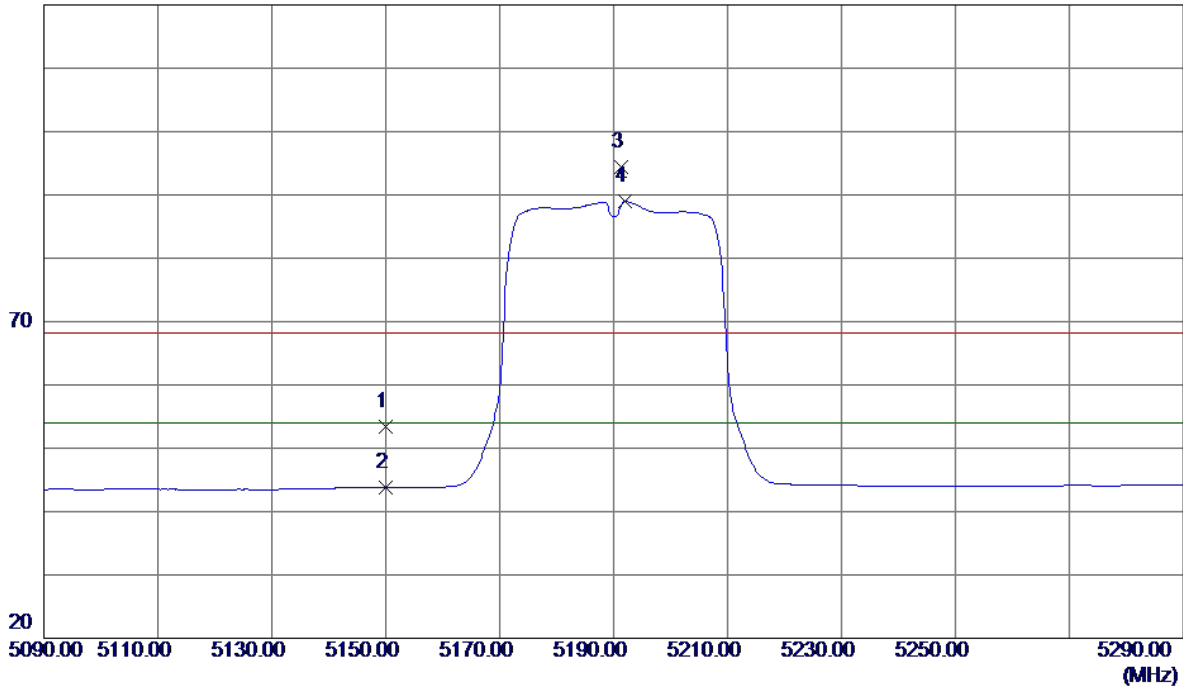

No.	Freq. MHz	Reading Level dBuV/m	Correct Factor dB	Measure ment dBuV/m	Limit dBuV/m	Margin dB	Detector	Comment
1	5150.0000	12.01	41.35	53.36	68.30	-14.94	Peak	
2	5150.0000	2.45	41.35	43.80	54.00	-10.20	AVG	
3	5191.4000	52.95	41.49	94.44	68.30	26.14	Peak	No Limit
4 *	5192.0000	47.48	41.49	88.97	54.00	34.97	AVG	No Limit

Orthogonal Axis:	X
Test Mode:	UNII-1/ TX AC40 Mode 5190MHz

Vertical

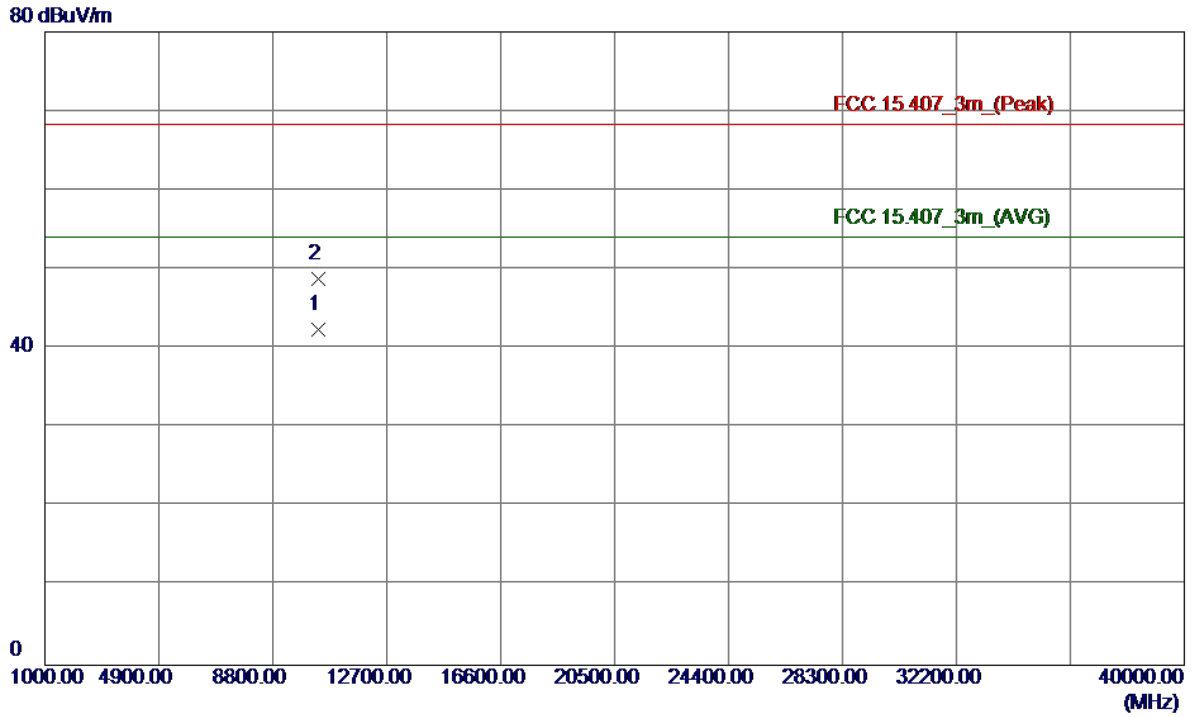

No.	Freq. MHz	Reading Level dBuV/m	Correct Factor dB	Measure ment dBuV/m	Limit dBuV/m	Margin dB	Detector	Comment
1 *	10380.1000	25.96	16.40	42.36	54.00	-11.64	AVG	
2	10380.1449	32.42	16.40	48.82	68.30	-19.48	Peak	

Orthogonal Axis:	X
Test Mode:	UNII-1/ TX AC40 Mode 5190MHz

Horizontal

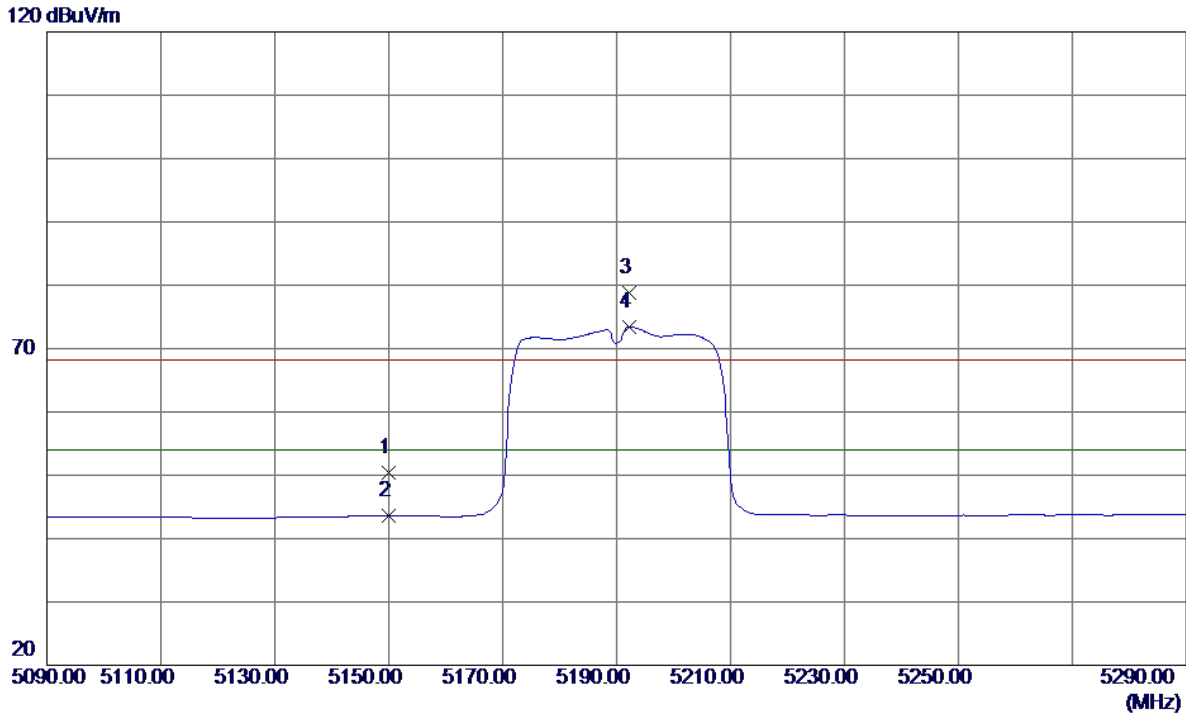

No.	Freq. MHz	Reading Level dBuV/m	Correct Factor dB	Measure ment dBuV/m	Limit dBuV/m	Margin dB	Detector	Comment
1	5150.0000	9.03	41.35	50.38	68.30	-17.92	Peak	
2	5150.0000	2.19	41.35	43.54	54.00	-10.46	AVG	
3	5192.2000	37.26	41.49	78.75	68.30	10.45	Peak	No Limit
4 *	5192.2000	32.00	41.49	73.49	54.00	19.49	AVG	No Limit

Orthogonal Axis:	X
Test Mode:	UNII-1/ TX AC40 Mode 5190MHz

Horizontal

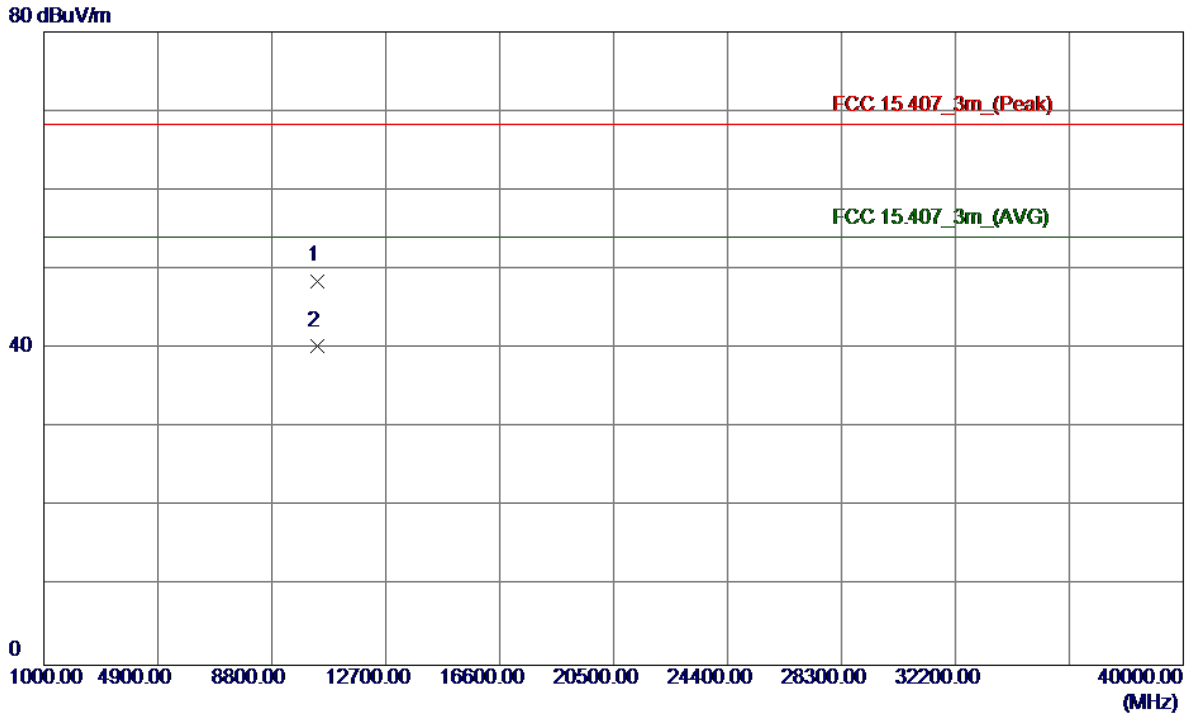

No.	Freq. MHz	Reading Level dBuV/m	Correct Factor dB	Measure ment dBuV/m	Limit dBuV/m	Margin dB	Detector	Comment
1	10380.1650	32.16	16.40	48.56	68.30	-19.74	Peak	
2 *	10380.1449	23.99	16.40	40.39	54.00	-13.61	AVG	

Orthogonal Axis:	X
Test Mode:	UNII-1/ TX AC40 Mode 5230MHz

Vertical

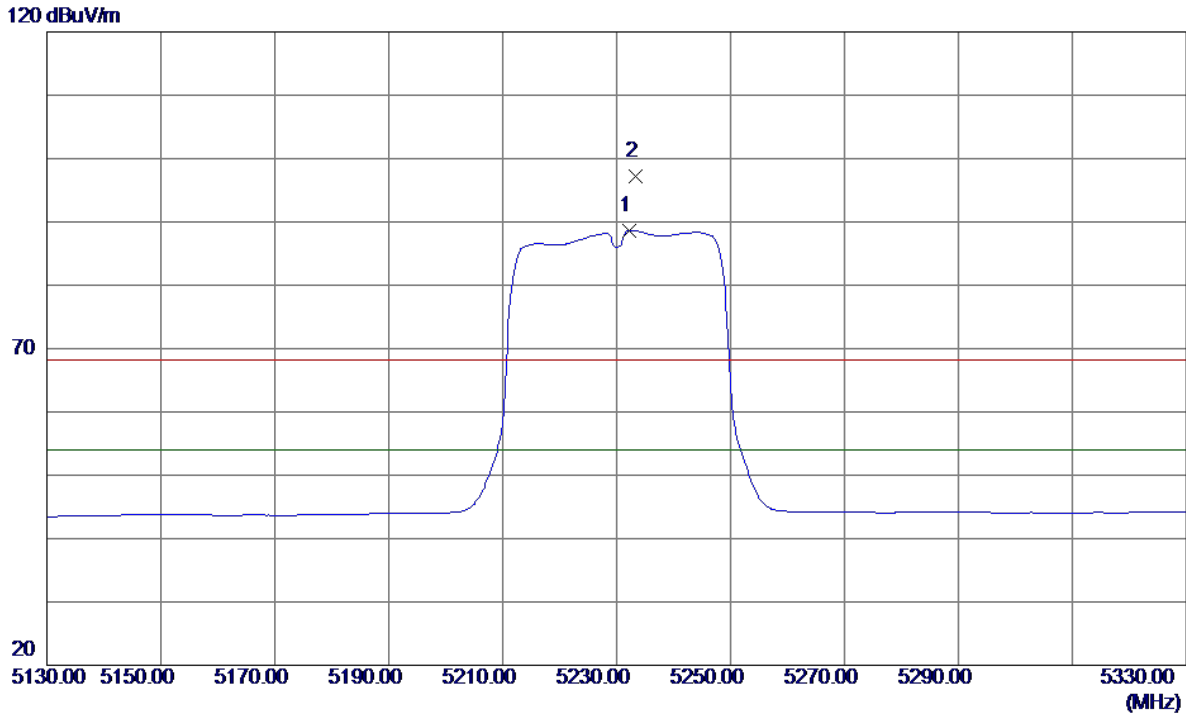

No.	Freq. MHz	Reading Level dBuV/m	Correct Factor dB	Measure ment dBuV/m	Limit dBuV/m	Margin dB	Detector	Comment
1 *	5232.2000	47.02	41.62	88.64	54.00	34.64	AVG	No Limit
2	5233.4000	55.66	41.63	97.29	68.30	28.99	Peak	No Limit

Orthogonal Axis:	X
Test Mode:	UNII-1/ TX AC40 Mode 5230MHz

Vertical

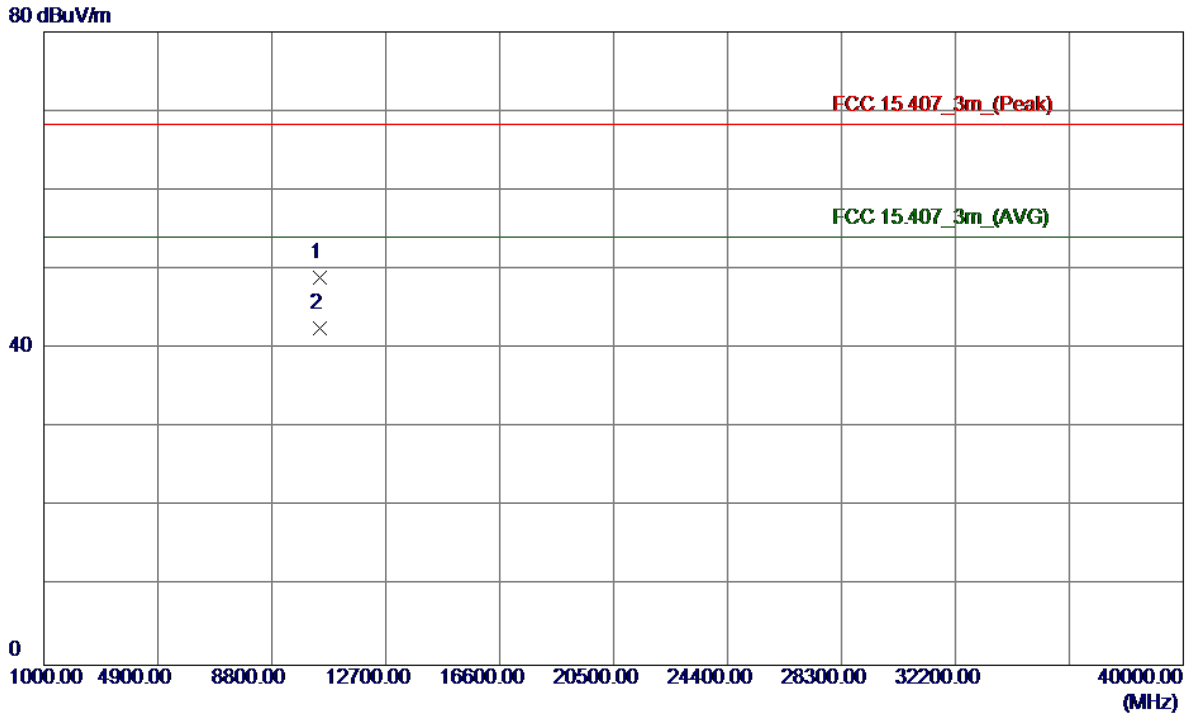

No.	Freq. MHz	Reading Level dBuV/m	Correct Factor dB	Measure ment dBuV/m	Limit dBuV/m	Margin dB	Detector	Comment
1	10460.2550	32.45	16.58	49.03	68.30	-19.27	Peak	
2 *	10460.1550	26.00	16.58	42.58	54.00	-11.42	AVG	

Orthogonal Axis:	X
Test Mode:	UNII-1/ TX AC40 Mode 5230MHz

Horizontal

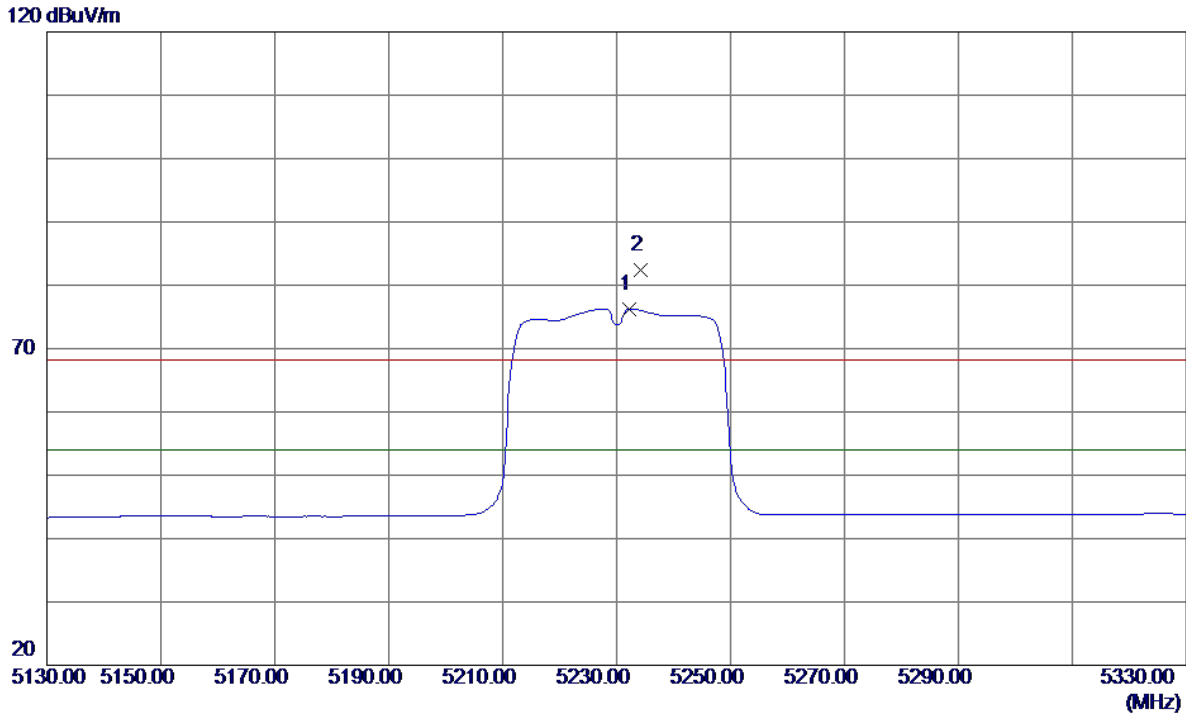

No.	Freq. MHz	Reading Level dBuV/m	Correct Factor dB	Measure ment dBuV/m	Limit dBuV/m	Margin dB	Detector	Comment
1 *	5232.2000	34.64	41.62	76.26	54.00	22.26	AVG	No Limit
2	5234.2000	40.78	41.63	82.41	68.30	14.11	Peak	No Limit

Orthogonal Axis:	X
Test Mode:	UNII-1/ TX AC40 Mode 5230MHz

Horizontal

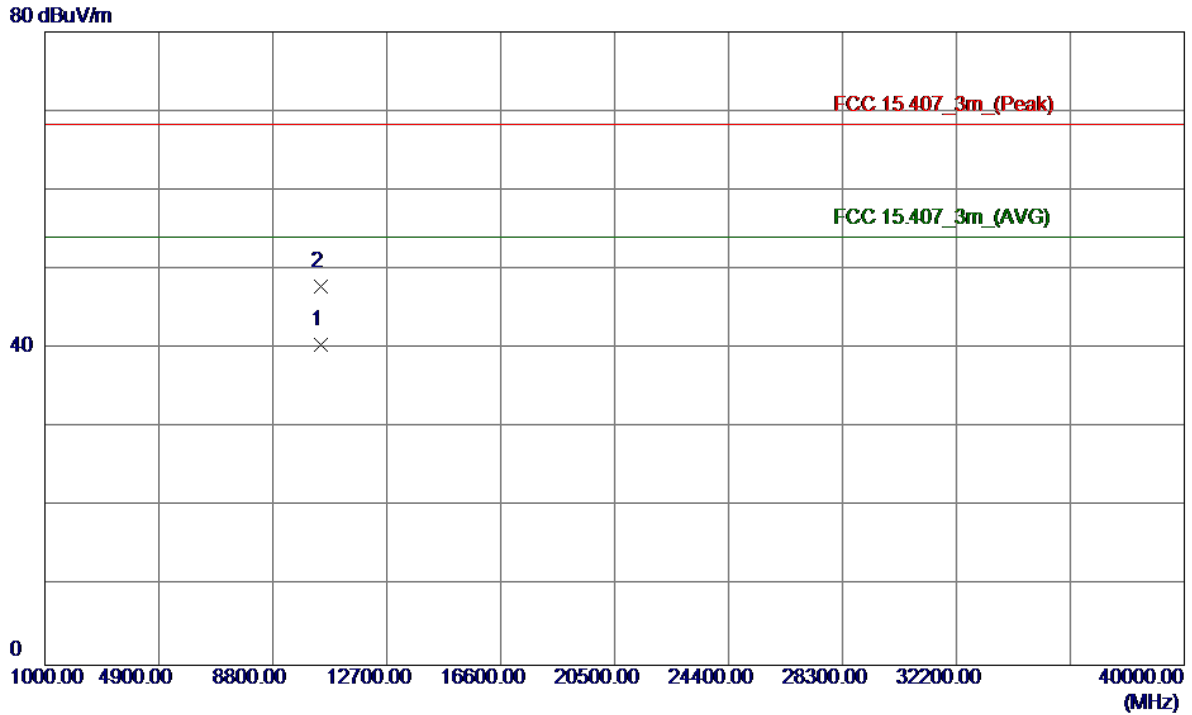

No.	Freq. MHz	Reading Level dBuV/m	Correct Factor dB	Measure ment dBuV/m	Limit dBuV/m	Margin dB	Detector	Comment
1 *	10460.1650	23.89	16.58	40.47	54.00	-13.53	AVG	
2	10460.2550	31.21	16.58	47.79	68.30	-20.51	Peak	

Orthogonal Axis:	X
Test Mode:	UNII-1/ TX AC80 Mode 5210MHz

Vertical

120 dBuV/m

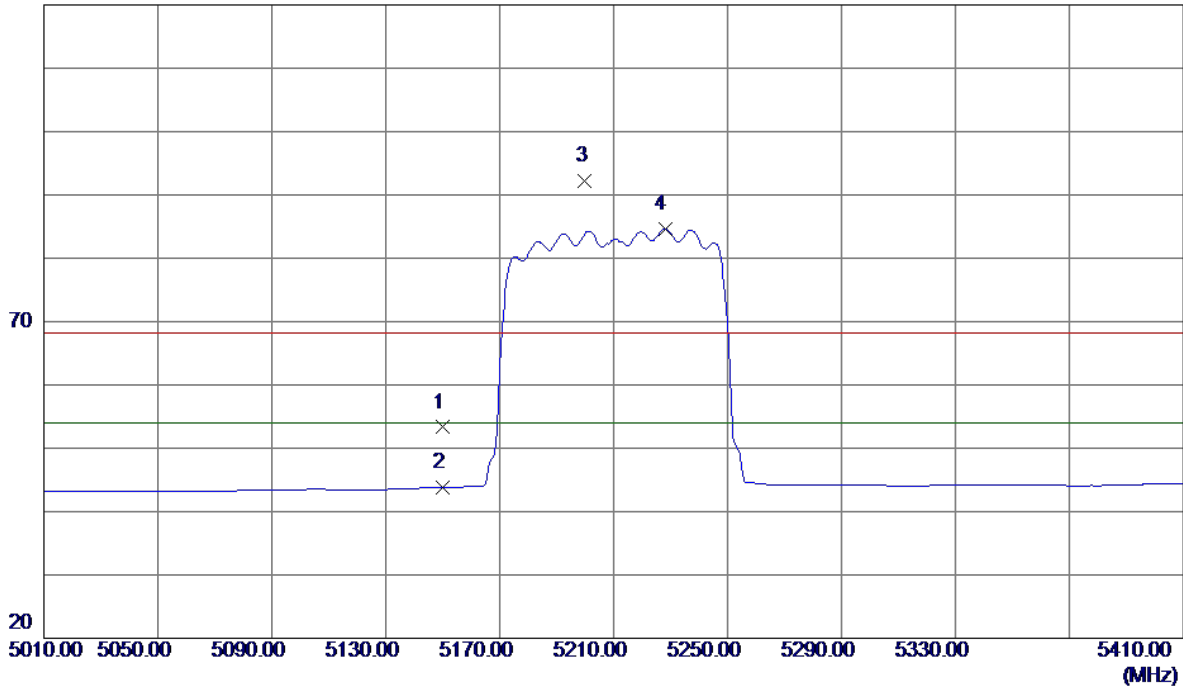

No.	Freq. MHz	Reading Level dBuV/m	Correct Factor dB	Measure ment dBuV/m	Limit dBuV/m	Margin dB	Detector	Comment
1	5150.0000	11.95	41.35	53.30	68.30	-15.00	Peak	
2	5150.0000	2.44	41.35	43.79	54.00	-10.21	AVG	
3	5200.0000	50.67	41.52	92.19	68.30	23.89	Peak	No Limit
4 *	5228.0000	43.02	41.61	84.63	54.00	30.63	AVG	No Limit

Orthogonal Axis:	X
Test Mode:	UNII-1/ TX AC80 Mode 5210MHz

Vertical

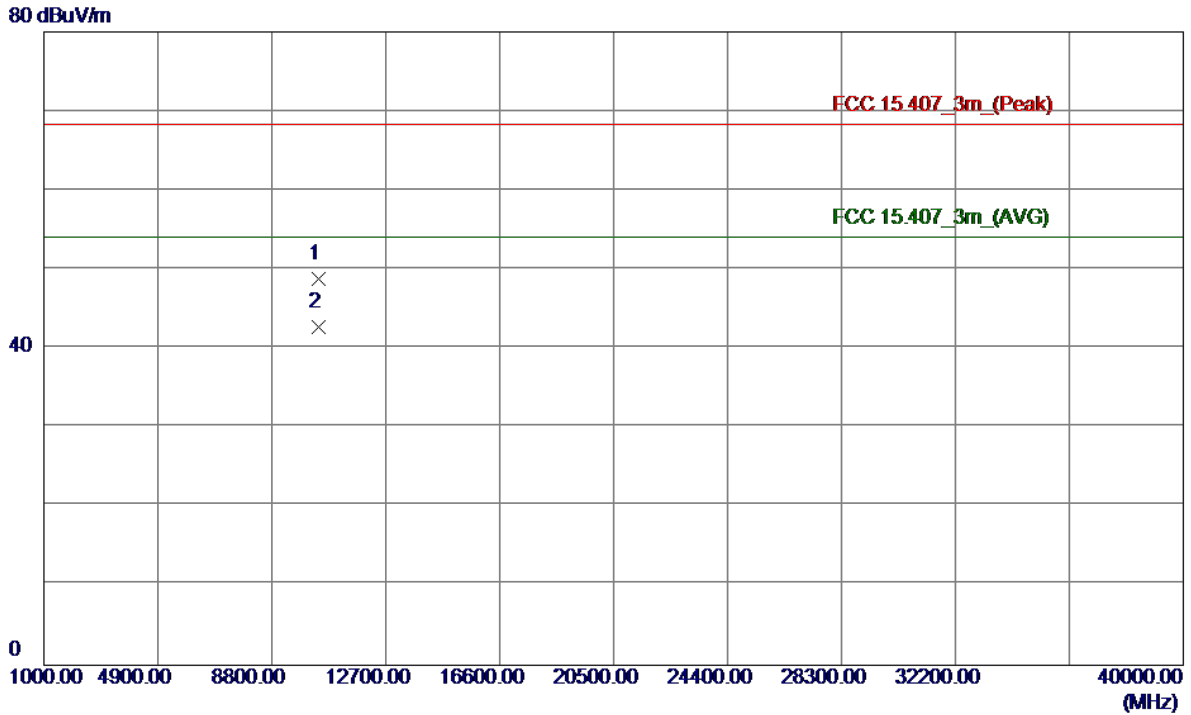

No.	Freq. MHz	Reading Level dBuV/m	Correct Factor dB	Measure ment dBuV/m	Limit dBuV/m	Margin dB	Detector	Comment
1	10420.1250	32.25	16.49	48.74	68.30	-19.56	Peak	
2 *	10420.0250	26.23	16.49	42.72	54.00	-11.28	AVG	

Orthogonal Axis:	X
Test Mode:	UNII-1/ TX AC80 Mode 5210MHz

Horizontal

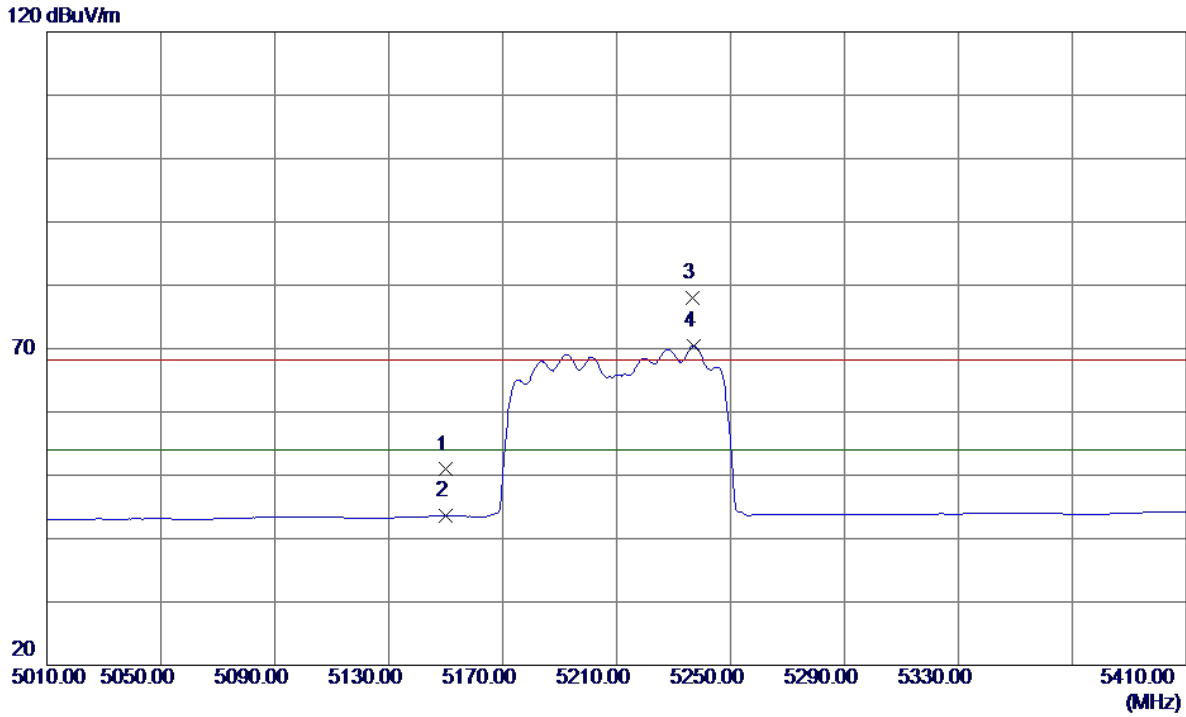

No.	Freq. MHz	Reading Level dBuV/m	Correct Factor dB	Measure ment dBuV/m	Limit dBuV/m	Margin dB	Detector	Comment
1	5150.0000	9.55	41.35	50.90	68.30	-17.40	Peak	
2	5150.0000	2.17	41.35	43.52	54.00	-10.48	AVG	
3	5236.8000	36.31	41.64	77.95	68.30	9.65	Peak	No Limit
4 *	5237.2000	28.74	41.64	70.38	54.00	16.38	AVG	No Limit

Orthogonal Axis:	X
Test Mode:	UNII-1/ TX AC80 Mode 5210MHz

Horizontal

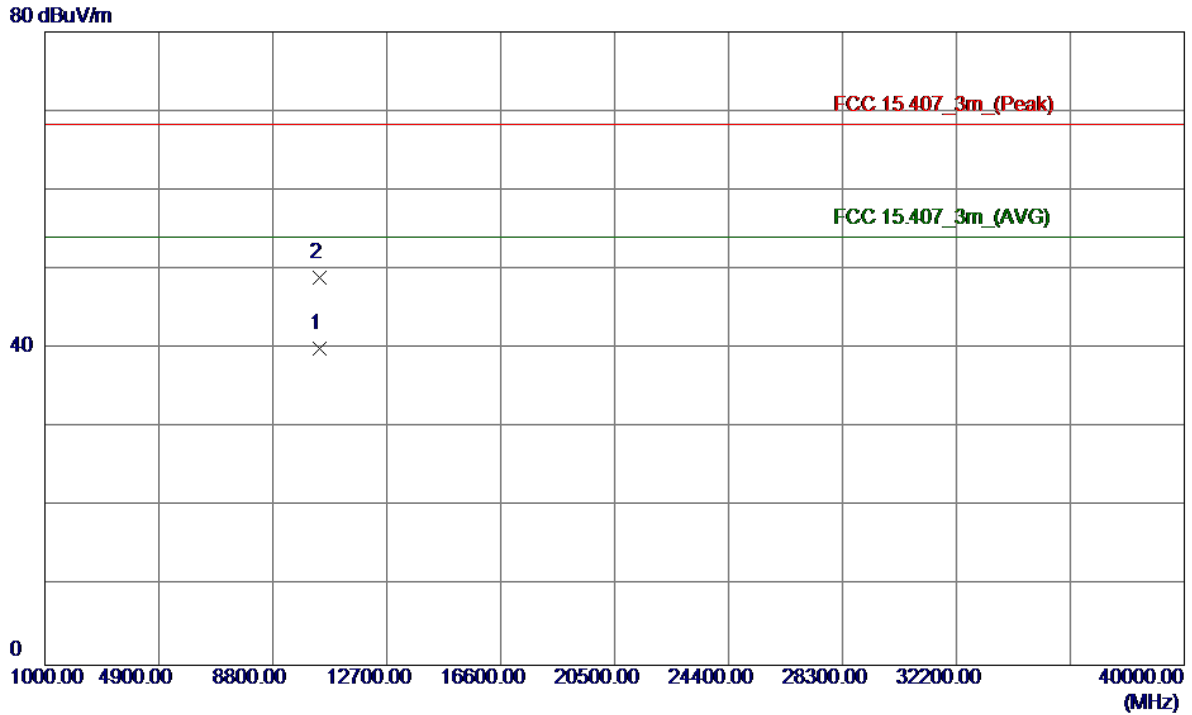

No.	Freq. MHz	Reading Level dBuV/m	Correct Factor dB	Measure ment dBuV/m	Limit dBuV/m	Margin dB	Detector	Comment
1 *	10420.0250	23.58	16.49	40.07	54.00	-13.93	AVG	
2	10420.1250	32.47	16.49	48.96	68.30	-19.34	Peak	

Orthogonal Axis:	X
Test Mode:	UNII-3/TX AC20 Mode 5745MHz

Vertical

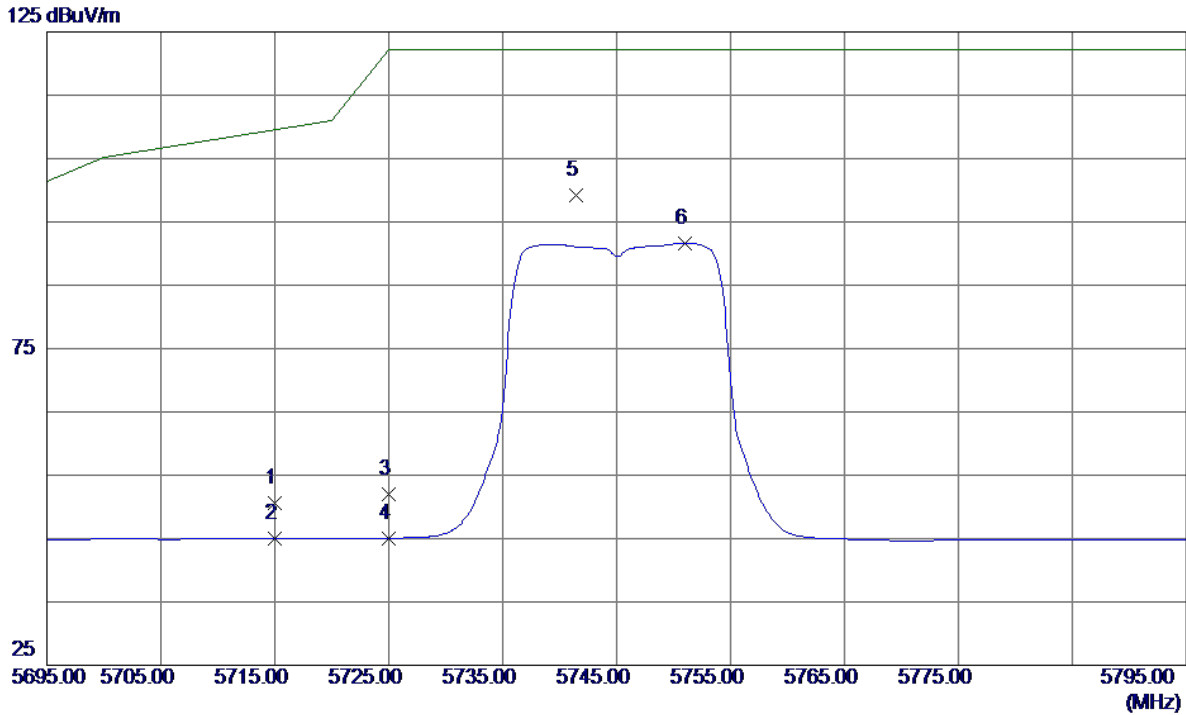

No.	Freq. MHz	Reading Level dBuV/m	Correct Factor dB	Measure ment dBuV/m	Limit dBuV/m	Margin dB	Detector	Comment
1	5715.0000	7.83	42.72	50.55	109.50	-58.95	Peak	
2	5715.0000	2.22	42.72	44.94	109.50	-64.56	AVG	
3	5725.0000	9.18	42.73	51.91	122.30	-70.39	Peak	
4	5725.0000	2.32	42.73	45.05	122.30	-77.25	AVG	
5 *	5741.4000	56.40	42.74	99.14	122.30	-23.16	Peak	
6	5751.0000	48.88	42.75	91.63	122.30	-30.67	AVG	

Orthogonal Axis:	X
Test Mode:	UNII-3/TX AC20 Mode 5745MHz

Vertical

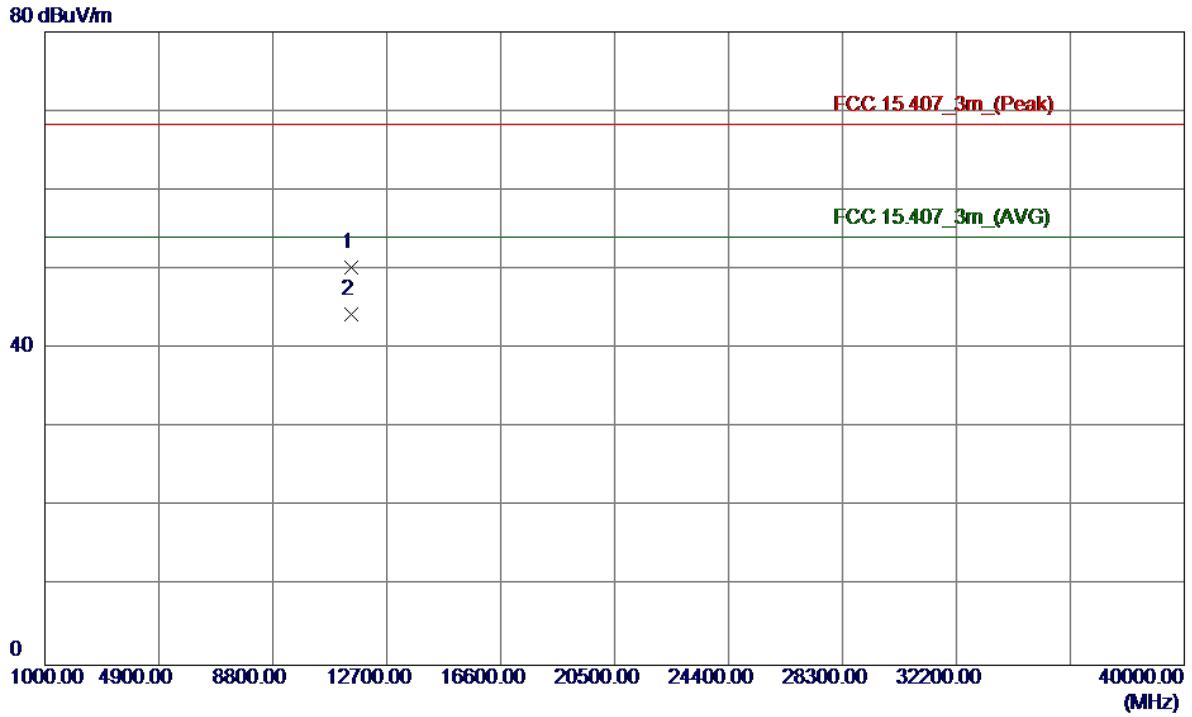

No.	Freq. MHz	Reading Level dBuV/m	Correct Factor dB	Measure ment dBuV/m	Limit dBuV/m	Margin dB	Detector	Comment
1	11489.7950	32.36	17.89	50.25	68.30	-18.05	Peak	
2 *	11489.9950	26.41	17.89	44.30	54.00	-9.70	AVG	

Orthogonal Axis:	X
Test Mode:	UNII-3/TX AC20 Mode 5745MHz

Horizontal

125 dBuV/m

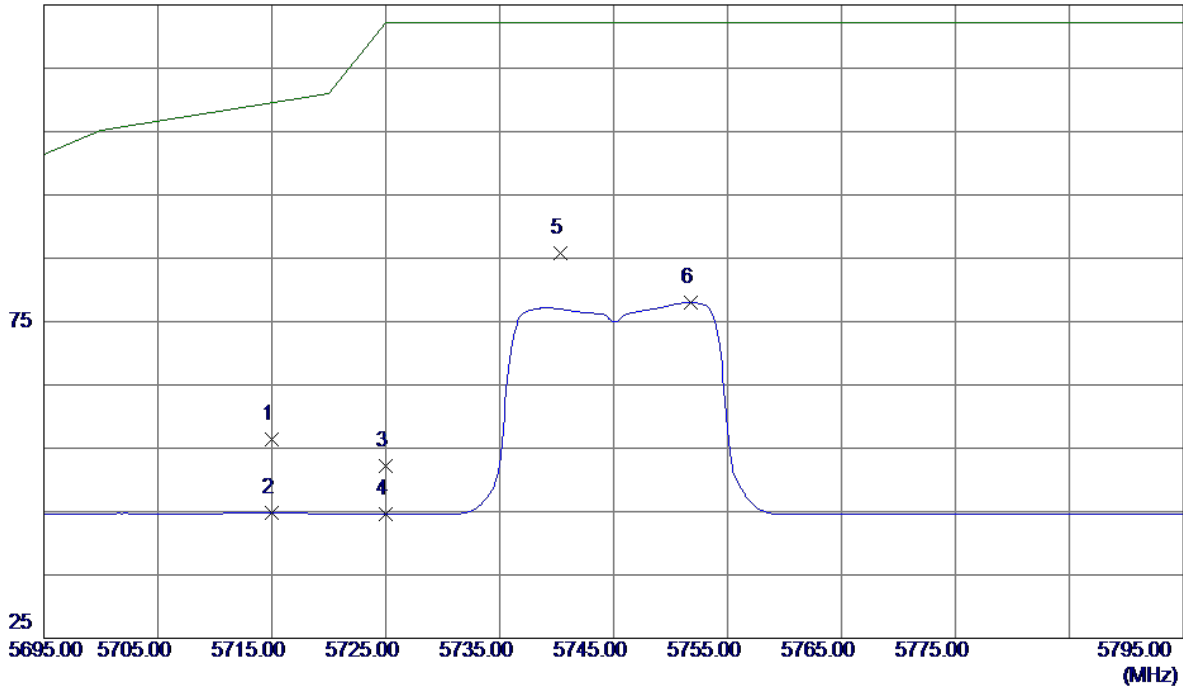

No.	Freq. MHz	Reading Level dBuV/m	Correct Factor dB	Measure ment dBuV/m	Limit dBuV/m	Margin dB	Detector	Comment
1	5715.0000	13.69	42.72	56.41	109.50	-53.09	Peak	
2	5715.0000	2.02	42.72	44.74	109.50	-64.76	AVG	
3	5725.0000	9.50	42.73	52.23	122.30	-70.07	Peak	
4	5725.0000	1.93	42.73	44.66	122.30	-77.64	AVG	
5 *	5740.3000	43.13	42.74	85.87	122.30	-36.43	Peak	
6	5751.8000	35.25	42.75	78.00	122.30	-44.30	AVG	

Orthogonal Axis:	X
Test Mode:	UNII-3/TX AC20 Mode 5745MHz

Horizontal

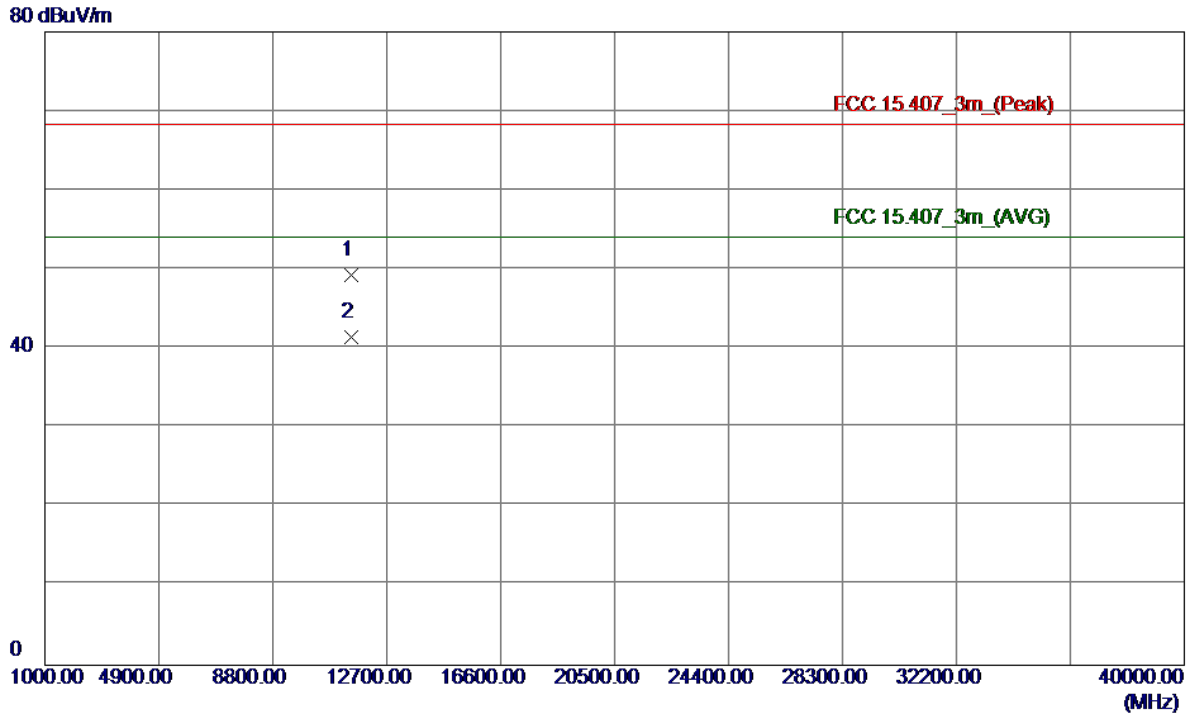

No.	Freq. MHz	Reading Level dBuV/m	Correct Factor dB	Measure ment dBuV/m	Limit dBuV/m	Margin dB	Detector	Comment
1	11489.9850	31.41	17.89	49.30	68.30	-19.00	Peak	
2 *	11489.9950	23.48	17.89	41.37	54.00	-12.63	AVG	

Orthogonal Axis:	X
Test Mode:	UNII-3/TX AC20 Mode 5785MHz

Vertical

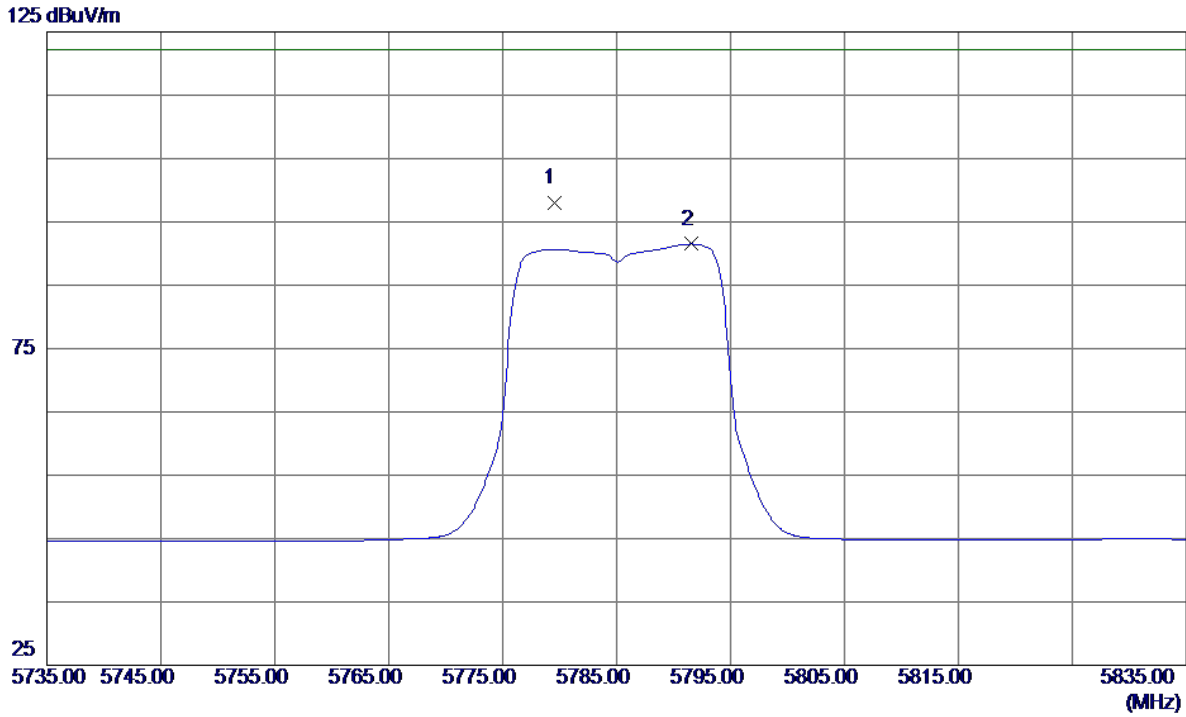

No.	Freq. MHz	Reading Level dBuV/m	Correct Factor dB	Measure ment dBuV/m	Limit dBuV/m	Margin dB	Detector	Comment
1 *	5779.5000	55.25	42.78	98.03	122.30	-24.27	Peak	
2	5791.6000	48.71	42.79	91.50	122.30	-30.80	AVG	

Orthogonal Axis:	X
Test Mode:	UNII-3/TX AC20 Mode 5785MHz

Vertical

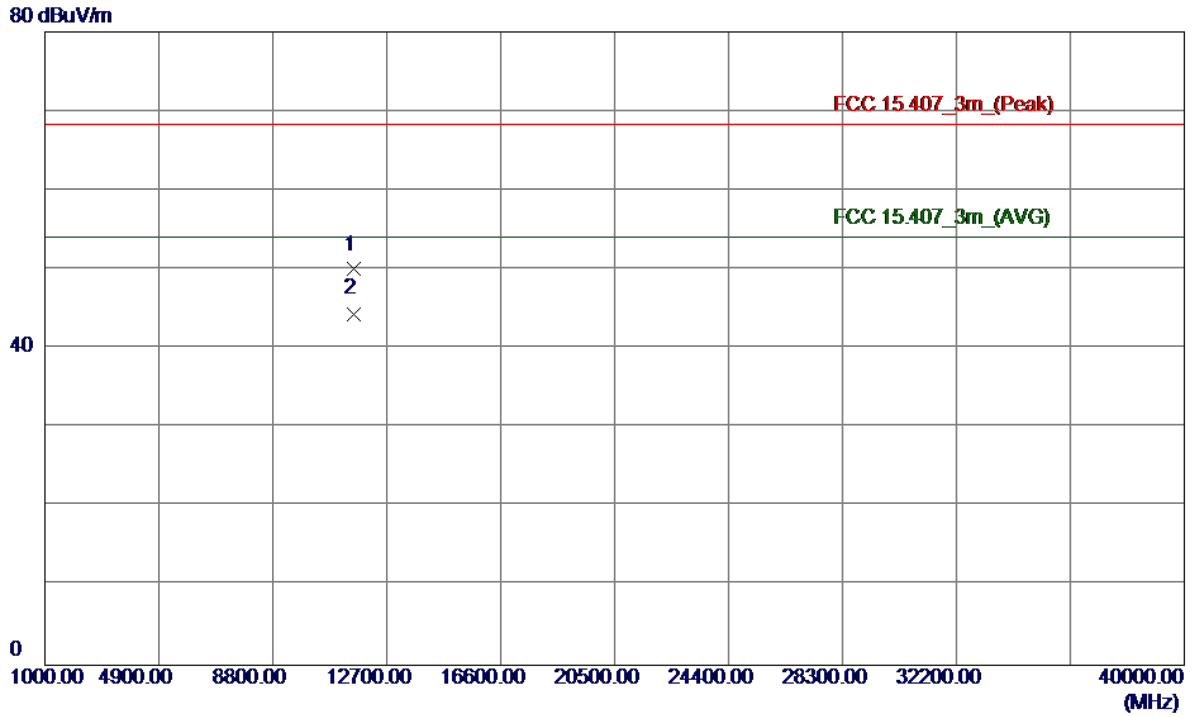

No.	Freq. MHz	Reading Level dBuV/m	Correct Factor dB	Measure ment dBuV/m	Limit dBuV/m	Margin dB	Detector	Comment
1	11570.1200	32.15	17.85	50.00	68.30	-18.30	Peak	
2 *	11570.0199	26.55	17.85	44.40	54.00	-9.60	AVG	

Orthogonal Axis:	X
Test Mode:	UNII-3/TX AC20 Mode 5785MHz

Horizontal

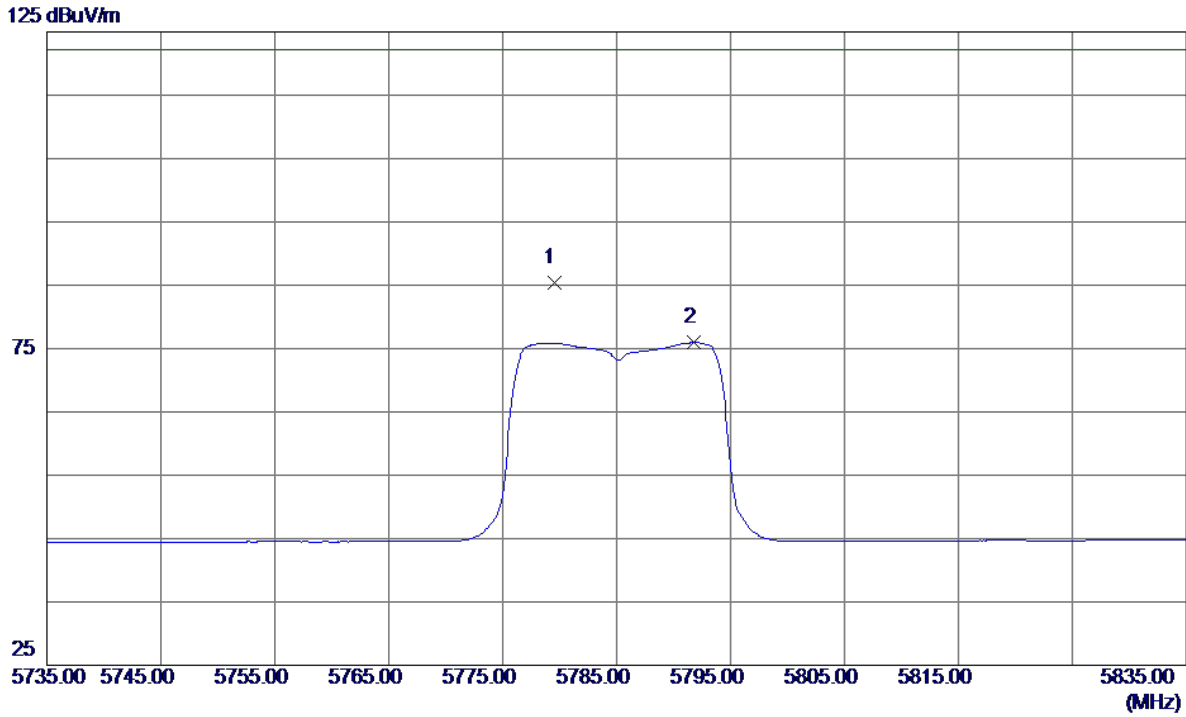

No.	Freq. MHz	Reading Level dBuV/m	Correct Factor dB	Measure ment dBuV/m	Limit dBuV/m	Margin dB	Detector	Comment
1 *	5779.5000	42.53	42.78	85.31	122.30	-36.99	Peak	
2	5791.8000	33.14	42.79	75.93	122.30	-46.37	AVG	

Orthogonal Axis:	X
Test Mode:	UNII-3/TX AC20 Mode 5785MHz

Horizontal

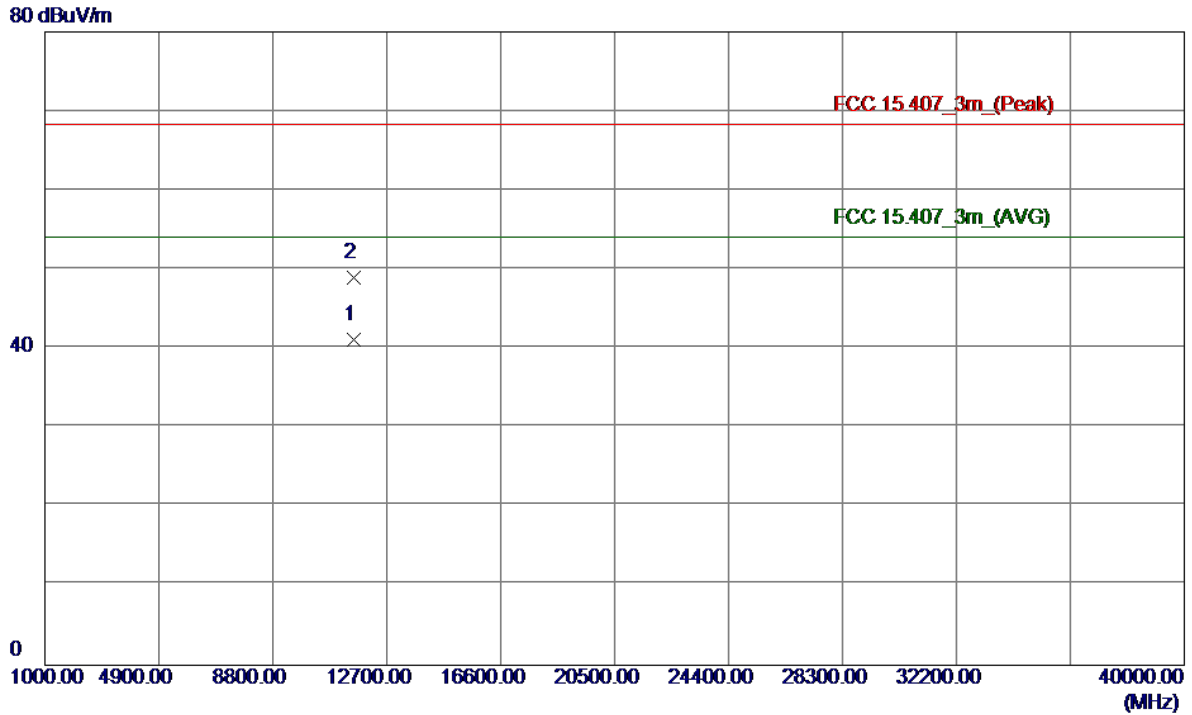

No.	Freq. MHz	Reading Level dBuV/m	Correct Factor dB	Measure ment dBuV/m	Limit dBuV/m	Margin dB	Detector	Comment
1 *	11570.0199	23.29	17.85	41.14	54.00	-12.86	AVG	
2	11570.1200	31.16	17.85	49.01	68.30	-19.29	Peak	

Orthogonal Axis:	X
Test Mode:	UNII-3/TX AC20 Mode 5825MHz

Vertical

125 dBuV/m

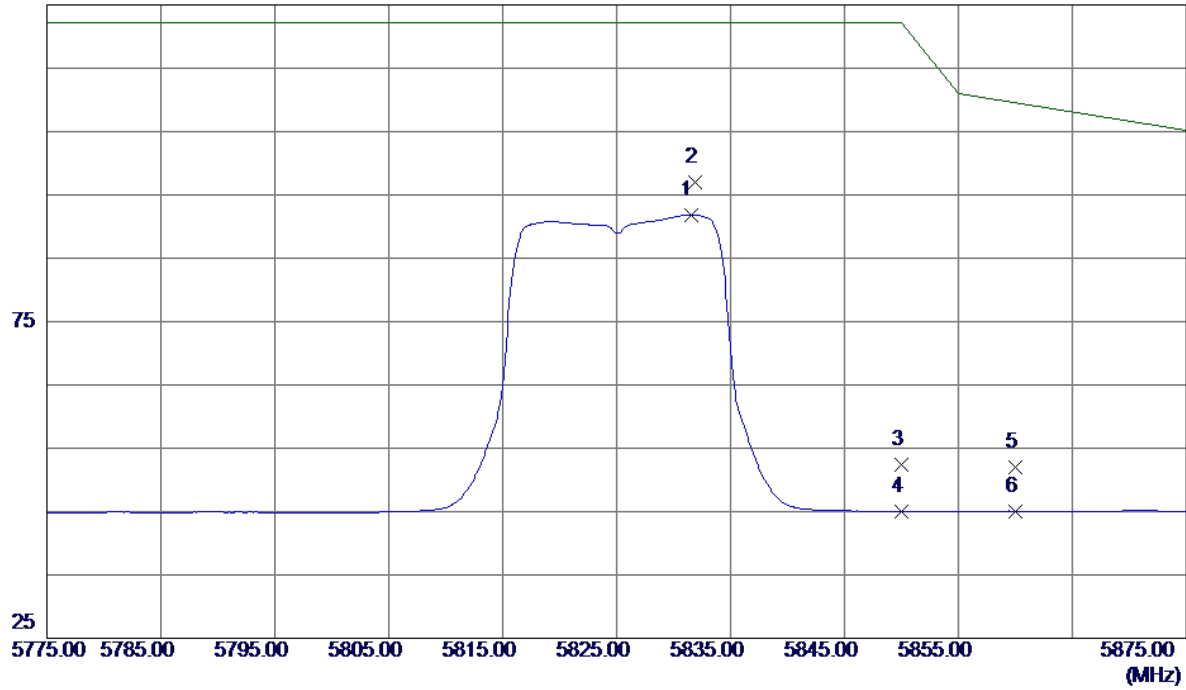

No.	Freq. MHz	Reading Level dBuV/m	Correct Factor dB	Measure ment dBuV/m	Limit dBuV/m	Margin dB	Detector	Comment
1	5831.5000	49.02	42.82	91.84	122.30	-30.46	AVG	
2 *	5831.9000	54.15	42.82	96.97	122.30	-25.33	Peak	
3	5850.0000	9.59	42.84	52.43	122.30	-69.87	Peak	
4	5850.0000	2.21	42.84	45.05	122.30	-77.25	AVG	
5	5860.0000	9.19	42.85	52.04	109.50	-57.46	Peak	
6	5860.0000	2.24	42.85	45.09	109.50	-64.41	AVG	

Orthogonal Axis:	X
Test Mode:	UNII-3/TX AC20 Mode 5825MHz

Vertical

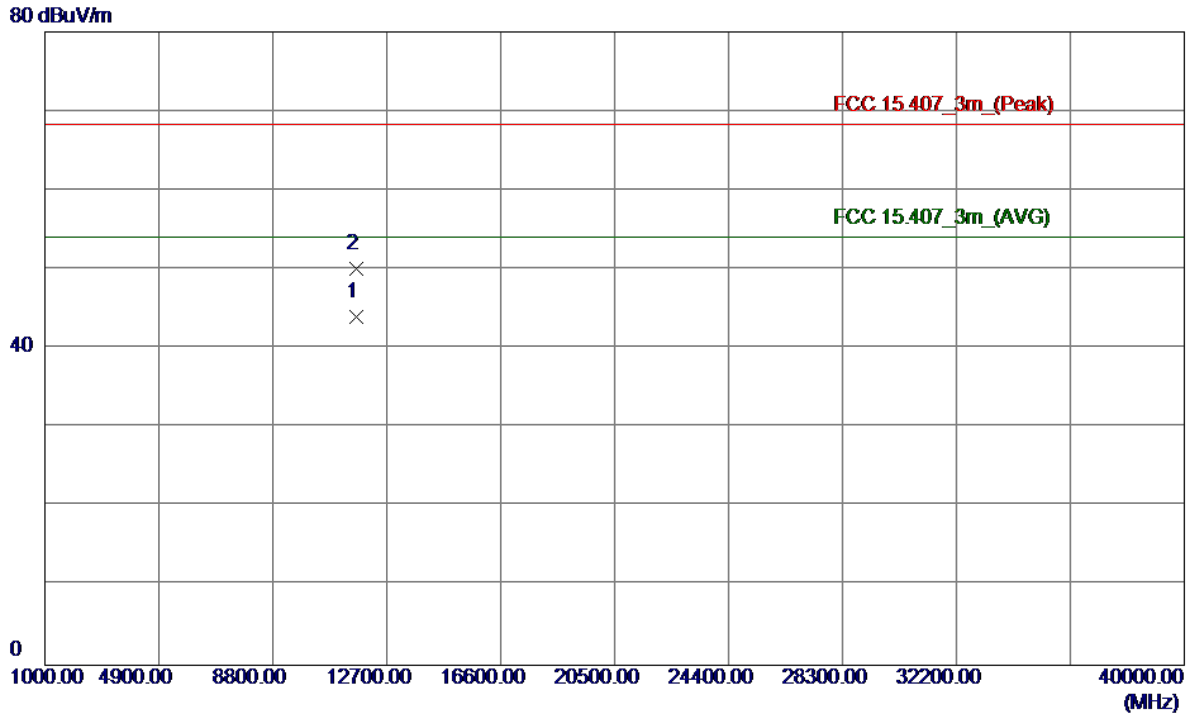

No.	Freq. MHz	Reading Level dBuV/m	Correct Factor dB	Measure ment dBuV/m	Limit dBuV/m	Margin dB	Detector	Comment
1 *	11649.9800	26.24	17.79	44.03	54.00	-9.97	AVG	
2	11649.7800	32.26	17.79	50.05	68.30	-18.25	Peak	

Orthogonal Axis:	X
Test Mode:	UNII-3/TX AC20 Mode 5825MHz

Horizontal

125 dBuV/m

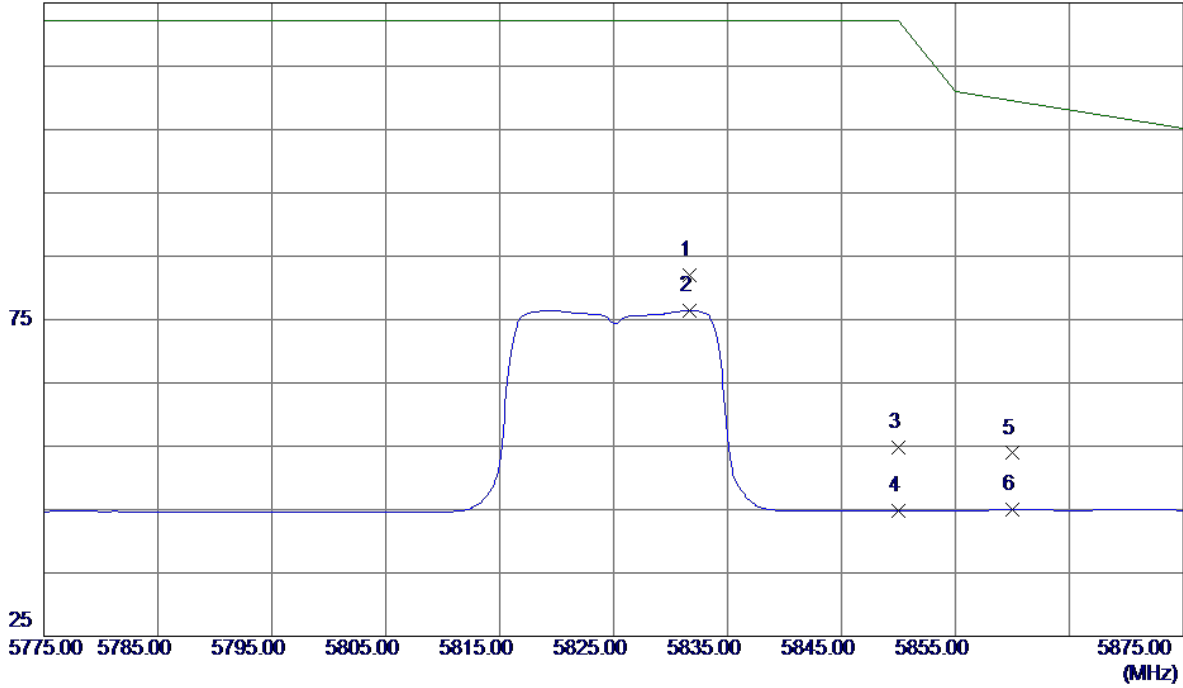

No.	Freq. MHz	Reading Level dBuV/m	Correct Factor dB	Measure ment dBuV/m	Limit dBuV/m	Margin dB	Detector	Comment
1 *	5831.7000	39.11	42.82	81.93	122.30	-40.37	Peak	
2	5831.7000	33.60	42.82	76.42	122.30	-45.88	AVG	
3	5850.0000	11.97	42.84	54.81	122.30	-67.49	Peak	
4	5850.0000	2.02	42.84	44.86	122.30	-77.44	AVG	
5	5860.0000	11.05	42.85	53.90	109.50	-55.60	Peak	
6	5860.0000	2.09	42.85	44.94	109.50	-64.56	AVG	

Orthogonal Axis:	X
Test Mode:	UNII-3/TX AC20 Mode 5825MHz

Horizontal

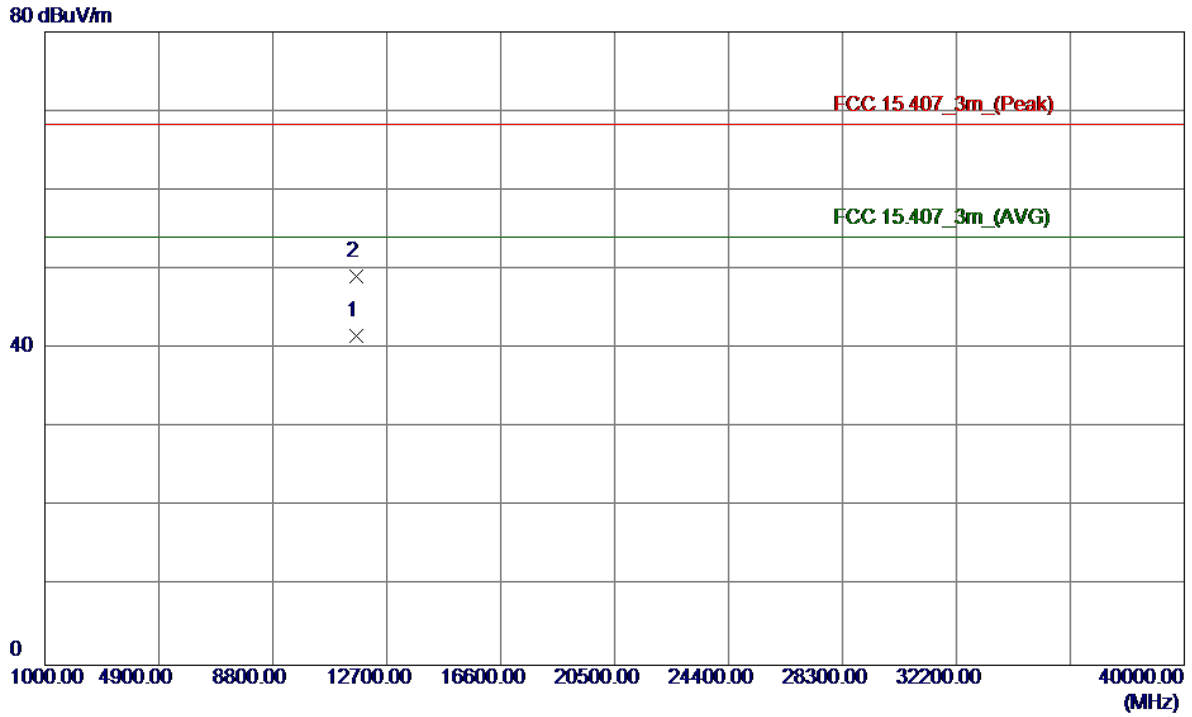

No.	Freq. MHz	Reading Level dBuV/m	Correct Factor dB	Measure ment dBuV/m	Limit dBuV/m	Margin dB	Detector	Comment
1 *	11649.7850	23.74	17.79	41.53	54.00	-12.47	AVG	
2	11649.7800	31.35	17.79	49.14	68.30	-19.16	Peak	

Orthogonal Axis:	X
Test Mode:	UNII-3/TX AC40 Mode 5755MHz

Vertical

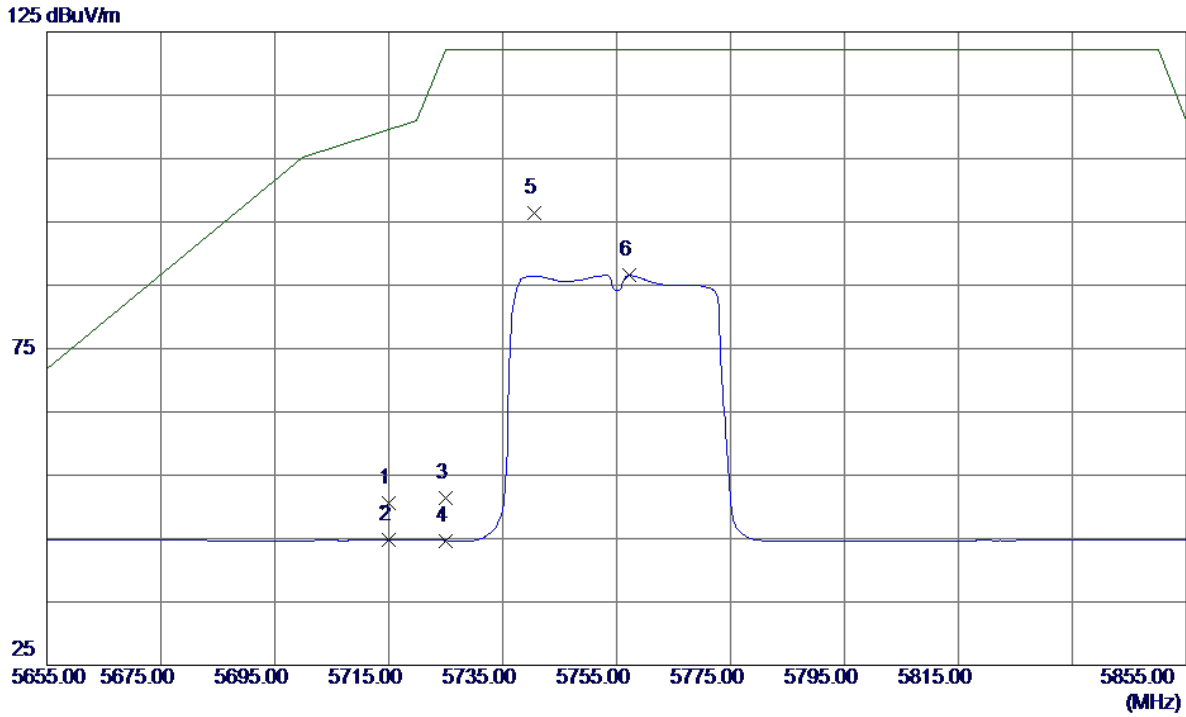

No.	Freq. MHz	Reading Level dBuV/m	Correct Factor dB	Measure ment dBuV/m	Limit dBuV/m	Margin dB	Detector	Comment
1	5715.0000	7.93	42.72	50.65	109.50	-58.85	Peak	
2	5715.0000	2.07	42.72	44.79	109.50	-64.71	AVG	
3	5725.0000	8.75	42.73	51.48	122.30	-70.82	Peak	
4	5725.0000	1.95	42.73	44.68	122.30	-77.62	AVG	
5 *	5740.6000	53.70	42.74	96.44	122.30	-25.86	Peak	
6	5757.2000	43.82	42.76	86.58	122.30	-35.72	AVG	

Orthogonal Axis:	X
Test Mode:	UNII-3/TX AC40 Mode 5755MHz

Vertical

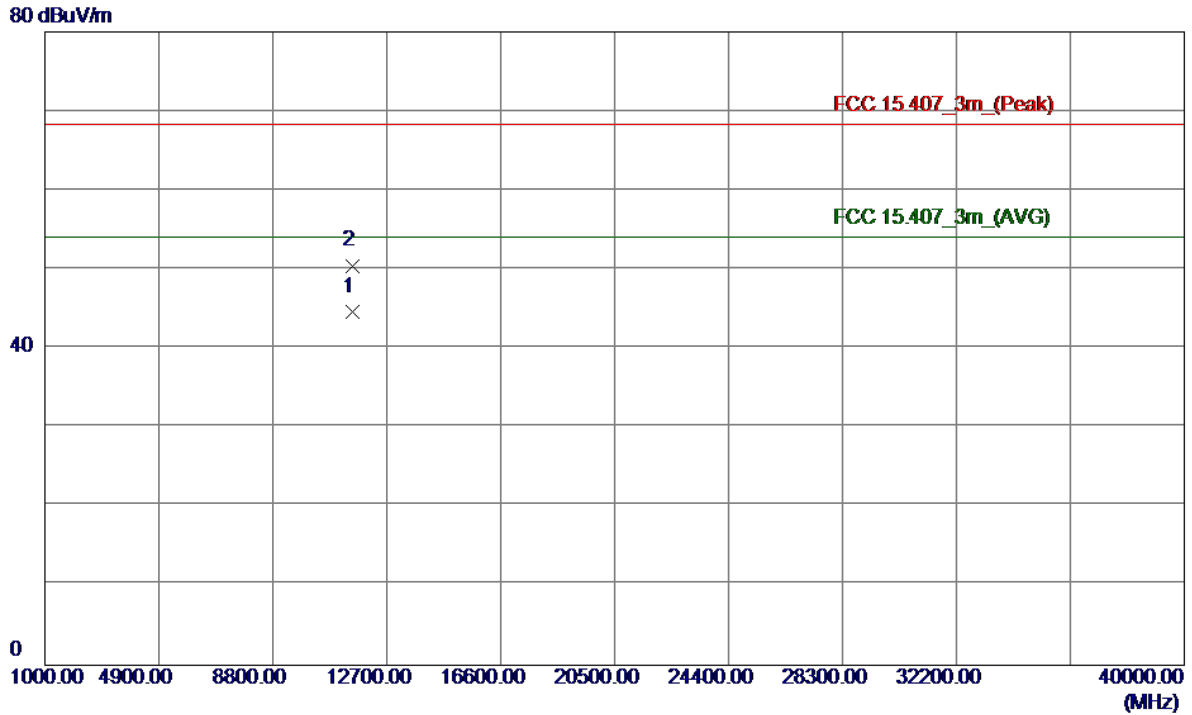

No.	Freq. MHz	Reading Level dBuV/m	Correct Factor dB	Measure ment dBuV/m	Limit dBuV/m	Margin dB	Detector	Comment
1 *	11509.9550	26.68	17.90	44.58	54.00	-9.42	AVG	
2	11509.8550	32.58	17.90	50.48	68.30	-17.82	Peak	

Orthogonal Axis:	X
Test Mode:	UNII-3/TX AC40 Mode 5755MHz

Horizontal

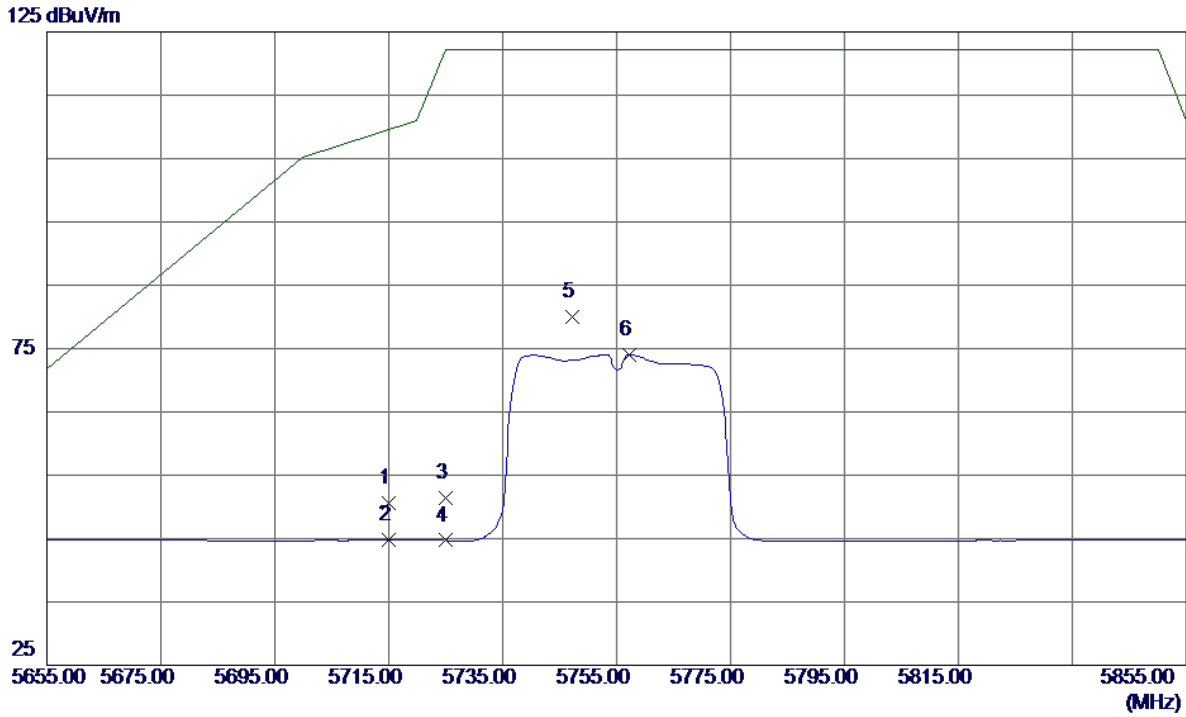

No.	Freq. MHz	Reading Level dBuV/m	Correct Factor dB	Measure ment dBuV/m	Limit dBuV/m	Margin dB	Detector	Comment
1	5715.0000	7.96	42.72	50.68	109.50	-58.82	Peak	
2	5715.0000	2.08	42.72	44.80	109.50	-64.70	AVG	
3	5725.0000	8.73	42.73	51.46	122.30	-70.84	Peak	
4	5725.0000	1.97	42.73	44.70	122.30	-77.60	AVG	
5 *	5747.2000	37.34	42.75	80.09	122.30	-42.21	Peak	
6	5757.2000	31.32	42.76	74.08	122.30	-48.22	AVG	

Orthogonal Axis:	X
Test Mode:	UNII-3/TX AC40 Mode 5755MHz

Horizontal

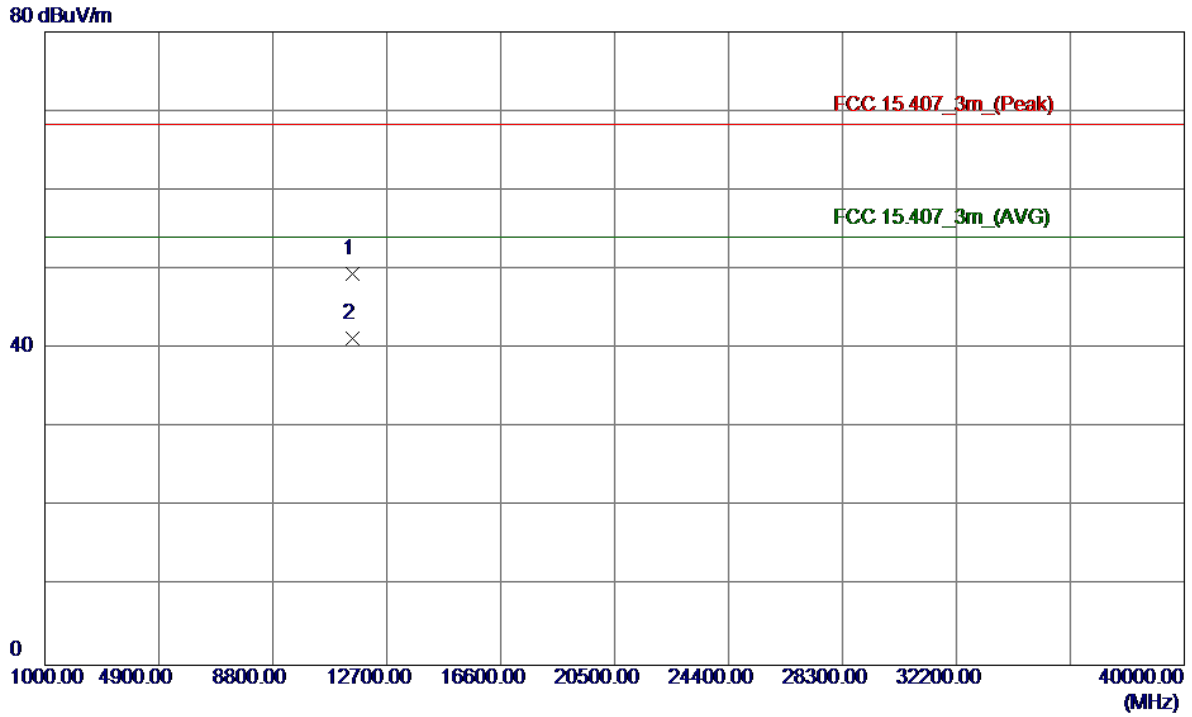

No.	Freq. MHz	Reading Level dBuV/m	Correct Factor dB	Measure ment dBuV/m	Limit dBuV/m	Margin dB	Detector	Comment
1	11509.8000	31.58	17.90	49.48	68.30	-18.82	Peak	
2 *	11509.8949	23.42	17.90	41.32	54.00	-12.68	AVG	

Orthogonal Axis:	X
Test Mode:	UNII-3/TX AC40 Mode 5795MHz

Vertical

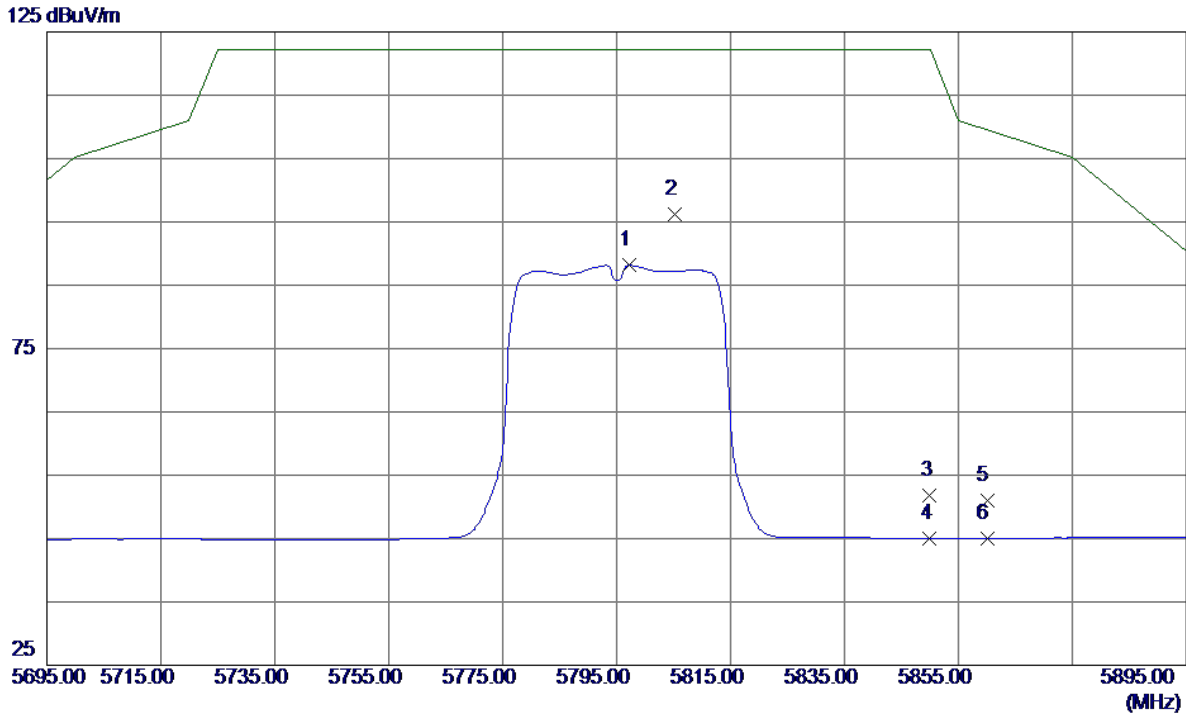

No.	Freq. MHz	Reading Level dBuV/m	Correct Factor dB	Measure ment dBuV/m	Limit dBuV/m	Margin dB	Detector	Comment
1	5797.2000	45.37	42.79	88.16	122.30	-34.14	AVG	
2 *	5805.2000	53.45	42.80	96.25	122.30	-26.05	Peak	
3	5850.0000	8.99	42.84	51.83	122.30	-70.47	Peak	
4	5850.0000	2.25	42.84	45.09	122.30	-77.21	AVG	
5	5860.0000	8.12	42.85	50.97	109.50	-58.53	Peak	
6	5860.0000	2.22	42.85	45.07	109.50	-64.43	AVG	

Orthogonal Axis:	X
Test Mode:	UNII-3/TX AC40 Mode 5795MHz

Vertical

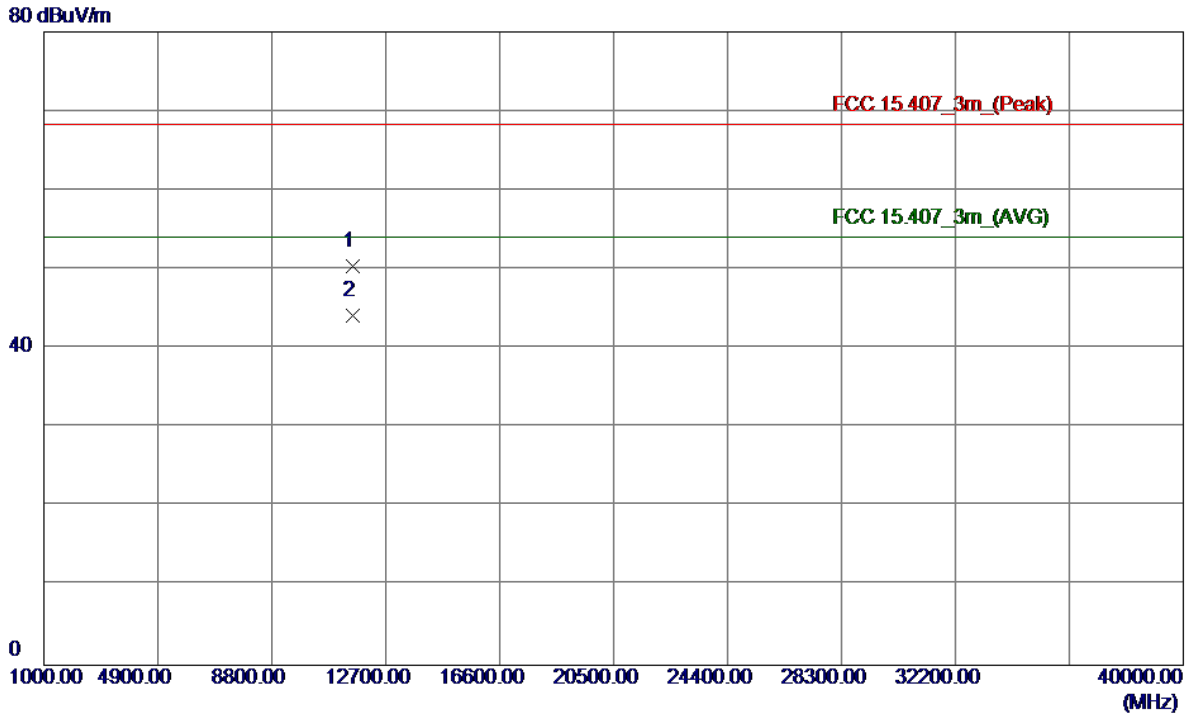

No.	Freq. MHz	Reading Level dBuV/m	Correct Factor dB	Measure ment dBuV/m	Limit dBuV/m	Margin dB	Detector	Comment
1	11589.9000	32.62	17.83	50.45	68.30	-17.85	Peak	
2 *	11589.9750	26.40	17.83	44.23	54.00	-9.77	AVG	

Orthogonal Axis:	X
Test Mode:	UNII-3/TX AC40 Mode 5795MHz

Horizontal

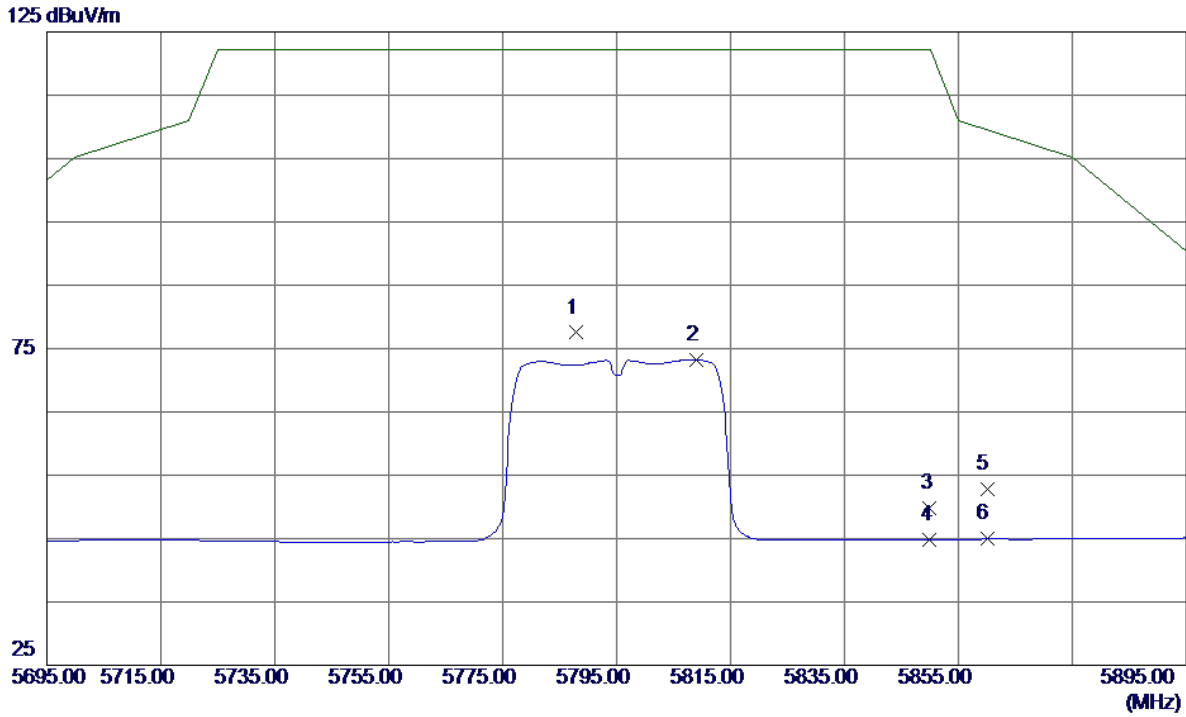

No.	Freq. MHz	Reading Level dBuV/m	Correct Factor dB	Measure ment dBuV/m	Limit dBuV/m	Margin dB	Detector	Comment
1 *	5787.8000	34.72	42.78	77.50	122.30	-44.80	Peak	
2	5809.0000	30.43	42.80	73.23	122.30	-49.07	AVG	
3	5850.0000	7.01	42.84	49.85	122.30	-72.45	Peak	
4	5850.0000	2.00	42.84	44.84	122.30	-77.46	AVG	
5	5860.0000	9.89	42.85	52.74	109.50	-56.76	Peak	
6	5860.0000	2.06	42.85	44.91	109.50	-64.59	AVG	

Orthogonal Axis:	X
Test Mode:	UNII-3/TX AC40 Mode 5795MHz

Horizontal

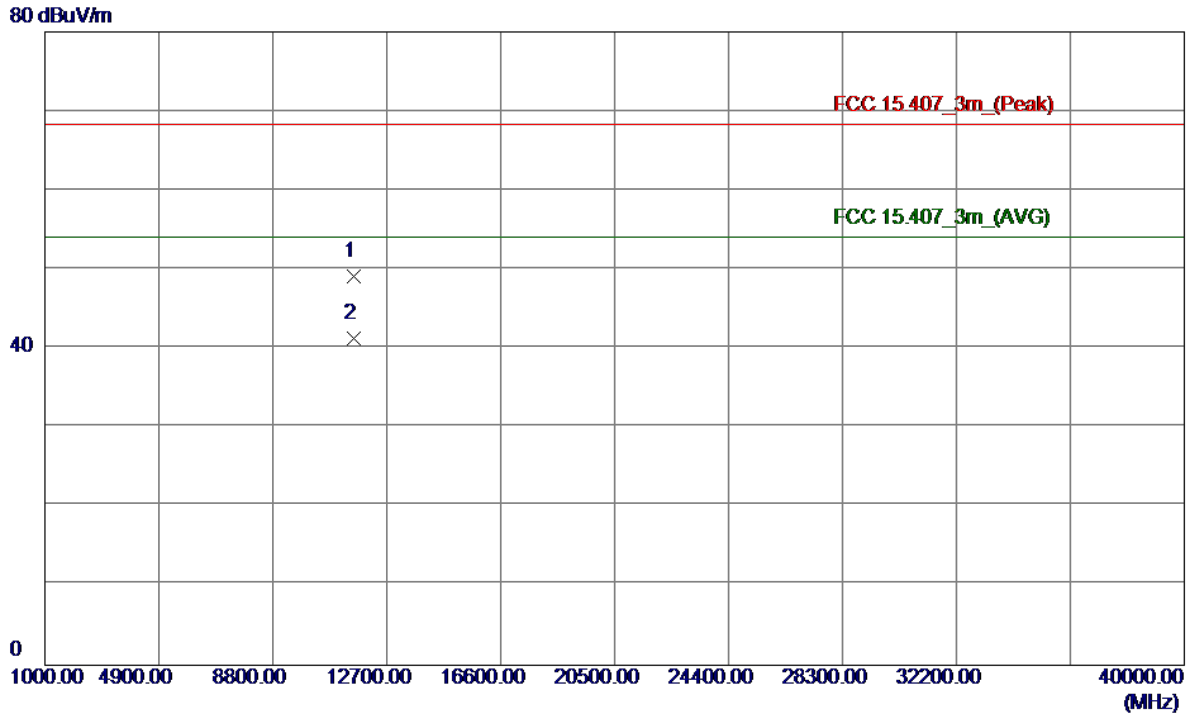

No.	Freq. MHz	Reading Level dBuV/m	Correct Factor dB	Measure ment dBuV/m	Limit dBuV/m	Margin dB	Detector	Comment
1	11589.9750	31.32	17.83	49.15	68.30	-19.15	Peak	
2 *	11590.0050	23.42	17.83	41.25	54.00	-12.75	AVG	

Orthogonal Axis:	X
Test Mode:	UNII-3/TX AC80 Mode 5775MHz

Vertical

125 dBuV/m

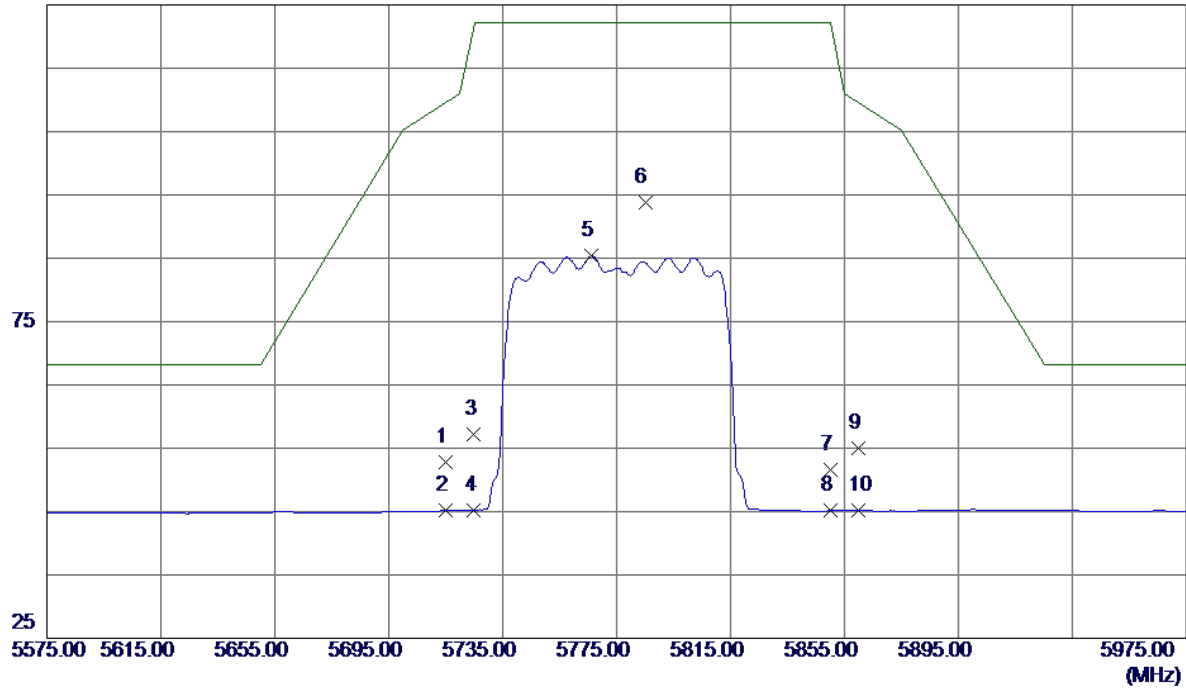

No.	Freq. MHz	Reading Level dBuV/m	Correct Factor dB	Measure ment dBuV/m	Limit dBuV/m	Margin dB	Detector	Comment
1	5715.0000	10.07	42.72	52.79	109.50	-56.71	Peak	
2	5715.0000	2.40	42.72	45.12	109.50	-64.38	AVG	
3	5725.0000	14.50	42.73	57.23	122.30	-65.07	Peak	
4	5725.0000	2.50	42.73	45.23	122.30	-77.07	AVG	
5	5766.2000	42.56	42.76	85.32	122.30	-36.98	Peak	
6 *	5785.0000	50.96	42.78	93.74	122.30	-28.56	Peak	
7	5850.0000	8.85	42.84	51.69	122.30	-70.61	Peak	
8	5850.0000	2.27	42.84	45.11	122.30	-77.19	AVG	
9	5860.0000	12.22	42.85	55.07	109.50	-54.43	Peak	
10	5860.0000	2.28	42.85	45.13	109.50	-64.37	AVG	

Orthogonal Axis:	X
Test Mode:	UNII-3/TX AC80 Mode 5775MHz

Vertical

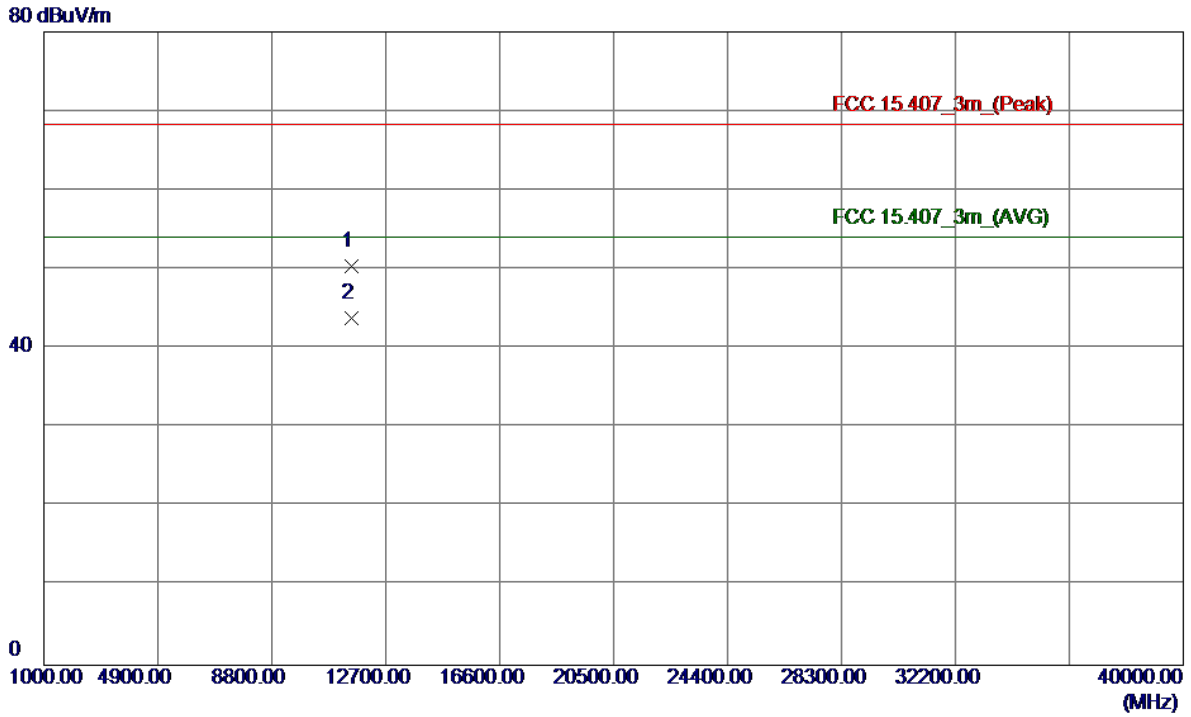

No.	Freq. MHz	Reading Level dBuV/m	Correct Factor dB	Measure ment dBuV/m	Limit dBuV/m	Margin dB	Detector	Comment
1	11549.6500	32.58	17.87	50.45	68.30	-17.85	Peak	
2 *	11549.9500	26.04	17.87	43.91	54.00	-10.09	AVG	

Orthogonal Axis:	X
Test Mode:	UNII-3/TX AC80 Mode 5775MHz

Horizontal

125 dBuV/m

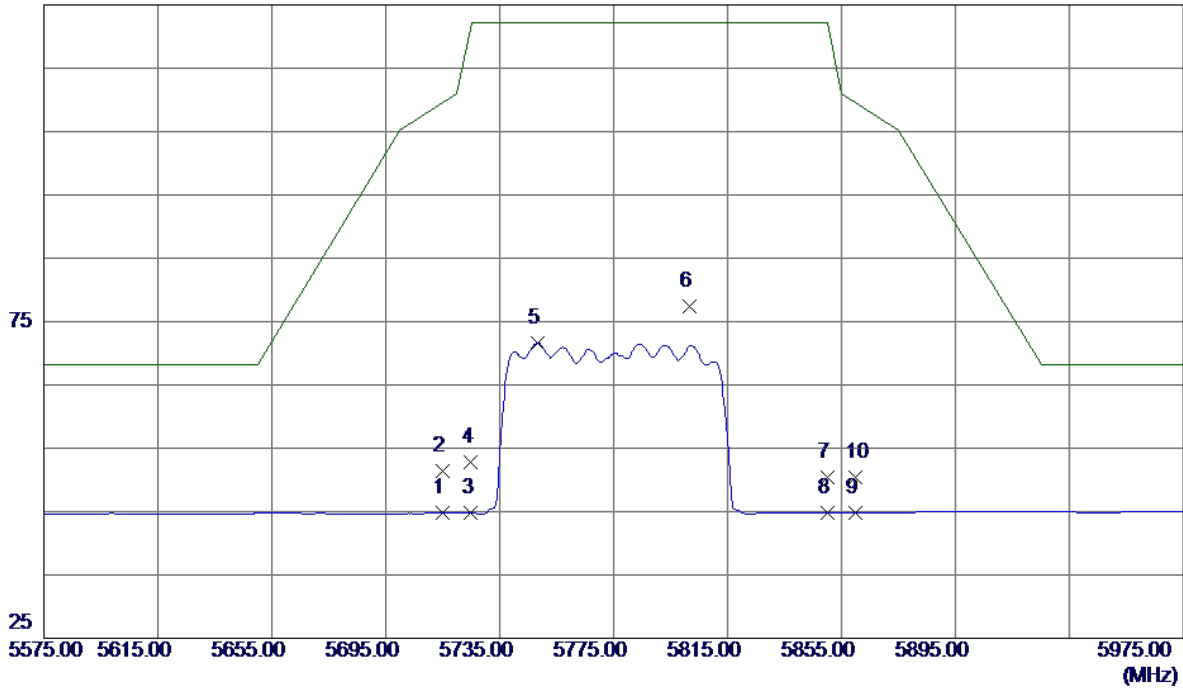

No.	Freq. MHz	Reading Level dBuV/m	Correct Factor dB	Measure ment dBuV/m	Limit dBuV/m	Margin dB	Detector	Comment
1	5715.0000	2.09	42.72	44.81	109.50	-64.69	AVG	
2	5715.0000	8.71	42.72	51.43	109.50	-58.07	Peak	
3	5725.0000	2.01	42.73	44.74	122.30	-77.56	AVG	
4	5725.0000	10.04	42.73	52.77	122.30	-69.53	Peak	
5	5748.2000	28.86	42.75	71.61	122.30	-50.69	AVG	
6 *	5801.8000	34.65	42.80	77.45	122.30	-44.85	Peak	
7	5850.0000	7.49	42.84	50.33	122.30	-71.97	Peak	
8	5850.0000	1.95	42.84	44.79	122.30	-77.51	AVG	
9	5860.0000	2.00	42.85	44.85	109.50	-64.65	AVG	
10	5860.0000	7.46	42.85	50.31	109.50	-59.19	Peak	

Orthogonal Axis:	X
Test Mode:	UNII-3/TX AC80 Mode 5775MHz

Horizontal

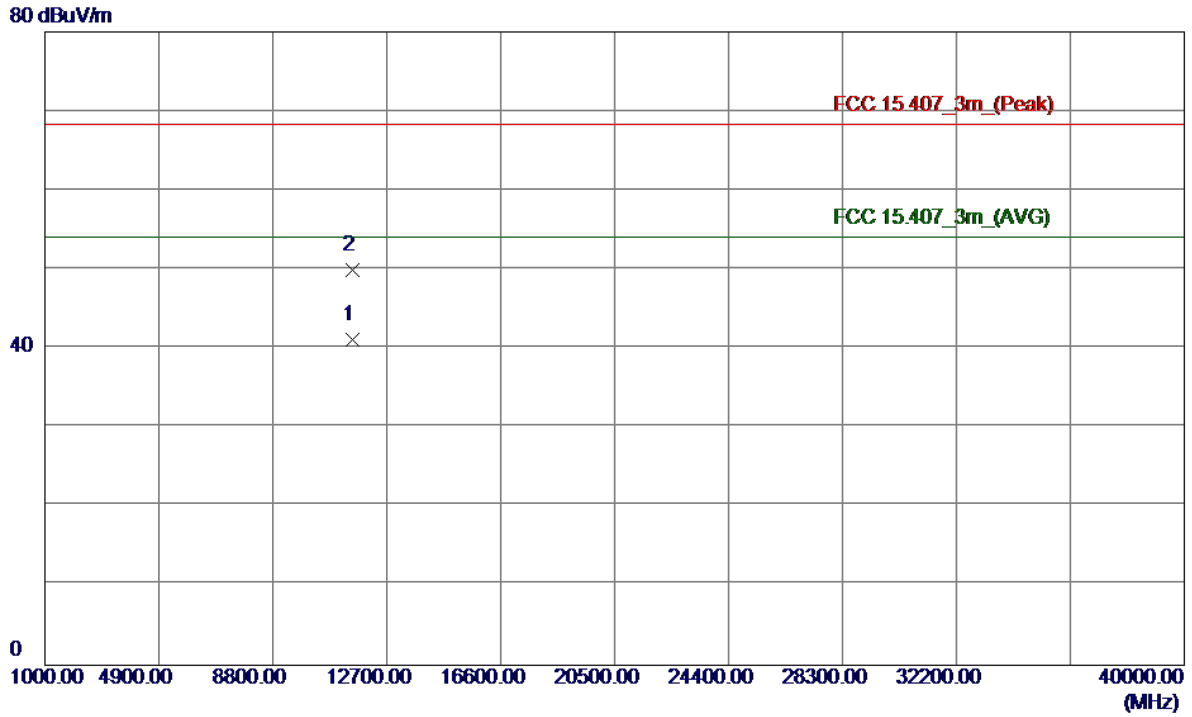

No.	Freq. MHz	Reading Level dBuV/m	Correct Factor dB	Measure ment dBuV/m	Limit dBuV/m	Margin dB	Detector	Comment
1 *	11549.9900	23.29	17.87	41.16	54.00	-12.84	AVG	
2	11549.9500	32.01	17.87	49.88	68.30	-18.42	Peak	