

FCC Radio Test Report

FCC ID: T58WF2780FR

This report concerns (check one): Original Grant Class I Change Class II Change

Project No. : 1607C232
Equipment : AC1200 WIRELESS DUAL BAND GIGABIT FIBER ROUTER
Model Name : WF2780F
Applicant : NETIS SYSTEMS CO., LTD
Address : 4F&5F R&D Building, Oriental Cyberport, High-Tech Industrial Park, Nanshan, Shenzhen, China.

Date of Receipt : Jul. 22, 2016
Date of Test : Jul. 22, 2016 ~ Nov. 03, 2016
Issued Date : Nov. 04, 2016
Tested by : BTL Inc.

Testing Engineer : Shawn Xiao
(Shawn Xiao)

Technical Manager : David Mao
(David Mao)

Authorized Signatory : Steven Lu
(Steven Lu)

B T L I N C .

No.3, Jinshagang 1st Road, Shixia, Dalang Town, Dongguan,
Guangdong, China.

TEL: +86-769-8318-3000 FAX: +86-769-8319-6000

Declaration

BTL represents to the client that testing is done in accordance with standard procedures as applicable and that test instruments used has been calibrated with standards traceable to international standard(s) and/or national standard(s).

BTL's reports apply only to the specific samples tested under conditions. It is manufacture's responsibility to ensure that additional production units of this model are manufactured with the identical electrical and mechanical components. **BTL** shall have no liability for any declarations, inferences or generalizations drawn by the client or others from **BTL** issued reports.

BTL's report must not be used by the client to claim product certification, approval, or endorsement by NVLAP, NIST, or any agency of the Federal Government.

This report is the confidential property of the client. As a mutual protection to the clients, the public and **BTL-self**, extracts from the test report shall not be reproduced except in full with **BTL's** authorized written approval.

BTL's laboratory quality assurance procedures are in compliance with the **ISO Guide 17025** requirements, and accredited by the conformity assessment authorities listed in this test report.

Limitation

For the use of the authority's logo is limited unless the Test Standard(s)/Scope(s)/Item(s) mentioned in this test report is (are) included in the conformity assessment authorities acceptance respective.

| Table of Contents | Page |
|--|-----------|
| 1 . CERTIFICATION | 6 |
| 2 . SUMMARY OF TEST RESULTS | 7 |
| 2.1 TEST FACILITY | 8 |
| 2.2 MEASUREMENT UNCERTAINTY | 8 |
| 3 . GENERAL INFORMATION | 9 |
| 3.1 GENERAL DESCRIPTION OF EUT | 9 |
| 3.2 DESCRIPTION OF TEST MODES | 11 |
| 3.3 TABLE OF PARAMETERS OF TEXT SOFTWARE SETTING | 13 |
| 3.4 BLOCK DIAGRAM SHOWING THE CONFIGURATION OF SYSTEM TESTED | 14 |
| 3.5 DESCRIPTION OF SUPPORT UNITS | 14 |
| 4 . EMC EMISSION TEST | 15 |
| 4.1 CONDUCTED EMISSION MEASUREMENT | 15 |
| 4.1.1 POWER LINE CONDUCTED EMISSION LIMITS | 15 |
| 4.1.2 TEST PROCEDURE | 15 |
| 4.1.3 DEVIATION FROM TEST STANDARD | 15 |
| 4.1.4 TEST SETUP | 16 |
| 4.1.5 EUT OPERATING CONDITIONS | 16 |
| 4.1.6 EUT TEST CONDITIONS | 16 |
| 4.1.7 TEST RESULTS | 16 |
| 4.2 RADIATED EMISSION MEASUREMENT | 17 |
| 4.2.1 RADIATED EMISSION LIMITS | 17 |
| 4.2.2 TEST PROCEDURE | 18 |
| 4.2.3 DEVIATION FROM TEST STANDARD | 18 |
| 4.2.4 TEST SETUP | 19 |
| 4.2.5 EUT OPERATING CONDITIONS | 20 |
| 4.2.6 EUT TEST CONDITIONS | 20 |
| 4.2.7 TEST RESULTS (9KHZ TO 30MHZ) | 20 |
| 4.2.8 TEST RESULTS (30MHZ TO 1000 MHZ) | 20 |
| 4.2.9 TEST RESULTS (ABOVE 1000 MHZ) | 20 |
| 5 . BANDWIDTH TEST | 21 |
| 5.1 APPLIED PROCEDURES | 21 |
| 5.1.1 TEST PROCEDURE | 21 |
| 5.1.2 DEVIATION FROM STANDARD | 21 |
| 5.1.3 TEST SETUP | 21 |
| 5.1.4 EUT OPERATION CONDITIONS | 21 |
| 5.1.5 EUT TEST CONDITIONS | 21 |
| 5.1.6 TEST RESULTS | 21 |
| 6 . MAXIMUM PEAK CONDUCTED OUTPUT POWER TEST | 22 |

| Table of Contents | Page |
|--|------------|
| 6.1 APPLIED PROCEDURES / LIMIT | 22 |
| 6.1.1 TEST PROCEDURE | 22 |
| 6.1.2 DEVIATION FROM STANDARD | 22 |
| 6.1.3 TEST SETUP | 22 |
| 6.1.4 EUT OPERATION CONDITIONS | 22 |
| 6.1.5 EUT TEST CONDITIONS | 22 |
| 6.1.6 TEST RESULTS | 22 |
| 7 . ANTENNA CONDUCTED SPURIOUS EMISSION | 23 |
| 7.1 APPLIED PROCEDURES / LIMIT | 23 |
| 7.1.1 TEST PROCEDURE | 23 |
| 7.1.2 DEVIATION FROM STANDARD | 23 |
| 7.1.3 TEST SETUP | 23 |
| 7.1.4 EUT OPERATION CONDITIONS | 23 |
| 7.1.5 EUT TEST CONDITIONS | 23 |
| 7.1.6 TEST RESULTS | 23 |
| 8 . POWER SPECTRAL DENSITY TEST | 24 |
| 8.1 APPLIED PROCEDURES / LIMIT | 24 |
| 8.1.1 TEST PROCEDURE | 24 |
| 8.1.2 DEVIATION FROM STANDARD | 24 |
| 8.1.3 TEST SETUP | 24 |
| 8.1.4 EUT OPERATION CONDITIONS | 24 |
| 8.1.5 EUT TEST CONDITIONS | 24 |
| 8.1.6 TEST RESULTS | 24 |
| 9 . MEASUREMENT INSTRUMENTS LIST | 25 |
| 10 . EUT TEST PHOTO | 27 |
| ATTACHMENT A - CONDUCTED EMISSION | 31 |
| ATTACHMENT B - RADIATED EMISSION (9KHZ TO 30MHZ) | 34 |
| ATTACHMENT C - RADIATED EMISSION (30MHZ TO 1000MHZ) | 39 |
| ATTACHMENT D - RADIATED EMISSION (ABOVE 1000MHZ) | 46 |
| ATTACHMENT E - BANDWIDTH | 95 |
| ATTACHMENT F - MAXIMUM PEAK CONDUCTED OUTPUT POWER | 104 |
| ATTACHMENT G - ANTENNA CONDUCTED SPURIOUS EMISSION | 109 |
| ATTACHMENT H - POWER SPECTRAL DENSITY | 158 |

REPORT ISSUED HISTORY

| Issued No. | Description | Issued Date |
|---------------------|-----------------|---------------|
| BTL-FCCP-1-1607C232 | Original Issue. | Nov. 04, 2016 |

1. CERTIFICATION

Equipment : AC1200 WIRELESS DUAL BAND GIGABIT FIBER ROUTER
Brand Name : netis
Model Name : WF2780F
Applicant : NETIS SYSTEMS CO., LTD
Manufacturer : Shenzhen Netcore Industrial Ltd.
Address : 4F&5F R&D Building, Oriental Cyberport, High-Tech Industrial Park, Nanshan, Shenzhen, China.
Factory : Dongguan City Netcore Network Technology Co.,Ltd.
Address : No.10-1,Sankeng Road,Qinghutou,Tangxia Town,Dongguan City
Date of Test : Jul. 22, 2016 ~ Nov. 03, 2016
Test Sample : Engineering Sample
Standard(s) : FCC Part15, Subpart C:(15.247) / ANSI C63.10-2013

The above equipment has been tested and found compliance with the requirement of the relative standards by BTL Inc.

The test data, data evaluation, and equipment configuration contained in our test report (Ref No. BTL-FCCP-1-1607C232) were obtained utilizing the test procedures, test instruments, test sites that has been accredited by the Authority of TAF according to the ISO-17025 quality assessment standard and technical standard(s).

Test results included in this report is only for the WIFI 2.4GHz part.

2. SUMMARY OF TEST RESULTS

Test procedures according to the technical standard(s):

| Applied Standard(s): FCC Part15 (15.247) , Subpart C | | | | |
|--|---------------|-------------------------------------|----------|--------|
| Standard(s) | Section | Test Item | Judgment | Remark |
| | 15.207 | Conducted Emission | PASS | |
| | 15.247(d) | Antenna conducted Spurious Emission | PASS | |
| | 15.247(a)(2) | 6dB Bandwidth | PASS | |
| | 15.247(b)(3) | Peak Output Power | PASS | |
| | 15.247(e) | Power Spectral Density | PASS | |
| | 15.203 | Antenna Requirement | PASS | |
| | 15.209/15.205 | Transmitter Radiated Emissions | PASS | |

NOTE:

(1) "N/A" denotes test is not applicable in this test report.

2.1 TEST FACILITY

The test facilities used to collect the test data in this report is at the location of No.3, Jinshagang 1st Road, Shixia, Dalang Town, Dongguan, Guangdong, China.

BTL's test firm number for FCC: 319330

2.2 MEASUREMENT UNCERTAINTY

Where relevant, the following measurement uncertainty levels have been estimated for tests performed on the EUT as specified in CISPR 16-4-2. The BTL measurement uncertainty is less than the CISPR 16-4-2 U_{CISPR} requirement.

The reported uncertainty of measurement $y \pm U$, where expanded uncertainty U is based on a standard uncertainty multiplied by a coverage factor of $k=2$, providing a level of confidence of approximately 95 %.

A. Conducted Measurement:

| Test Site | Method | Measurement Frequency Range | U, (dB) |
|-----------|--------|-----------------------------|---------|
| DG-C02 | CISPR | 150 KHz ~ 30MHz | 2.32 |

B. Radiated Measurement:

| Test Site | Method | Measurement Frequency Range | Ant. H / V | U, (dB) |
|-----------|--------|-----------------------------|------------|---------|
| DG-CB03 | CISPR | 9KHz~30MHz | V | 3.79 |
| | | 9KHz~30MHz | H | 3.57 |
| | | 30MHz ~ 200MHz | V | 3.82 |
| | | 30MHz ~ 200MHz | H | 3.78 |
| | | 200MHz ~ 1,000MHz | V | 4.10 |
| | | 200MHz ~ 1,000MHz | H | 4.06 |
| | | 1GHz~18GHz | V | 3.12 |
| | | 1GHz~18GHz | H | 3.68 |
| | | 18GHz~40GHz | V | 4.15 |
| | | 18GHz~40GHz | H | 4.14 |

Note: Unless specifically mentioned, the uncertainty of measurement has not been taken into account to declare the compliance or non-compliance to the specification.

3. GENERAL INFORMATION

3.1 GENERAL DESCRIPTION OF EUT

| | | | |
|---------------------|---|--|--|
| Equipment | AC1200 WIRELESS DUAL BAND GIGABIT FIBER ROUTER | | |
| Brand Name | netis | | |
| Model Name | WF2780F | | |
| Model Difference | N/A | | |
| Product Description | Operation Frequency | 2412~2462 MHz | |
| | Modulation Technology | 802.11b:DSSS 802.11g:OFDM 802.11n:OFDM | |
| | Bit Rate of Transmitter | 802.11b: 11/5.5/2/1 Mbps 802.11g: 54/48/36/24/18/12/9/6 Mbps 802.11n up to 300 Mbps | |
| | Output Power (Max.) | 802.11b: 17.03dBm 802.11g: 23.68dBm 802.11n(20MHz): 21.73dBm 802.11n(40MHz): 21.36dBm | |
| Power Source | DC voltage supplied from AC/DC adapter. Manufacturer: ShenZhen TOPOW Electronics Co., Ltd. Model Name: NTT101120100UL | | |
| Power Rating | I/P: 100-240V~0.5A 50/60Hz O/P:12V --- 1A | | |

Note:

- For a more detailed features description, please refer to the manufacturer's specifications or the user's manual.
- Channel List:

| CH01 – CH11 for 802.11b, 802.11g, 802.11n(20MHz) CH03 – CH09 for 802.11n(40MHz) | | | | | | | |
|--|-----------------|---------|-----------------|---------|-----------------|---------|-----------------|
| Channel | Frequency (MHz) | Channel | Frequency (MHz) | Channel | Frequency (MHz) | Channel | Frequency (MHz) |
| 01 | 2412 | 04 | 2427 | 07 | 2442 | 10 | 2457 |
| 02 | 2417 | 05 | 2432 | 08 | 2447 | 11 | 2462 |
| 03 | 2422 | 06 | 2437 | 09 | 2452 | | |

3. Table for Filed Antenna

| Ant. | Brand | Model Name | Antenna Type | Connector | Gain (dBi) |
|------|-------|------------|--------------|-----------|------------|
| 1 | N/A | N/A | Dipole | N/A | 5 |
| 2 | N/A | N/A | Dipole | N/A | 5 |

Note:

The EUT incorporates a MIMO function. Physically, the EUT provides two completed transmitters and receivers (2T2R).

4.

| Operating Mode | 2TX |
|----------------|-------------------|
| TX Mode | |
| 802.11b | V (ANT 1 + ANT 2) |
| 802.11g | V (ANT 1 + ANT 2) |
| 802.11n(20MHz) | V (ANT 1 + ANT 2) |
| 802.11n(40MHz) | V (ANT 1 + ANT 2) |

3.2 DESCRIPTION OF TEST MODES

To investigate the maximum EMI emission characteristics generated from EUT, the test system was pre-scanning tested based on the consideration of following EUT operation mode or test configuration mode which possibly have effect on EMI emission level. Each of these EUT operation mode(s) or test configuration mode(s) mentioned above was evaluated respectively.

| Pretest Mode | Description |
|--------------|----------------------------------|
| Mode 1 | TX B MODE CHANNEL 01/06/11 |
| Mode 2 | TX G MODE CHANNEL 01/06/11 |
| Mode 3 | TX N-20MHZ MODE CHANNEL 01/06/11 |
| Mode 4 | TX N-40MHZ MODE CHANNEL 03/06/09 |
| Mode 5 | Normal Link |

The EUT system operated these modes were found to be the worst case during the pre-scanning test as following:

| For Conducted Test | |
|--------------------|-------------|
| Final Test Mode | Description |
| Mode 5 | Normal Link |

| For Radiated Test | |
|-------------------|----------------------------------|
| Final Test Mode | Description |
| Mode 1 | TX B MODE CHANNEL 01/06/11 |
| Mode 2 | TX G MODE CHANNEL 01/06/11 |
| Mode 3 | TX N-20MHZ MODE CHANNEL 01/06/11 |
| Mode 4 | TX N-40MHZ MODE CHANNEL 03/06/09 |

| For Band Edge Test | |
|--------------------|----------------------------------|
| Final Test Mode | Description |
| Mode 1 | TX B MODE CHANNEL 01/06/11 |
| Mode 2 | TX G MODE CHANNEL 01/06/11 |
| Mode 3 | TX N-20MHZ MODE CHANNEL 01/06/11 |
| Mode 4 | TX N-40MHZ MODE CHANNEL 03/06/09 |

| 6dB Spectrum Bandwidth | |
|------------------------|----------------------------------|
| Final Test Mode | Description |
| Mode 1 | TX B MODE CHANNEL 01/06/11 |
| Mode 2 | TX G MODE CHANNEL 01/06/11 |
| Mode 3 | TX N-20MHZ MODE CHANNEL 01/06/11 |
| Mode 4 | TX N-40MHZ MODE CHANNEL 03/06/09 |

| Maximum Conducted Output Power | |
|--------------------------------|----------------------------------|
| Final Test Mode | Description |
| Mode 1 | TX B MODE CHANNEL 01/06/11 |
| Mode 2 | TX G MODE CHANNEL 01/06/11 |
| Mode 3 | TX N-20MHZ MODE CHANNEL 01/06/11 |
| Mode 4 | TX N-40MHZ MODE CHANNEL 03/06/09 |

| Power Spectral Density | |
|------------------------|----------------------------------|
| Final Test Mode | Description |
| Mode 1 | TX B MODE CHANNEL 01/06/11 |
| Mode 2 | TX G MODE CHANNEL 01/06/11 |
| Mode 3 | TX N-20MHZ MODE CHANNEL 01/06/11 |
| Mode 4 | TX N-40MHZ MODE CHANNEL 03/06/09 |

Note:

- (1) The measurements are performed at the high, middle, low available channels.
- (2) 802.11b mode: DBPSK (1Mbps)
 802.11g mode: OFDM (6Mbps)
 802.11n HT20 mode : BPSK (13Mbps)
 802.11n HT40 mode : BPSK (27Mbps)
 For radiated emission tests, the highest output powers were set for final test.
- (3) For radiated below 1G test, the 802.11b is found to be the worst case and recorded.
- (4) The EUT was programmed to be in continuously transmitting mode and the transmit duty cycle is not less than 98%.

3.3 TABLE OF PARAMETERS OF TEXT SOFTWARE SETTING

During testing, channel & power controlling software provided by the customer was used to control the operating channel as well as the output power level. The RF output power selection is for the setting of RF output power expected by the customer and is going to be fixed on the firmware of the final end product power parameters of WLAN

| Test software version | MP_TOOL | | |
|-----------------------|---------|------|------|
| Frequency (MHz) | 2412 | 2437 | 2462 |
| 802.11b | 25 | 25 | 25 |
| 802.11g | 32 | 32 | 32 |
| 802.11n (20MHz) | 30 | 30 | 30 |
| Frequency (MHz) | 2422 | 2437 | 2452 |
| 802.11n (40MHz) | 33 | 33 | 33 |

3.4 BLOCK DIAGRAM SHOWING THE CONFIGURATION OF SYSTEM TESTED

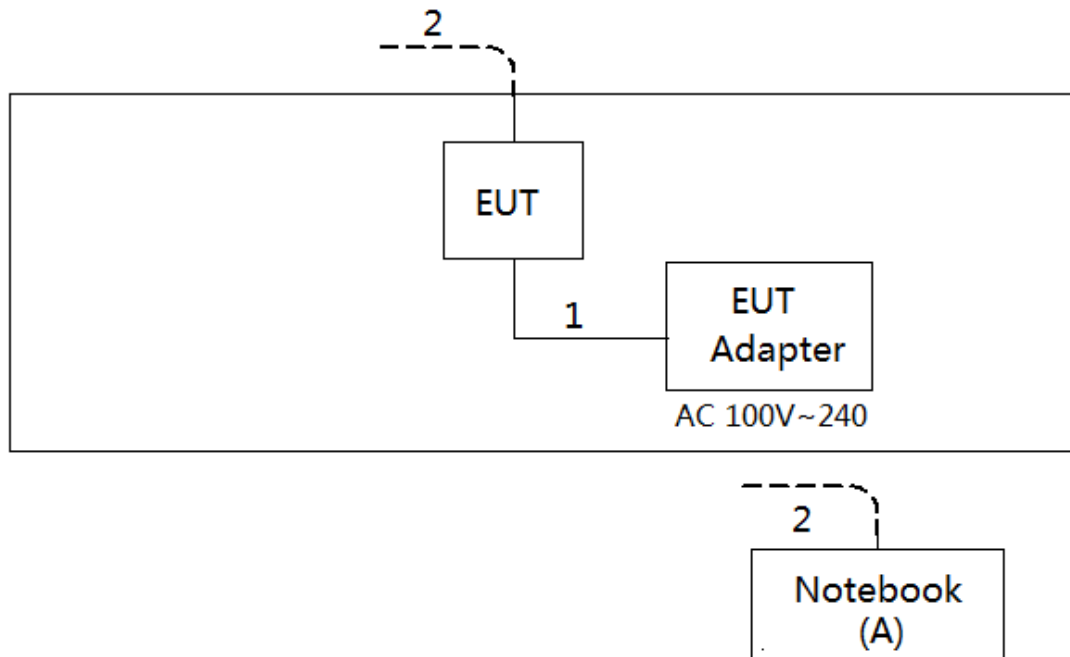

3.5 DESCRIPTION OF SUPPORT UNITS

The EUT has been tested as an independent unit together with other necessary accessories or support units. The following support units or accessories were used to form a representative test configuration during the tests.

| Item | Equipment | Mfr/Brand | Model/Type No. | FCC ID | Series No. |
|------|-----------|-----------|----------------|--------|------------|
| A | NOTEBOOK | Dell | DCSM 745 | DOC | G7K832X |

| Item | Shielded Type | Ferrite Core | Length | Note |
|------|---------------|--------------|--------|-------------|
| 1 | NO | NO | 1.8m | Power Cable |
| 2 | NO | NO | 10m | RJ45 Cable |

4. EMC EMISSION TEST

4.1 CONDUCTED EMISSION MEASUREMENT

4.1.1 POWER LINE CONDUCTED EMISSION LIMITS (Frequency Range 150KHz-30MHz)

| Frequency of Emission (MHz) | Conducted Limit (dBμV) | |
|-----------------------------|------------------------|-----------|
| | Quasi-peak | Average |
| 0.15 -0.50 | 66 to 56* | 56 to 46* |
| 0.50 -5.0 | 56 | 46 |
| 5.0 -30.0 | 60 | 50 |

Note:

- (1) The limit of " * " decreases with the logarithm of the frequency
- (2) The test result calculated as following:
 Measurement Value = Reading Level + Correct Factor
 Correct Factor = Insertion Loss + Cable Loss + Attenuator Factor(if use)
 Margin Level = Measurement Value - Limit Value

The following table is the setting of the receiver

| Receiver Parameters | Setting |
|---------------------|----------|
| Attenuation | 10 dB |
| Start Frequency | 0.15 MHz |
| Stop Frequency | 30 MHz |
| IF Bandwidth | 9 KHz |

4.1.2 TEST PROCEDURE

- a. The EUT was placed 0.8 meters from the horizontal ground plane with EUT being connected to the power mains through a line impedance stabilization network (LISN). All other support equipment powered from additional LISN(s). The LISN provide 50 Ohm/ 50uH of coupling impedance for the measuring instrument.
- b. Interconnecting cables that hang closer than 40 cm to the ground plane shall be folded back and forth in the center forming a bundle 30 to 40 cm long.
- c. I/O cables that are not connected to a peripheral shall be bundled in the center. The end of the cable may be terminated, if required, using the correct terminating impedance. The overall length shall not exceed 1 m.
- d. LISN at least 80 cm from nearest part of EUT chassis.
- e. For the actual test configuration, please refer to the related Item –EUT Test Photos.

4.1.3 DEVIATION FROM TEST STANDARD

No deviation

4.1.4 TEST SETUP

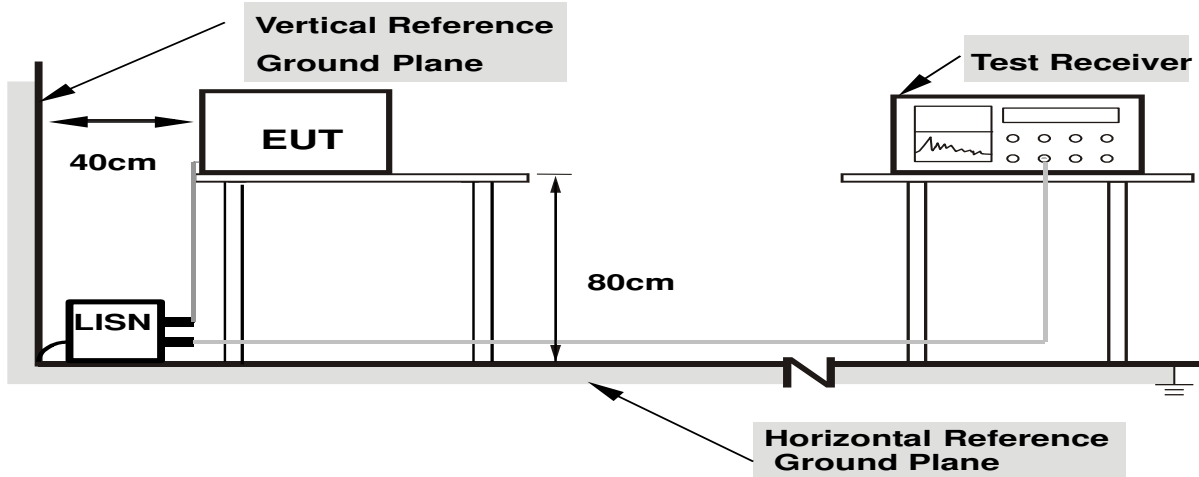

- Note:**
- 1.Support units were connected to second LISN.
 - 2.Both of LISNs (AMN) are 80 cm from EUT and at least 80 from other units and other metal planes

4.1.5 EUT OPERATING CONDITIONS

The EUT was placed on the test table and programmed in normal function.

4.1.6 EUT TEST CONDITIONS

Temperature: 25°C Relative Humidity: 55% Test Voltage: AC 120V/60Hz

4.1.7 TEST RESULTS

Please refer to the Attachment A.

4.2 RADIATED EMISSION MEASUREMENT

4.2.1 RADIATED EMISSION LIMITS

In case the emission fall within the restricted band specified on 15.205(a), then the 15.209(a) limit in the table below has to be followed.

LIMITS OF RADIATED EMISSION MEASUREMENT (9KHz-1000MHz)

| Frequency (MHz) | Field Strength (microvolts/meter) | Measurement Distance (meters) |
|-----------------|-----------------------------------|-------------------------------|
| 0.009~0.490 | 2400/F(KHz) | 300 |
| 0.490~1.705 | 24000/F(KHz) | 30 |
| 1.705~30.0 | 30 | 30 |
| 30~88 | 100 | 3 |
| 88~216 | 150 | 3 |
| 216~960 | 200 | 3 |
| 960~1000 | 500 | 3 |

LIMITS OF RADIATED EMISSION MEASUREMENT (Above 1000MHz)

| Frequency (MHz) | (dBuV/m) (at 3 meters) | |
|-----------------|------------------------|---------|
| | PEAK | AVERAGE |
| Above 1000 | 74 | 54 |

Notes:

- (1) The limit for radiated test was performed according to FCC PART 15C.
- (2) The tighter limit applies at the band edges.
- (3) Emission level (dBuV/m)=20log Emission level (uV/m).
- (4) The test result calculated as following:
 Measurement Value = Reading Level + Correct Factor
 Correct Factor = Antenna Factor + Cable Loss - Amplifier Gain(if use)
 Margin Level = Measurement Value - Limit Value

| Spectrum Parameter | Setting |
|--|---|
| Attenuation | Auto |
| Start Frequency | 1000 MHz |
| Stop Frequency | 10th carrier harmonic |
| RBW / VBW (Emission in restricted band) | 1MHz / 3MHz for Peak, 1MHz / 1/T for Average |

| Receiver Parameter | Setting |
|------------------------|-----------------------------------|
| Attenuation | Auto |
| Start ~ Stop Frequency | 9KHz~90KHz for PK/AVG detector |
| Start ~ Stop Frequency | 90KHz~110KHz for QP detector |
| Start ~ Stop Frequency | 110KHz~490KHz for PK/AVG detector |
| Start ~ Stop Frequency | 490KHz~30MHz for QP detector |
| Start ~ Stop Frequency | 30MHz~1000MHz for QP detector |

4.2.2 TEST PROCEDURE

- a. The measuring distance of 3 m shall be used for measurements. The EUT was placed on the top of a rotating table 0.8 meter above the ground at a 3 meter semi-anechoic chamber. The table was rotated 360 degrees to determine the position of the highest radiation. (below 1GHz)
- b. The measuring distance of 3 m shall be used for measurements. The EUT was placed on the top of a rotating table 1.5 meter above the ground at a 3 meter semi-anechoic chamber. The table was rotated 360 degrees to determine the position of the highest radiation. (above 1GHz)
- c. The height of the equipment or of the substitution antenna shall be 0.8m or 1.5m; the height of the test antenna shall vary between 1 m to 4 m. Both horizontal and vertical polarizations of the antenna are set to make the measurement.
- d. For each suspected emission, the EUT was arranged to its worst case and then the antenna was tuned to heights find the maximum reading (used Bore sight function).
- e. The receiver system was set to peak and average detect function and specified bandwidth with maximum hold mode when the test frequency is above 1GHz.
- f. The initial step in collecting radiated emission data is a receiver peak detector mode pre-scanning the measurement frequency range. Significant peaks are then marked and then Quasi Peak detector mode re-measured.
- g. All readings are Peak unless otherwise stated QP in column of Note. Peak denotes that the Peak reading compliance with the QP Limits and then QP Mode measurement didn't perform. (below 1GHz)
- h. All readings are Peak Mode value unless otherwise stated AVG in column of Note. If the Peak Mode Measured value compliance with the Peak Limits and lower than AVG Limits, the EUT shall be deemed to meet both Peak & AVG Limits and then only Peak Mode was measured, but AVG Mode didn't perform. (above 1GHz)
- i. For the actual test configuration, please refer to the related Item –EUT Test Photos.

4.2.3 DEVIATION FROM TEST STANDARD

No deviation

4.2.4 TEST SETUP

(A) Radiated Emission Test Set-Up Frequency Below 1 GHz

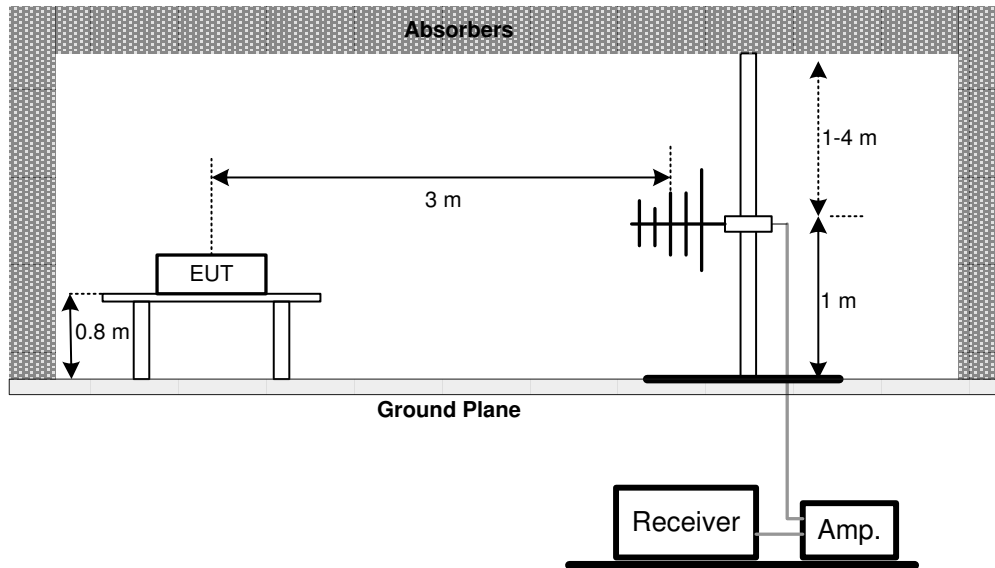

(B) Radiated Emission Test Set-Up Frequency Above 1 GHz

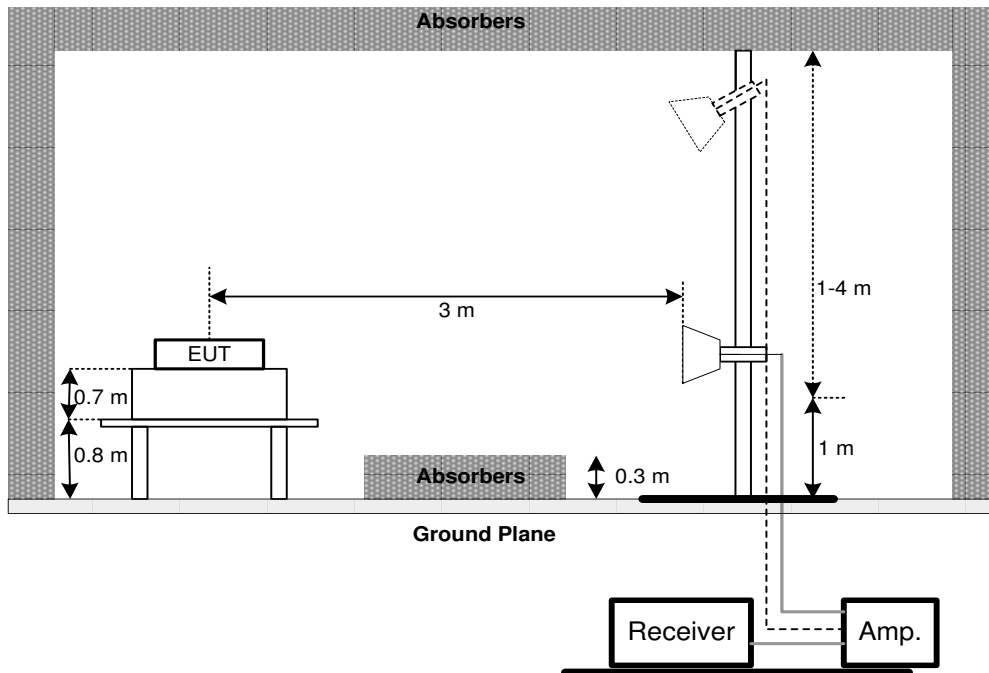

(C) For Radiated Emissions Below 30MHz

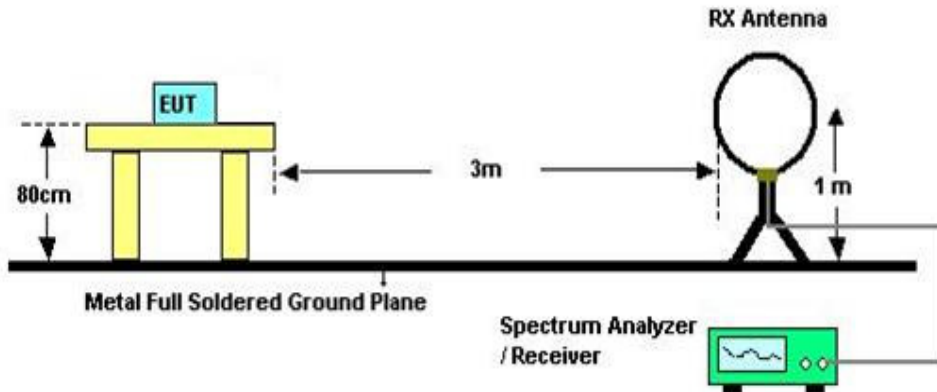

4.2.5 EUT OPERATING CONDITIONS

The EUT was programmed to be in continuously transmitting mode.

4.2.6 EUT TEST CONDITIONS

Temperature: 25°C Relative Humidity: 55% Test Voltage: AC 120V/60Hz

4.2.7 TEST RESULTS (9KHZ TO 30MHZ)

Please refer to the Attachment B

Remark:

- (1) The amplitude of spurious emissions which are attenuated by more than 20 dB below the permissible value has no need to be reported.
- (2) Distance extrapolation factor = $40 \log (\text{specific distance} / \text{test distance})$ (dB).
- (3) Limit line = specific limits (dBuV) + distance extrapolation factor.

4.2.8 TEST RESULTS (30MHZ TO 1000 MHZ)

Please refer to the Attachment C.

4.2.9 TEST RESULTS (ABOVE 1000 MHZ)

Please refer to the Attachment D.

Remark:

- (1) No limit: This is fundamental signal, the judgment is not applicable.
For fundamental signal judgment was referred to Peak output test.

5. BANDWIDTH TEST

5.1 APPLIED PROCEDURES

| FCC Part15 (15.247) , Subpart C | | | |
|---------------------------------|-----------|-----------------------|--------|
| Section | Test Item | Frequency Range (MHz) | Result |
| 15.247(a)(2) | Bandwidth | 2400-2483.5 | PASS |

5.1.1 TEST PROCEDURE

- a. The EUT was directly connected to the spectrum analyzer and antenna output port as show in the block diagram below,
- b. Spectrum Setting: RBW= 100KHz, VBW=300KHz, Sweep time = 2.5 ms.

5.1.2 DEVIATION FROM STANDARD

No deviation.

5.1.3 TEST SETUP

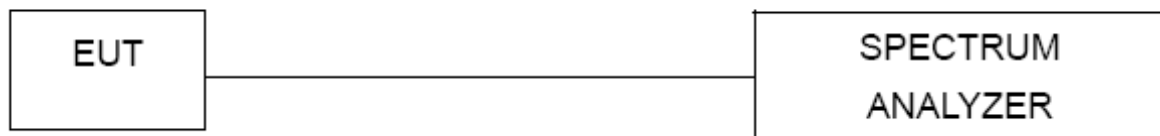

5.1.4 EUT OPERATION CONDITIONS

The EUT was programmed to be in continuously transmitting mode.

5.1.5 EUT TEST CONDITIONS

Temperature: 25°C Relative Humidity: 55% Test Voltage: AC 120V/60Hz

5.1.6 TEST RESULTS

Please refer to the Attachment E.

6. MAXIMUM PEAK CONDUCTED OUTPUT POWER TEST

6.1 APPLIED PROCEDURES / LIMIT

| FCC Part15 (15.247) , Subpart C | | | | |
|---------------------------------|----------------------|-----------------|-----------------------|--------|
| Section | Test Item | Limit | Frequency Range (MHz) | Result |
| 15.247(b)(3) | Maximum Output Power | 1 Watt or 30dBm | 2400-2483.5 | PASS |

6.1.1 TEST PROCEDURE

- a. The EUT was directly connected to the power meter and antenna output port as show in the block diagram below,
- b. The maximum peak conducted output power was performed in accordance with method 9.1.2 of FCC KDB 558074 D01 DTS Meas Guidance and FCC KDB 662911 D01 Multiple Transmitter Output.

6.1.2 DEVIATION FROM STANDARD

No deviation.

6.1.3 TEST SETUP



6.1.4 EUT OPERATION CONDITIONS

The EUT was programmed to be in continuously transmitting mode.

6.1.5 EUT TEST CONDITIONS

Temperature: 25°C Relative Humidity: 55% Test Voltage: AC 120V/60Hz

6.1.6 TEST RESULTS

Please refer to the Attachment F.

7. ANTENNA CONDUCTED SPURIOUS EMISSION

7.1 APPLIED PROCEDURES / LIMIT

In any 100 kHz bandwidth outside the frequency band in which the spread spectrum or digitally modulated device is operating, the RF power that is produced shall be at least 20 dB below that in the 100 kHz bandwidth within the band that contains the highest level of the desired power, based on either an RF conducted or a radiated measurement, provided that the transmitter demonstrates compliance with the peak conducted power limits.

7.1.1 TEST PROCEDURE

- a. The EUT was directly connected to the spectrum analyzer and antenna output port as show in the block diagram below,
- b. Spectrum Setting: RBW= 100KHz, VBW=300KHz, Sweep time = Auto.
- c. Offset=antenna gain+cable loss

7.1.2 DEVIATION FROM STANDARD

No deviation.

7.1.3 TEST SETUP

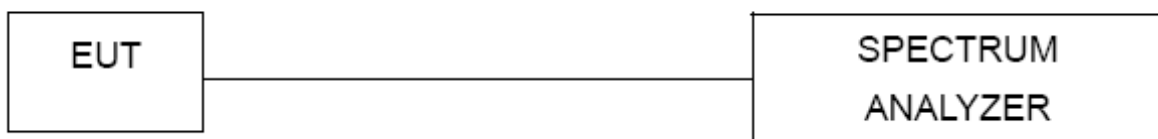

7.1.4 EUT OPERATION CONDITIONS

The EUT was programmed to be in continuously transmitting mode.

7.1.5 EUT TEST CONDITIONS

Temperature: 25°C Relative Humidity: 55% Test Voltage: AC 120V/60Hz

7.1.6 TEST RESULTS

Please refer to the Attachment G.

8. POWER SPECTRAL DENSITY TEST

8.1 APPLIED PROCEDURES / LIMIT

| FCC Part15 (15.247) , Subpart C | | | | |
|---------------------------------|------------------------|---------------------|-----------------------|--------|
| Section | Test Item | Limit | Frequency Range (MHz) | Result |
| 15.247(e) | Power Spectral Density | 8 dBm (in any 3KHz) | 2400-2483.5 | PASS |

8.1.1 TEST PROCEDURE

- a. The EUT was directly connected to the spectrum analyzer and antenna output port as show in the block diagram below,
- b. Spectrum Setting: RBW=3KHz, VBW=10KHz, Sweep time = Auto.

8.1.2 DEVIATION FROM STANDARD

No deviation.

8.1.3 TEST SETUP



8.1.4 EUT OPERATION CONDITIONS

The EUT was programmed to be in continuously transmitting mode.

8.1.5 EUT TEST CONDITIONS

Temperature: 25°C Relative Humidity: 55% Test Voltage: AC 120V/60Hz

8.1.6 TEST RESULTS

Please refer to the Attachment H.

9. MEASUREMENT INSTRUMENTS LIST

| Conducted Emission Measurement | | | | | |
|--------------------------------|----------------------|--------------|--------------------------|------------|------------------|
| Item | Kind of Equipment | Manufacturer | Type No. | Serial No. | Calibrated until |
| 1 | LISN | EMCO | 3816/2 | 0052765 | Mar. 27, 2017 |
| 2 | LISN | R&S | ENV216 | 101447 | Mar. 27, 2017 |
| 3 | Test Cable | emci | RG223(9KHz-30MHz) | C_17 | Mar. 10, 2017 |
| 4 | EMI Test Receiver | R&S | ESCI | 100382 | Mar. 27, 2017 |
| 5 | 50Ω Terminator | SHX | TF2-3G-A | 08122901 | Mar. 27, 2017 |
| 6 | Measurement Software | Farad | EZ-EMC Ver.NB-03A1-01 | N/A | N/A |

| Radiated Emission Measurement | | | | | |
|-------------------------------|-------------------------------------|----------------|--------------------------------------|---------------|------------------|
| Item | Kind of Equipment | Manufacturer | Type No. | Serial No. | Calibrated until |
| 1 | Antenna | Schwarbeck | VULB9160 | 9160-3232 | Mar. 27, 2017 |
| 2 | Amplifier | HP | 8447D | 2944A09673 | Nov. 09, 2016 |
| 3 | Receiver | AGILENT | N9038A | MY52130039 | Sep. 04, 2017 |
| 4 | Test Cable | emci | LMR-400(30MHz-1GHz) | C-01 | Jun. 26, 2017 |
| 5 | Control | CT | SC100 | N/A | N/A |
| 6 | Position Control | MF | MF-7802 | MF780208416 | N/A |
| 7 | Antenna | ETS | 3115 | 00075789 | Mar. 27, 2017 |
| 8 | Amplifier | Agilent | 8449B | 3008A02274 | Nov. 01, 2017 |
| 9 | Test Cable | emci | EMC104-SM-S M-10000(1GHz-26.5GHz) | C-68 | Jun. 26, 2017 |
| 10 | Controller | CT | SC100 | N/A | N/A |
| 11 | Broad-Band Horn Antenna | Schwarzbeck | BBHA 9170 | 9170319 | Apr. 23, 2017 |
| 12 | Microwave Preamplifier With Adaptor | EMC INSTRUMENT | EMC2654045 | 980039 & HA01 | Mar. 27, 2017 |
| 13 | Active Loop Antenna | R&S | HFH2-Z2 | 830749/020 | Sep. 06, 2017 |
| 14 | Measurement Software | Farad | EZ-EMC Ver.NB-03A1-01 | N/A | N/A |

| 6dB Bandwidth Measurement | | | | | |
|---------------------------|-------------------|--------------|----------|------------|------------------|
| Item | Kind of Equipment | Manufacturer | Type No. | Serial No. | Calibrated until |
| 1 | Spectrum Analyzer | R&S | FSP 40 | 100185 | Sep. 04, 2017 |

| Peak Output Power Measurement | | | | | |
|-------------------------------|-----------------------|--------------|----------|------------|------------------|
| Item | Kind of Equipment | Manufacturer | Type No. | Serial No. | Calibrated until |
| 1 | P-series Power meter | Agilent | N1911A | MY45100473 | Sep. 04, 2017 |
| 2 | Wireband Power sensor | Agilent | N1921A | MY51100041 | Sep. 04, 2017 |

| Antenna Conducted Spurious Emission Measurement | | | | | |
|---|-------------------|--------------|----------|------------|------------------|
| Item | Kind of Equipment | Manufacturer | Type No. | Serial No. | Calibrated until |
| 1 | Spectrum Analyzer | R&S | FSP 40 | 100185 | Sep. 04, 2017 |

| Power Spectral Density Measurement | | | | | |
|------------------------------------|-------------------|--------------|----------|------------|------------------|
| Item | Kind of Equipment | Manufacturer | Type No. | Serial No. | Calibrated until |
| 1 | Spectrum Analyzer | R&S | FSP 40 | 100185 | Sep. 04, 2017 |

Remark: "N/A" denotes no model name, serial no. or calibration specified.
 All calibration period of equipment list is one year.

10. EUT TEST PHOTO**Conducted Measurement Photos**

Radiated Measurement Photos

9KHz to 30MHz

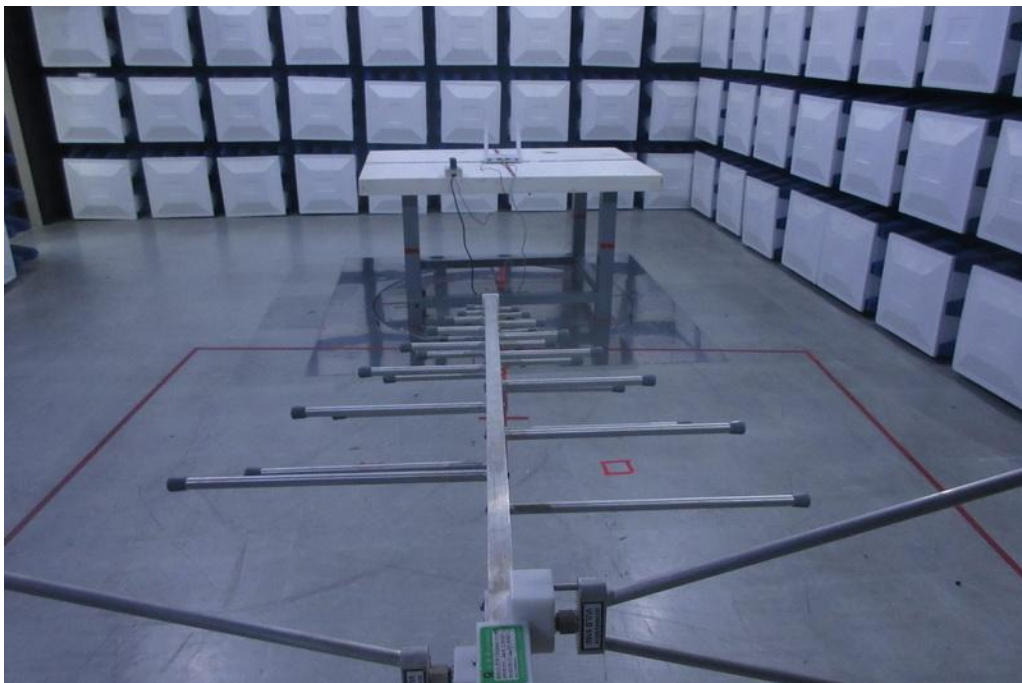

Radiated Measurement Photos**30MHz to 1000MHz**

Radiated Measurement Photos

Above 1000MHz



ATTACHMENT A - CONDUCTED EMISSION

Test Mode : Normal Link

Line

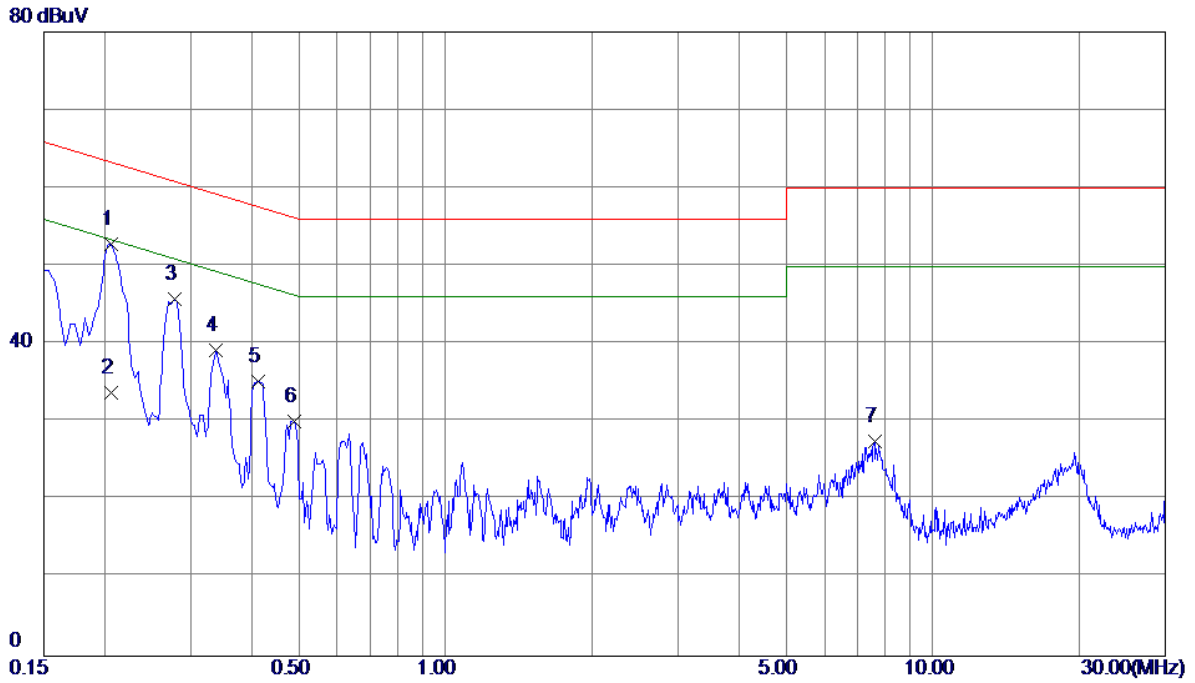

| No. | Freq. MHz | Reading Level dBuV | Correct Factor dB | Measure ment dBuV | Limit dBuV | Margin dB | Detector | Comment |
|-----|--------------|--------------------------|-------------------------|-------------------------|---------------|--------------|----------|---------|
| 1 * | 0.2060 | 43.33 | 9.53 | 52.86 | 63.37 | -10.51 | Peak | |
| 2 | 0.2060 | 24.20 | 9.53 | 33.73 | 53.37 | -19.64 | AVG | |
| 3 | 0.2779 | 36.21 | 9.53 | 45.74 | 60.88 | -15.14 | Peak | |
| 4 | 0.3379 | 29.60 | 9.53 | 39.13 | 59.25 | -20.12 | Peak | |
| 5 | 0.4140 | 25.67 | 9.55 | 35.22 | 57.57 | -22.35 | Peak | |
| 6 | 0.4900 | 20.47 | 9.63 | 30.10 | 56.17 | -26.07 | Peak | |
| 7 | 7.5980 | 17.37 | 10.17 | 27.54 | 60.00 | -32.46 | Peak | |

Test Mode : Normal Link

Neutral

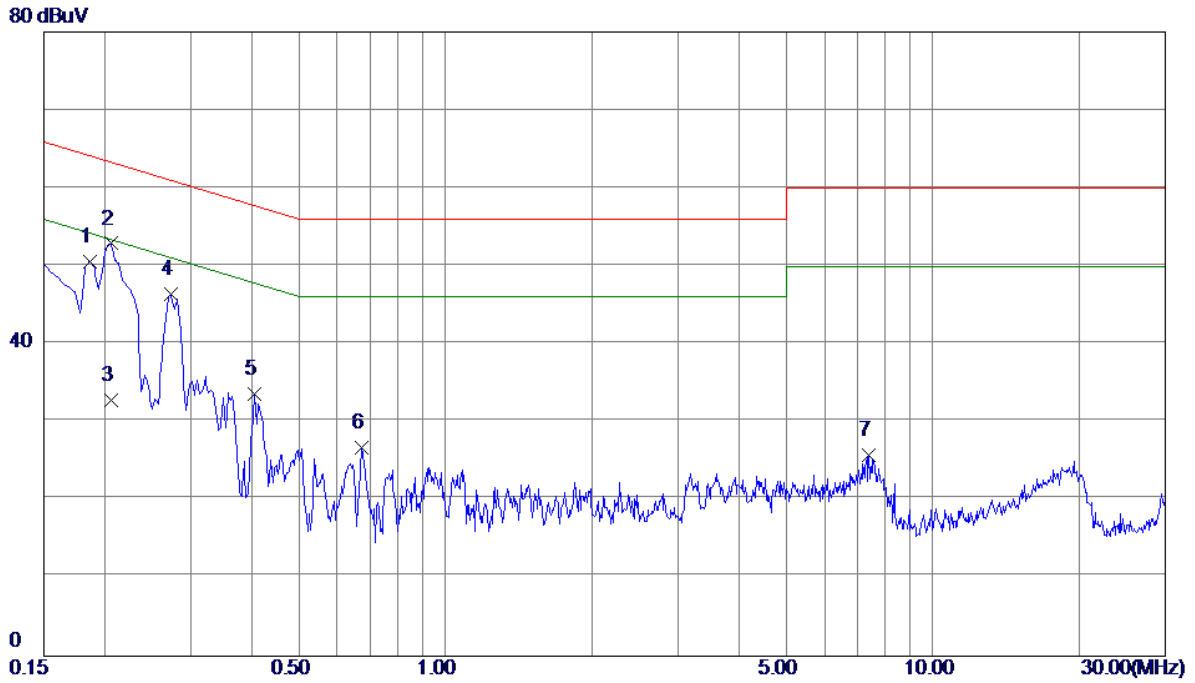

| No. | Freq. MHz | Reading Level dBuV | Correct Factor dB | Measure ment dBuV | Limit dBuV | Margin dB | Detector | Comment |
|-----|--------------|--------------------------|-------------------------|-------------------------|---------------|--------------|----------|---------|
| 1 | 0.1860 | 41.12 | 9.48 | 50.60 | 64.21 | -13.61 | Peak | |
| 2 * | 0.2060 | 43.35 | 9.53 | 52.88 | 63.37 | -10.49 | Peak | |
| 3 | 0.2060 | 23.30 | 9.53 | 32.83 | 53.37 | -20.54 | AVG | |
| 4 | 0.2740 | 36.84 | 9.53 | 46.37 | 61.00 | -14.63 | Peak | |
| 5 | 0.4060 | 24.16 | 9.44 | 33.60 | 57.73 | -24.13 | Peak | |
| 6 | 0.6740 | 17.30 | 9.45 | 26.75 | 56.00 | -29.25 | Peak | |
| 7 | 7.3900 | 15.75 | 10.00 | 25.75 | 60.00 | -34.25 | Peak | |

ATTACHMENT B - RADIATED EMISSION (9KHZ TO 30MHZ)

Test Mode: TX B MODE CHANNEL 01

Ant 0°

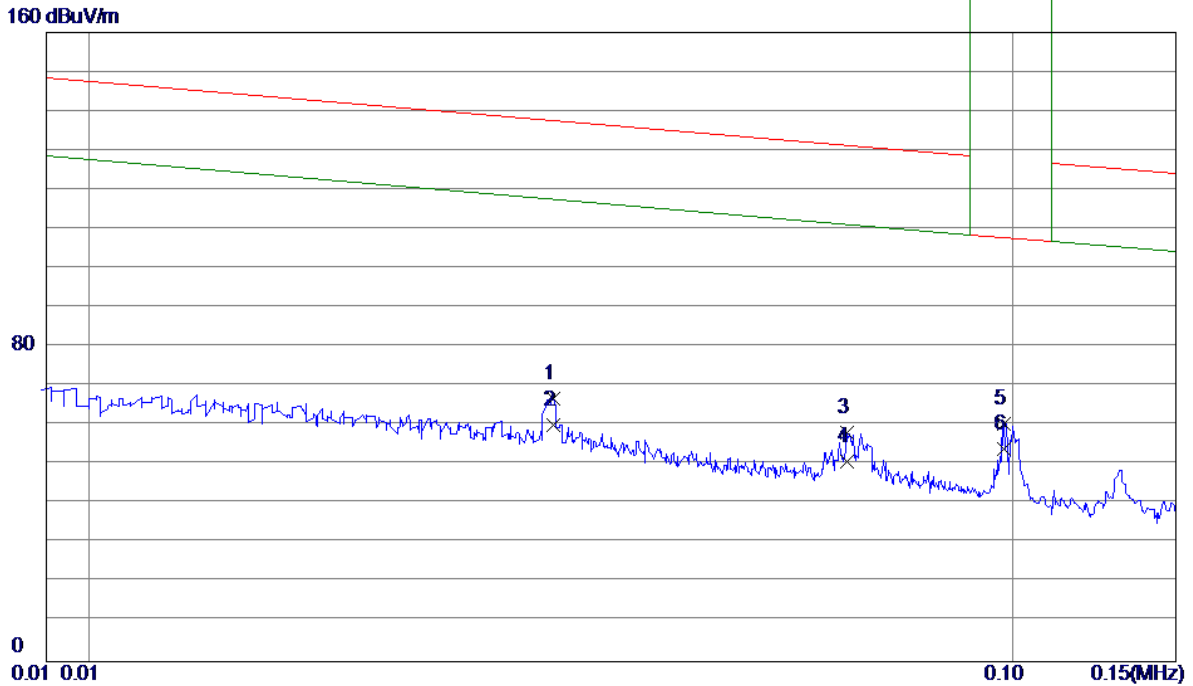

| No. | Freq. MHz | Reading Level dBuV/m | Correct Factor dB | Measure ment dBuV/m | Limit dBuV/m | Margin dB | Detector | Comment |
|-----|--------------|----------------------------|-------------------------|---------------------------|-----------------|--------------|----------|---------|
| 1 | 0.0318 | 44.94 | 22.07 | 67.01 | 142.87 | -75.86 | Peak | |
| 2 | 0.0318 | 38.11 | 22.07 | 60.18 | 122.87 | -62.69 | AVG | |
| 3 | 0.0661 | 38.69 | 19.63 | 58.32 | 134.40 | -76.08 | Peak | |
| 4 | 0.0661 | 31.36 | 19.63 | 50.99 | 114.40 | -63.41 | AVG | |
| 5 * | 0.0978 | 42.02 | 18.53 | 60.55 | 107.84 | -47.29 | Peak | |
| 6 | 0.0978 | 35.54 | 18.53 | 54.07 | 999.00 | -944.93 | AVG | |

Test Mode: TX B MODE CHANNEL 01

Ant 0°

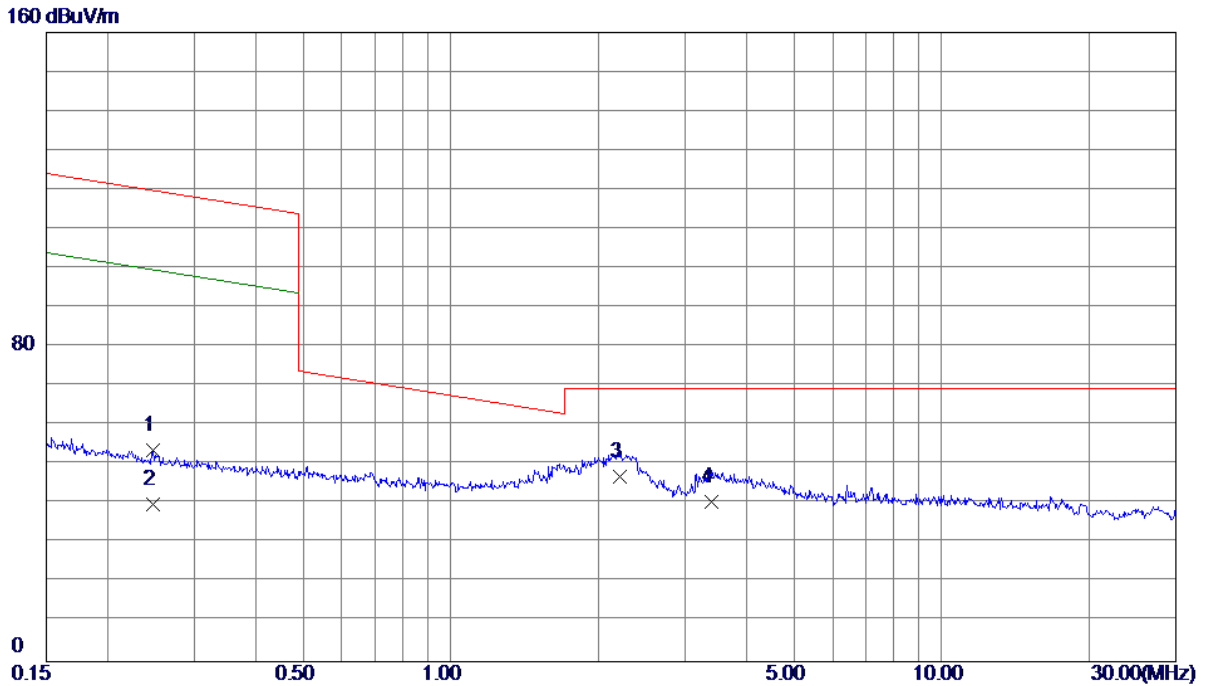

| No. | Freq. MHz | Reading Level dBuV/m | Correct Factor dB | Measure ment dBuV/m | Limit dBuV/m | Margin dB | Detector | Comment |
|-----|--------------|----------------------------|-------------------------|---------------------------|-----------------|--------------|----------|---------|
| 1 | 0.2468 | 35.01 | 18.65 | 53.66 | 122.11 | -68.45 | Peak | |
| 2 | 0.2468 | 21.30 | 18.65 | 39.95 | 102.11 | -62.16 | AVG | |
| 3 * | 2.2132 | 29.30 | 17.63 | 46.93 | 69.54 | -22.61 | QP | |
| 4 | 3.3994 | 23.10 | 17.48 | 40.58 | 69.54 | -28.96 | QP | |

Test Mode: TX B MODE CHANNEL 01

Ant 90°

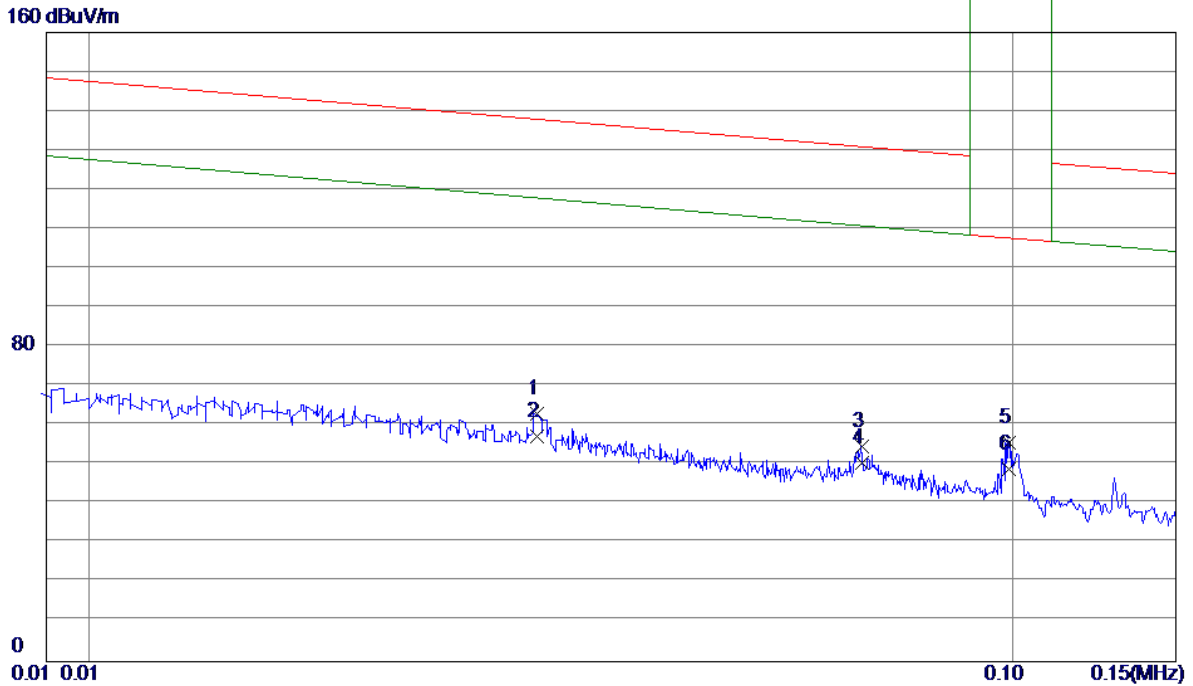

| No. | Freq. MHz | Reading Level dBuV/m | Correct Factor dB | Measure ment dBuV/m | Limit dBuV/m | Margin dB | Detector | Comment |
|-----|--------------|----------------------------|-------------------------|---------------------------|-----------------|--------------|----------|---------|
| 1 | 0.0306 | 40.70 | 22.22 | 62.92 | 143.16 | -80.24 | Peak | |
| 2 | 0.0306 | 35.16 | 22.22 | 57.38 | 123.16 | -65.78 | AVG | |
| 3 | 0.0686 | 35.11 | 19.60 | 54.71 | 133.78 | -79.07 | Peak | |
| 4 | 0.0686 | 30.82 | 19.60 | 50.42 | 113.78 | -63.36 | AVG | |
| 5 * | 0.0990 | 37.24 | 18.47 | 55.71 | 107.73 | -52.02 | Peak | |
| 6 | 0.0990 | 30.57 | 18.47 | 49.04 | 999.00 | -949.96 | AVG | |

Test Mode: TX B MODE CHANNEL 01

Ant 90°

160 dBuV/m

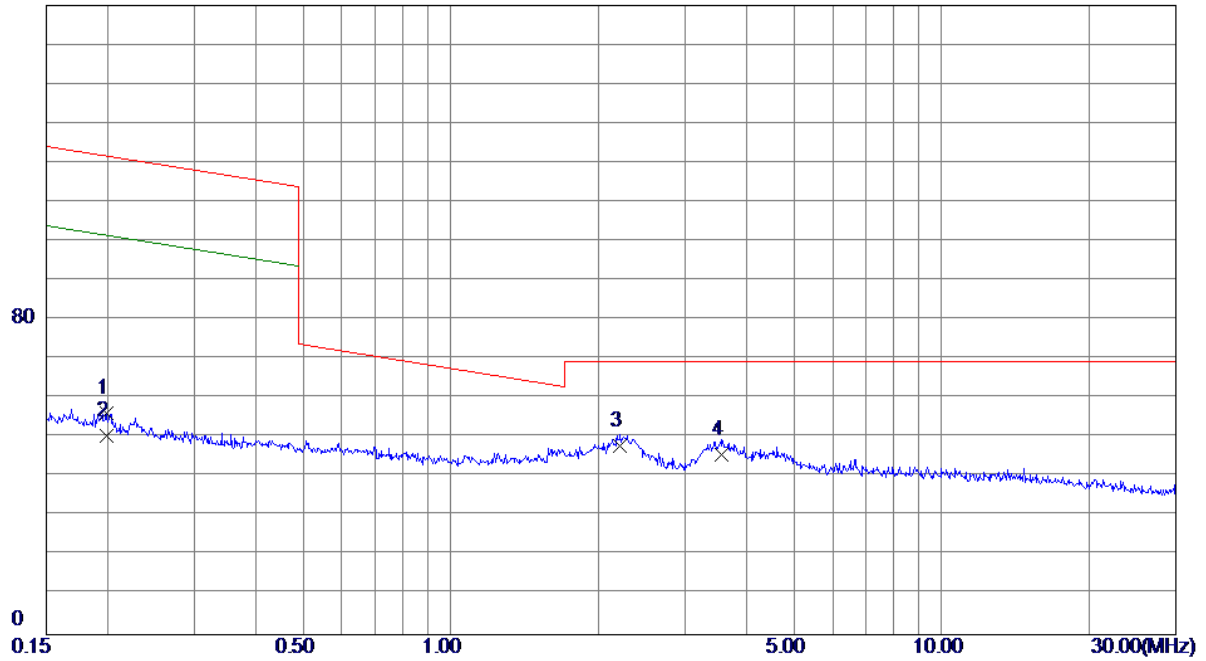

| No. | Freq. MHz | Reading Level dBuV/m | Correct Factor dB | Measure ment dBuV/m | Limit dBuV/m | Margin dB | Detector | Comment |
|-----|--------------|----------------------------|-------------------------|---------------------------|-----------------|--------------|----------|---------|
| 1 | 0.1986 | 37.59 | 18.70 | 56.29 | 123.75 | -67.46 | Peak | |
| 2 | 0.1986 | 31.88 | 18.70 | 50.58 | 103.75 | -53.17 | AVG | |
| 3 * | 2.2132 | 30.24 | 17.63 | 47.87 | 69.54 | -21.67 | QP | |
| 4 | 3.5653 | 27.91 | 17.83 | 45.74 | 69.54 | -23.80 | QP | |

ATTACHMENT C - RADIATED EMISSION (30MHZ TO 1000MHZ)

Test Mode: TX B MODE CHANNEL 01

Vertical

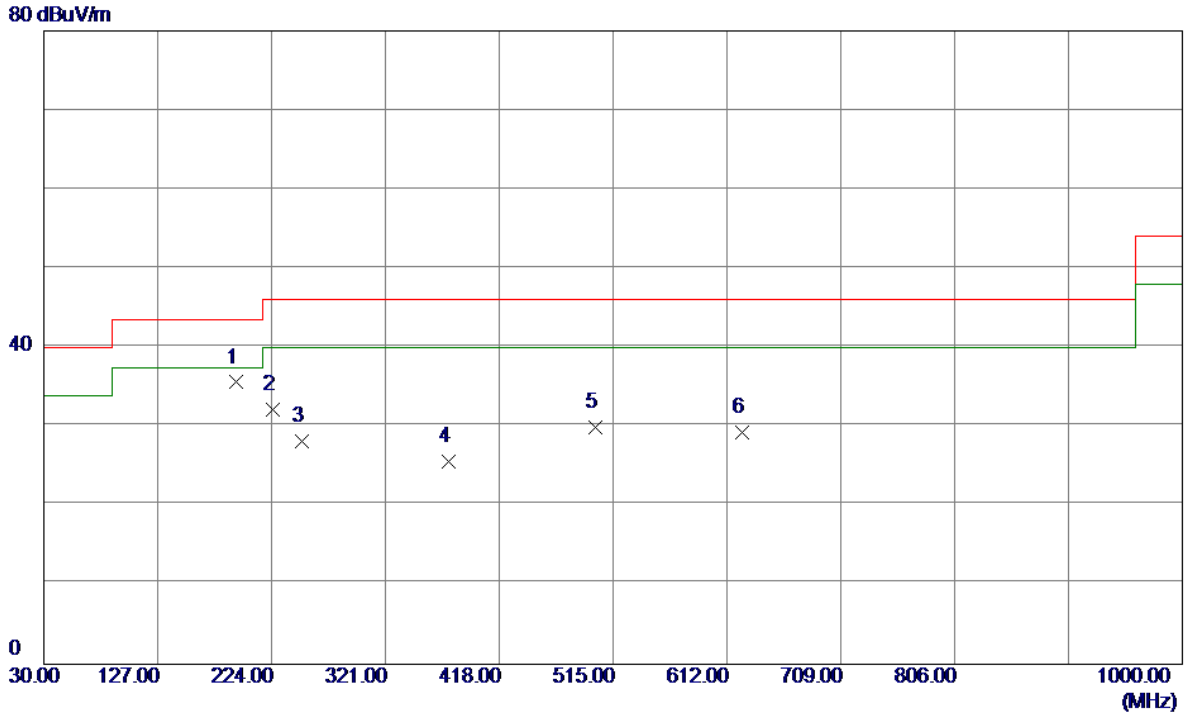

| No. | Freq. MHz | Reading Level dBuV/m | Correct Factor dB | Measure ment dBuV/m | Limit dBuV/m | Margin dB | Detector | Comment |
|-----|--------------|----------------------------|-------------------------|---------------------------|-----------------|--------------|----------|---------|
| 1 * | 193.4450 | 49.70 | -14.10 | 35.60 | 43.50 | -7.90 | Peak | |
| 2 | 224.9700 | 45.95 | -13.82 | 32.13 | 46.00 | -13.87 | Peak | |
| 3 | 250.1900 | 42.30 | -14.20 | 28.10 | 46.00 | -17.90 | Peak | |
| 4 | 374.8350 | 35.10 | -9.51 | 25.59 | 46.00 | -20.41 | Peak | |
| 5 | 499.9650 | 39.59 | -9.72 | 29.87 | 46.00 | -16.13 | Peak | |
| 6 | 625.0949 | 34.95 | -5.61 | 29.34 | 46.00 | -16.66 | Peak | |

Test Mode: TX B MODE CHANNEL 01

Horizontal

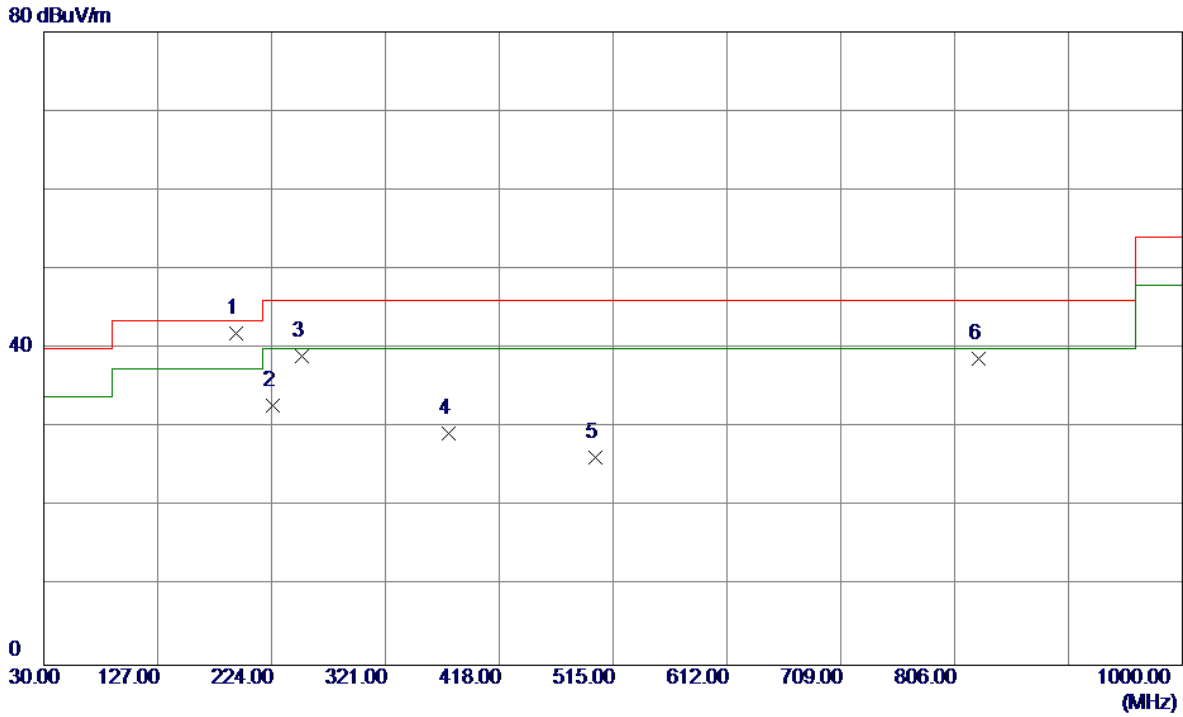

| No. | Freq. MHz | Reading Level dBuV/m | Correct Factor dB | Measure ment dBuV/m | Limit dBuV/m | Margin dB | Detector | Comment |
|-----|--------------|----------------------------|-------------------------|---------------------------|-----------------|--------------|----------|---------|
| 1 * | 193.4450 | 56.04 | -14.10 | 41.94 | 43.50 | -1.56 | QP | |
| 2 | 224.9700 | 46.65 | -13.82 | 32.83 | 46.00 | -13.17 | Peak | |
| 3 | 250.1900 | 53.17 | -14.20 | 38.97 | 46.00 | -7.03 | Peak | |
| 4 | 374.8350 | 38.84 | -9.51 | 29.33 | 46.00 | -16.67 | Peak | |
| 5 | 499.9650 | 35.89 | -9.72 | 26.17 | 46.00 | -19.83 | Peak | |
| 6 | 826.8550 | 39.24 | -0.55 | 38.69 | 46.00 | -7.31 | Peak | |

Test Mode: TX B MODE CHANNEL 06

Vertical

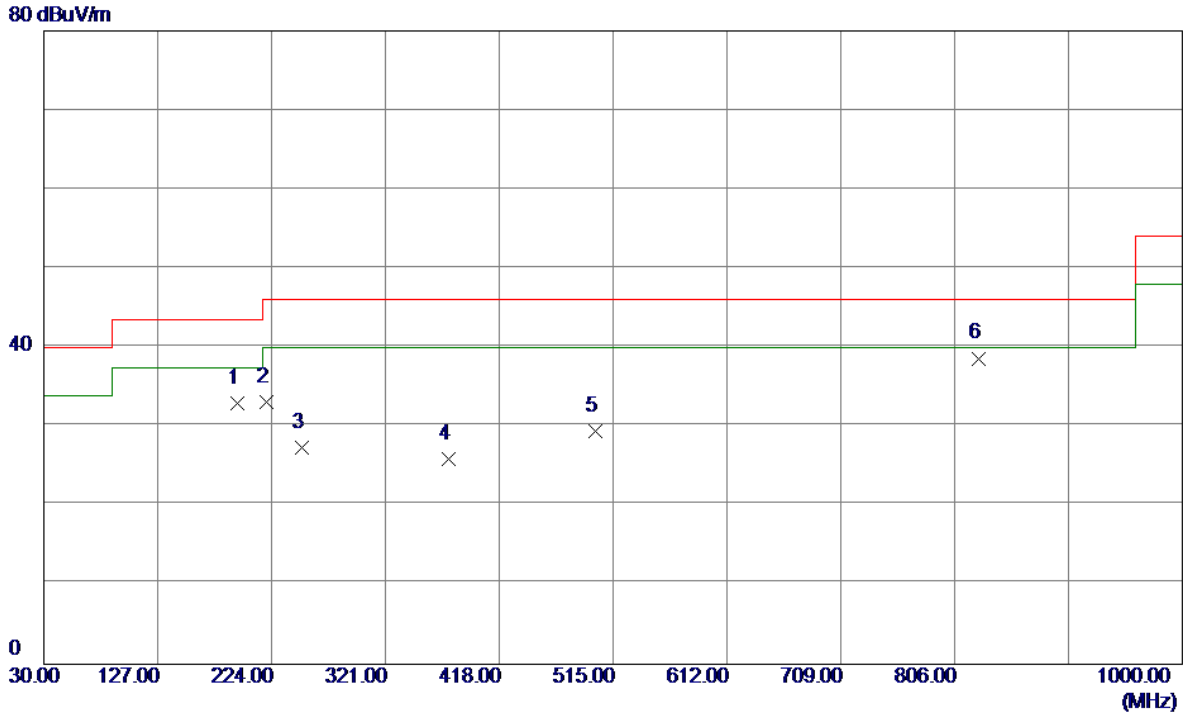

| No. | Freq. MHz | Reading Level dBuV/m | Correct Factor dB | Measure ment dBuV/m | Limit dBuV/m | Margin dB | Detector | Comment |
|-----|--------------|----------------------------|-------------------------|---------------------------|-----------------|--------------|----------|---------|
| 1 | 194.9000 | 47.18 | -14.18 | 33.00 | 43.50 | -10.50 | Peak | |
| 2 | 220.1200 | 47.32 | -14.25 | 33.07 | 46.00 | -12.93 | Peak | |
| 3 | 250.1900 | 41.59 | -14.20 | 27.39 | 46.00 | -18.61 | Peak | |
| 4 | 374.8350 | 35.49 | -9.51 | 25.98 | 46.00 | -20.02 | Peak | |
| 5 | 499.9650 | 39.18 | -9.72 | 29.46 | 46.00 | -16.54 | Peak | |
| 6 * | 826.8550 | 39.19 | -0.55 | 38.64 | 46.00 | -7.36 | Peak | |

Test Mode: TX B MODE CHANNEL 06

Horizontal

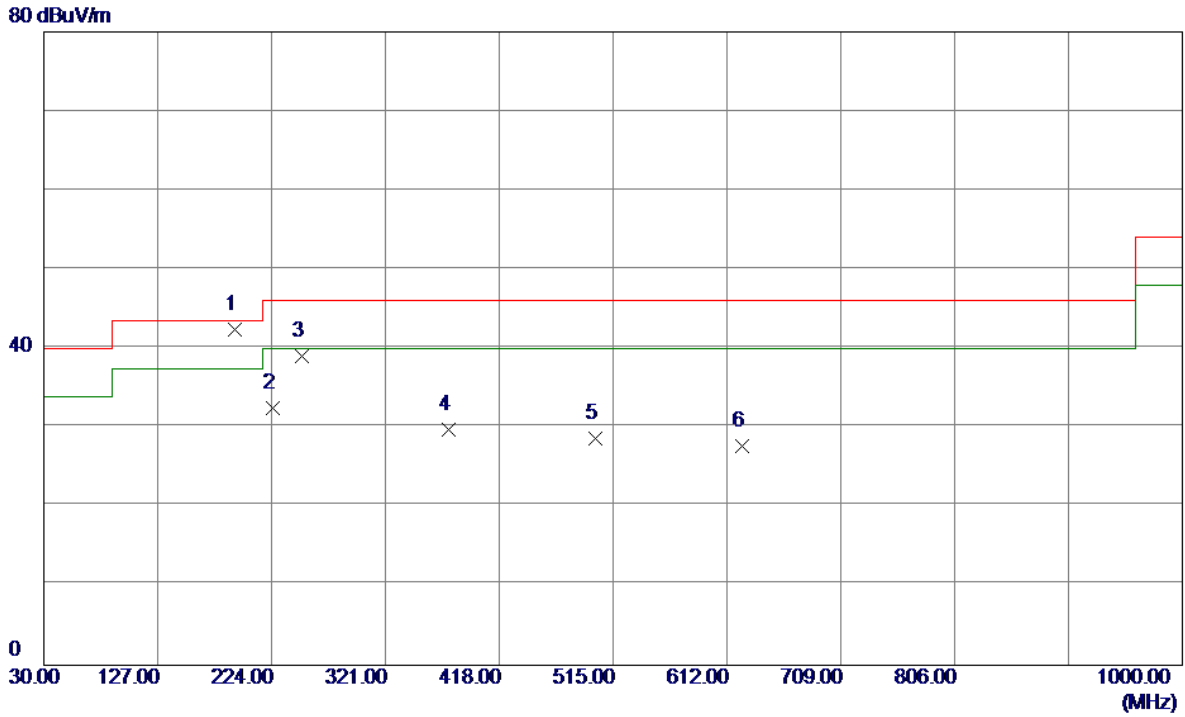

| No. | Freq. MHz | Reading Level dBuV/m | Correct Factor dB | Measure ment dBuV/m | Limit dBuV/m | Margin dB | Detector | Comment |
|-----|--------------|----------------------------|-------------------------|---------------------------|-----------------|--------------|----------|---------|
| 1 * | 192.4750 | 56.42 | -14.06 | 42.36 | 43.50 | -1.14 | QP | |
| 2 | 224.9700 | 46.27 | -13.82 | 32.45 | 46.00 | -13.55 | Peak | |
| 3 | 250.1900 | 53.24 | -14.20 | 39.04 | 46.00 | -6.96 | Peak | |
| 4 | 374.8350 | 39.32 | -9.51 | 29.81 | 46.00 | -16.19 | Peak | |
| 5 | 499.9650 | 38.43 | -9.72 | 28.71 | 46.00 | -17.29 | Peak | |
| 6 | 625.0949 | 33.30 | -5.61 | 27.69 | 46.00 | -18.31 | Peak | |

Test Mode: TX B MODE CHANNEL 11

Vertical

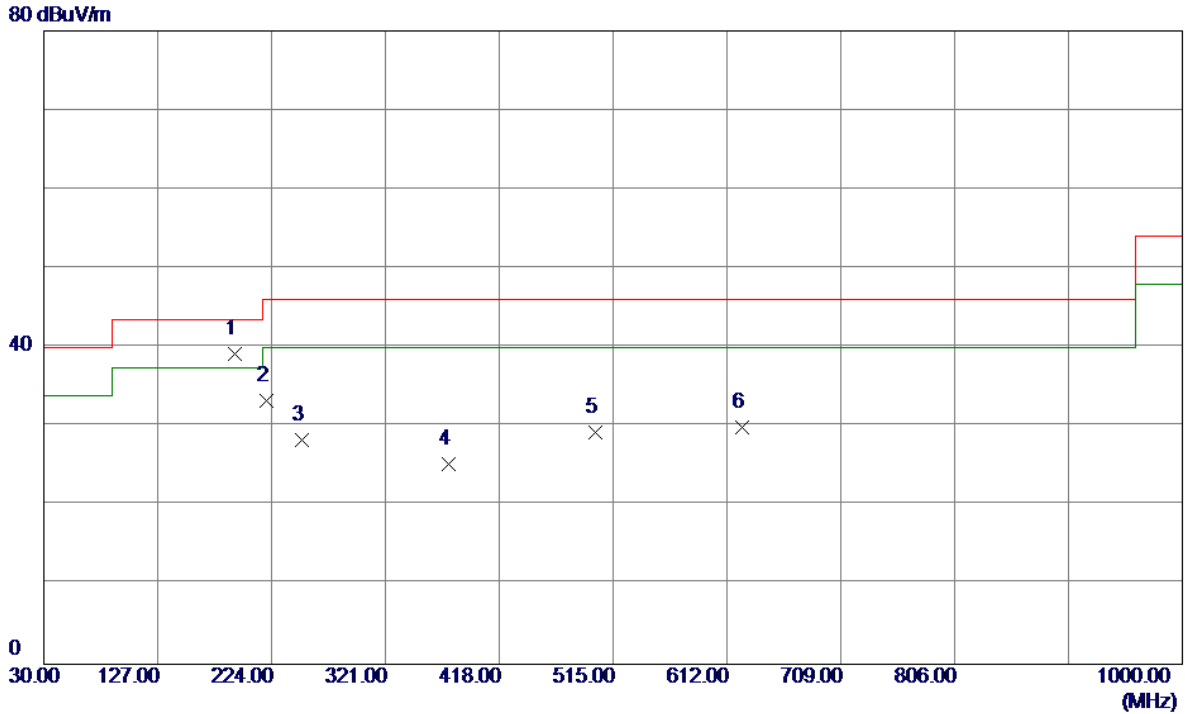

| No. | Freq. MHz | Reading Level dBuV/m | Correct Factor dB | Measure ment dBuV/m | Limit dBuV/m | Margin dB | Detector | Comment |
|-----|--------------|----------------------------|-------------------------|---------------------------|-----------------|--------------|----------|---------|
| 1 * | 192.4750 | 53.21 | -14.06 | 39.15 | 43.50 | -4.35 | Peak | |
| 2 | 220.1200 | 47.47 | -14.25 | 33.22 | 46.00 | -12.78 | Peak | |
| 3 | 250.1900 | 42.58 | -14.20 | 28.38 | 46.00 | -17.62 | Peak | |
| 4 | 374.8350 | 34.76 | -9.51 | 25.25 | 46.00 | -20.75 | Peak | |
| 5 | 499.9650 | 39.03 | -9.72 | 29.31 | 46.00 | -16.69 | Peak | |
| 6 | 625.0949 | 35.55 | -5.61 | 29.94 | 46.00 | -16.06 | Peak | |

Test Mode: TX B MODE CHANNEL 11

Horizontal

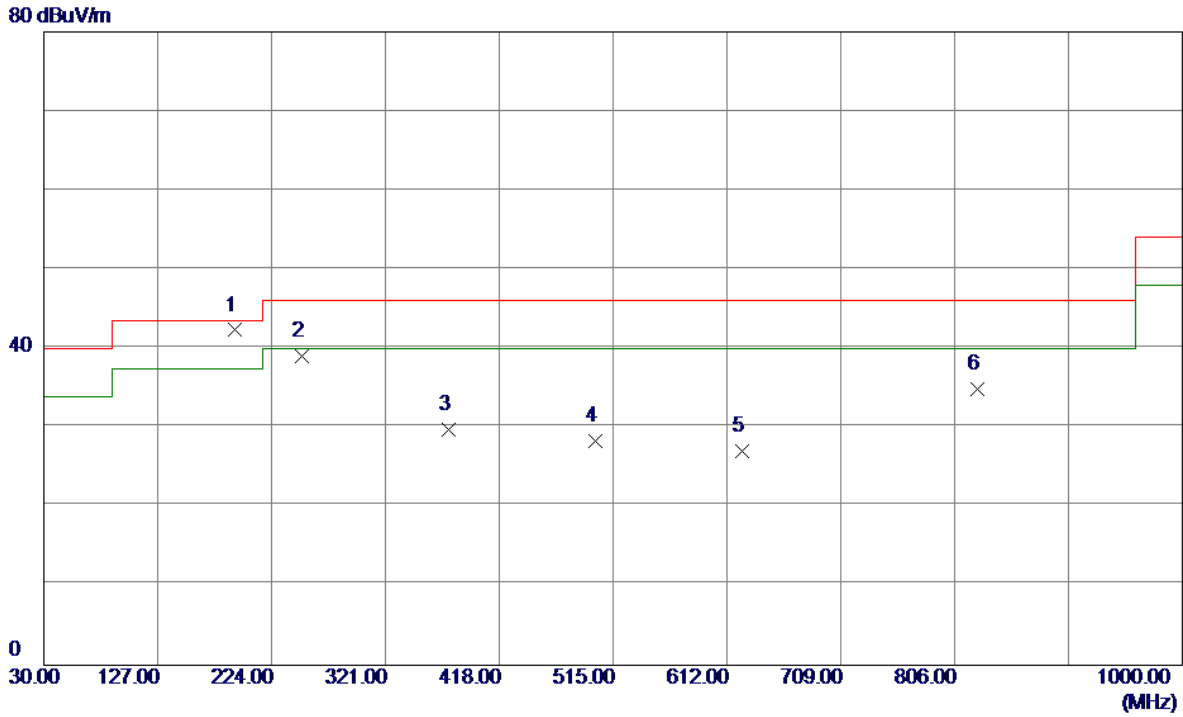

| No. | Freq. MHz | Reading Level dBuV/m | Correct Factor dB | Measure ment dBuV/m | Limit dBuV/m | Margin dB | Detector | Comment |
|-----|--------------|----------------------------|-------------------------|---------------------------|-----------------|--------------|----------|---------|
| 1 * | 192.9600 | 56.40 | -14.08 | 42.32 | 43.50 | -1.18 | QP | |
| 2 | 250.1900 | 53.21 | -14.20 | 39.01 | 46.00 | -6.99 | Peak | |
| 3 | 374.8350 | 39.23 | -9.51 | 29.72 | 46.00 | -16.28 | Peak | |
| 4 | 499.9650 | 38.02 | -9.72 | 28.30 | 46.00 | -17.70 | Peak | |
| 5 | 625.0949 | 32.63 | -5.61 | 27.02 | 46.00 | -18.98 | Peak | |
| 6 | 825.8850 | 35.41 | -0.52 | 34.89 | 46.00 | -11.11 | Peak | |

ATTACHMENT D - RADIATED EMISSION (ABOVE 1000MHZ)

| | |
|-------------------|-------------------|
| Orthogonal Axis : | X |
| Test Mode : | TX B MODE 2412MHz |

Vertical

125 dBuV/m

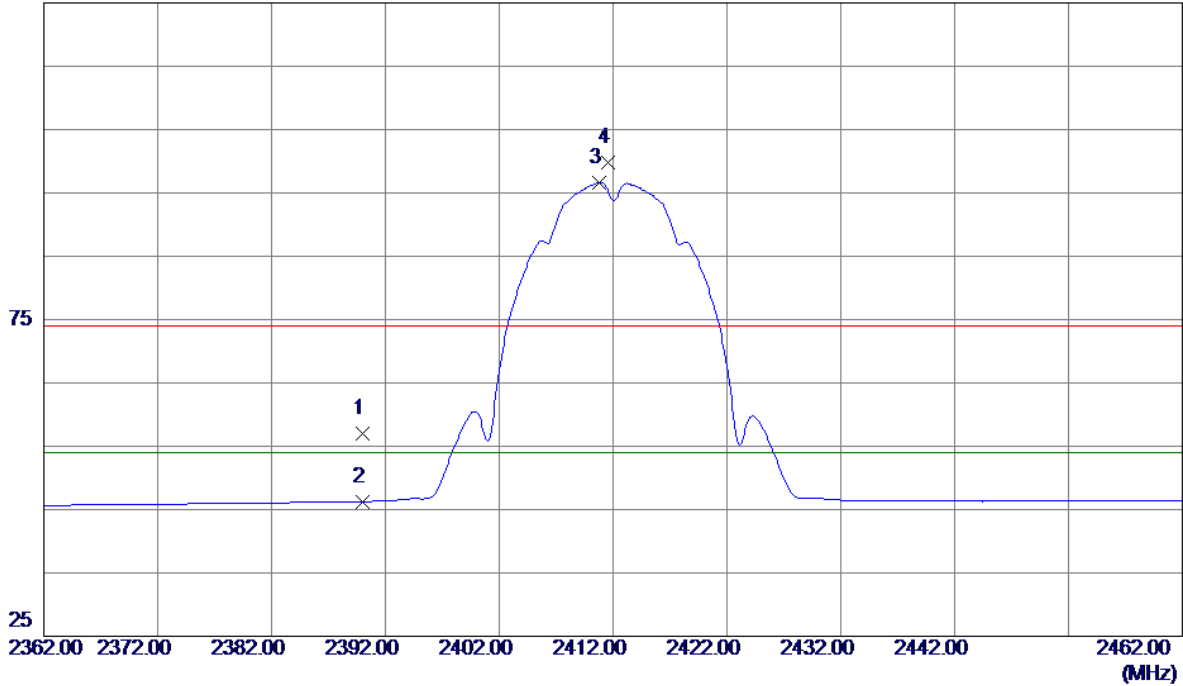

| No. | Freq. MHz | Reading Level dBuV/m | Correct Factor dB | Measure ment dBuV/m | Limit dBuV/m | Margin dB | Detector | Comment |
|-----|--------------|----------------------------|-------------------------|---------------------------|-----------------|--------------|----------|----------|
| 1 | 2390.0000 | 23.21 | 33.88 | 57.09 | 74.00 | -16.91 | Peak | |
| 2 | 2390.0000 | 12.38 | 33.88 | 46.26 | 54.00 | -7.74 | AVG | |
| 3 * | 2410.8000 | 62.60 | 34.00 | 96.60 | 54.00 | 42.60 | AVG | No Limit |
| 4 | 2411.6000 | 65.74 | 34.00 | 99.74 | 74.00 | 25.74 | Peak | No Limit |

| | |
|-------------------|-------------------|
| Orthogonal Axis : | X |
| Test Mode : | TX B MODE 2412MHz |

Vertical

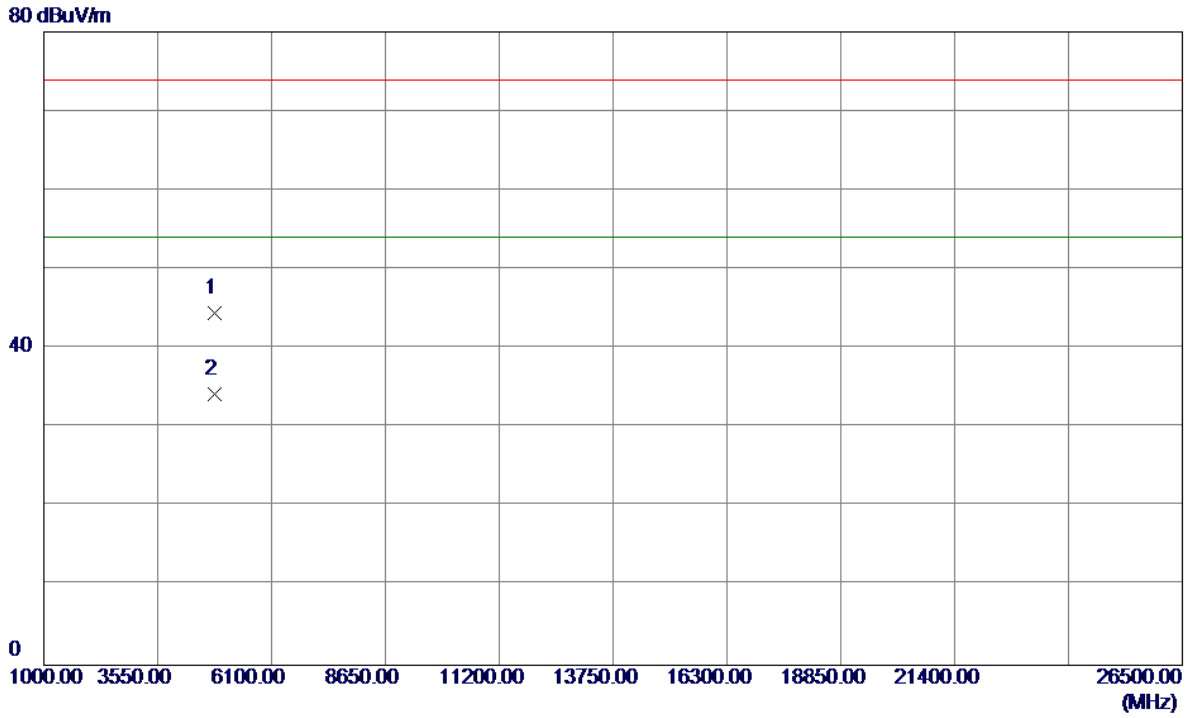

| No. | Freq. MHz | Reading Level dBuV/m | Correct Factor dB | Measure ment dBuV/m | Limit dBuV/m | Margin dB | Detector | Comment |
|-----|--------------|----------------------------|-------------------------|---------------------------|-----------------|--------------|----------|---------|
| 1 | 4823.9700 | 39.42 | 5.11 | 44.53 | 74.00 | -29.47 | Peak | |
| 2 * | 4824.0000 | 29.10 | 5.11 | 34.21 | 54.00 | -19.79 | AVG | |

| | |
|-------------------|-------------------|
| Orthogonal Axis : | X |
| Test Mode : | TX B MODE 2412MHz |

Horizontal

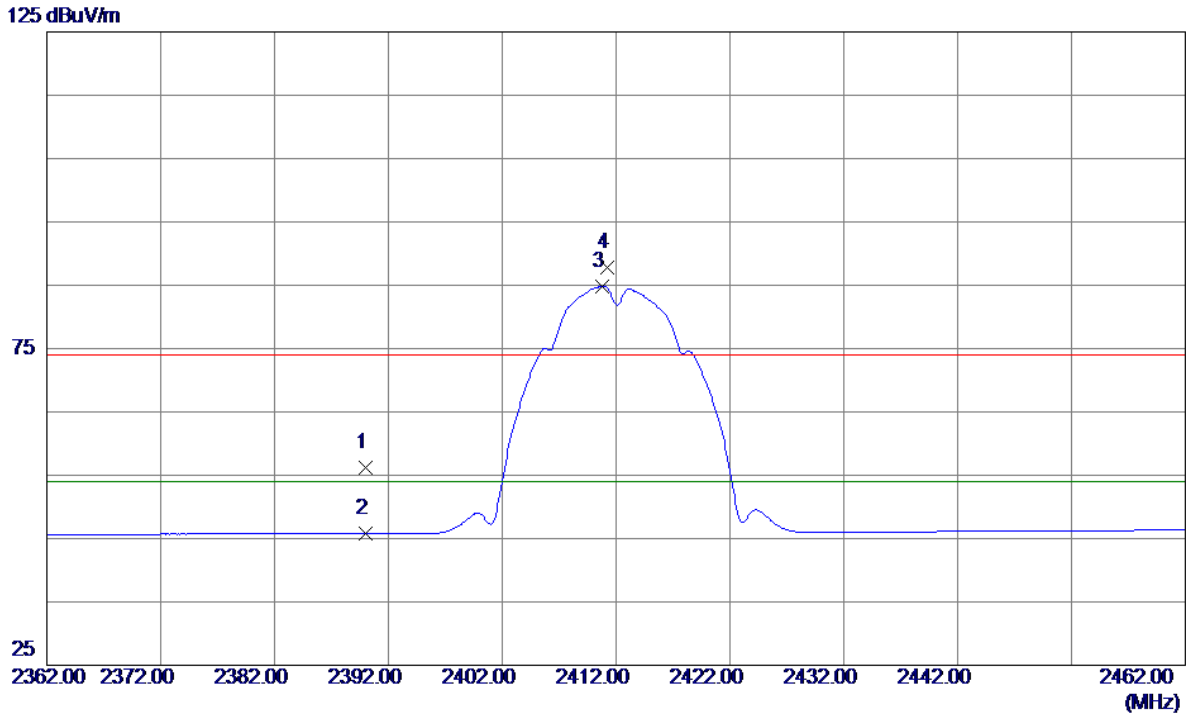

| No. | Freq. MHz | Reading Level dBuV/m | Correct Factor dB | Measure ment dBuV/m | Limit dBuV/m | Margin dB | Detector | Comment |
|-----|--------------|----------------------------|-------------------------|---------------------------|-----------------|--------------|----------|----------|
| 1 | 2390.0000 | 22.30 | 33.88 | 56.18 | 74.00 | -17.82 | Peak | |
| 2 | 2390.0000 | 11.89 | 33.88 | 45.77 | 54.00 | -8.23 | AVG | |
| 3 * | 2410.8000 | 50.88 | 34.00 | 84.88 | 54.00 | 30.88 | AVG | No Limit |
| 4 | 2411.2000 | 53.82 | 34.00 | 87.82 | 74.00 | 13.82 | Peak | No Limit |

| | |
|-------------------|-------------------|
| Orthogonal Axis : | X |
| Test Mode : | TX B MODE 2412MHz |

Horizontal

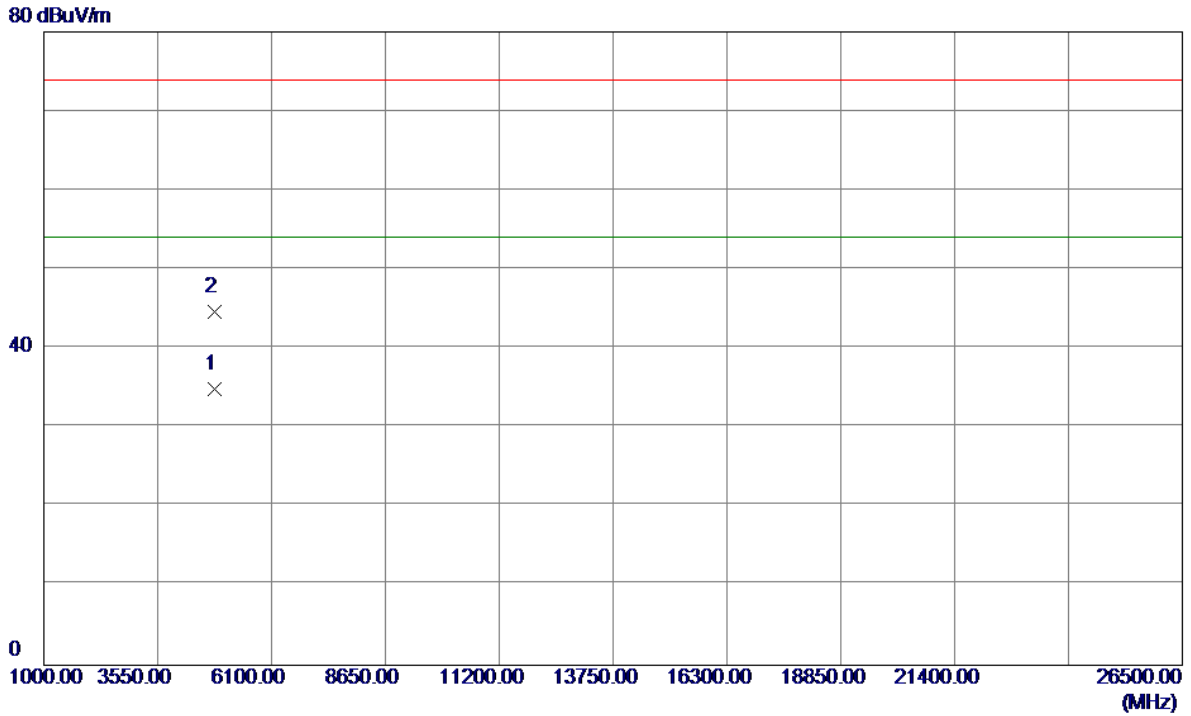

| No. | Freq. MHz | Reading Level dBuV/m | Correct Factor dB | Measure ment dBuV/m | Limit dBuV/m | Margin dB | Detector | Comment |
|-----|--------------|----------------------------|-------------------------|---------------------------|-----------------|--------------|----------|---------|
| 1 * | 4824.0000 | 29.73 | 5.11 | 34.84 | 54.00 | -19.16 | AVG | |
| 2 | 4824.1600 | 39.52 | 5.11 | 44.63 | 74.00 | -29.37 | Peak | |

| | |
|-------------------|-------------------|
| Orthogonal Axis : | X |
| Test Mode : | TX B MODE 2437MHz |

Vertical

125 dBuV/m

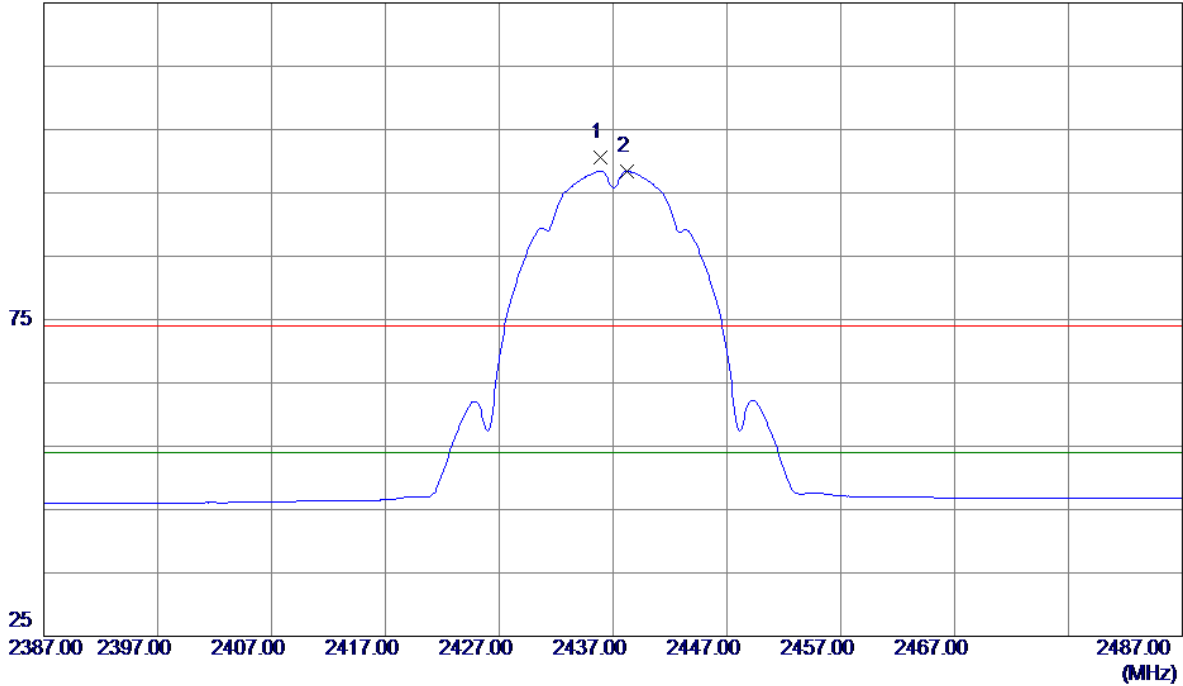

| No. | Freq. MHz | Reading Level dBuV/m | Correct Factor dB | Measure ment dBuV/m | Limit dBuV/m | Margin dB | Detector | Comment |
|-----|--------------|----------------------------|-------------------------|---------------------------|-----------------|--------------|----------|----------|
| 1 | 2435.9000 | 66.49 | 34.14 | 100.63 | 74.00 | 26.63 | Peak | No Limit |
| 2 * | 2438.2000 | 64.34 | 34.15 | 98.49 | 54.00 | 44.49 | AVG | No Limit |

| | |
|-------------------|-------------------|
| Orthogonal Axis : | X |
| Test Mode : | TX B MODE 2437MHz |

Vertical

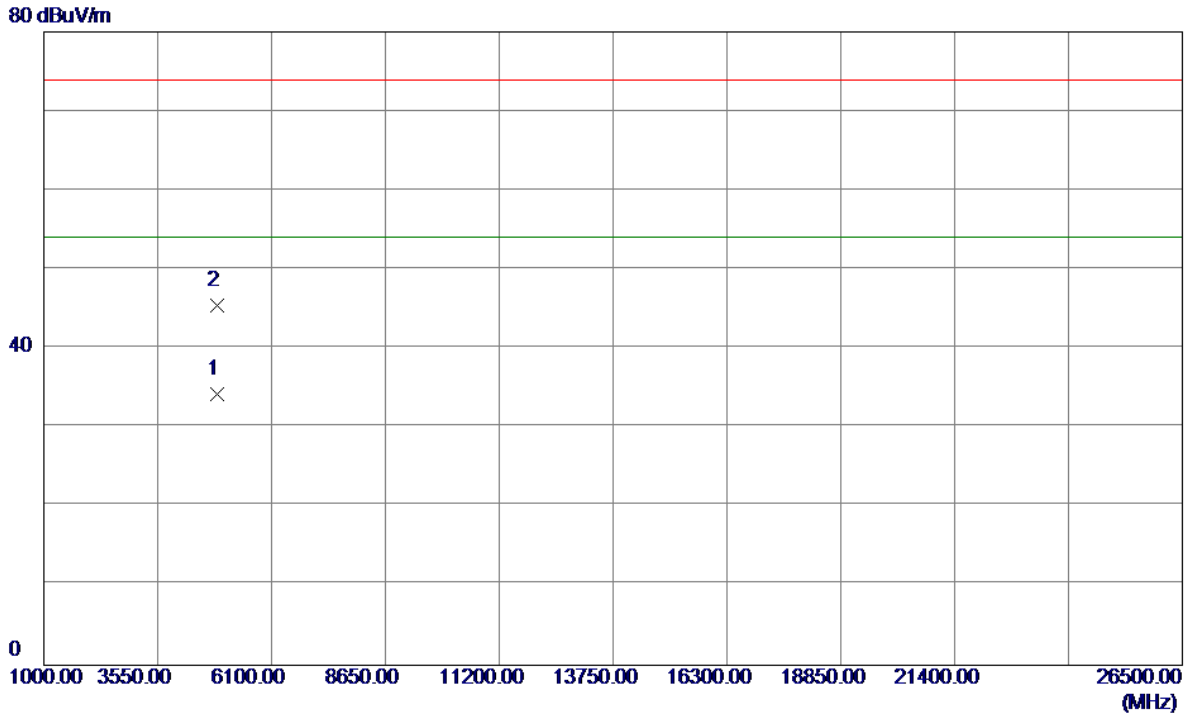

| No. | Freq. MHz | Reading Level dBuV/m | Correct Factor dB | Measure ment dBuV/m | Limit dBuV/m | Margin dB | Detector | Comment |
|-----|--------------|----------------------------|-------------------------|---------------------------|-----------------|--------------|----------|---------|
| 1 * | 4874.0700 | 28.86 | 5.31 | 34.17 | 54.00 | -19.83 | AVG | |
| 2 | 4874.0800 | 40.10 | 5.31 | 45.41 | 74.00 | -28.59 | Peak | |

| | |
|-------------------|-------------------|
| Orthogonal Axis : | X |
| Test Mode : | TX B MODE 2437MHz |

Horizontal

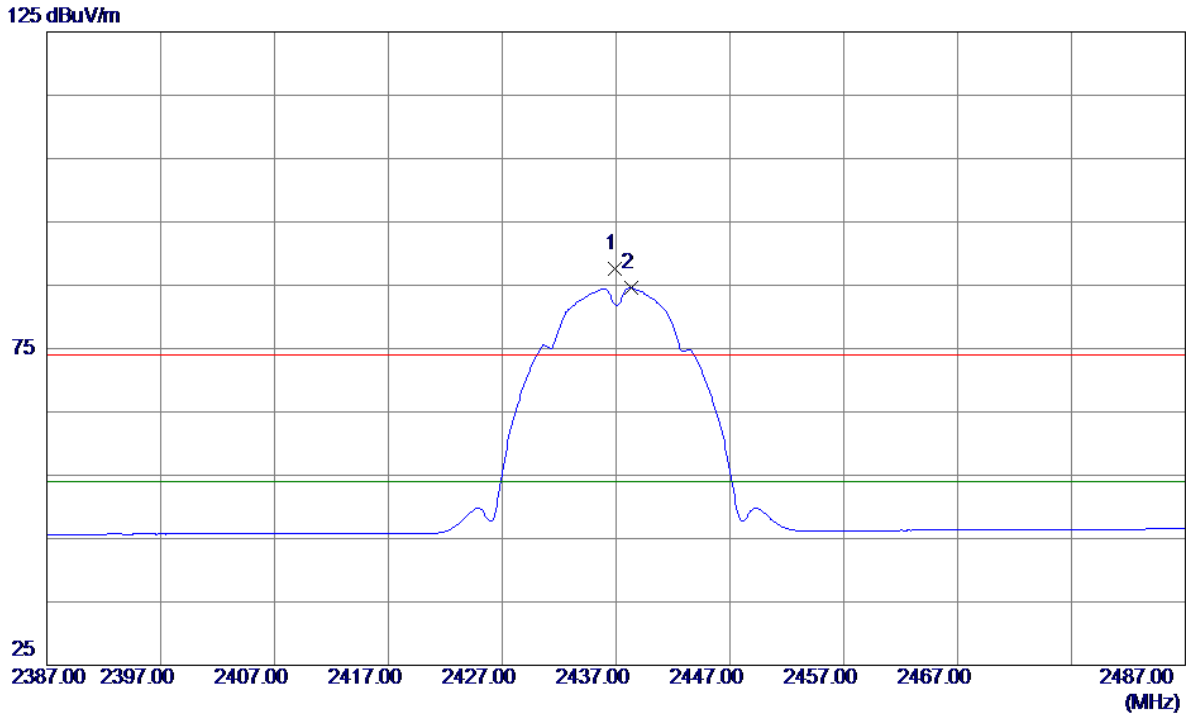

| No. | Freq. MHz | Reading Level dBuV/m | Correct Factor dB | Measure ment dBuV/m | Limit dBuV/m | Margin dB | Detector | Comment |
|-----|--------------|----------------------------|-------------------------|---------------------------|-----------------|--------------|----------|----------|
| 1 | 2436.9000 | 53.37 | 34.15 | 87.52 | 74.00 | 13.52 | Peak | No Limit |
| 2 * | 2438.3000 | 50.41 | 34.15 | 84.56 | 54.00 | 30.56 | AVG | No Limit |

| | |
|-------------------|-------------------|
| Orthogonal Axis : | X |
| Test Mode : | TX B MODE 2437MHz |

Horizontal

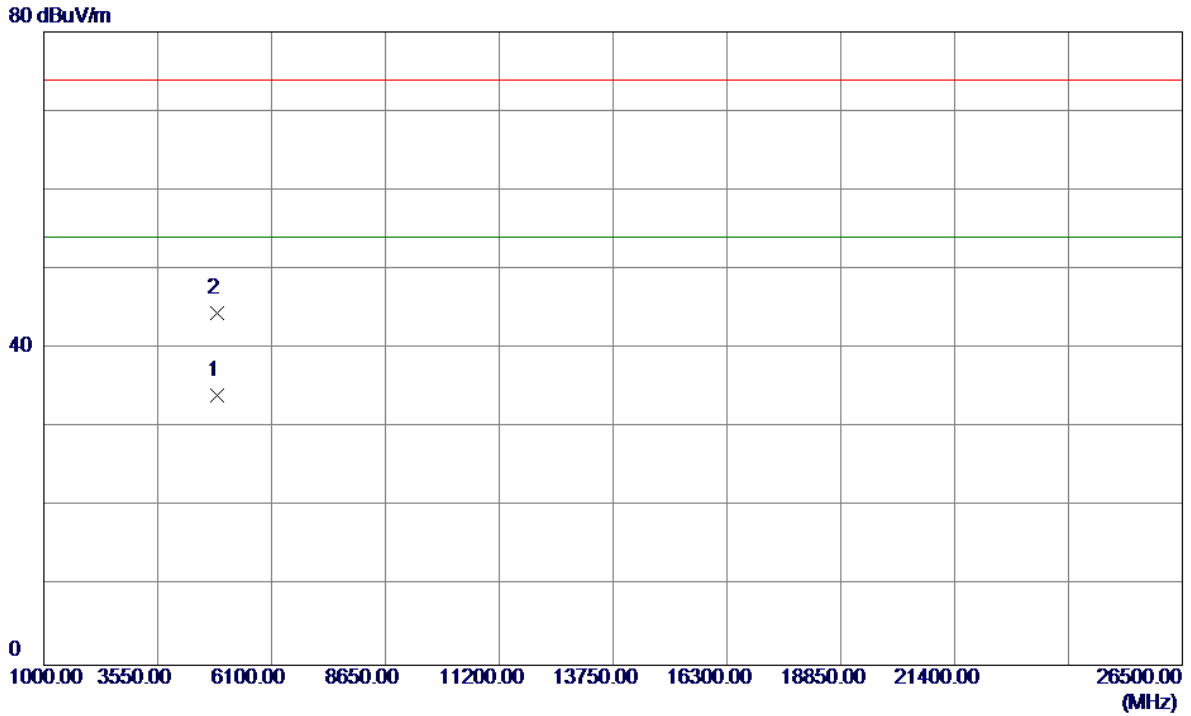

| No. | Freq. MHz | Reading Level dBuV/m | Correct Factor dB | Measure ment dBuV/m | Limit dBuV/m | Margin dB | Detector | Comment |
|-----|--------------|----------------------------|-------------------------|---------------------------|-----------------|--------------|----------|---------|
| 1 * | 4874.0099 | 28.80 | 5.31 | 34.11 | 54.00 | -19.89 | AVG | |
| 2 | 4874.0400 | 39.21 | 5.31 | 44.52 | 74.00 | -29.48 | Peak | |

| | |
|-------------------|-------------------|
| Orthogonal Axis : | X |
| Test Mode : | TX B MODE 2462MHz |

Vertical

125 dBuV/m

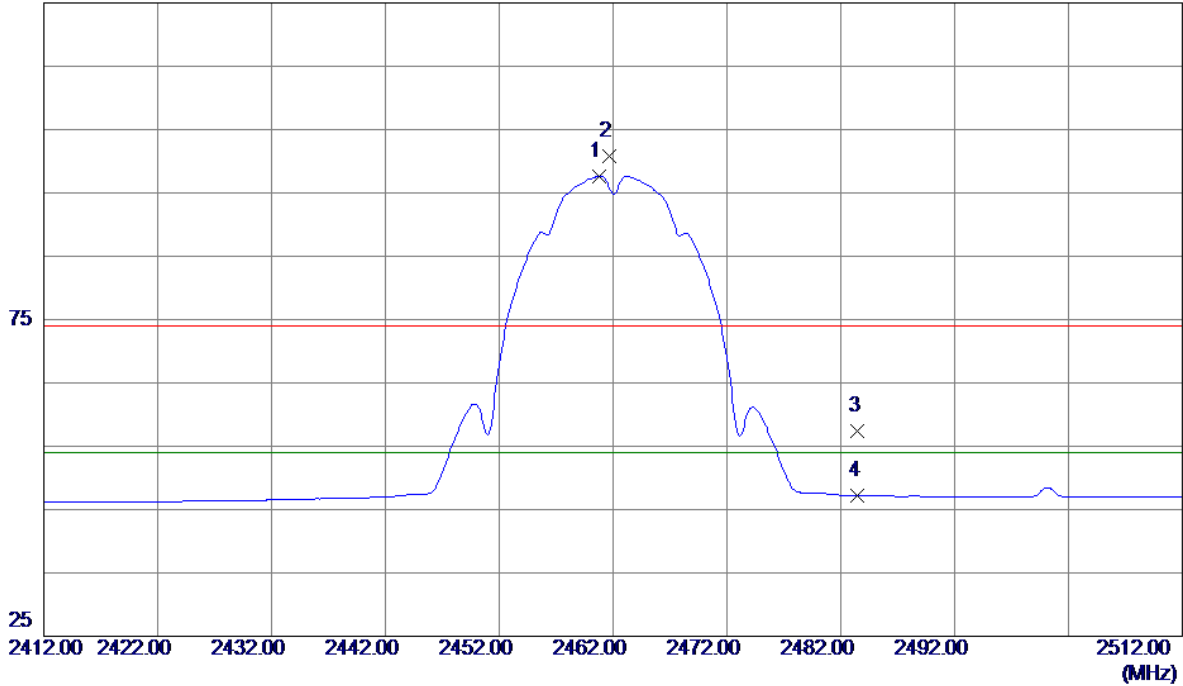

| No. | Freq. MHz | Reading Level dBuV/m | Correct Factor dB | Measure ment dBuV/m | Limit dBuV/m | Margin dB | Detector | Comment |
|-----|--------------|----------------------------|-------------------------|---------------------------|-----------------|--------------|----------|----------|
| 1 * | 2460.8000 | 63.40 | 34.28 | 97.68 | 54.00 | 43.68 | AVG | No Limit |
| 2 | 2461.7000 | 66.49 | 34.29 | 100.78 | 74.00 | 26.78 | Peak | No Limit |
| 3 | 2483.5000 | 23.04 | 34.41 | 57.45 | 74.00 | -16.55 | Peak | |
| 4 | 2483.5000 | 12.77 | 34.41 | 47.18 | 54.00 | -6.82 | AVG | |

| | |
|-------------------|-------------------|
| Orthogonal Axis : | X |
| Test Mode : | TX B MODE 2462MHz |

Vertical

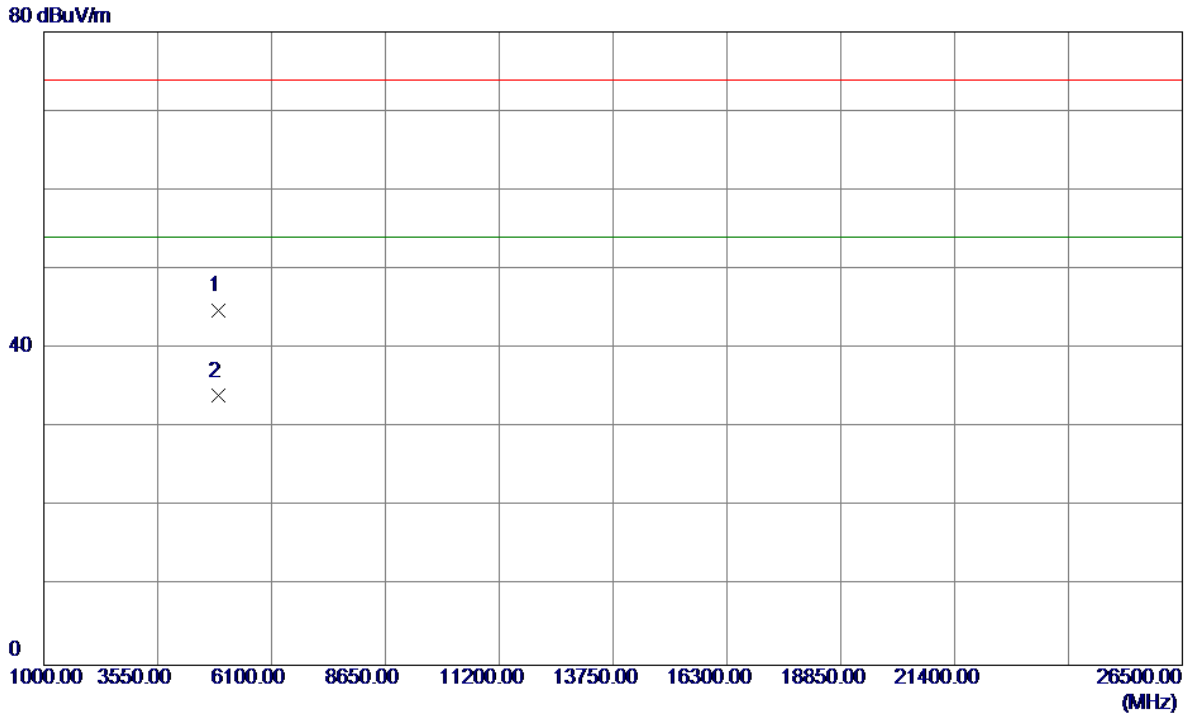

| No. | Freq. MHz | Reading Level dBuV/m | Correct Factor dB | Measure ment dBuV/m | Limit dBuV/m | Margin dB | Detector | Comment |
|-----|--------------|----------------------------|-------------------------|---------------------------|-----------------|--------------|----------|---------|
| 1 | 4923.9700 | 39.29 | 5.51 | 44.80 | 74.00 | -29.20 | Peak | |
| 2 * | 4924.0500 | 28.49 | 5.51 | 34.00 | 54.00 | -20.00 | AVG | |

| | |
|-------------------|-------------------|
| Orthogonal Axis : | X |
| Test Mode : | TX B MODE 2462MHz |

Horizontal

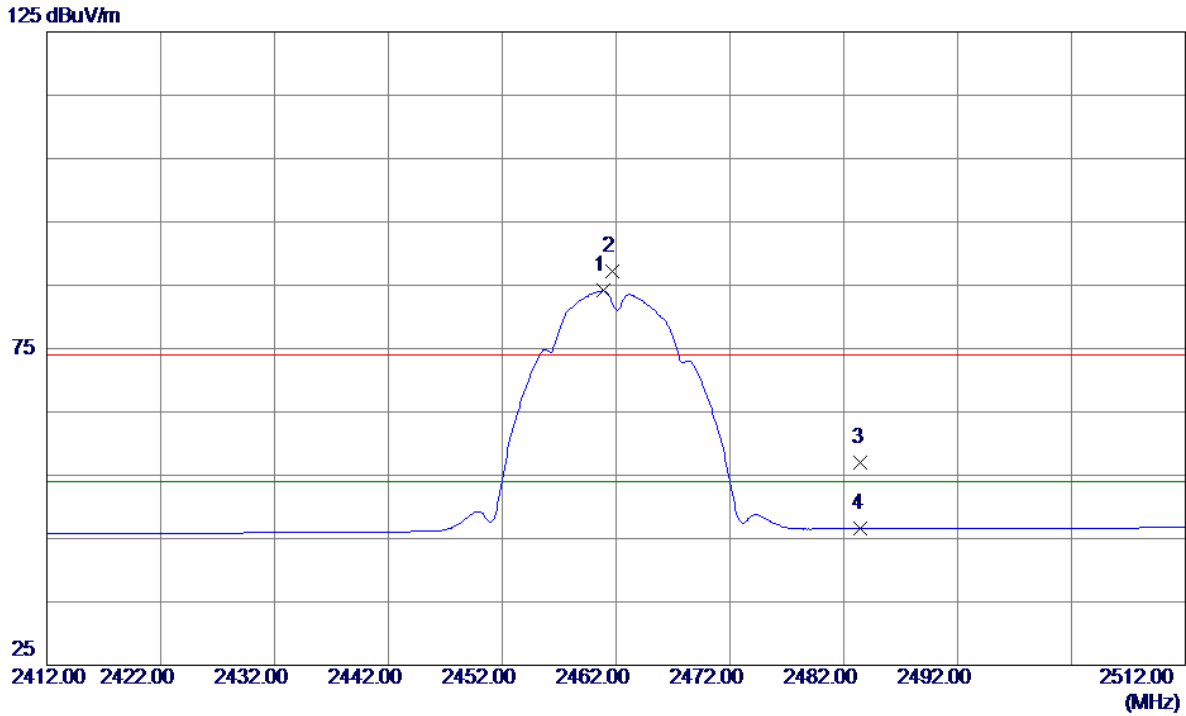

| No. | Freq. MHz | Reading Level dBuV/m | Correct Factor dB | Measure ment dBuV/m | Limit dBuV/m | Margin dB | Detector | Comment |
|-----|--------------|----------------------------|-------------------------|---------------------------|-----------------|--------------|----------|----------|
| 1 * | 2460.9000 | 49.84 | 34.28 | 84.12 | 54.00 | 30.12 | AVG | No Limit |
| 2 | 2461.7000 | 52.93 | 34.29 | 87.22 | 74.00 | 13.22 | Peak | No Limit |
| 3 | 2483.5000 | 22.61 | 34.41 | 57.02 | 74.00 | -16.98 | Peak | |
| 4 | 2483.5000 | 12.12 | 34.41 | 46.53 | 54.00 | -7.47 | AVG | |

| | |
|-------------------|-------------------|
| Orthogonal Axis : | X |
| Test Mode : | TX B MODE 2462MHz |

Horizontal

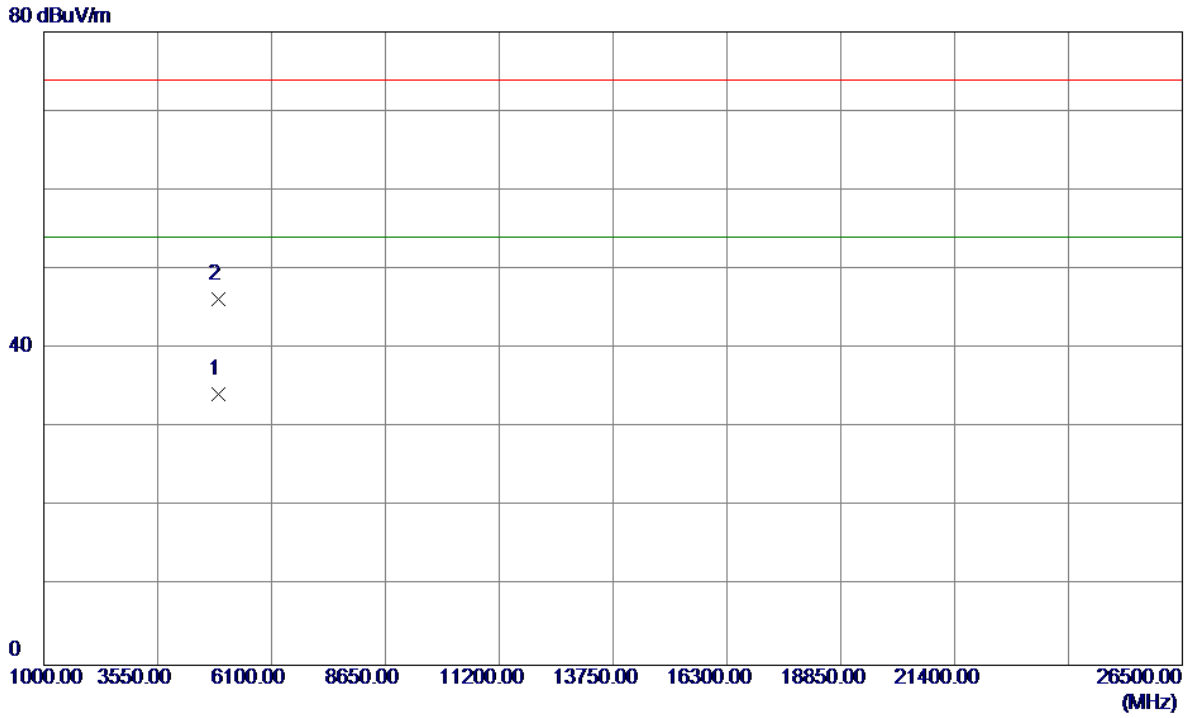

| No. | Freq. MHz | Reading Level dBuV/m | Correct Factor dB | Measure ment dBuV/m | Limit dBuV/m | Margin dB | Detector | Comment |
|-----|--------------|----------------------------|-------------------------|---------------------------|-----------------|--------------|----------|---------|
| 1 * | 4923.9200 | 28.79 | 5.51 | 34.30 | 54.00 | -19.70 | AVG | |
| 2 | 4923.9800 | 40.69 | 5.51 | 46.20 | 74.00 | -27.80 | Peak | |

| | |
|-------------------|-------------------|
| Orthogonal Axis : | X |
| Test Mode : | TX G MODE 2412MHz |

Vertical

125 dBuV/m

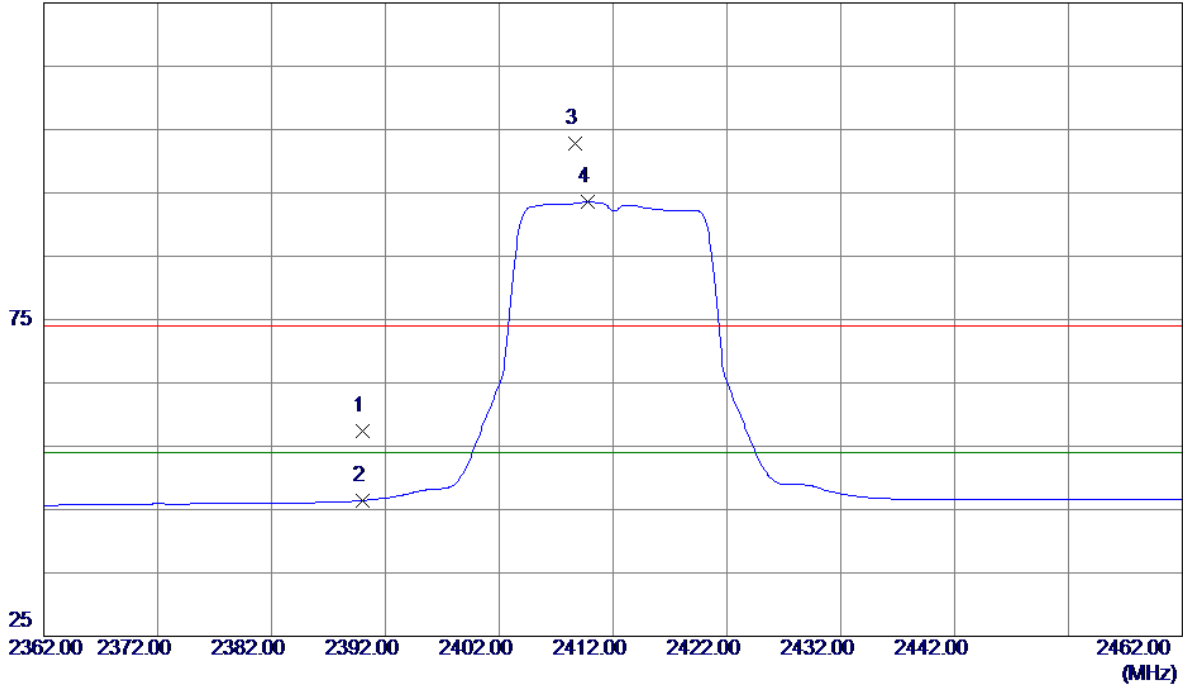

| No. | Freq. MHz | Reading Level dBuV/m | Correct Factor dB | Measure ment dBuV/m | Limit dBuV/m | Margin dB | Detector | Comment |
|-----|--------------|----------------------------|-------------------------|---------------------------|-----------------|--------------|----------|----------|
| 1 | 2390.0000 | 23.56 | 33.88 | 57.44 | 74.00 | -16.56 | Peak | |
| 2 | 2390.0000 | 12.56 | 33.88 | 46.44 | 54.00 | -7.56 | AVG | |
| 3 | 2408.7000 | 68.89 | 33.98 | 102.87 | 74.00 | 28.87 | Peak | No Limit |
| 4 * | 2409.8000 | 59.58 | 33.99 | 93.57 | 54.00 | 39.57 | AVG | No Limit |

| | |
|-------------------|-------------------|
| Orthogonal Axis : | X |
| Test Mode : | TX G MODE 2412MHz |

Vertical

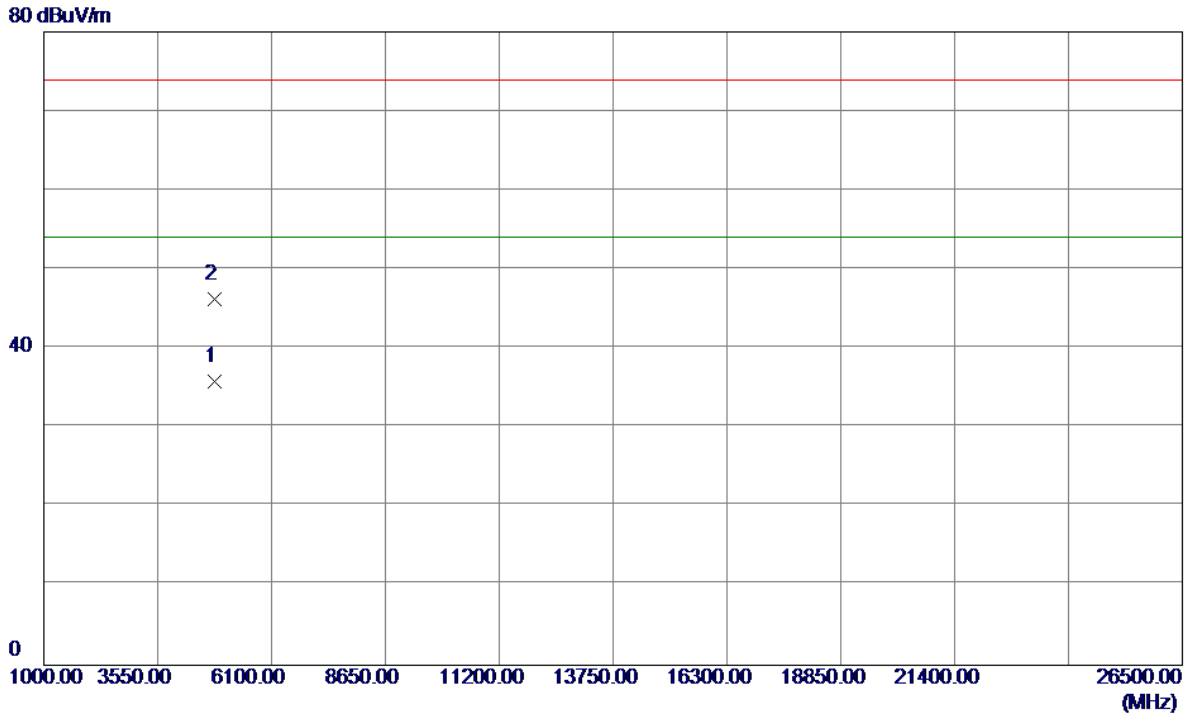

| No. | Freq. MHz | Reading Level dBuV/m | Correct Factor dB | Measure ment dBuV/m | Limit dBuV/m | Margin dB | Detector | Comment |
|-----|--------------|----------------------------|-------------------------|---------------------------|-----------------|--------------|----------|---------|
| 1 * | 4824.0000 | 30.66 | 5.11 | 35.77 | 54.00 | -18.23 | AVG | |
| 2 | 4824.1000 | 41.18 | 5.11 | 46.29 | 74.00 | -27.71 | Peak | |

| | |
|-------------------|-------------------|
| Orthogonal Axis : | X |
| Test Mode : | TX G MODE 2412MHz |

Horizontal

125 dBuV/m

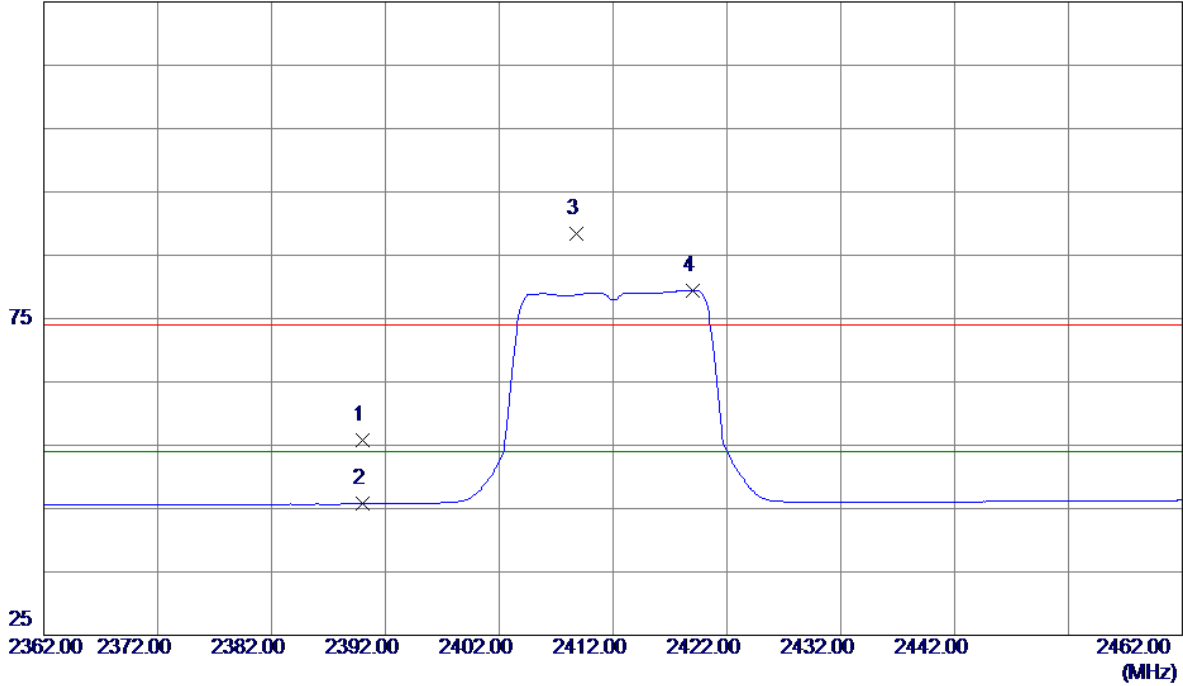

| No. | Freq. MHz | Reading Level dBuV/m | Correct Factor dB | Measure ment dBuV/m | Limit dBuV/m | Margin dB | Detector | Comment |
|-----|--------------|----------------------------|-------------------------|---------------------------|-----------------|--------------|----------|----------|
| 1 | 2390.0000 | 21.91 | 33.88 | 55.79 | 74.00 | -18.21 | Peak | |
| 2 | 2390.0000 | 11.83 | 33.88 | 45.71 | 54.00 | -8.29 | AVG | |
| 3 | 2408.8000 | 54.45 | 33.98 | 88.43 | 74.00 | 14.43 | Peak | No Limit |
| 4 * | 2419.0000 | 45.45 | 34.04 | 79.49 | 54.00 | 25.49 | AVG | No Limit |

| | |
|-------------------|-------------------|
| Orthogonal Axis : | X |
| Test Mode : | TX G MODE 2412MHz |

Horizontal

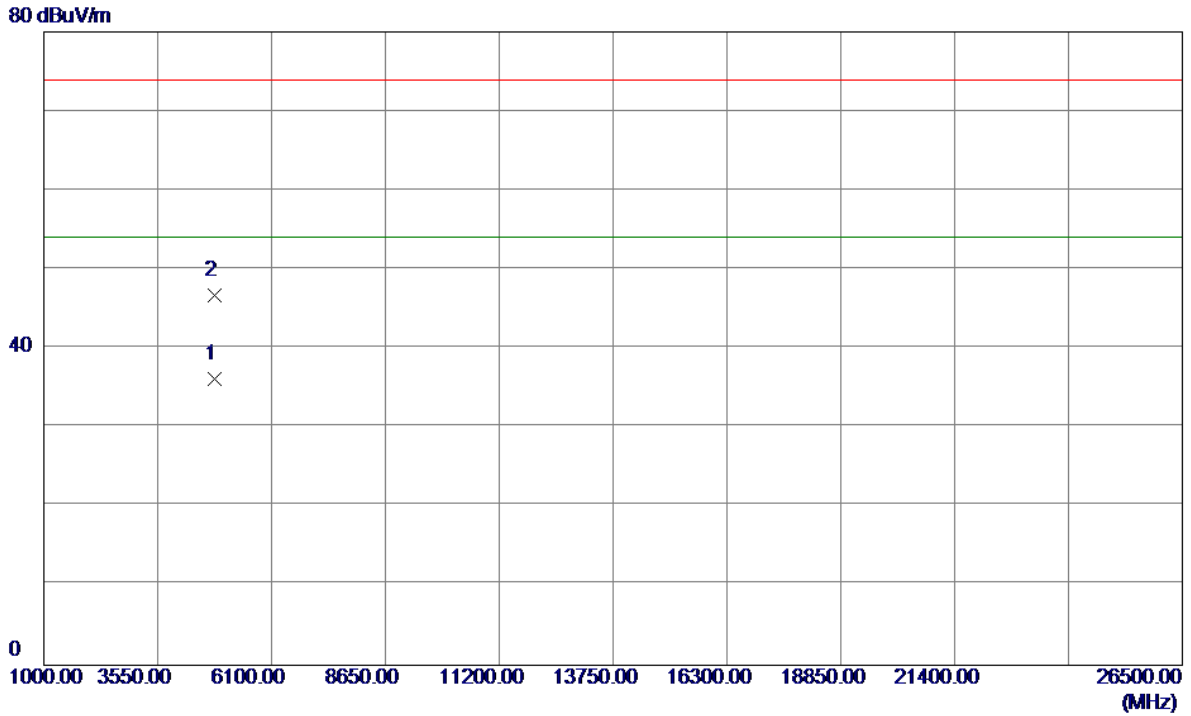

| No. | Freq. MHz | Reading Level dBuV/m | Correct Factor dB | Measure ment dBuV/m | Limit dBuV/m | Margin dB | Detector | Comment |
|-----|--------------|----------------------------|-------------------------|---------------------------|-----------------|--------------|----------|---------|
| 1 * | 4823.9900 | 31.04 | 5.11 | 36.15 | 54.00 | -17.85 | AVG | |
| 2 | 4824.1700 | 41.63 | 5.11 | 46.74 | 74.00 | -27.26 | Peak | |

| | |
|-------------------|-------------------|
| Orthogonal Axis : | X |
| Test Mode : | TX G MODE 2437MHz |

Vertical

125 dBuV/m

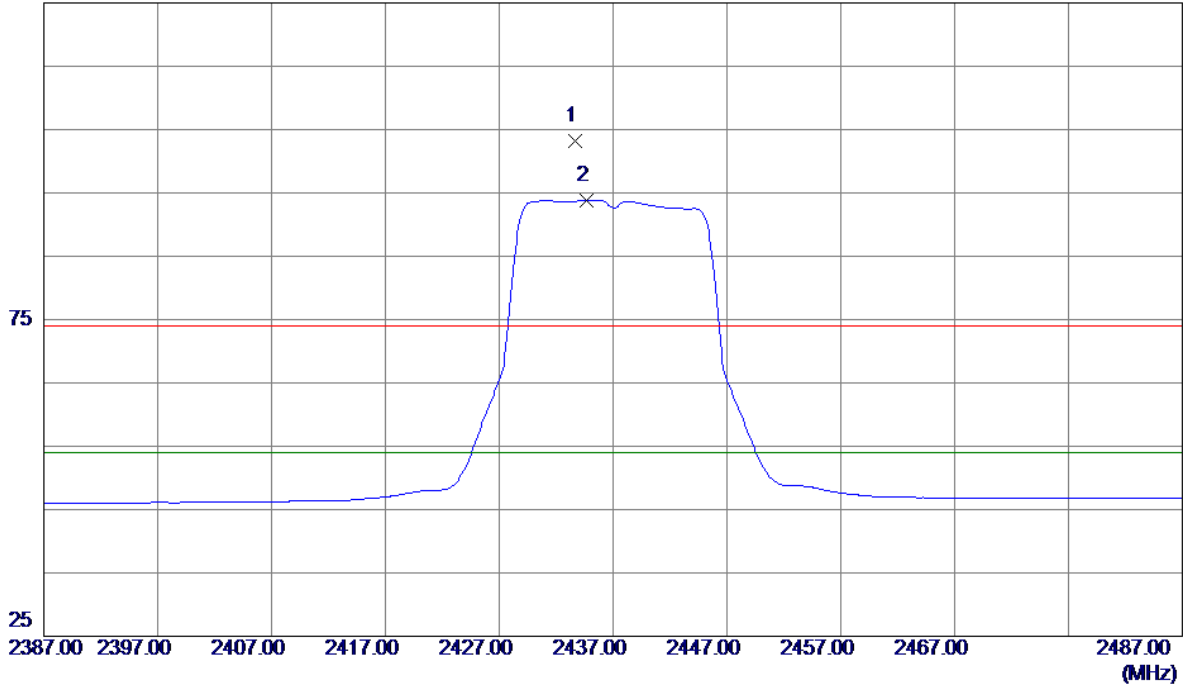

| No. | Freq. MHz | Reading Level dBuV/m | Correct Factor dB | Measure ment dBuV/m | Limit dBuV/m | Margin dB | Detector | Comment |
|-----|--------------|----------------------------|-------------------------|---------------------------|-----------------|--------------|----------|----------|
| 1 | 2433.7000 | 69.09 | 34.13 | 103.22 | 74.00 | 29.22 | Peak | No Limit |
| 2 * | 2434.7000 | 59.71 | 34.13 | 93.84 | 54.00 | 39.84 | AVG | No Limit |

| | |
|-------------------|-------------------|
| Orthogonal Axis : | X |
| Test Mode : | TX G MODE 2437MHz |

Vertical

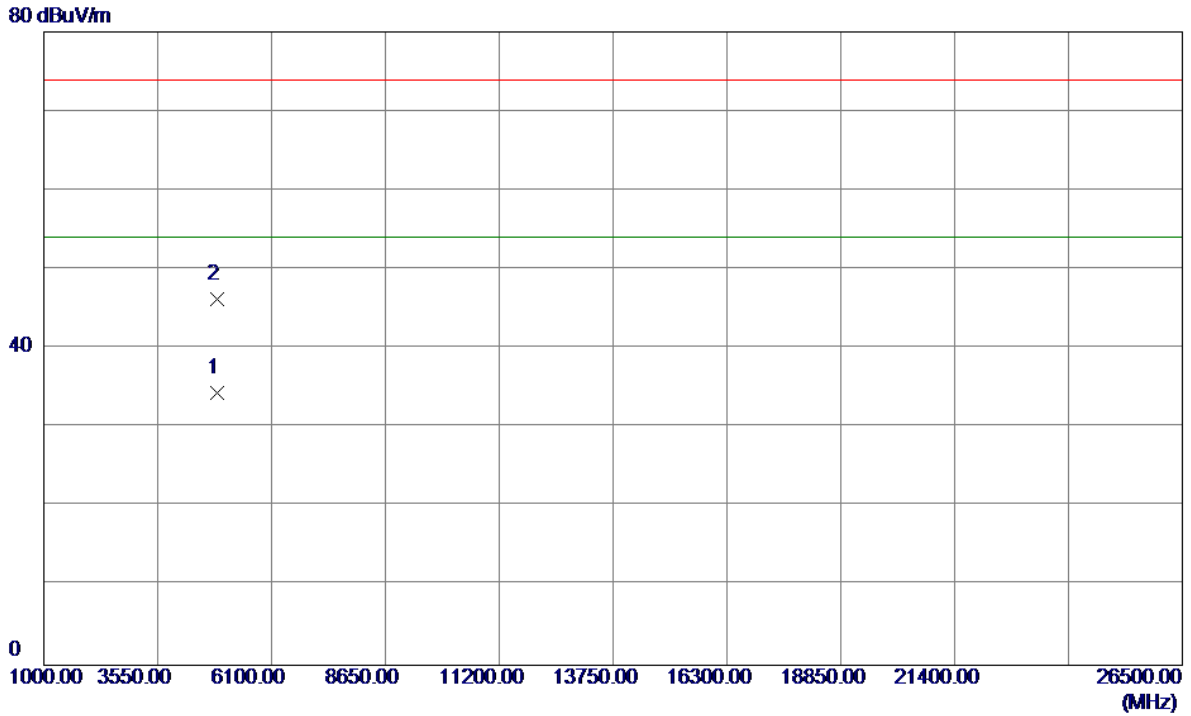

| No. | Freq. MHz | Reading Level dBuV/m | Correct Factor dB | Measure ment dBuV/m | Limit dBuV/m | Margin dB | Detector | Comment |
|-----|--------------|----------------------------|-------------------------|---------------------------|-----------------|--------------|----------|---------|
| 1 * | 4873.9900 | 29.16 | 5.31 | 34.47 | 54.00 | -19.53 | AVG | |
| 2 | 4874.1000 | 40.92 | 5.31 | 46.23 | 74.00 | -27.77 | Peak | |

| | |
|-------------------|-------------------|
| Orthogonal Axis : | X |
| Test Mode : | TX G MODE 2437MHz |

Horizontal

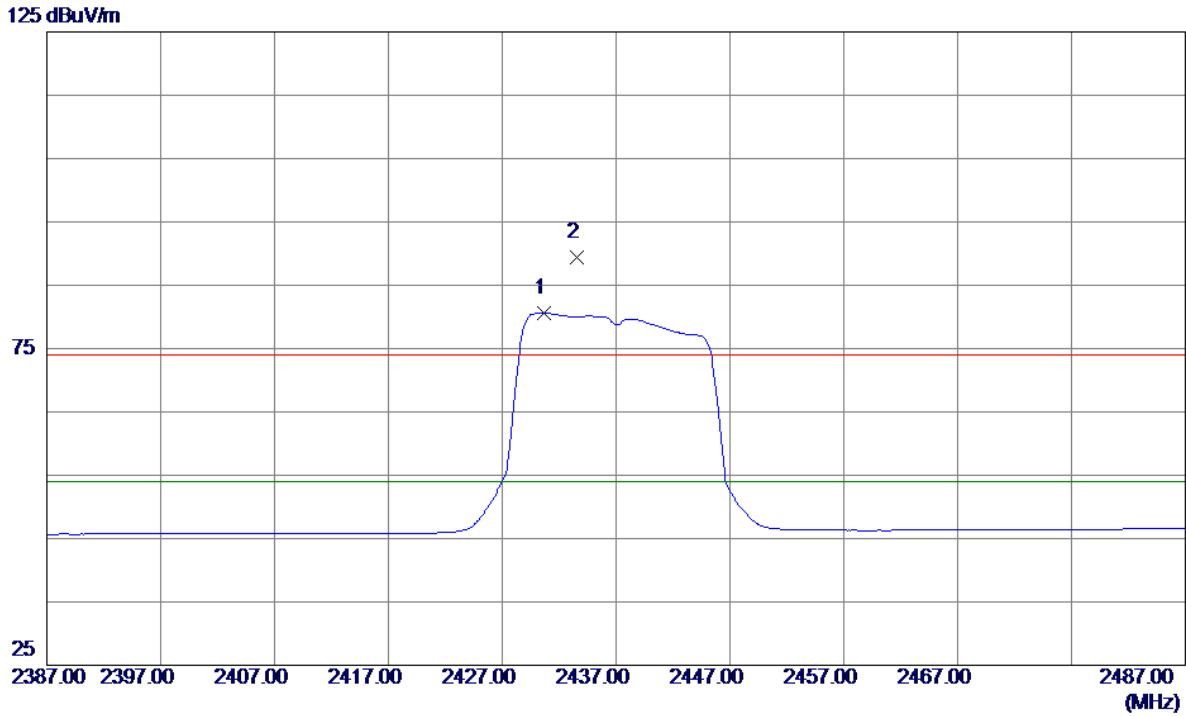

| No. | Freq. MHz | Reading Level dBuV/m | Correct Factor dB | Measure ment dBuV/m | Limit dBuV/m | Margin dB | Detector | Comment |
|-----|--------------|----------------------------|-------------------------|---------------------------|-----------------|--------------|----------|----------|
| 1 * | 2430.7000 | 46.46 | 34.11 | 80.57 | 54.00 | 26.57 | AVG | No Limit |
| 2 | 2433.6000 | 55.26 | 34.13 | 89.39 | 74.00 | 15.39 | Peak | No Limit |

| | |
|-------------------|-------------------|
| Orthogonal Axis : | X |
| Test Mode : | TX G MODE 2437MHz |

Horizontal

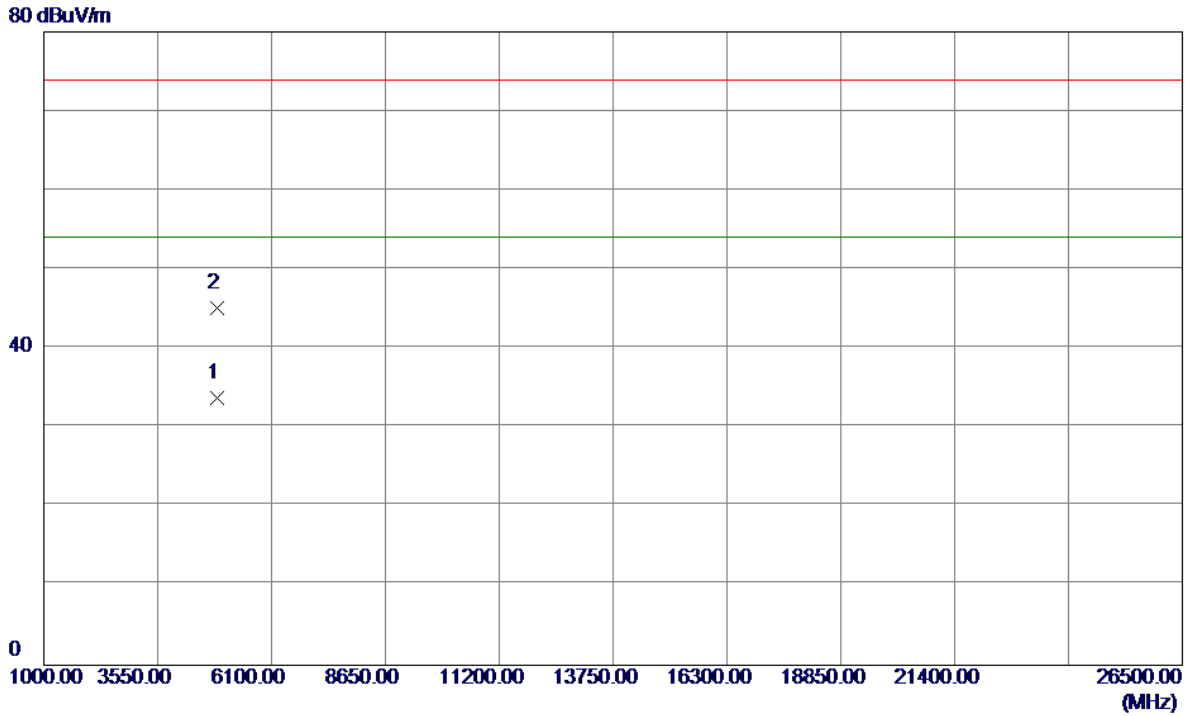

| No. | Freq. MHz | Reading Level dBuV/m | Correct Factor dB | Measure ment dBuV/m | Limit dBuV/m | Margin dB | Detector | Comment |
|-----|--------------|----------------------------|-------------------------|---------------------------|-----------------|--------------|----------|---------|
| 1 * | 4875.1900 | 28.50 | 5.32 | 33.82 | 54.00 | -20.18 | AVG | |
| 2 | 4875.5000 | 39.73 | 5.32 | 45.05 | 74.00 | -28.95 | Peak | |

| | |
|-------------------|-------------------|
| Orthogonal Axis : | X |
| Test Mode : | TX G MODE 2462MHz |

Vertical

125 dBuV/m

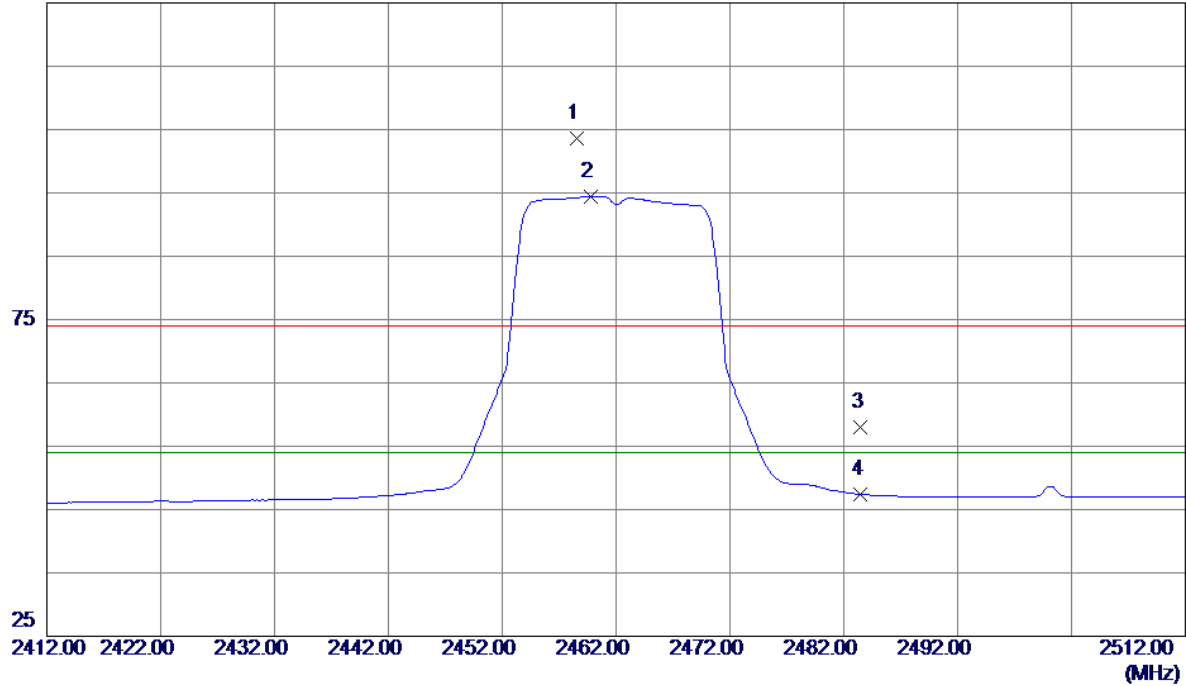

| No. | Freq. MHz | Reading Level dBuV/m | Correct Factor dB | Measure ment dBuV/m | Limit dBuV/m | Margin dB | Detector | Comment |
|-----|--------------|----------------------------|-------------------------|---------------------------|-----------------|--------------|----------|----------|
| 1 | 2458.6000 | 69.41 | 34.27 | 103.68 | 74.00 | 29.68 | Peak | No Limit |
| 2 * | 2459.8000 | 60.21 | 34.28 | 94.49 | 54.00 | 40.49 | AVG | No Limit |
| 3 | 2483.5000 | 23.53 | 34.41 | 57.94 | 74.00 | -16.06 | Peak | |
| 4 | 2483.5000 | 12.98 | 34.41 | 47.39 | 54.00 | -6.61 | AVG | |

| | |
|-------------------|-------------------|
| Orthogonal Axis : | X |
| Test Mode : | TX G MODE 2462MHz |

Vertical

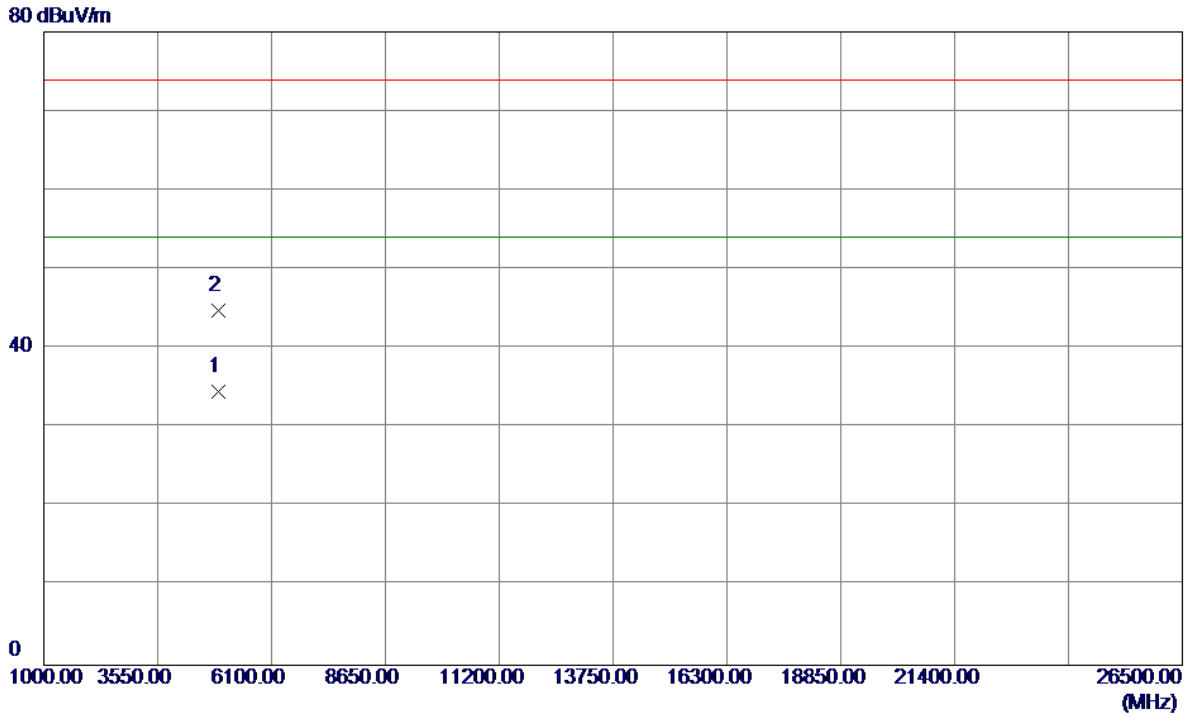

| No. | Freq. MHz | Reading Level dBuV/m | Correct Factor dB | Measure ment dBuV/m | Limit dBuV/m | Margin dB | Detector | Comment |
|-----|--------------|----------------------------|-------------------------|---------------------------|-----------------|--------------|----------|---------|
| 1 * | 4923.9700 | 28.99 | 5.51 | 34.50 | 54.00 | -19.50 | AVG | |
| 2 | 4924.0200 | 39.29 | 5.51 | 44.80 | 74.00 | -29.20 | Peak | |

| | |
|-------------------|-------------------|
| Orthogonal Axis : | X |
| Test Mode : | TX G MODE 2462MHz |

Horizontal

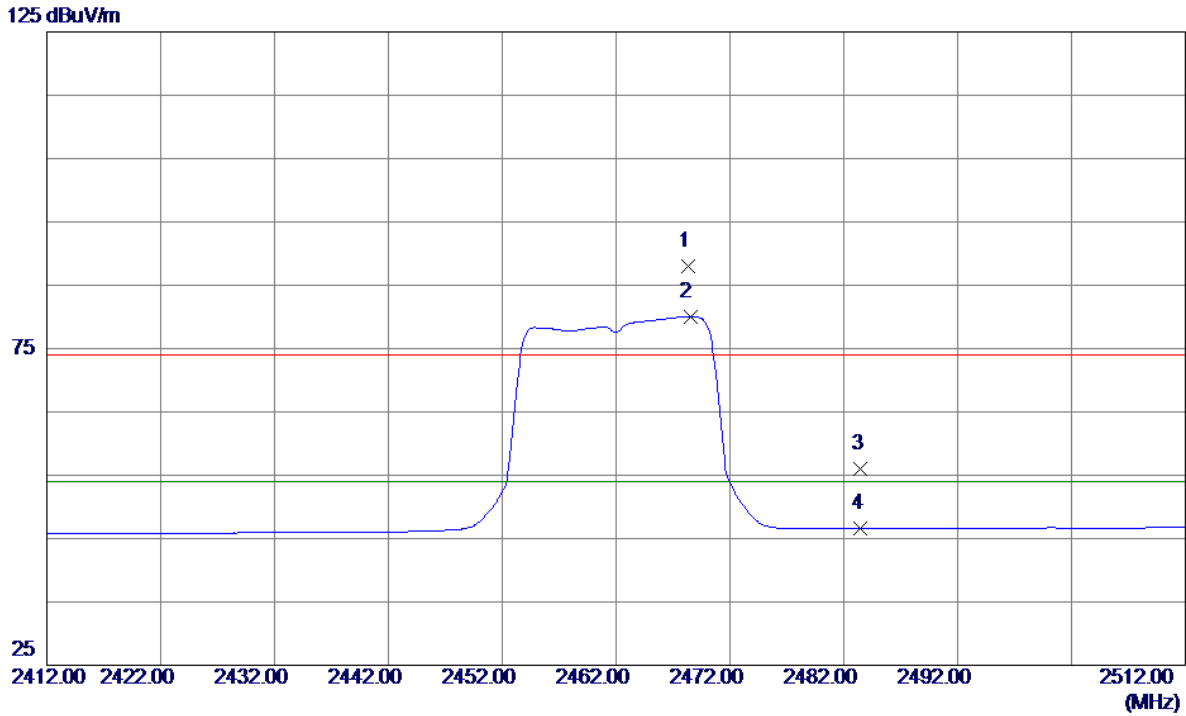

| No. | Freq. MHz | Reading Level dBuV/m | Correct Factor dB | Measure ment dBuV/m | Limit dBuV/m | Margin dB | Detector | Comment |
|-----|--------------|----------------------------|-------------------------|---------------------------|-----------------|--------------|----------|----------|
| 1 | 2468.3000 | 53.60 | 34.33 | 87.93 | 74.00 | 13.93 | Peak | No Limit |
| 2 * | 2468.5000 | 45.68 | 34.33 | 80.01 | 54.00 | 26.01 | AVG | No Limit |
| 3 | 2483.5000 | 21.51 | 34.41 | 55.92 | 74.00 | -18.08 | Peak | |
| 4 | 2483.5000 | 12.13 | 34.41 | 46.54 | 54.00 | -7.46 | AVG | |

| | |
|-------------------|-------------------|
| Orthogonal Axis : | X |
| Test Mode : | TX G MODE 2462MHz |

Horizontal

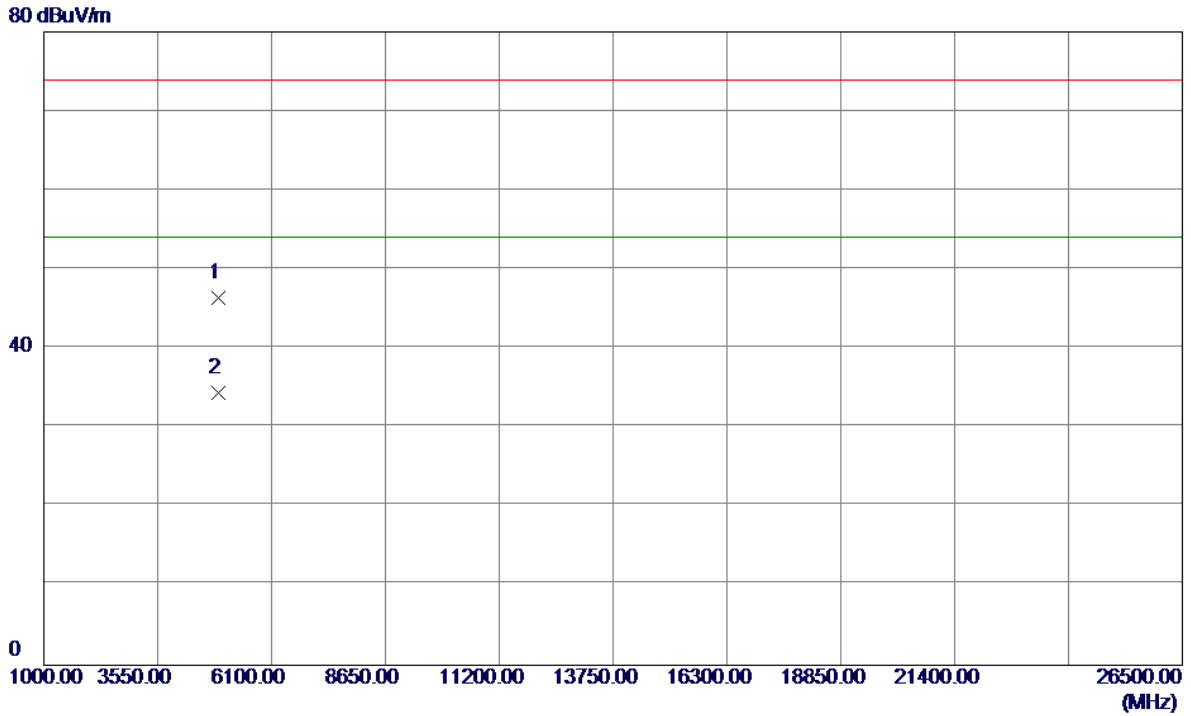

| No. | Freq. MHz | Reading Level dBuV/m | Correct Factor dB | Measure ment dBuV/m | Limit dBuV/m | Margin dB | Detector | Comment |
|-----|--------------|----------------------------|-------------------------|---------------------------|-----------------|--------------|----------|---------|
| 1 | 4923.7200 | 40.95 | 5.51 | 46.46 | 74.00 | -27.54 | Peak | |
| 2 * | 4923.9400 | 28.87 | 5.51 | 34.38 | 54.00 | -19.62 | AVG | |

| | |
|-------------------|-----------------------|
| Orthogonal Axis : | X |
| Test Mode : | TX N-20M MODE 2412MHz |

Vertical

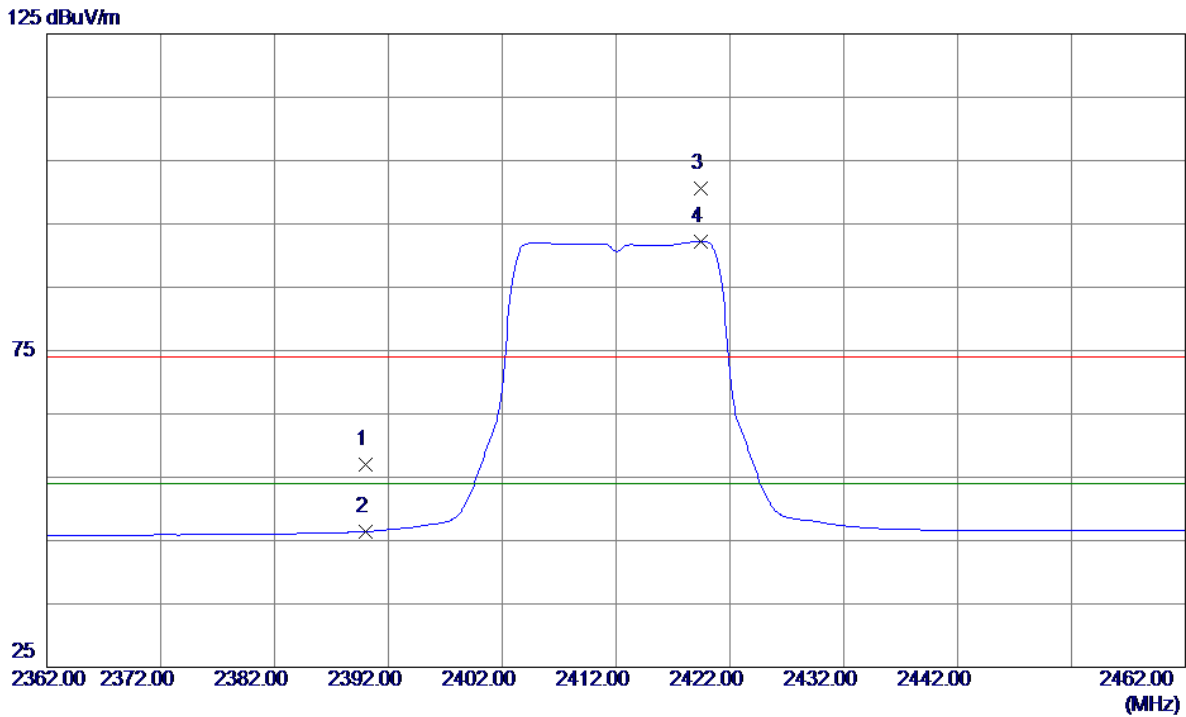

| No. | Freq. MHz | Reading Level dBuV/m | Correct Factor dB | Measure ment dBuV/m | Limit dBuV/m | Margin dB | Detector | Comment |
|-----|--------------|----------------------------|-------------------------|---------------------------|-----------------|--------------|----------|----------|
| 1 | 2390.0000 | 23.17 | 33.88 | 57.05 | 74.00 | -16.95 | Peak | |
| 2 | 2390.0000 | 12.54 | 33.88 | 46.42 | 54.00 | -7.58 | AVG | |
| 3 | 2419.4000 | 66.52 | 34.05 | 100.57 | 74.00 | 26.57 | Peak | No Limit |
| 4 * | 2419.4000 | 58.16 | 34.05 | 92.21 | 54.00 | 38.21 | AVG | No Limit |

| | |
|-------------------|-----------------------|
| Orthogonal Axis : | X |
| Test Mode : | TX N-20M MODE 2412MHz |

Vertical

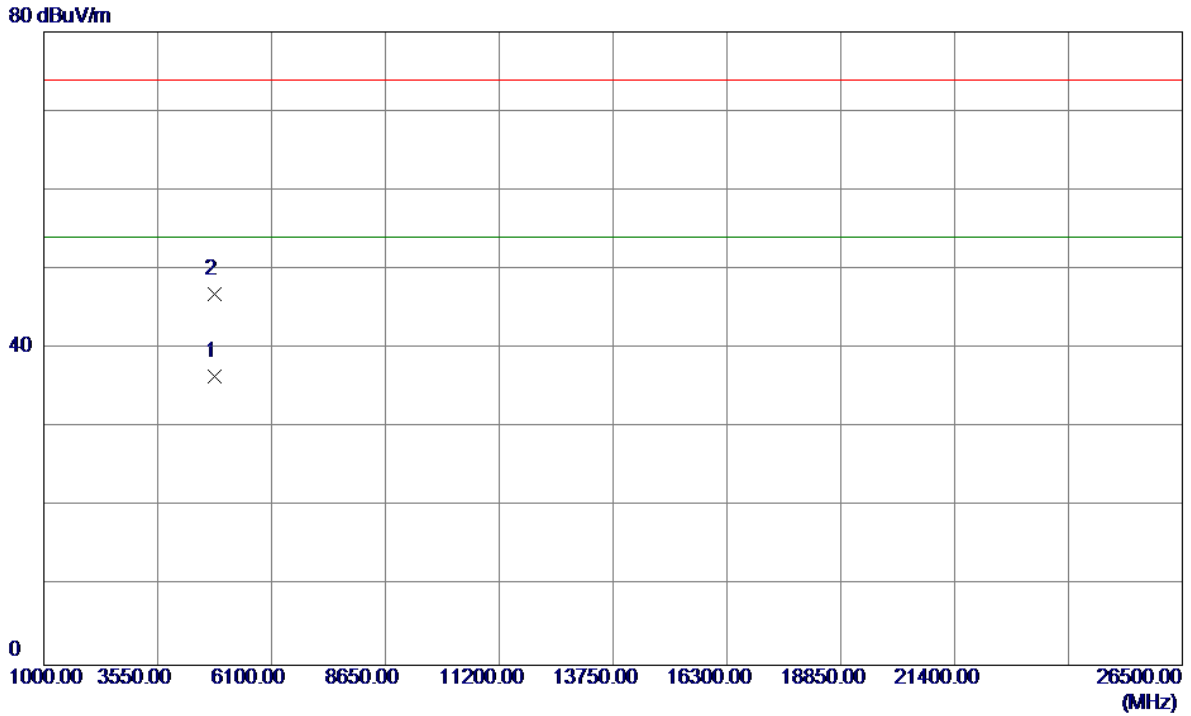

| No. | Freq. MHz | Reading Level dBuV/m | Correct Factor dB | Measure ment dBuV/m | Limit dBuV/m | Margin dB | Detector | Comment |
|-----|--------------|----------------------------|-------------------------|---------------------------|-----------------|--------------|----------|---------|
| 1 * | 4823.9700 | 31.34 | 5.11 | 36.45 | 54.00 | -17.55 | AVG | |
| 2 | 4824.0200 | 41.75 | 5.11 | 46.86 | 74.00 | -27.14 | Peak | |

| | |
|-------------------|-----------------------|
| Orthogonal Axis : | X |
| Test Mode : | TX N-20M MODE 2412MHz |

Horizontal

125 dBuV/m

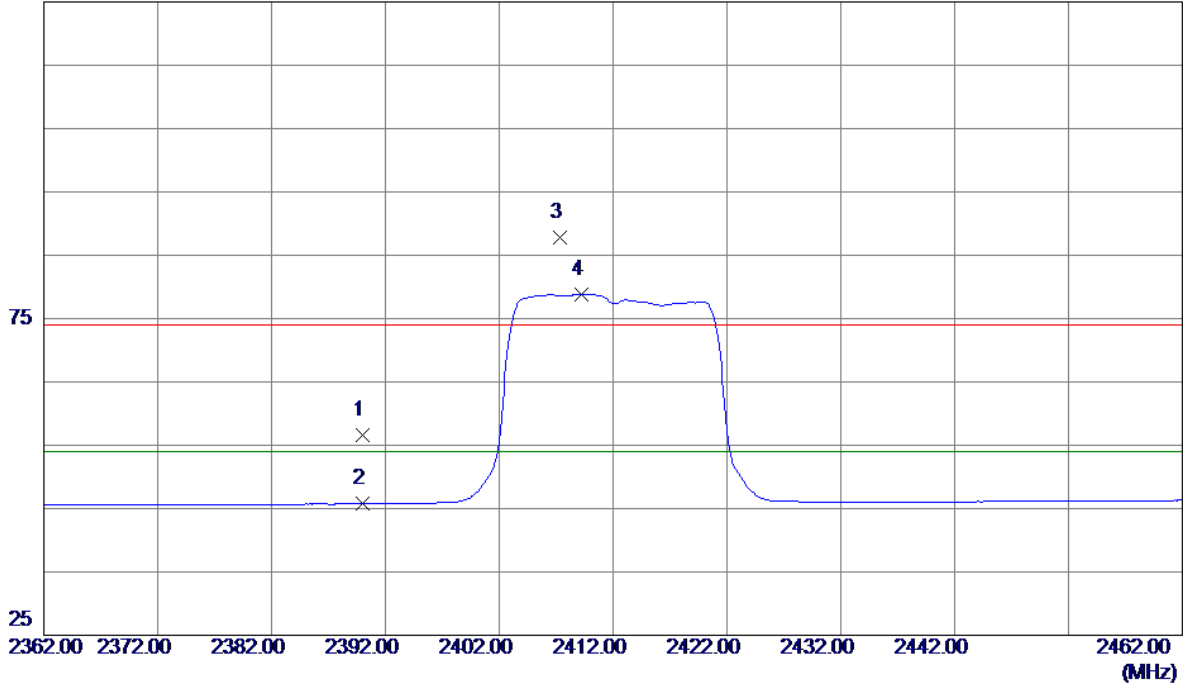

| No. | Freq. MHz | Reading Level dBuV/m | Correct Factor dB | Measure ment dBuV/m | Limit dBuV/m | Margin dB | Detector | Comment |
|-----|--------------|----------------------------|-------------------------|---------------------------|-----------------|--------------|----------|----------|
| 1 | 2390.0000 | 22.74 | 33.88 | 56.62 | 74.00 | -17.38 | Peak | |
| 2 | 2390.0000 | 11.84 | 33.88 | 45.72 | 54.00 | -8.28 | AVG | |
| 3 | 2407.3000 | 53.74 | 33.98 | 87.72 | 74.00 | 13.72 | Peak | No Limit |
| 4 * | 2409.2000 | 44.87 | 33.99 | 78.86 | 54.00 | 24.86 | AVG | No Limit |

| | |
|-------------------|-----------------------|
| Orthogonal Axis : | X |
| Test Mode : | TX N-20M MODE 2412MHz |

Horizontal

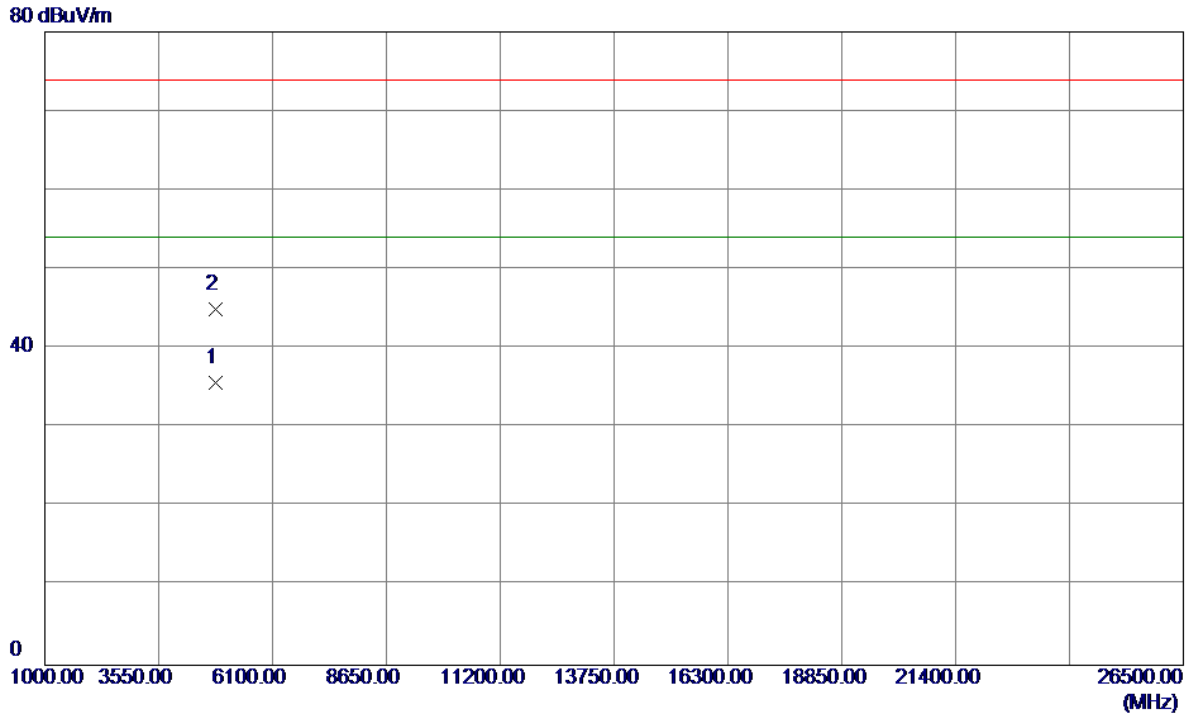

| No. | Freq. MHz | Reading Level dBuV/m | Correct Factor dB | Measure ment dBuV/m | Limit dBuV/m | Margin dB | Detector | Comment |
|-----|--------------|----------------------------|-------------------------|---------------------------|-----------------|--------------|----------|---------|
| 1 * | 4823.9800 | 30.58 | 5.11 | 35.69 | 54.00 | -18.31 | AVG | |
| 2 | 4824.0099 | 39.83 | 5.11 | 44.94 | 74.00 | -29.06 | Peak | |

| | |
|-------------------|-----------------------|
| Orthogonal Axis : | X |
| Test Mode : | TX N-20M MODE 2437MHz |

Vertical

125 dBuV/m

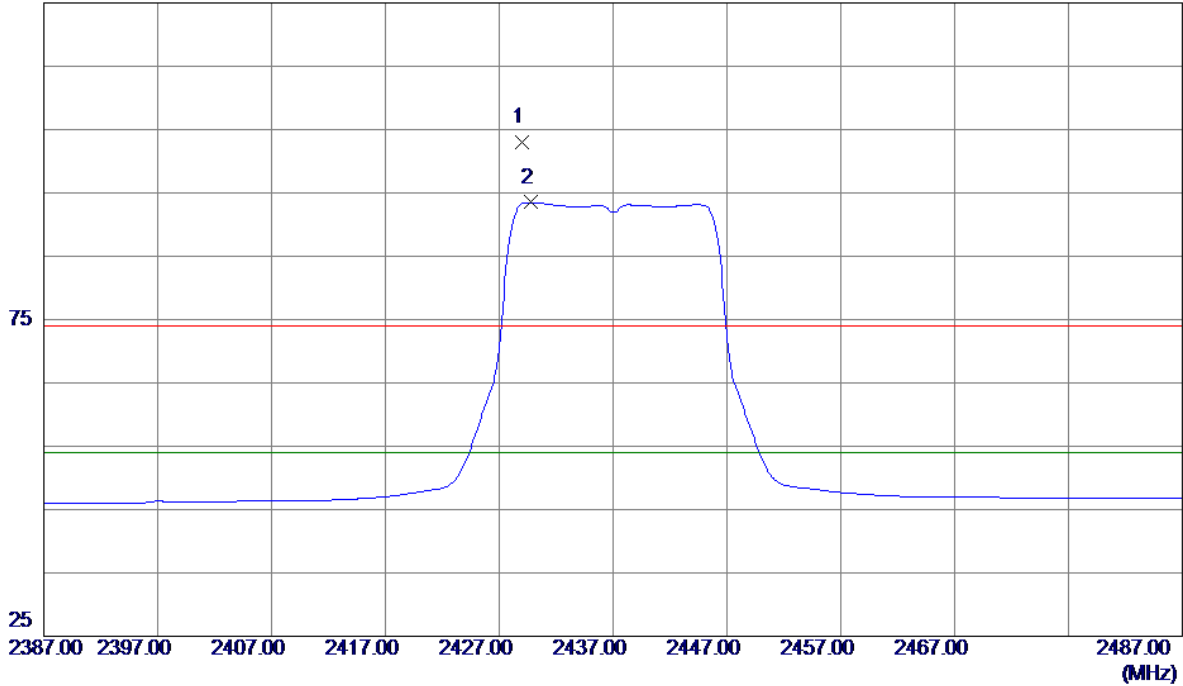

| No. | Freq. MHz | Reading Level dBuV/m | Correct Factor dB | Measure ment dBuV/m | Limit dBuV/m | Margin dB | Detector | Comment |
|-----|--------------|----------------------------|-------------------------|---------------------------|-----------------|--------------|----------|----------|
| 1 | 2429.0000 | 68.90 | 34.10 | 103.00 | 74.00 | 29.00 | Peak | No Limit |
| 2 * | 2429.8000 | 59.39 | 34.11 | 93.50 | 54.00 | 39.50 | AVG | No Limit |

| | |
|-------------------|-----------------------|
| Orthogonal Axis : | X |
| Test Mode : | TX N-20M MODE 2437MHz |

Vertical

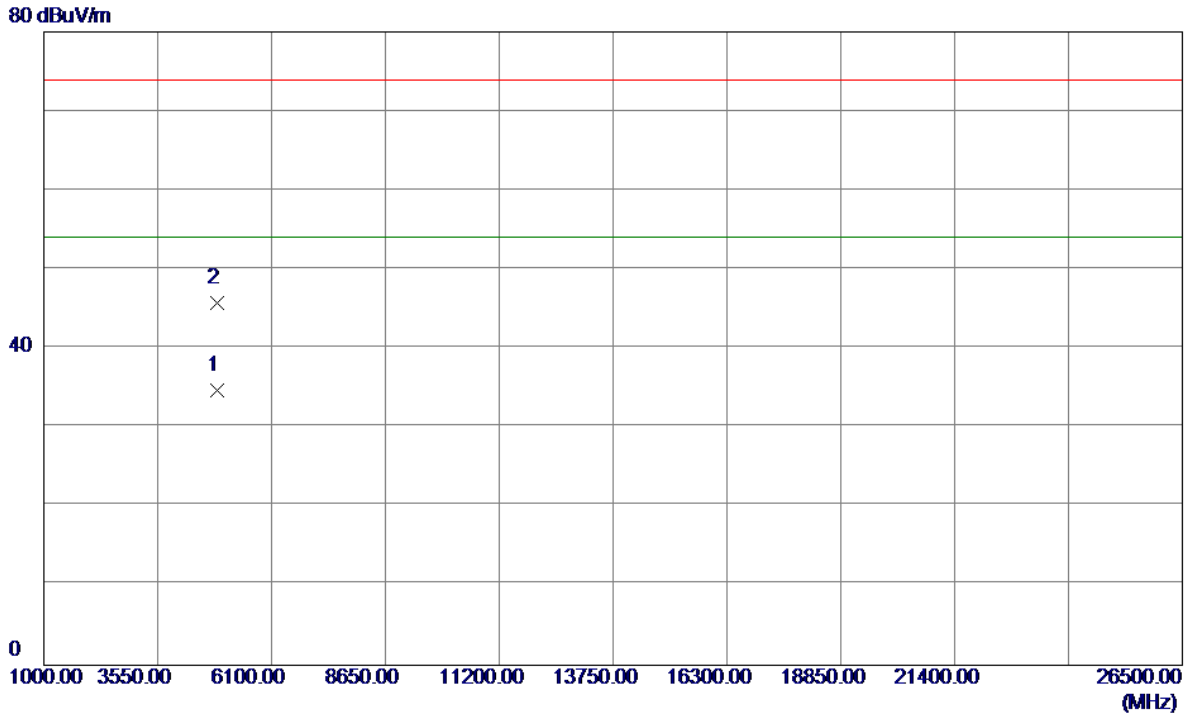

| No. | Freq. MHz | Reading Level dBuV/m | Correct Factor dB | Measure ment dBuV/m | Limit dBuV/m | Margin dB | Detector | Comment |
|-----|--------------|----------------------------|-------------------------|---------------------------|-----------------|--------------|----------|---------|
| 1 * | 4873.9800 | 29.36 | 5.31 | 34.67 | 54.00 | -19.33 | AVG | |
| 2 | 4874.0200 | 40.41 | 5.31 | 45.72 | 74.00 | -28.28 | Peak | |

| | |
|-------------------|-----------------------|
| Orthogonal Axis : | X |
| Test Mode : | TX N-20M MODE 2437MHz |

Horizontal

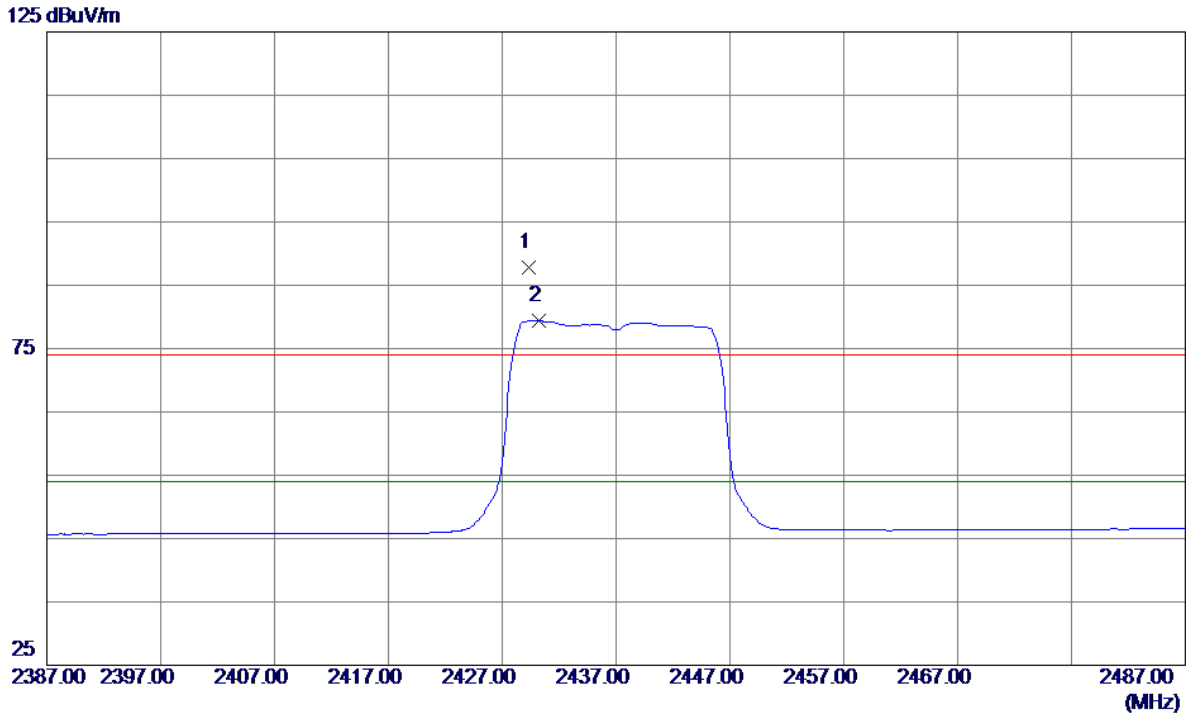

| No. | Freq. MHz | Reading Level dBuV/m | Correct Factor dB | Measure ment dBuV/m | Limit dBuV/m | Margin dB | Detector | Comment |
|-----|--------------|----------------------------|-------------------------|---------------------------|-----------------|--------------|----------|----------|
| 1 | 2429.3000 | 53.65 | 34.10 | 87.75 | 74.00 | 13.75 | Peak | No Limit |
| 2 * | 2430.2000 | 45.26 | 34.11 | 79.37 | 54.00 | 25.37 | AVG | No Limit |

| | |
|-------------------|-----------------------|
| Orthogonal Axis : | X |
| Test Mode : | TX N-20M MODE 2437MHz |

Horizontal

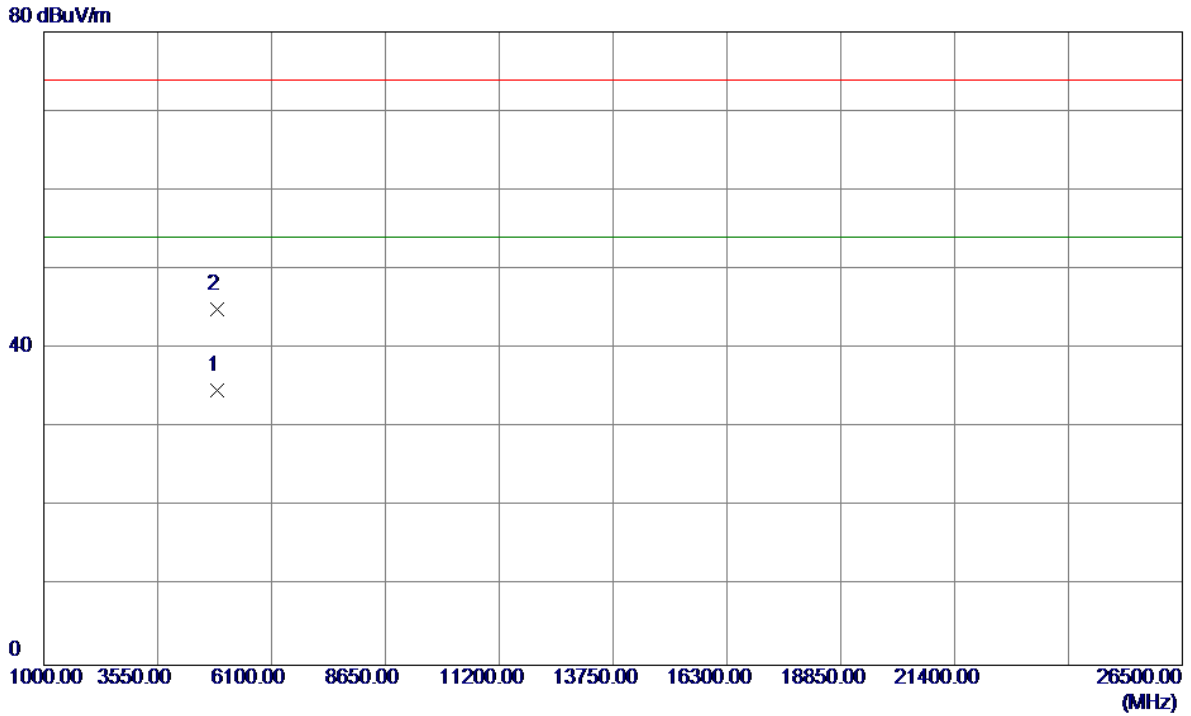

| No. | Freq. MHz | Reading Level dBuV/m | Correct Factor dB | Measure ment dBuV/m | Limit dBuV/m | Margin dB | Detector | Comment |
|-----|--------------|----------------------------|-------------------------|---------------------------|-----------------|--------------|----------|---------|
| 1 * | 4873.9800 | 29.45 | 5.31 | 34.76 | 54.00 | -19.24 | AVG | |
| 2 | 4874.1000 | 39.67 | 5.31 | 44.98 | 74.00 | -29.02 | Peak | |

| | |
|-------------------|-----------------------|
| Orthogonal Axis : | X |
| Test Mode : | TX N-20M MODE 2462MHz |

Vertical

125 dBuV/m

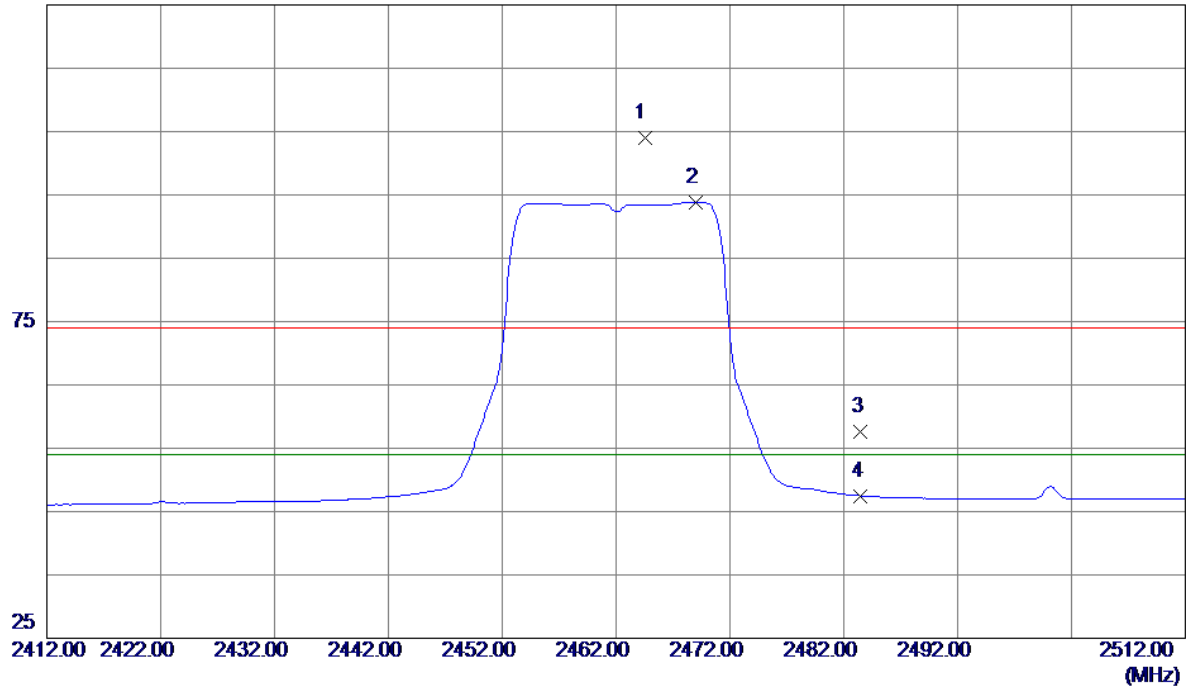

| No. | Freq. MHz | Reading Level dBuV/m | Correct Factor dB | Measure ment dBuV/m | Limit dBuV/m | Margin dB | Detector | Comment |
|-----|--------------|----------------------------|-------------------------|---------------------------|-----------------|--------------|----------|----------|
| 1 | 2464.5000 | 69.70 | 34.31 | 104.01 | 74.00 | 30.01 | Peak | No Limit |
| 2 * | 2469.0000 | 59.53 | 34.33 | 93.86 | 54.00 | 39.86 | AVG | No Limit |
| 3 | 2483.5000 | 23.26 | 34.41 | 57.67 | 74.00 | -16.33 | Peak | |
| 4 | 2483.5000 | 13.07 | 34.41 | 47.48 | 54.00 | -6.52 | AVG | |

| | |
|-------------------|-----------------------|
| Orthogonal Axis : | X |
| Test Mode : | TX N-20M MODE 2462MHz |

Vertical

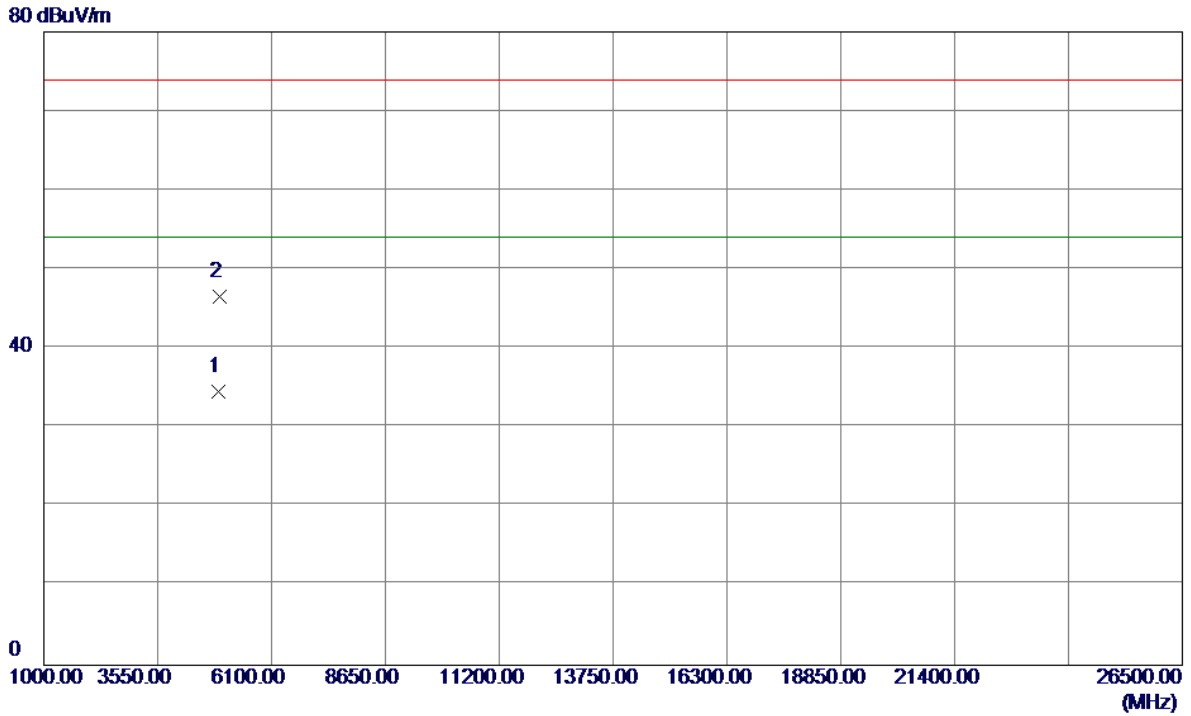

| No. | Freq. MHz | Reading Level dBuV/m | Correct Factor dB | Measure ment dBuV/m | Limit dBuV/m | Margin dB | Detector | Comment |
|-----|--------------|----------------------------|-------------------------|---------------------------|-----------------|--------------|----------|---------|
| 1 * | 4923.9500 | 29.01 | 5.51 | 34.52 | 54.00 | -19.48 | AVG | |
| 2 | 4924.2200 | 41.00 | 5.51 | 46.51 | 74.00 | -27.49 | Peak | |

| | |
|-------------------|-----------------------|
| Orthogonal Axis : | X |
| Test Mode : | TX N-20M MODE 2462MHz |

Horizontal

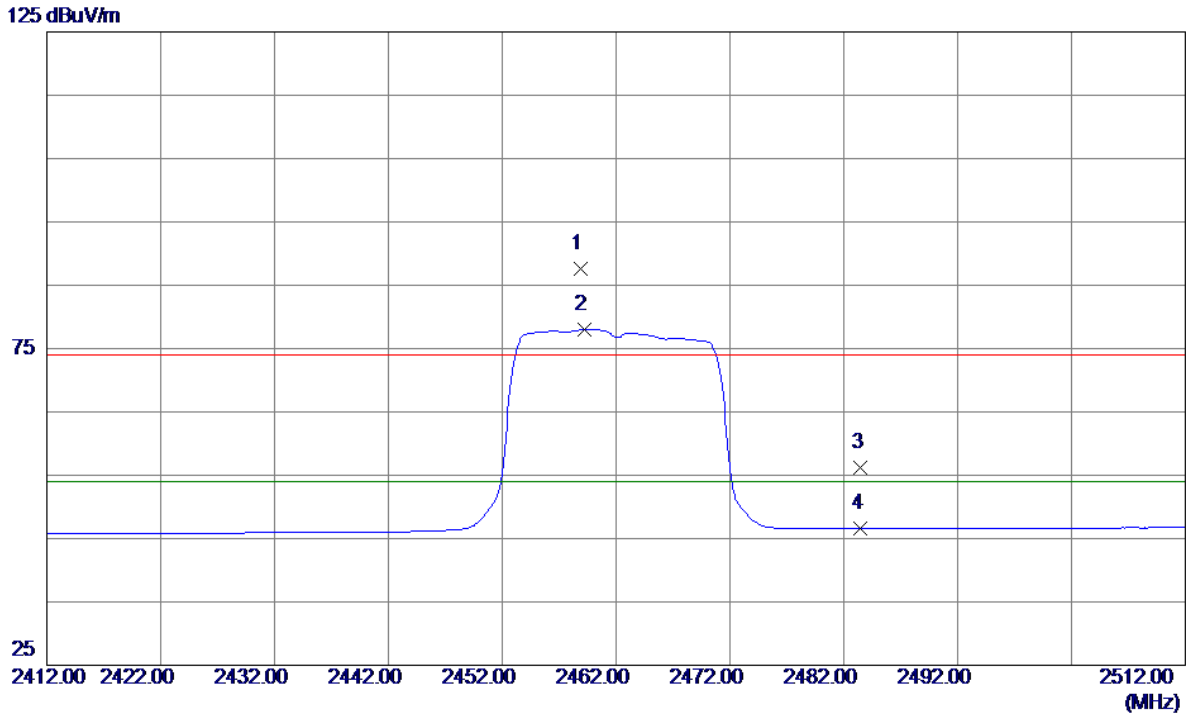

| No. | Freq. MHz | Reading Level dBuV/m | Correct Factor dB | Measure ment dBuV/m | Limit dBuV/m | Margin dB | Detector | Comment |
|-----|--------------|----------------------------|-------------------------|---------------------------|-----------------|--------------|----------|----------|
| 1 | 2458.9000 | 53.27 | 34.27 | 87.54 | 74.00 | 13.54 | Peak | No Limit |
| 2 * | 2459.2000 | 43.73 | 34.27 | 78.00 | 54.00 | 24.00 | AVG | No Limit |
| 3 | 2483.5000 | 21.84 | 34.41 | 56.25 | 74.00 | -17.75 | Peak | |
| 4 | 2483.5000 | 12.14 | 34.41 | 46.55 | 54.00 | -7.45 | AVG | |

| | |
|-------------------|-----------------------|
| Orthogonal Axis : | X |
| Test Mode : | TX N-20M MODE 2462MHz |

Horizontal

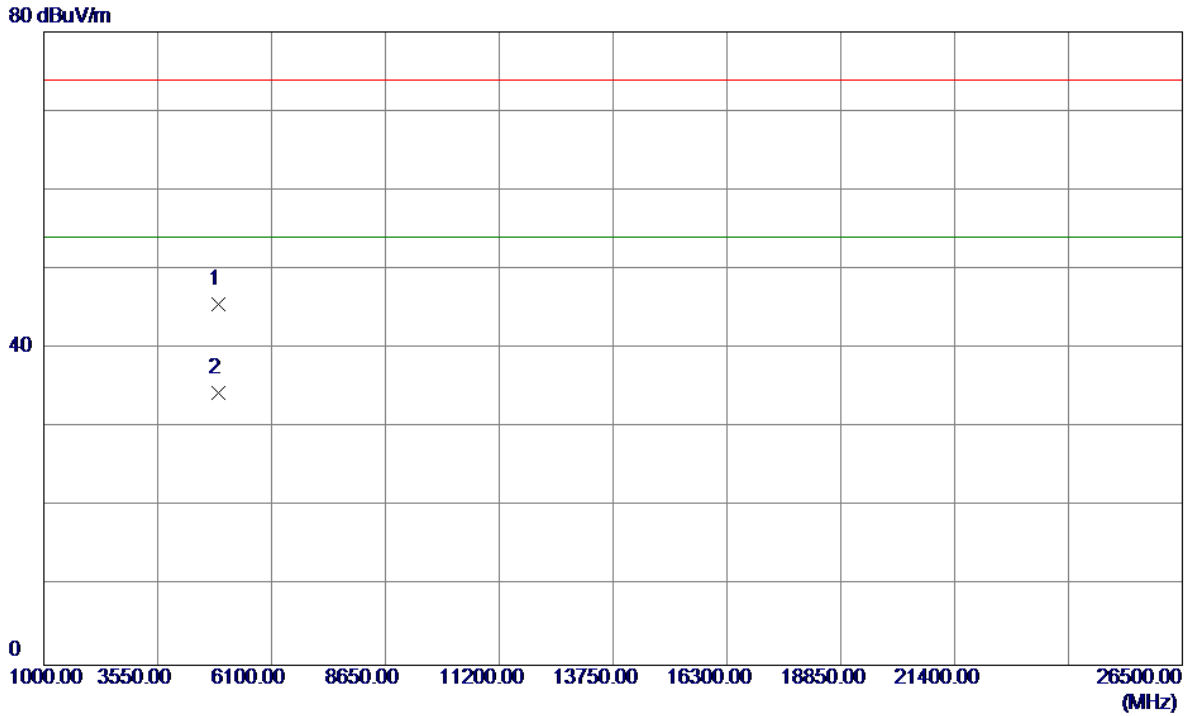

| No. | Freq. MHz | Reading Level dBuV/m | Correct Factor dB | Measure ment dBuV/m | Limit dBuV/m | Margin dB | Detector | Comment |
|-----|--------------|----------------------------|-------------------------|---------------------------|-----------------|--------------|----------|---------|
| 1 * | 4924.0200 | 40.13 | 5.51 | 45.64 | 74.00 | -28.36 | Peak | |
| 2 | 4924.0400 | 28.90 | 5.51 | 34.41 | 74.00 | -39.59 | Peak | |

| | |
|-------------------|-----------------------|
| Orthogonal Axis : | X |
| Test Mode : | TX N-40M MODE 2422MHz |

Vertical

125 dBuV/m

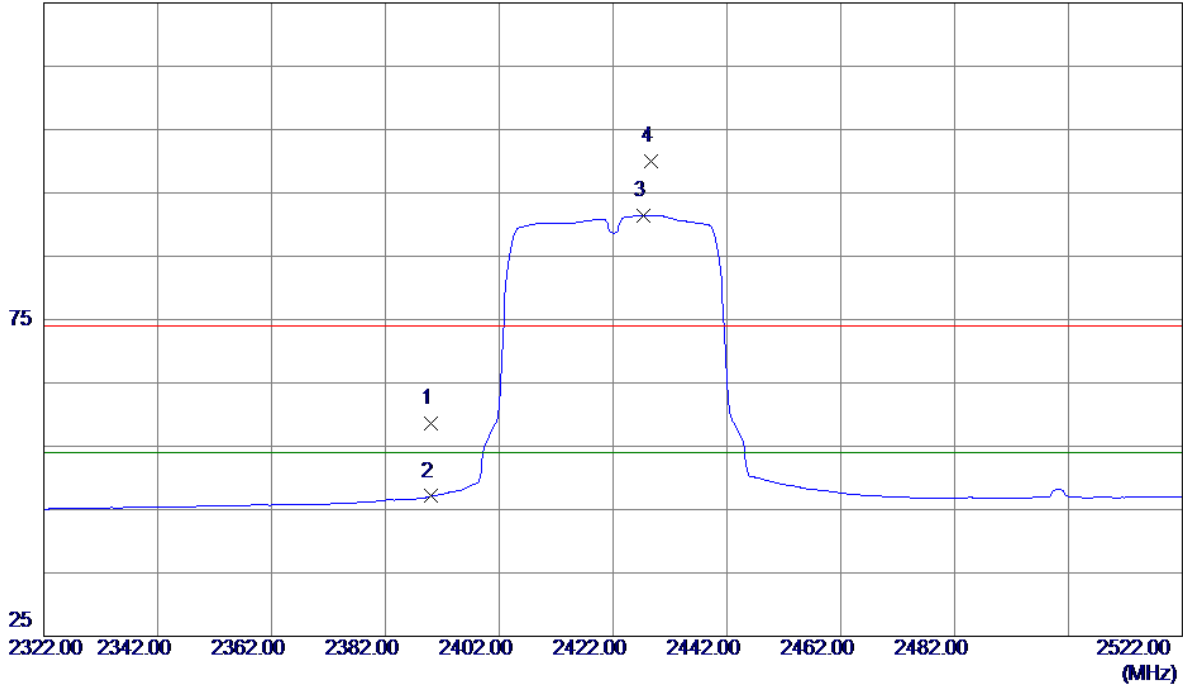

| No. | Freq. MHz | Reading Level dBuV/m | Correct Factor dB | Measure ment dBuV/m | Limit dBuV/m | Margin dB | Detector | Comment |
|-----|--------------|----------------------------|-------------------------|---------------------------|-----------------|--------------|----------|----------|
| 1 | 2390.0000 | 24.66 | 33.88 | 58.54 | 74.00 | -15.46 | Peak | |
| 2 | 2390.0000 | 13.22 | 33.88 | 47.10 | 54.00 | -6.90 | AVG | |
| 3 * | 2427.4000 | 57.39 | 34.09 | 91.48 | 54.00 | 37.48 | AVG | No Limit |
| 4 | 2428.6000 | 65.85 | 34.10 | 99.95 | 74.00 | 25.95 | Peak | No Limit |

| | |
|-------------------|-----------------------|
| Orthogonal Axis : | X |
| Test Mode : | TX N-40M MODE 2422MHz |

Vertical

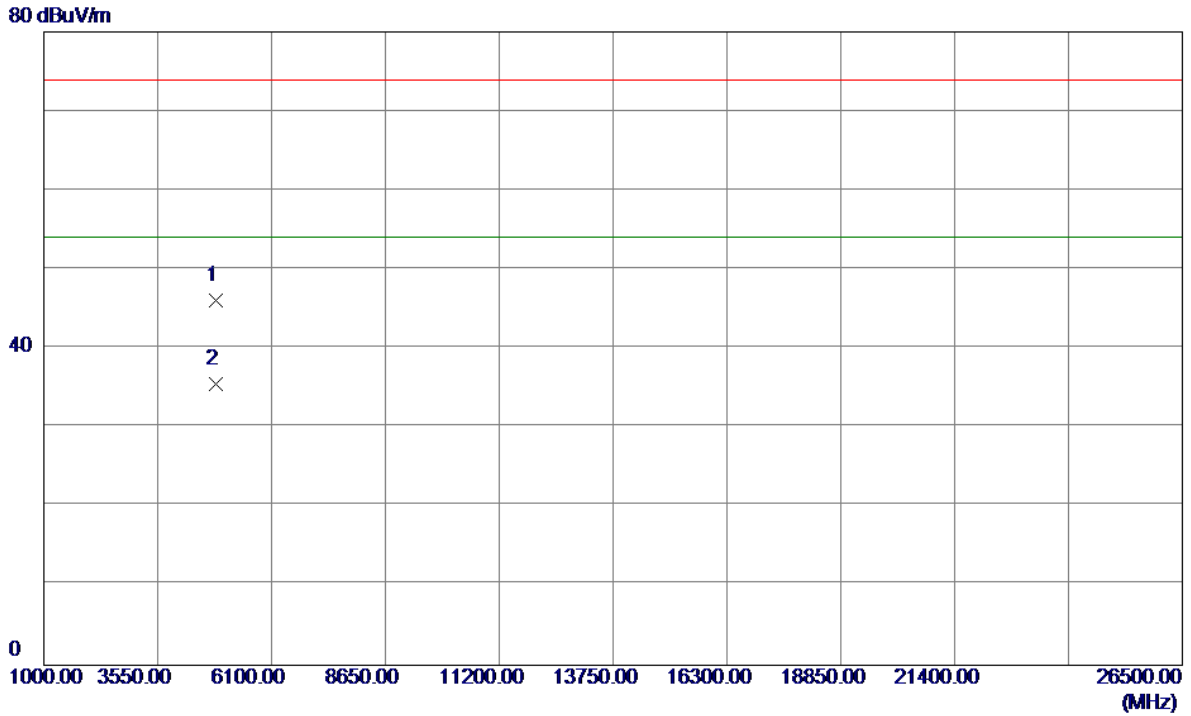

| No. | Freq. MHz | Reading Level dBuV/m | Correct Factor dB | Measure ment dBuV/m | Limit dBuV/m | Margin dB | Detector | Comment |
|-----|--------------|----------------------------|-------------------------|---------------------------|-----------------|--------------|----------|---------|
| 1 | 4843.9000 | 40.96 | 5.19 | 46.15 | 74.00 | -27.85 | Peak | |
| 2 * | 4843.9700 | 30.34 | 5.19 | 35.53 | 54.00 | -18.47 | AVG | |

| | |
|-------------------|-----------------------|
| Orthogonal Axis : | X |
| Test Mode : | TX N-40M MODE 2422MHz |

Horizontal

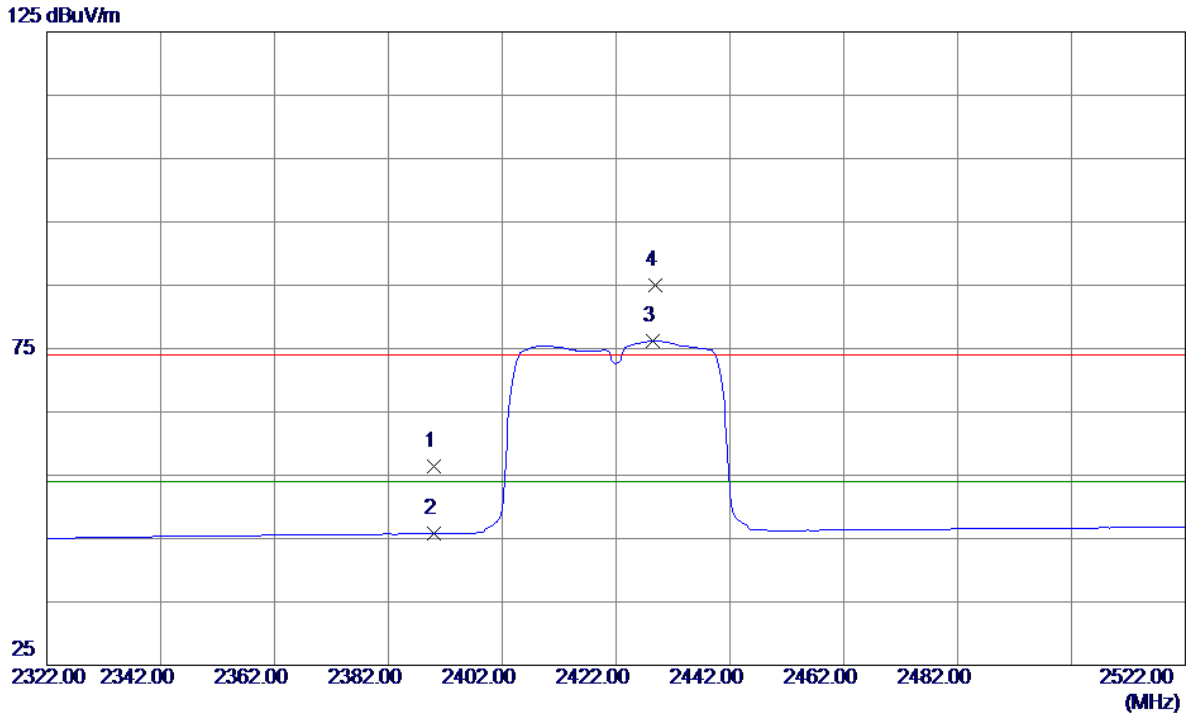

| No. | Freq. MHz | Reading Level dBuV/m | Correct Factor dB | Measure ment dBuV/m | Limit dBuV/m | Margin dB | Detector | Comment |
|-----|--------------|----------------------------|-------------------------|---------------------------|-----------------|--------------|----------|----------|
| 1 | 2390.0000 | 22.54 | 33.88 | 56.42 | 74.00 | -17.58 | Peak | |
| 2 | 2390.0000 | 11.84 | 33.88 | 45.72 | 54.00 | -8.28 | AVG | |
| 3 * | 2428.4000 | 42.04 | 34.10 | 76.14 | 54.00 | 22.14 | AVG | No Limit |
| 4 | 2428.8000 | 50.94 | 34.10 | 85.04 | 74.00 | 11.04 | Peak | No Limit |

| | |
|-------------------|-----------------------|
| Orthogonal Axis : | X |
| Test Mode : | TX N-40M MODE 2422MHz |

Horizontal

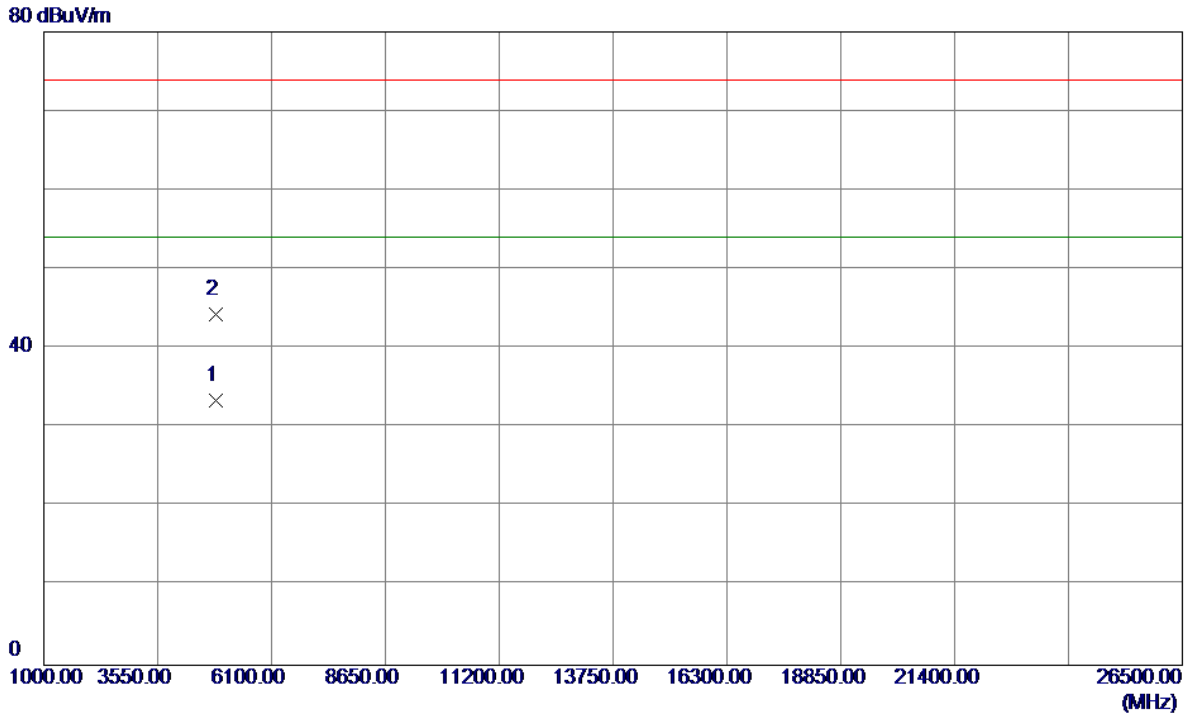

| No. | Freq. MHz | Reading Level dBuV/m | Correct Factor dB | Measure ment dBuV/m | Limit dBuV/m | Margin dB | Detector | Comment |
|-----|--------------|----------------------------|-------------------------|---------------------------|-----------------|--------------|----------|---------|
| 1 * | 4844.8700 | 28.29 | 5.20 | 33.49 | 54.00 | -20.51 | AVG | |
| 2 | 4844.0600 | 39.18 | 5.19 | 44.37 | 74.00 | -29.63 | Peak | |

| | |
|-------------------|-----------------------|
| Orthogonal Axis : | X |
| Test Mode : | TX N-40M MODE 2437MHz |

Vertical

125 dBuV/m

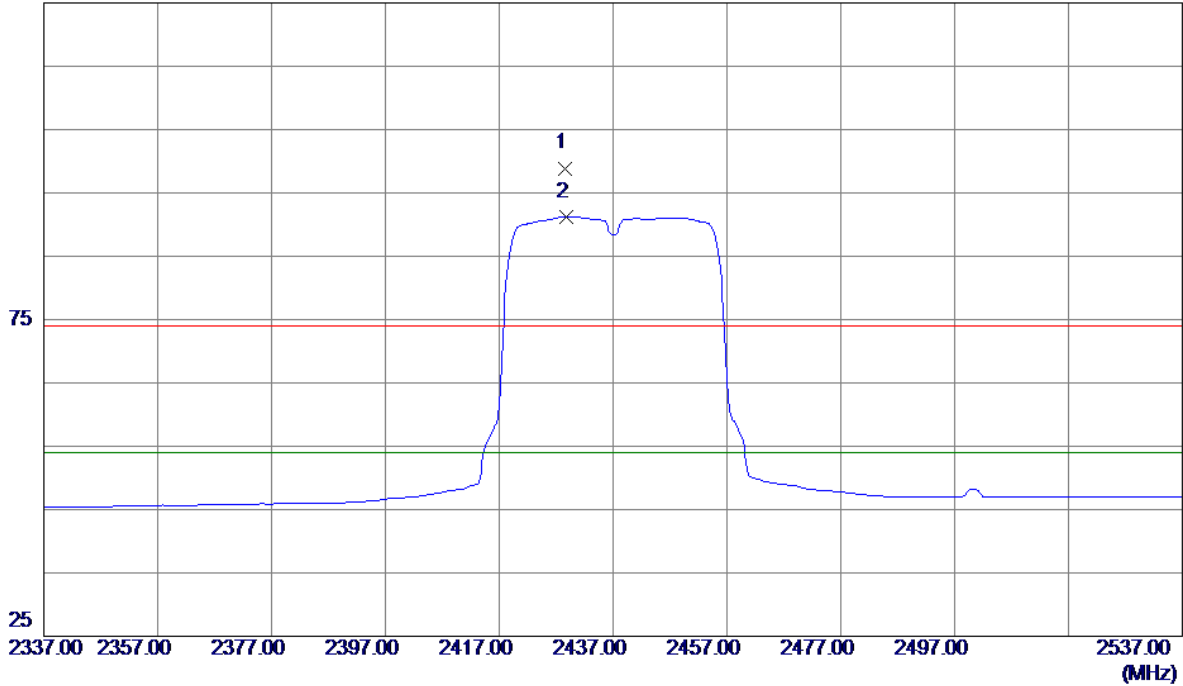

| No. | Freq. MHz | Reading Level dBuV/m | Correct Factor dB | Measure ment dBuV/m | Limit dBuV/m | Margin dB | Detector | Comment |
|-----|--------------|----------------------------|-------------------------|---------------------------|-----------------|--------------|----------|----------|
| 1 | 2428.6000 | 64.80 | 34.10 | 98.90 | 74.00 | 24.90 | Peak | No Limit |
| 2 * | 2428.8000 | 57.12 | 34.10 | 91.22 | 54.00 | 37.22 | AVG | No Limit |

| | |
|-------------------|-----------------------|
| Orthogonal Axis : | X |
| Test Mode : | TX N-40M MODE 2437MHz |

Vertical

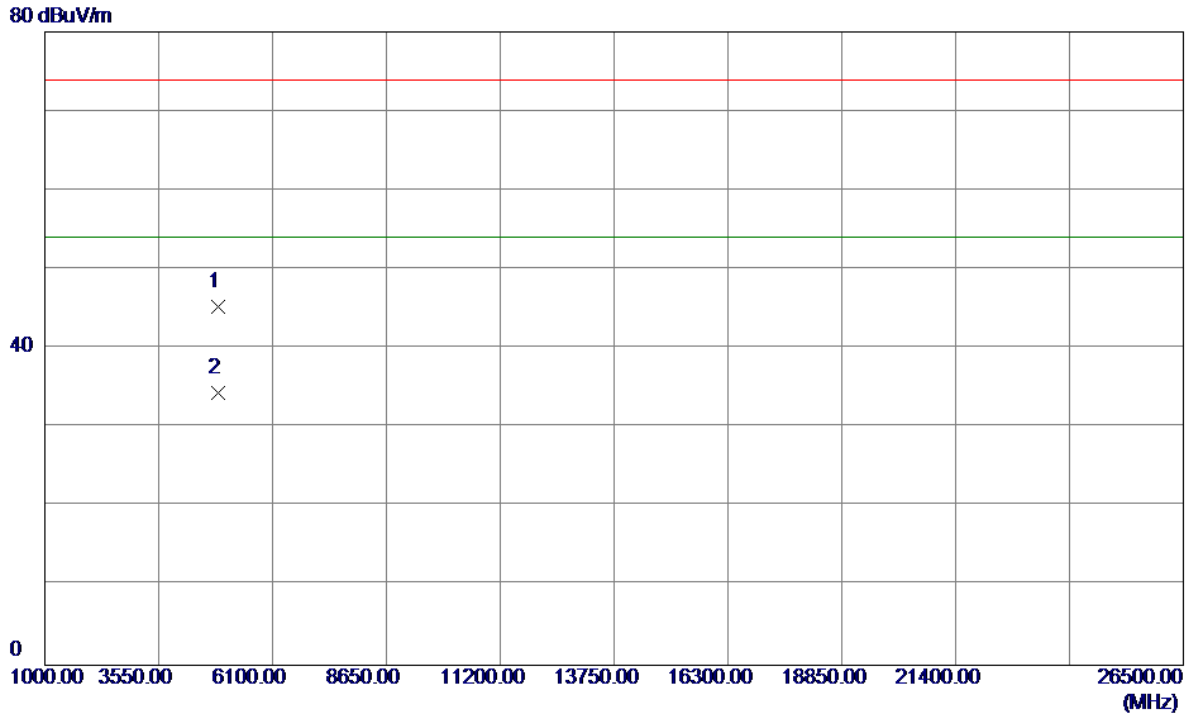

| No. | Freq. MHz | Reading Level dBuV/m | Correct Factor dB | Measure ment dBuV/m | Limit dBuV/m | Margin dB | Detector | Comment |
|-----|--------------|----------------------------|-------------------------|---------------------------|-----------------|--------------|----------|---------|
| 1 | 4873.8200 | 39.91 | 5.31 | 45.22 | 74.00 | -28.78 | Peak | |
| 2 * | 4873.9900 | 29.12 | 5.31 | 34.43 | 54.00 | -19.57 | AVG | |

| | |
|-------------------|-----------------------|
| Orthogonal Axis : | X |
| Test Mode : | TX N-40M MODE 2437MHz |

Horizontal

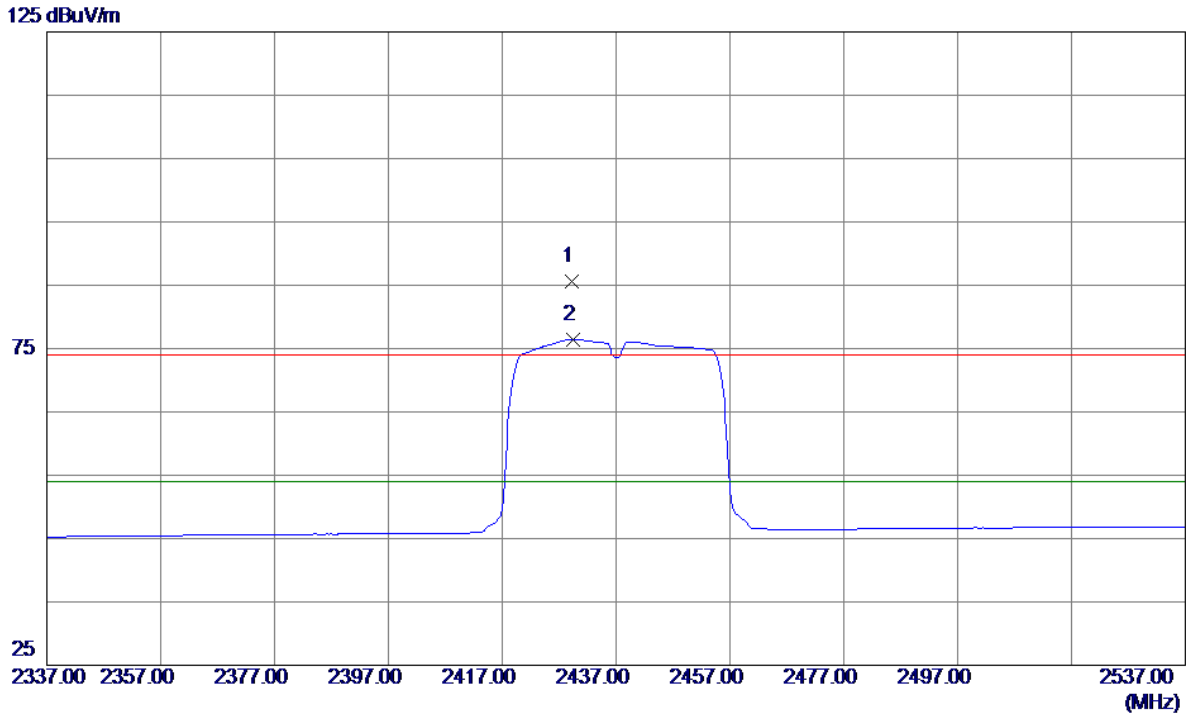

| No. | Freq. MHz | Reading Level dBuV/m | Correct Factor dB | Measure ment dBuV/m | Limit dBuV/m | Margin dB | Detector | Comment |
|-----|--------------|----------------------------|-------------------------|---------------------------|-----------------|--------------|----------|----------|
| 1 | 2429.2000 | 51.44 | 34.10 | 85.54 | 74.00 | 11.54 | Peak | No Limit |
| 2 * | 2429.4000 | 42.29 | 34.10 | 76.39 | 54.00 | 22.39 | AVG | No Limit |

| | |
|-------------------|-----------------------|
| Orthogonal Axis : | X |
| Test Mode : | TX N-40M MODE 2437MHz |

Horizontal

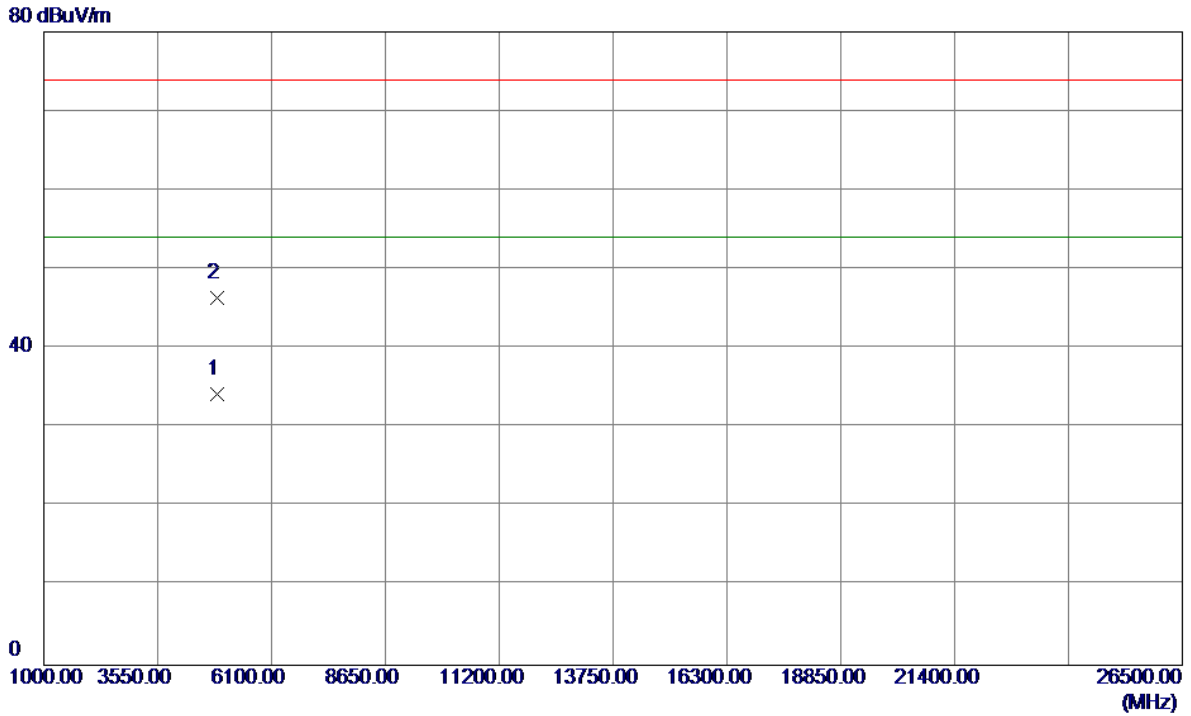

| No. | Freq. MHz | Reading Level dBuV/m | Correct Factor dB | Measure ment dBuV/m | Limit dBuV/m | Margin dB | Detector | Comment |
|-----|--------------|----------------------------|-------------------------|---------------------------|-----------------|--------------|----------|---------|
| 1 * | 4873.9400 | 28.86 | 5.31 | 34.17 | 54.00 | -19.83 | AVG | |
| 2 | 4874.1800 | 41.15 | 5.31 | 46.46 | 74.00 | -27.54 | Peak | |

| | |
|-------------------|-----------------------|
| Orthogonal Axis : | X |
| Test Mode : | TX N-40M MODE 2452MHz |

Vertical

125 dBuV/m

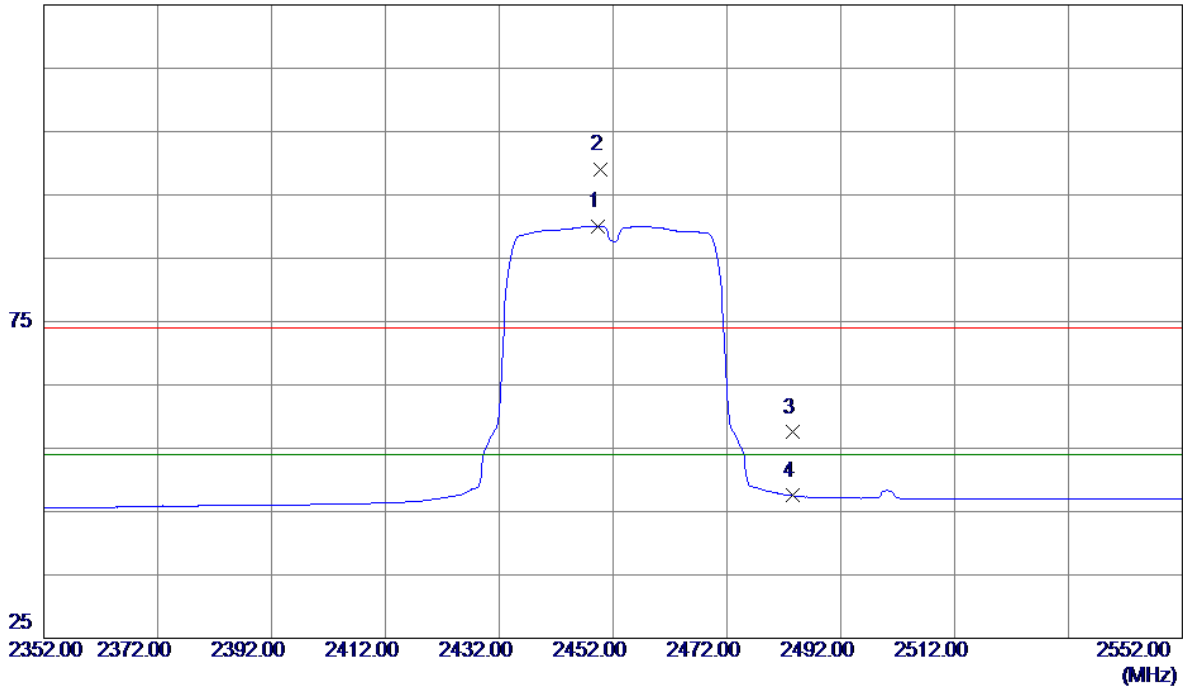

| No. | Freq. MHz | Reading Level dBuV/m | Correct Factor dB | Measure ment dBuV/m | Limit dBuV/m | Margin dB | Detector | Comment |
|-----|--------------|----------------------------|-------------------------|---------------------------|-----------------|--------------|----------|----------|
| 1 * | 2449.4000 | 55.86 | 34.22 | 90.08 | 54.00 | 36.08 | AVG | No Limit |
| 2 | 2449.8000 | 64.73 | 34.22 | 98.95 | 74.00 | 24.95 | Peak | No Limit |
| 3 | 2483.5000 | 23.09 | 34.41 | 57.50 | 74.00 | -16.50 | Peak | |
| 4 | 2483.5000 | 13.09 | 34.41 | 47.50 | 54.00 | -6.50 | AVG | |

| | |
|-------------------|-----------------------|
| Orthogonal Axis : | X |
| Test Mode : | TX N-40M MODE 2452MHz |

Vertical

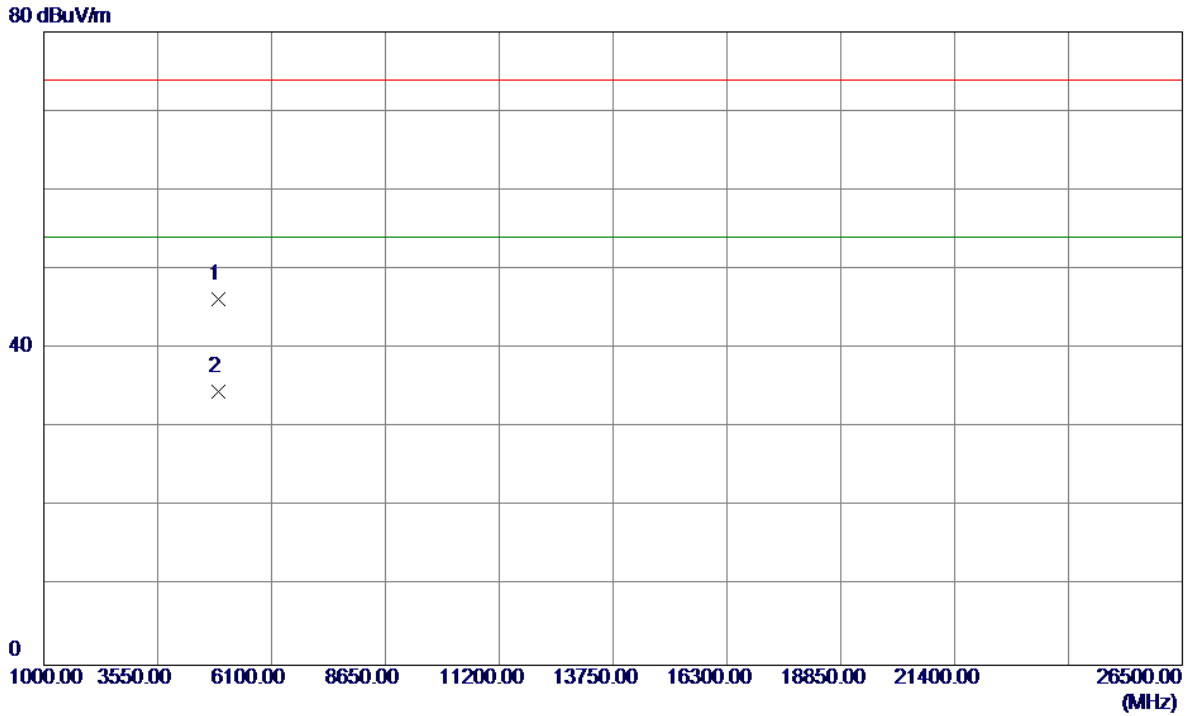

| No. | Freq. MHz | Reading Level dBuV/m | Correct Factor dB | Measure ment dBuV/m | Limit dBuV/m | Margin dB | Detector | Comment |
|-----|--------------|----------------------------|-------------------------|---------------------------|-----------------|--------------|----------|---------|
| 1 | 4903.8900 | 40.74 | 5.43 | 46.17 | 74.00 | -27.83 | Peak | |
| 2 * | 4904.0099 | 29.15 | 5.43 | 34.58 | 54.00 | -19.42 | AVG | |

| | |
|-------------------|-----------------------|
| Orthogonal Axis : | X |
| Test Mode : | TX N-40M MODE 2452MHz |

Horizontal

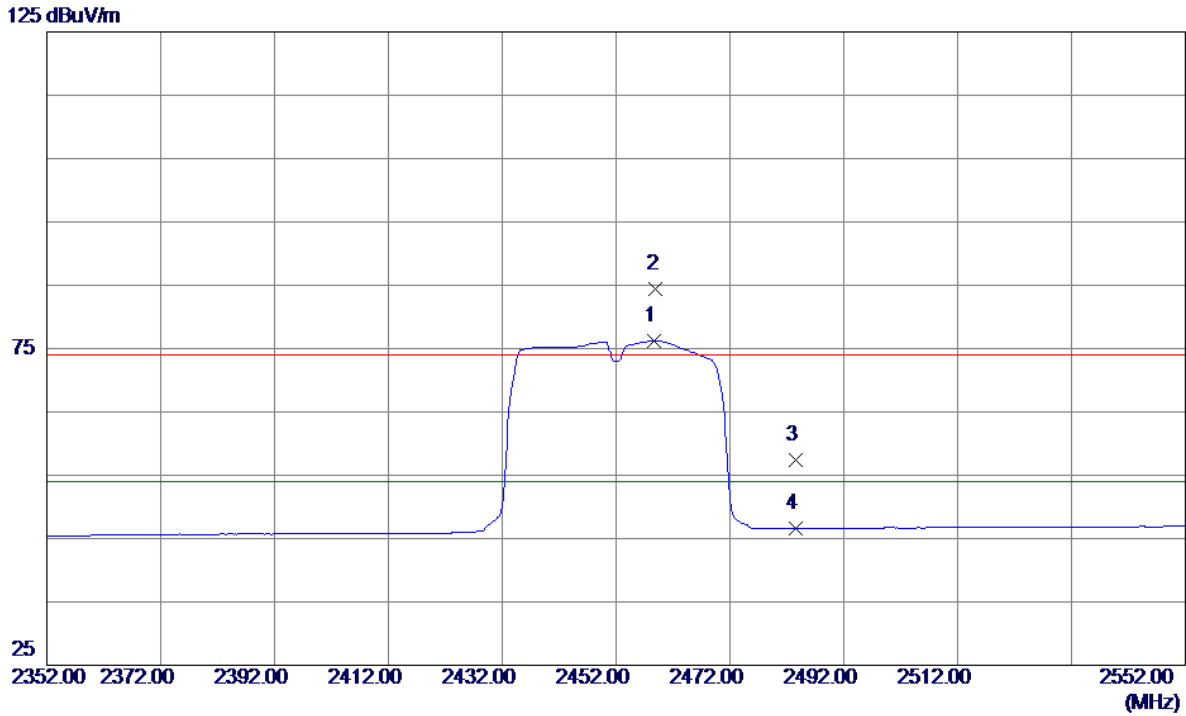

| No. | Freq. MHz | Reading Level dBuV/m | Correct Factor dB | Measure ment dBuV/m | Limit dBuV/m | Margin dB | Detector | Comment |
|-----|--------------|----------------------------|-------------------------|---------------------------|-----------------|--------------|----------|----------|
| 1 * | 2458.6000 | 41.89 | 34.27 | 76.16 | 54.00 | 22.16 | AVG | No Limit |
| 2 | 2459.0000 | 50.20 | 34.27 | 84.47 | 74.00 | 10.47 | Peak | No Limit |
| 3 | 2483.5000 | 22.98 | 34.41 | 57.39 | 74.00 | -16.61 | Peak | |
| 4 | 2483.5000 | 12.15 | 34.41 | 46.56 | 54.00 | -7.44 | AVG | |

| | |
|-------------------|-----------------------|
| Orthogonal Axis : | X |
| Test Mode : | TX N-40M MODE 2452MHz |

Horizontal

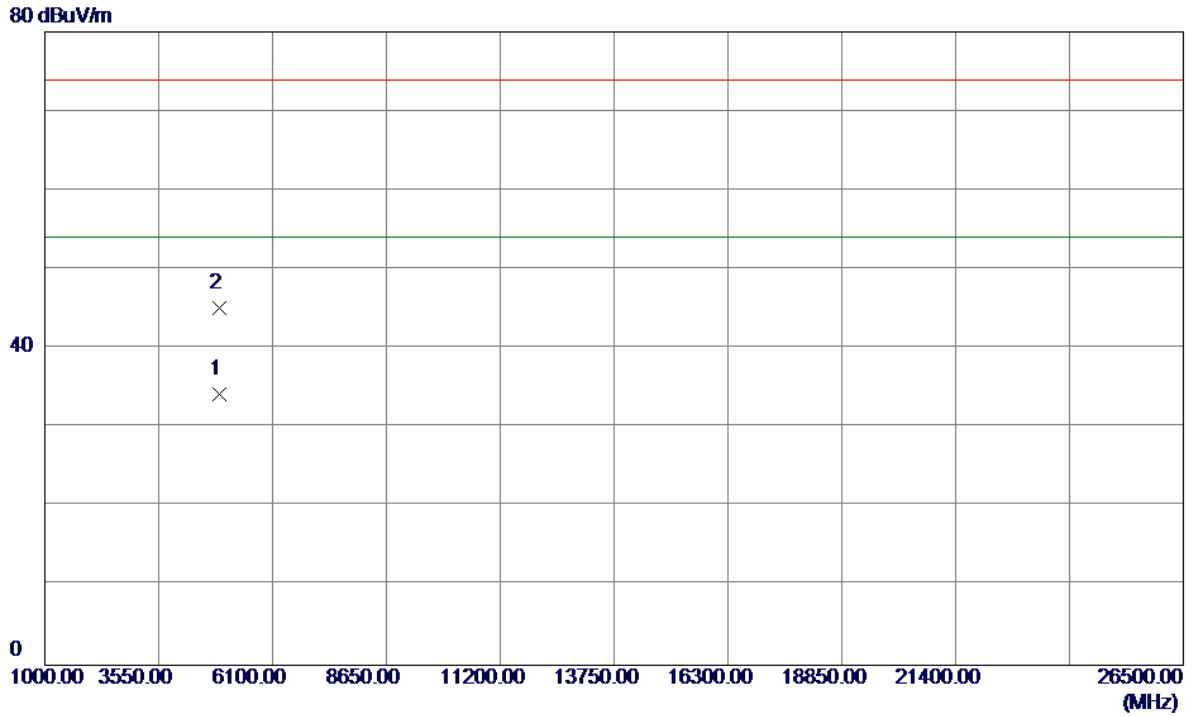

| No. | Freq. MHz | Reading Level dBuV/m | Correct Factor dB | Measure ment dBuV/m | Limit dBuV/m | Margin dB | Detector | Comment |
|-----|--------------|----------------------------|-------------------------|---------------------------|-----------------|--------------|----------|---------|
| 1 * | 4904.0400 | 28.88 | 5.43 | 34.31 | 54.00 | -19.69 | AVG | |
| 2 | 4904.0500 | 39.71 | 5.43 | 45.14 | 74.00 | -28.86 | Peak | |

ATTACHMENT E - BANDWIDTH

Test Mode : TX B Mode_CH01/06/11

| Frequency (MHz) | 6dB Bandwidth (MHz) | 99% Occupied BW (MHz) | Min. Limit (kHz) | Test Result |
|-----------------|---------------------|-----------------------|------------------|-------------|
| 2412 | 10.10 | 15.04 | 500 | Complies |
| 2437 | 10.10 | 15.04 | 500 | Complies |
| 2462 | 10.10 | 15.04 | 500 | Complies |

TX CH01

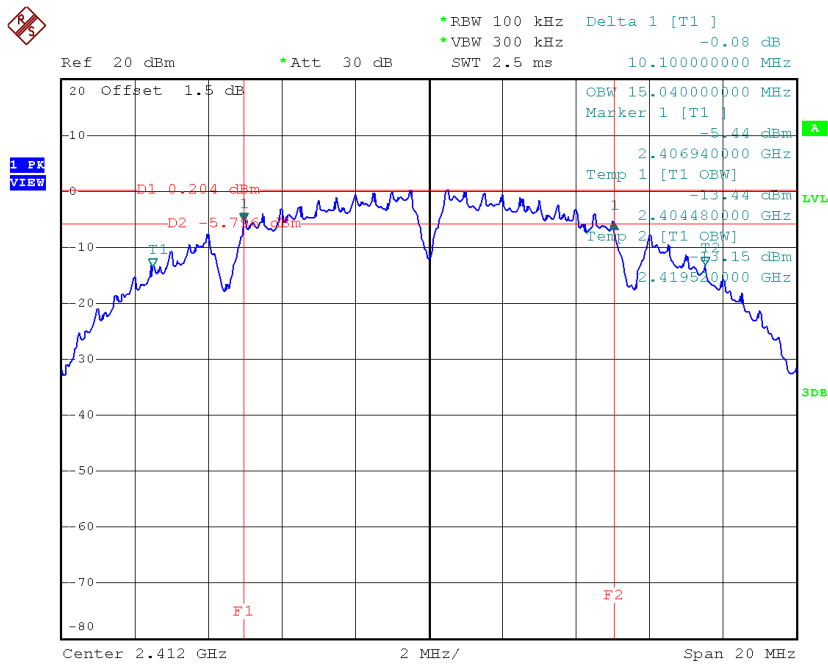

Date: 14.AUG.2016 11:52:14

TX CH06

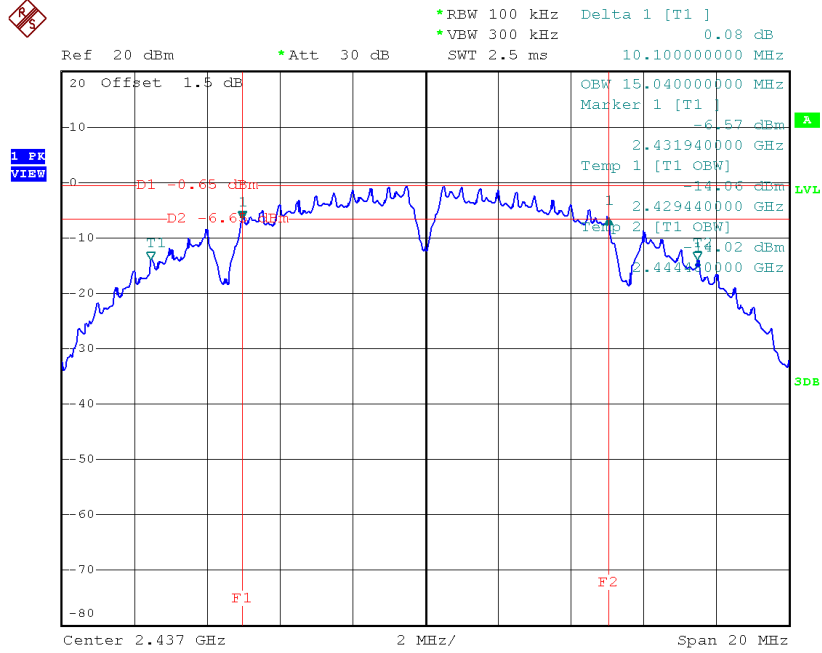

Date: 14.AUG.2016 11:54:00

TX CH11

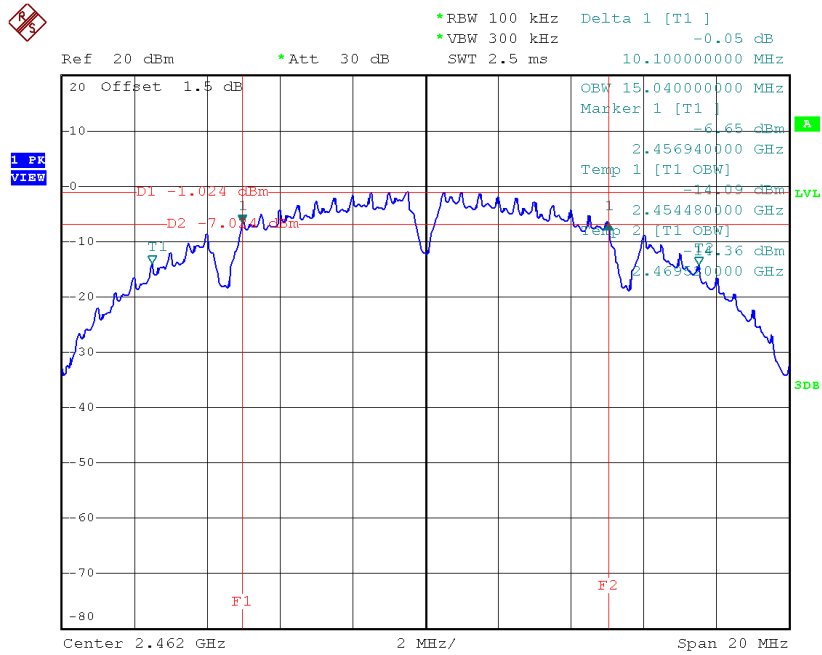

Date: 14.AUG.2016 11:55:47

Test Mode: TX G Mode_CH01/06/11

| Frequency (MHz) | 6dB Bandwidth (MHz) | 99% Occupied BW (MHz) | Min. Limit (kHz) | Test Result |
|-----------------|---------------------|-----------------------|------------------|-------------|
| 2412 | 16.62 | 16.52 | 500 | Complies |
| 2437 | 16.64 | 16.52 | 500 | Complies |
| 2462 | 16.63 | 16.52 | 500 | Complies |

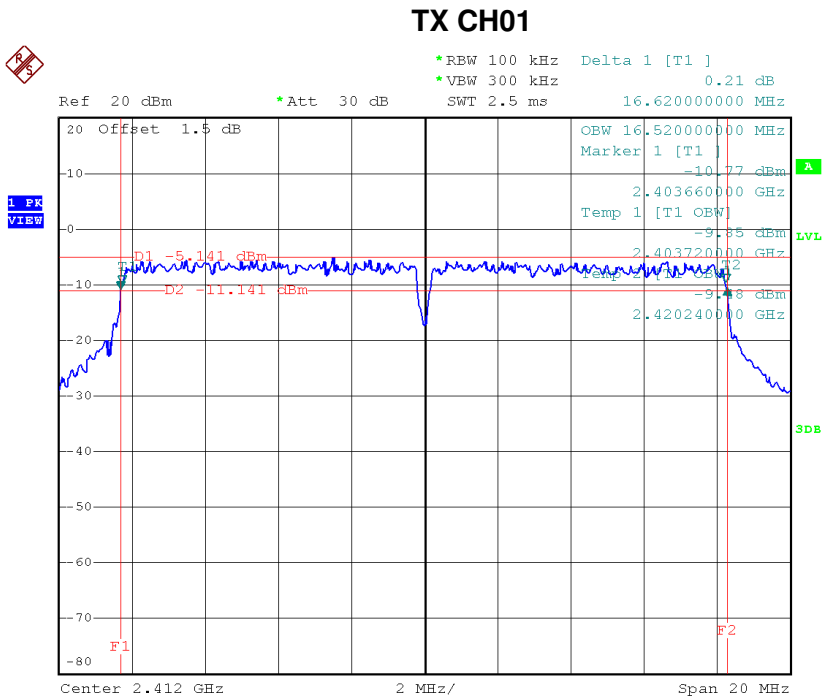

Date: 14.AUG.2016 12:04:38

TX CH06

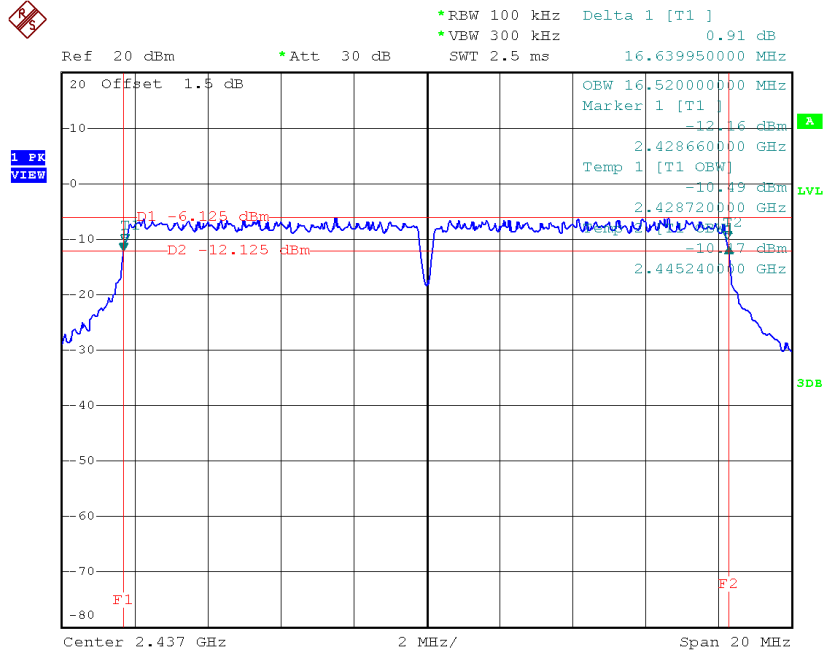

Date: 14.AUG.2016 12:06:22

TX CH11

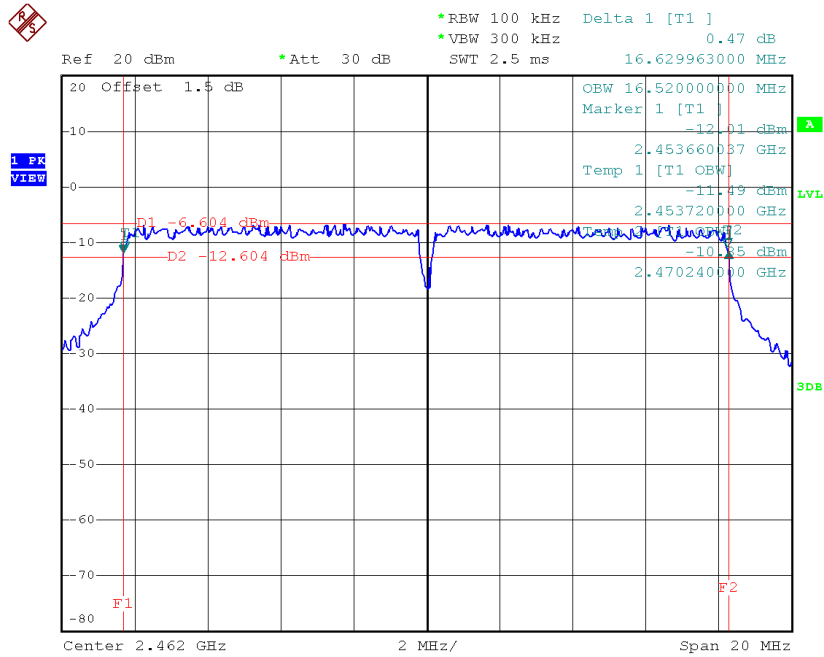

Date: 14.AUG.2016 12:07:29

Test Mode : TX N-20MHz Mode_CH01/06/11

| Frequency (MHz) | 6dB Bandwidth (MHz) | 99% Occupied BW (MHz) | Min. Limit (kHz) | Test Result |
|-----------------|---------------------|-----------------------|------------------|-------------|
| 2412 | 17.90 | 17.68 | 500 | Complies |
| 2437 | 17.86 | 17.68 | 500 | Complies |
| 2462 | 17.86 | 17.68 | 500 | Complies |

TX CH01

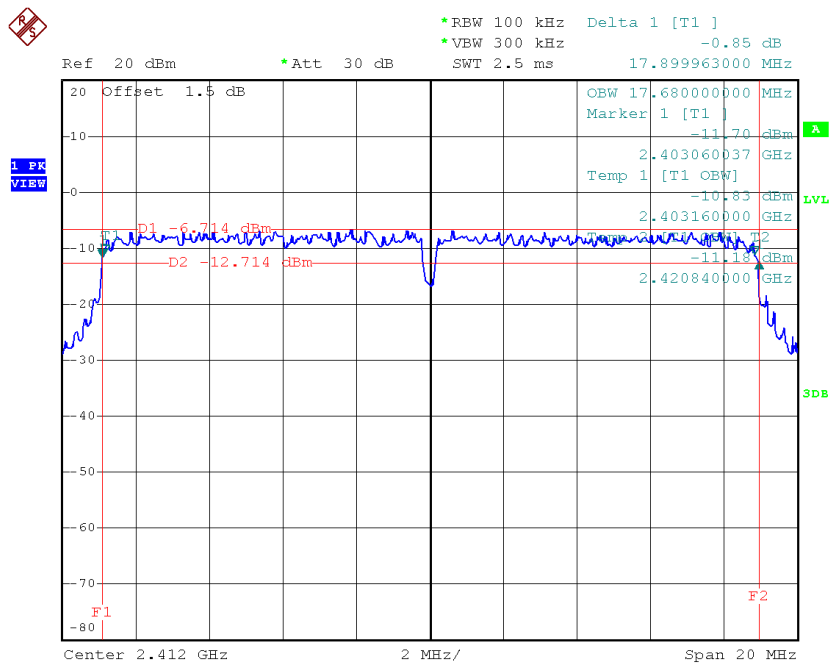

Date: 14.AUG.2016 12:14:39

TX CH06

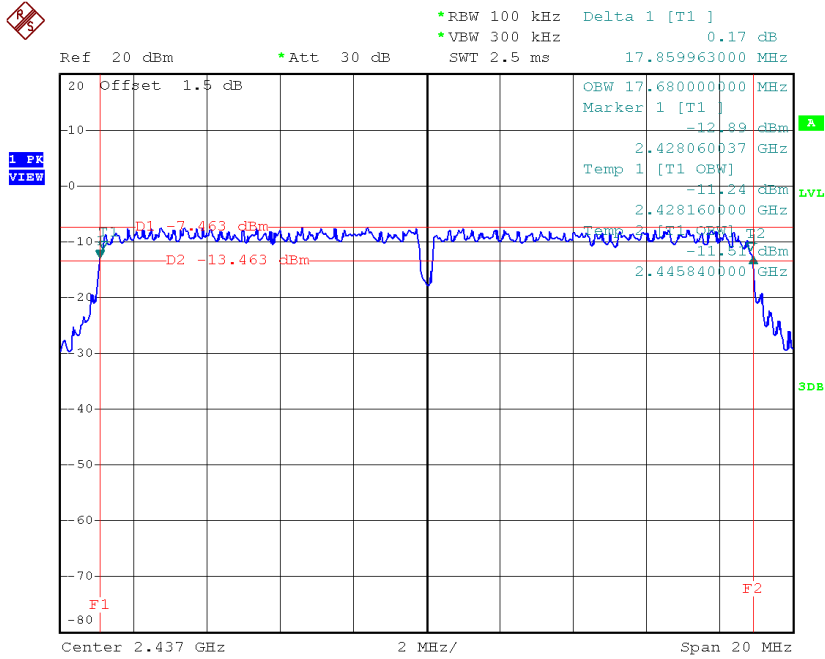

Date: 14.AUG.2016 12:17:12

TX CH11

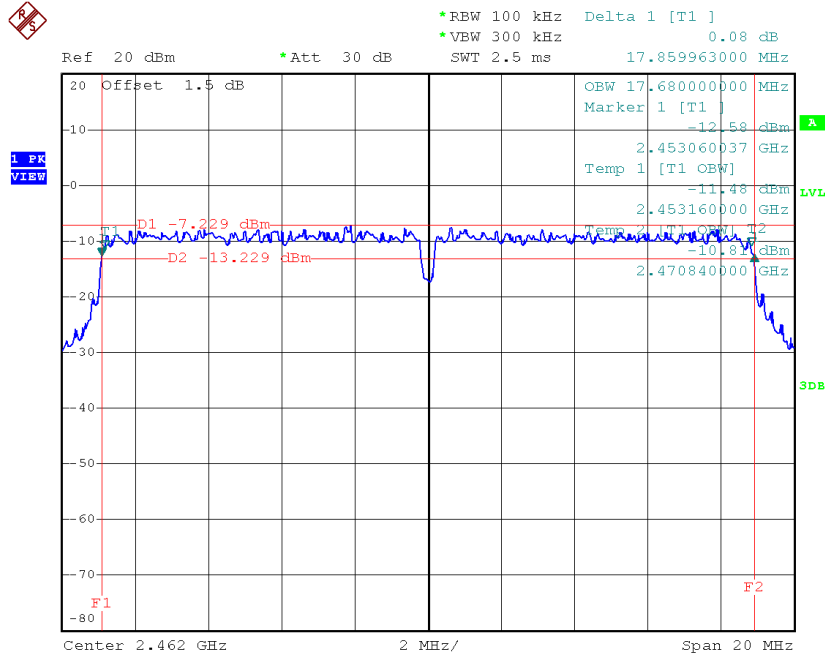

Date: 14.AUG.2016 12:20:35

Test Mode : TX N-40MHz Mode_CH03/06/09

| Frequency (MHz) | 6dB Bandwidth (MHz) | 99% Occupied BW (MHz) | Min. Limit (kHz) | Test Result |
|-----------------|---------------------|-----------------------|------------------|-------------|
| 2422 | 36.57 | 36.16 | 500 | Complies |
| 2437 | 36.57 | 36.08 | 500 | Complies |
| 2452 | 36.52 | 36.16 | 500 | Complies |

TX CH03

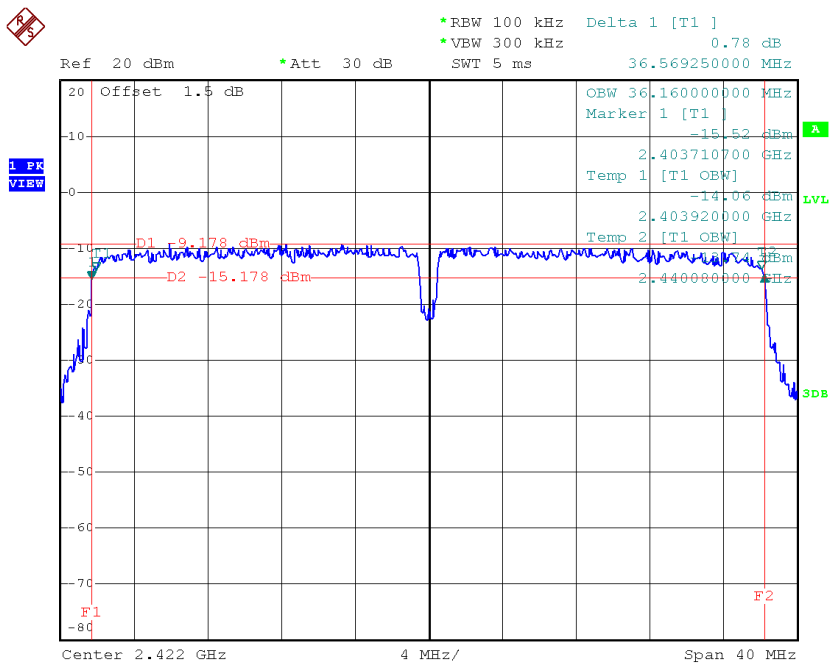

Date: 14.AUG.2016 12:29:20

TX CH06

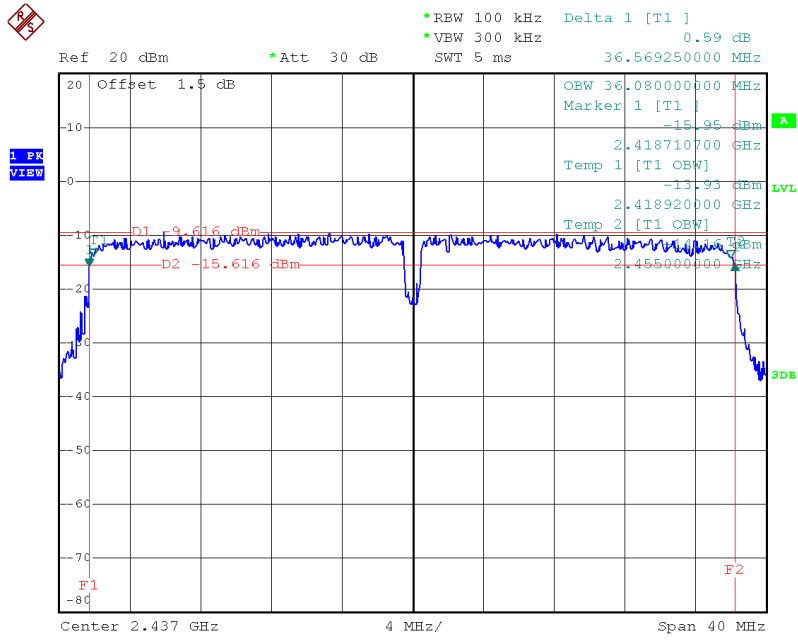

Date: 14.AUG.2016 12:31:18

TX CH09

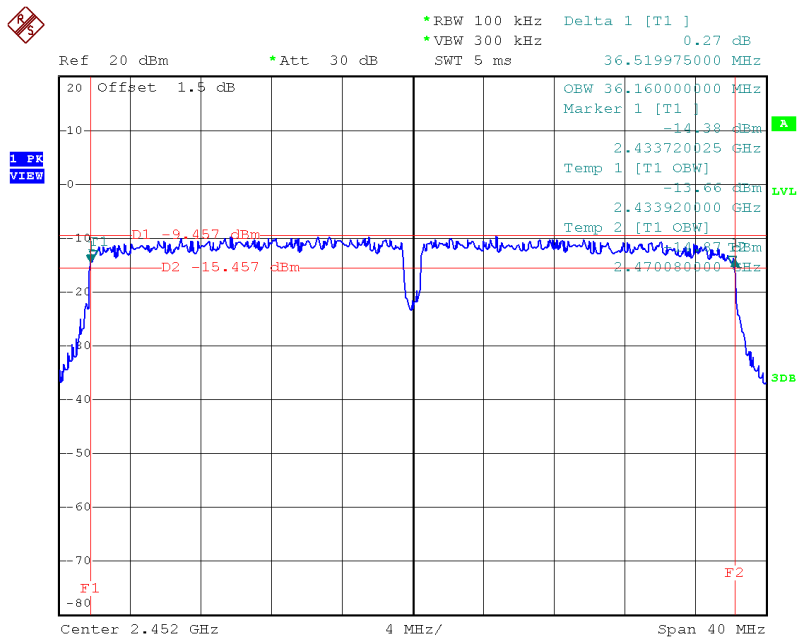

Date: 14.AUG.2016 12:46:39

ATTACHMENT F - MAXIMUM PEAK CONDUCTED OUTPUT POWER

| Test Mode :TX B Mode_CH01/06/11_ANT 1 | | | | | |
|---------------------------------------|-----------------------|---------------------|------------------|----------------|----------|
| Frequency (MHz) | Conducted Power (dBm) | Conducted Power (W) | Max. Limit (dBm) | Max. Limit (W) | Result |
| 2412 | 13.77 | 0.02 | 30.00 | 1.00 | Complies |
| 2437 | 13.95 | 0.02 | 30.00 | 1.00 | Complies |
| 2462 | 13.53 | 0.02 | 30.00 | 1.00 | Complies |

| Test Mode :TX B Mode_CH01/06/11_ANT 2 | | | | | |
|---------------------------------------|-----------------------|---------------------|------------------|----------------|----------|
| Frequency (MHz) | Conducted Power (dBm) | Conducted Power (W) | Max. Limit (dBm) | Max. Limit (W) | Result |
| 2412 | 14.26 | 0.03 | 30.00 | 1.00 | Complies |
| 2437 | 13.68 | 0.02 | 30.00 | 1.00 | Complies |
| 2462 | 13.87 | 0.02 | 30.00 | 1.00 | Complies |

| Test Mode :TX B Mode_CH01/06/11_Total | | | | | |
|---------------------------------------|-----------------------|---------------------|------------------|----------------|----------|
| Frequency (MHz) | Conducted Power (dBm) | Conducted Power (W) | Max. Limit (dBm) | Max. Limit (W) | Result |
| 2412 | 17.03 | 0.05 | 30.00 | 1.00 | Complies |
| 2437 | 16.83 | 0.05 | 30.00 | 1.00 | Complies |
| 2462 | 16.71 | 0.05 | 30.00 | 1.00 | Complies |

| Test Mode :TX G Mode_CH01/06/11_ANT 1 | | | | | |
|---------------------------------------|-----------------------|---------------------|------------------|----------------|----------|
| Frequency (MHz) | Conducted Power (dBm) | Conducted Power (W) | Max. Limit (dBm) | Max. Limit (W) | Result |
| 2412 | 20.85 | 0.12 | 30.00 | 1.00 | Complies |
| 2437 | 20.79 | 0.12 | 30.00 | 1.00 | Complies |
| 2462 | 20.67 | 0.12 | 30.00 | 1.00 | Complies |

| Test Mode :TX G Mode_CH01/06/11_ANT 2 | | | | | |
|---------------------------------------|-----------------------|---------------------|------------------|----------------|----------|
| Frequency (MHz) | Conducted Power (dBm) | Conducted Power (W) | Max. Limit (dBm) | Max. Limit (W) | Result |
| 2412 | 20.48 | 0.11 | 30.00 | 1.00 | Complies |
| 2437 | 20.24 | 0.11 | 30.00 | 1.00 | Complies |
| 2462 | 20.12 | 0.10 | 30.00 | 1.00 | Complies |

| Test Mode :TX G Mode_CH01/06/11_Total | | | | | |
|---------------------------------------|-----------------------|---------------------|------------------|----------------|----------|
| Frequency (MHz) | Conducted Power (dBm) | Conducted Power (W) | Max. Limit (dBm) | Max. Limit (W) | Result |
| 2412 | 23.68 | 0.23 | 30.00 | 1.00 | Complies |
| 2437 | 23.53 | 0.23 | 30.00 | 1.00 | Complies |
| 2462 | 23.41 | 0.22 | 30.00 | 1.00 | Complies |

| Test Mode :TX N20 Mode_CH01/06/11_ANT 1 | | | | | |
|---|-----------------------|---------------------|------------------|----------------|----------|
| Frequency (MHz) | Conducted Power (dBm) | Conducted Power (W) | Max. Limit (dBm) | Max. Limit (W) | Result |
| 2412 | 18.79 | 0.08 | 30.00 | 1.00 | Complies |
| 2437 | 18.74 | 0.07 | 30.00 | 1.00 | Complies |
| 2462 | 18.67 | 0.07 | 30.00 | 1.00 | Complies |

| Test Mode :TX N20 Mode_CH01/06/11_ANT 2 | | | | | |
|---|-----------------------|---------------------|------------------|----------------|----------|
| Frequency (MHz) | Conducted Power (dBm) | Conducted Power (W) | Max. Limit (dBm) | Max. Limit (W) | Result |
| 2412 | 18.54 | 0.07 | 30.00 | 1.00 | Complies |
| 2437 | 18.69 | 0.07 | 30.00 | 1.00 | Complies |
| 2462 | 18.68 | 0.07 | 30.00 | 1.00 | Complies |

| Test Mode :TX N20 Mode_CH01/06/11_Total | | | | | |
|---|-----------------------|---------------------|------------------|----------------|----------|
| Frequency (MHz) | Conducted Power (dBm) | Conducted Power (W) | Max. Limit (dBm) | Max. Limit (W) | Result |
| 2412 | 21.68 | 0.15 | 30.00 | 1.00 | Complies |
| 2437 | 21.73 | 0.15 | 30.00 | 1.00 | Complies |
| 2462 | 21.69 | 0.15 | 30.00 | 1.00 | Complies |

| Test Mode :TX N40 Mode_CH03/06/09_ANT 1 | | | | | |
|---|-----------------------|---------------------|------------------|----------------|----------|
| Frequency (MHz) | Conducted Power (dBm) | Conducted Power (W) | Max. Limit (dBm) | Max. Limit (W) | Result |
| 2422 | 18.51 | 0.07 | 30.00 | 1.00 | Complies |
| 2437 | 18.38 | 0.07 | 30.00 | 1.00 | Complies |
| 2452 | 18.26 | 0.07 | 30.00 | 1.00 | Complies |

| Test Mode :TX N40 Mode_CH03/06/09_ANT 2 | | | | | |
|---|-----------------------|---------------------|------------------|----------------|----------|
| Frequency (MHz) | Conducted Power (dBm) | Conducted Power (W) | Max. Limit (dBm) | Max. Limit (W) | Result |
| 2422 | 18.18 | 0.07 | 30.00 | 1.00 | Complies |
| 2437 | 18.13 | 0.07 | 30.00 | 1.00 | Complies |
| 2452 | 18.12 | 0.06 | 30.00 | 1.00 | Complies |

| Test Mode :TX N40 Mode_CH03/06/09_Total | | | | | |
|---|-----------------------|---------------------|------------------|----------------|----------|
| Frequency (MHz) | Conducted Power (dBm) | Conducted Power (W) | Max. Limit (dBm) | Max. Limit (W) | Result |
| 2422 | 21.36 | 0.14 | 30.00 | 1.00 | Complies |
| 2437 | 21.27 | 0.13 | 30.00 | 1.00 | Complies |
| 2452 | 21.20 | 0.13 | 30.00 | 1.00 | Complies |

ATTACHMENT G - ANTENNA CONDUCTED SPURIOUS EMISSION

Test Mode : TX B Mode_ANT 1

TX B mode CH01

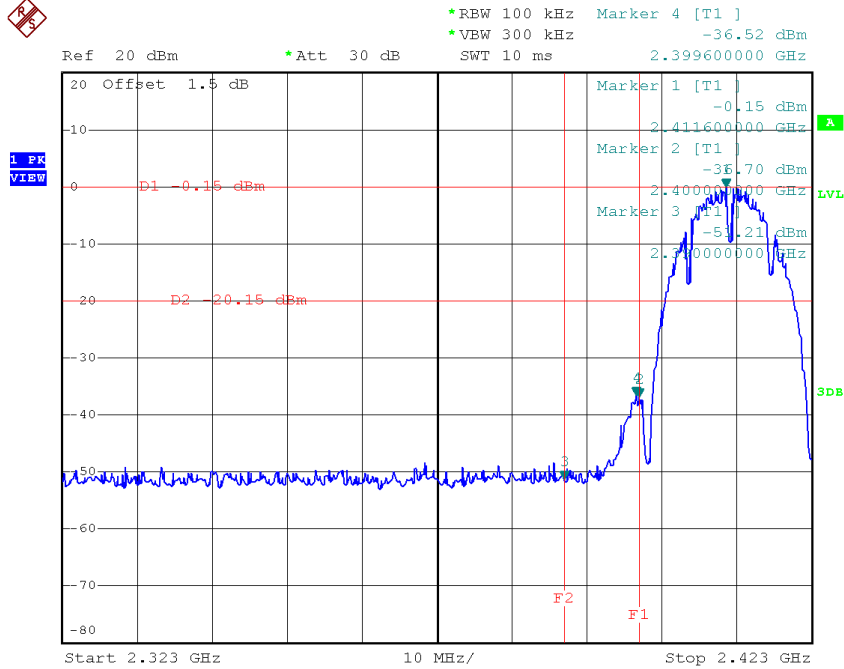

Date: 14.AUG.2016 11:52:53

TX B mode CH11

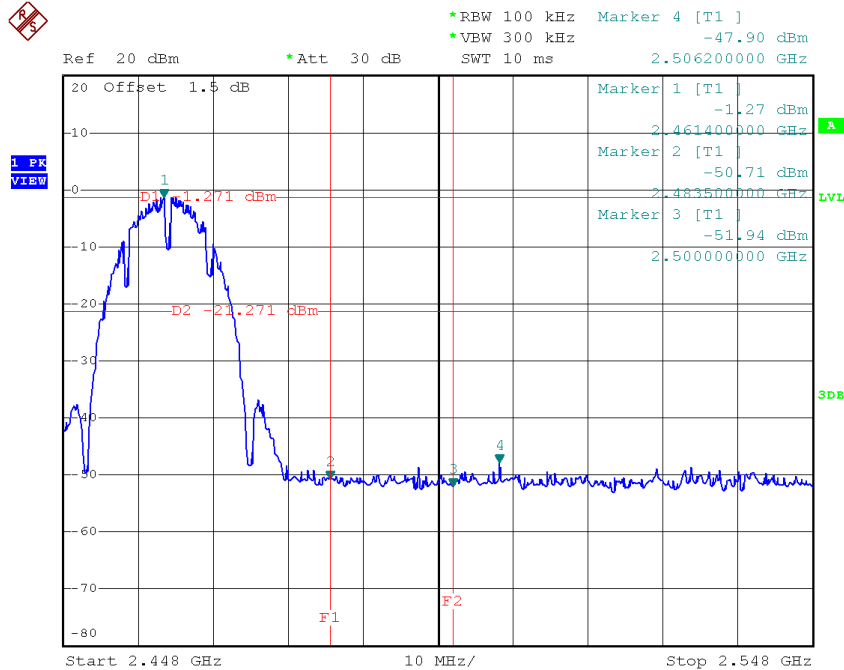

Date: 14.AUG.2016 11:56:26

TX B mode CH01 (10 Harmonic of the frequency)



Ref 20 dBm *Att 30 dB *REW 100 kHz Marker 2 [T1]
*VBW 300 kHz -48.26 dBm
SWT 300 ms 83.460000000 MHz

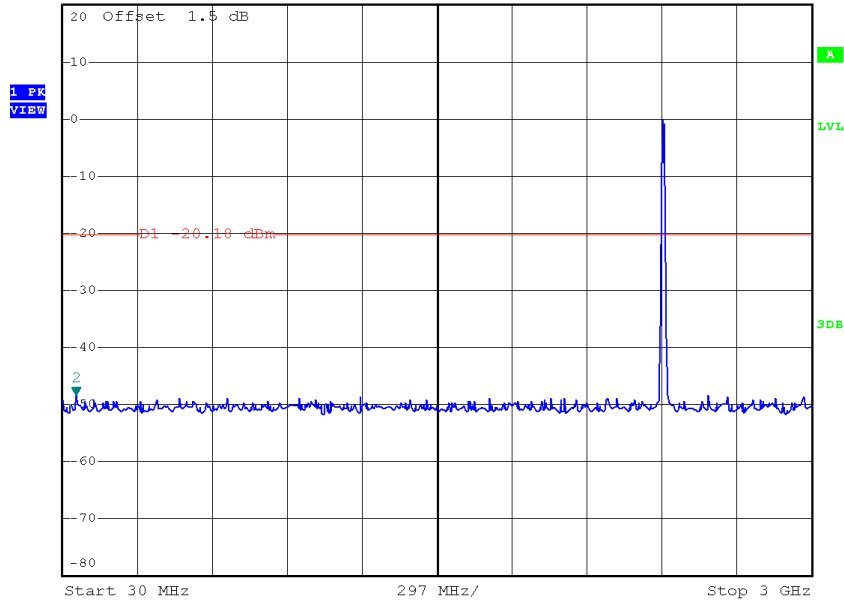

Date: 14.AUG.2016 11:52:28



Ref 20 dBm *Att 30 dB *REW 100 kHz Marker 1 [T1]
*VBW 300 kHz -45.01 dBm
SWT 1.2 s 14.040000000 GHz

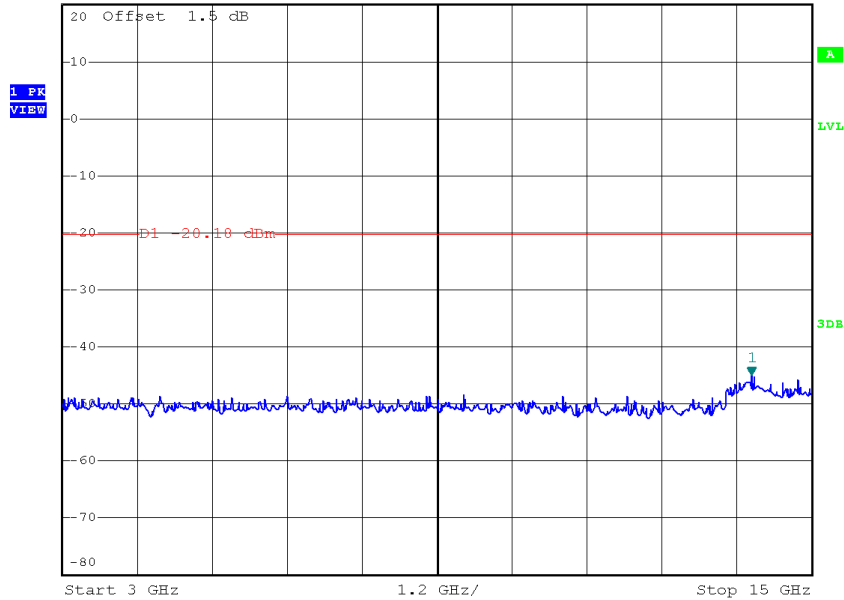

Date: 14.AUG.2016 11:52:36

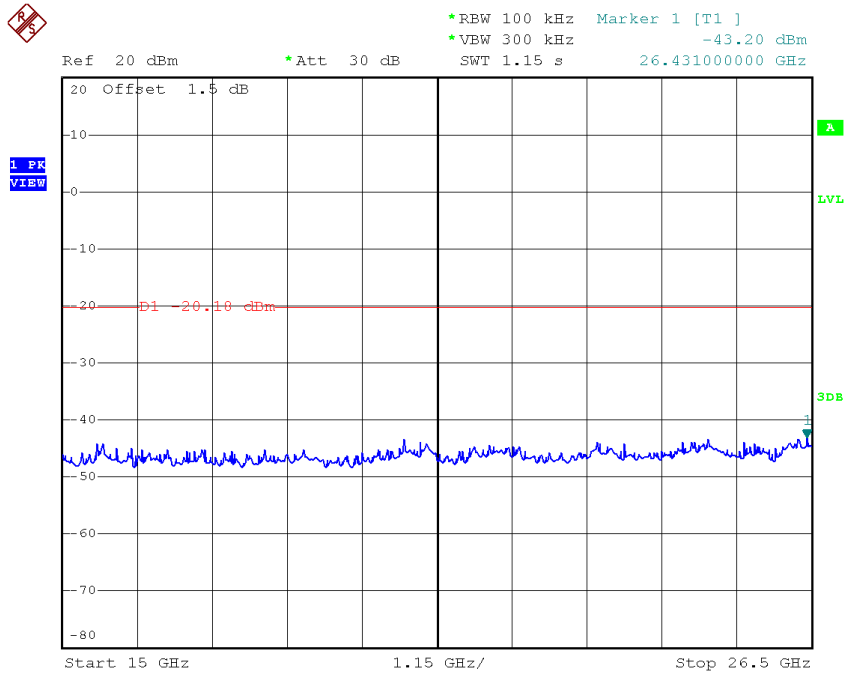

Date: 14.AUG.2016 11:52:45

TX B mode CH06 (10 Harmonic of the frequency)

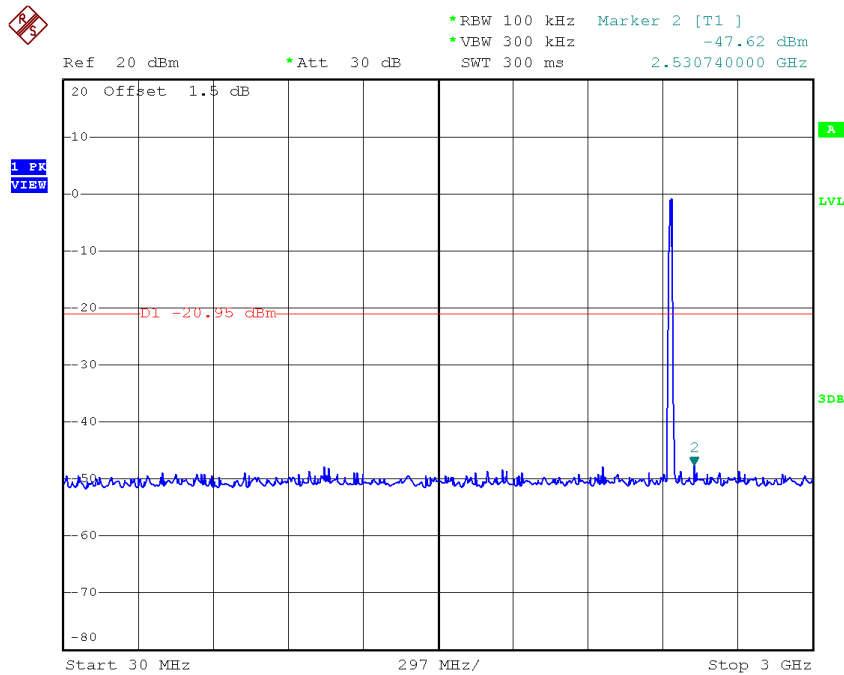

Date: 14.AUG.2016 11:54:13



Ref 20 dBm *Att 30 dB *RBW 100 kHz Marker 1 [T1]
*VEW 300 kHz -45.61 dBm
SWT 1.2 s 14.088000000 GHz

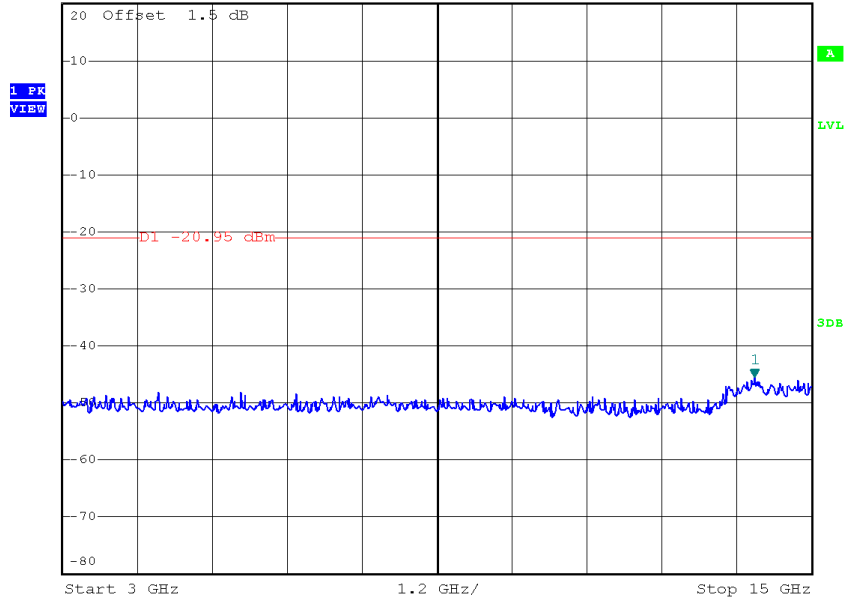

Date: 14.AUG.2016 11:54:22



Ref 20 dBm *Att 30 dB *RBW 100 kHz Marker 1 [T1]
*VEW 300 kHz -42.40 dBm
SWT 1.15 s 26.339000000 GHz

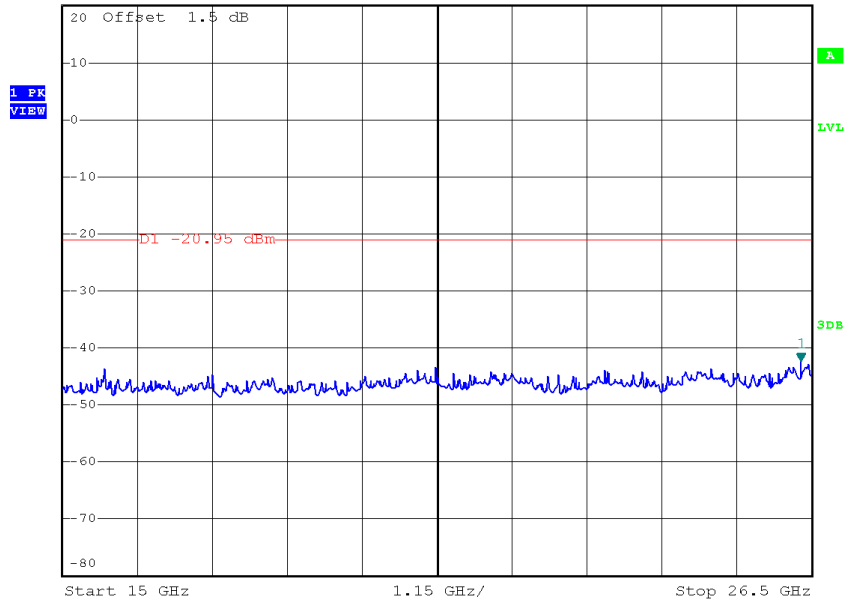

Date: 14.AUG.2016 11:54:30

TX B mode CH11 (10 Harmonic of the frequency)

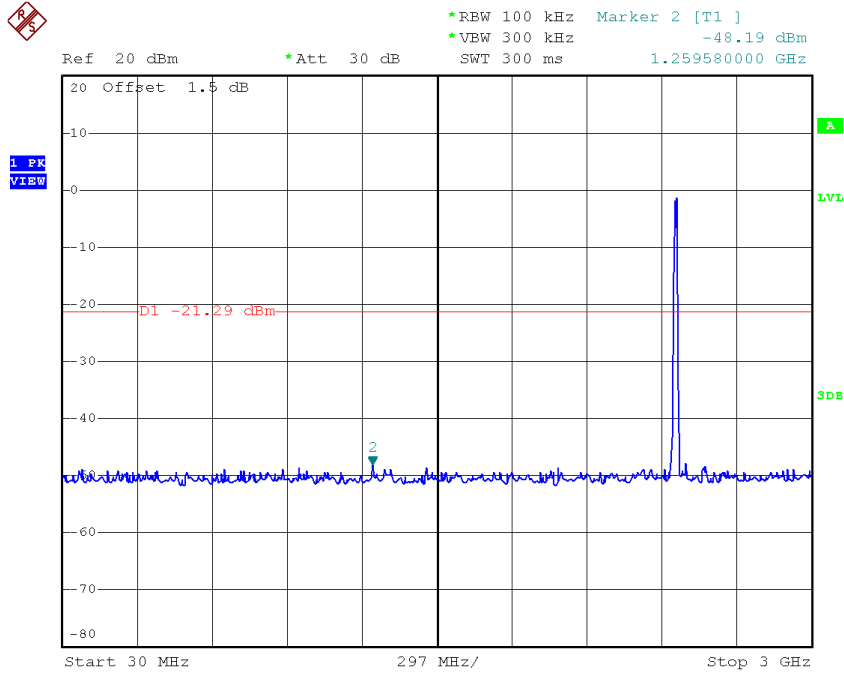

Date: 14.AUG.2016 11:56:01

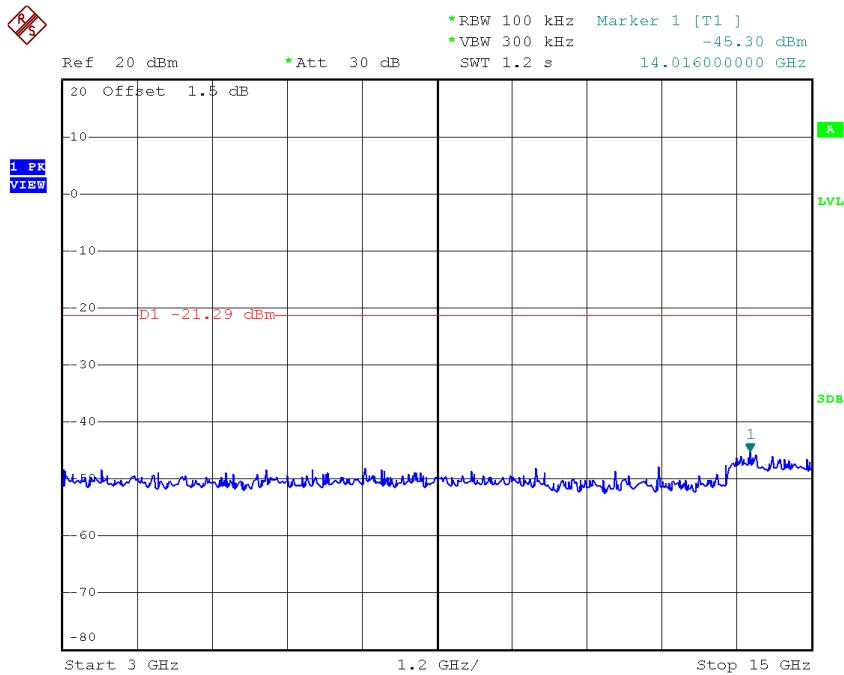

Date: 14.AUG.2016 11:56:10



*REW 100 kHz Marker 1 [T1]
*VEW 300 kHz -41.77 dBm
Ref 20 dBm *Att 30 dB SWT 1.15 s 26.454000000 GHz

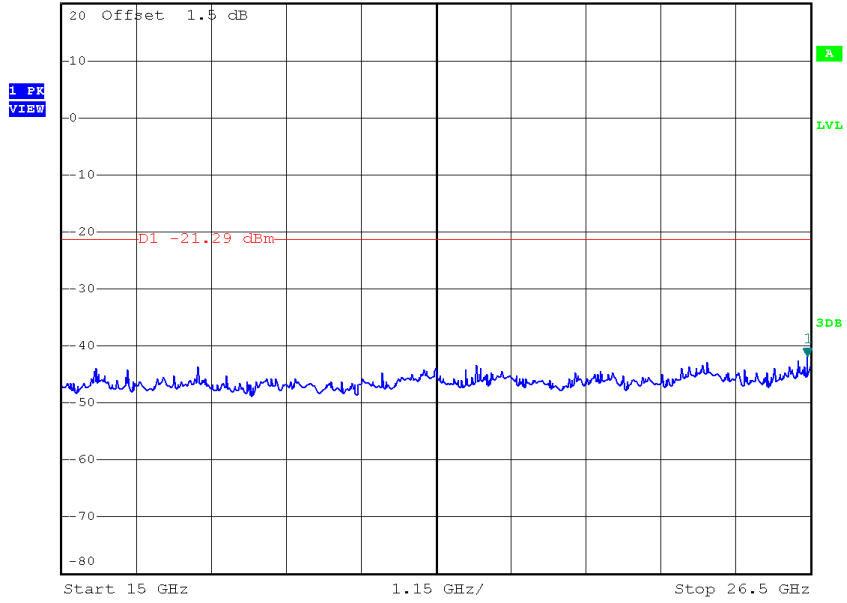

Date: 14.AUG.2016 11:56:18

Test Mode : TX B Mode_ANT 2

TX B mode CH01

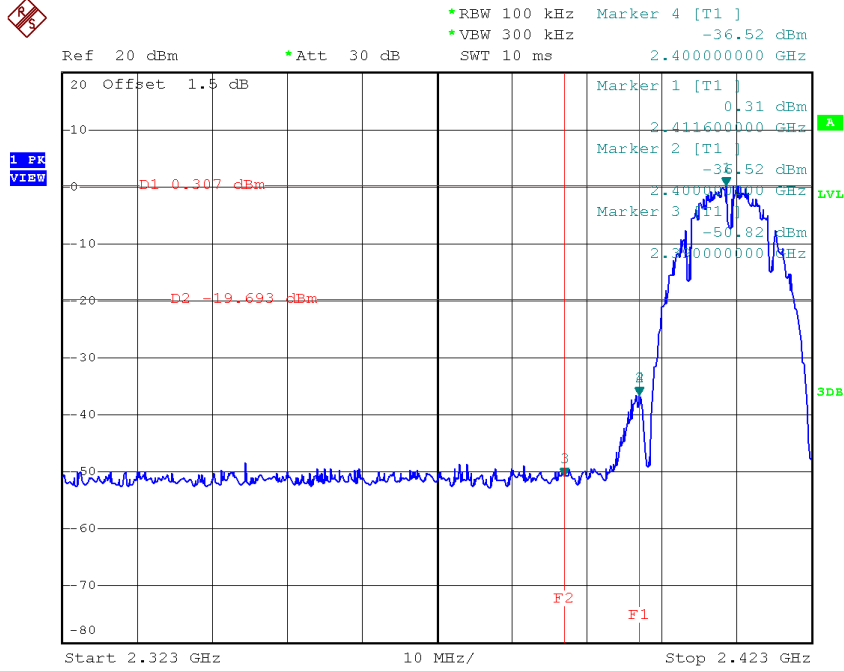

Date: 14.AUG.2016 11:58:28

TX B mode CH11

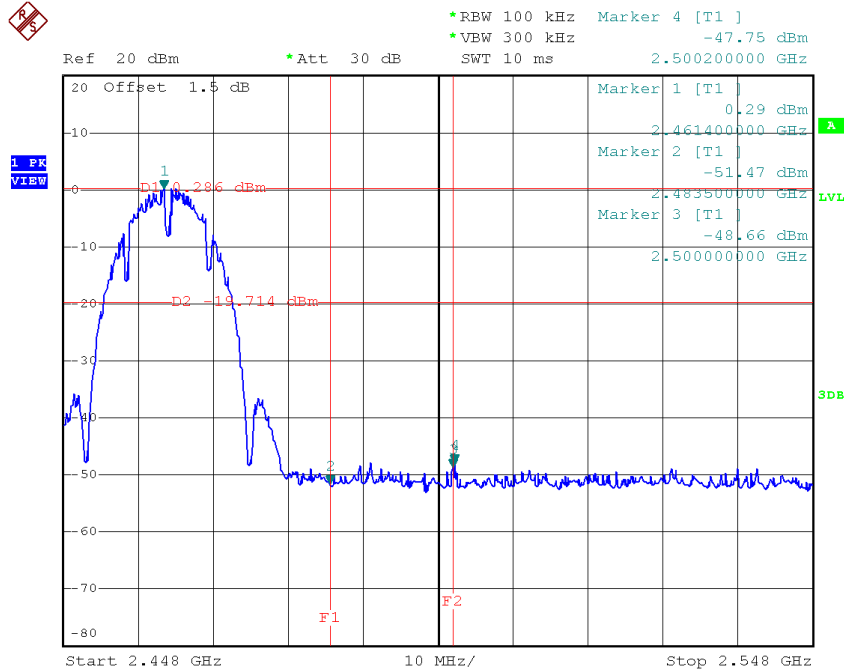

Date: 14.AUG.2016 12:02:33

TX B mode CH01 (10 Harmonic of the frequency)



*REW 100 kHz Marker 2 [T1]
*VBW 300 kHz -47.78 dBm
SWT 300 ms 2.126820000 GHz

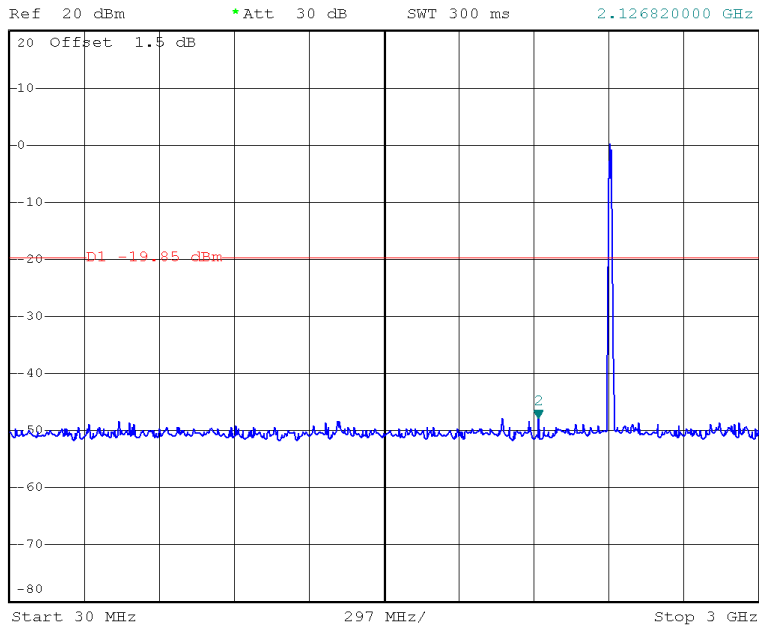

Date: 14.AUG.2016 11:58:04



*REW 100 kHz Marker 1 [T1]
*VBW 300 kHz -45.61 dBm
SWT 1.2 s 14.016000000 GHz

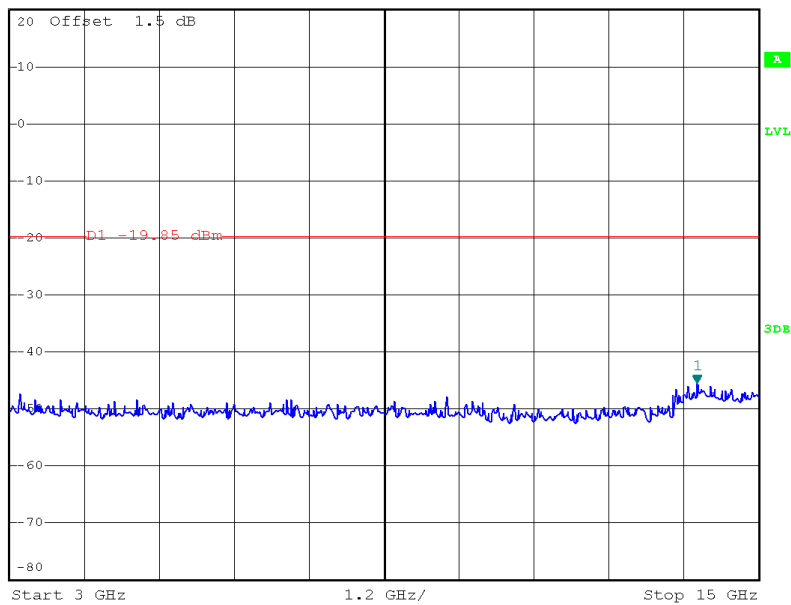

Date: 14.AUG.2016 11:58:12

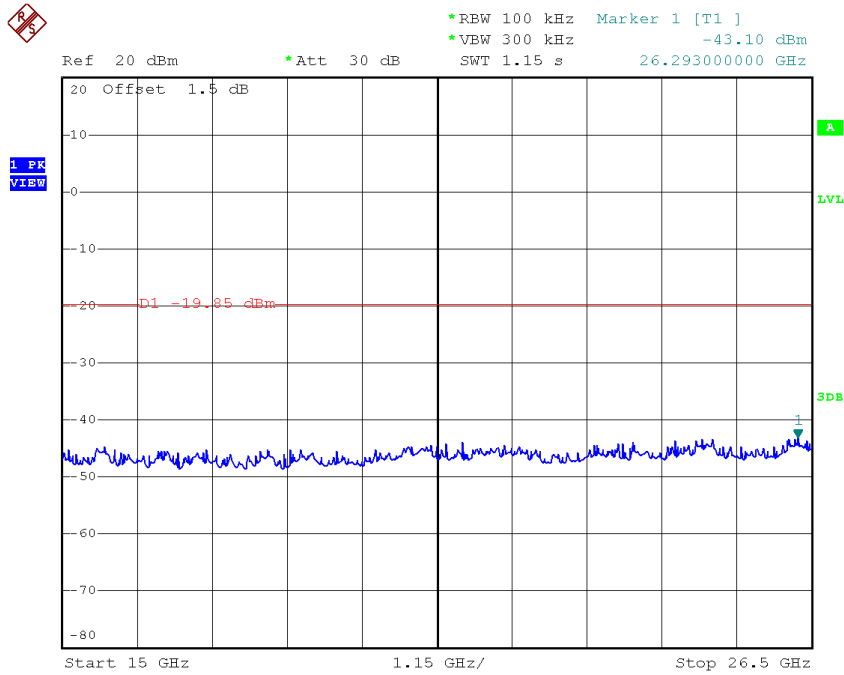

Date: 14.AUG.2016 11:58:20

TX B mode CH06 (10 Harmonic of the frequency)

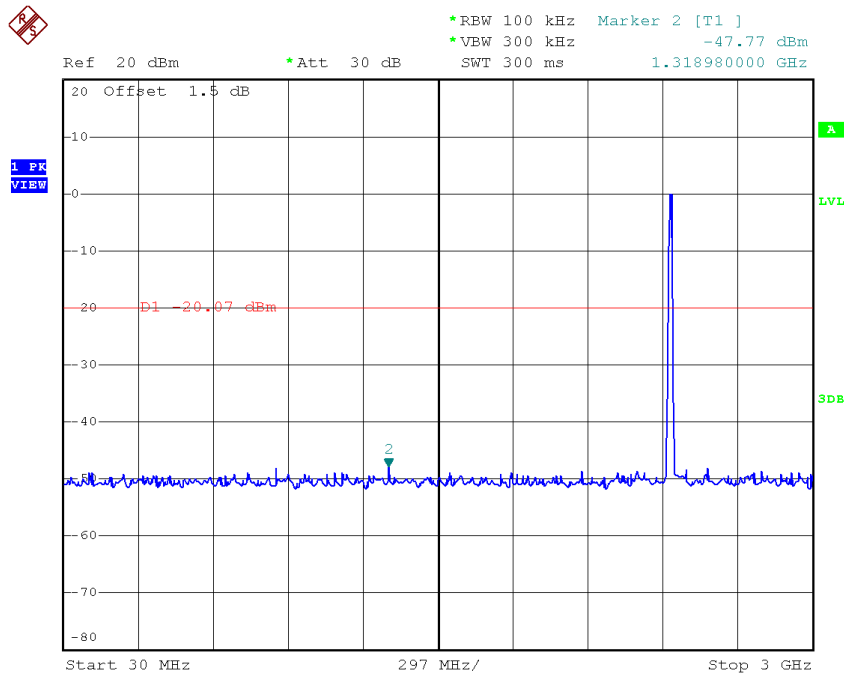

Date: 14.AUG.2016 12:00:35



Ref 20 dBm *Att 30 dB *RBW 100 kHz Marker 1 [T1]
*VEW 300 kHz -45.53 dBm
SWT 1.2 s 14.04000000 GHz

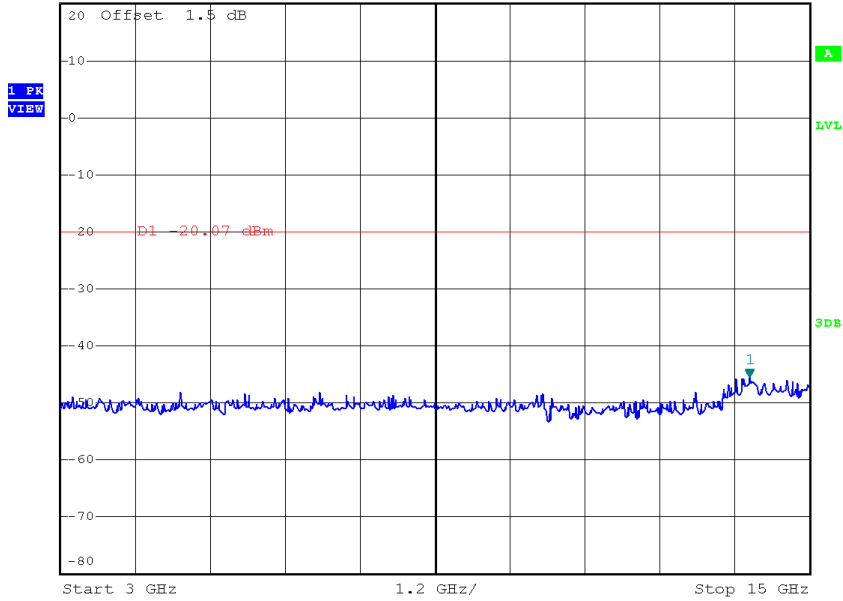

Date: 14.AUG.2016 12:00:43



Ref 20 dBm *Att 30 dB *RBW 100 kHz Marker 1 [T1]
*VEW 300 kHz -42.55 dBm
SWT 1.15 s 26.33900000 GHz

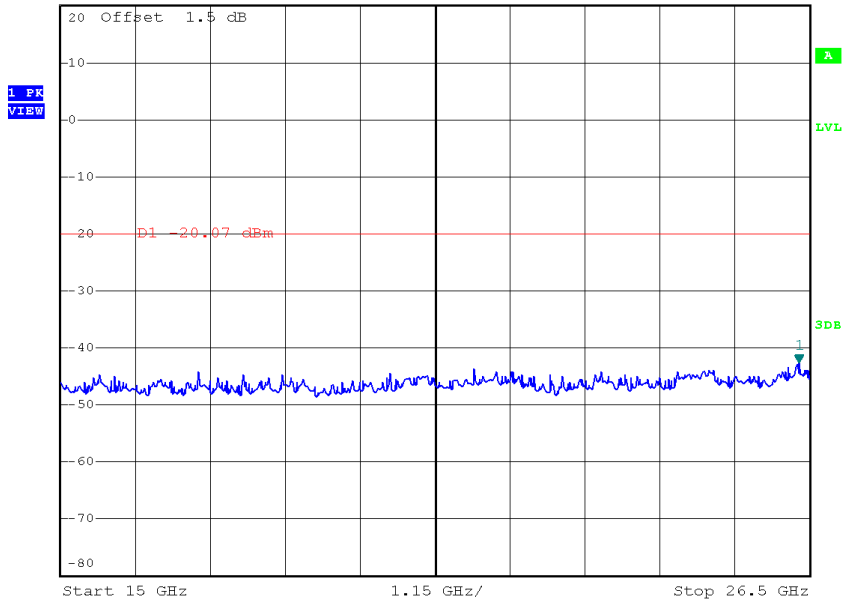

Date: 14.AUG.2016 12:00:52

TX B mode CH11 (10 Harmonic of the frequency)

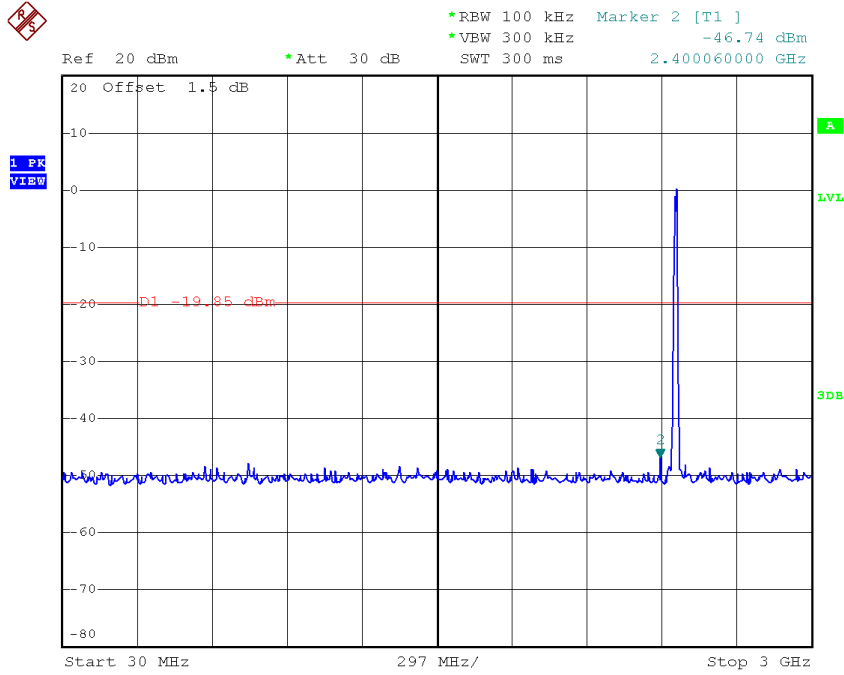

Date: 14.AUG.2016 12:02:09

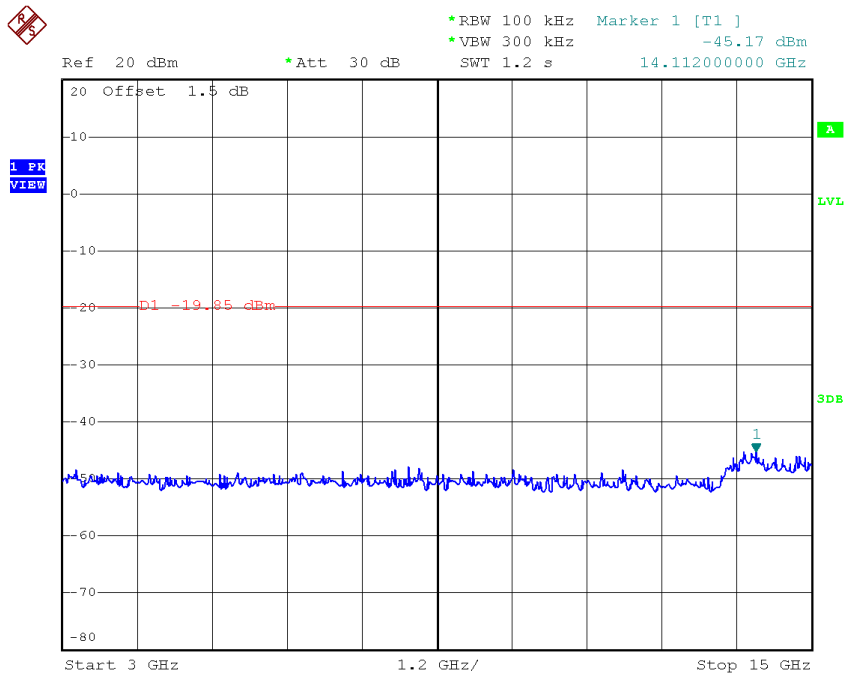

Date: 14.AUG.2016 12:02:17

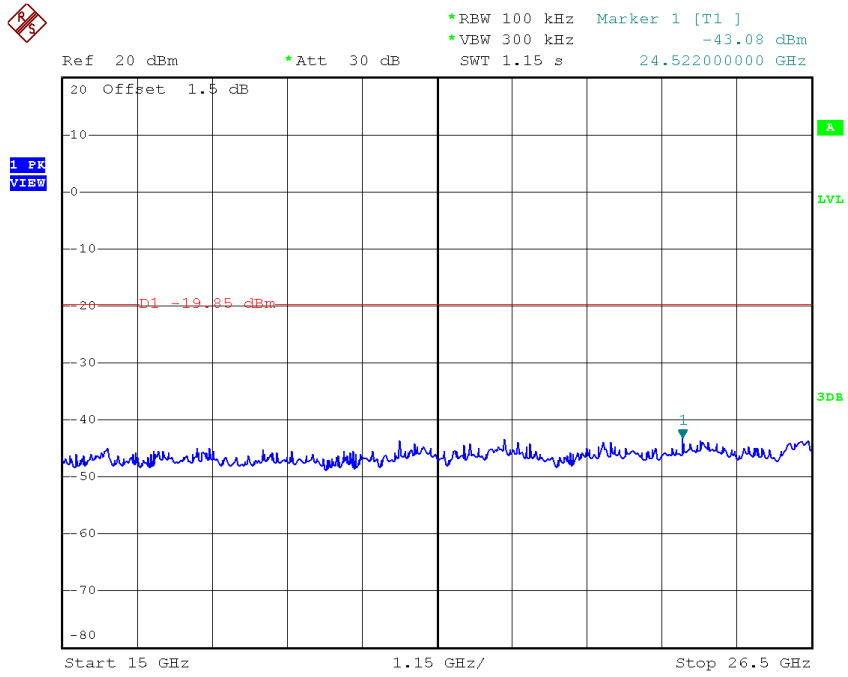

Date: 14.AUG.2016 12:02:26

Test Mode : TX G Mode_ANT 1

TX G mode CH01

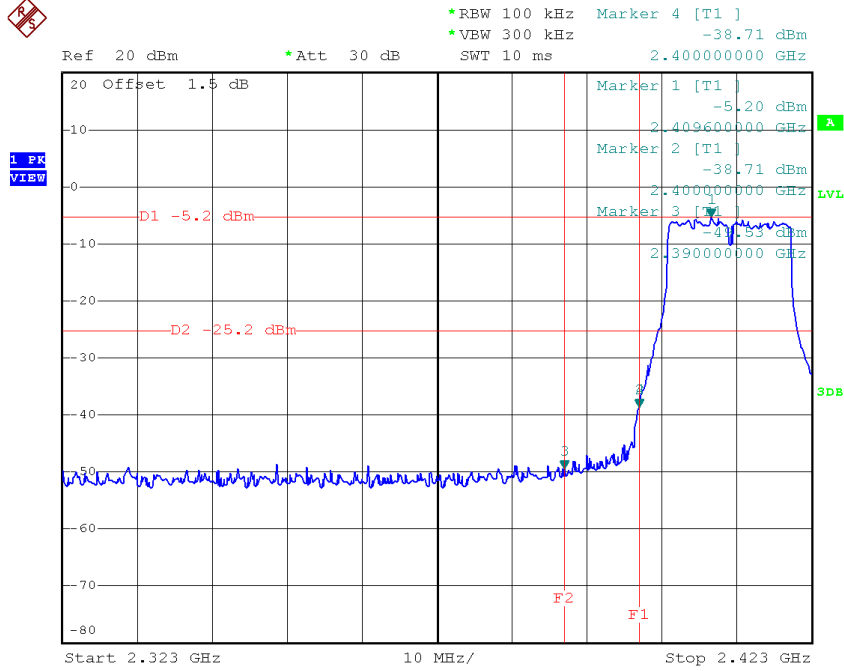

Date: 14.AUG.2016 12:05:17

TX G mode CH11

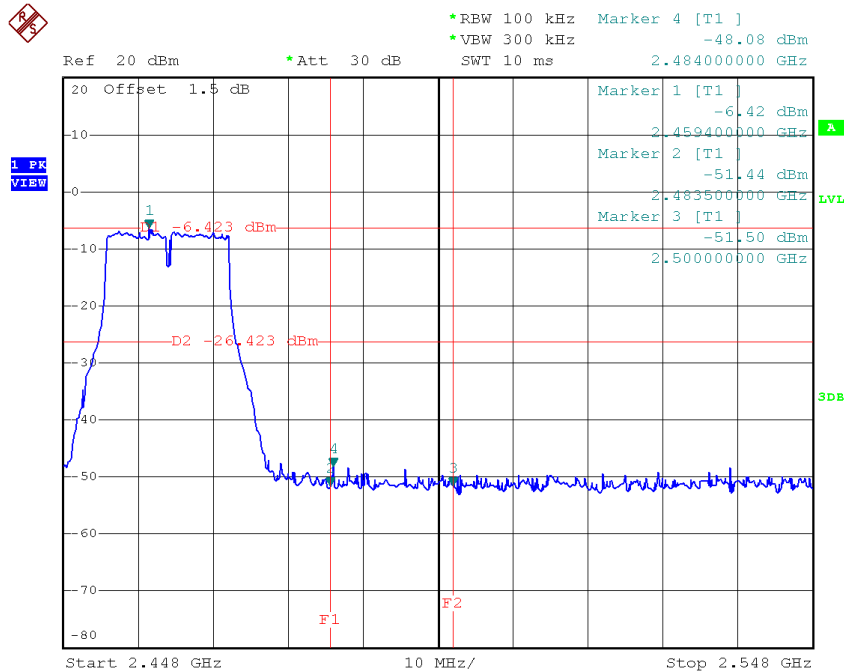

Date: 14.AUG.2016 12:08:08

TX G mode CH01 (10 Harmonic of the frequency)



Ref 20 dBm *Att 30 dB *REW 100 kHz Marker 2 [T1]
 *VBW 300 kHz -47.95 dBm
 SWT 300 ms 849.720000000 MHz

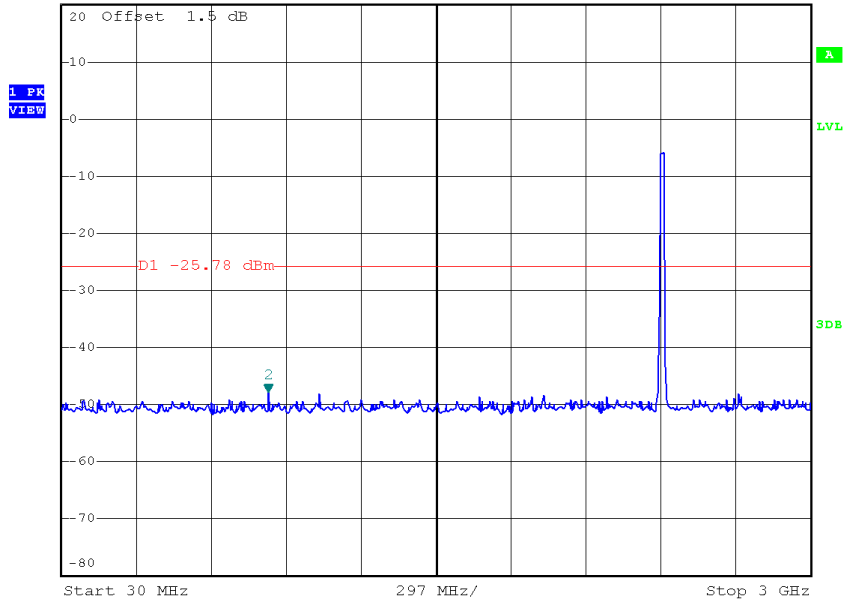

Date: 14.AUG.2016 12:04:53



Ref 20 dBm *Att 30 dB *REW 100 kHz Marker 1 [T1]
 *VBW 300 kHz -45.36 dBm
 SWT 1.2 s 14.040000000 GHz

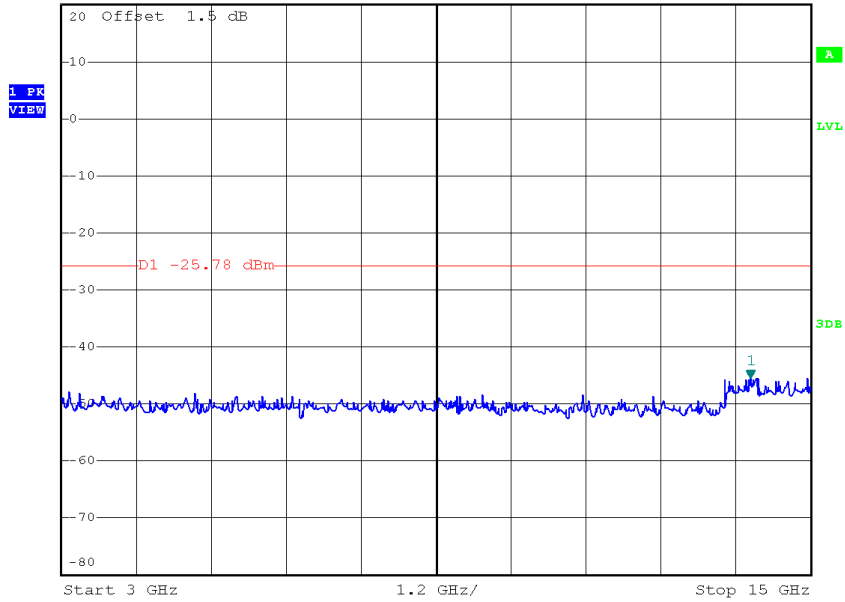

Date: 14.AUG.2016 12:05:01

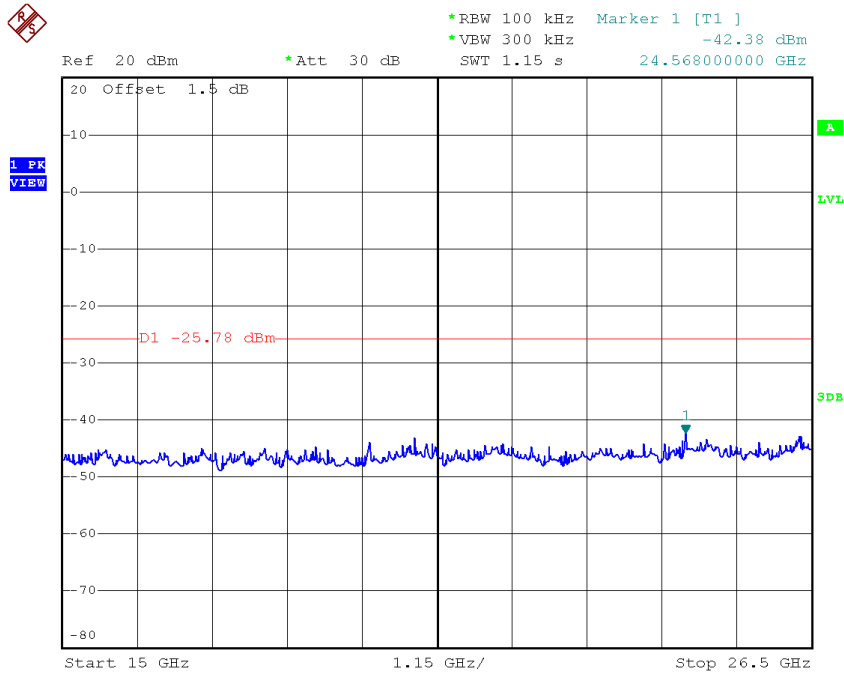

Date: 14.AUG.2016 12:05:10

TX G mode CH06 (10 Harmonic of the frequency)

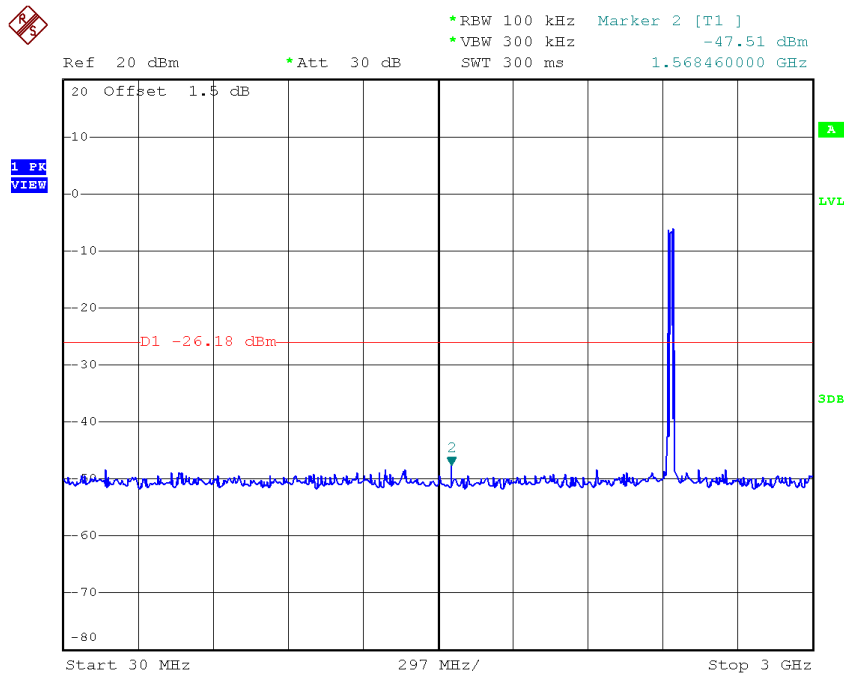

Date: 14.AUG.2016 12:06:36



*RBW 100 kHz Marker 1 [T1]
*VEW 300 kHz -44.48 dBm
Ref 20 dBm *Att 30 dB SWT 1.2 s 13.848000000 GHz

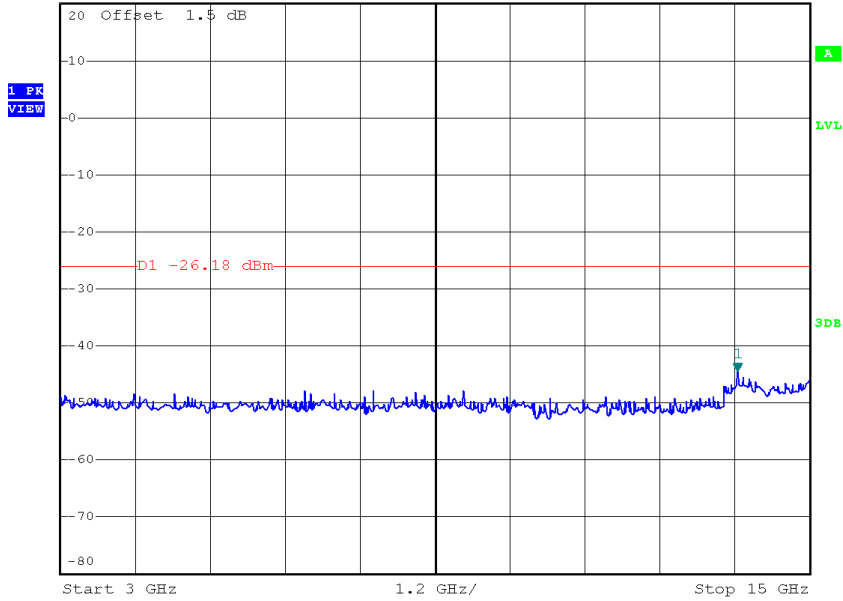

Date: 14.AUG.2016 12:06:44



*RBW 100 kHz Marker 1 [T1]
*VEW 300 kHz -41.65 dBm
Ref 20 dBm *Att 30 dB SWT 1.15 s 26.270000000 GHz

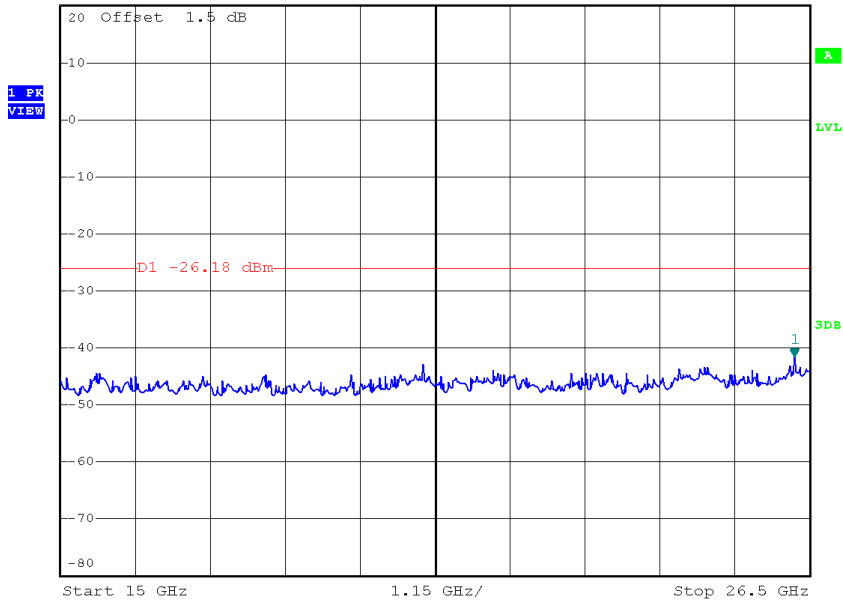

Date: 14.AUG.2016 12:06:53

TX G mode CH11 (10 Harmonic of the frequency)

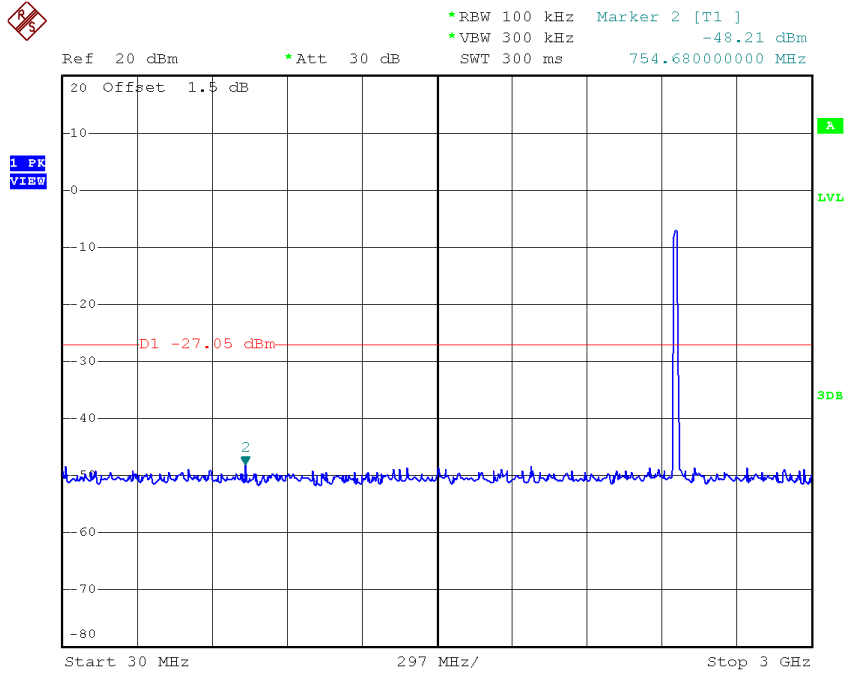

Date: 14.AUG.2016 12:07:43

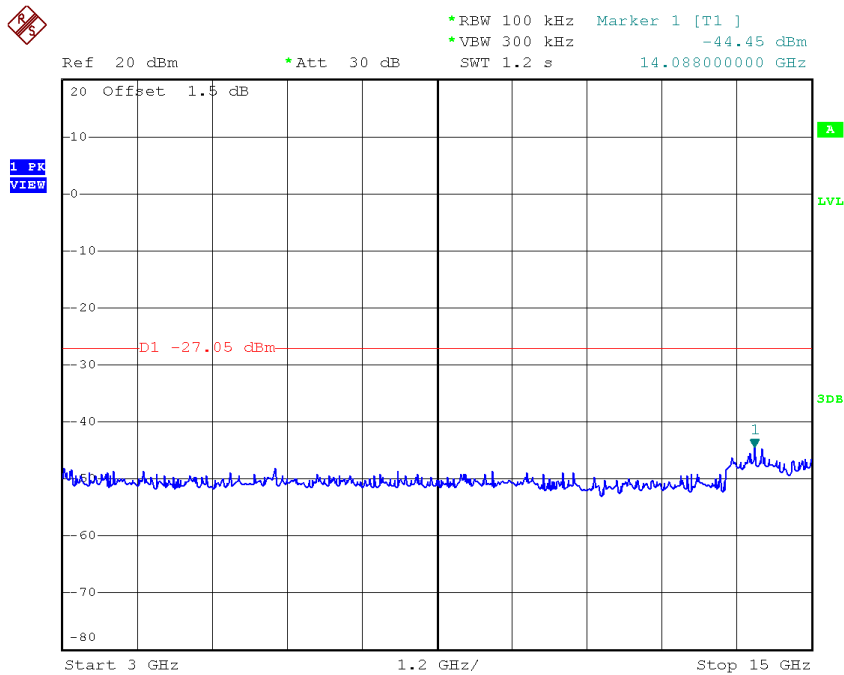

Date: 14.AUG.2016 12:07:52



*REW 100 kHz Marker 1 [T1]
*VEW 300 kHz -42.61 dBm
SWT 1.15 s 26.270000000 GHz

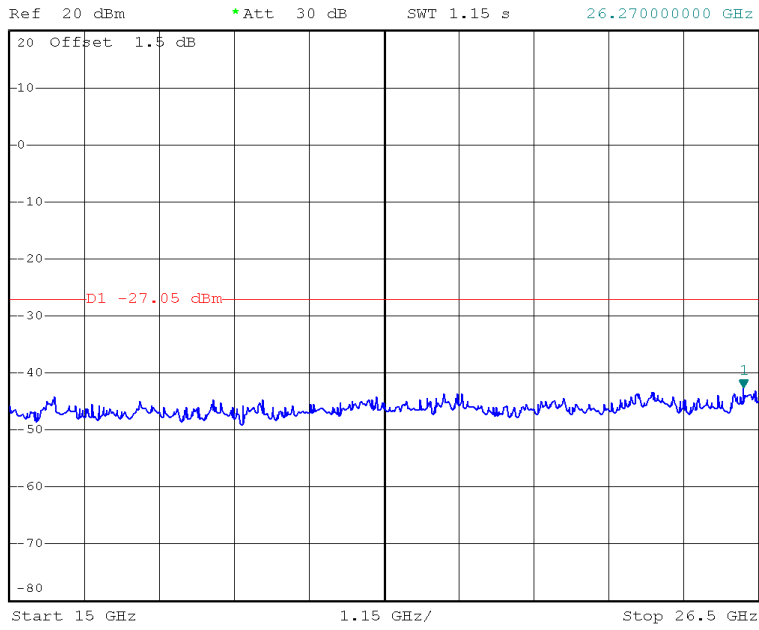

Date: 14.AUG.2016 12:08:00

Test Mode : TX G Mode_ANT 2

TX G mode CH01

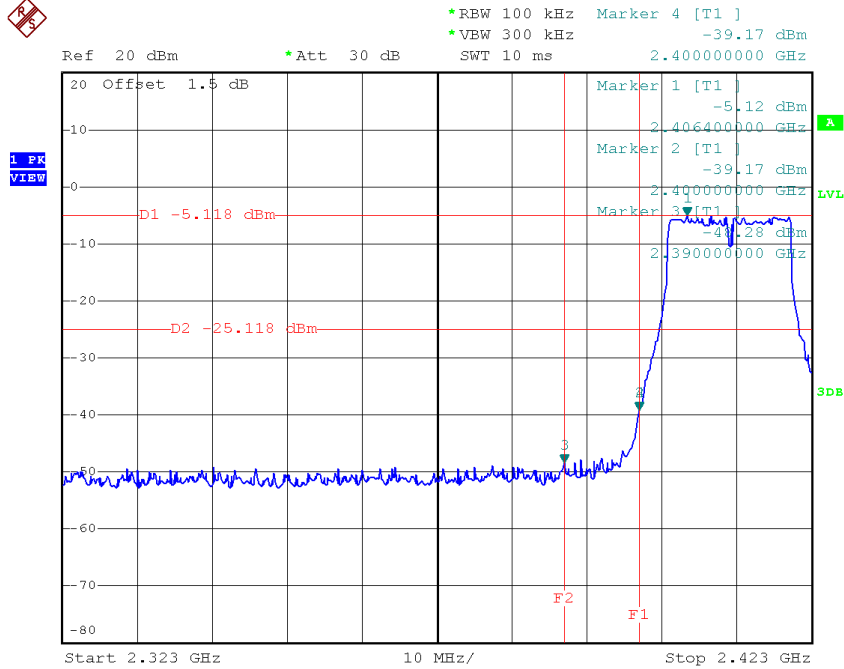

Date: 14.AUG.2016 12:09:38

TX G mode CH11

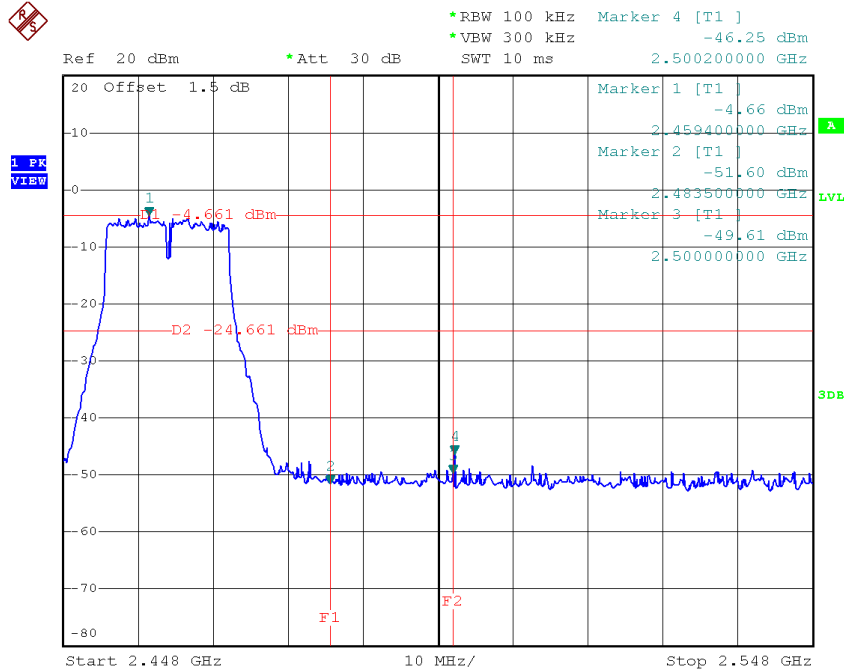

Date: 14.AUG.2016 12:13:08

TX G mode CH01 (10 Harmonic of the frequency)

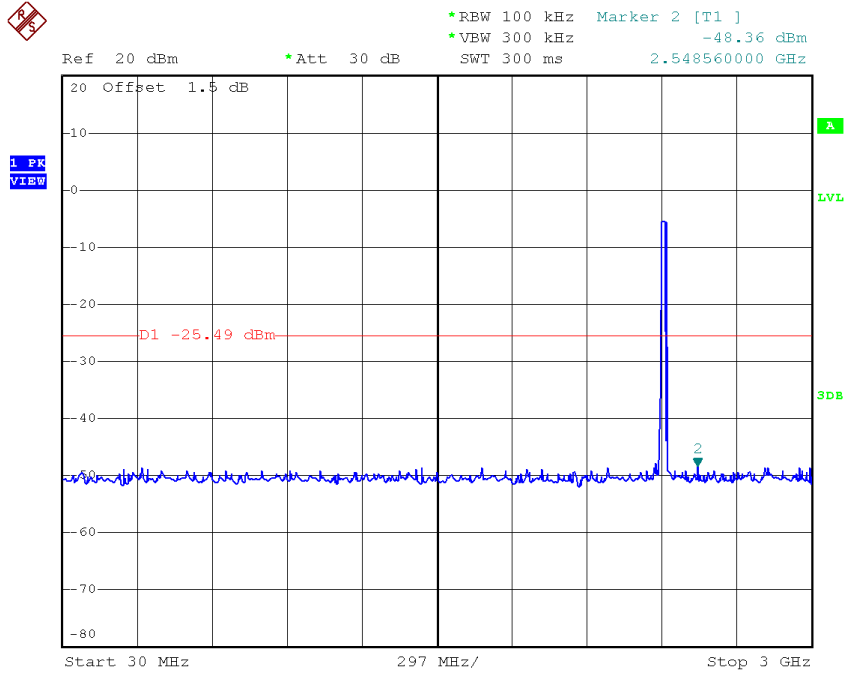

Date: 14.AUG.2016 12:09:14

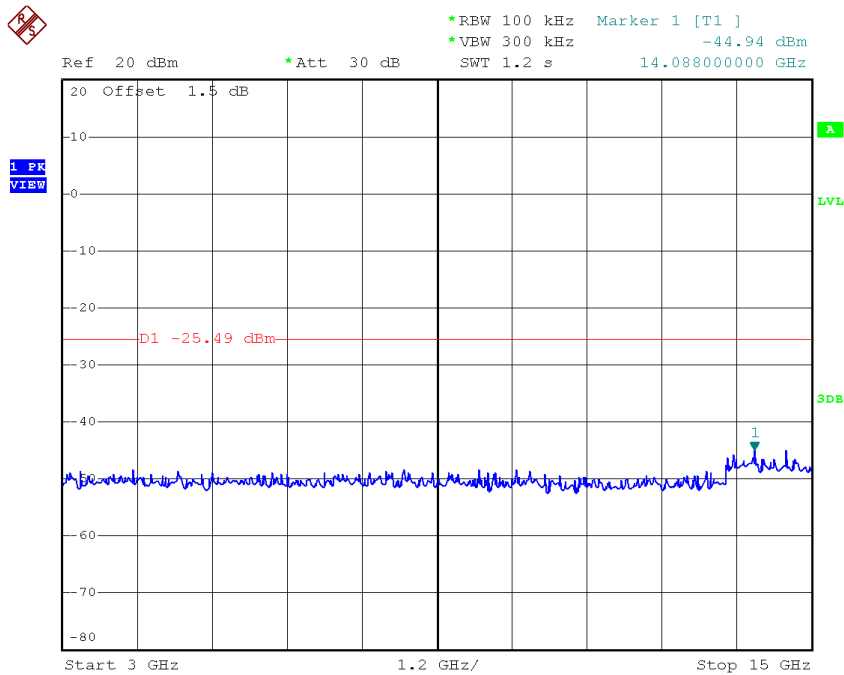

Date: 14.AUG.2016 12:09:22

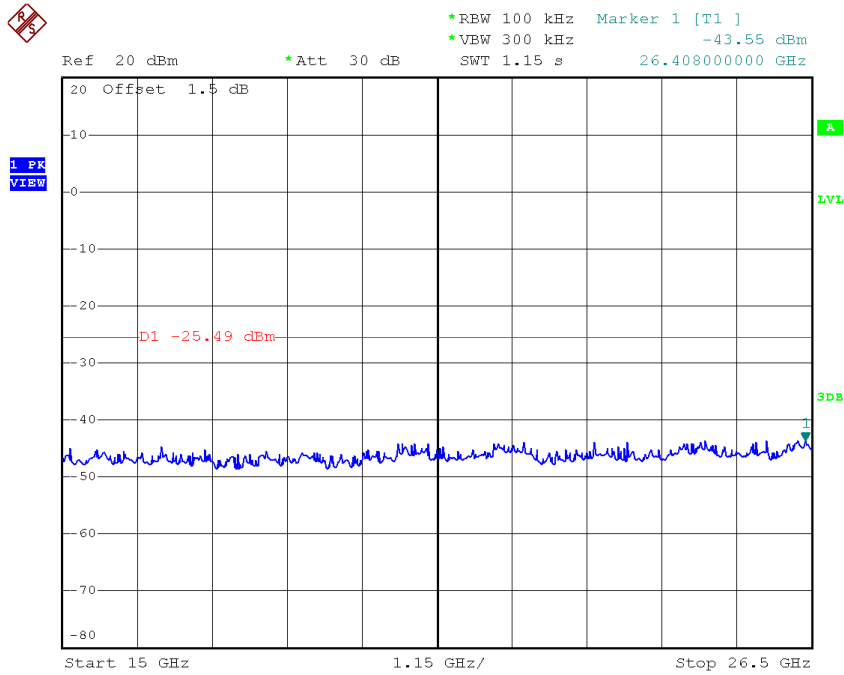

Date: 14.AUG.2016 12:09:30

TX G mode CH06 (10 Harmonic of the frequency)

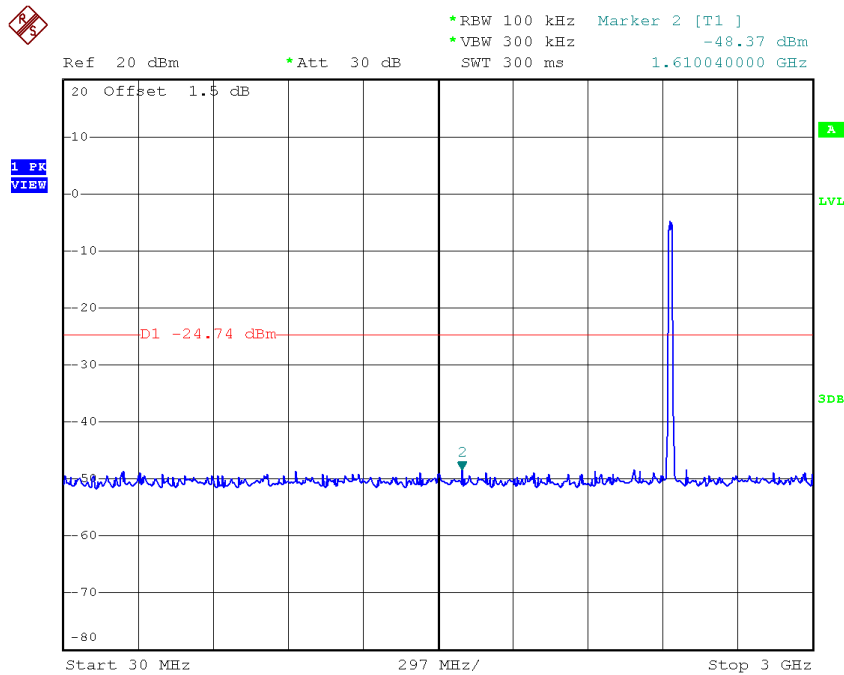

Date: 14.AUG.2016 12:11:02



Ref 20 dBm *Att 30 dB *RBW 100 kHz Marker 1 [T1]
*VEW 300 kHz -45.46 dBm
SWT 1.2 s 14.016000000 GHz

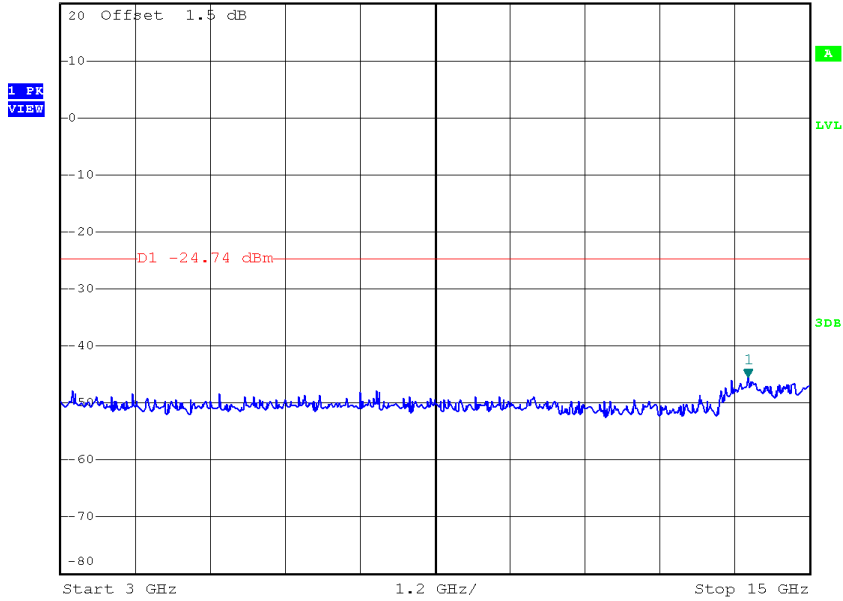

Date: 14.AUG.2016 12:11:11



Ref 20 dBm *Att 30 dB *RBW 100 kHz Marker 1 [T1]
*VEW 300 kHz -43.44 dBm
SWT 1.15 s 26.339000000 GHz

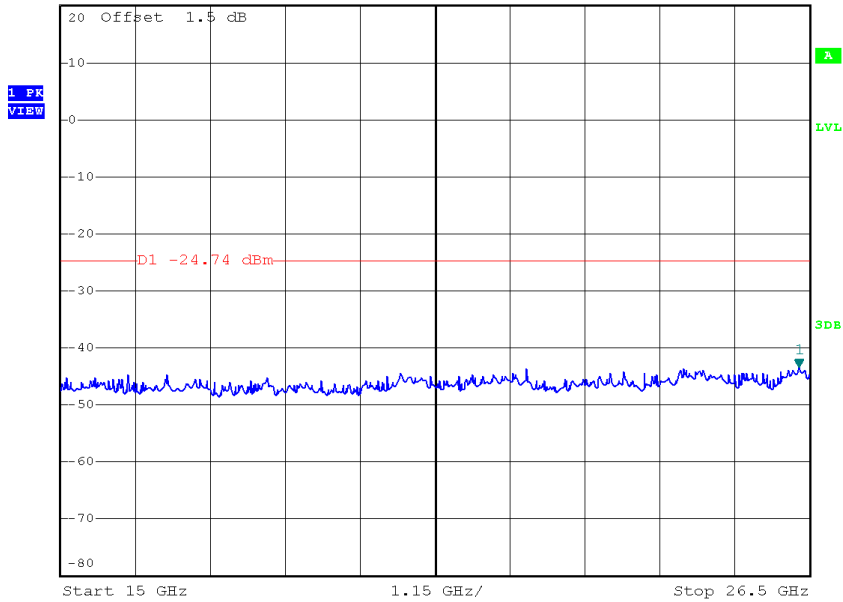

Date: 14.AUG.2016 12:11:19

TX G mode CH11 (10 Harmonic of the frequency)

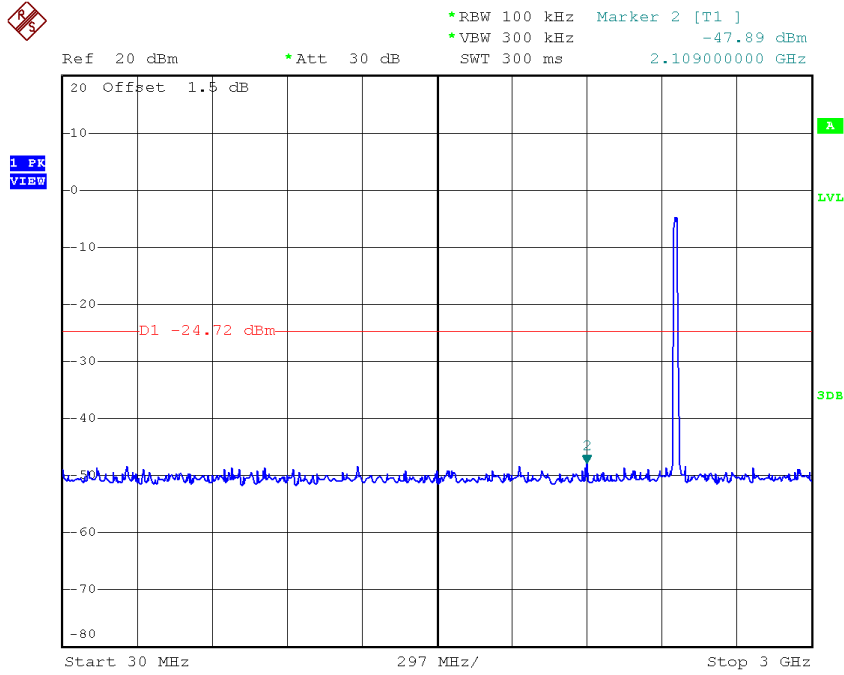

Date: 14.AUG.2016 12:12:44

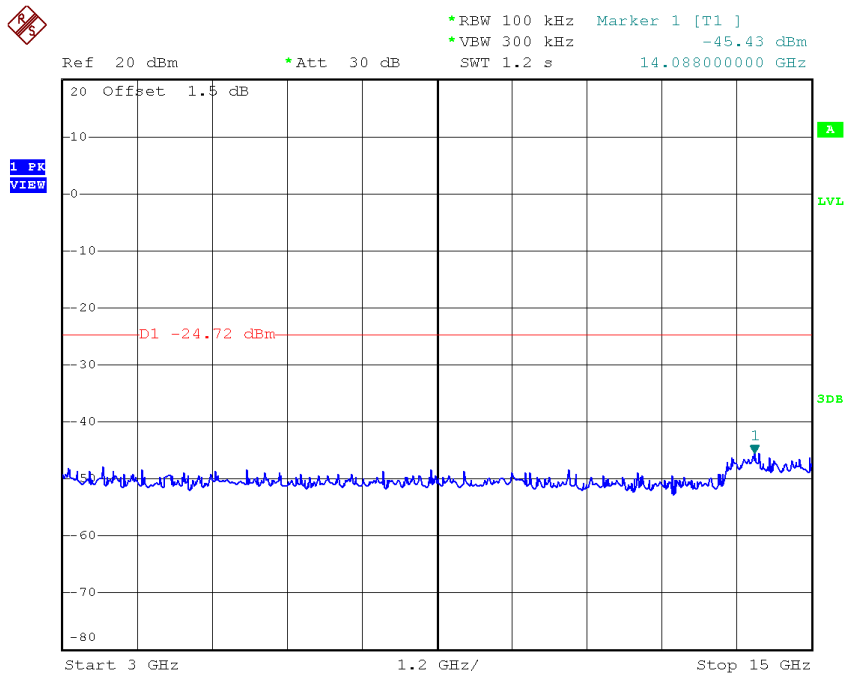

Date: 14.AUG.2016 12:12:52

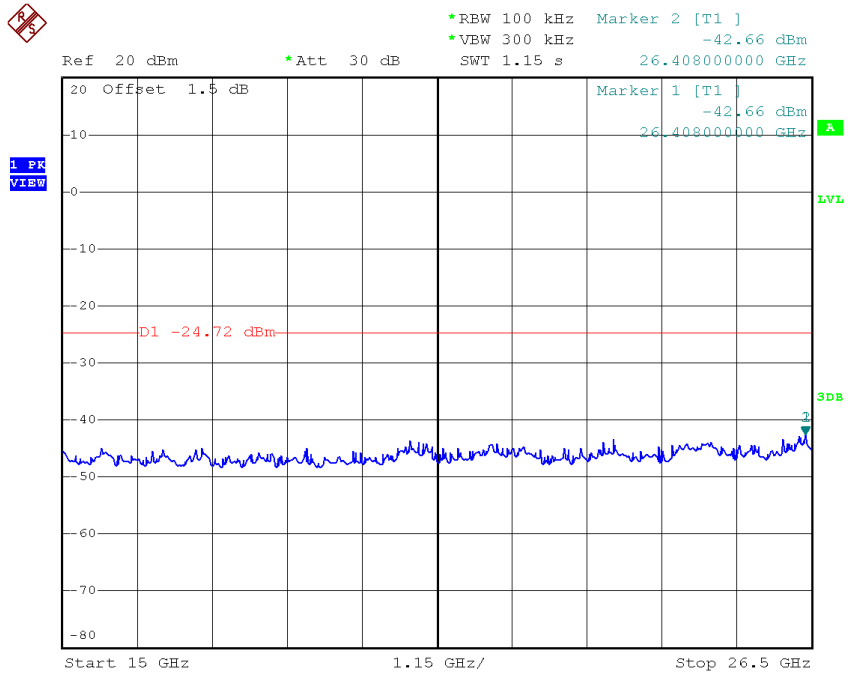

Date: 14.AUG.2016 12:13:00

Test Mode : TX N-20M Mode_ANT 1

TX HT20 mode CH01

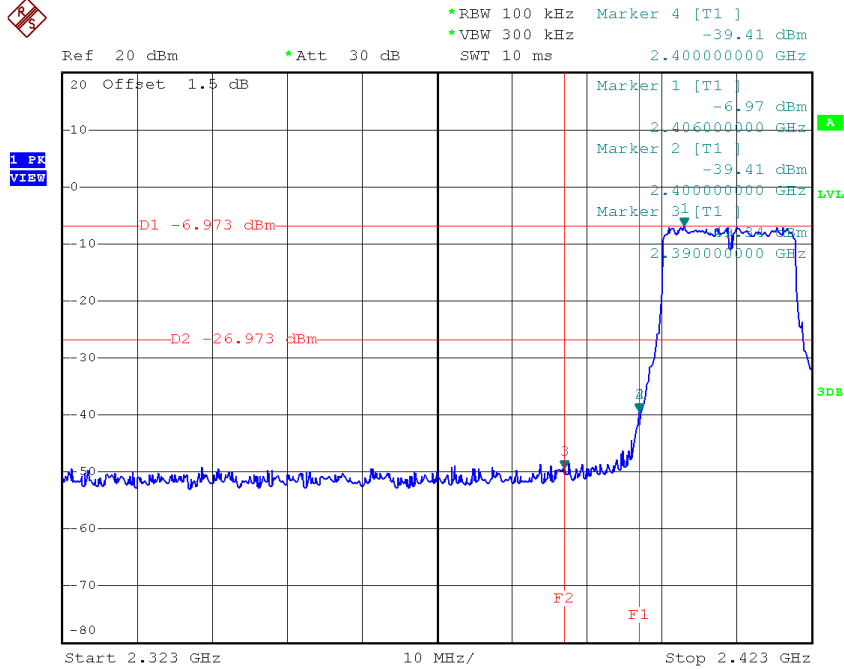

Date: 14.AUG.2016 12:15:18

TX HT20 mode CH11

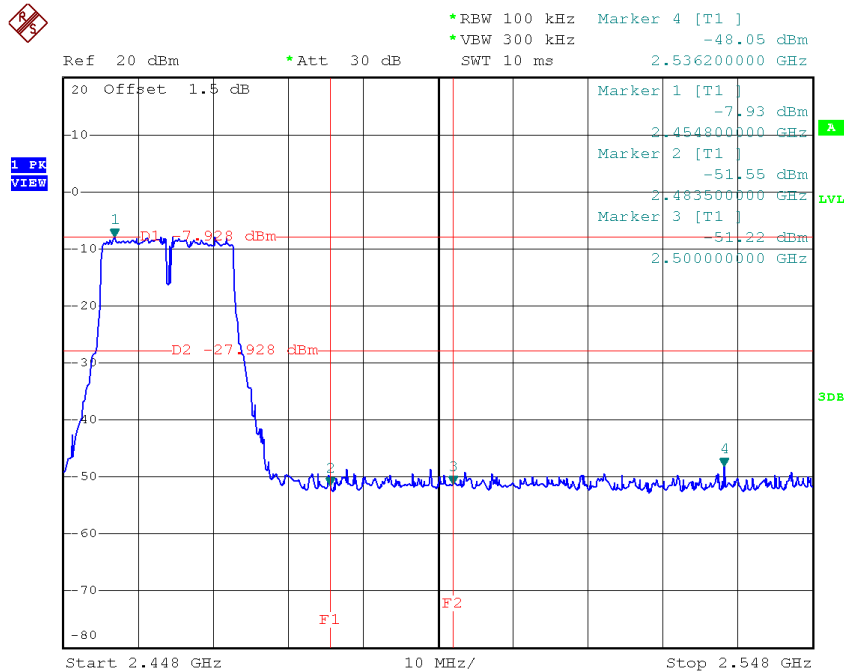

Date: 14.AUG.2016 12:21:13

TX HT20 mode CH01 (10 Harmonic of the frequency)



Ref 20 dBm *Att 30 dB *REW 100 kHz Marker 2 [T1]
*VBW 300 kHz -48.09 dBm
SWT 300 ms 2.322840000 GHz

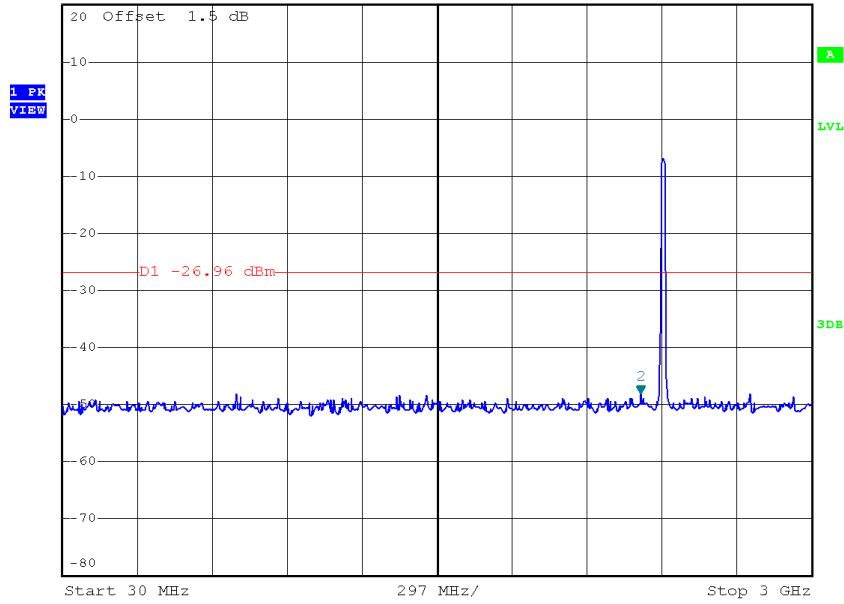

Date: 14.AUG.2016 12:14:54



Ref 20 dBm *Att 30 dB *REW 100 kHz Marker 1 [T1]
*VBW 300 kHz -45.40 dBm
SWT 1.2 s 13.968000000 GHz

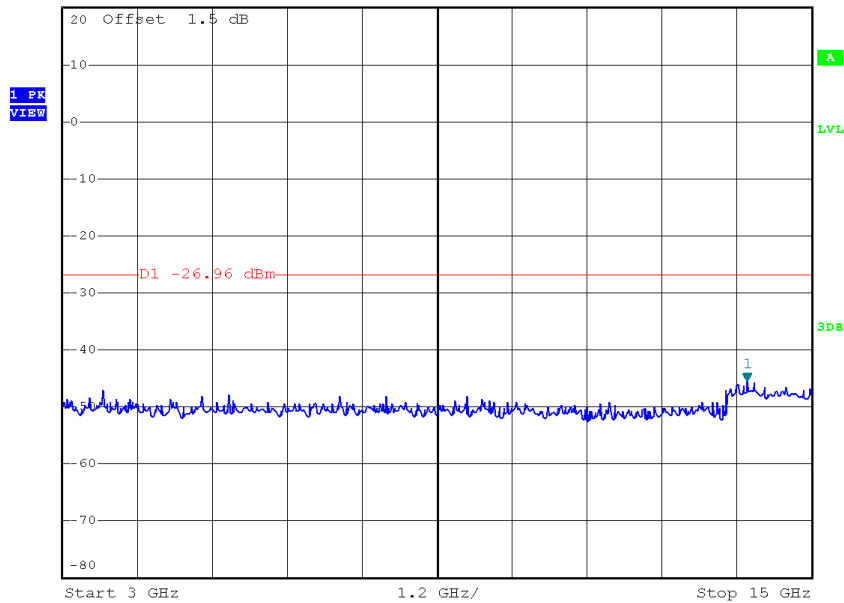

Date: 14.AUG.2016 12:15:02

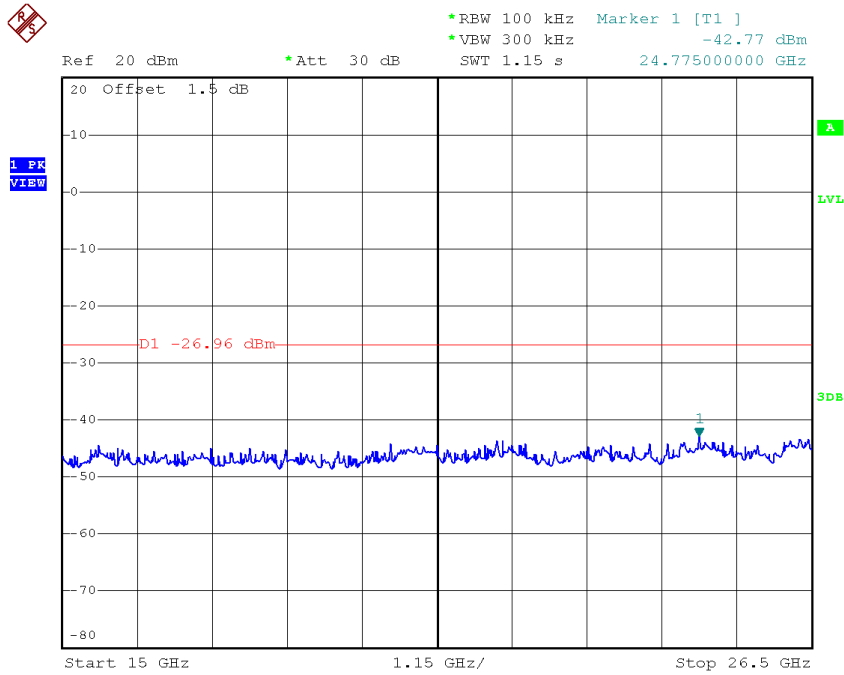

Date: 14.AUG.2016 12:15:11

TX HT20 mode CH06 (10 Harmonic of the frequency)

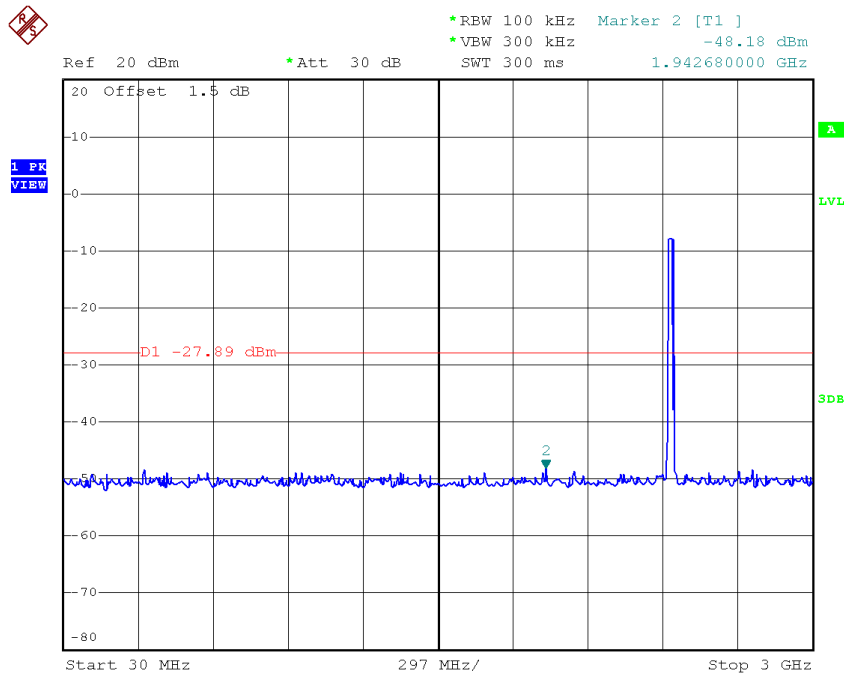

Date: 14.AUG.2016 12:17:26



*RBW 100 kHz Marker 1 [T1]
*VEW 300 kHz -45.47 dBm
Ref 20 dBm *Att 30 dB SWT 1.2 s 14.832000000 GHz

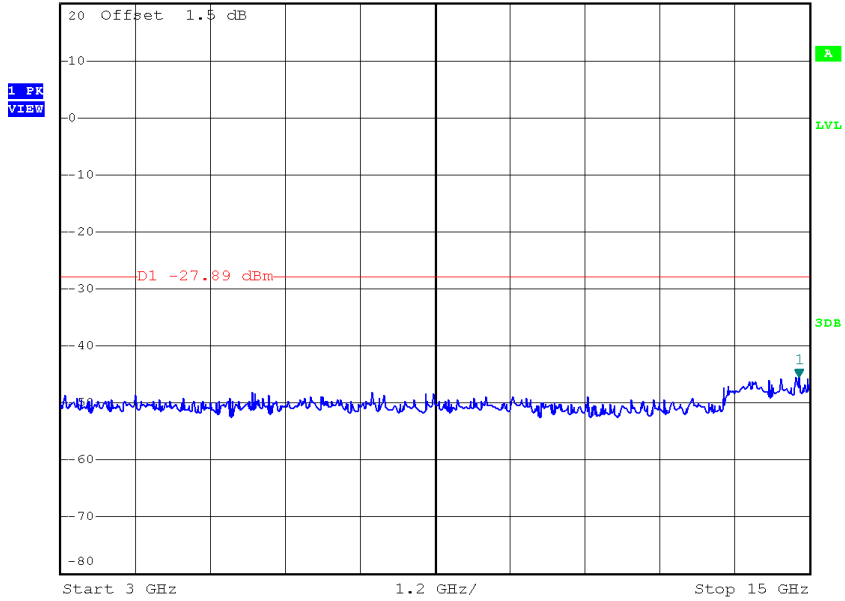

Date: 14.AUG.2016 12:17:34



*RBW 100 kHz Marker 1 [T1]
*VEW 300 kHz -42.90 dBm
Ref 20 dBm *Att 30 dB SWT 1.15 s 26.431000000 GHz

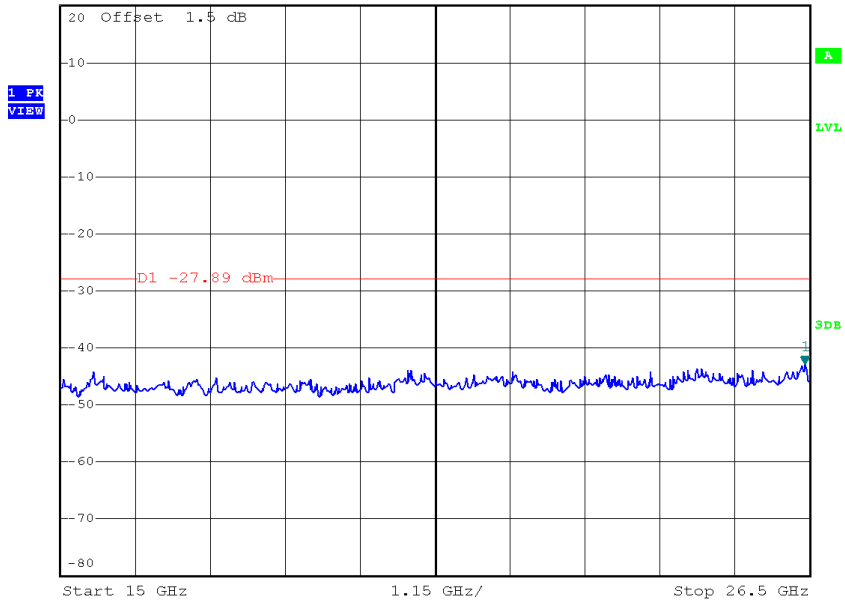

Date: 14.AUG.2016 12:17:51

TX HT20 mode CH11 (10 Harmonic of the frequency)



Ref 20 dBm *Att 30 dB *REW 100 kHz Marker 2 [T1]
*VBW 300 kHz -48.11 dBm
SWT 300 ms 2.400060000 GHz

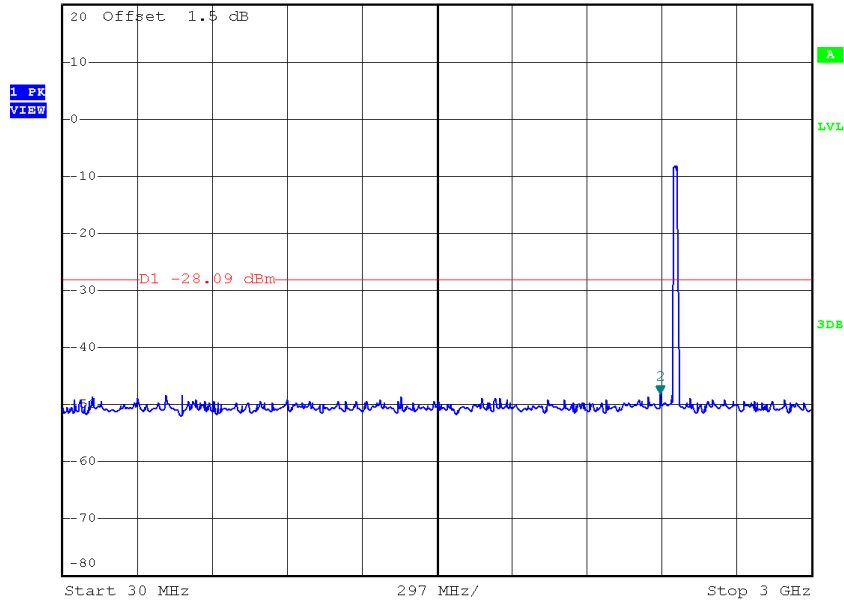

Date: 14.AUG.2016 12:20:49



Ref 20 dBm *Att 30 dB *REW 100 kHz Marker 1 [T1]
*VBW 300 kHz -44.24 dBm
SWT 1.2 s 14.160000000 GHz

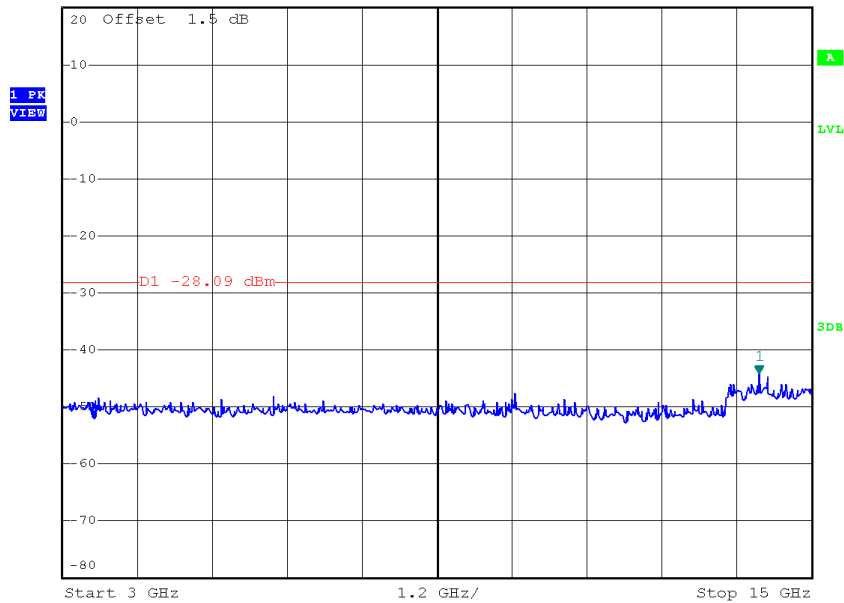

Date: 14.AUG.2016 12:20:57

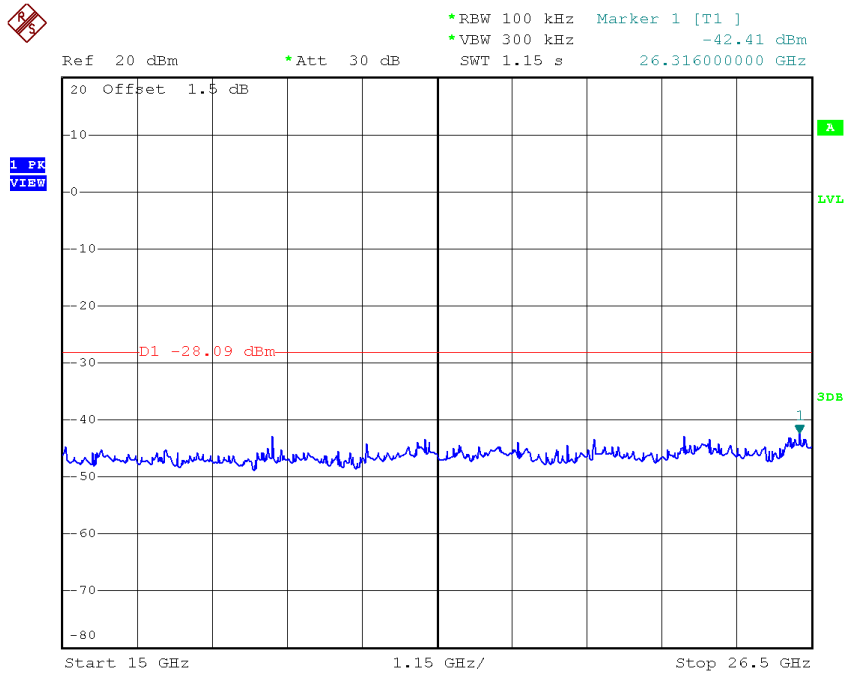

Date: 14.AUG.2016 12:21:06

Test Mode : TX N-20M Mode_ANT 2

TX HT20 mode CH01

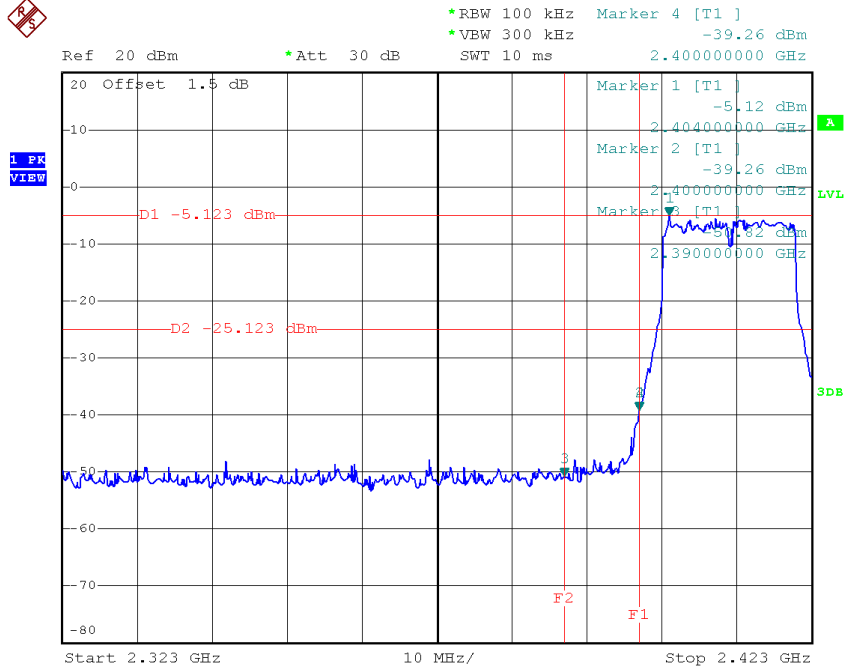

Date: 14.AUG.2016 12:23:47

TX HT20 mode CH11

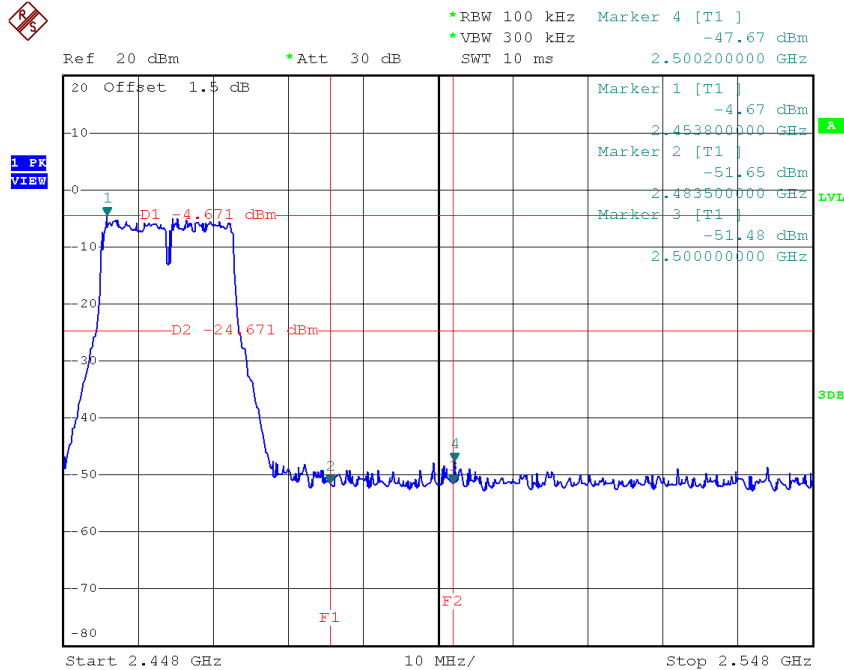

Date: 14.AUG.2016 12:27:55

TX HT20 mode CH01 (10 Harmonic of the frequency)



Ref 20 dBm *Att 30 dB *REW 100 kHz Marker 2 [T1]
*VBW 300 kHz -46.84 dBm
SWT 300 ms 2.501040000 GHz

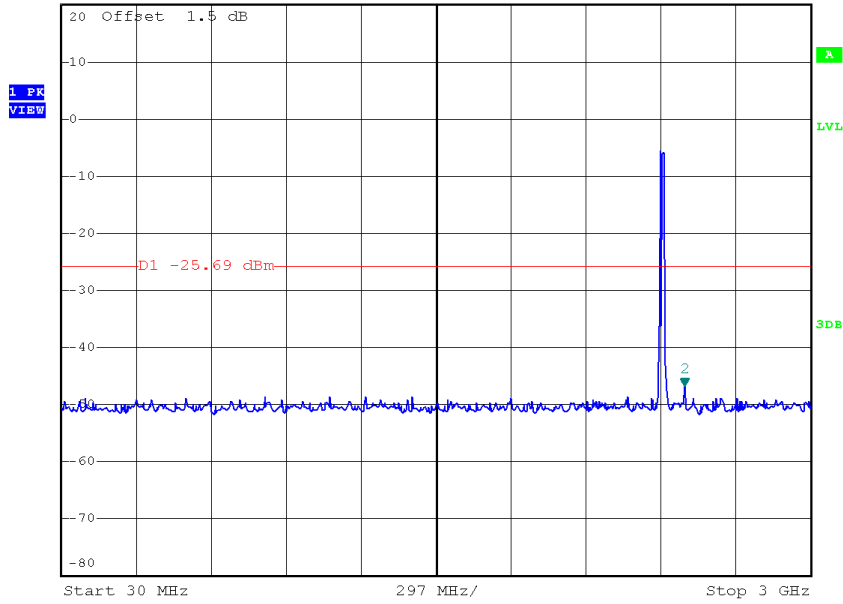

Date: 14.AUG.2016 12:23:23



Ref 20 dBm *Att 30 dB *REW 100 kHz Marker 1 [T1]
*VBW 300 kHz -44.50 dBm
SWT 1.2 s 14.256000000 GHz

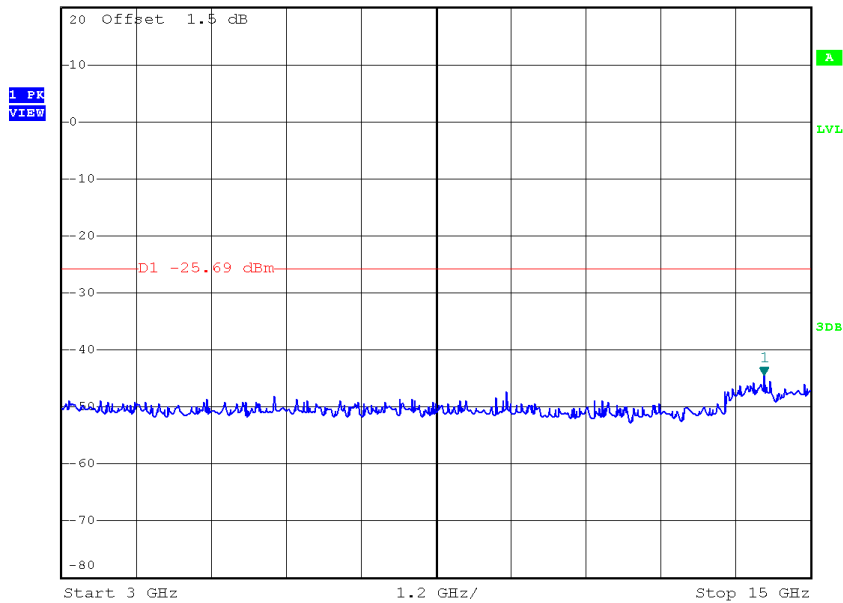

Date: 14.AUG.2016 12:23:31

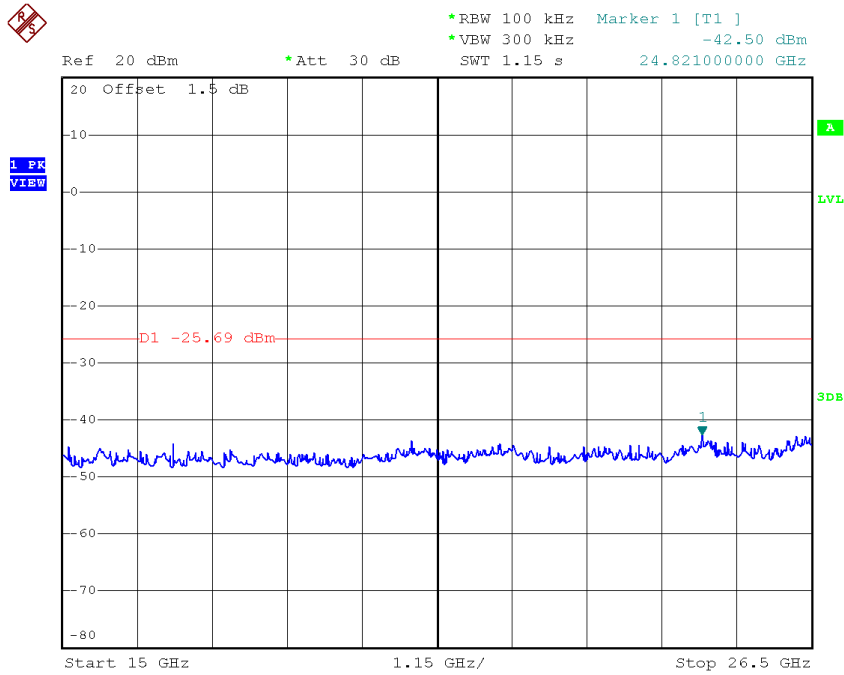

Date: 14.AUG.2016 12:23:40

TX HT20 mode CH06 (10 Harmonic of the frequency)

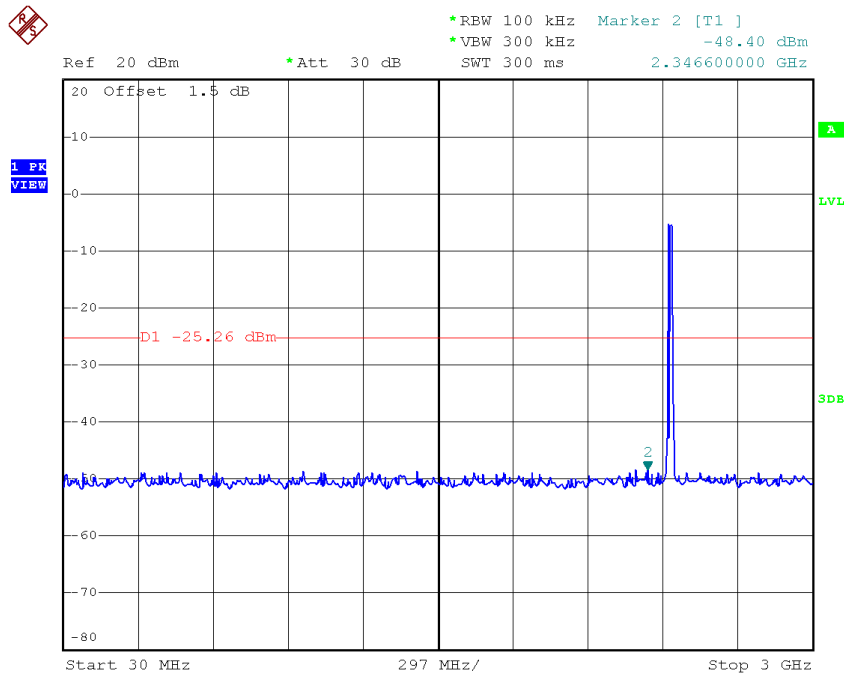

Date: 14.AUG.2016 12:26:11



Ref 20 dBm *Att 30 dB *RBW 100 kHz Marker 1 [T1]
*VEW 300 kHz -45.52 dBm
SWT 1.2 s 13.848000000 GHz

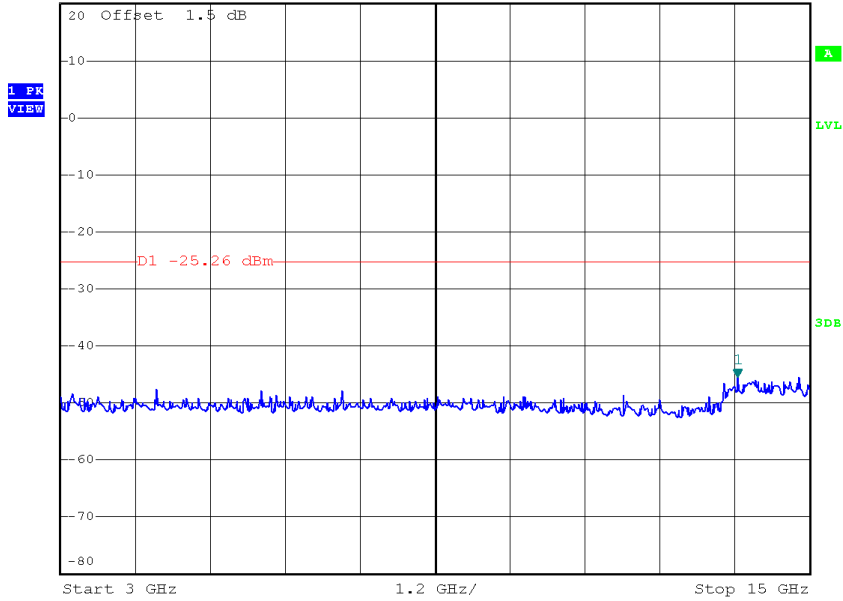

Date: 14.AUG.2016 12:26:19



Ref 20 dBm *Att 30 dB *RBW 100 kHz Marker 1 [T1]
*VEW 300 kHz -42.10 dBm
SWT 1.15 s 23.349000000 GHz

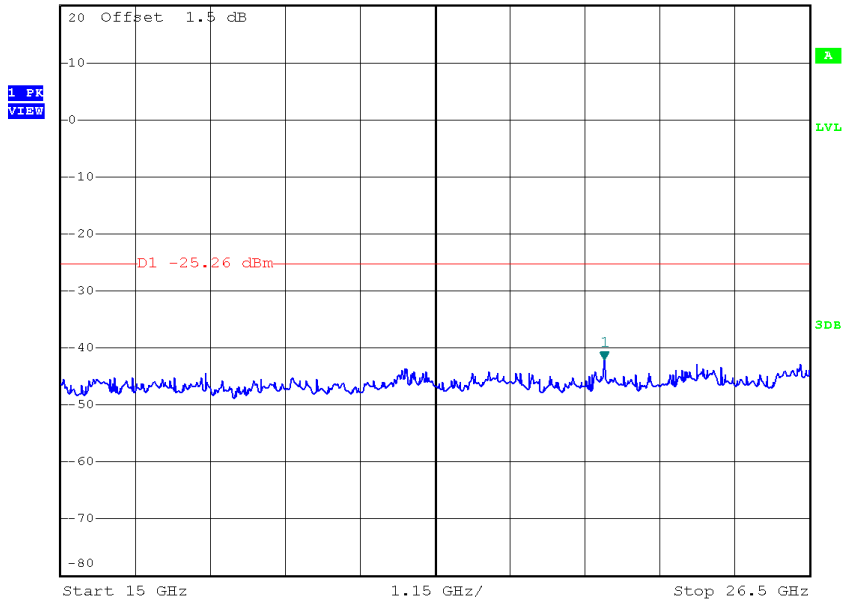

Date: 14.AUG.2016 12:26:28

TX HT20 mode CH11 (10 Harmonic of the frequency)



Ref 20 dBm *Att 30 dB SWT 300 ms
*REW 100 kHz Marker 2 [T1] -47.81 dBm
*VBW 300 kHz 1.455600000 GHz

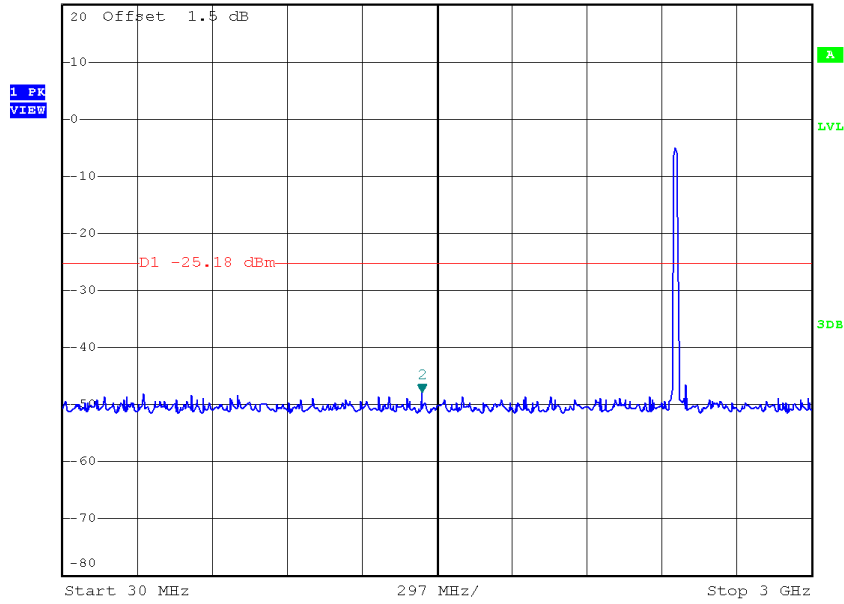

Date: 14.AUG.2016 12:27:31



Ref 20 dBm *Att 30 dB SWT 1.2 s
*REW 100 kHz Marker 1 [T1] -45.54 dBm
*VBW 300 kHz 14.016000000 GHz

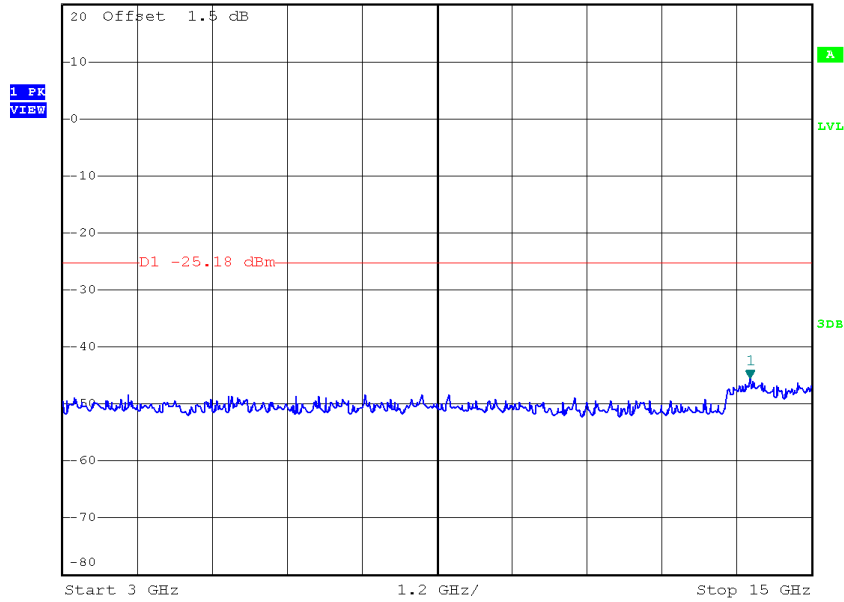

Date: 14.AUG.2016 12:27:39



*REW 100 kHz Marker 1 [T1]
*VEW 300 kHz -43.46 dBm
Ref 20 dBm *Att 30 dB SWT 1.15 s 26.293000000 GHz

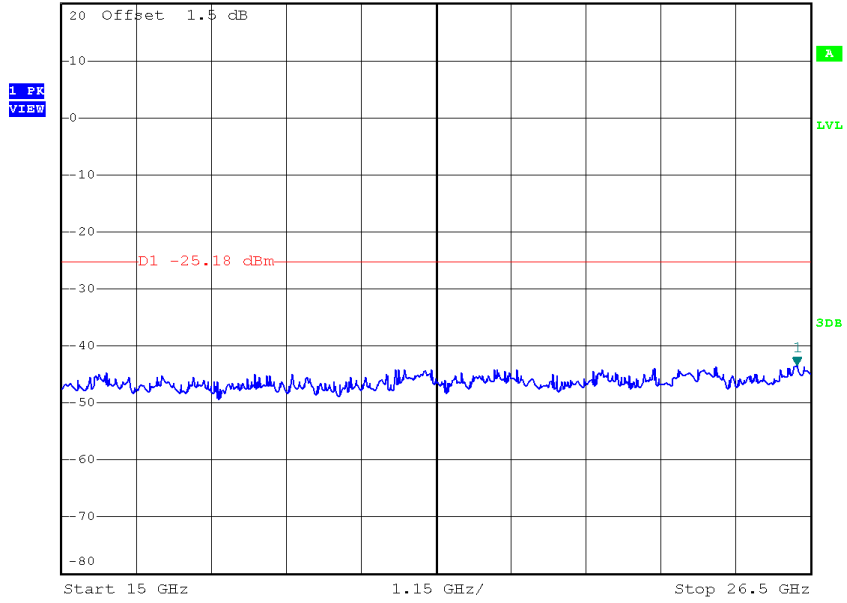

Date: 14.AUG.2016 12:27:48

Test Mode : TX N-40M Mode_ANT 1

TX HT40 mode CH03

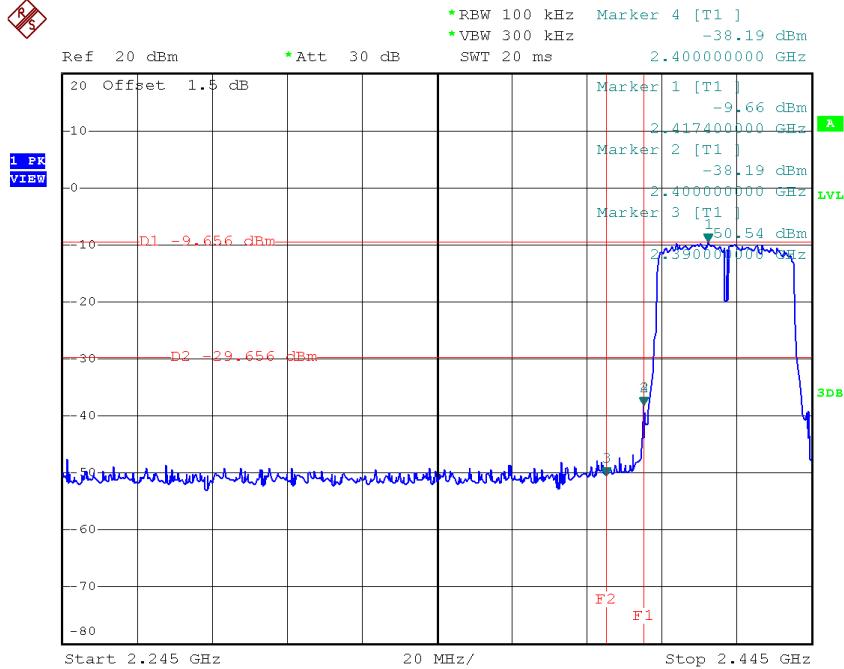

Date: 14.AUG.2016 12:29:58

TX HT40 mode CH09

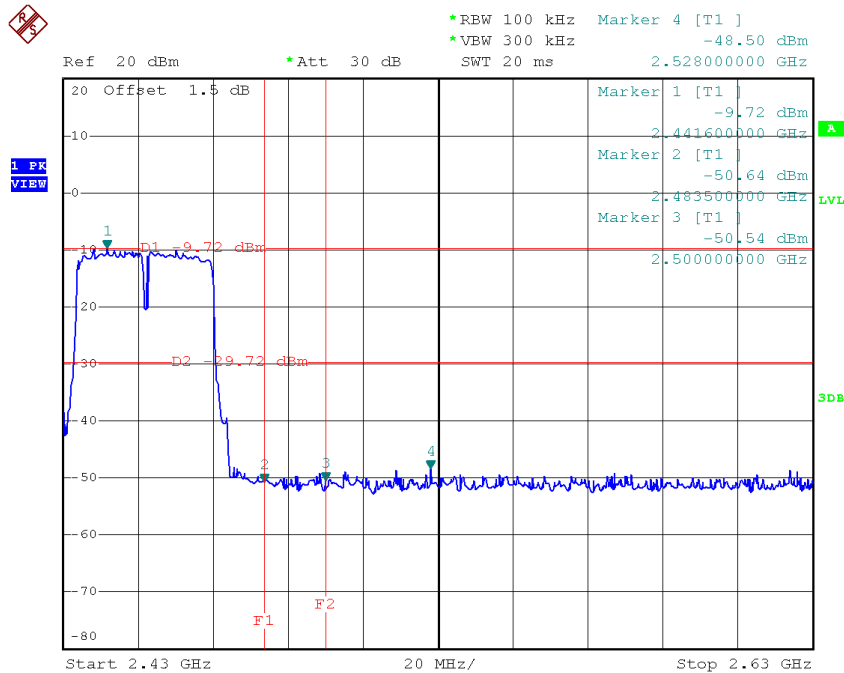

Date: 14.AUG.2016 12:47:17

TX HT40 mode CH03 (10 Harmonic of the frequency)



Ref 20 dBm *Att 30 dB *REW 100 kHz Marker 2 [T1]
*VBW 300 kHz -47.80 dBm
SWT 300 ms 237.900000000 MHz

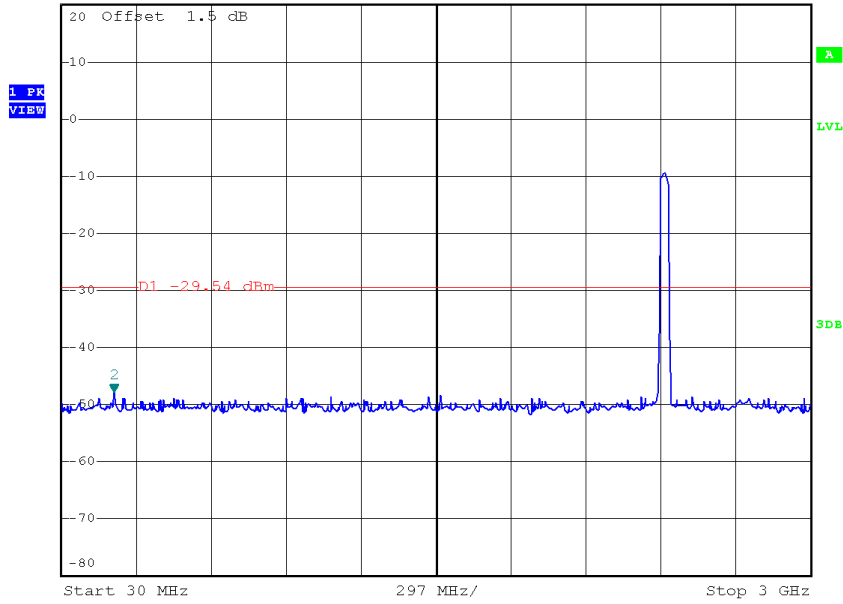

Date: 14.AUG.2016 12:29:33



Ref 20 dBm *Att 30 dB *REW 100 kHz Marker 1 [T1]
*VBW 300 kHz -45.54 dBm
SWT 1.2 s 14.520000000 GHz

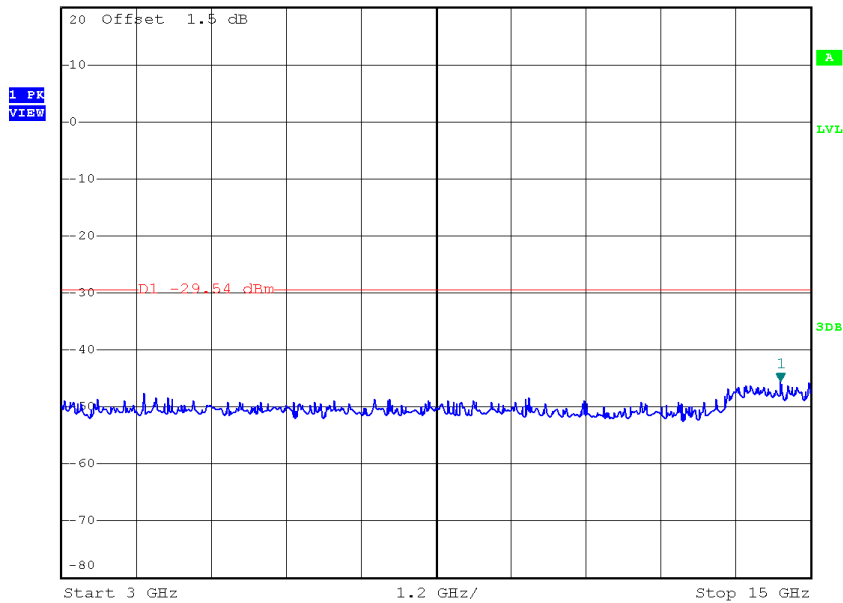

Date: 14.AUG.2016 12:29:42

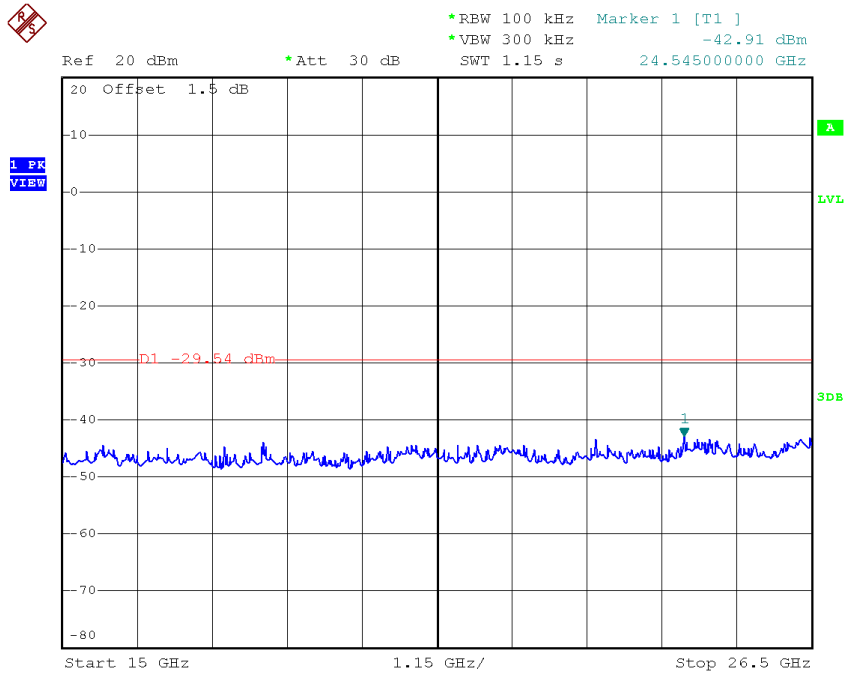

Date: 14.AUG.2016 12:29:50

TX HT40 mode CH06 (10 Harmonic of the frequency)

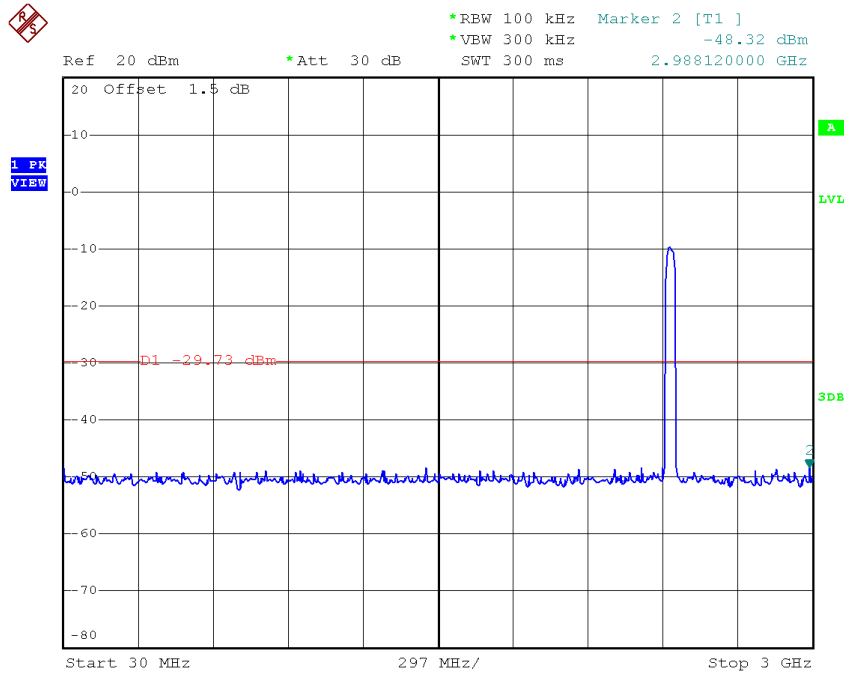

Date: 14.AUG.2016 12:31:32



*RBW 100 kHz Marker 1 [T1]
*VEW 300 kHz -45.27 dBm
Ref 20 dBm *Att 30 dB SWT 1.2 s 14.160000000 GHz

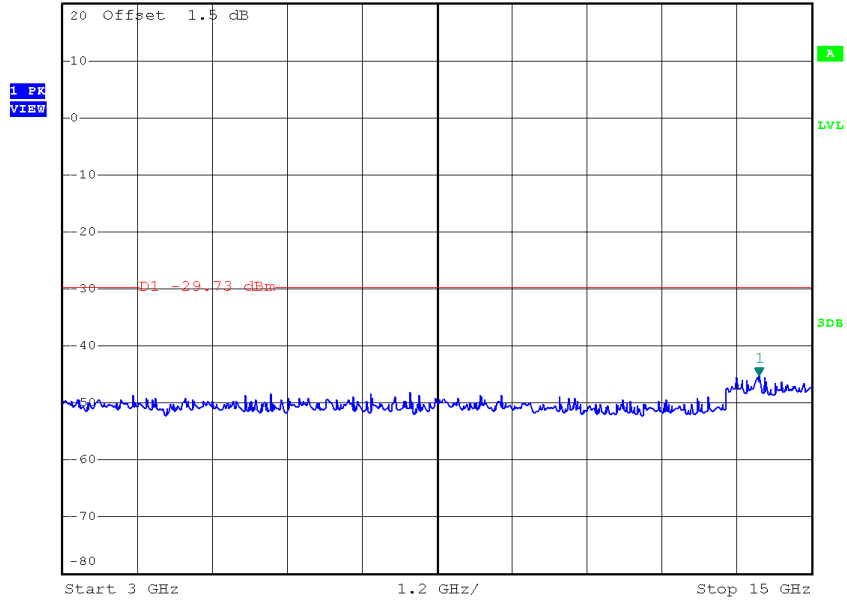

Date: 14.AUG.2016 12:31:40



*RBW 100 kHz Marker 1 [T1]
*VEW 300 kHz -42.53 dBm
Ref 20 dBm *Att 30 dB SWT 1.15 s 26.339000000 GHz

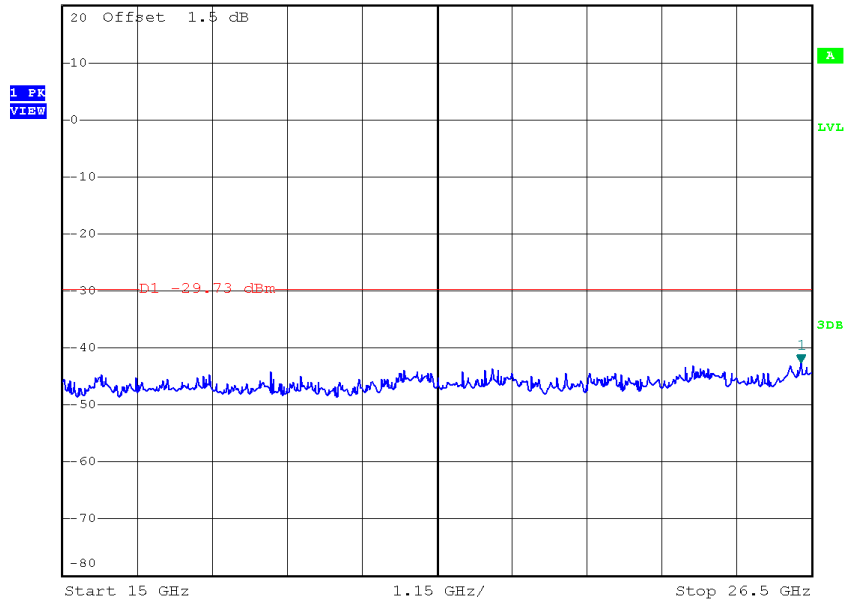

Date: 14.AUG.2016 12:31:49

TX HT40 mode CH09 (10 Harmonic of the frequency)



Ref 20 dBm *Att 30 dB *REW 100 kHz Marker 2 [T1]
*VBW 300 kHz -47.60 dBm
SWT 300 ms 772.500000000 MHz

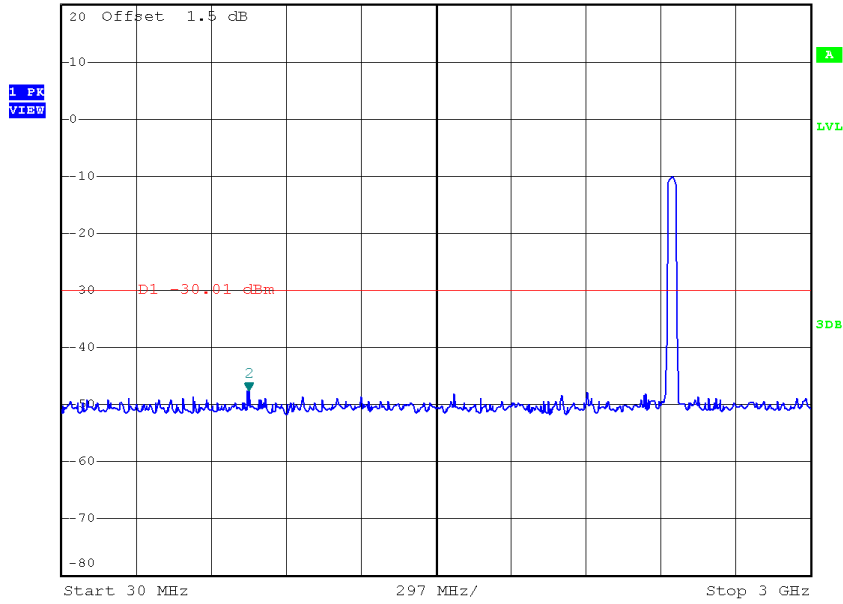

Date: 14.AUG.2016 12:46:53



Ref 20 dBm *Att 30 dB *REW 100 kHz Marker 1 [T1]
*VBW 300 kHz -45.51 dBm
SWT 1.2 s 14.640000000 GHz

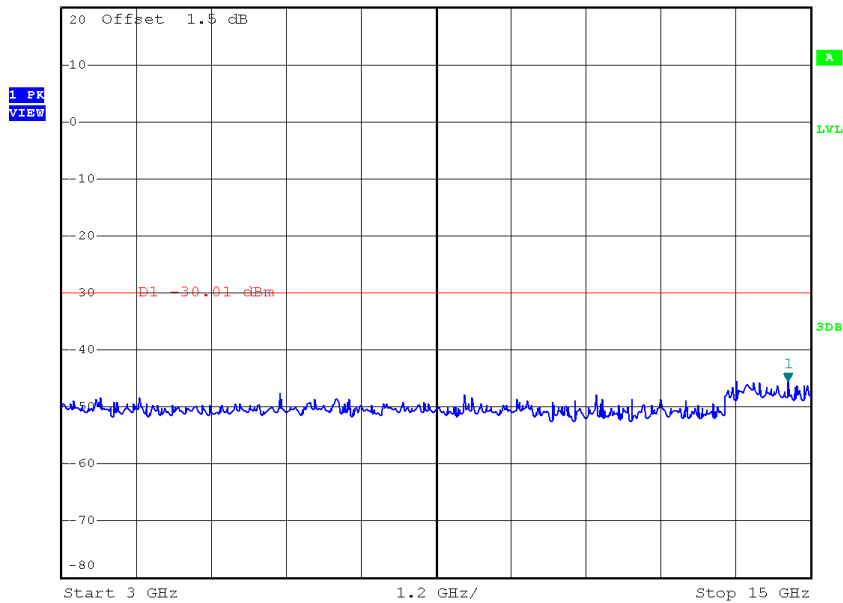

Date: 14.AUG.2016 12:47:01



*REW 100 kHz Marker 1 [T1]
*VEW 300 kHz -42.64 dBm
Ref 20 dBm *Att 30 dB SWT 1.15 s 26.247000000 GHz

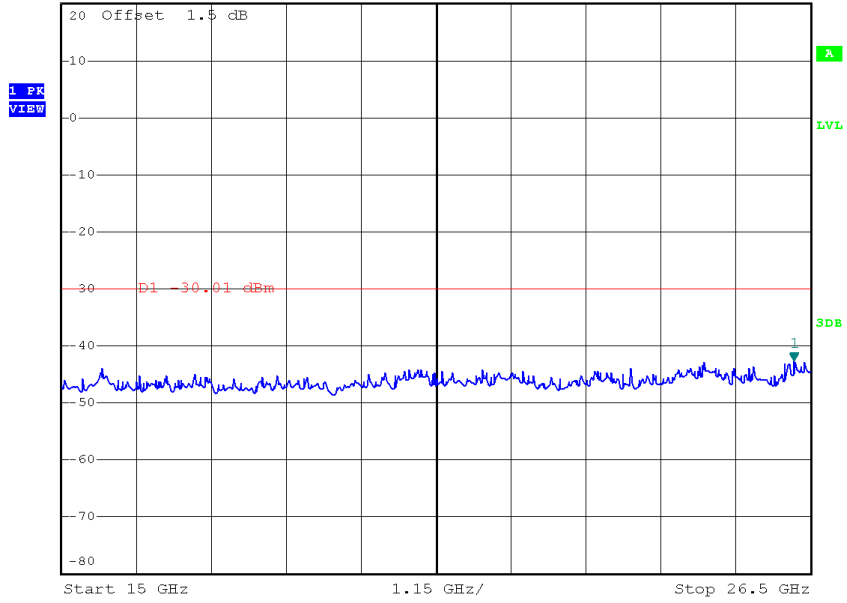

Date: 14.AUG.2016 12:47:10

Test Mode : TX N-40M Mode_ANT 2

TX HT40 mode CH03

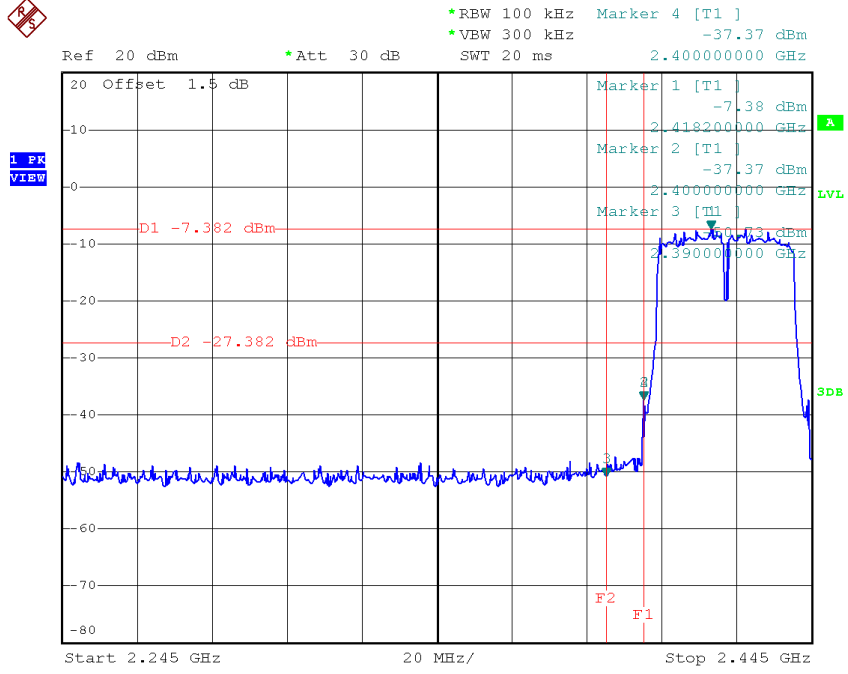

Date: 14.AUG.2016 12:49:19

TX HT40 mode CH09

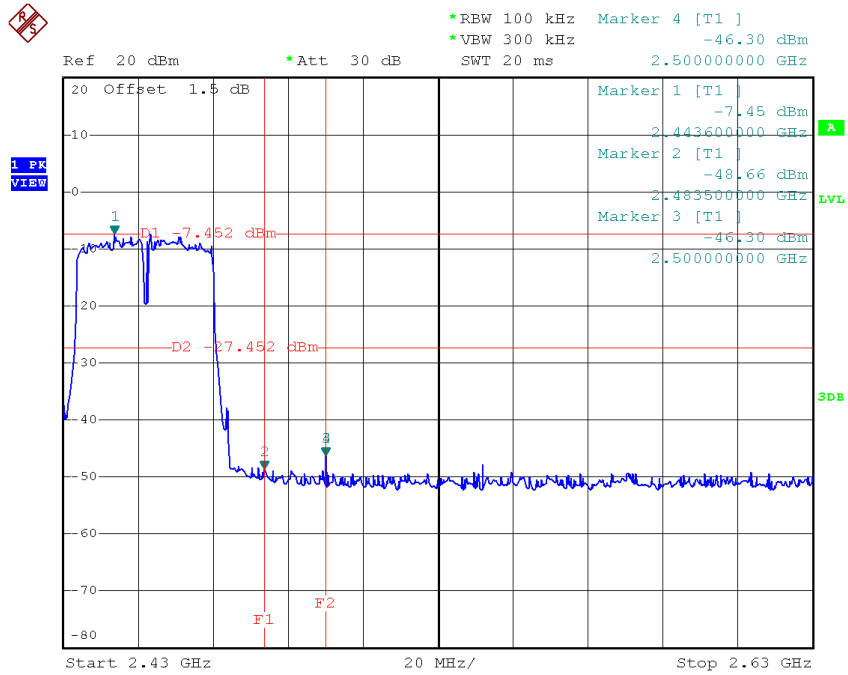

Date: 14.AUG.2016 12:54:05

TX HT40 mode CH03 (10 Harmonic of the frequency)



Ref 20 dBm *Att 30 dB *REW 100 kHz Marker 2 [T1]
*VBW 300 kHz -47.54 dBm
SWT 300 ms 160.680000000 MHz

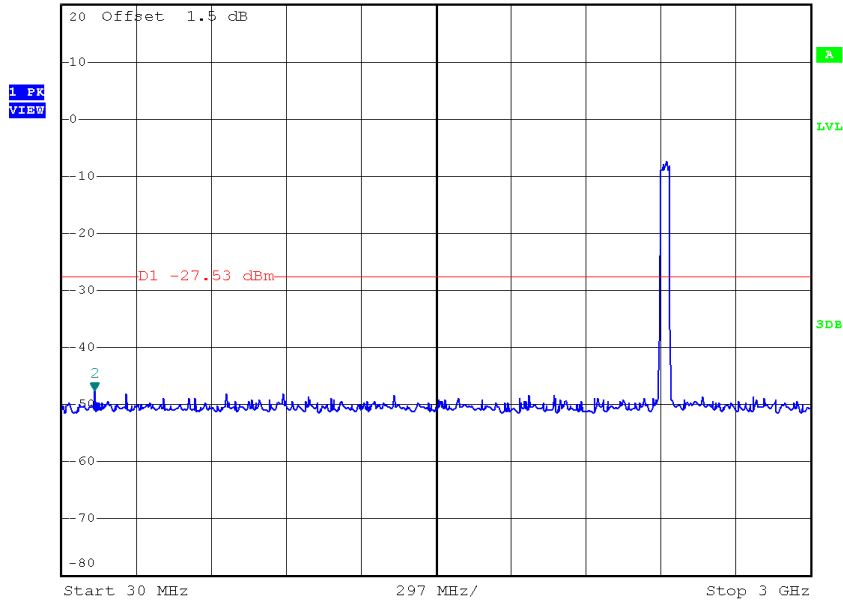

Date: 14.AUG.2016 12:48:55



Ref 20 dBm *Att 30 dB *REW 100 kHz Marker 1 [T1]
*VBW 300 kHz -45.24 dBm
SWT 1.2 s 13.944000000 GHz

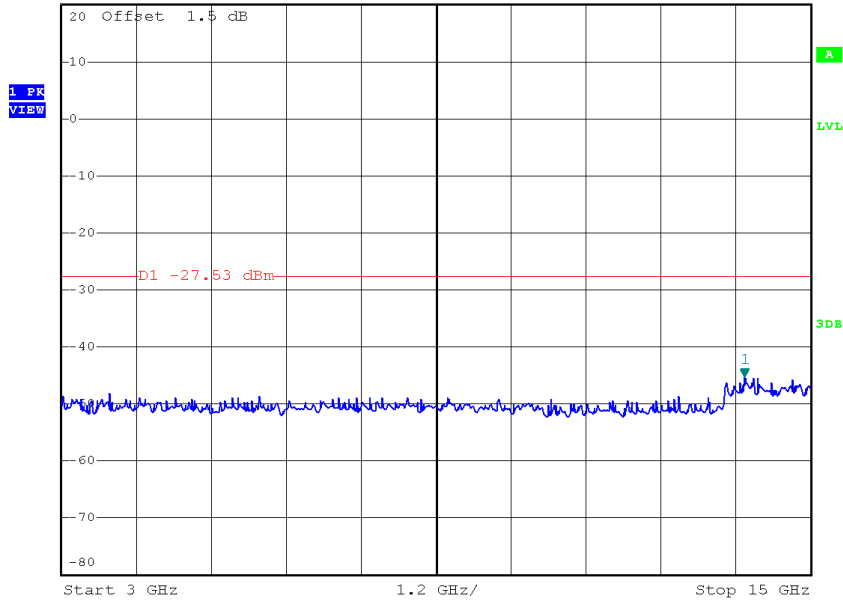

Date: 14.AUG.2016 12:49:03

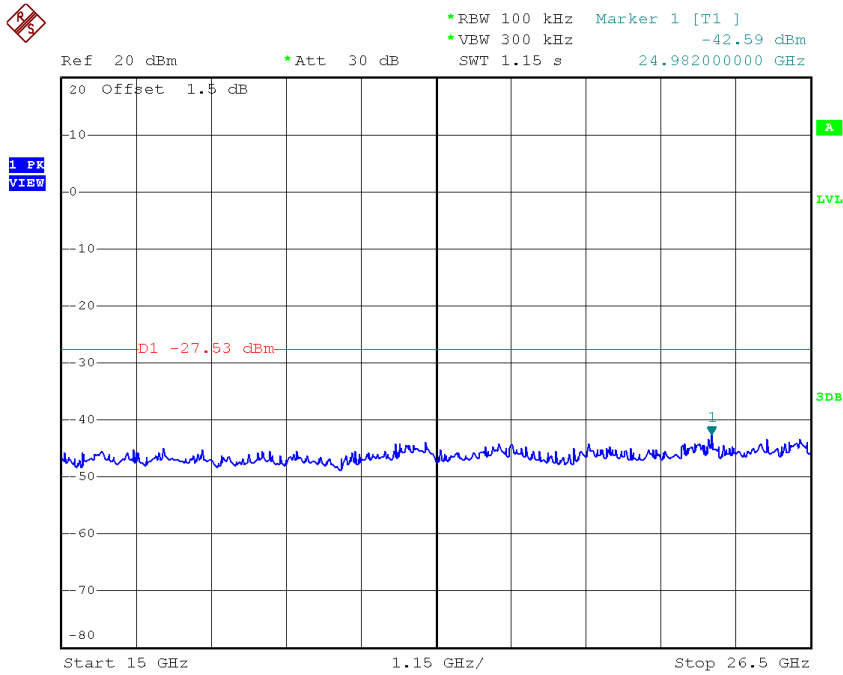

Date: 14.AUG.2016 12:49:12

TX HT40 mode CH06 (10 Harmonic of the frequency)

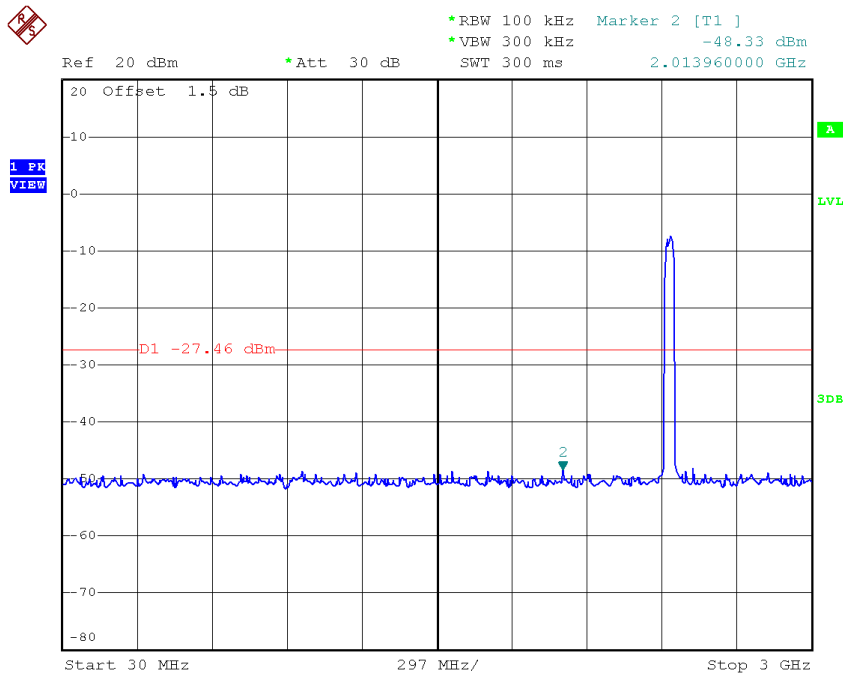

Date: 14.AUG.2016 12:52:24



Ref 20 dBm *Att 30 dB *RBW 100 kHz Marker 1 [T1]
*VEW 300 kHz -45.11 dBm
SWT 1.2 s 13.968000000 GHz

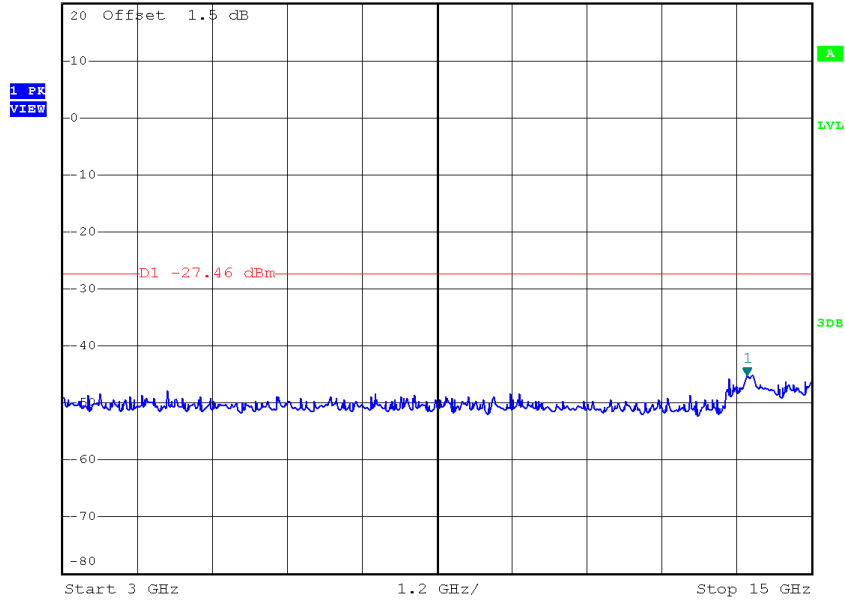

Date: 14.AUG.2016 12:52:33



Ref 20 dBm *Att 30 dB *RBW 100 kHz Marker 1 [T1]
*VEW 300 kHz -43.27 dBm
SWT 1.15 s 26.454000000 GHz

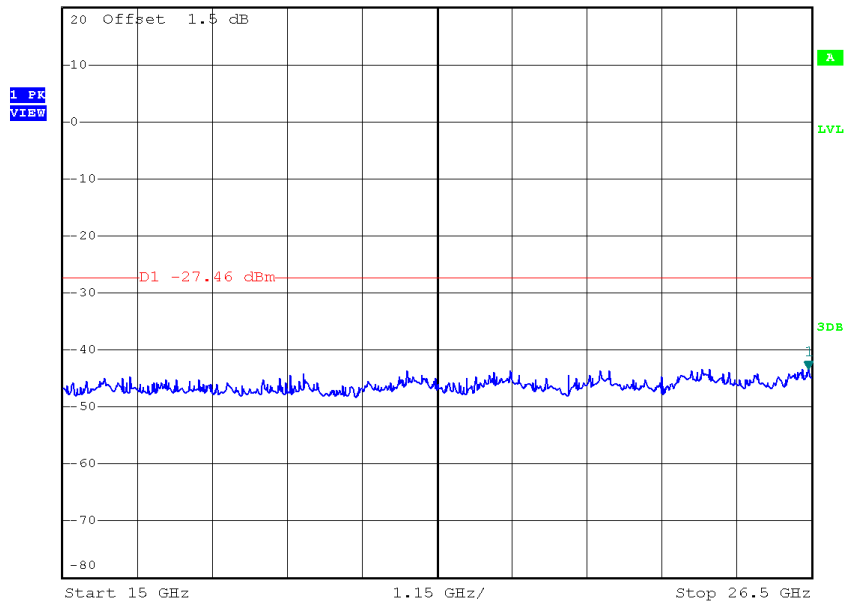

Date: 14.AUG.2016 12:52:41

TX HT40 mode CH09 (10 Harmonic of the frequency)



Ref 20 dBm *Att 30 dB *REW 100 kHz Marker 2 [T1]
 *VBW 300 kHz -47.73 dBm
 SWT 300 ms 742.800000000 MHz

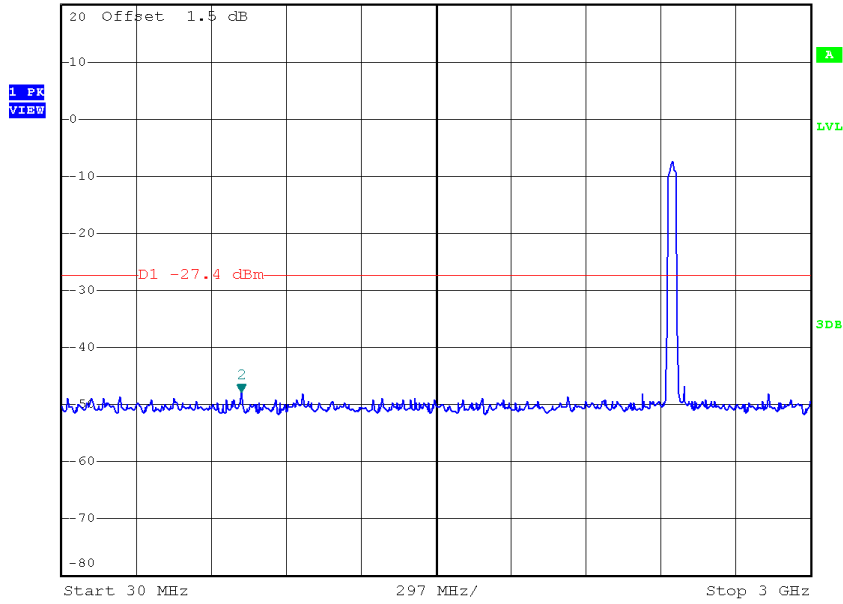

Date: 14.AUG.2016 12:53:41



Ref 20 dBm *Att 30 dB *REW 100 kHz Marker 1 [T1]
 *VBW 300 kHz -44.11 dBm
 SWT 1.2 s 14.856000000 GHz

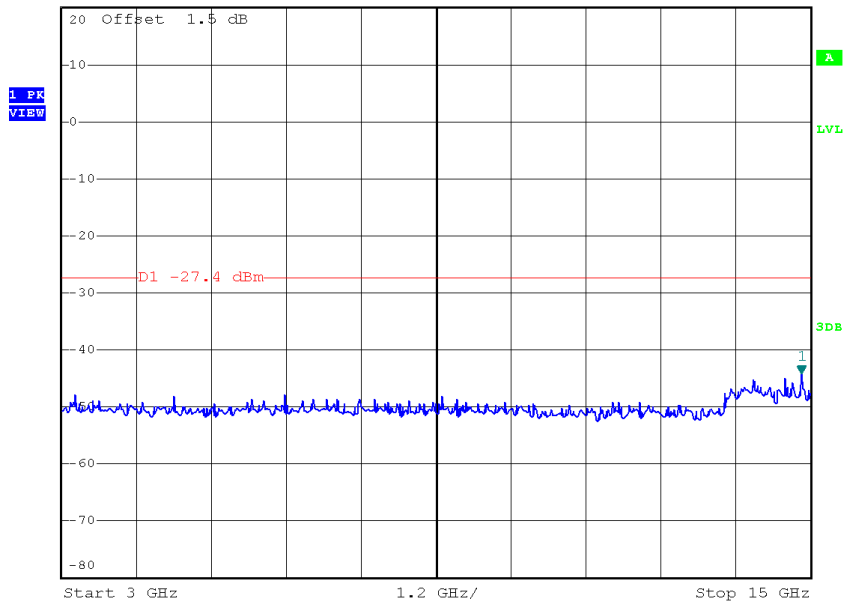

Date: 14.AUG.2016 12:53:50

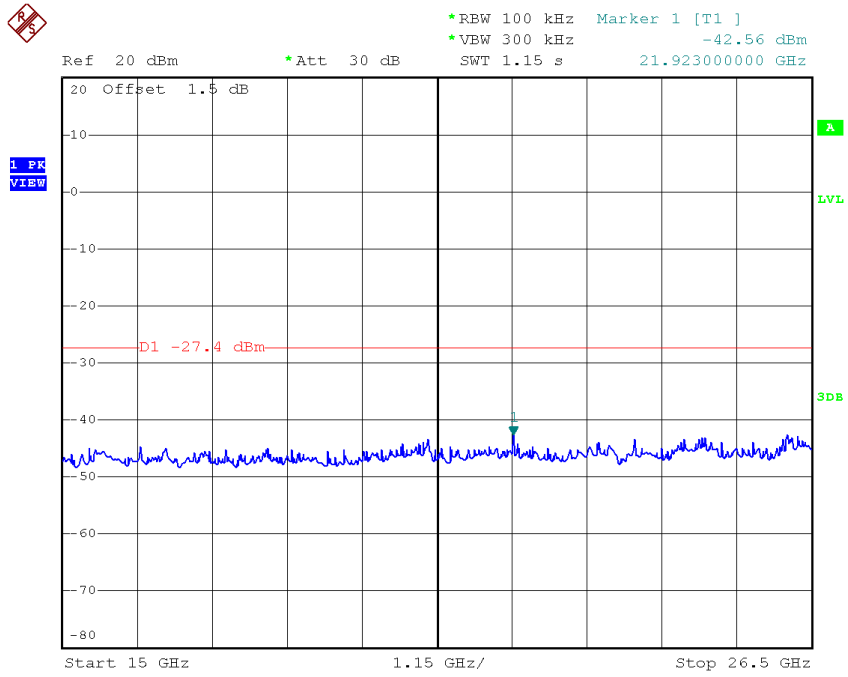

Date: 14.AUG.2016 12:53:58

ATTACHMENT H - POWER SPECTRAL DENSITY

Test Mode :TX B Mode_CH01/06/11_ANT 1

| Frequency (MHz) | Power Density (dBm/3kHz) | Power Density (mW/3kHz) | Max. Limit (dBm/3kHz) | Result |
|-----------------|--------------------------|-------------------------|-----------------------|----------|
| 2412 | -20.16 | 0.0096 | 8.00 | Complies |
| 2437 | -20.99 | 0.0080 | 8.00 | Complies |
| 2462 | -21.21 | 0.0076 | 8.00 | Complies |

TX CH01

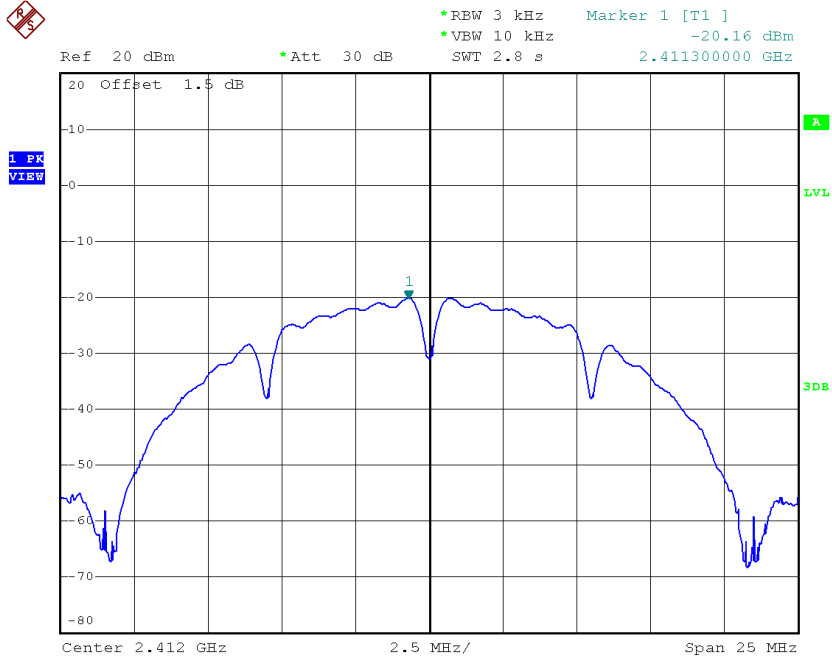

Date: 14.AUG.2016 11:53:02

TX CH06

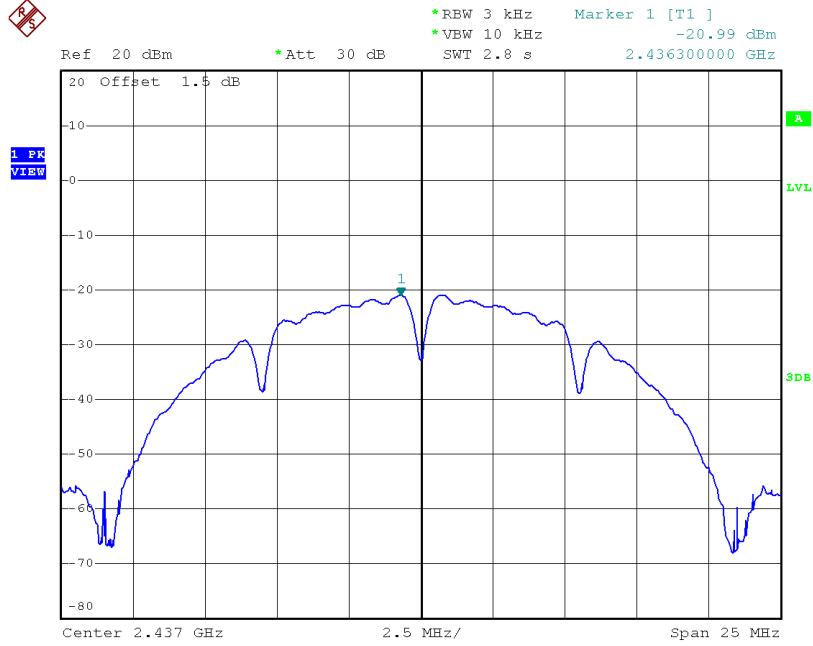

Date: 14.AUG.2016 11:54:40

TX CH11

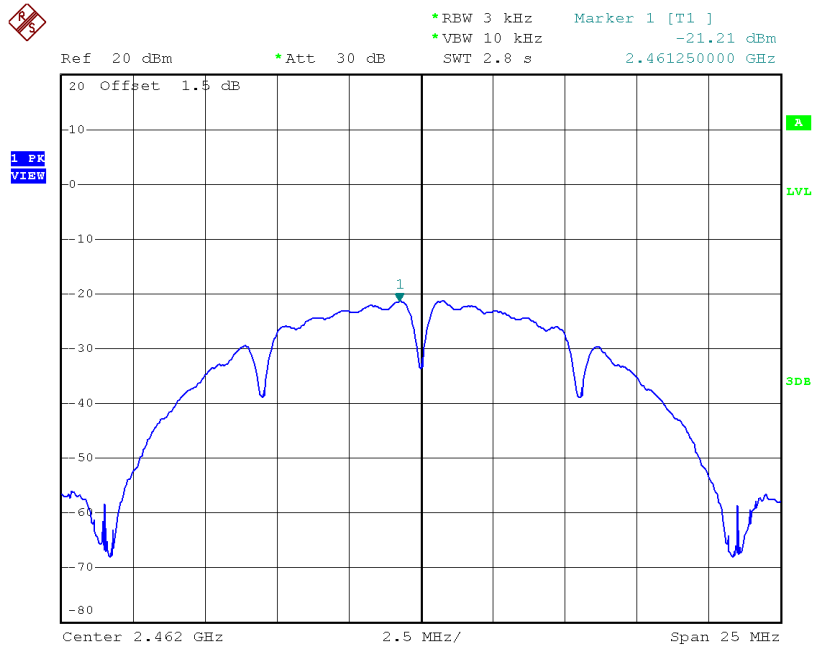

Date: 14.AUG.2016 11:56:35

Test Mode :TX B Mode_CH01/06/11_ANT 2

| Frequency (MHz) | Power Density (dBm/3kHz) | Power Density (mW/3kHz) | Max. Limit (dBm/3kHz) | Result |
|-----------------|--------------------------|-------------------------|-----------------------|----------|
| 2412 | -19.59 | 0.0110 | 8.00 | Complies |
| 2437 | -19.75 | 0.0106 | 8.00 | Complies |
| 2462 | -19.72 | 0.0107 | 8.00 | Complies |

TX CH01

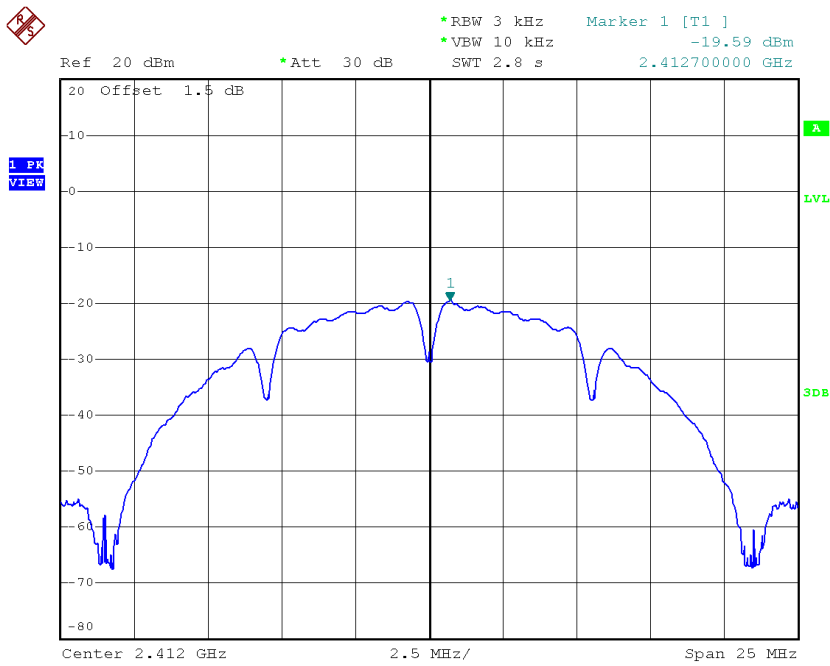

Date: 14.AUG.2016 11:58:37

TX CH06

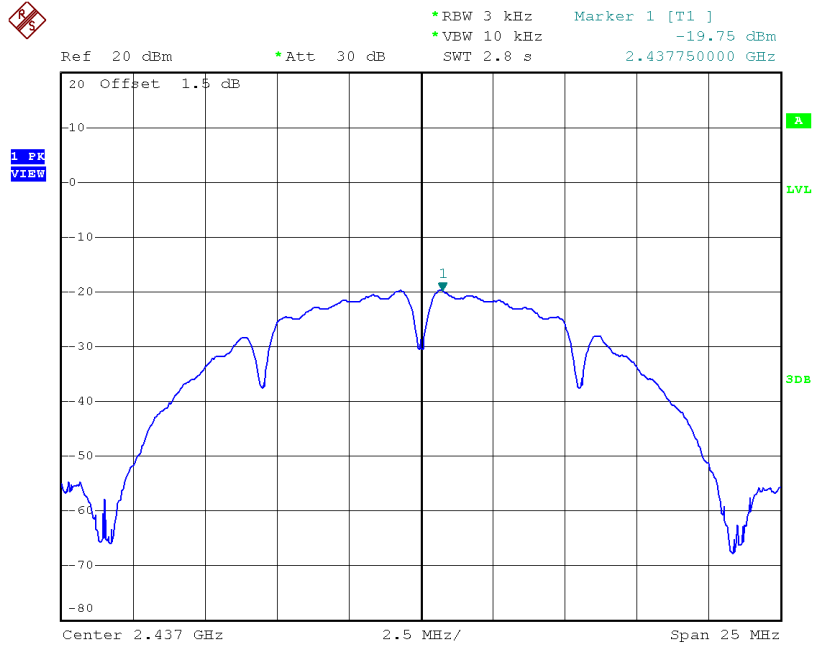

Date: 14.AUG.2016 12:01:01

TX CH11

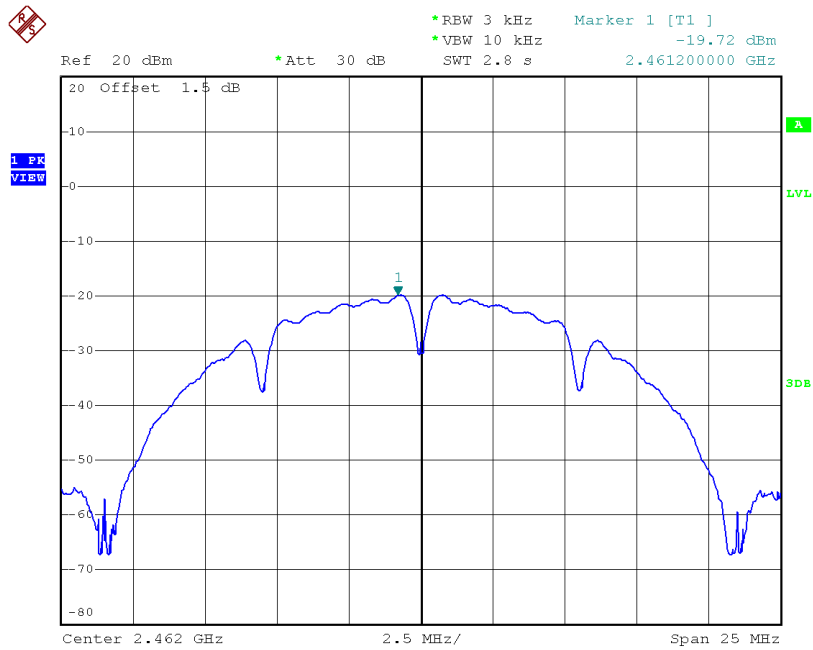

Date: 14.AUG.2016 12:02:42

Test Mode :TX B Mode_CH01/06/11_Total

| Frequency (MHz) | Power Density (dBm/3kHz) | Power Density (mW/3kHz) | Max. Limit (dBm/3kHz) | Result |
|-----------------|--------------------------|-------------------------|-----------------------|----------|
| 2412 | -16.86 | 0.0206 | 8.00 | Complies |
| 2437 | -17.30 | 0.0186 | 8.00 | Complies |
| 2462 | -17.38 | 0.0183 | 8.00 | Complies |

Test Mode :TX G Mode_CH01/06/11_ANT 1

| Frequency (MHz) | Power Density (dBm/3kHz) | Power Density (mW/3kHz) | Max. Limit (dBm/3kHz) | Result |
|-----------------|--------------------------|-------------------------|-----------------------|----------|
| 2412 | -19.47 | 0.0113 | 8.00 | Complies |
| 2437 | -20.69 | 0.0085 | 8.00 | Complies |
| 2462 | -21.08 | 0.0078 | 8.00 | Complies |

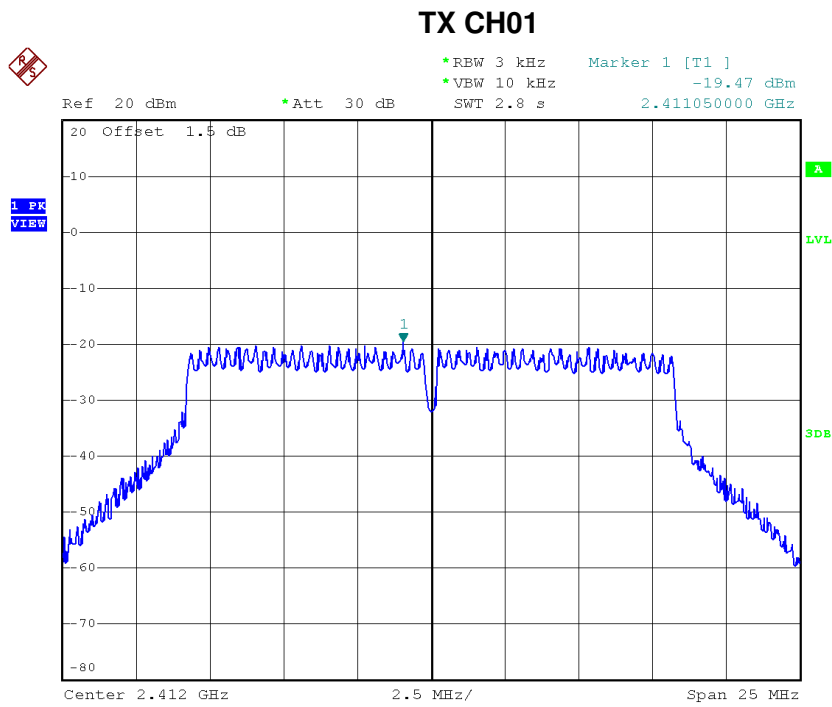

Date: 14.AUG.2016 12:05:26

TX CH06



Ref 20 dBm *Att 30 dB SWT 2.8 s 2.442300000 GHz
*RBW 3 kHz Marker 1 [T1] -20.69 dBm
*VBW 10 kHz

1 FPK
VIEW

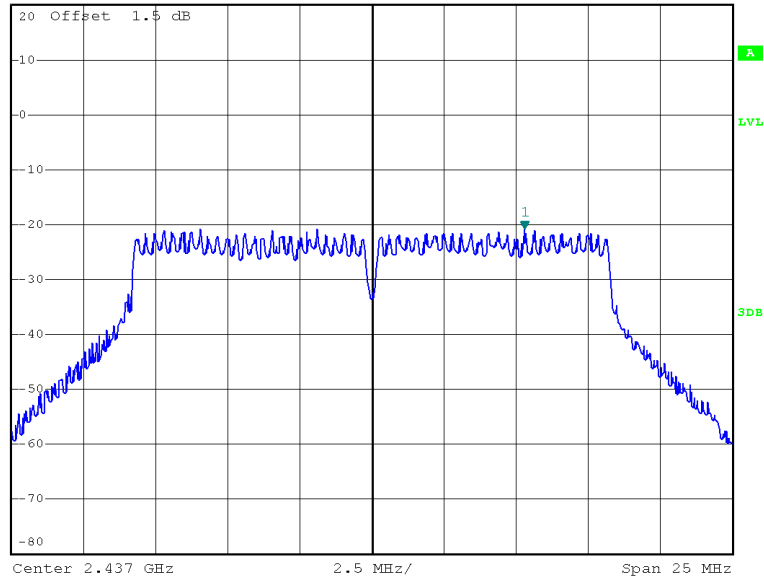

Date: 14.AUG.2016 12:07:02

TX CH11



Ref 20 dBm *Att 30 dB SWT 2.8 s 2.454800000 GHz
*RBW 3 kHz Marker 1 [T1] -21.08 dBm
*VBW 10 kHz

1 FPK
VIEW

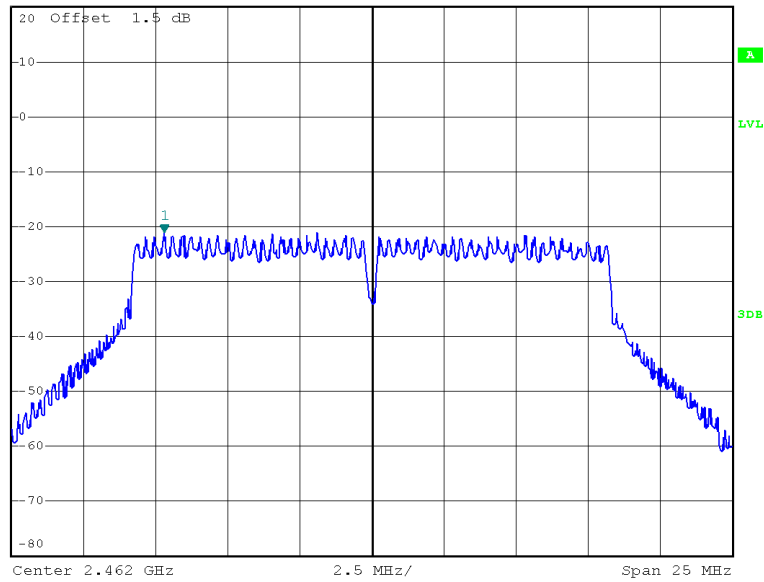

Date: 14.AUG.2016 12:08:17

Test Mode :TX G Mode_CH01/06/11_ANT 2

| Frequency (MHz) | Power Density (dBm/3kHz) | Power Density (mW/3kHz) | Max. Limit (dBm/3kHz) | Result |
|-----------------|--------------------------|-------------------------|-----------------------|----------|
| 2412 | -19.45 | 0.0114 | 8.00 | Complies |
| 2437 | -19.16 | 0.0121 | 8.00 | Complies |
| 2462 | -19.48 | 0.0113 | 8.00 | Complies |

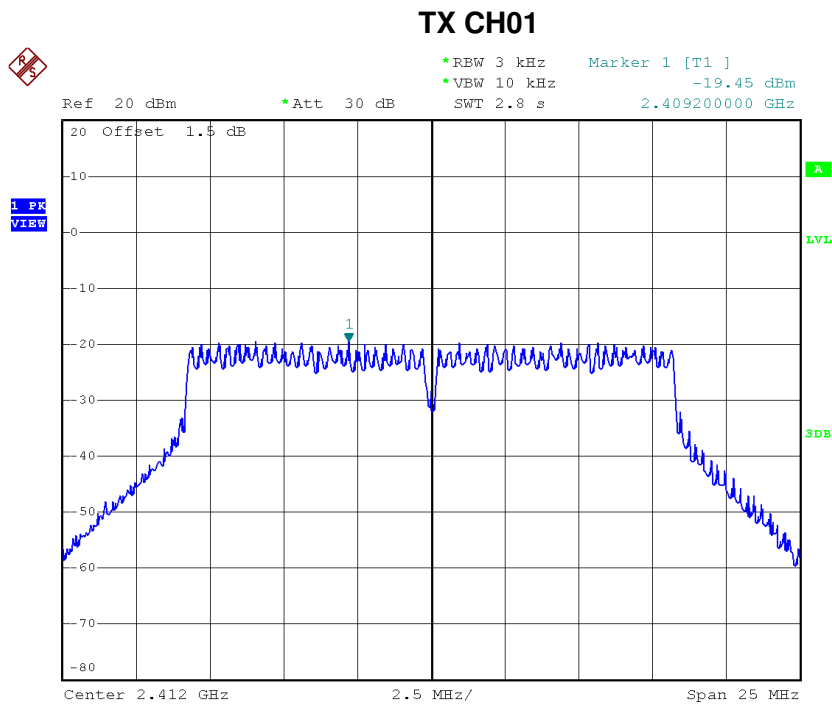

Date: 14.AUG.2016 12:09:47

TX CH06



Ref 20 dBm *Att 30 dB SWT 2.8 s
*RBW 3 kHz Marker 1 [T1] -19.16 dBm
*VBW 10 kHz 2.437950000 GHz

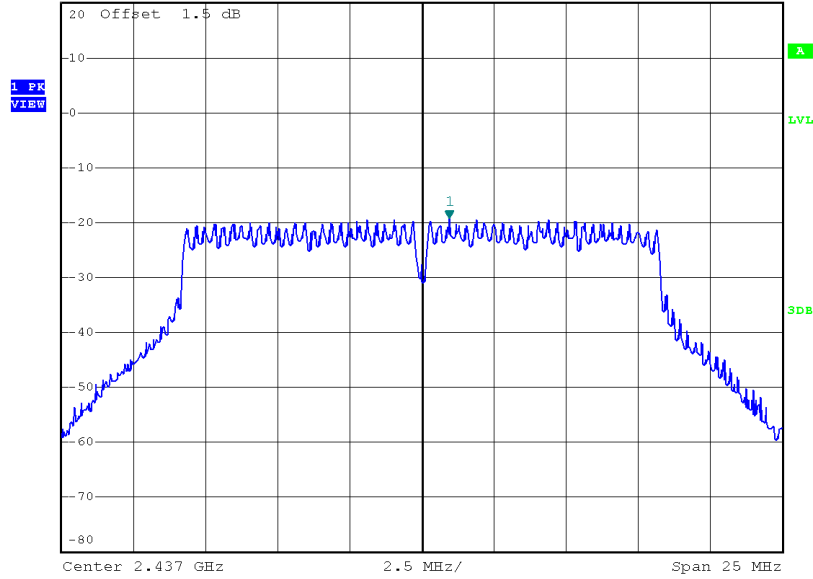

Date: 14.AUG.2016 12:11:28

TX CH11



Ref 20 dBm *Att 30 dB SWT 2.8 s
*RBW 3 kHz Marker 1 [T1] -19.48 dBm
*VBW 10 kHz 2.459200000 GHz

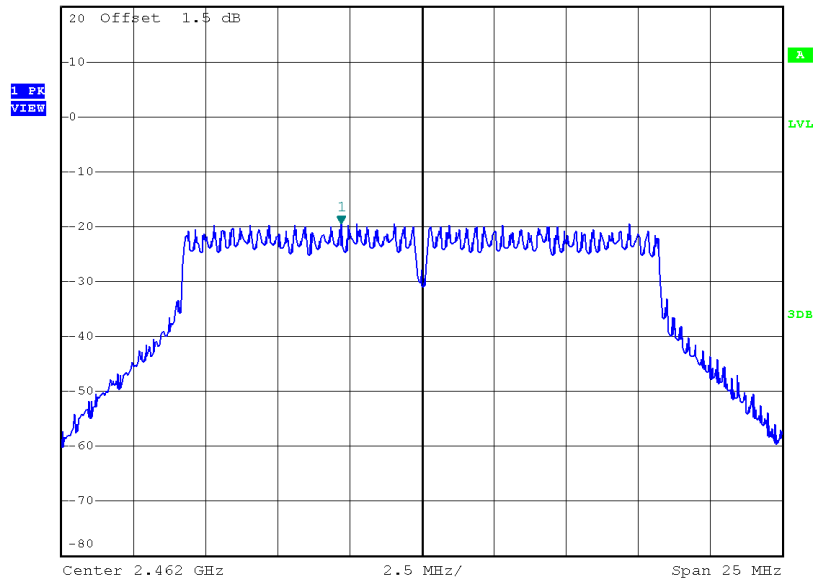

Date: 14.AUG.2016 12:13:17

Test Mode :TX G Mode_CH01/06/11_Total

| Frequency (MHz) | Power Density (dBm/3kHz) | Power Density (mW/3kHz) | Max. Limit (dBm/3kHz) | Result |
|-----------------|--------------------------|-------------------------|-----------------------|----------|
| 2412 | -16.44 | 0.0227 | 8.00 | Complies |
| 2437 | -16.86 | 0.0206 | 8.00 | Complies |
| 2462 | -17.19 | 0.0191 | 8.00 | Complies |

Test Mode : TX N-20M Mode_CH01/06/11_ANT 1

| Frequency (MHz) | Power Density (dBm/3kHz) | Power Density (mW/3kHz) | Max. Limit (dBm/3kHz) | Result |
|-----------------|--------------------------|-------------------------|-----------------------|----------|
| 2412 | -19.06 | 0.0124 | 8.00 | Complies |
| 2437 | -21.27 | 0.0075 | 8.00 | Complies |
| 2462 | -21.00 | 0.0079 | 8.00 | Complies |

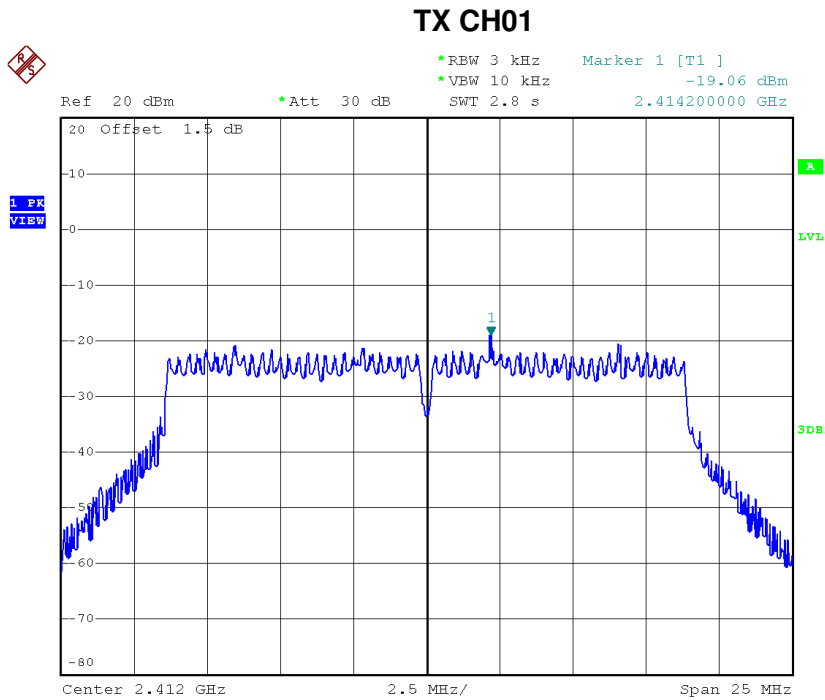

Date: 14.AUG.2016 12:15:27

TX CH06



*RBW 3 kHz Marker 1 [T1]
*VBW 10 kHz -21.27 dBm
SWT 2.8 s 2.434800000 GHz

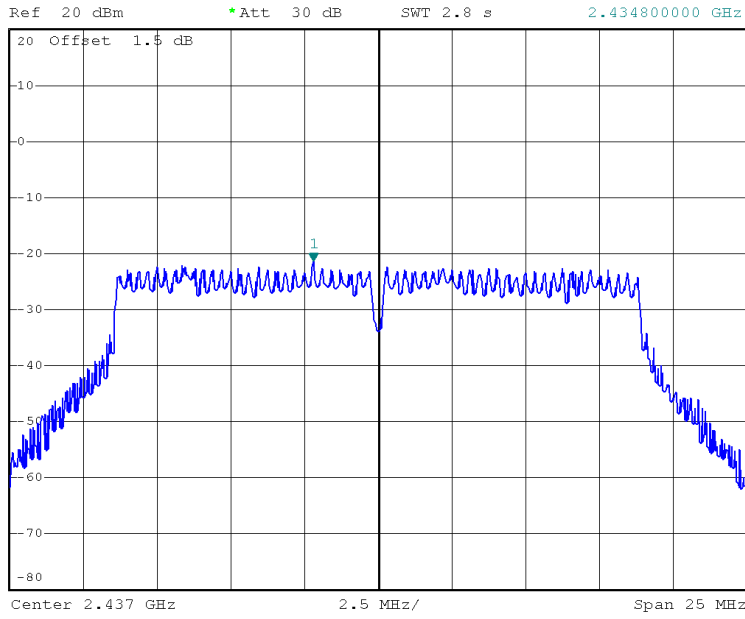

Date: 14.AUG.2016 12:17:44

TX CH11



*RBW 3 kHz Marker 1 [T1]
*VBW 10 kHz -21.00 dBm
SWT 2.8 s 2.459800000 GHz

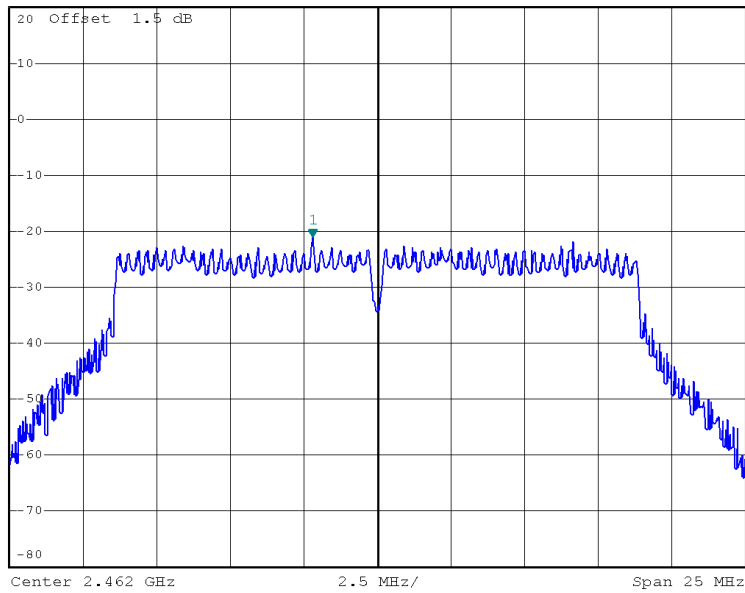

Date: 14.AUG.2016 12:21:22

Test Mode : TX N-20M Mode_CH01/06/11_ANT 2

| Frequency (MHz) | Power Density (dBm/3kHz) | Power Density (mW/3kHz) | Max. Limit (dBm/3kHz) | Result |
|-----------------|--------------------------|-------------------------|-----------------------|----------|
| 2412 | -19.78 | 0.0105 | 8.00 | Complies |
| 2437 | -19.23 | 0.0119 | 8.00 | Complies |
| 2462 | -19.04 | 0.0125 | 8.00 | Complies |

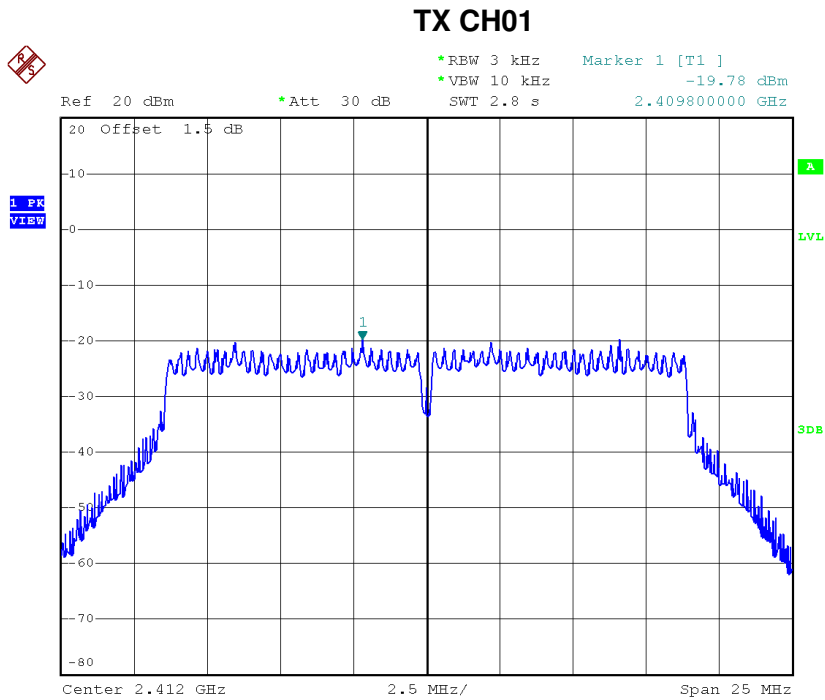

Date: 14.AUG.2016 12:23:56

TX CH06



*RBW 3 kHz Marker 1 [T1]
*VBW 10 kHz -19.23 dBm
SWT 2.8 s 2.430400000 GHz

Ref 20 dBm *Att 30 dB

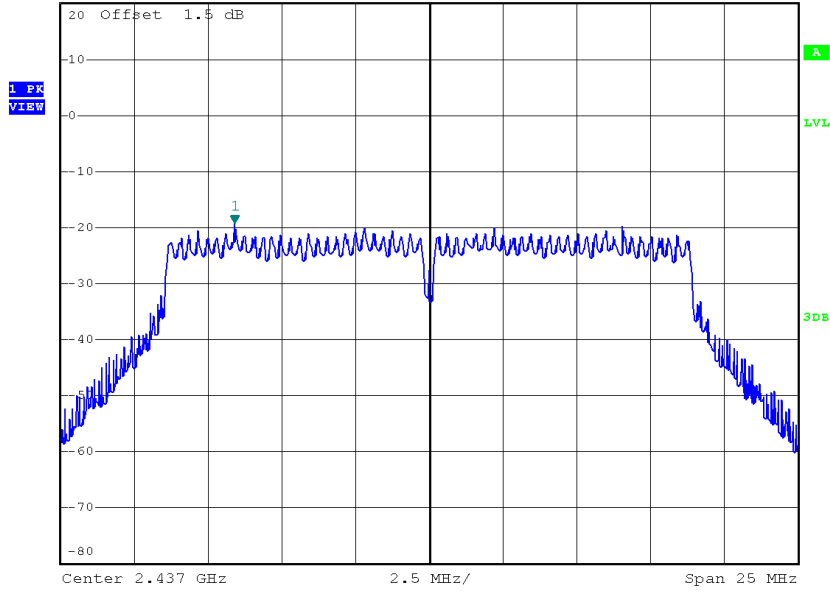

Date: 14.AUG.2016 12:26:37

TX CH11



*RBW 3 kHz Marker 1 [T1]
*VBW 10 kHz -19.04 dBm
SWT 2.8 s 2.459800000 GHz

Ref 20 dBm *Att 30 dB

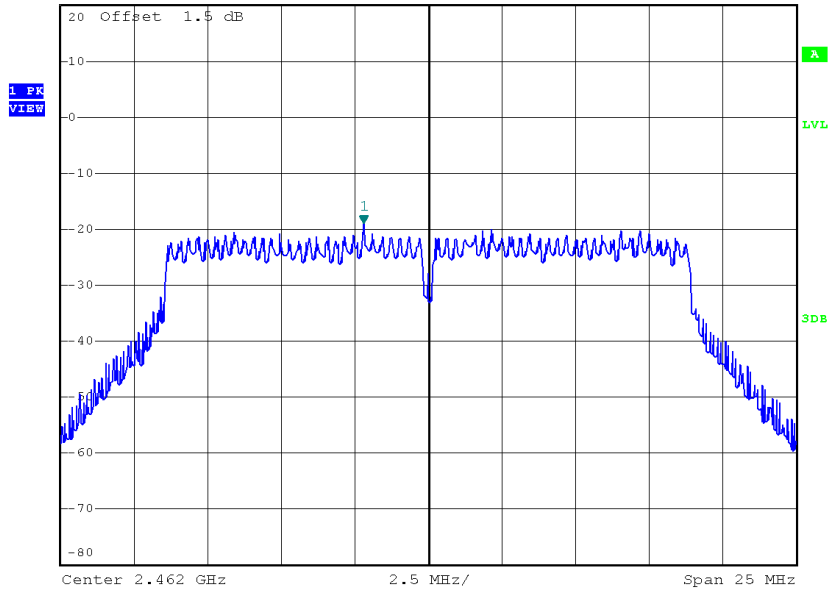

Date: 14.AUG.2016 12:28:05

Test Mode : TX N-20M Mode_CH01/06/11_Total

| Frequency (MHz) | Power Density (dBm/3kHz) | Power Density (mW/3kHz) | Max. Limit (dBm/3kHz) | Result |
|-----------------|--------------------------|-------------------------|-----------------------|----------|
| 2412 | -16.40 | 0.0229 | 8.00 | Complies |
| 2437 | -17.12 | 0.0194 | 8.00 | Complies |
| 2462 | -16.90 | 0.0204 | 8.00 | Complies |

Test Mode : TX N-40M Mode_CH03/06/09_ANT 1

| Frequency (MHz) | Power Density (dBm/3kHz) | Power Density (mW/3kHz) | Max. Limit (dBm/3kHz) | Result |
|-----------------|--------------------------|-------------------------|-----------------------|----------|
| 2422 | -21.80 | 0.0066 | 8.00 | Complies |
| 2437 | -23.18 | 0.0048 | 8.00 | Complies |
| 2452 | -23.62 | 0.0043 | 8.00 | Complies |

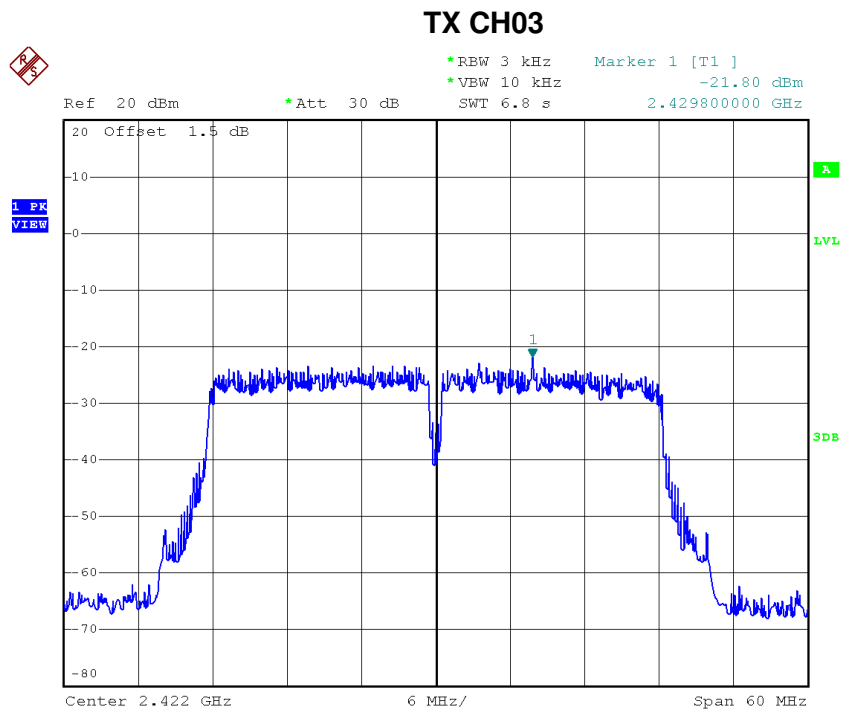

Date: 14.AUG.2016 12:30:10

TX CH06



Ref 20 dBm *Att 30 dB SWT 6.8 s Marker 1 [T1] -23.18 dBm
*RBW 3 kHz *VBW 10 kHz 2.428240000 GHz

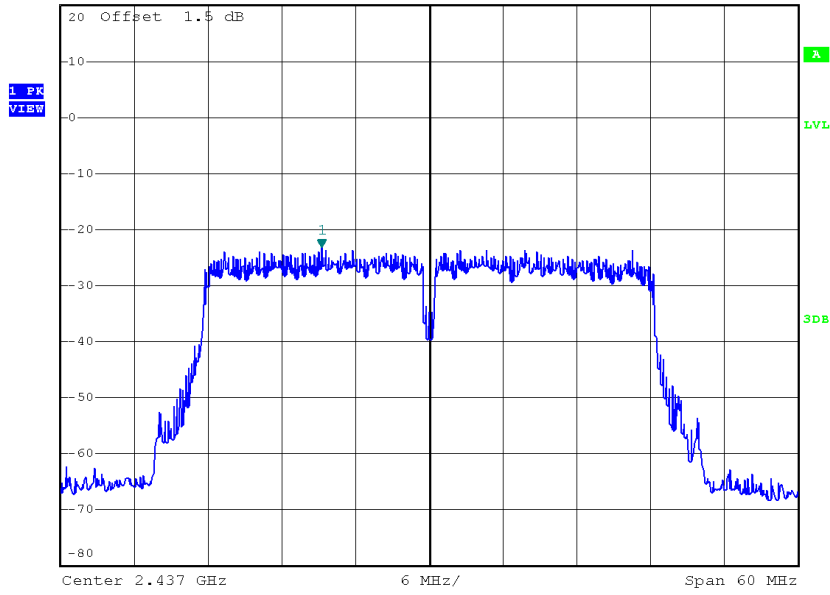

Date: 14.AUG.2016 12:32:01

TX CH09



Ref 20 dBm *Att 30 dB SWT 6.8 s Marker 1 [T1] -23.62 dBm
*RBW 3 kHz *VBW 10 kHz 2.439400000 GHz

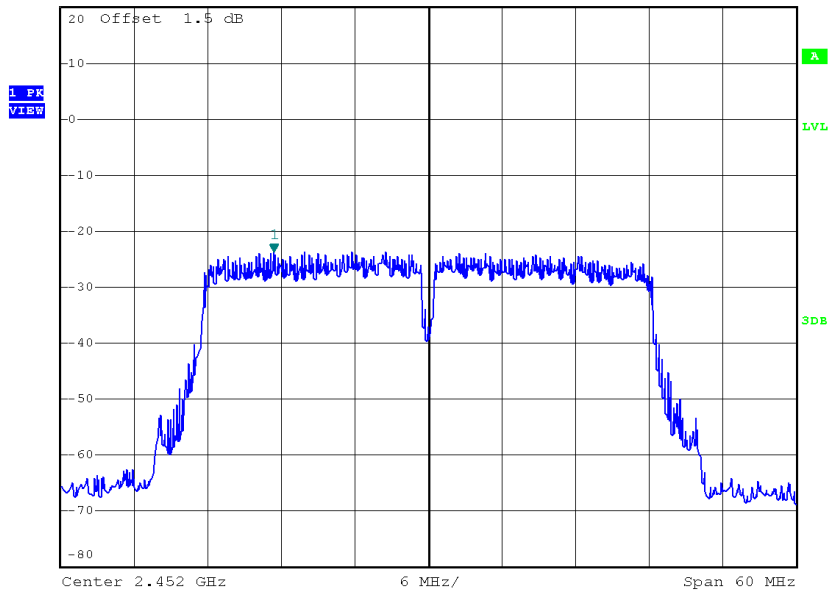

Date: 14.AUG.2016 12:47:30

Test Mode : TX N-40M Mode_CH03/06/09_ANT 2

| Frequency (MHz) | Power Density (dBm/3kHz) | Power Density (mW/3kHz) | Max. Limit (dBm/3kHz) | Result |
|-----------------|--------------------------|-------------------------|-----------------------|----------|
| 2422 | -21.93 | 0.0064 | 8.00 | Complies |
| 2437 | -22.43 | 0.0057 | 8.00 | Complies |
| 2452 | -22.06 | 0.0062 | 8.00 | Complies |

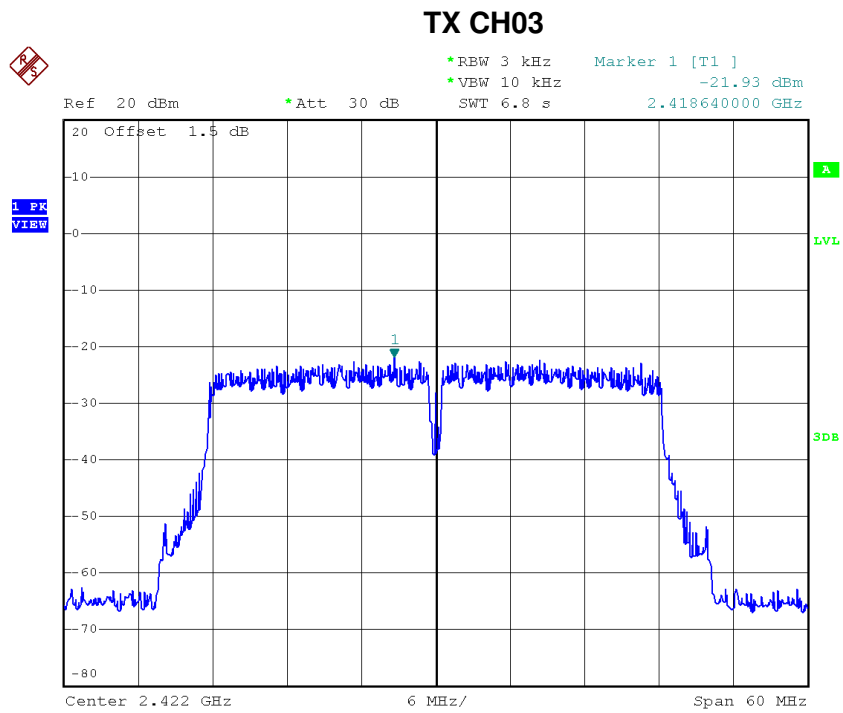

Date: 14.AUG.2016 12:49:31

TX CH06



*RBW 3 kHz Marker 1 [T1]
*VBW 10 kHz -22.43 dBm
SWT 6.8 s 2.444800000 GHz

Ref 20 dBm *Att 30 dB

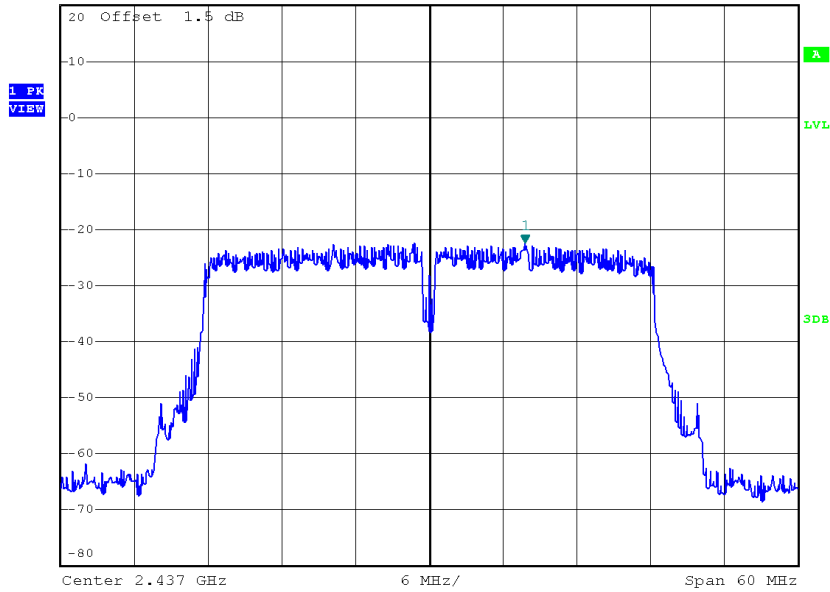

Date: 14.AUG.2016 12:52:53

TX CH09



*RBW 3 kHz Marker 1 [T1]
*VBW 10 kHz -22.06 dBm
SWT 6.8 s 2.459800000 GHz

Ref 20 dBm *Att 30 dB

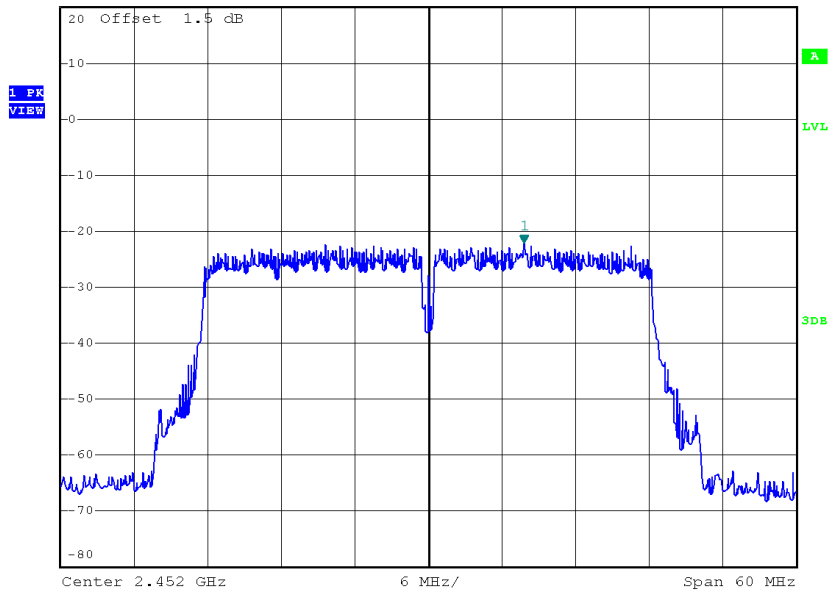

Date: 14.AUG.2016 12:54:18

Test Mode : TX N-40M Mode_CH03/06/09_Total

| Frequency (MHz) | Power Density (dBm/3kHz) | Power Density (mW/3kHz) | Max. Limit (dBm/3kHz) | Result |
|-----------------|--------------------------|-------------------------|-----------------------|----------|
| 2422 | -18.86 | 0.0130 | 8.00 | Complies |
| 2437 | -19.79 | 0.0105 | 8.00 | Complies |
| 2452 | -19.79 | 0.0105 | 8.00 | Complies |