



**FCC 47 CFR PART 15 SUBPART C AND ANSI C63.10:2009  
TEST REPORT**

**For**

**300Mbps Wireless N High Power Ceiling-Mounted Access Point**

**Model : WF2520**

**Data Applies To : WF2520P**

**Trade Name : netis**

**Issued for**

**NETIS SYSTEMS CO., LTD**

**4F & 5F, R&D Building, Oriental Cyberport, High-Tech Industrial Park,  
Nanshan, Shenzhen, China**

**Issued by**

**Compliance Certification Services Inc.  
Hsinchu Lab.**

**No.989-1, Wenshan Rd., Shangshan Village,  
Qionglin Township, Hsinchu County 30741, Taiwan (R.O.C.)**

**TEL: +886-3-5921698**

**FAX: +886-3-5921108**

**<http://www.ccsrf.com>**

**E-Mail : [service@ccsrf.com](mailto:service@ccsrf.com)**

**Issued Date: April 17, 2015**



**Note:** This report shall not be reproduced except in full, without the written approval of Compliance Certification Services Inc. This document may be altered or revised by Compliance Certification Services Inc. personnel only, and shall be noted in the revision section of the document. The client should not use it to claim product endorsement by TAF or any government agencies. The test results of this report relate only to the tested sample identified in this report.

---



### Revision History

Rev.	Issue Date	Revisions	Effect Page	Revised By
00	04/17/2015	Initial Issue	All Page 106	Dola Hsieh



---

**TABLE OF CONTENTS**

<b>TITLE</b>	<b>PAGE NO.</b>
<b>1. TEST REPORT CERTIFICATION .....</b>	<b>4</b>
<b>2. EUT DESCRIPTION .....</b>	<b>5</b>
<b>3. DESCRIPTION OF TEST MODES .....</b>	<b>7</b>
<b>4. TEST METHODOLOGY .....</b>	<b>9</b>
<b>5. FACILITIES AND ACCREDITATION .....</b>	<b>9</b>
5.1 FACILITIES .....	9
5.2 ACCREDITATIONS.....	9
5.3 MEASUREMENT UNCERTAINTY .....	10
<b>6. SETUP OF EQUIPMENT UNDER TEST.....</b>	<b>11</b>
<b>7. FCC PART 15.247 REQUIREMENTS .....</b>	<b>12</b>
7.1 6dB BANDWIDTH .....	12
7.2 MAXIMUM PEAK OUTPUT POWER .....	26
7.3 AVERAGE POWER .....	29
7.4 POWER SPECTRAL DENSITY .....	32
7.5 CONDUCTED SPURIOUS EMISSION .....	47
7.6 RADIATED EMISSION.....	66
7.7 CONDUCTED EMISSION.....	99
<b>APPENDIX SETUP PHOTOS .....</b>	<b>104</b>



### 1. TEST REPORT CERTIFICATION

**Applicant** : NETIS SYSTEMS CO., LTD  
**Address** : 4F & 5F, R&D Building, Oriental Cyberport, High-Tech Industrial Park, Nanshan, Shenzhen, China  
**Equipment Under Test** : 300Mbps Wireless N High Power Ceiling-Mounted Access Point  
**Model** : WF2520  
**Data Applies To** : WF2520P  
**Trade Name** : netis  
**Tested Date** : January 28 ~ April 07, 2015

APPLICABLE STANDARD	
Standard	Test Result
FCC Part 15 Subpart C AND ANSI C63.10:2009	PASS

WE HEREBY CERTIFY THAT: The above equipment has been tested by Compliance Certification Services Inc., and found compliance with the requirements set forth in the technical standards mentioned above. The results of testing in this report apply only to the product/system, which was tested. Other similar equipment will not necessarily produce the same results due to production tolerance and measurement uncertainties.

**Approved by:**

Rex Liao  
Deputy Manager

**Reviewed by:**

Jacky Chen  
Section Manager

**2. EUT DESCRIPTION**

<b>Product Name</b>	300Mbps Wireless N High Power Ceiling-Mounted Access Point
<b>Model Number</b>	WF2520
<b>Data Applies To</b>	WF2520P
<b>Identify Number</b>	T150128D05
<b>Received Date</b>	January 28, 2015
<b>Frequency Range</b>	IEEE 802.11b/g, 802.11gn HT20 : 2412MHz ~ 2462MHz IEEE 802.11gn HT40 : 2422MHz ~ 2452MHz
<b>Transmit Power</b>	IEEE 802.11b : 17.03 dBm (0.0505 W) IEEE 802.11g : 21.72 dBm (0.1486 W) IEEE 802.11gn HT20 : 27.33 dBm (0.5408 W) IEEE 802.11gn HT40 : 26.60 dBm (0.4571 W)
<b>Channel Spacing</b>	IEEE 802.11b/g, 802.11gn HT20/HT40 : 5MHz
<b>Channel Number</b>	IEEE 802.11b/g, 802.11gn HT20 : 11 Channels IEEE 802.11gn HT40 : 7 Channels
<b>Transmit Data Rate</b>	IEEE 802.11b : up to 11 Mbps IEEE 802.11g : up to 54 Mbps IEEE 802.11gn (HT20,800ns GI) : up to 130.00 Mbps IEEE 802.11gn (HT20,400ns GI) : up to 144.40 Mbps IEEE 802.11gn (HT40,800ns GI) : up to 270.00 Mbps IEEE 802.11gn (HT40,400ns GI) : up to 300.00 Mbps
<b>Type of Modulation</b>	IEEE 802.11b : DSSS (CCK, DQPSK, DBPSK) IEEE 802.11g : OFDM (64QAM, 16QAM, QPSK, BPSK) IEEE 802.11gn HT20/40 : OFDM (64QAM, 16QAM, QPSK, BPSK)
<b>Antenna Type</b>	PIFA Antenna × 2 , Antenna A Gain : 4 dBi (RFA-25-G162-70B-70R/Black) Antenna B Gain : 3.8 dBi (RFA-25-G162-70-70L/Gray)
<b>Power Rating</b>	48Vdc
<b>Test Voltage</b>	120Vac, 60Hz
<b>I/O Port</b>	LAN Port × 1, WAN/PoE Port × 1

**Power Adapter (For WF2520P):**

No.	Manufacturer	Model No.	Power Input	Power Output
1	SHENZHEN JOKE ELECTRONICS., LTD	JK240050-S04EUA	100-240Vac, 50/60Hz, 0.5A	24Vdc, 500mA



**The difference of the series model :**

<b>Model Number</b>	<b>Difference</b>
WF2520	Products for 48Vdc
WF2520P	Products for Passive PoE, PoE injector, and each 24Vdc Adapter.

**Remark :**

- 1. The sample selected for test was engineering sample that approximated to production product and was provided by manufacturer.*
- 2. For more details, please refer to the User's manual of the EUT.*
- 3. The model WF2520 was considered the main model for testing.*
- 4. This submittal(s) (test report) is intended for FCC ID: T58WF2520R filing to comply with Section 15.207, 15.209 and 15.247 of the FCC Part 15, Subpart C Rules.*



### 3. DESCRIPTION OF TEST MODES

The EUT is an 802.11n transceiver in 300Mbps Wireless N High Power Ceiling-Mounted Access Point form factor.

For IEEE 802.11b/g mode (1TX / 1RX) : Chain 0(Ant. A) transmit/receive.

For IEEE 802.11gn HT20/HT40 mode (2TX / 2RX) : Chain 0(Ant. A) & Chain 1(Ant. B) transmit/receive.

#### Conducted Emission / Radiated Emission Test (Below 1 GHz)

1. The following test modes were scanned during the preliminary test:

No.	Pre-Test Mode
1	TX Mode

2. After the preliminary scan, the following test mode was found to produce the highest emission level.

Final Test Mode		
Emission	Radiated Emission	TX Mode
	Conducted Emission	TX Mode

*Remark : Then, the above highest emission mode of the configuration of the EUT and cable was chosen for all final test items.*

#### Conducted / Radiated Emission Test (Above 1 GHz)

##### IEEE 802.11b, 802.11g, 802.11gn HT20 mode

The EUT had been tested under operating condition.

There are three channels have been tested as following :

Channel	Frequency (MHz)
Low	2412
Middle	2437
High	2462

IEEE 802.11b mode : 1Mbps data rate (worst case) were chosen for full testing.

IEEE 802.11g mode : 6Mbps data rate (worst case) were chosen for full testing.

IEEE 802.11gn HT20 mode : 6.5Mbps data rate (worst case) were chosen for full testing.



**IEEE 802.11gn HT40 mode**

The EUT had been tested under operating condition.

There are three channels have been tested as following :

<b>Channel</b>	<b>Frequency (MHz)</b>
Low	2422
Middle	2437
High	2452

IEEE 802.11gn HT40 mode : 13.5Mbps data rate (worst case) were chosen for full testing.





## 4. TEST METHODOLOGY

The tests documented in this report were performed in accordance with ANSI C63.10:2009 and FCC CFR 47, 15.207, 15.209 and 15.247.

## 5. FACILITIES AND ACCREDITATION

### 5.1 FACILITIES

All measurement facilities used to collect the measurement data are located at

No.989-1, Wenshan Rd., Shangshan Village,  
Qionglin Township, Hsinchu County 30741, Taiwan (R.O.C.)

The sites are constructed in conformance with the requirements of ANSI C63.10:2009 and CISPR 22. All receiving equipment conforms to CISPR 16-1-1, CISPR 16-1-2, CISPR 16-1-3, CISPR 16-1-4, CISPR 16-1-5.

### 5.2 ACCREDITATIONS

Our laboratories are accredited and approved by the following approval agencies according to ISO/IEC 17025.

<b>Taiwan</b>	TAF
---------------	-----

The measuring facility of laboratories has been authorized or registered by the following approval agencies.

<b>Canada</b>	INDUSTRY CANADA
<b>Japan</b>	VCCI
<b>Taiwan</b>	BSMI
<b>USA</b>	FCC MRA

Copies of granted accreditation certificates are available for downloading from our web site, <http://www.ccsrf.com>

**Remark:** FCC Designation Number TW1027.



### 5.3 MEASUREMENT UNCERTAINTY

The following table is for the measurement uncertainty, which is calculated as per the document CISPR 16-4-2.

PARAMETER	UNCERTAINTY
Semi Anechoic Chamber (966 Chamber_B) / Radiated Emission, 30 to 1000 MHz	+/- 3.97
Semi Anechoic Chamber (966 Chamber_B) / Radiated Emission, 1 to 18GHz	+/- 3.58
Semi Anechoic Chamber (966 Chamber_B) / Radiated Emission, 18 to 26 GHz	+/- 3.59
Semi Anechoic Chamber (966 Chamber_B) / Radiated Emission, 26 to 40 GHz	+/- 3.81
Conducted Emission (Mains Terminals), 9kHz to 30MHz	+/- 2.48

This uncertainty represents an expanded uncertainty expressed at approximately the 95% confidence level using a coverage factor of  $k=2$ .

Consistent with industry standard (e.g. CISPR 22, clause 11, Measurement Uncertainty) determining compliance with the limits shall be base on the results of the compliance measurement. Consequently the measure emissions being less than the maximum allowed emission result in this be a compliant test or passing test.

The acceptable measurement uncertainty value without requiring revision of the compliance statement is base on conducted and radiated emissions being less than  $U_{CISPR}$  which is 3.6dB and 5.2dB respectively. CCS values (called  $U_{Lab}$  in CISPR 16-4-2) is less than  $U_{CISPR}$  as shown in the table above. Therefore, MU need not be considered for compliance.



## 6. SETUP OF EQUIPMENT UNDER TEST

### SUPPORT EQUIPMENT

No.	Product	Manufacturer	Model No.	Serial No.
1	Notebook PC	DELL	INSPIRON 640m PP19L	CN-0MG532-70166 -71G-03EC
2	POE	Ubiquiti Networks, Inc.	GP-D480-050G	---

No.	Signal Cable Description
1	Non-shielded RJ-45 cable, 12m × 1

### SETUP DIAGRAM FOR TESTS

EUT & peripherals setup diagram is shown in appendix setup photos.

### EUT OPERATING CONDITION

1. EUT & peripherals setup diagram is shown in appendix setup photos.
2. Run Test software. "artqui"

#### **TX Mode:**

- ⇒ **Tx Data Rate:** 1Mbps Bandwidth 20 (IEEE 802.11b mode)  
6Mbps Bandwidth 20 (IEEE 802.11g mode)  
6.5Mbps Bandwidth 20 (IEEE 802.11gn HT20 mode)  
13.5Mbps Bandwidth 40 (IEEE 802.11gn HT40 mode)

#### ⇒ **Power control**

- IEEE 802.11b Channel Low (2412MHz) Chain0 Power set 20
- IEEE 802.11b Channel Mid (2437MHz) Chain0 Power set 20
- IEEE 802.11b Channel High (2462MHz) Chain0 Power set 22
- IEEE 802.11g Channel Low (2412MHz) Chain0 Power set 29
- IEEE 802.11g Channel Mid (2437MHz) Chain0 Power set 28
- IEEE 802.11g Channel High (2462MHz) Chain0 Power set 30
- IEEE 802.11gn HT20 Channel Low (2412MHz) Chain0/1 Power set 47/49
- IEEE 802.11gn HT20 Channel Mid (2437MHz) Chain0/1 Power set 54/57
- IEEE 802.11gn HT20 Channel High (2462MHz) Chain0/1 Power set 44/44
- IEEE 802.11gn HT40 Channel Low (2422MHz) Chain0/1 Power set 45/48
- IEEE 802.11gn HT40 Channel Mid (2437MHz) Chain0/1 Power set 44/47
- IEEE 802.11gn HT40 Channel High (2452MHz) Chain0/1 Power set 46/46

3. All of the functions are under run.
4. Start test.



## 7. FCC PART 15.247 REQUIREMENTS

### 7.1 6dB BANDWIDTH

#### LIMITS

§ 15.247(a) (2) For direct sequence systems, the minimum 6dB bandwidth shall be at least 500kHz.

#### TEST EQUIPMENT

Name of Equipment	Manufacturer	Model	Serial Number	Calibration Due
Spectrum Analyzer	Agilent	E4446A	MY43360132	06/10/2015

*Remark: Each piece of equipment is scheduled for calibration once a year.*

#### TEST SETUP



#### TEST PROCEDURE

1. The transmitter output was connected to a spectrum analyzer.
2. Set RBW = 100 kHz.
3. Set the video bandwidth (VBW)  $\geq 3 \times$  RBW.
4. Detector = Peak.
5. Trace mode = max hold.
6. Sweep = auto couple.
7. Allow the trace to stabilize.
8. Measure the maximum width of the emission that is constrained by the frequencies associated with the two outermost amplitude points (upper and lower frequencies) that are attenuated by 6 dB relative to the maximum level measured in the fundamental emission.



**TEST RESULTS**

**IEEE 802.11b Mode (1TX)**

Channel	Channel Frequency (MHz)	6dB Bandwidth (MHz)	Minimum Limit (kHz)	Pass / Fail
		Chain 0		
Low	2412	10.020	500	PASS
Middle	2437	10.040	500	PASS
High	2462	10.025	500	PASS

**IEEE 802.11g Mode (1TX)**

Channel	Channel Frequency (MHz)	6dB Bandwidth (MHz)	Minimum Limit (kHz)	Pass / Fail
		Chain 0		
Low	2412	16.565	500	PASS
Middle	2437	16.540	500	PASS
High	2462	16.540	500	PASS

**IEEE 802.11gn HT20 Mode (2TX)**

Channel	Channel Frequency (MHz)	6dB Bandwidth (MHz)		Minimum Limit (kHz)	Pass / Fail
		Chain 0	Chain 1		
Low	2412	17.745	16.525	500	PASS
Middle	2437	17.765	16.560	500	PASS
High	2462	17.755	16.550	500	PASS

**IEEE 802.11gn HT40 Mode (2TX)**

Channel	Channel Frequency (MHz)	6dB Bandwidth (MHz)		Minimum Limit (kHz)	Pass / Fail
		Chain 0	Chain 1		
Low	2422	36.395	36.405	500	PASS
Middle	2437	36.385	36.425	500	PASS
High	2452	36.375	36.395	500	PASS



**6dB BANDWIDTH**

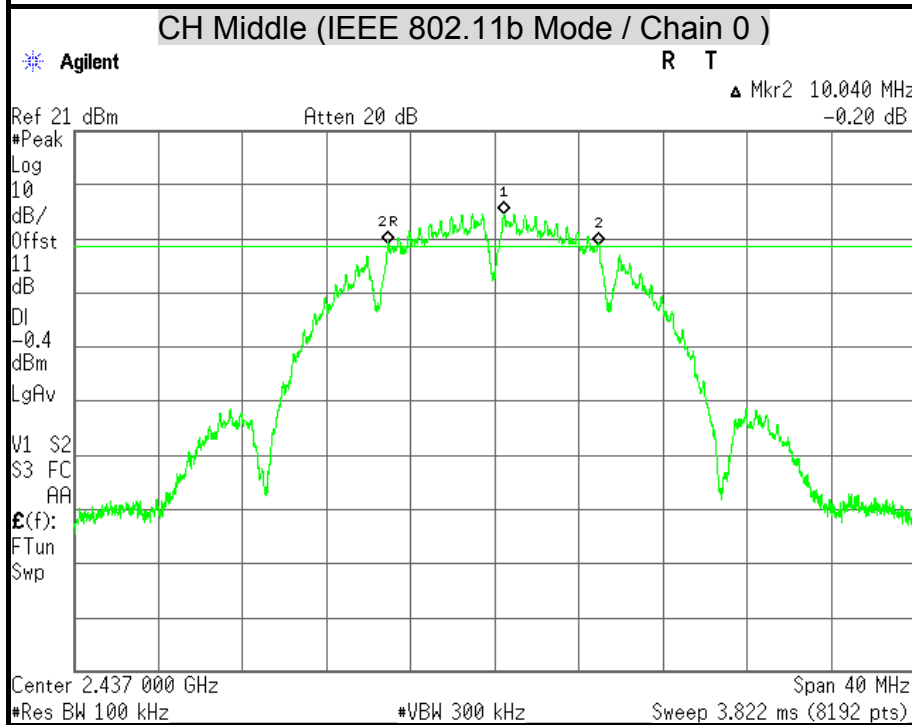
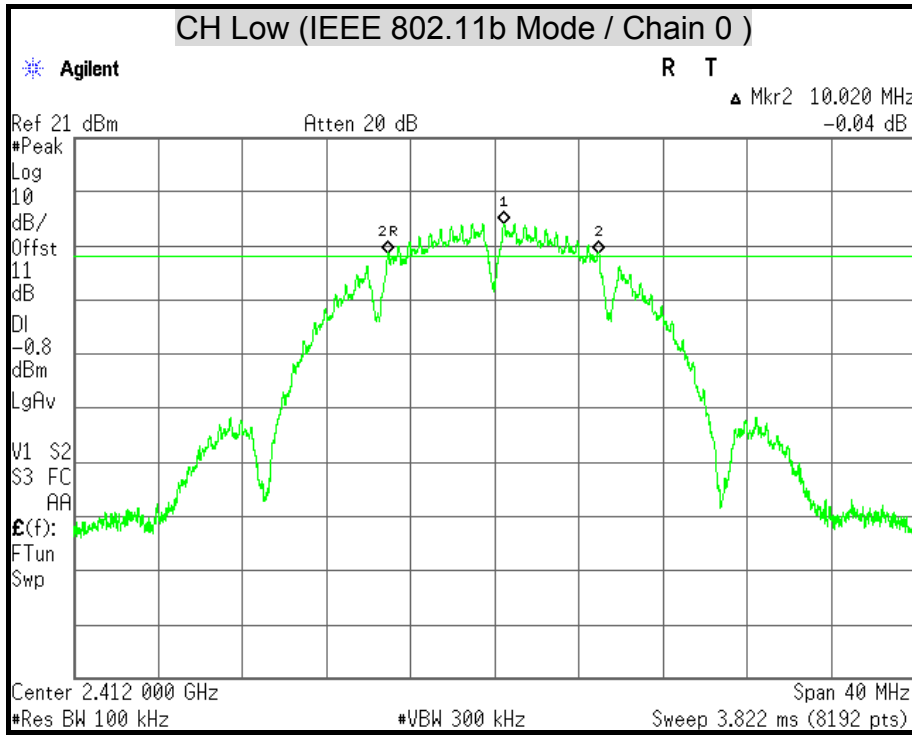

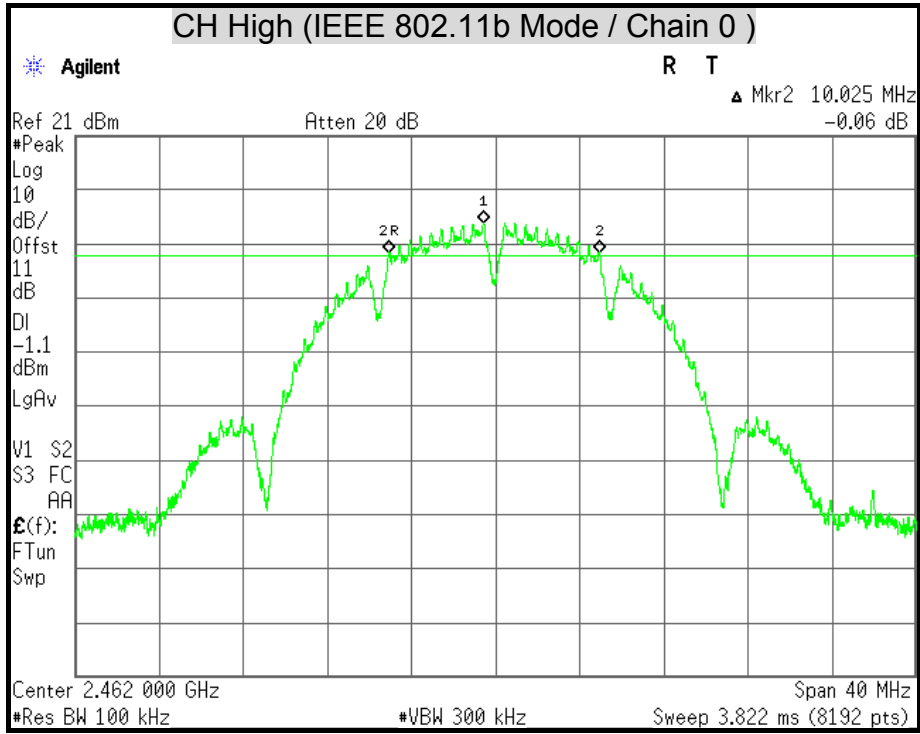

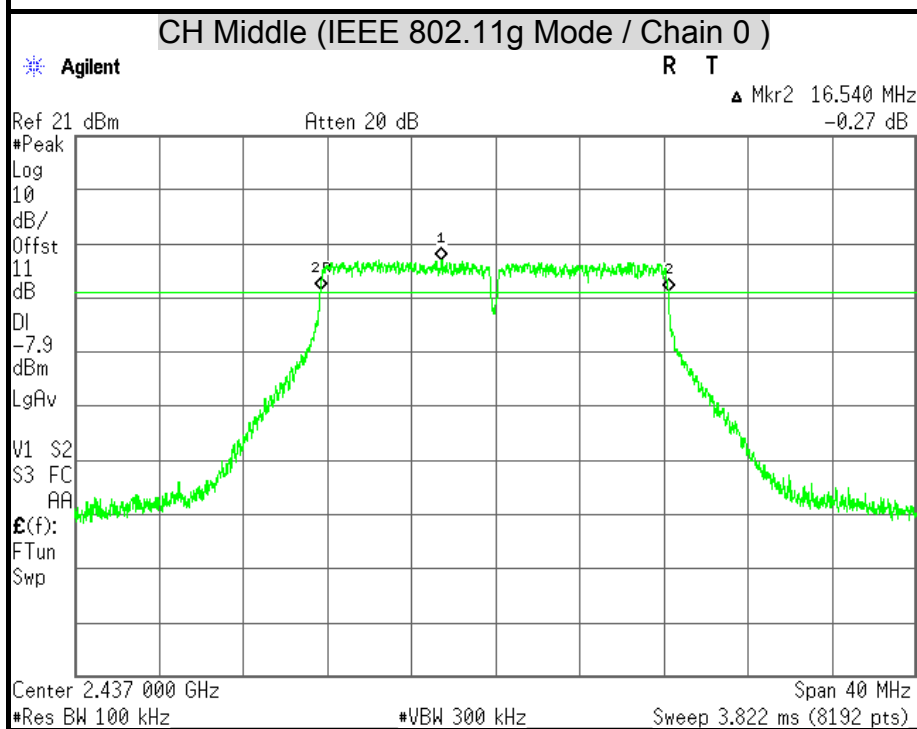
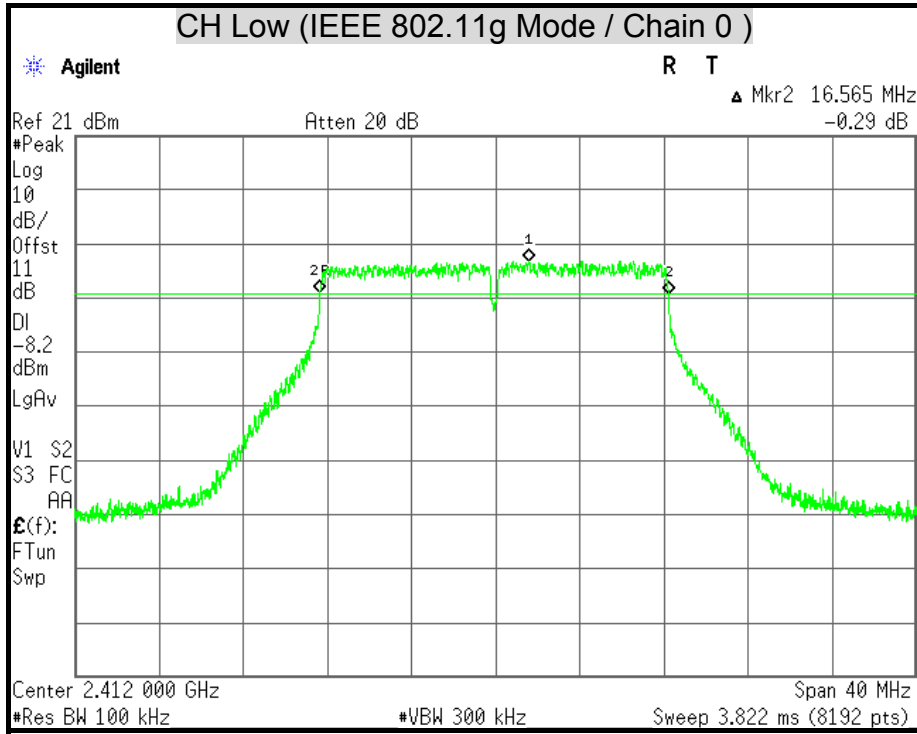



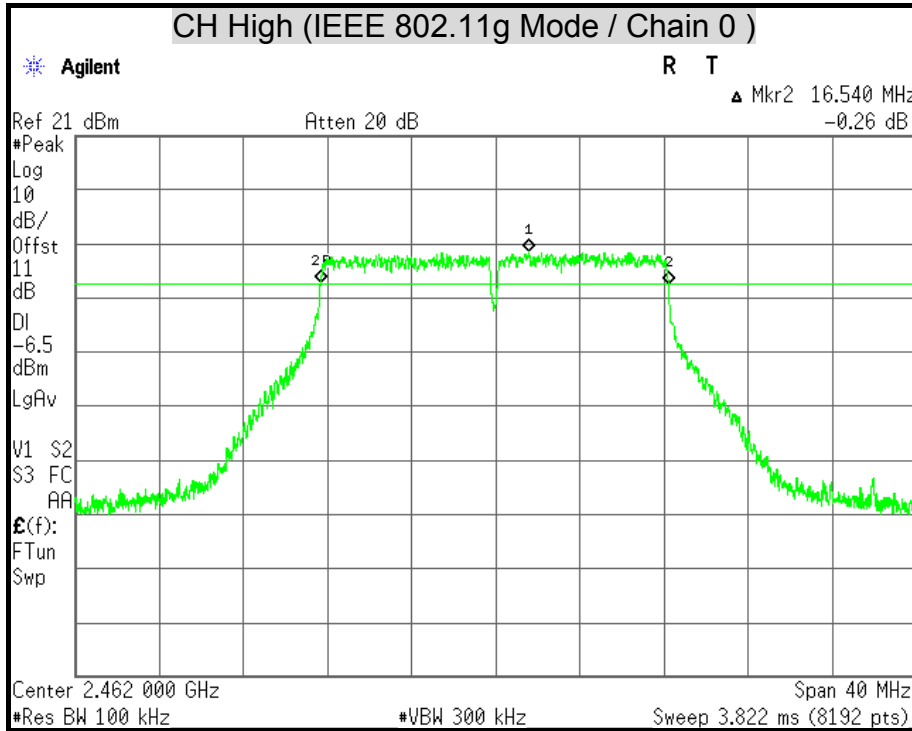

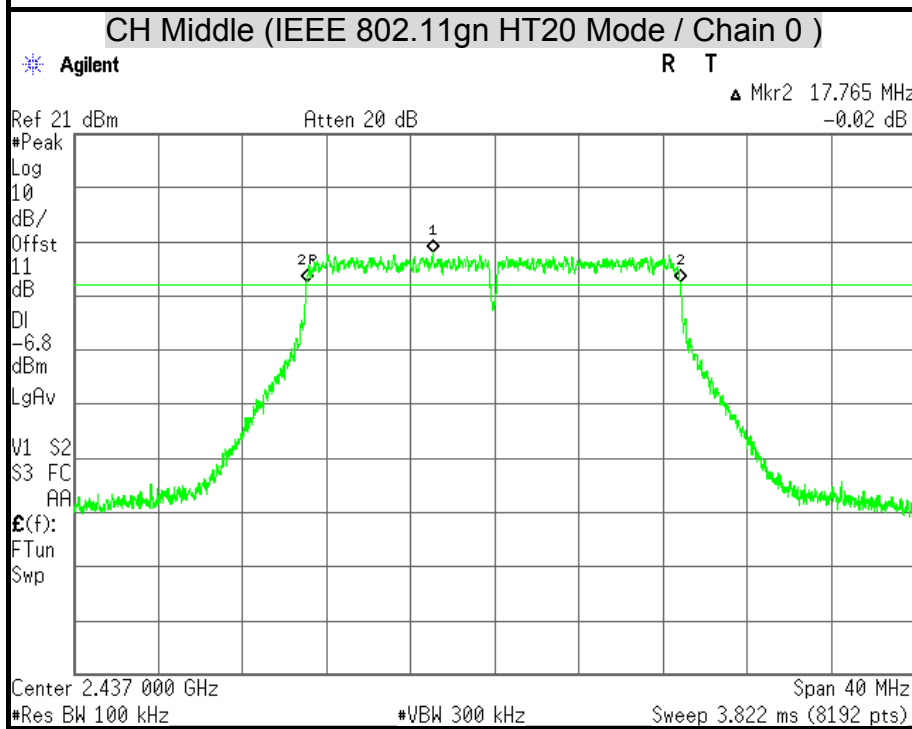
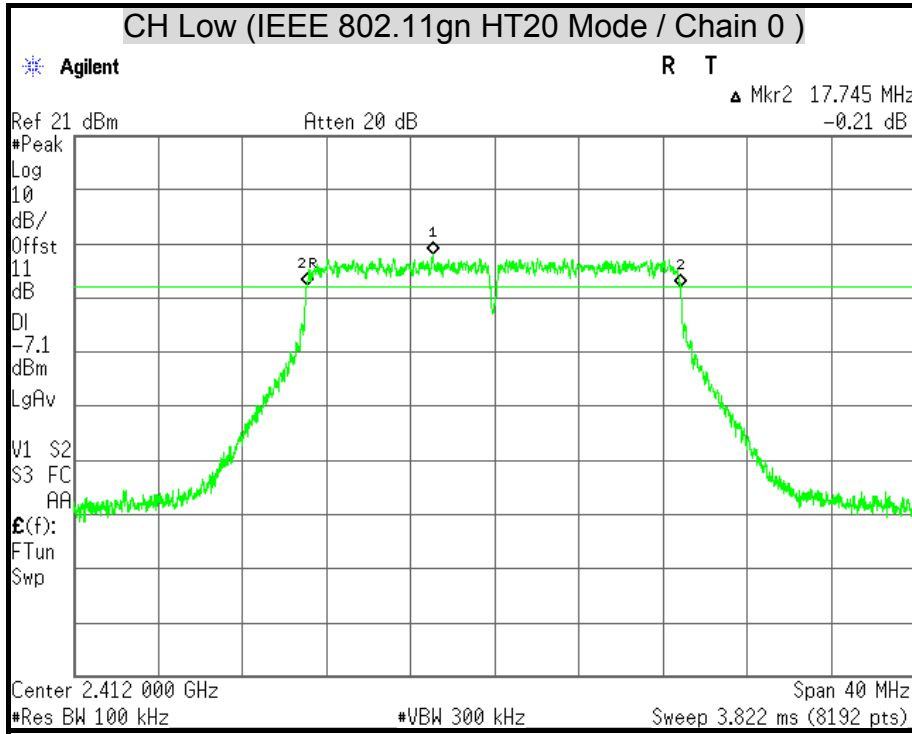

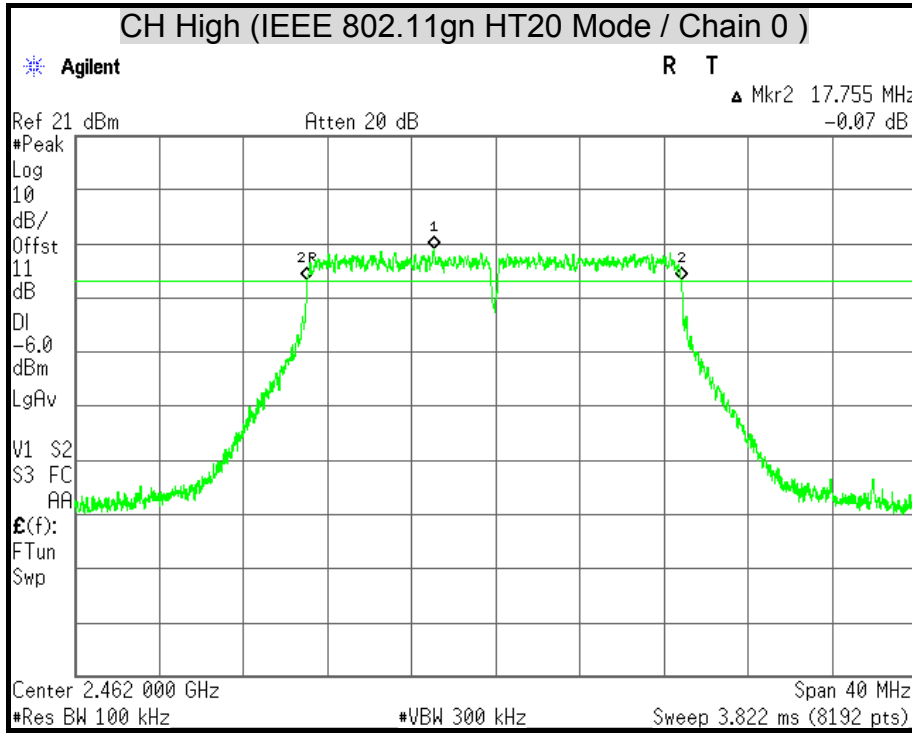

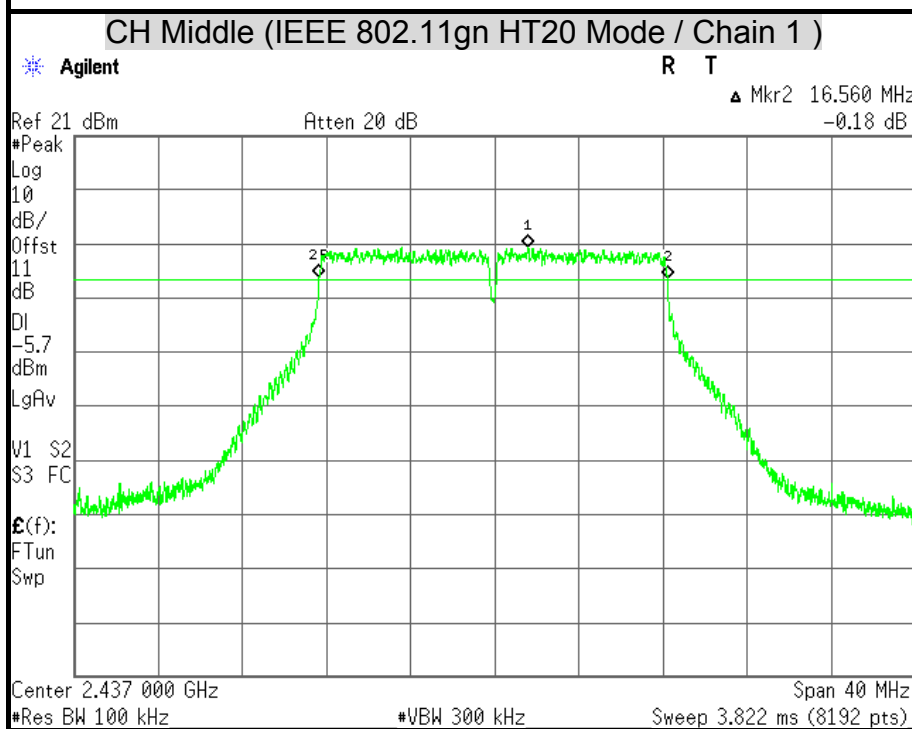
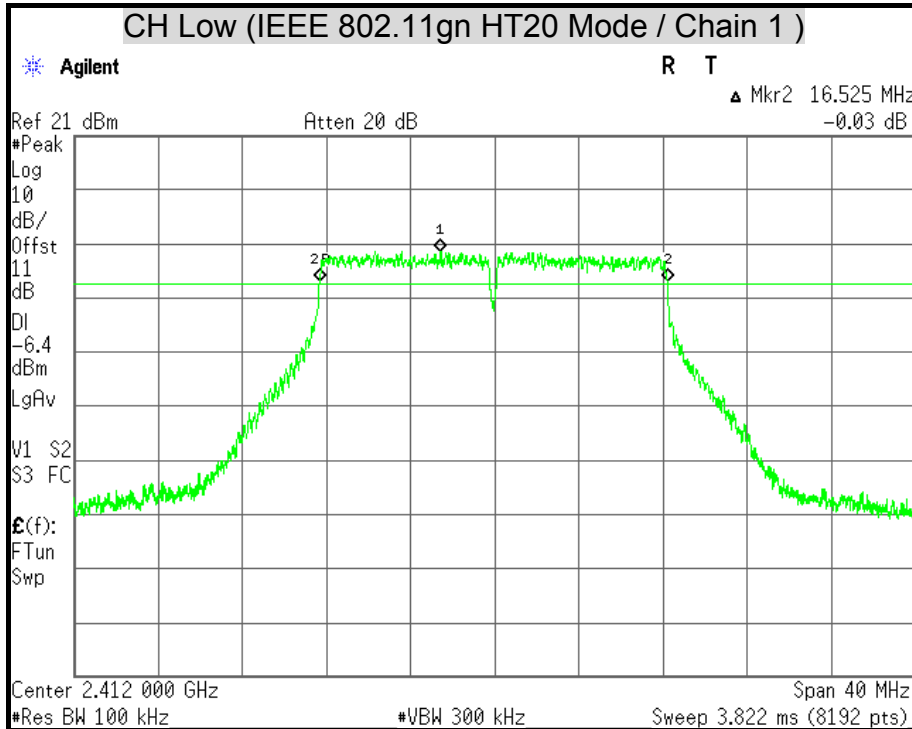

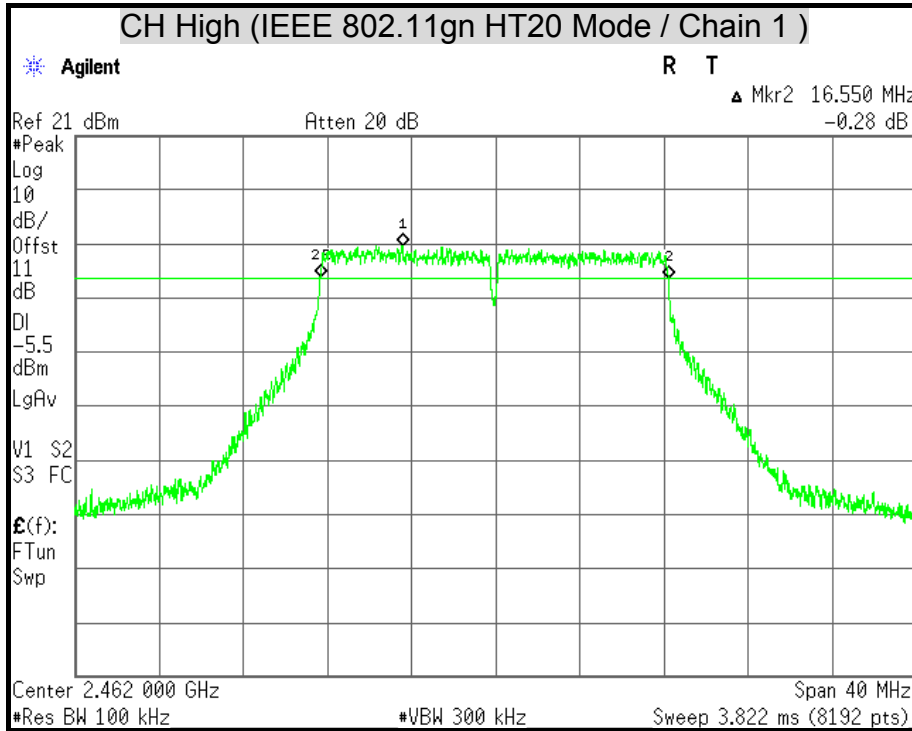

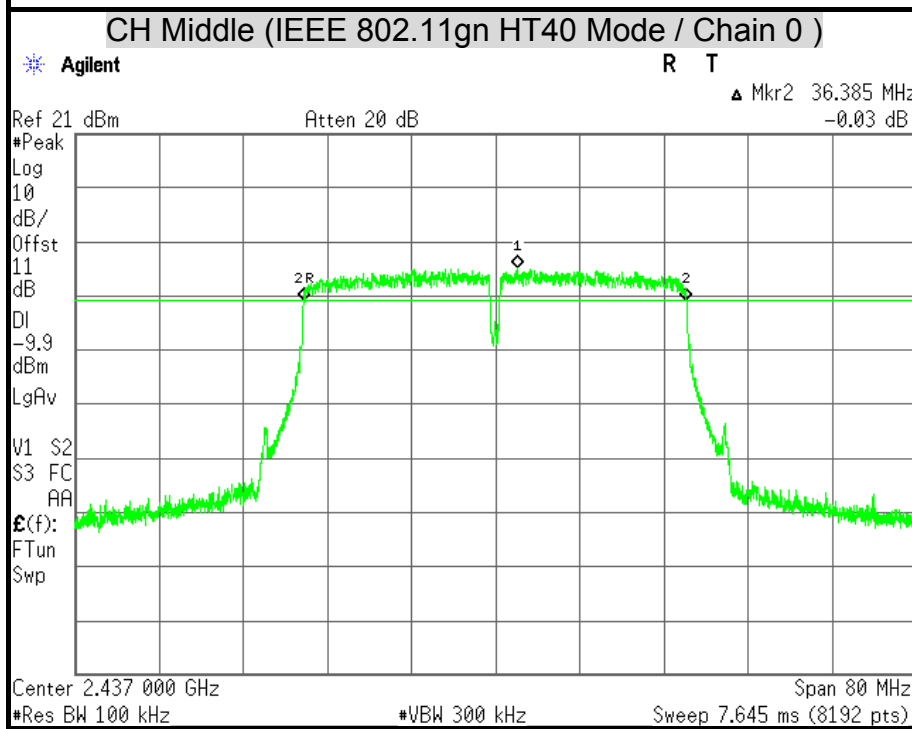
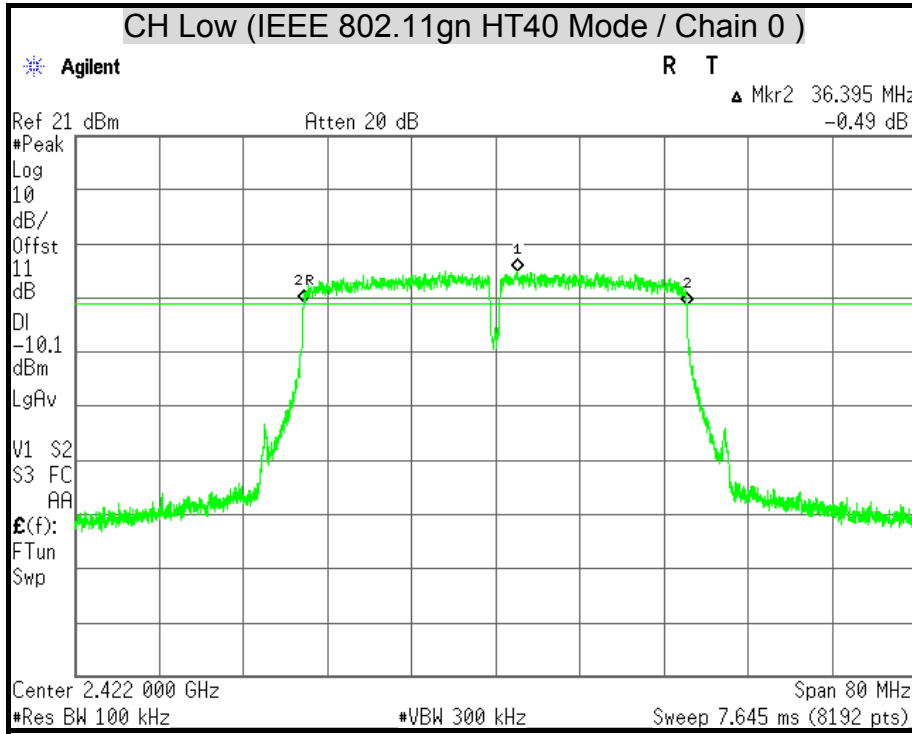

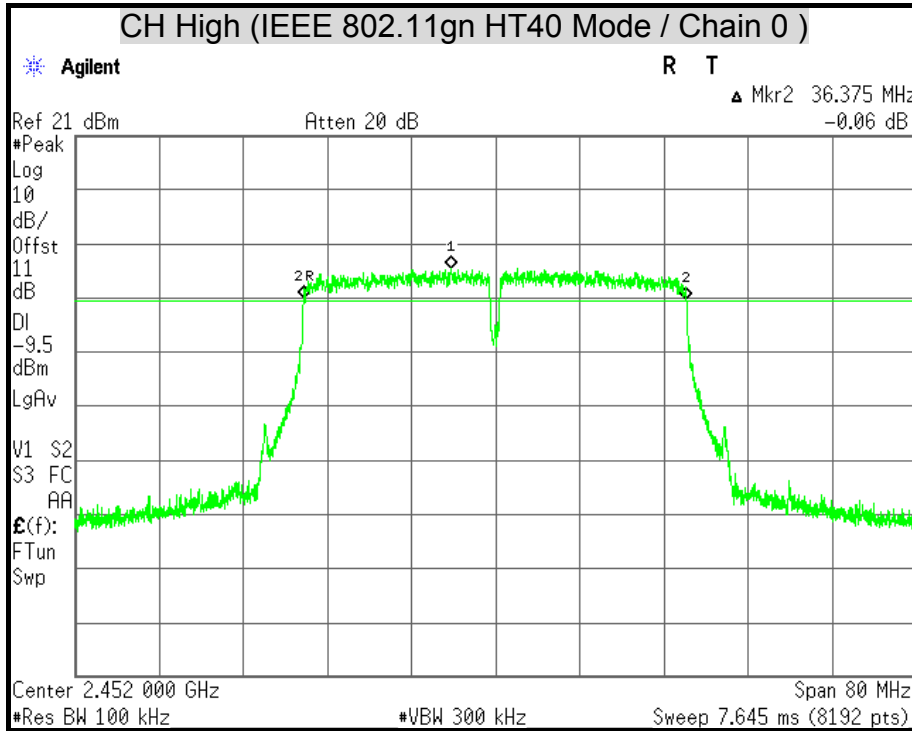

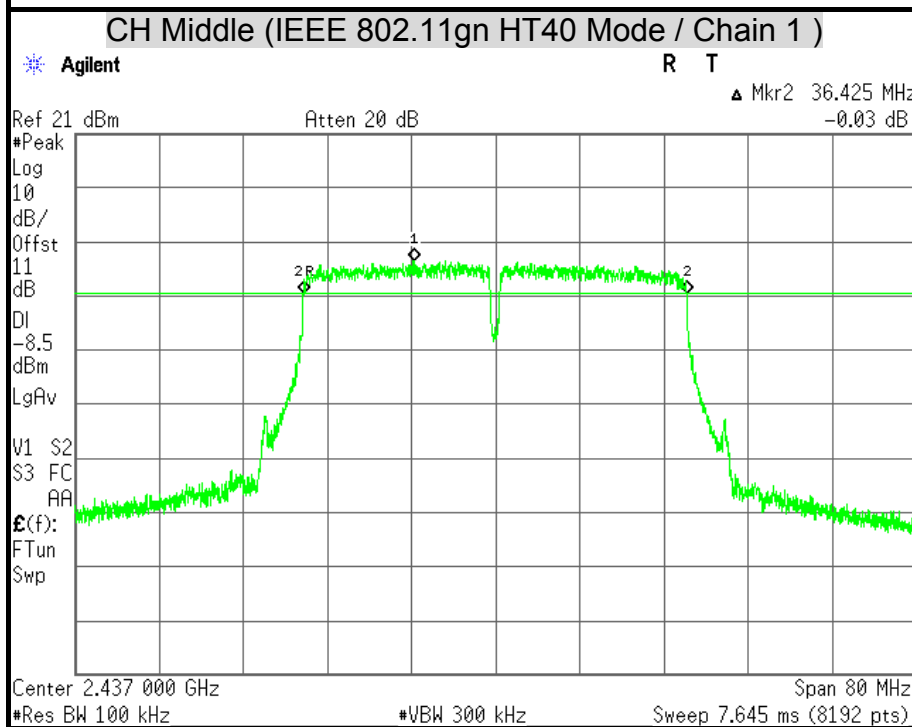
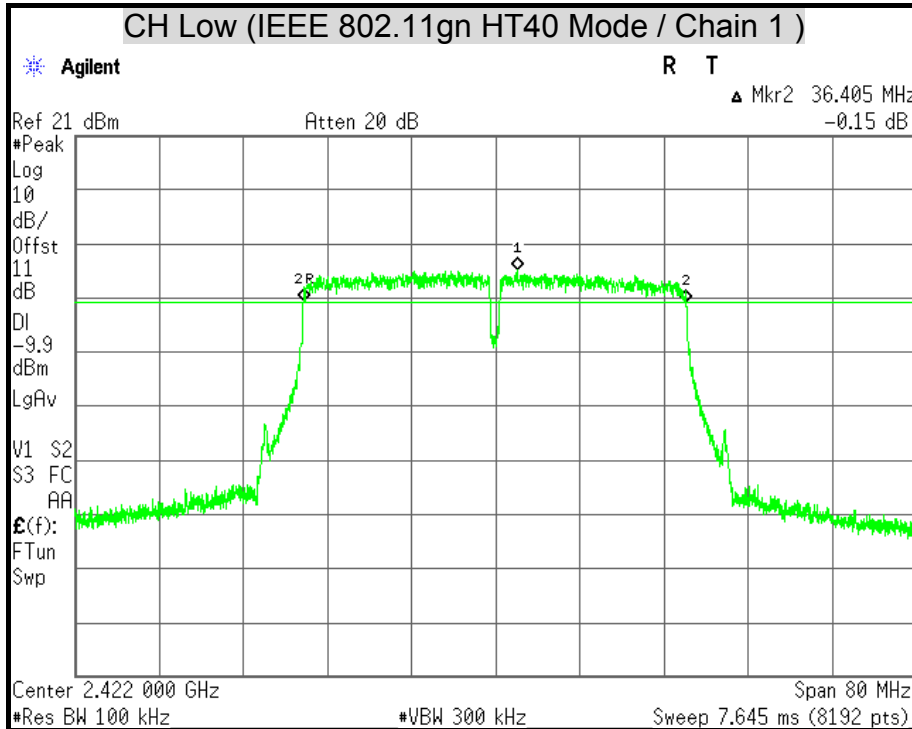



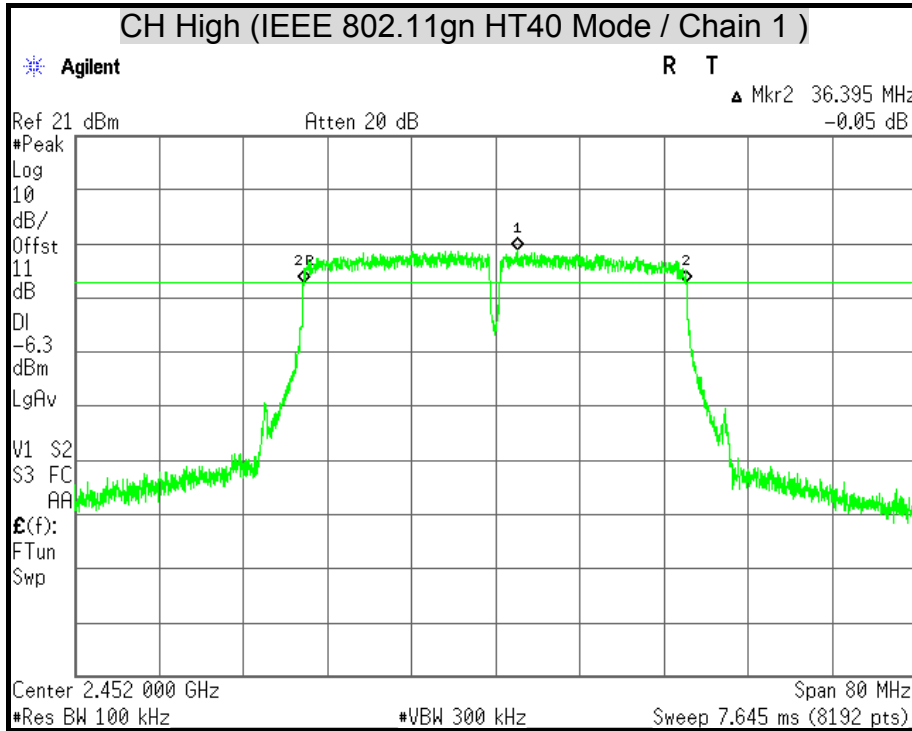



## 7.2 MAXIMUM PEAK OUTPUT POWER

### LIMITS

§ 15.247(b) The maximum peak output power of the intentional radiator shall not exceed the following :

§ 15.247(b) (3) For systems using digital modulation in the 902-928 MHz, 2400-2483.5 MHz, and 5725-5850 MHz bands : 1 watt.

§ 15.247(b) (4) Except as shown in paragraphs (c) of this section, if transmitting antennas of directional gain greater than 6 dBi are used the peak output power from the intentional radiator shall be reduced below the stated values in paragraphs (b)(1) or (b)(2), and (b)(3) of this section, as appropriate, by the amount in dB that the directional gain of the antenna exceeds 6 dBi.

§ KDB 662911 : For power measurements on IEEE 802.11 devices

Array Gain = 0 dB (i.e., no array gain) for  $N_{ANT} \leq 4$  ;

Array Gain = 0 dB (i.e., no array gain) for channel widths  $\geq 40$  MHz for any  $N_{ANT}$  ;

Array Gain =  $5 \log(N_{ANT}/N_{SS})$  dB or 3 dB, whichever is less for 20-MHz channel widths with  $N_{ANT} \geq 5$ .

### TEST EQUIPMENT

Name of Equipment	Manufacturer	Model	Serial Number	Calibration Due
Power Meter	Anritsu	ML2495A	1149001	12/11/2015
Power Sensor	Anritsu	MA2411B	1126148	12/11/2015

*Remark: Each piece of equipment is scheduled for calibration once a year.*

### TEST SETUP



### TEST PROCEDURE

The transmitter output is connected to the power meter. The power meter is set to the peak power detection.



**TEST RESULTS**

**IEEE 802.11b Mode (1TX)**

Channel	Channel Frequency (MHz)	Peak Power		Peak Power Limit		Pass / Fail
		Chain 0		(dBm)	(W)	
		(dBm)	(W)			
Low	2412	16.54	0.0451	30	1	PASS
Middle	2437	16.37	0.0434	30	1	PASS
High	2462	17.03	0.0505	30	1	PASS

**Remark:**

1. At final test to get the worst-case emission at 1Mbps.
2. The cable assembly insertion loss of 11 dB (including 10 dB pad and 1 dB cable) was Entered as an offset in the power meter to allow for direct reading of power.

**IEEE 802.11g Mode (1TX)**

Channel	Channel Frequency (MHz)	Peak Power		Peak Power Limit		Pass / Fail
		Chain 0		(dBm)	(W)	
		(dBm)	(W)			
Low	2412	20.77	0.1194	30	1	PASS
Middle	2437	20.14	0.1033	30	1	PASS
High	2462	21.72	0.1486	30	1	PASS

**Remark:**

1. At final test to get the worst-case emission at 6Mbps.
2. The cable assembly insertion loss of 11 dB (including 10 dB pad and 1 dB cable) was Entered as an offset in the power meter to allow for direct reading of power.



IEEE 802.11gn HT20 Mode (2TX)

Channel	Channel Frequency (MHz)	Peak Power (dBm)		Peak Power Total		Peak Power Limit		Pass / Fail
		Chain 0	Chain 1	(dBm)	(W)	(dBm)	(W)	
Low	2412	22.09	21.94	25.03	0.3184	30	1	PASS
Middle	2437	23.87	24.72	27.33	0.5408	30	1	PASS
High	2462	19.76	19.64	22.71	0.1866	30	1	PASS

Remark:

1. At final test to get the worst-case emission at 6.5Mbps.
2. The cable assembly insertion loss of 11 dB (including 10 dB pad and 1 dB cable) was Entered as an offset in the power meter to allow for direct reading of power.
3. Array gain = 0 dB for  $N_{ANT} \leq 4$ , power limit do not reduce.
4. Total power = Chain 0 + Chain 1.

IEEE 802.11gn HT40 Mode (2TX)

Channel	Channel Frequency (MHz)	Peak Power (dBm)		Peak Power Total		Peak Power Limit		Pass / Fail
		Chain 0	Chain 1	(dBm)	(W)	(dBm)	(W)	
Low	2422	23.23	23.92	26.60	0.4571	30	1	PASS
Middle	2437	22.46	22.74	25.61	0.3639	30	1	PASS
High	2452	23.52	22.08	25.87	0.3864	30	1	PASS

Remark:

1. At final test to get the worst-case emission at 13.5Mbps.
2. The cable assembly insertion loss of 11 dB (including 10 dB pad and 1 dB cable) was Entered as an offset in the power meter to allow for direct reading of power.
3. Array gain = 0 dB for  $N_{ANT} \leq 4$ , power limit do not reduce.
4. Total power = Chain 0 + Chain 1.



### 7.3 AVERAGE POWER

#### LIMITS

None; for reporting purposes only.

#### TEST EQUIPMENT

Name of Equipment	Manufacturer	Model	Serial Number	Calibration Due
Power Meter	ANRITSU	ML2495A	1149001	12/11/2015
Power Sensor	ANRITSU	MA2411B	1126148	12/11/2015

*Remark: Each piece of equipment is scheduled for calibration once a year.*

#### TEST SETUP



#### TEST PROCEDURE

The transmitter output is connected to the power meter. The power meter is set to the average power detection.



**TEST RESULTS**

**IEEE 802.11b Mode (1TX)**

Channel	Channel Frequency (MHz)	Average Power (dBm)
		Chain 0
Low	2412	14.55
Middle	2437	14.36
High	2462	14.97

**Remark:**

1. At final test to get the worst-case emission at 1Mbps.
2. The cable assembly insertion loss of 11 dB (including 10 dB pad and 1 dB cable) was Entered as an offset in the power meter to allow for direct reading of power.

**IEEE 802.11g Mode (1TX)**

Channel	Channel Frequency (MHz)	Average Power (dBm)
		Chain 0
Low	2412	13.17
Middle	2437	12.79
High	2462	13.67

**Remark:**

1. At final test to get the worst-case emission at 6Mbps.
2. The cable assembly insertion loss of 11 dB (including 10 dB pad and 1 dB cable) was Entered as an offset in the power meter to allow for direct reading of power.



**IEEE 802.11gn HT20 Mode (2TX)**

Channel	Channel Frequency (MHz)	Average Power (dBm)	
		Chain 0	Chain 1
Low	2412	17.21	16.86
Middle	2437	19.85	20.27
High	2462	15.19	14.84

**Remark:**

1. At final test to get the worst-case emission at 6.5Mbps.
2. The cable assembly insertion loss of 11 dB (including 10 dB pad and 1 dB cable) was Entered as an offset in the power meter to allow for direct reading of power.

**IEEE 802.11gn HT40 Mode (2TX)**

Channel	Channel Frequency (MHz)	Average Power (dBm)	
		Chain 0	Chain 1
Low	2422	15.23	15.61
Middle	2437	14.53	14.88
High	2452	14.77	14.67

**Remark:**

1. At final test to get the worst-case emission at 13.5Mbps.
2. The cable assembly insertion loss of 11 dB (including 10 dB pad and 1 dB cable) was Entered as an offset in the power meter to allow for direct reading of power.



### 7.4 POWER SPECTRAL DENSITY

#### LIMITS

§ 15.247(e) For digitally modulated systems, the power spectral density conducted from the intentional radiator to the antenna shall not greater than 8 dBm in any 3 kHz band during any time interval of continuous transmission.

#### TEST EQUIPMENT

Name of Equipment	Manufacturer	Model	Serial Number	Calibration Due
Spectrum Analyzer	Agilent	E4446A	MY43360132	06/10/2015

*Remark: Each piece of equipment is scheduled for calibration once a year.*

#### TEST SETUP



#### TEST PROCEDURE

1. The transmitter output was connected to the spectrum analyzer.
2. Set analyzer center frequency to DTS channel center frequency.
3. Set the span to 1.5 times the DTS channel bandwidth.
4. Set the RBW to:  $3 \text{ kHz} \leq \text{RBW} \leq 100 \text{ kHz}$ .
5. Set the VBW  $\geq 3 \times \text{RBW}$ .
6. Detector = peak.
7. Sweep time = auto couple.
8. Trace mode = max hold.
9. Allow trace to fully stabilize.
10. Use the peak marker function to determine the maximum amplitude level within the RBW.
11. If measured value exceeds limit, reduce RBW (no less than 3 kHz) and repeat.





**TEST RESULTS**

**IEEE 802.11b Mode (1TX)**

Channel	Channel Frequency (MHz)	Final RF Power Level in 3KHz BW (dBm)	Minimum Limit (dBm)	Pass / Fail
		Chain 0		
Low	2412	-15.27	8	PASS
Middle	2437	-15.22	8	PASS
High	2462	-15.31	8	PASS

**Remark:**

1. At final test to get the worst-case emission at 1Mbps.
2. The cable assembly insertion loss of 11 dB (including 10 dB pad and 1 dB cable) was Entered as an offset in the spectrum analyzer to allow for direct reading of power.

**IEEE 802.11g Mode (1TX)**

Channel	Channel Frequency (MHz)	Final RF Power Level in 3KHz BW (dBm)	Minimum Limit (dBm)	Pass / Fail
		Chain 0		
Low	2412	-16.16	8	PASS
Middle	2437	-15.94	8	PASS
High	2462	-14.90	8	PASS

**Remark:**

1. At final test to get the worst-case emission at 6Mbps.
2. The cable assembly insertion loss of 11 dB (including 10 dB pad and 1 dB cable) was Entered as an offset in the spectrum analyzer to allow for direct reading of power.



IEEE 802.11gn HT20 Mode (2TX)

Channel	Channel Frequency (MHz)	Final RF Power Level in 3KHz BW (dBm)		PSD Total (dBm)	Minimum Limit (dBm)	Pass / Fail
		Chain 0	Chain 1			
Low	2412	-15.30	-14.95	-12.11	7.09	PASS
Middle	2437	-14.69	-13.98	-11.31	7.09	PASS
High	2462	-13.75	-14.08	-10.90	7.09	PASS

Remark:

1. At final test to get the worst-case emission at 6.5Mbps.
2. The cable assembly insertion loss of 11 dB (including 10 dB pad and 1 dB cable) was Entered as an offset in the spectrum analyzer to allow for direct reading of power.
3. The maximum antenna gain is 6.91 dBi which is more than 6dBi, the limit should be 7.09 dBm.
4. Total power spectral density = Chain 0 + Chain 1.

IEEE 802.11gn HT40 Mode (2TX)

Channel	Channel Frequency (MHz)	Final RF Power Level in 3KHz BW (dBm)		PSD Total (dBm)	Minimum Limit (dBm)	Pass / Fail
		Chain 0	Chain 1			
Low	2422	-15.54	-15.52	-12.52	7.09	PASS
Middle	2437	-14.85	-15.04	-11.93	7.09	PASS
High	2452	-16.33	-13.62	-11.75	7.09	PASS

Remark:

1. At final test to get the worst-case emission at 13.5Mbps.
2. The cable assembly insertion loss of 11 dB (including 10 dB pad and 1 dB cable) was Entered as an offset in the spectrum analyzer to allow for direct reading of power.
3. The maximum antenna gain is 6.91 dBi which is more than 6dBi, the limit should be 7.09 dBm.
4. Total power spectral density = Chain 0 + Chain 1.



**POWER SPECTRAL DENSITY**

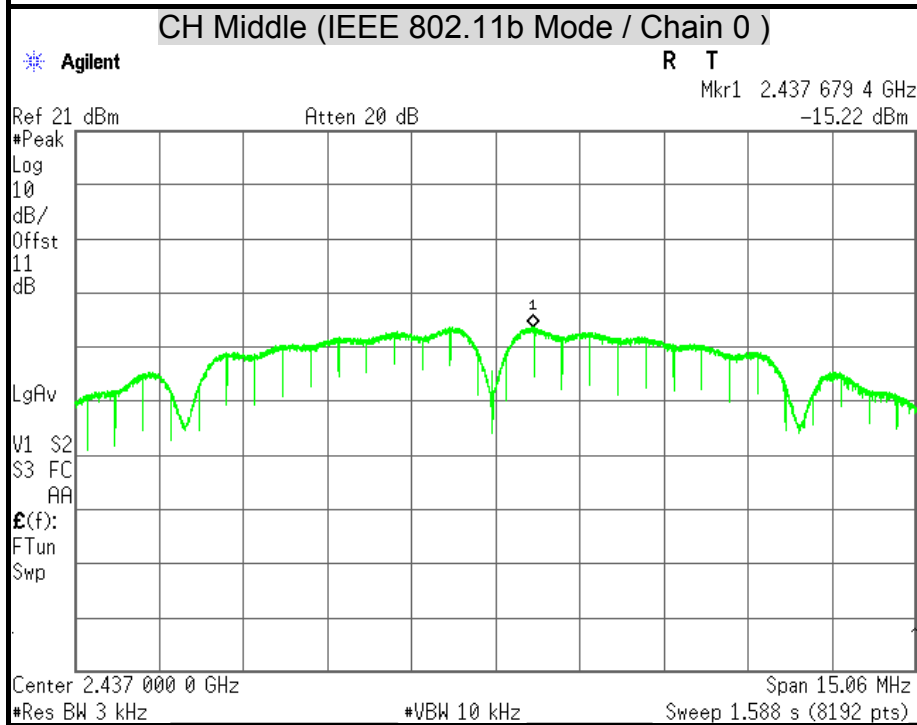
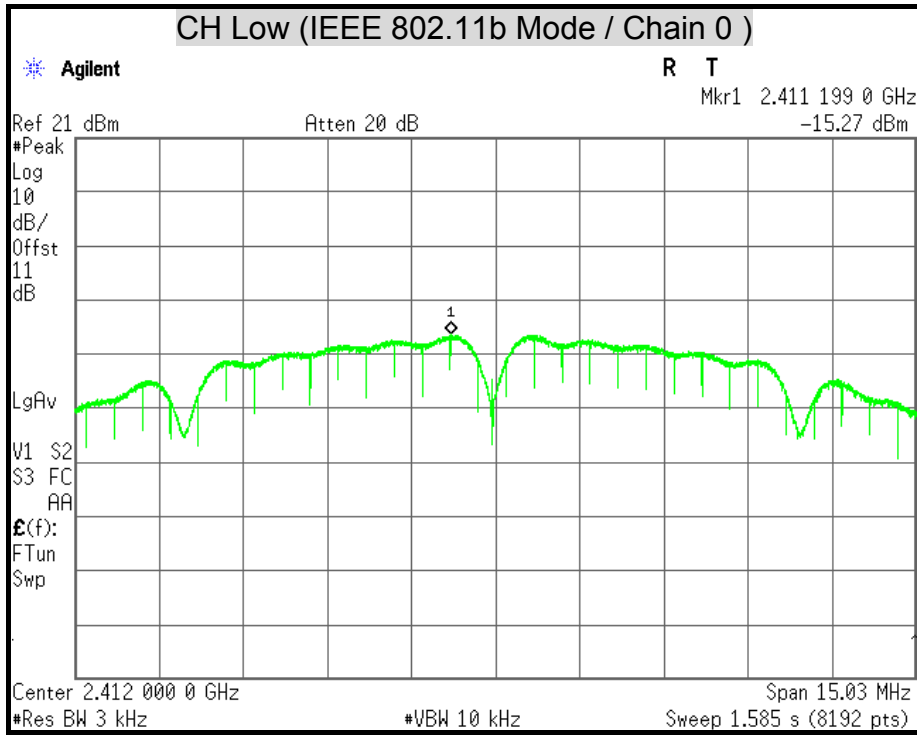

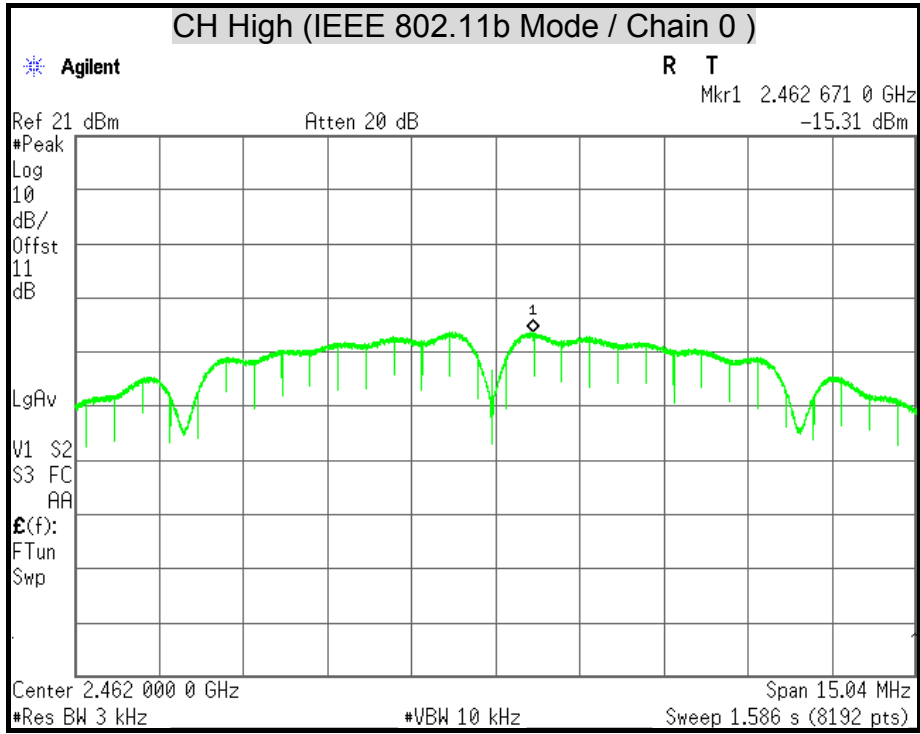

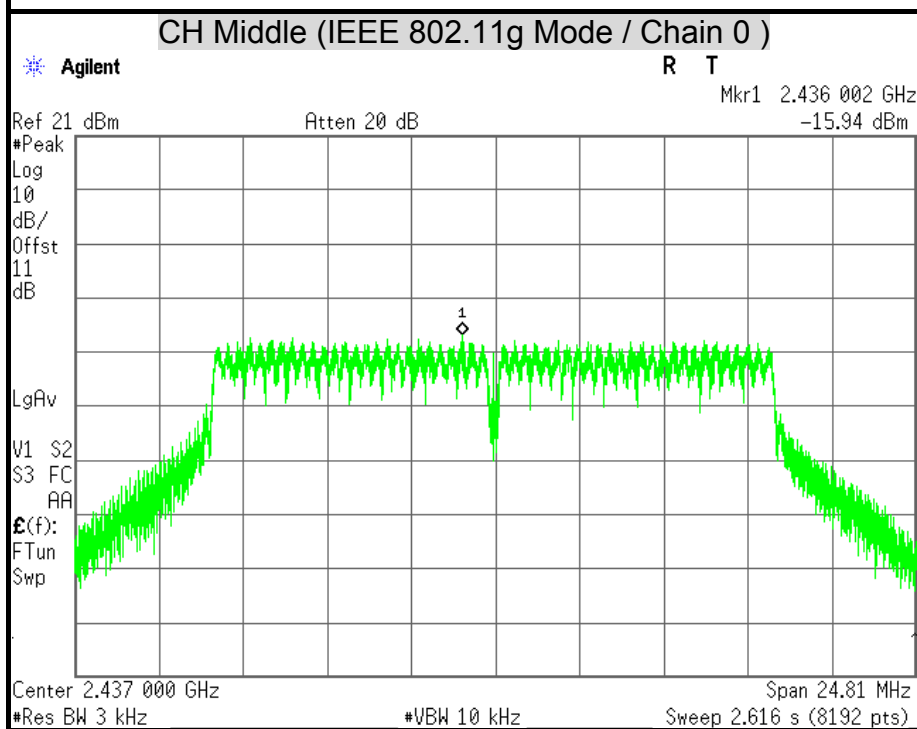
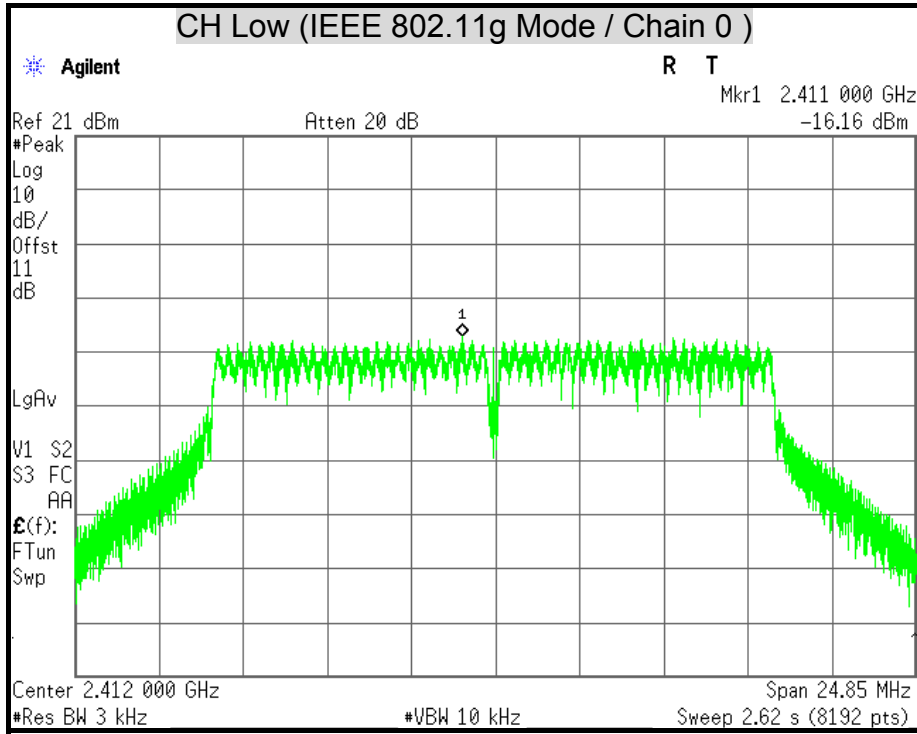

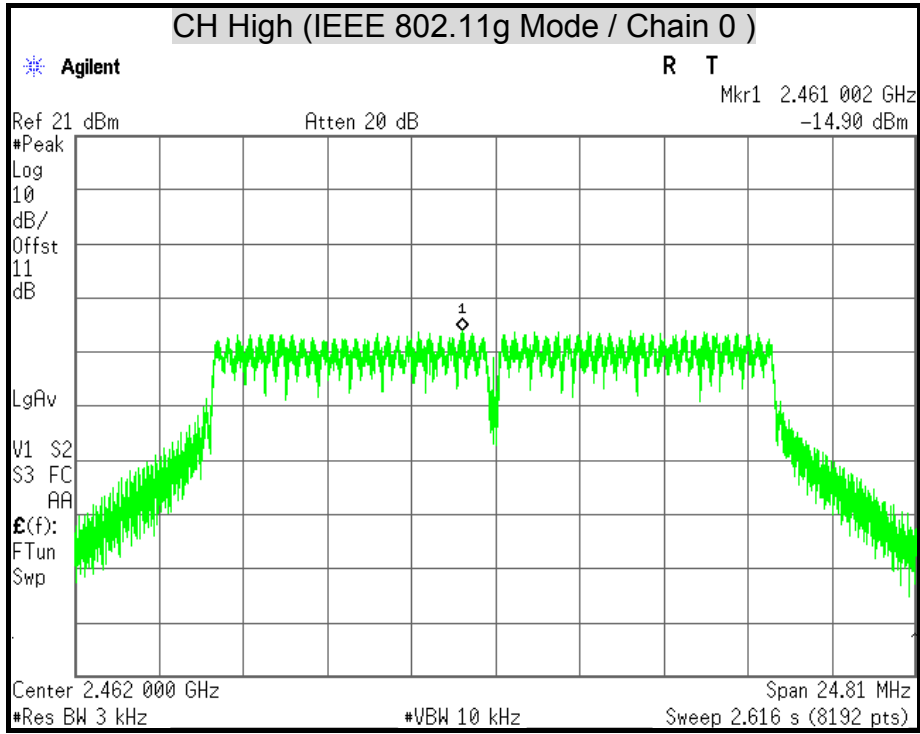

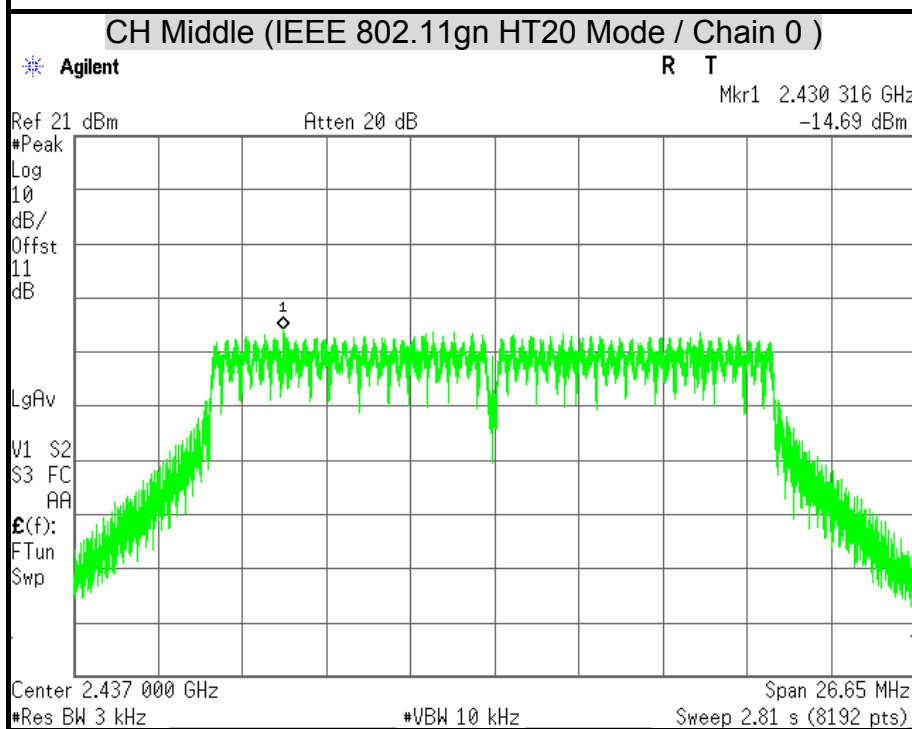
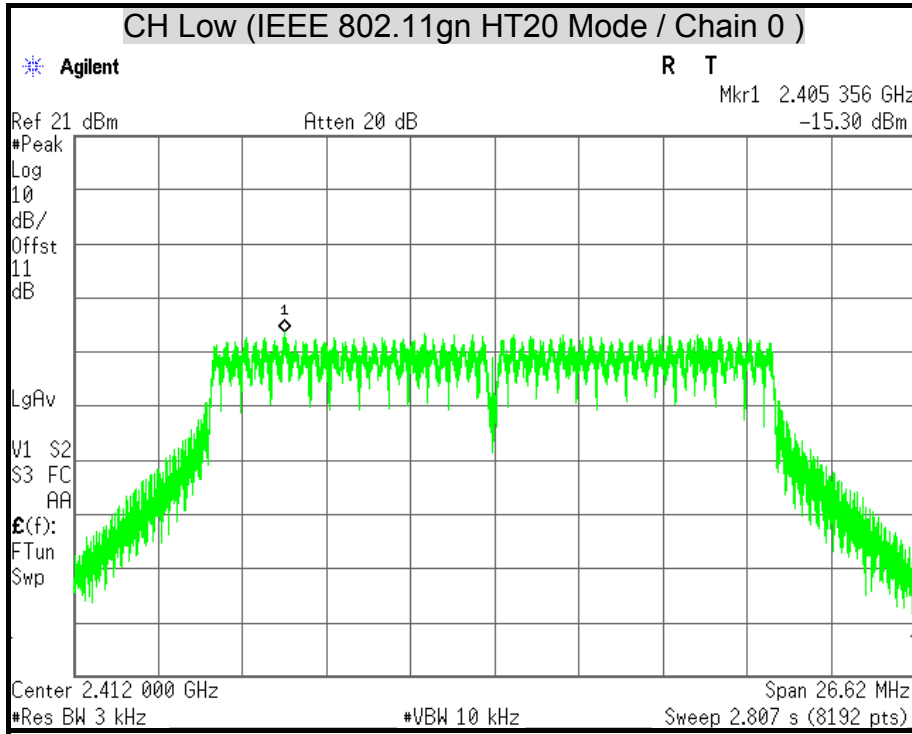

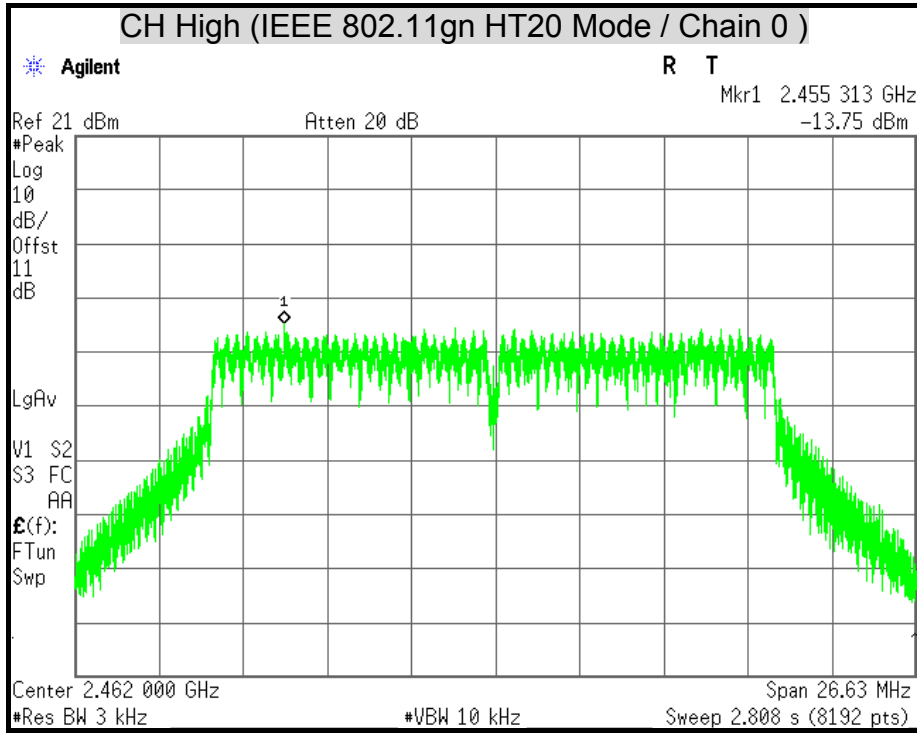



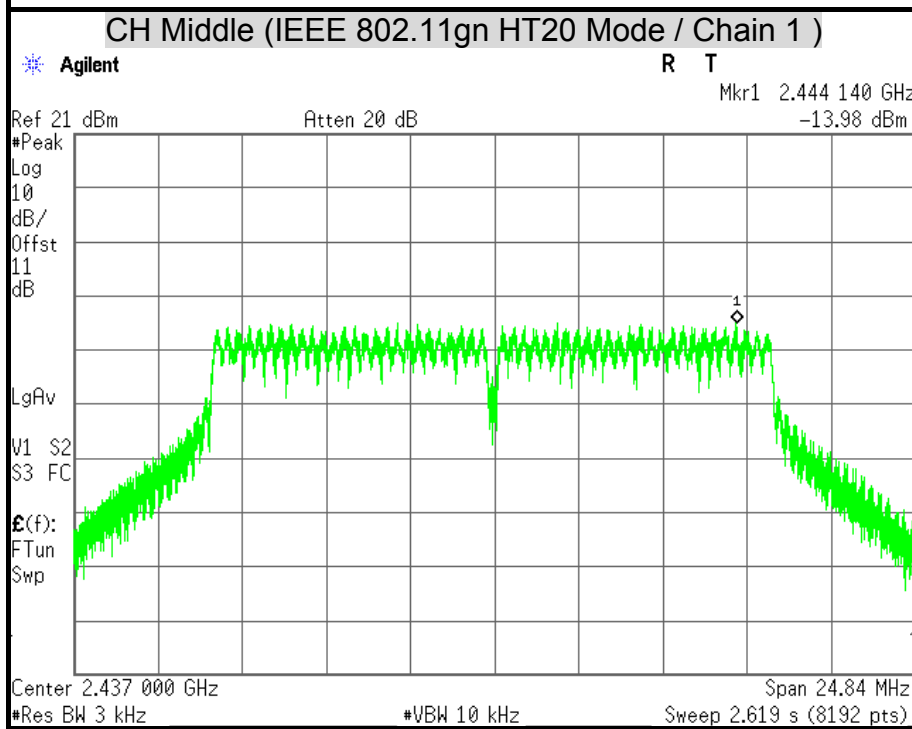
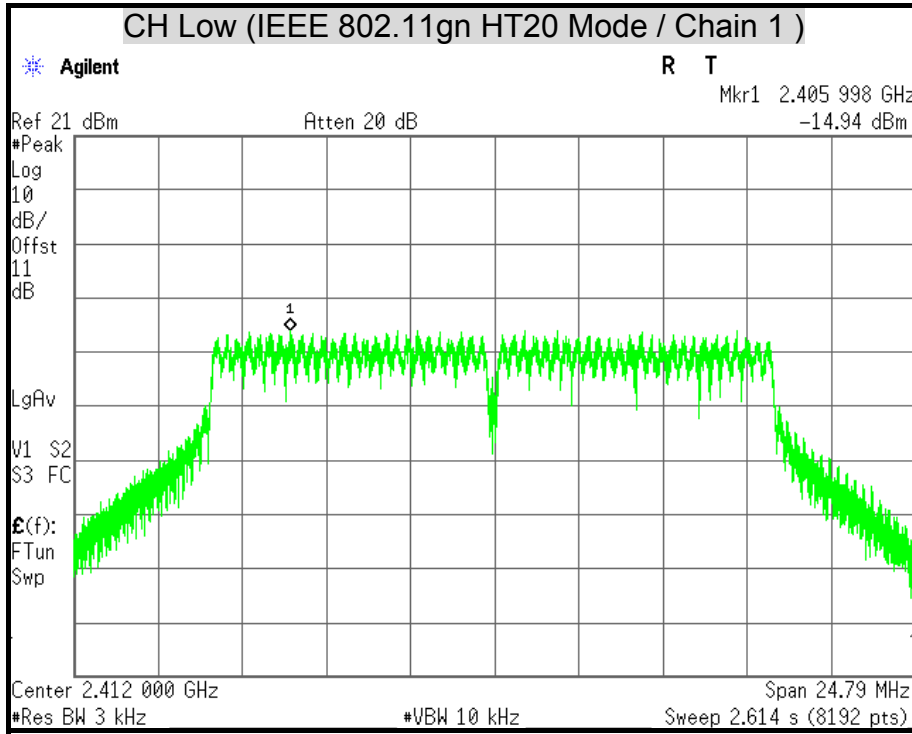

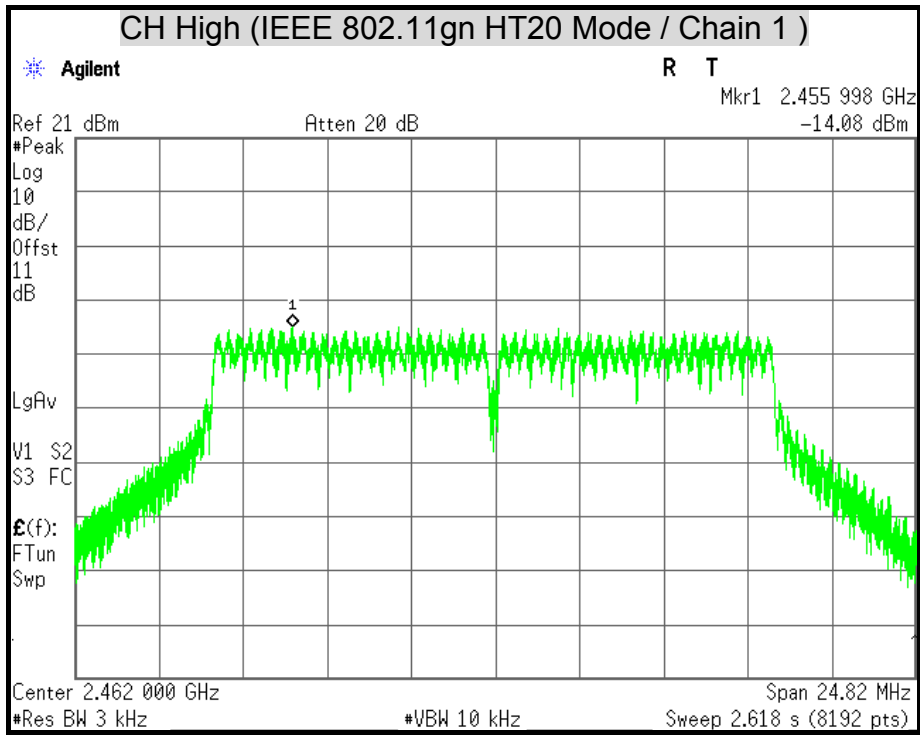

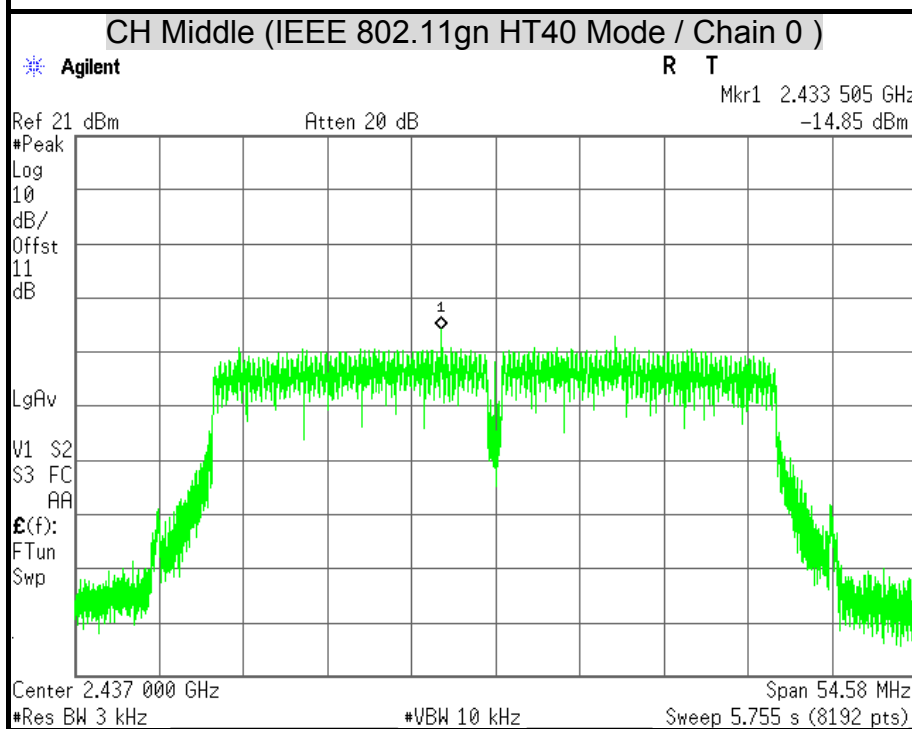
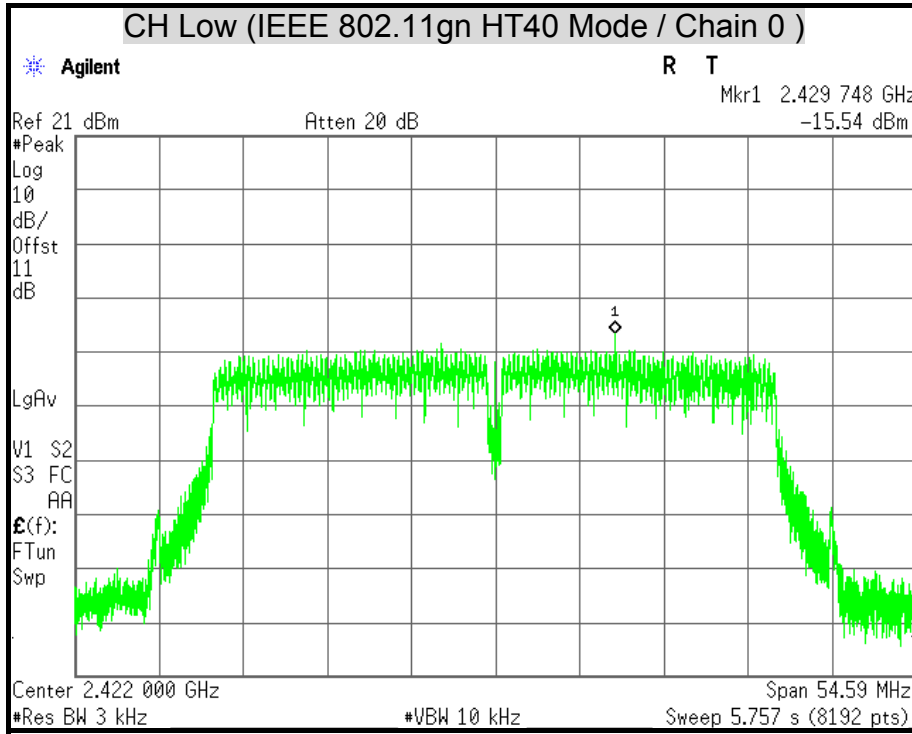

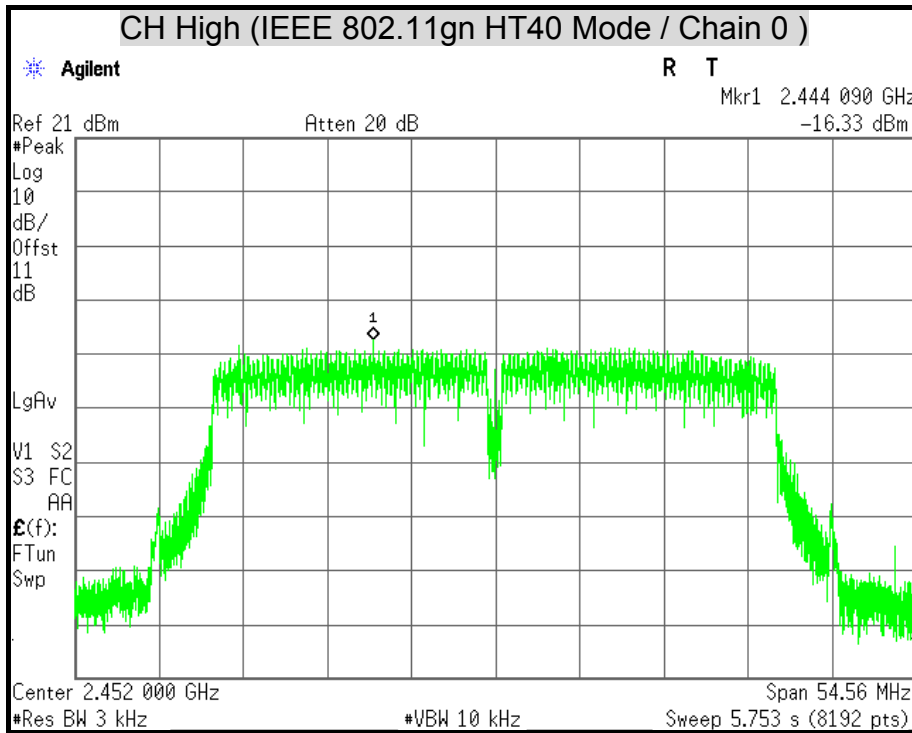

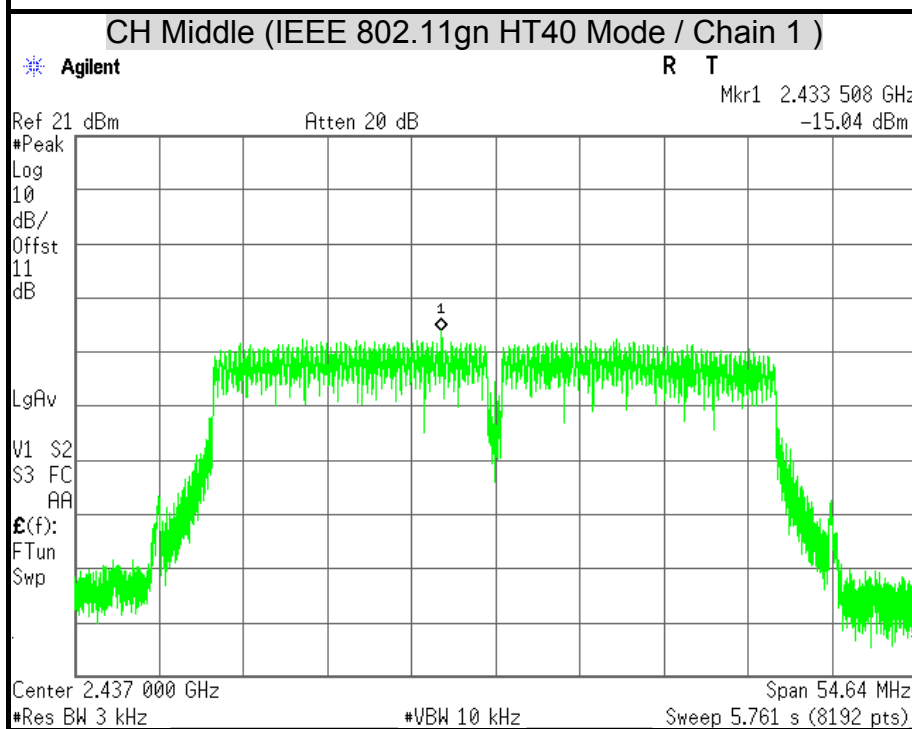
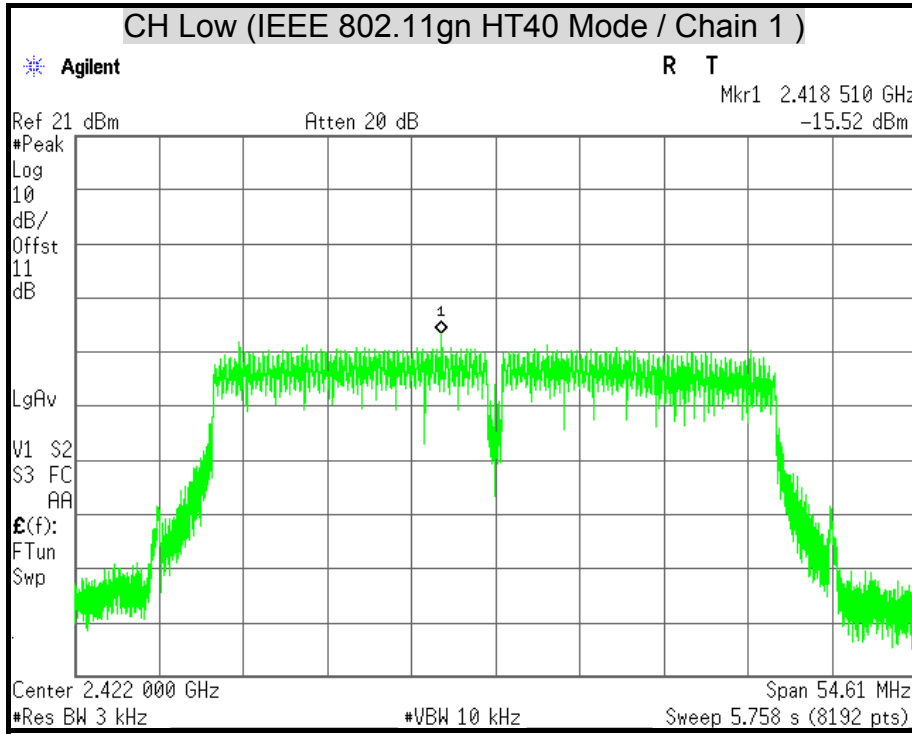

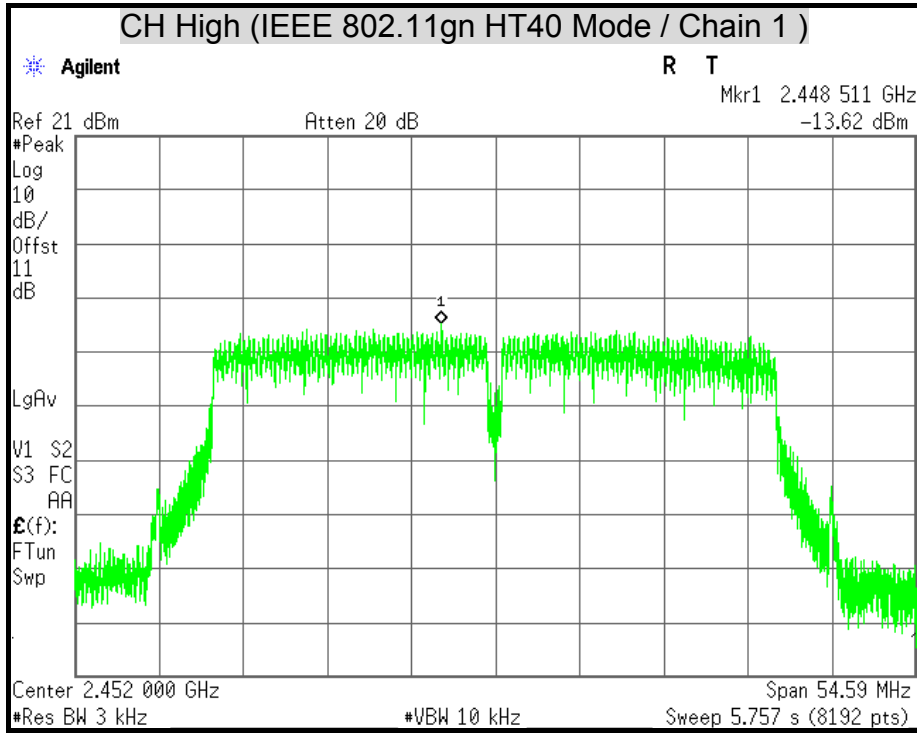



### 7.5 CONDUCTED SPURIOUS EMISSION

#### LIMITS

§ 15.247(d) In any 100 kHz bandwidth outside the frequency band in which the spread spectrum intentional radiator is operating, the radio frequency power that is produced by the intentional radiator shall be at least 20 dB below that in the 100 kHz bandwidth within the band that contains the highest level of the desired power, based on either an RF conducted or a radiated measurement. Attenuation below the general limits specified in § 15.209(a) is not required. In addition, radiated emissions which fall in the restricted bands, as defined in § 15.205(a), must also comply with the radiated emission limits specified in § 15.209(a) (see § 15.205(c)).

#### TEST EQUIPMENT

Name of Equipment	Manufacturer	Model	Serial Number	Calibration Due
Spectrum Analyzer	Agilent	E4446A	MY43360132	06/10/2015

*Remark: Each piece of equipment is scheduled for calibration once a year.*

#### TEST SETUP



#### TEST PROCEDURE

The transmitter output is connected to a spectrum analyzer. The resolution bandwidth is set to 100 kHz. The video bandwidth is set to 300 kHz.

The spectrum from 30 MHz to 26.5 GHz is investigated with the transmitter set to the lowest, middle, and highest channels in the 2.4 GHz band.



TEST RESULTS

OUT-OF-BAND SPURIOUS EMISSIONS-CONDUCTED MEASUREMENT

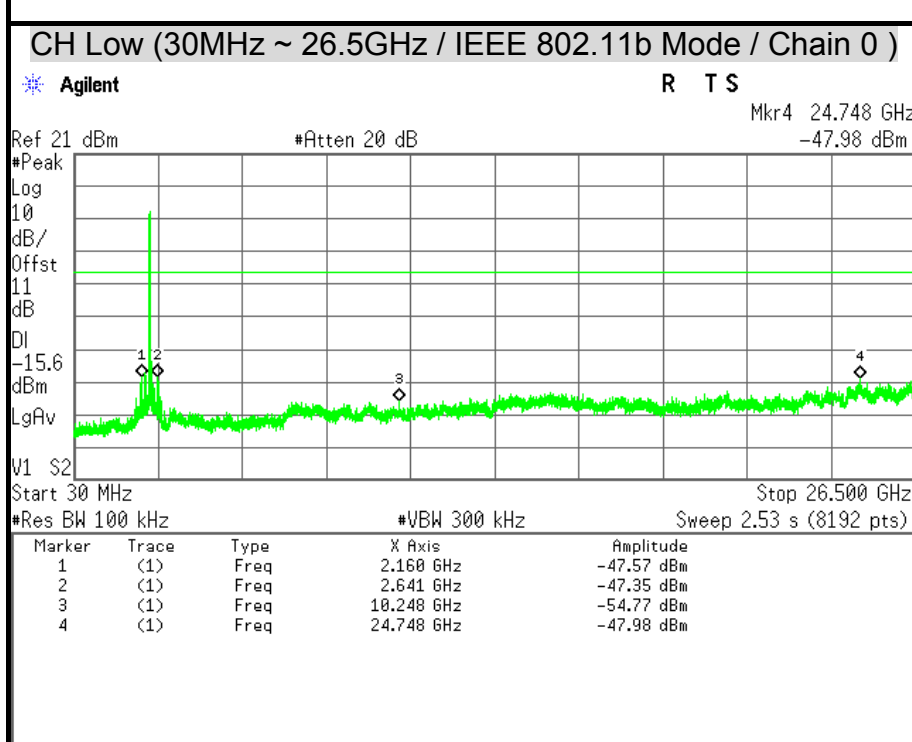
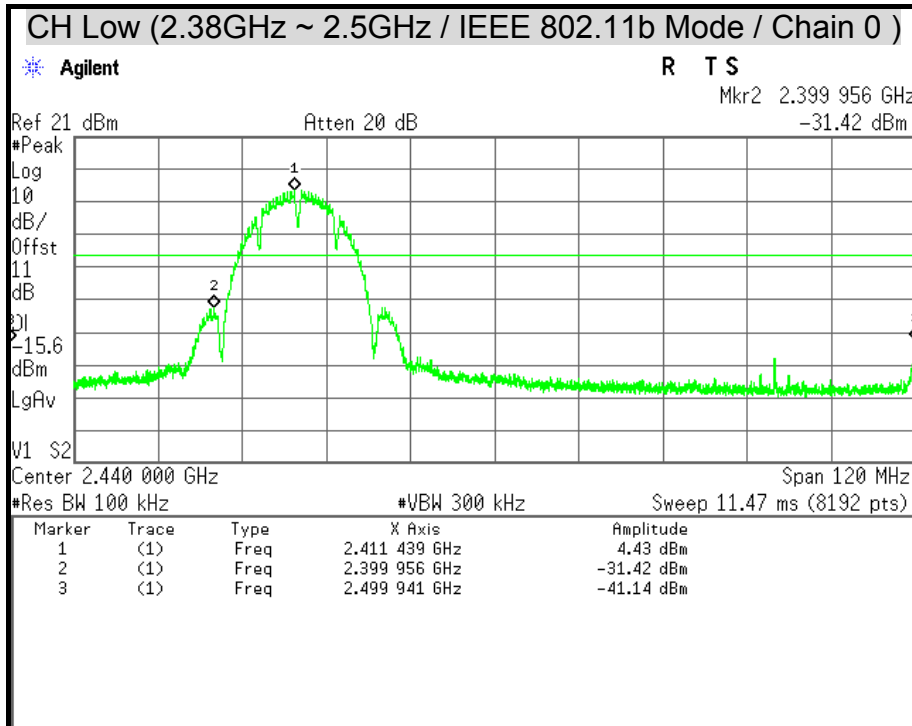



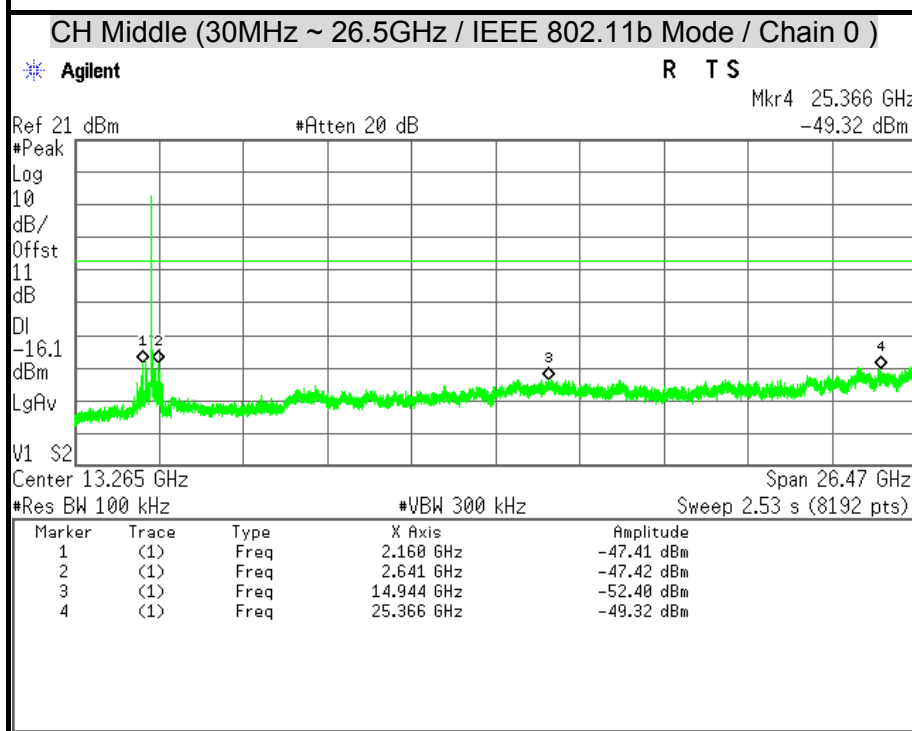
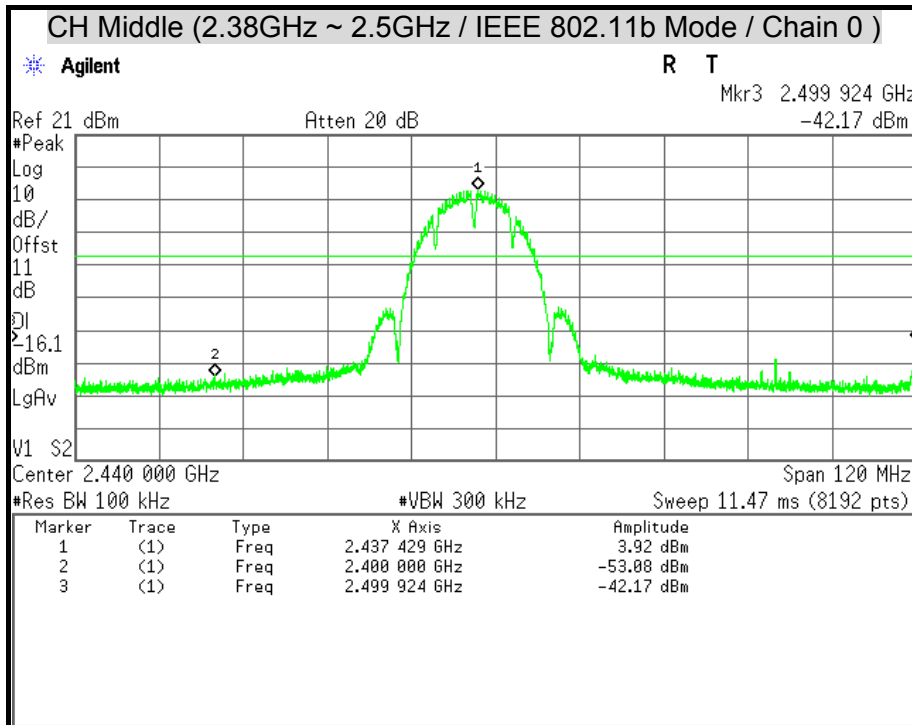

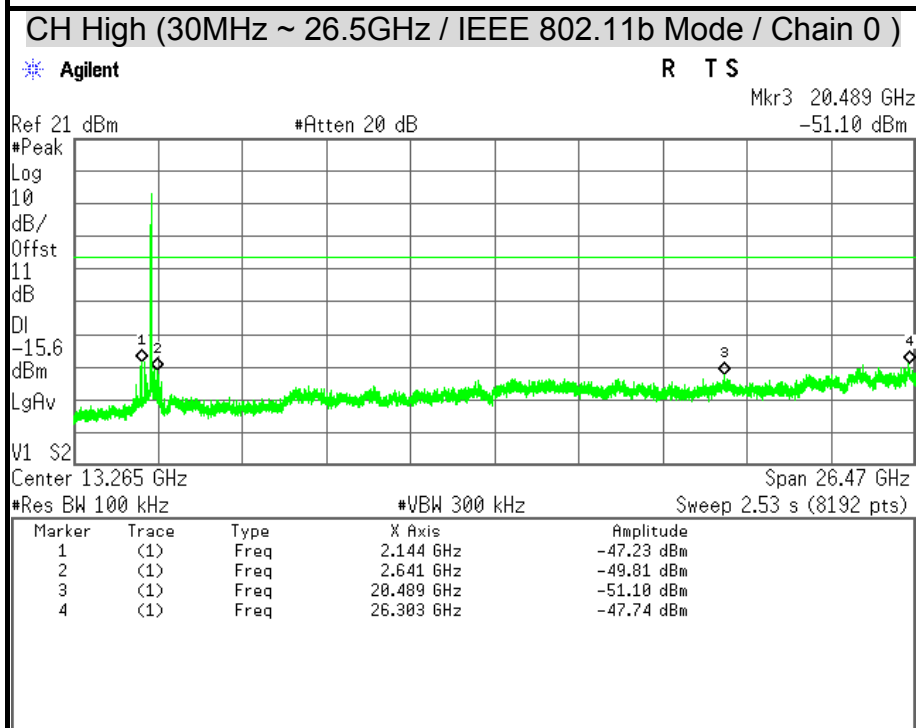
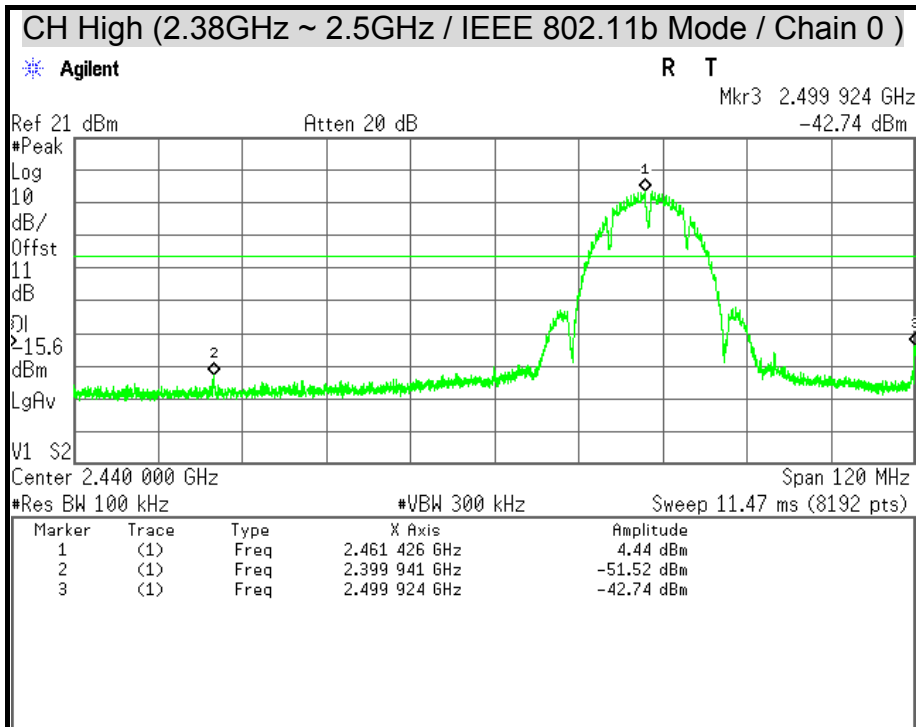

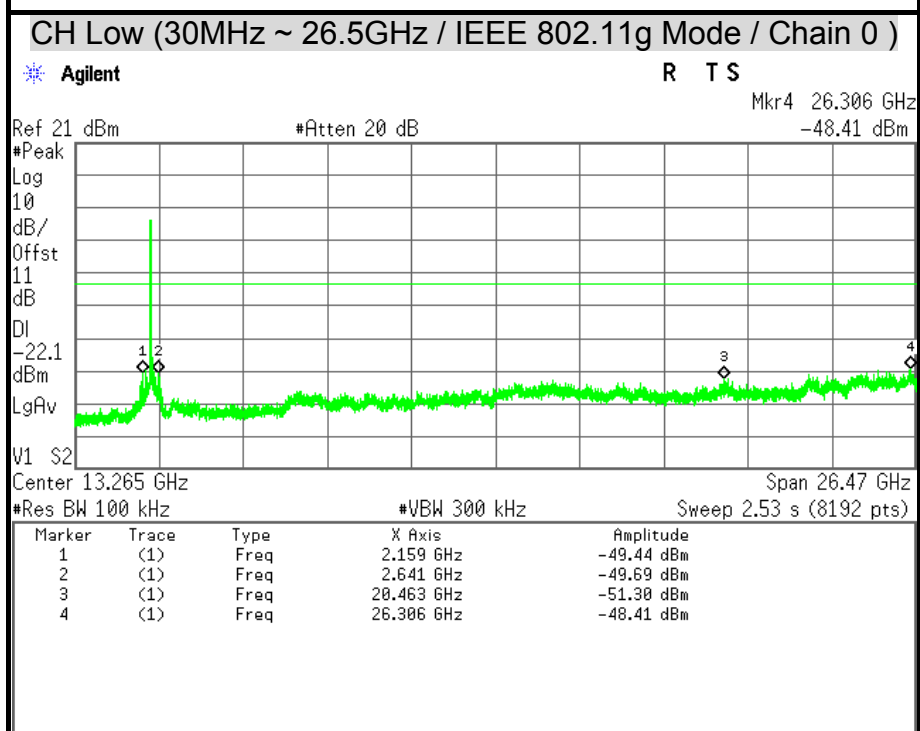
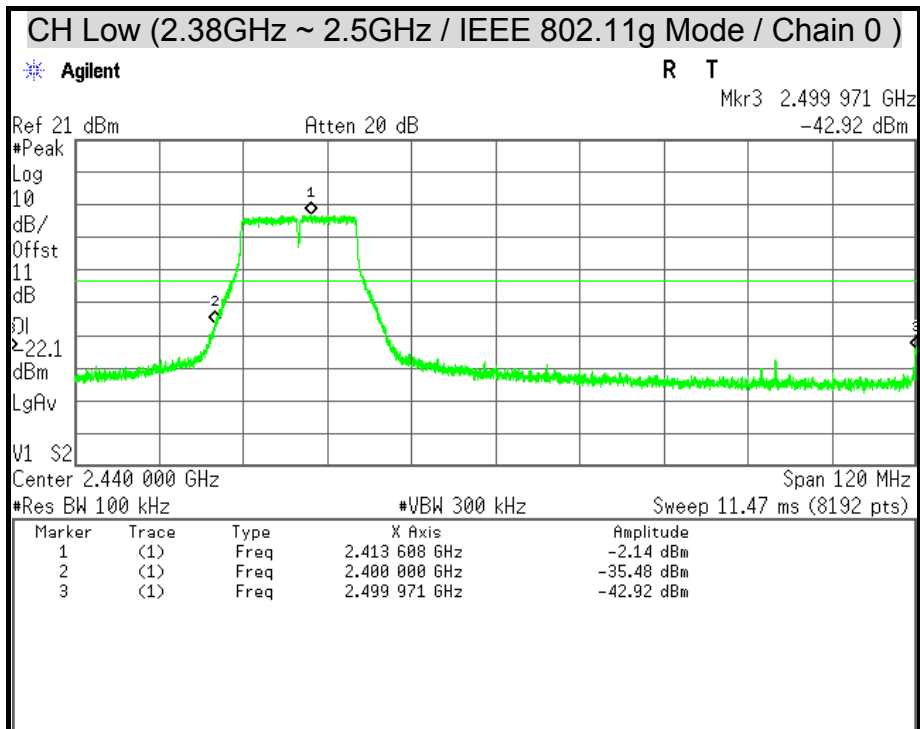

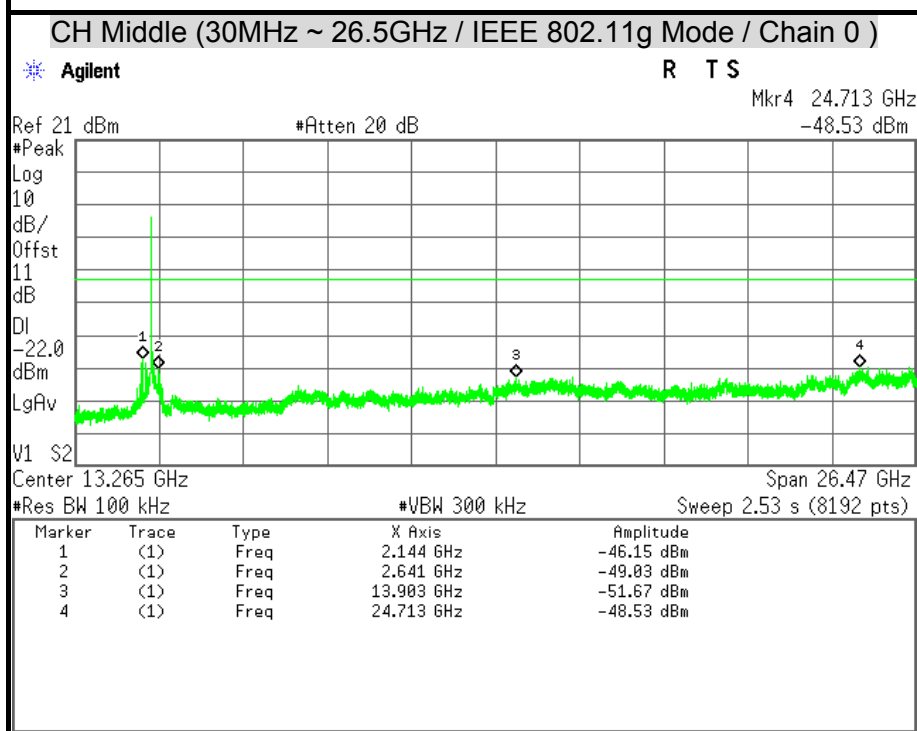
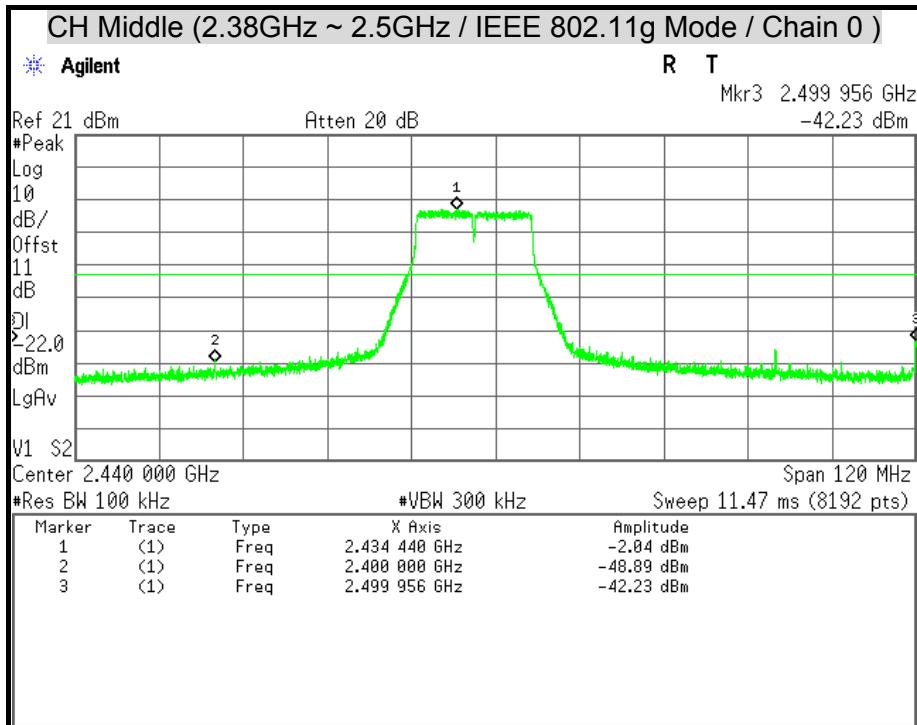

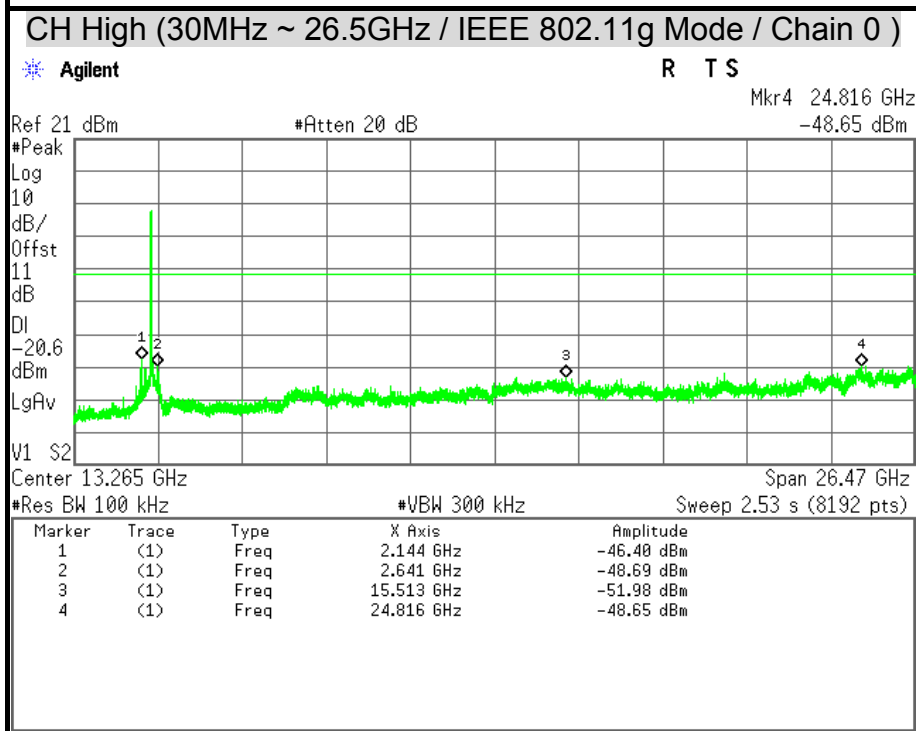
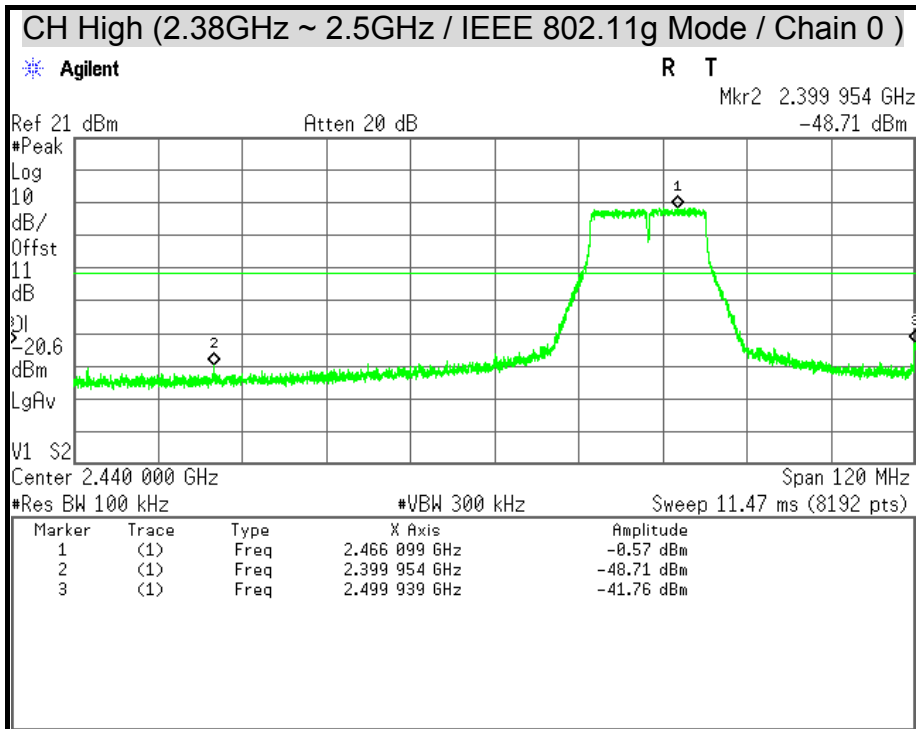

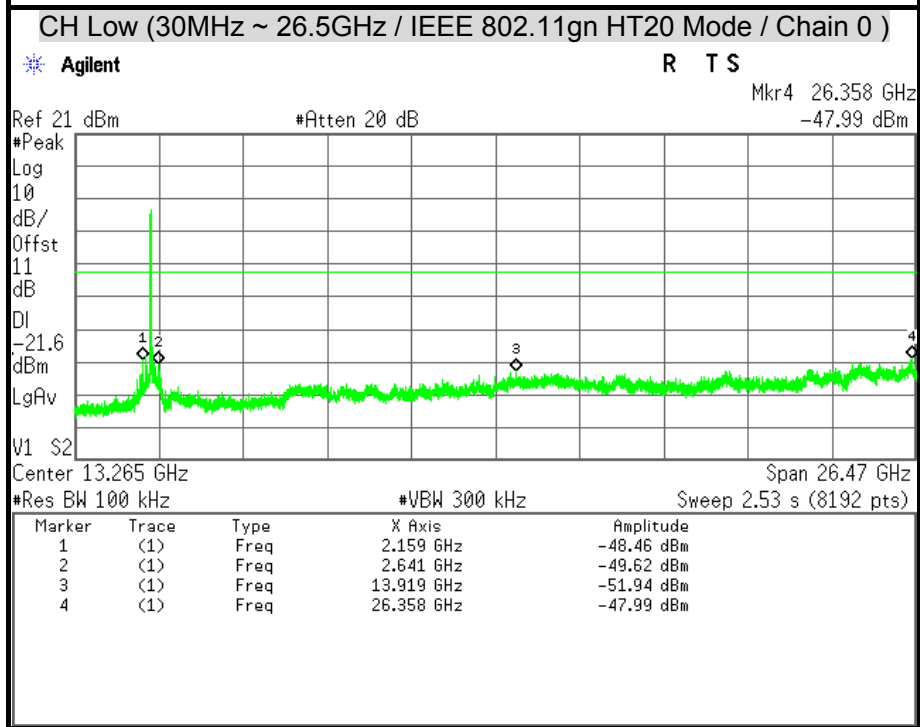
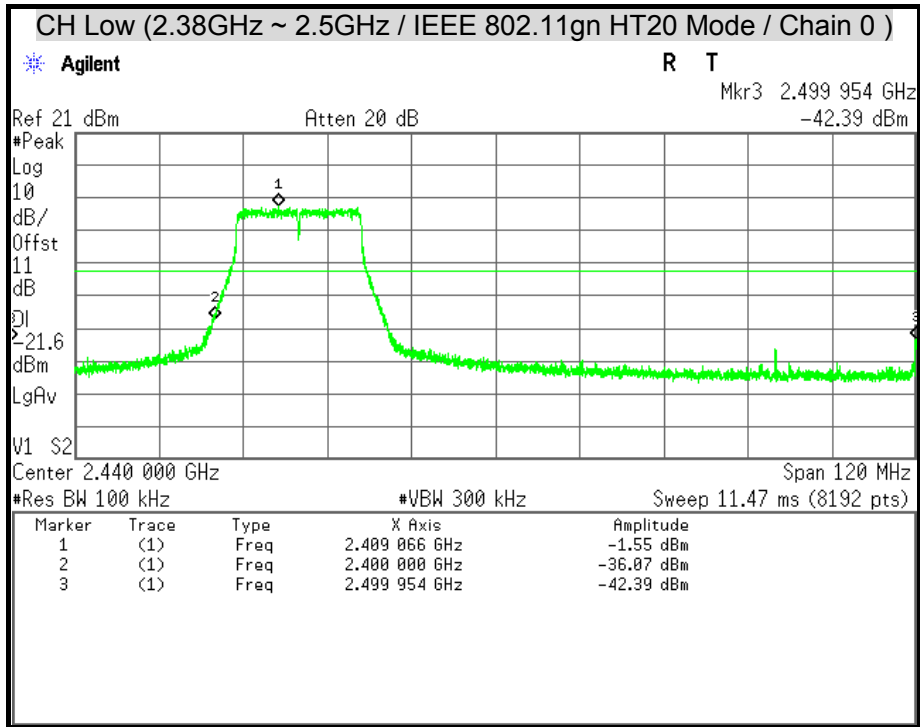

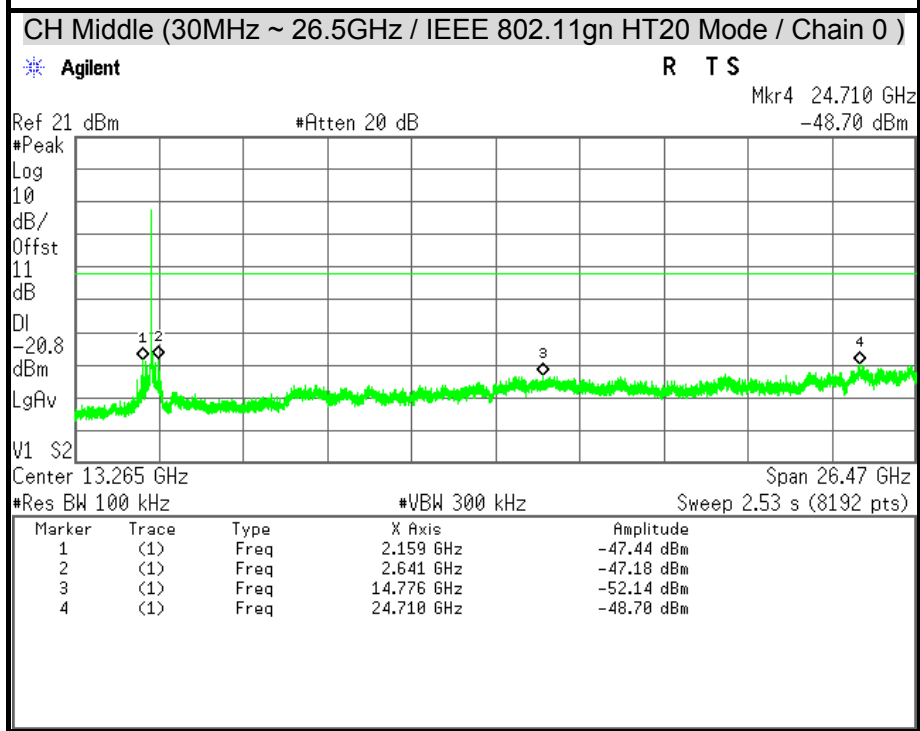
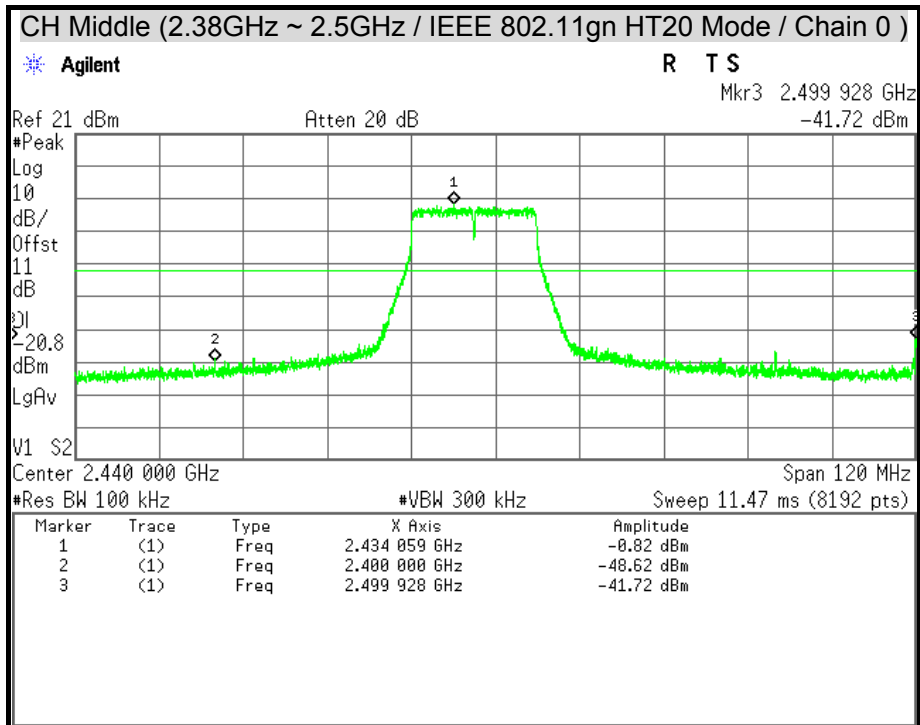

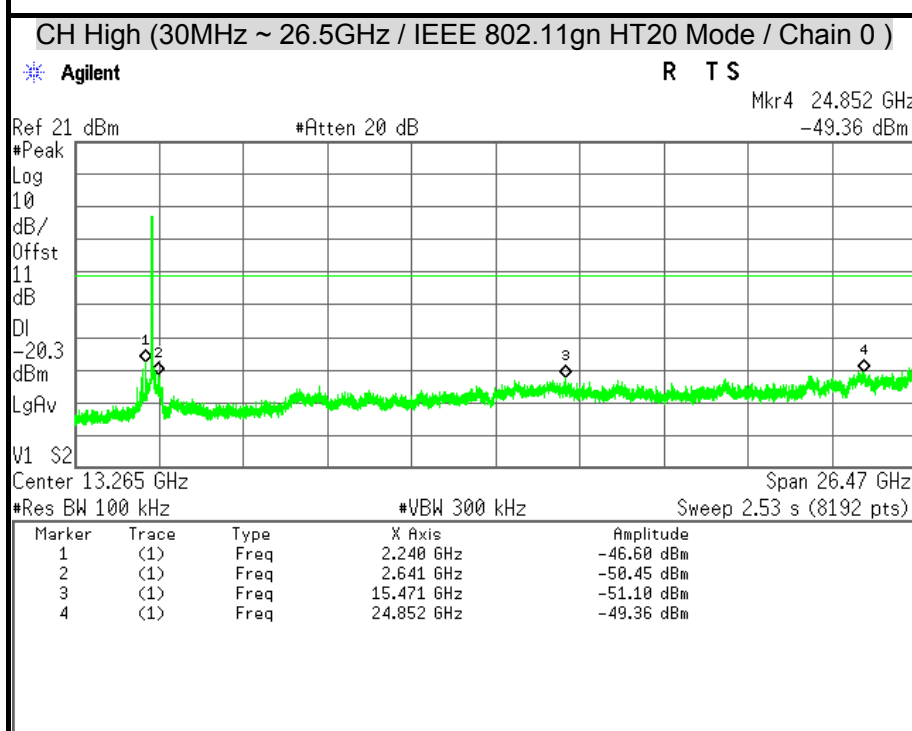
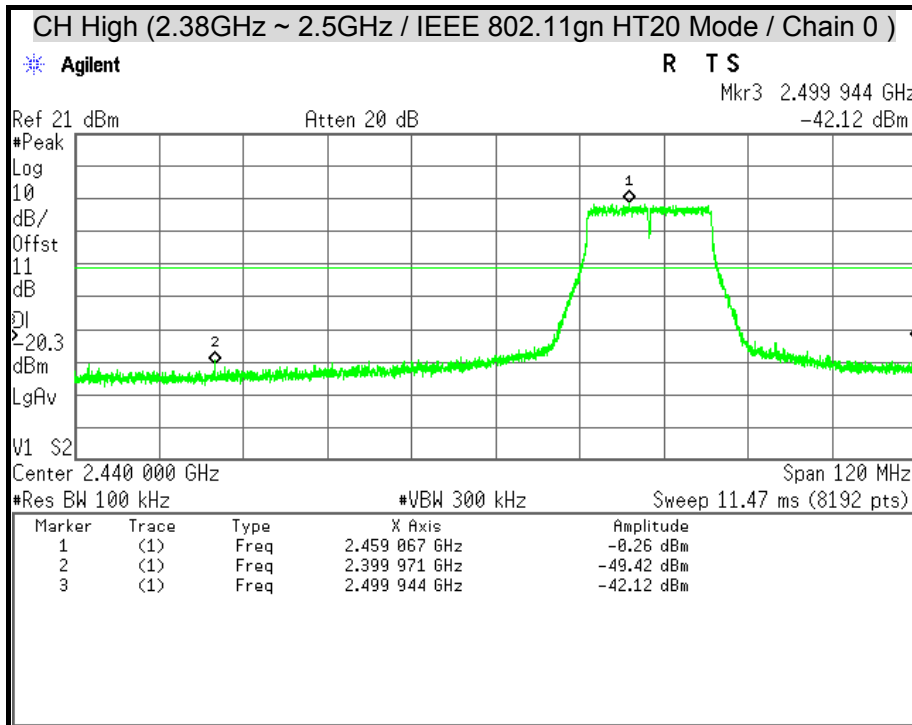



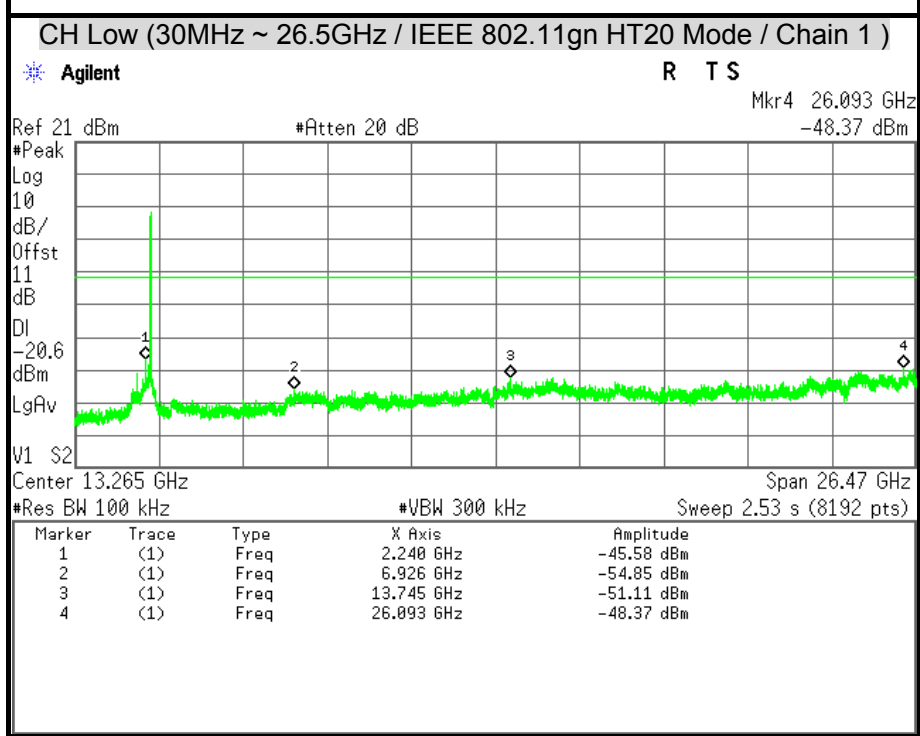
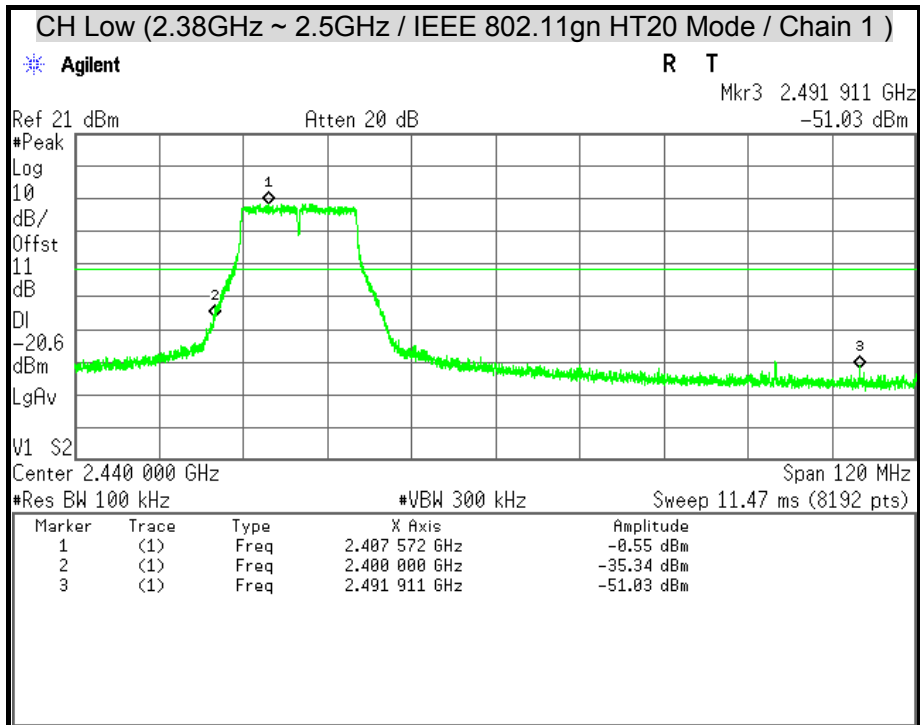

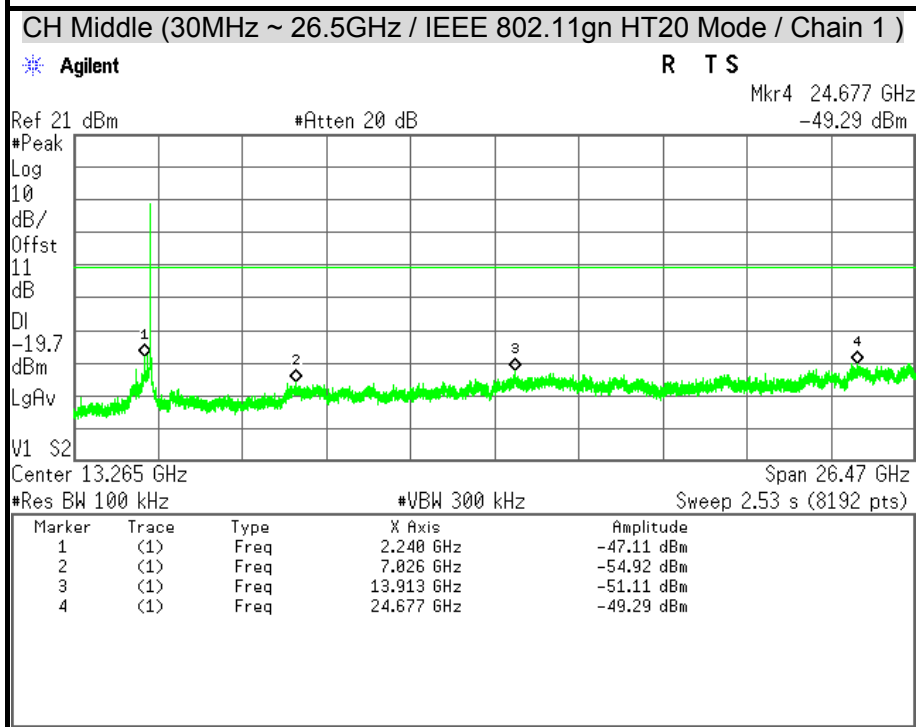
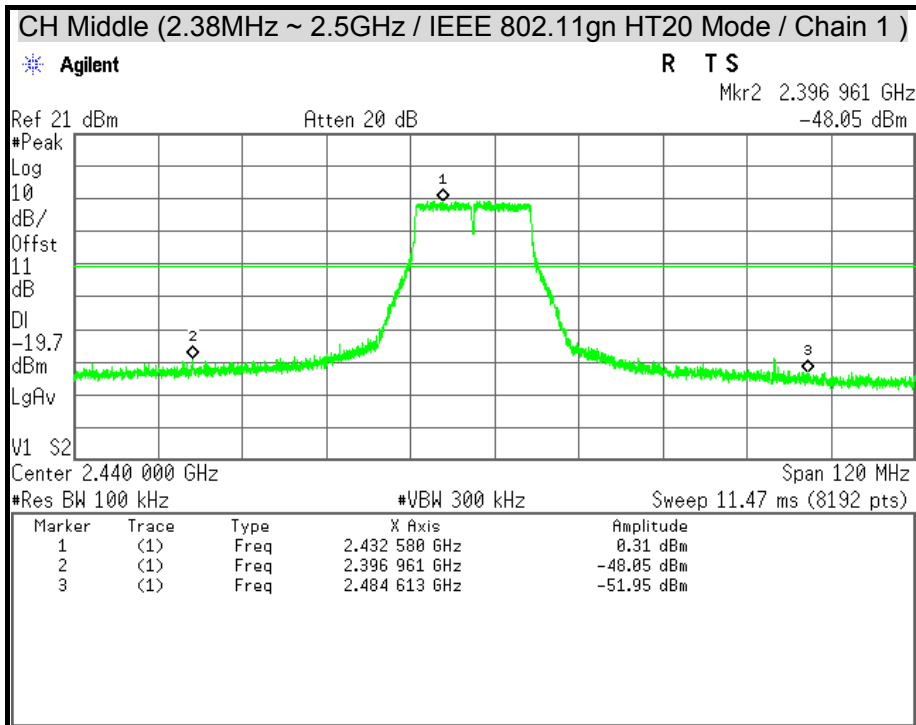

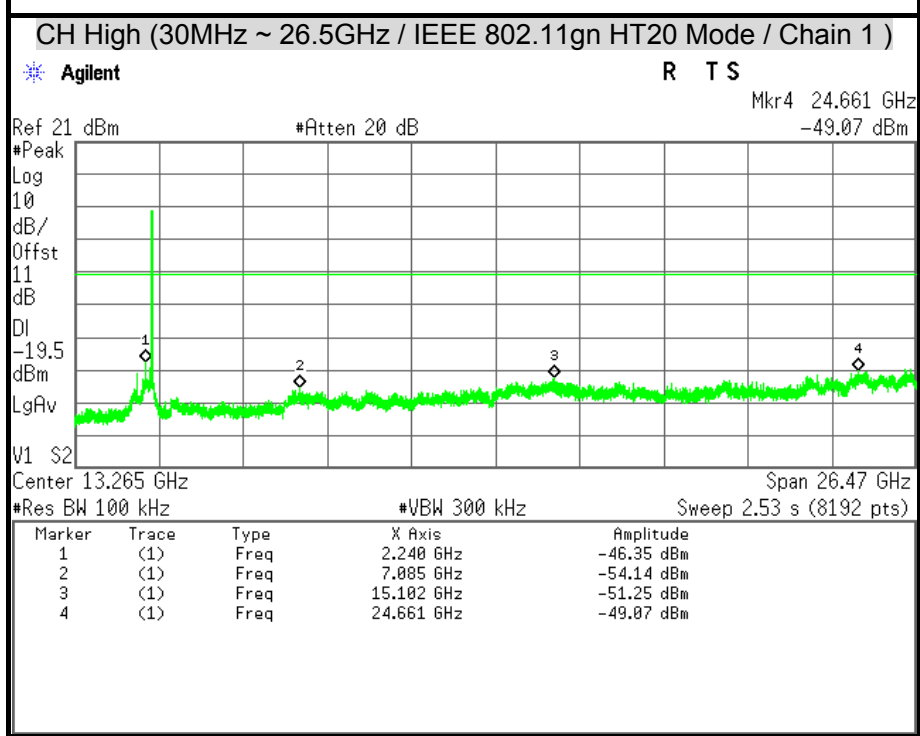
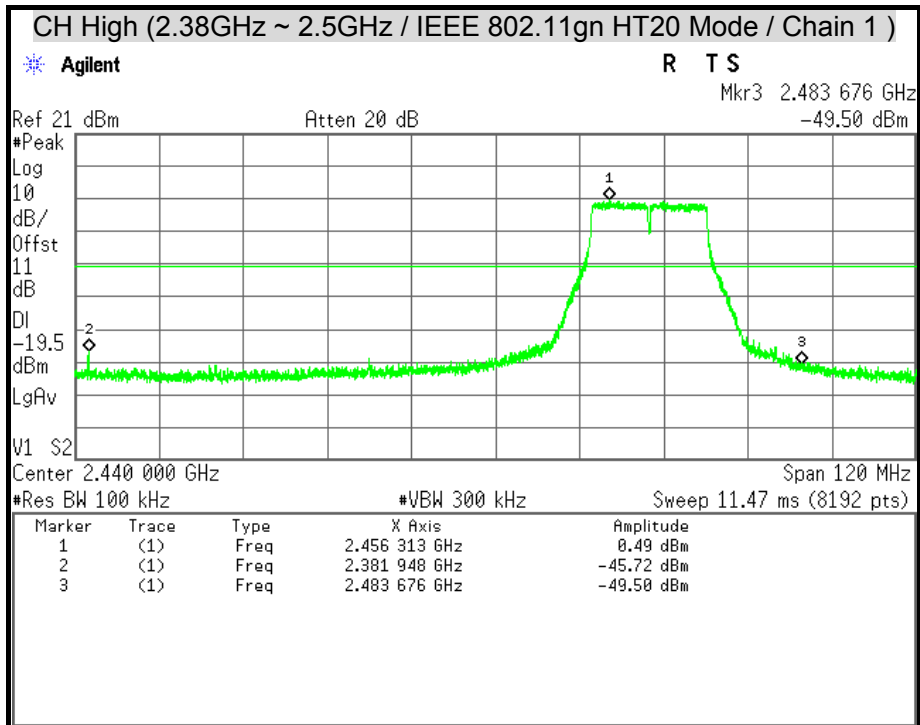

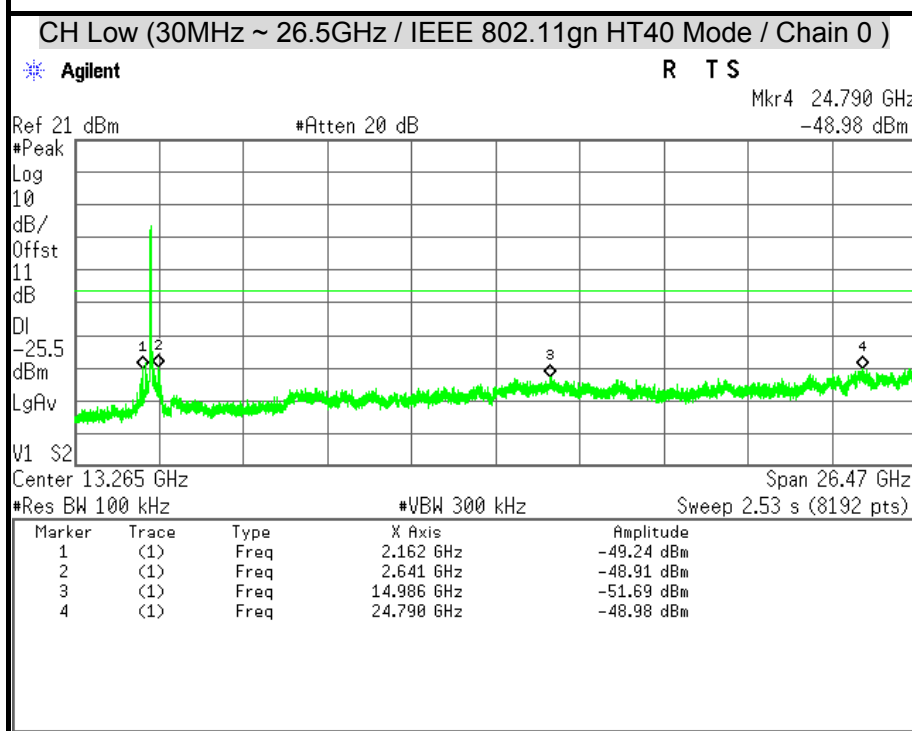
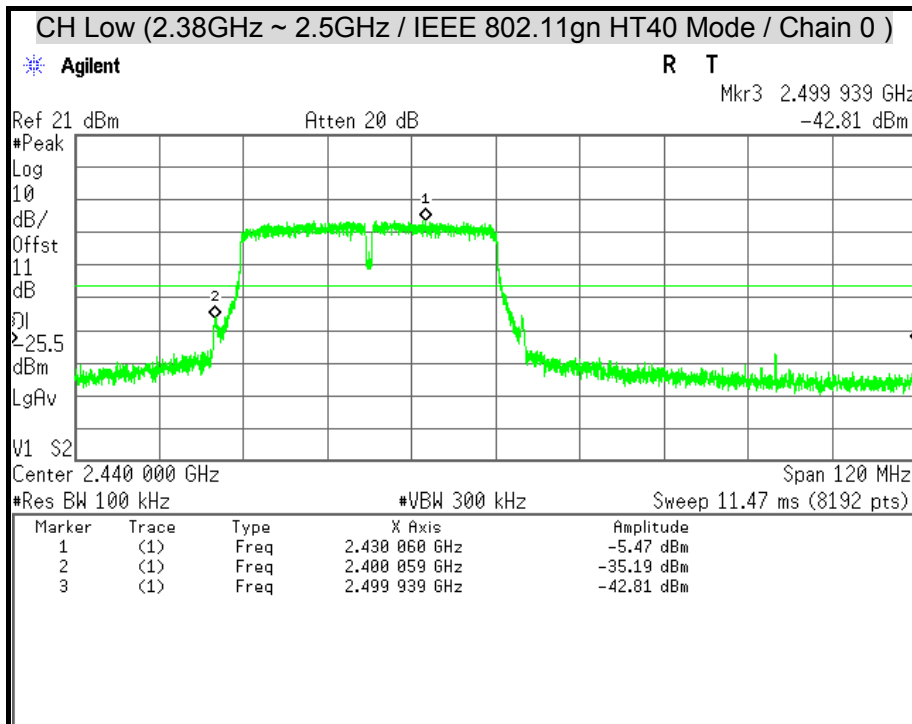

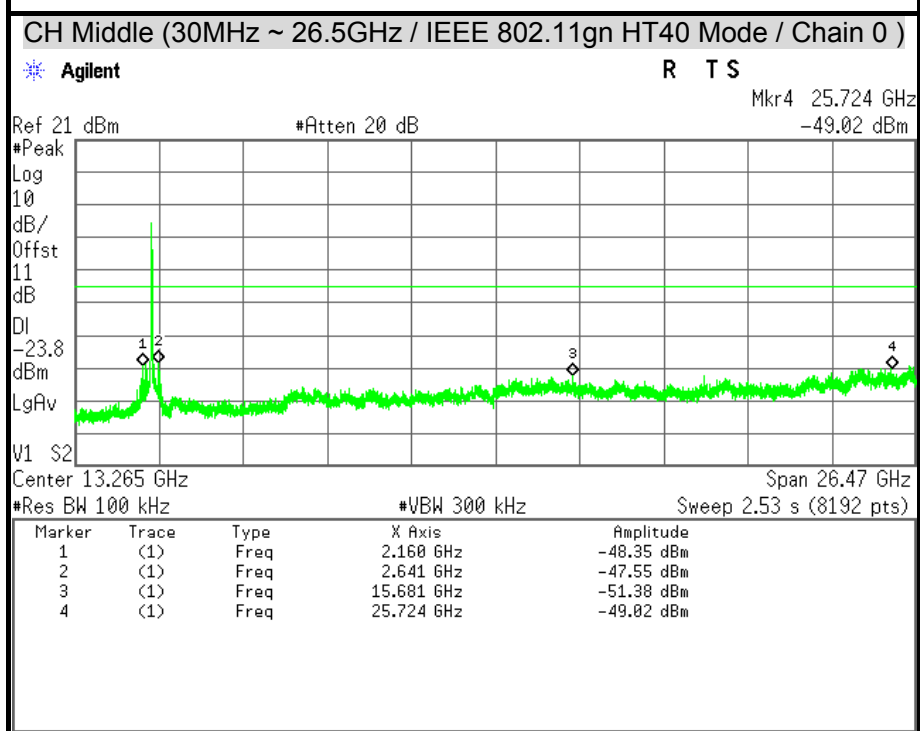
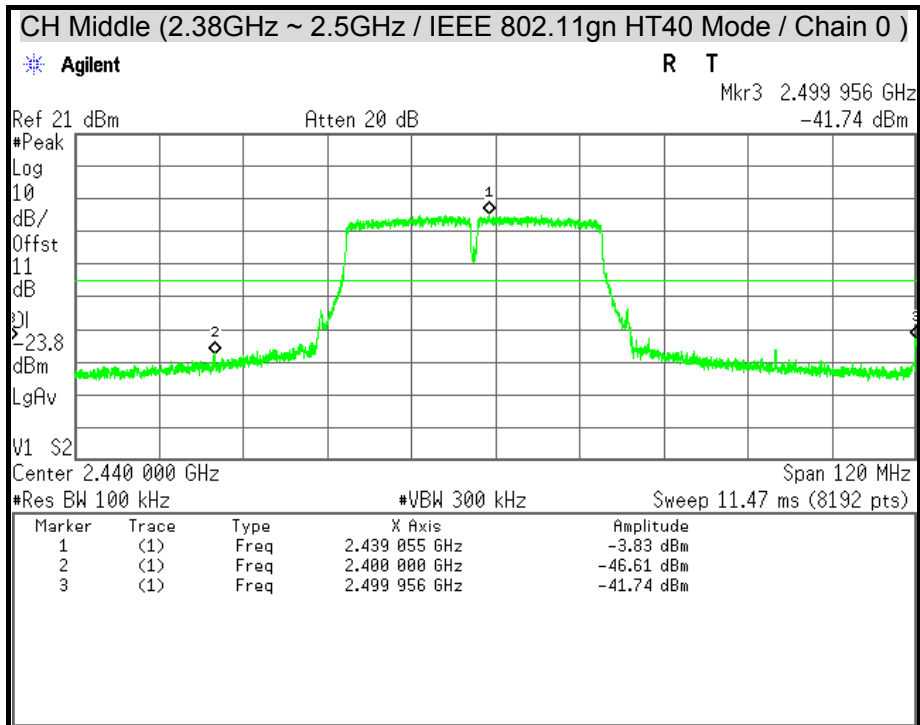

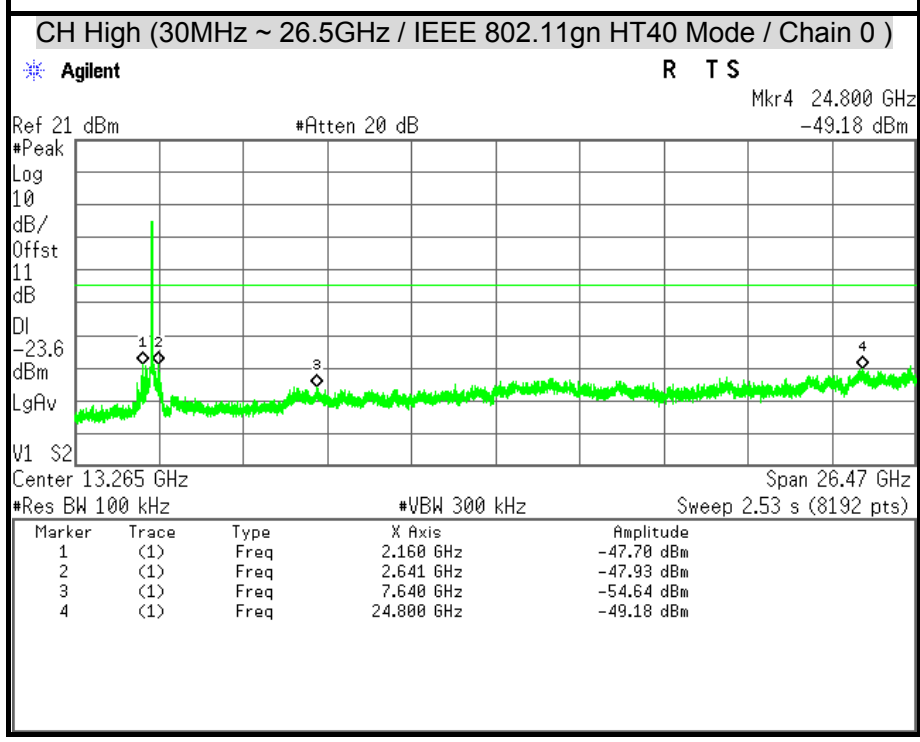
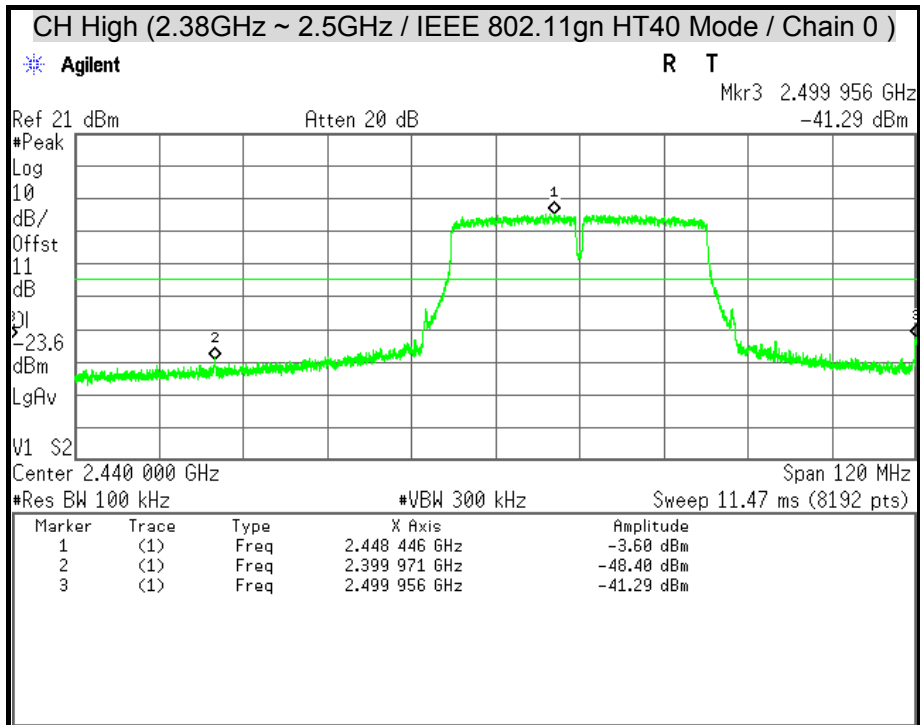

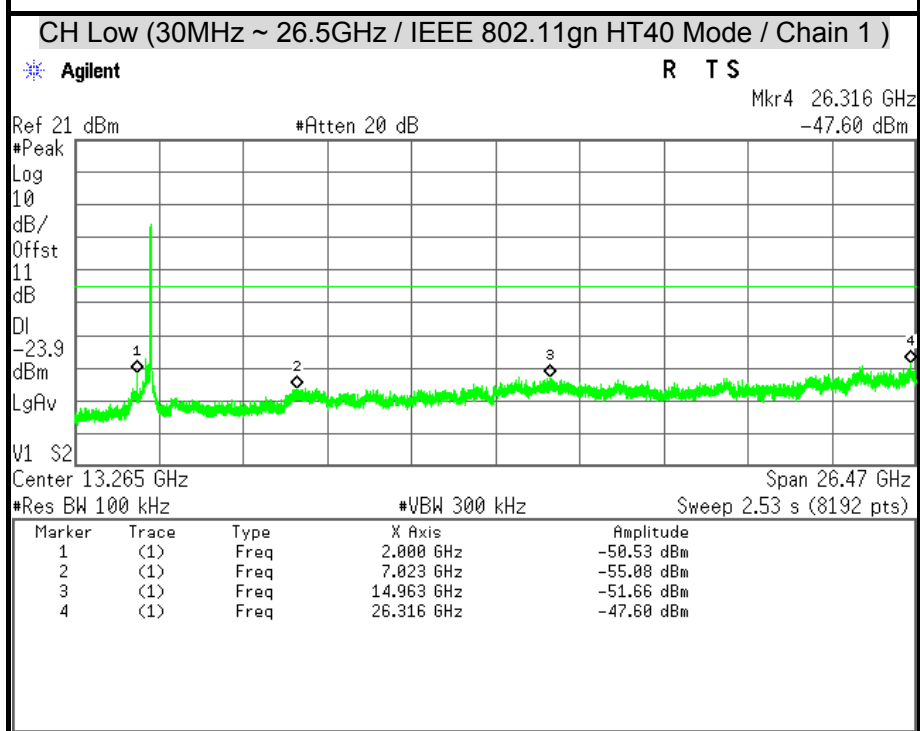
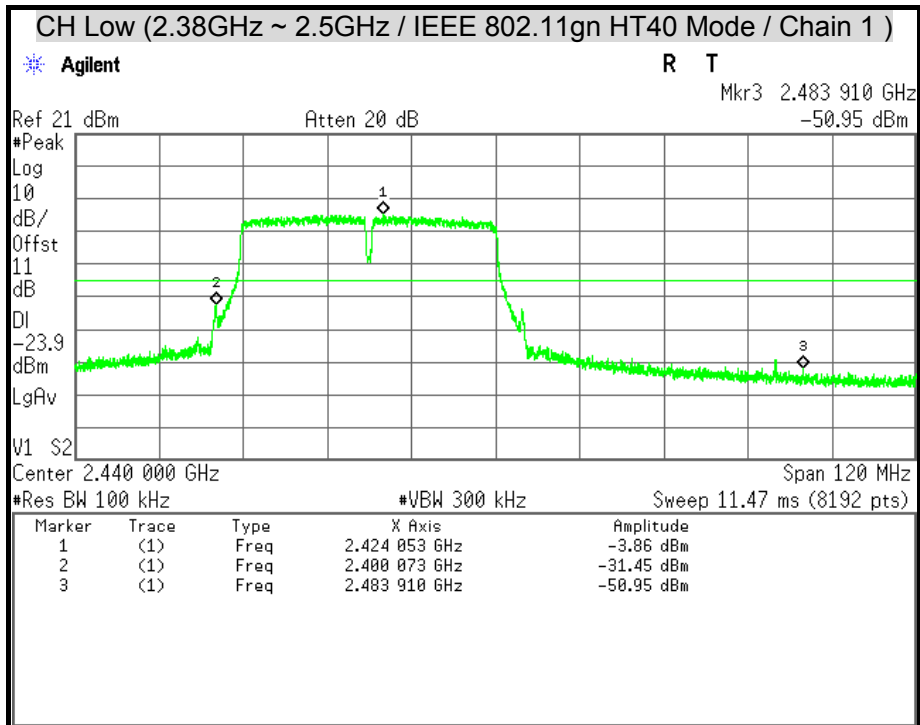

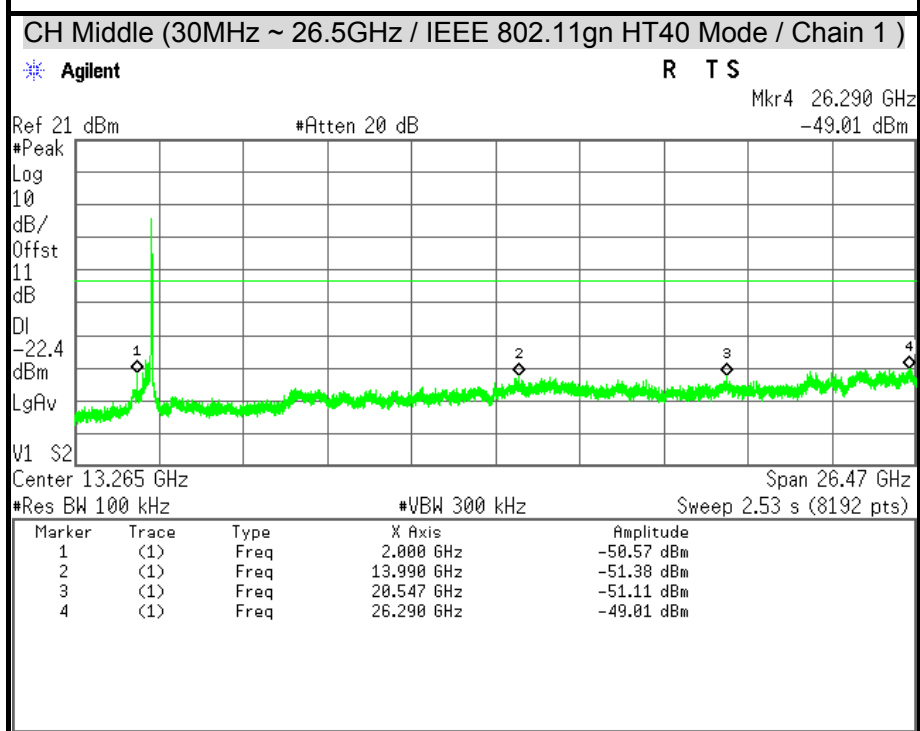
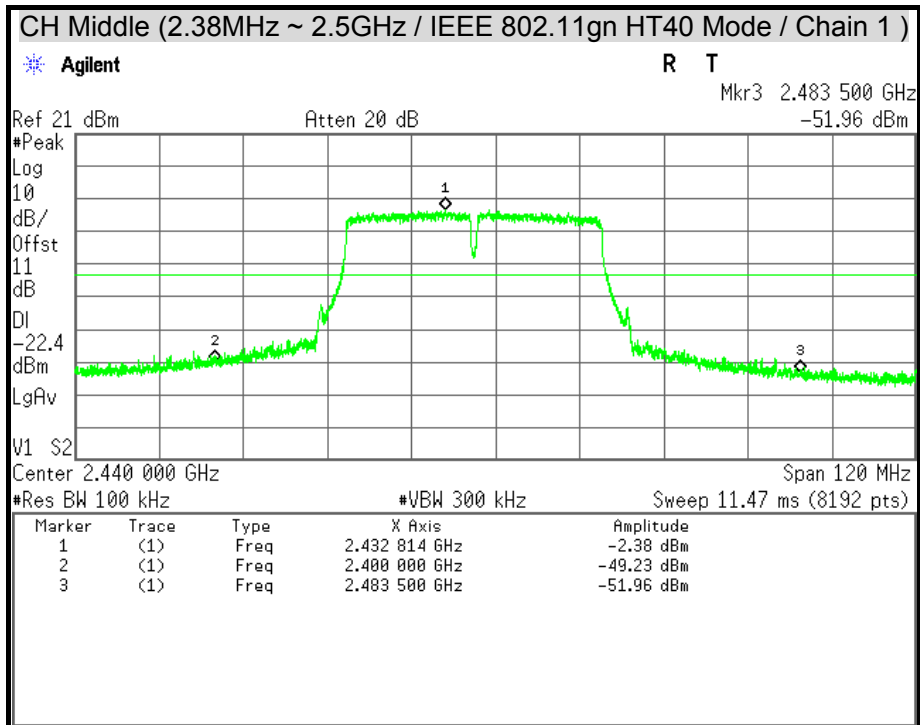



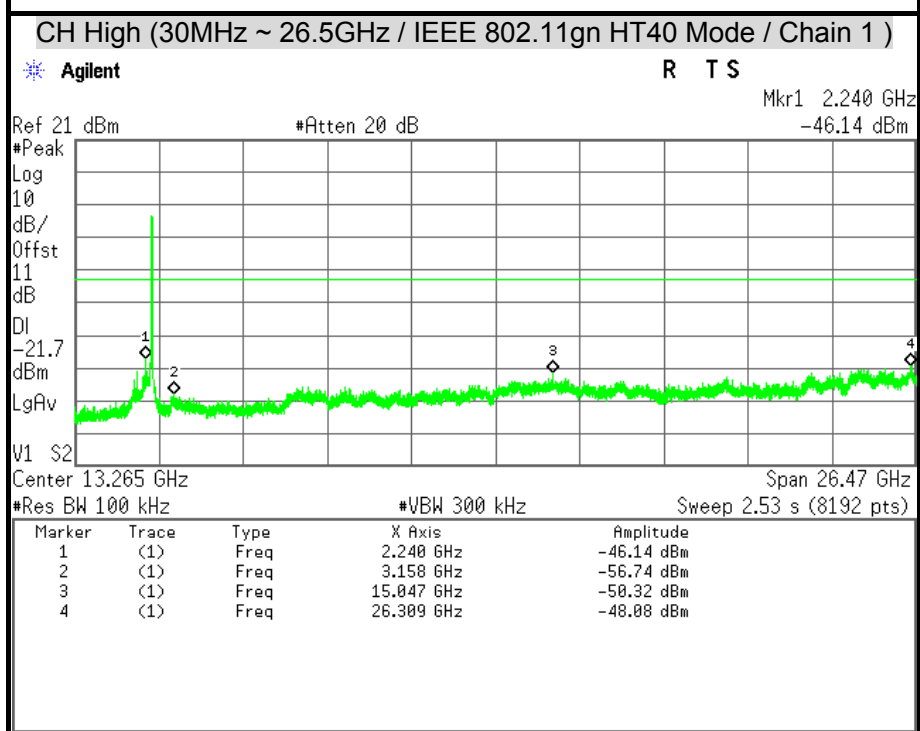
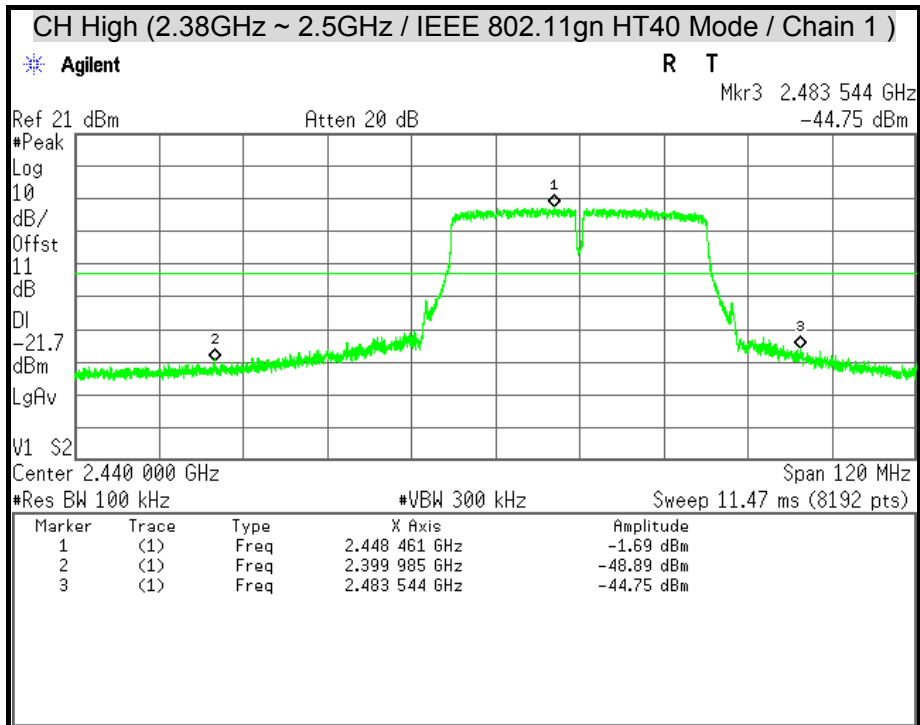



### 7.6 RADIATED EMISSION

#### LIMITS

(1) According to § 15.205 (a) Except as shown in paragraph (d) of this section, only spurious emissions are permitted in any of the frequency bands listed below:

MHz	MHz	MHz	GHz
0.090 - 0.110	16.42 - 16.423	399.9 - 410	4.5 - 5.15
<sup>1</sup> 0.495 - 0.505	16.69475 - 16.69525	608 - 614	5.35 - 5.46
2.1735 - 2.1905	16.80425 - 16.80475	960 - 1240	7.25 - 7.75
4.125 - 4.128	25.5 - 25.67	1300 - 1427	8.025 - 8.5
4.17725 - 4.17775	37.5 - 38.25	1435 - 1626.5	9.0 - 9.2
4.20725 - 4.20775	73 - 74.6	1645.5 - 1646.5	9.3 - 9.5
6.215 - 6.218	74.8 - 75.2	1660 - 1710	10.6 - 12.7
6.26775 - 6.26825	108 - 121.94	1718.8 - 1722.2	13.25 - 13.4
6.31175 - 6.31225	123 - 138	2200 - 2300	14.47 - 14.5
8.291 - 8.294	149.9 - 150.05	2310 - 2390	15.35 - 16.2
8.362 - 8.366	156.52475 - 156.52525	2483.5 - 2500	17.7 - 21.4
8.37625 - 8.38675	156.7 - 156.9	2655 - 2900	22.01 - 23.12
8.41425 - 8.41475	162.0125 - 167.17	3260 - 3267	23.6 - 24.0
12.29 - 12.293	167.72 - 173.2	3332 - 3339	31.2 - 31.8
12.51975 - 12.52025	240 - 285	3345.8 - 3338	36.43 - 36.5
12.57675 - 12.57725	322 - 335.4	3600 - 4400	( <sup>2</sup> )
13.36 - 13.41			

**Remark:**

1. <sup>1</sup> Until February 1, 1999, this restricted band shall be 0.490-0.510 MHz.
2. <sup>2</sup> Above 38.6

(2) According to § 15.205 (b) Except as provided in paragraphs (d) and (e), the field strength of emissions appearing within these frequency bands shall not exceed the limits shown in Section 15.209. At frequencies equal to or less than 1000 MHz, compliance with the limits in Section 15.209 shall be demonstrated using measurement instrumentation employing a CISPR quasi-peak detector. Above 1000 MHz, compliance with the emission limits in Section 15.209 shall be demonstrated based on the average value of the measured emissions. The provisions in Section 15.35 apply to these measurements.



(3) According to § 15.209 (a) Except as provided elsewhere in this Subpart, the emissions from an intentional radiator shall not exceed the field strength levels specified in the following table :

Frequency (MHz)	Field Strength (microvolts/meter)	Measurement Distance (meters)
0.009 – 0.490	2400/F(KHz)	300
0.490 – 1.705	24000/F(KHz)	30
1.705 – 30.0	30	30
30 - 88	100 **	3
88 - 216	150 **	3
216 - 960	200 **	3
Above 960	500	3

**Remark:** \*\*Except as provided in paragraph (g), fundamental emissions from intentional radiators operating under this Section shall not be located in the frequency bands 54-72 MHz, 76-88 MHz, 174-216 MHz or 470-806 MHz. However, operation within these frequency bands is permitted under other sections of this Part, e.g., Sections 15.231 and 15.241.

(4) According to § 15.209 (b) In the emission table above, the tighter limit applies at the band edges.

**TEST EQUIPMENT**

**Radiated Emission / 966Chamber\_B**

Name of Equipment	Manufacture	Model	Serial Number	Calibration Due
Spectrum Analyzer	Agilent	E4446A	MY46180323	04/15/2015
EMI Test Receiver	ROHDE & SCHWARZ	ESCS 30	835418/008	10/14/2015
Bi-log Antenna	SCHWARZBECK	VULB 9168	9168-250	08/21/2015
Broad-Band Horn Antenna	SCHWARZBECK	BBHA 9120 D	9120D-778	08/19/2015
Double-Ridged Waveguide Horn	ETS-LINDGREN	3117	00078733	12/02/2015
Horn Antenna	COM-POWER	AH-840	03077	12/17/2015
Pre-Amplifier	Agilent	8447D	2944A10052	07/15/2015
Pre-Amplifier	Agilent	8449B	3008A01916	07/15/2015
LOOP Antenna	EMCO	6502	8905-2356	09/23/2015
Notch Filters Band Reject	Micro-Tronics	BRM05702-01	026	N.C.R

**Remark:** 1. Each piece of equipment is scheduled for calibration once a year.  
2. N.C.R = No Calibration Request.



**TEST SETUP**

The diagram below shows the test setup that is utilized to make the measurements for emission below 1GHz.

**9kHz ~ 30MHz**

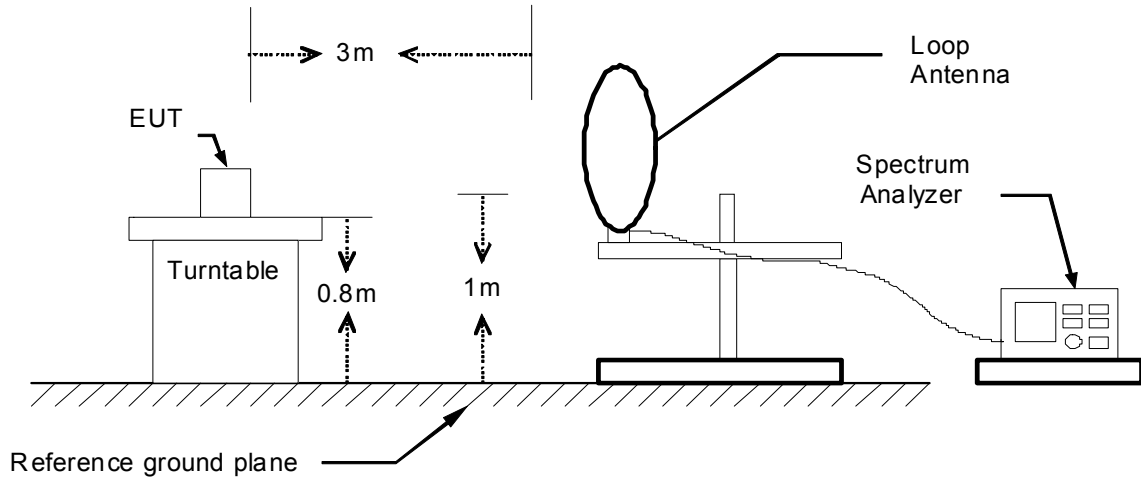

**30MHz ~ 1GHz**

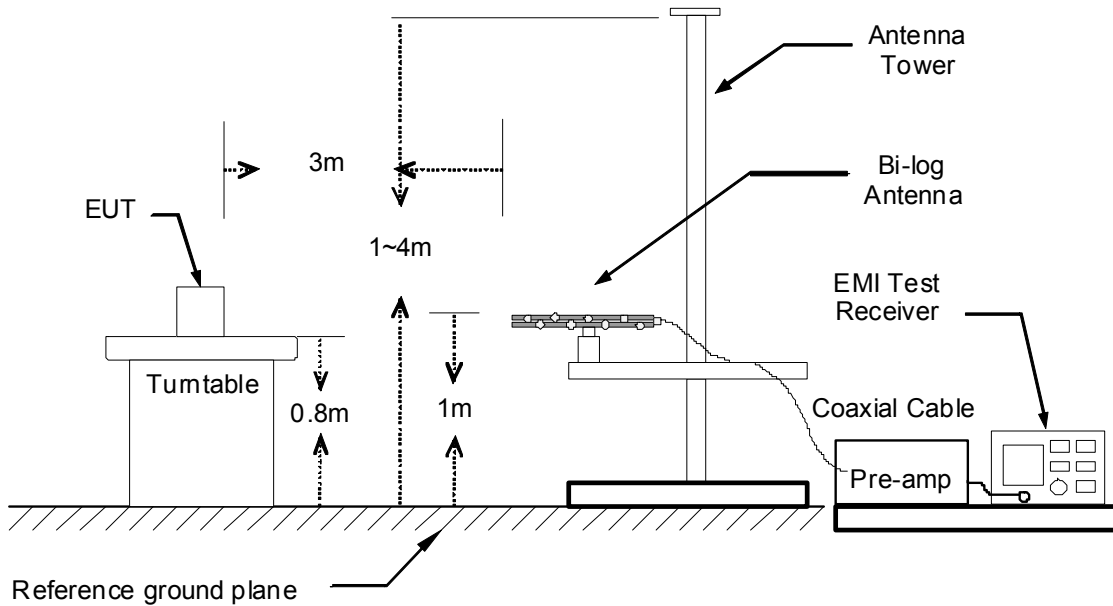



The diagram below shows the test setup that is utilized to make the measurements for emission above 1GHz.

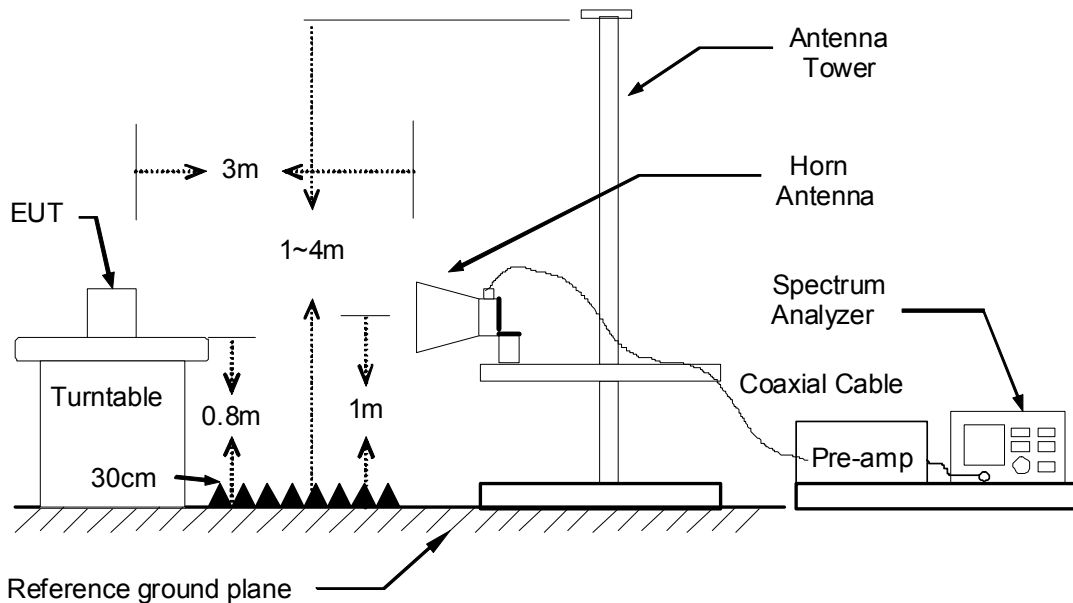

### **TEST PROCEDURE**

1. The EUT was placed on the top of a rotating table 0.8 meters above the ground. The table was rotated 360 degrees to determine the position of the highest radiation.
2. While measuring the radiated emission below 1GHz, the EUT was set 3 meters away from the interference-receiving antenna, which was mounted on the top of a variable-height antenna tower. While measuring the radiated emission above 1GHz, the EUT was set 3 meters away from the interference-receiving antenna.
3. The antenna is a broadband antenna, and its height is varied from one meter to four meters above the ground to determine the maximum value of the field strength. Both horizontal and vertical polarization of the antenna are set to make the measurement.
4. For each suspected emission, the EUT was arranged to its worst case and then the antenna was tuned to heights from 1 meter to 4 meters and the table was turned from 0 degrees to 360 degrees to find the maximum reading.
5. The test-receiver system was set to Peak Detect Function and Specified Bandwidth with Maximum Hold Mode.
6. If the emission level of the EUT in peak mode was 10 dB lower than the limit specified, then testing could be stopped and the peak values of the EUT would be reported. Otherwise the emissions that did not have 10 dB margin would be re-tested one by one using peak, quasi-peak or average method as specified and then reported in a data sheet.

#### **Remark :**

1. The resolution bandwidth and video bandwidth of test receiver/spectrum analyzer is 120 KHz for Peak detection (PK) and Quasi-peak detection (QP) at frequency below 1GHz.
2. The resolution bandwidth and video bandwidth of test receiver/spectrum analyzer is 1 MHz for Peak detection and frequency above 1GHz.
3. The resolution bandwidth of test receiver/spectrum analyzer is 1 MHz and the video bandwidth is 10 Hz for Average detection (AV) at frequency above 1GHz.



**TEST RESULTS**

**Below 1 GHz (9kHz ~ 30MHz)**

No emission found between lowest internal used/generated frequency to 30MHz.

**Below 1 GHz (30MHz ~ 1GHz)**

<b>Product Name</b>	300Mbps Wireless N High Power Ceiling-Mounted Access Point	<b>Test By</b>	Davis Tseng
<b>Test Model</b>	WF2520	<b>Test Date</b>	2015/03/13
<b>Test Mode</b>	TX Mode	<b>Temp. &amp; Humidity</b>	24.5°C, 33%

966 Chamber_B at 3Meter / Horizontal						
Frequency (MHz)	Reading (dBµV)	Correction Factor (dB/m)	Result (dBµV/m)	Limit (dBµV/m)	Margin (dB)	Remark
89.17	55.32	-19.55	35.77	43.50	-7.73	Peak
183.26	48.10	-14.60	33.50	43.50	-10.00	Peak
259.89	44.43	-12.88	31.56	46.00	-14.44	Peak
324.88	42.25	-10.98	31.27	46.00	-14.73	Peak
600.36	38.83	-5.82	33.01	46.00	-12.99	Peak
649.83	37.91	-5.36	32.55	46.00	-13.45	Peak

966 Chamber_B at 3Meter / Vertical						
Frequency (MHz)	Reading (dBµV)	Correction Factor (dB/m)	Result (dBµV/m)	Limit (dBµV/m)	Margin (dB)	Remark
32.91	49.30	-15.08	34.22	40.00	-5.78	Peak
89.17	54.05	-19.55	34.51	43.50	-8.99	Peak
183.26	53.41	-14.60	38.81	43.50	-4.69	Peak
423.82	39.25	-9.02	30.23	46.00	-15.77	Peak
600.36	44.01	-5.82	38.19	46.00	-7.81	Peak
943.74	31.50	-0.19	31.31	46.00	-14.69	Peak

**Remark:**

1. Quasi-peak test would be performed if the peak result were greater than the quasi-peak limit.
2. Data of measurement within this frequency range shown " --- " in the table above means the reading of emissions are attenuated more than 20dB below the permissible limits or the field strength is too small to be measured.
3. Correction Factor (dB/m) = Antenna Factor (dB/m) + Cable Loss (dB) – PreAmp.Gain (dB)
4. Result (dBuV/m) = Reading (dBuV) + Correction Factor (dB/m)
5. Margin (dB) = Remark result (dBuV/m) - Quasi-peak limit (dBuV/m).



Above 1 GHz

<b>Product Name</b>	300Mbps Wireless N High Power Ceiling-Mounted Access Point	<b>Test By</b>	Rex Chiu
<b>Test Model</b>	WF2520	<b>Test Date</b>	2015/03/05
<b>Test Mode</b>	IEEE 802.11b TX / CH Low	<b>Temp. &amp; Humidity</b>	19°C, 56%

966 Chamber_B at 3Meter / Horizontal									
Frequency (MHz)	Reading-PK (dBuV)	Reading-AV (dBuV)	Correction Factor (dB/m)	Result-PK (dBuV/m)	Result-AV (dBuV/m)	Limit-PK (dBuV/m)	Limit-AV (dBuV/m)	Margin (dB)	Remark
1084.00	56.12	43.41	-2.06	54.06	41.35	74.00	54.00	-12.65	AVG
2068.00	51.59	39.04	2.76	54.35	41.80	74.00	54.00	-12.20	AVG
2482.00	51.20	38.82	3.57	54.77	42.39	74.00	54.00	-11.61	AVG
3105.00	42.47	---	4.24	46.71	---	74.00	54.00	-7.29	Peak
4830.00	43.43	44.81	8.00	51.43	52.81	74.00	54.00	-1.19	AVG
7290.00	39.64	---	11.64	51.29	---	74.00	54.00	-2.71	Peak

966 Chamber_B at 3Meter / Vertical									
Frequency (MHz)	Reading-PK (dBuV)	Reading-AV (dBuV)	Correction Factor (dB/m)	Result-PK (dBuV/m)	Result-AV (dBuV/m)	Limit-PK (dBuV/m)	Limit-AV (dBuV/m)	Margin (dB)	Remark
1080.00	56.93	45.62	-2.06	54.87	43.56	74.00	54.00	-10.44	AVG
1724.00	54.91	44.86	0.07	54.98	44.93	74.00	54.00	-9.07	AVG
2484.00	52.10	40.81	3.58	55.68	44.39	74.00	54.00	-9.61	AVG
3375.00	41.61	---	4.78	46.39	---	74.00	54.00	-7.61	Peak
4830.00	40.08	---	8.00	48.08	---	74.00	54.00	-5.92	Peak
6930.00	40.39	---	12.22	52.60	---	74.00	54.00	-1.40	Peak

Remark:

1. Measuring frequencies from 1 GHz to the 10th harmonic of highest fundamental frequency.
2. Average test would be performed if the peak result were greater than the average limit.
3. Data of measurement within this frequency range shown " --- " in the table above means the reading of emissions are attenuated more than 20dB below the permissible limits or the field strength is too small to be measured.
4. Measurements above show only up to 6 maximum emissions noted, or would be lesser, with " N/A " remark, if no specific emissions from the EUT are recorded (ie: margin>20dB from the applicable limit) and considered that's already beyond the background noise floor.
5. Result = Reading + Correction Factor  
Margin = Result - Limit  
Remark Peak = Result(PK) - Limit(AV)  
Remark AVG = Result(AV) - Limit(AV)



<b>Product Name</b>	300Mbps Wireless N High Power Ceiling-Mounted Access Point	<b>Test By</b>	Rex Chiu
<b>Test Model</b>	WF2520	<b>Test Date</b>	2015/03/05
<b>Test Mode</b>	IEEE 802.11b TX / CH Middle	<b>Temp. &amp; Humidity</b>	19°C, 56%

**966 Chamber\_B at 3Meter / Horizontal**

Frequency (MHz)	Reading-PK (dBuV)	Reading-AV (dBuV)	Correction Factor (dB/m)	Result-PK (dBuV/m)	Result-AV (dBuV/m)	Limit-PK (dBuV/m)	Limit-AV (dBuV/m)	Margin (dB)	Remark
1780.00	54.18	39.57	0.59	54.77	40.16	74.00	54.00	-13.84	AVG
2390.00	51.26	39.59	3.39	54.65	42.98	74.00	54.00	-11.02	AVG
2482.00	52.09	40.22	3.57	55.66	43.79	74.00	54.00	-10.21	AVG
3225.00	42.37	---	4.48	46.85	---	74.00	54.00	-7.15	Peak
4875.00	45.28	45.40	8.04	53.32	53.44	74.00	54.00	-0.56	AVG
7110.00	39.27	---	12.06	51.33	---	74.00	54.00	-2.67	Peak

**966 Chamber\_B at 3Meter / Vertical**

Frequency (MHz)	Reading-PK (dBuV)	Reading-AV (dBuV)	Correction Factor (dB/m)	Result-PK (dBuV/m)	Result-AV (dBuV/m)	Limit-PK (dBuV/m)	Limit-AV (dBuV/m)	Margin (dB)	Remark
1546.00	55.59	40.20	-1.58	54.01	38.62	74.00	54.00	-15.38	AVG
2390.00	51.86	39.93	3.39	55.25	43.32	74.00	54.00	-10.68	AVG
2482.00	52.69	40.58	3.57	56.26	44.15	74.00	54.00	-9.85	AVG
3255.00	42.66	---	4.54	47.20	---	74.00	54.00	-6.80	Peak
4875.00	41.05	---	8.04	49.09	---	74.00	54.00	-4.91	Peak
6930.00	39.10	---	12.22	51.32	---	74.00	54.00	-2.68	Peak

**Remark:**

1. Measuring frequencies from 1 GHz to the 10th harmonic of highest fundamental frequency.
2. Average test would be performed if the peak result were greater than the average limit.
3. Data of measurement within this frequency range shown " --- " in the table above means the reading of emissions are attenuated more than 20dB below the permissible limits or the field strength is too small to be measured.
4. Measurements above show only up to 6 maximum emissions noted, or would be lesser, with " N/A " remark, if no specific emissions from the EUT are recorded (ie: margin>20dB from the applicable limit) and considered that's already beyond the background noise floor.
5. Result = Reading + Correction Factor  
Margin = Result - Limit  
Remark Peak = Result(PK) - Limit(AV)  
Remark AVG = Result(AV) - Limit(AV)





<b>Product Name</b>	300Mbps Wireless N High Power Ceiling-Mounted Access Point	<b>Test By</b>	Rex Chiu
<b>Test Model</b>	WF2520	<b>Test Date</b>	2015/03/05
<b>Test Mode</b>	IEEE 802.11b TX / CH High	<b>Temp. &amp; Humidity</b>	19°C, 56%

966 Chamber_B at 3Meter / Horizontal									
Frequency (MHz)	Reading-PK (dBuV)	Reading-AV (dBuV)	Correction Factor (dB/m)	Result-PK (dBuV/m)	Result-AV (dBuV/m)	Limit-PK (dBuV/m)	Limit-AV (dBuV/m)	Margin (dB)	Remark
2018.00	51.87	39.19	2.67	54.54	41.86	74.00	54.00	-12.14	AVG
2216.00	51.15	39.00	3.05	54.20	42.05	74.00	54.00	-11.95	AVG
2390.00	51.99	40.02	3.39	55.38	43.41	74.00	54.00	-10.59	AVG
3150.00	42.51	---	4.33	46.84	---	74.00	54.00	-7.16	Peak
4920.00	45.70	45.21	8.08	53.77	53.29	74.00	54.00	-0.71	AVG
7110.00	39.57	---	12.06	51.63	---	74.00	54.00	-2.37	Peak

966 Chamber_B at 3Meter / Vertical									
Frequency (MHz)	Reading-PK (dBuV)	Reading-AV (dBuV)	Correction Factor (dB/m)	Result-PK (dBuV/m)	Result-AV (dBuV/m)	Limit-PK (dBuV/m)	Limit-AV (dBuV/m)	Margin (dB)	Remark
1942.00	52.48	39.34	2.09	54.57	41.43	74.00	54.00	-12.57	AVG
2076.00	51.36	39.00	2.78	54.14	41.78	74.00	54.00	-12.22	AVG
2390.00	52.96	40.87	3.39	56.35	44.26	74.00	54.00	-9.74	AVG
3315.00	42.77	---	4.66	47.43	---	74.00	54.00	-6.57	Peak
4920.00	41.77	---	8.08	49.85	---	74.00	54.00	-4.15	Peak
7260.00	39.90	---	11.71	51.62	---	74.00	54.00	-2.38	Peak

**Remark:**

1. Measuring frequencies from 1 GHz to the 10th harmonic of highest fundamental frequency.
2. Average test would be performed if the peak result were greater than the average limit.
3. Data of measurement within this frequency range shown " --- " in the table above means the reading of emissions are attenuated more than 20dB below the permissible limits or the field strength is too small to be measured.
4. Measurements above show only up to 6 maximum emissions noted, or would be lesser, with " N/A " remark, if no specific emissions from the EUT are recorded (ie: margin>20dB from the applicable limit) and considered that's already beyond the background noise floor.
5. Result = Reading + Correction Factor  
Margin = Result - Limit  
Remark Peak = Result(PK) - Limit(AV)  
Remark AVG = Result(AV) - Limit(AV)



<b>Product Name</b>	300Mbps Wireless N High Power Ceiling-Mounted Access Point	<b>Test By</b>	Rex Chiu
<b>Test Model</b>	WF2520	<b>Test Date</b>	2015/03/05
<b>Test Mode</b>	IEEE 802.11g TX / CH Low	<b>Temp. &amp; Humidity</b>	19°C, 56%

966 Chamber_B at 3Meter / Horizontal									
Frequency (MHz)	Reading-PK (dBuV)	Reading-AV (dBuV)	Correction Factor (dB/m)	Result-PK (dBuV/m)	Result-AV (dBuV/m)	Limit-PK (dBuV/m)	Limit-AV (dBuV/m)	Margin (dB)	Remark
1584.00	48.32	---	-1.23	47.09	---	74.00	54.00	-6.91	Peak
1714.00	46.56	---	-0.02	46.54	---	74.00	54.00	-7.46	Peak
2486.00	45.71	---	3.58	49.30	---	74.00	54.00	-4.70	Peak
3165.00	42.62	---	4.36	46.98	---	74.00	54.00	-7.02	Peak
4830.00	45.21	36.35	8.00	53.22	44.35	74.00	54.00	-9.65	AVG
6975.00	38.64	---	12.28	50.92	---	74.00	54.00	-3.08	Peak

966 Chamber_B at 3Meter / Vertical									
Frequency (MHz)	Reading-PK (dBuV)	Reading-AV (dBuV)	Correction Factor (dB/m)	Result-PK (dBuV/m)	Result-AV (dBuV/m)	Limit-PK (dBuV/m)	Limit-AV (dBuV/m)	Margin (dB)	Remark
1366.00	45.16	---	-2.03	43.13	---	74.00	54.00	-10.87	Peak
2034.00	42.48	---	2.70	45.18	---	74.00	54.00	-8.82	Peak
2484.00	49.68	36.33	3.58	53.26	39.91	74.00	54.00	-14.09	AVG
3075.00	42.23	---	4.18	46.41	---	74.00	54.00	-7.59	Peak
4770.00	40.84	---	7.96	48.80	---	74.00	54.00	-5.20	Peak
7140.00	39.72	---	11.99	51.71	---	74.00	54.00	-2.29	Peak

**Remark:**

1. Measuring frequencies from 1 GHz to the 10th harmonic of highest fundamental frequency.
2. Average test would be performed if the peak result were greater than the average limit.
3. Data of measurement within this frequency range shown " --- " in the table above means the reading of emissions are attenuated more than 20dB below the permissible limits or the field strength is too small to be measured.
4. Measurements above show only up to 6 maximum emissions noted, or would be lesser, with " N/A " remark, if no specific emissions from the EUT are recorded (ie: margin>20dB from the applicable limit) and considered that's already beyond the background noise floor.
5. Result = Reading + Correction Factor  
Margin = Result - Limit  
Remark Peak = Result(PK) - Limit(AV)  
Remark AVG = Result(AV) - Limit(AV)



<b>Product Name</b>	300Mbps Wireless N High Power Ceiling-Mounted Access Point	<b>Test By</b>	Rex Chiu
<b>Test Model</b>	WF2520	<b>Test Date</b>	2015/03/05
<b>Test Mode</b>	IEEE 802.11g TX / CH Middle	<b>Temp. &amp; Humidity</b>	19°C, 56%

966 Chamber_B at 3Meter / Horizontal									
Frequency (MHz)	Reading-PK (dBuV)	Reading-AV (dBuV)	Correction Factor (dB/m)	Result-PK (dBuV/m)	Result-AV (dBuV/m)	Limit-PK (dBuV/m)	Limit-AV (dBuV/m)	Margin (dB)	Remark
1668.00	50.30	---	-0.45	49.85	---	74.00	54.00	-4.15	Peak
2388.00	50.56	37.36	3.39	53.95	40.75	74.00	54.00	-13.25	AVG
2500.00	49.56	38.55	3.61	53.17	42.16	74.00	54.00	-11.84	AVG
4875.00	46.01	38.62	8.04	54.05	46.66	74.00	54.00	-7.34	AVG
7305.00	42.54	28.36	11.61	54.15	39.97	74.00	54.00	-14.03	AVG
9750.00	39.07	37.67	14.29	53.36	51.96	74.00	54.00	-2.04	AVG

966 Chamber_B at 3Meter / Vertical									
Frequency (MHz)	Reading-PK (dBuV)	Reading-AV (dBuV)	Correction Factor (dB/m)	Result-PK (dBuV/m)	Result-AV (dBuV/m)	Limit-PK (dBuV/m)	Limit-AV (dBuV/m)	Margin (dB)	Remark
1952.00	42.94	---	2.18	45.13	---	74.00	54.00	-8.87	Peak
2390.00	53.40	40.10	3.39	56.79	43.49	74.00	54.00	-10.51	AVG
2484.00	52.92	39.71	3.58	56.50	43.29	74.00	54.00	-10.71	AVG
3285.00	42.13	---	4.60	46.73	---	74.00	54.00	-7.27	Peak
4875.00	44.39	---	8.04	52.43	---	74.00	54.00	-1.57	Peak
7305.00	43.92	34.54	11.61	55.53	46.15	74.00	54.00	-7.85	AVG

**Remark:**

1. Measuring frequencies from 1 GHz to the 10th harmonic of highest fundamental frequency.
2. Average test would be performed if the peak result were greater than the average limit.
3. Data of measurement within this frequency range shown " --- " in the table above means the reading of emissions are attenuated more than 20dB below the permissible limits or the field strength is too small to be measured.
4. Measurements above show only up to 6 maximum emissions noted, or would be lesser, with " N/A " remark, if no specific emissions from the EUT are recorded (ie: margin>20dB from the applicable limit) and considered that's already beyond the background noise floor.
5. Result = Reading + Correction Factor  
Margin = Result - Limit  
Remark Peak = Result(PK) - Limit(AV)  
Remark AVG = Result(AV) - Limit(AV)



<b>Product Name</b>	300Mbps Wireless N High Power Ceiling-Mounted Access Point	<b>Test By</b>	Rex Chiu
<b>Test Model</b>	WF2520	<b>Test Date</b>	2015/03/05
<b>Test Mode</b>	IEEE 802.11g TX / CH High	<b>Temp. &amp; Humidity</b>	19°C, 56%

966 Chamber_B at 3Meter / Horizontal									
Frequency (MHz)	Reading-PK (dBuV)	Reading-AV (dBuV)	Correction Factor (dB/m)	Result-PK (dBuV/m)	Result-AV (dBuV/m)	Limit-PK (dBuV/m)	Limit-AV (dBuV/m)	Margin (dB)	Remark
1714.00	48.64	---	-0.02	48.62	---	74.00	54.00	-5.38	Peak
2390.00	46.50	---	3.39	49.90	---	74.00	54.00	-4.10	Peak
2908.00	42.01	---	4.57	46.58	---	74.00	54.00	-7.42	Peak
4920.00	45.11	34.64	8.08	53.19	42.72	74.00	54.00	-11.28	AVG
7380.00	42.55	27.60	11.44	53.99	39.04	74.00	54.00	-14.96	AVG
9855.00	40.31	38.77	14.44	54.75	53.21	74.00	54.00	-0.79	AVG

966 Chamber_B at 3Meter / Vertical									
Frequency (MHz)	Reading-PK (dBuV)	Reading-AV (dBuV)	Correction Factor (dB/m)	Result-PK (dBuV/m)	Result-AV (dBuV/m)	Limit-PK (dBuV/m)	Limit-AV (dBuV/m)	Margin (dB)	Remark
2188.00	42.15	---	3.00	45.15	---	74.00	54.00	-8.85	Peak
2390.00	47.36	---	3.39	50.75	---	74.00	54.00	-3.25	Peak
2728.00	42.89	---	4.15	47.04	---	74.00	54.00	-6.96	Peak
3135.00	42.33	---	4.30	46.63	---	74.00	54.00	-7.37	Peak
4920.00	42.79	---	8.08	50.87	---	74.00	54.00	-3.13	Peak
7380.00	41.50	26.49	11.44	52.94	37.93	74.00	54.00	-16.07	AVG

**Remark:**

1. Measuring frequencies from 1 GHz to the 10th harmonic of highest fundamental frequency.
2. Average test would be performed if the peak result were greater than the average limit.
3. Data of measurement within this frequency range shown " --- " in the table above means the reading of emissions are attenuated more than 20dB below the permissible limits or the field strength is too small to be measured.
4. Measurements above show only up to 6 maximum emissions noted, or would be lesser, with " N/A " remark, if no specific emissions from the EUT are recorded (ie: margin>20dB from the applicable limit) and considered that's already beyond the background noise floor.
5. Result = Reading + Correction Factor  
Margin = Result - Limit  
Remark Peak = Result(PK) - Limit(AV)  
Remark AVG = Result(AV) - Limit(AV)



<b>Product Name</b>	300Mbps Wireless N High Power Ceiling-Mounted Access Point	<b>Test By</b>	Rex Chiu
<b>Test Model</b>	WF2520	<b>Test Date</b>	2015/03/05
<b>Test Mode</b>	IEEE 802.11gn HT20 TX / CH Low	<b>Temp. &amp; Humidity</b>	19°C, 56%

966 Chamber_B at 3Meter / Horizontal									
Frequency (MHz)	Reading-PK (dBuV)	Reading-AV (dBuV)	Correction Factor (dB/m)	Result-PK (dBuV/m)	Result-AV (dBuV/m)	Limit-PK (dBuV/m)	Limit-AV (dBuV/m)	Margin (dB)	Remark
1714.00	51.05	---	-0.02	51.03	---	74.00	54.00	-2.97	Peak
2488.00	47.05	---	3.59	50.64	---	74.00	54.00	-3.36	Peak
2792.00	47.81	---	4.30	52.11	---	74.00	54.00	-1.89	Peak
4815.00	47.09	35.78	7.99	55.08	43.77	74.00	54.00	-10.23	AVG
7110.00	39.31	---	12.06	51.36	---	74.00	54.00	-2.64	Peak
9645.00	40.45	38.41	14.14	54.60	52.55	74.00	54.00	-1.45	AVG

966 Chamber_B at 3Meter / Vertical									
Frequency (MHz)	Reading-PK (dBuV)	Reading-AV (dBuV)	Correction Factor (dB/m)	Result-PK (dBuV/m)	Result-AV (dBuV/m)	Limit-PK (dBuV/m)	Limit-AV (dBuV/m)	Margin (dB)	Remark
1692.00	48.12	---	-0.23	47.89	---	74.00	54.00	-6.11	Peak
2246.00	47.83	---	3.11	50.94	---	74.00	54.00	-3.06	Peak
2484.00	48.01	---	3.58	51.59	---	74.00	54.00	-2.41	Peak
4830.00	41.28	---	8.00	49.28	---	74.00	54.00	-4.72	Peak
7230.00	40.53	---	11.78	52.31	---	74.00	54.00	-1.69	Peak
9645.00	39.77	32.48	14.14	53.91	46.62	74.00	54.00	-7.38	AVG

**Remark:**

1. Measuring frequencies from 1 GHz to the 10th harmonic of highest fundamental frequency.
2. Average test would be performed if the peak result were greater than the average limit.
3. Data of measurement within this frequency range shown " --- " in the table above means the reading of emissions are attenuated more than 20dB below the permissible limits or the field strength is too small to be measured.
4. Measurements above show only up to 6 maximum emissions noted, or would be lesser, with " N/A " remark, if no specific emissions from the EUT are recorded (ie: margin>20dB from the applicable limit) and considered that's already beyond the background noise floor.
5. Result = Reading + Correction Factor  
Margin = Result – Limit  
Remark Peak = Result(PK) – Limit(AV)  
Remark AVG = Result(AV) – Limit(AV)



<b>Product Name</b>	300Mbps Wireless N High Power Ceiling-Mounted Access Point	<b>Test By</b>	Rex Chiu
<b>Test Model</b>	WF2520	<b>Test Date</b>	2015/03/05
<b>Test Mode</b>	IEEE 802.11gn HT20 TX / CH Middle	<b>Temp. &amp; Humidity</b>	19°C, 56%

966 Chamber_B at 3Meter / Horizontal									
Frequency (MHz)	Reading-PK (dBuV)	Reading-AV (dBuV)	Correction Factor (dB/m)	Result-PK (dBuV/m)	Result-AV (dBuV/m)	Limit-PK (dBuV/m)	Limit-AV (dBuV/m)	Margin (dB)	Remark
1834.00	48.63	---	1.09	49.72	---	74.00	54.00	-4.28	Peak
2390.00	50.04	36.66	3.39	53.43	40.05	74.00	54.00	-13.95	AVG
2498.00	50.41	37.29	3.61	54.02	40.90	74.00	54.00	-13.1	AVG
4875.00	46.53	36.27	8.04	54.57	44.31	74.00	54.00	-9.69	AVG
7305.00	40.77	---	11.61	52.37	---	74.00	54.00	-1.63	Peak
9750.00	39.81	37.50	14.29	54.10	51.79	74.00	54.00	-2.21	AVG

966 Chamber_B at 3Meter / Vertical									
Frequency (MHz)	Reading-PK (dBuV)	Reading-AV (dBuV)	Correction Factor (dB/m)	Result-PK (dBuV/m)	Result-AV (dBuV/m)	Limit-PK (dBuV/m)	Limit-AV (dBuV/m)	Margin (dB)	Remark
2286.00	48.99	---	3.19	52.18	---	74.00	54.00	-1.82	Peak
2390.00	53.53	39.56	3.39	56.92	42.95	74.00	54.00	-11.05	AVG
2484.00	53.96	40.23	3.58	57.54	43.81	74.00	54.00	-10.19	AVG
3225.00	42.71	---	4.48	47.19	---	74.00	54.00	-6.81	Peak
4875.00	42.00	---	8.04	50.04	---	74.00	54.00	-3.96	Peak
6615.00	40.02	---	11.80	51.82	---	74.00	54.00	-2.18	Peak

**Remark:**

1. Measuring frequencies from 1 GHz to the 10th harmonic of highest fundamental frequency.
2. Average test would be performed if the peak result were greater than the average limit.
3. Data of measurement within this frequency range shown " --- " in the table above means the reading of emissions are attenuated more than 20dB below the permissible limits or the field strength is too small to be measured.
4. Measurements above show only up to 6 maximum emissions noted, or would be lesser, with " N/A " remark, if no specific emissions from the EUT are recorded (ie: margin>20dB from the applicable limit) and considered that's already beyond the background noise floor.
5. Result = Reading + Correction Factor  
Margin = Result - Limit  
Remark Peak = Result(PK) - Limit(AV)  
Remark AVG = Result(AV) - Limit(AV)



<b>Product Name</b>	300Mbps Wireless N High Power Ceiling-Mounted Access Point	<b>Test By</b>	Rex Chiu
<b>Test Model</b>	WF2520	<b>Test Date</b>	2015/03/05
<b>Test Mode</b>	IEEE 802.11gn HT20 TX / CH High	<b>Temp. &amp; Humidity</b>	19°C, 56%

966 Chamber_B at 3Meter / Horizontal									
Frequency (MHz)	Reading-PK (dBuV)	Reading-AV (dBuV)	Correction Factor (dB/m)	Result-PK (dBuV/m)	Result-AV (dBuV/m)	Limit-PK (dBuV/m)	Limit-AV (dBuV/m)	Margin (dB)	Remark
1724.00	48.67	---	0.07	48.74	---	74.00	54.00	-5.26	Peak
2254.00	47.57	---	3.13	50.70	---	74.00	54.00	-3.30	Peak
2390.00	46.16	---	3.39	49.55	---	74.00	54.00	-4.45	Peak
4920.00	44.52	---	8.08	52.60	---	74.00	54.00	-1.40	Peak
6810.00	39.65	---	12.06	51.71	---	74.00	54.00	-2.29	Peak
9855.00	40.08	38.64	14.44	54.52	53.08	74.00	54.00	-0.92	AVG

966 Chamber_B at 3Meter / Vertical									
Frequency (MHz)	Reading-PK (dBuV)	Reading-AV (dBuV)	Correction Factor (dB/m)	Result-PK (dBuV/m)	Result-AV (dBuV/m)	Limit-PK (dBuV/m)	Limit-AV (dBuV/m)	Margin (dB)	Remark
1708.00	47.64	---	-0.08	47.56	---	74.00	54.00	-6.44	Peak
2088.00	47.92	---	2.80	50.73	---	74.00	54.00	-3.27	Peak
2390.00	48.54	---	3.39	51.94	---	74.00	54.00	-2.06	Peak
4920.00	41.43	---	8.08	49.51	---	74.00	54.00	-4.49	Peak
6945.00	38.97	---	12.24	51.21	---	74.00	54.00	-2.79	Peak
9855.00	39.77	28.78	14.44	54.21	43.22	74.00	54.00	-10.78	AVG

**Remark:**

1. Measuring frequencies from 1 GHz to the 10th harmonic of highest fundamental frequency.
2. Average test would be performed if the peak result were greater than the average limit.
3. Data of measurement within this frequency range shown " --- " in the table above means the reading of emissions are attenuated more than 20dB below the permissible limits or the field strength is too small to be measured.
4. Measurements above show only up to 6 maximum emissions noted, or would be lesser, with " N/A " remark, if no specific emissions from the EUT are recorded (ie: margin>20dB from the applicable limit) and considered that's already beyond the background noise floor.
5. Result = Reading + Correction Factor  
 Margin = Result - Limit  
 Remark Peak = Result(PK) - Limit(AV)  
 Remark AVG = Result(AV) - Limit(AV)





<b>Product Name</b>	300Mbps Wireless N High Power Ceiling-Mounted Access Point	<b>Test By</b>	Rex Chiu
<b>Test Model</b>	WF2520	<b>Test Date</b>	2015/03/05
<b>Test Mode</b>	IEEE 802.11gn HT40 TX / CH Low	<b>Temp. &amp; Humidity</b>	19°C, 56%

966 Chamber_B at 3Meter / Horizontal									
Frequency (MHz)	Reading-PK (dBuV)	Reading-AV (dBuV)	Correction Factor (dB/m)	Result-PK (dBuV/m)	Result-AV (dBuV/m)	Limit-PK (dBuV/m)	Limit-AV (dBuV/m)	Margin (dB)	Remark
1784.00	47.70	---	0.63	48.32	---	74.00	54.00	-5.68	Peak
2256.00	47.35	---	3.13	50.49	---	74.00	54.00	-3.51	Peak
2494.00	47.00	---	3.60	50.60	---	74.00	54.00	-3.40	Peak
3210.00	42.73	---	4.45	47.18	---	74.00	54.00	-6.82	Peak
4845.00	41.66	---	8.02	49.68	---	74.00	54.00	-4.32	Peak
6870.00	39.77	---	12.14	51.90	---	74.00	54.00	-2.10	Peak

966 Chamber_B at 3Meter / Vertical									
Frequency (MHz)	Reading-PK (dBuV)	Reading-AV (dBuV)	Correction Factor (dB/m)	Result-PK (dBuV/m)	Result-AV (dBuV/m)	Limit-PK (dBuV/m)	Limit-AV (dBuV/m)	Margin (dB)	Remark
1882.00	47.94	---	1.53	49.48	---	74.00	54.00	-4.52	Peak
2254.00	47.78	---	3.13	50.91	---	74.00	54.00	-3.09	Peak
2484.00	47.86	---	3.58	51.43	---	74.00	54.00	-2.57	Peak
3645.00	41.95	---	5.30	47.25	---	74.00	54.00	-6.75	Peak
4800.00	40.47	---	7.98	48.45	---	74.00	54.00	-5.55	Peak
6945.00	39.41	---	12.24	51.65	---	74.00	54.00	-2.35	Peak

**Remark:**

1. Measuring frequencies from 1 GHz to the 10th harmonic of highest fundamental frequency.
2. Average test would be performed if the peak result were greater than the average limit.
3. Data of measurement within this frequency range shown " --- " in the table above means the reading of emissions are attenuated more than 20dB below the permissible limits or the field strength is too small to be measured.
4. Measurements above show only up to 6 maximum emissions noted, or would be lesser, with " N/A " remark, if no specific emissions from the EUT are recorded (ie: margin>20dB from the applicable limit) and considered that's already beyond the background noise floor.
5. Result = Reading + Correction Factor  
Margin = Result – Limit  
Remark Peak = Result(PK) – Limit(AV)  
Remark AVG = Result(AV) – Limit(AV)





<b>Product Name</b>	300Mbps Wireless N High Power Ceiling-Mounted Access Point	<b>Test By</b>	Rex Chiu
<b>Test Model</b>	WF2520	<b>Test Date</b>	2015/03/05
<b>Test Mode</b>	IEEE 802.11gn HT40 TX / CH Middle	<b>Temp. &amp; Humidity</b>	19°C, 56%

966 Chamber_B at 3Meter / Horizontal									
Frequency (MHz)	Reading-PK (dBuV)	Reading-AV (dBuV)	Correction Factor (dB/m)	Result-PK (dBuV/m)	Result-AV (dBuV/m)	Limit-PK (dBuV/m)	Limit-AV (dBuV/m)	Margin (dB)	Remark
1738.00	48.95	---	0.20	49.15	---	74.00	54.00	-4.85	Peak
2390.00	59.47	47.44	3.39	62.86	50.83	74.00	54.00	-3.17	AVG
2484.00	58.40	44.96	3.58	61.98	48.54	74.00	54.00	-5.46	AVG
3255.00	41.93	---	4.54	46.47	---	74.00	54.00	-7.53	Peak
4860.00	43.30	---	8.03	51.33	---	74.00	54.00	-2.67	Peak
7110.00	39.90	---	12.06	51.96	---	74.00	54.00	-2.04	Peak

966 Chamber_B at 3Meter / Vertical									
Frequency (MHz)	Reading-PK (dBuV)	Reading-AV (dBuV)	Correction Factor (dB/m)	Result-PK (dBuV/m)	Result-AV (dBuV/m)	Limit-PK (dBuV/m)	Limit-AV (dBuV/m)	Margin (dB)	Remark
1734.00	47.87	---	0.16	48.03	---	74.00	54.00	-5.97	Peak
2390.00	63.54	49.84	3.39	66.93	53.23	74.00	54.00	-0.77	AVG
2484.00	60.19	49.52	3.58	63.77	53.10	74.00	54.00	-0.90	AVG
3135.00	41.75	---	4.30	46.05	---	74.00	54.00	-7.95	Peak
4890.00	40.66	---	8.05	48.72	---	74.00	54.00	-5.28	Peak
7140.00	39.19	---	11.99	51.17	---	74.00	54.00	-2.83	Peak

**Remark:**

1. Measuring frequencies from 1 GHz to the 10th harmonic of highest fundamental frequency.
2. Average test would be performed if the peak result were greater than the average limit.
3. Data of measurement within this frequency range shown " --- " in the table above means the reading of emissions are attenuated more than 20dB below the permissible limits or the field strength is too small to be measured.
4. Measurements above show only up to 6 maximum emissions noted, or would be lesser, with " N/A " remark, if no specific emissions from the EUT are recorded (ie: margin>20dB from the applicable limit) and considered that's already beyond the background noise floor.
5. Result = Reading + Correction Factor  
Margin = Result - Limit  
Remark Peak = Result(PK) - Limit(AV)  
Remark AVG = Result(AV) - Limit(AV)



<b>Product Name</b>	300Mbps Wireless N High Power Ceiling-Mounted Access Point	<b>Test By</b>	Rex Chiu
<b>Test Model</b>	WF2520	<b>Test Date</b>	2015/03/05
<b>Test Mode</b>	IEEE 802.11gn HT40 TX / CH High	<b>Temp. &amp; Humidity</b>	19°C, 56%

966 Chamber_B at 3Meter / Horizontal									
Frequency (MHz)	Reading-PK (dBuV)	Reading-AV (dBuV)	Correction Factor (dB/m)	Result-PK (dBuV/m)	Result-AV (dBuV/m)	Limit-PK (dBuV/m)	Limit-AV (dBuV/m)	Margin (dB)	Remark
1704.00	48.66	---	-0.12	48.54	---	74.00	54.00	-5.46	Peak
2162.00	47.51	---	2.95	50.46	---	74.00	54.00	-3.54	Peak
2382.00	48.15	---	3.38	51.53	---	74.00	54.00	-2.47	Peak
4905.00	42.30	---	8.06	50.37	---	74.00	54.00	-3.63	Peak
6930.00	39.43	---	12.22	51.64	---	74.00	54.00	-2.36	Peak
9810.00	40.99	38.74	14.37	55.36	53.11	74.00	54.00	-0.89	AVG

966 Chamber_B at 3Meter / Vertical									
Frequency (MHz)	Reading-PK (dBuV)	Reading-AV (dBuV)	Correction Factor (dB/m)	Result-PK (dBuV/m)	Result-AV (dBuV/m)	Limit-PK (dBuV/m)	Limit-AV (dBuV/m)	Margin (dB)	Remark
1742.00	48.18	---	0.24	48.41	---	74.00	54.00	-5.59	Peak
2070.00	47.14	---	2.77	49.91	---	74.00	54.00	-4.09	Peak
2384.00	48.55	---	3.38	51.94	---	74.00	54.00	-2.06	Peak
3240.00	42.63	---	4.51	47.14	---	74.00	54.00	-6.86	Peak
4815.00	40.57	---	7.99	48.56	---	74.00	54.00	-5.44	Peak
6975.00	40.08	---	12.28	52.36	---	74.00	54.00	-1.64	Peak

**Remark:**

1. Measuring frequencies from 1 GHz to the 10th harmonic of highest fundamental frequency.
2. Average test would be performed if the peak result were greater than the average limit.
3. Data of measurement within this frequency range shown " --- " in the table above means the reading of emissions are attenuated more than 20dB below the permissible limits or the field strength is too small to be measured.
4. Measurements above show only up to 6 maximum emissions noted, or would be lesser, with " N/A " remark, if no specific emissions from the EUT are recorded (ie: margin>20dB from the applicable limit) and considered that's already beyond the background noise floor.
5. Result = Reading + Correction Factor  
Margin = Result - Limit  
Remark Peak = Result(PK) - Limit(AV)  
Remark AVG = Result(AV) - Limit(AV)



Restricted Band Edges

Detector Mode : Peak

Polarity : Horizontal

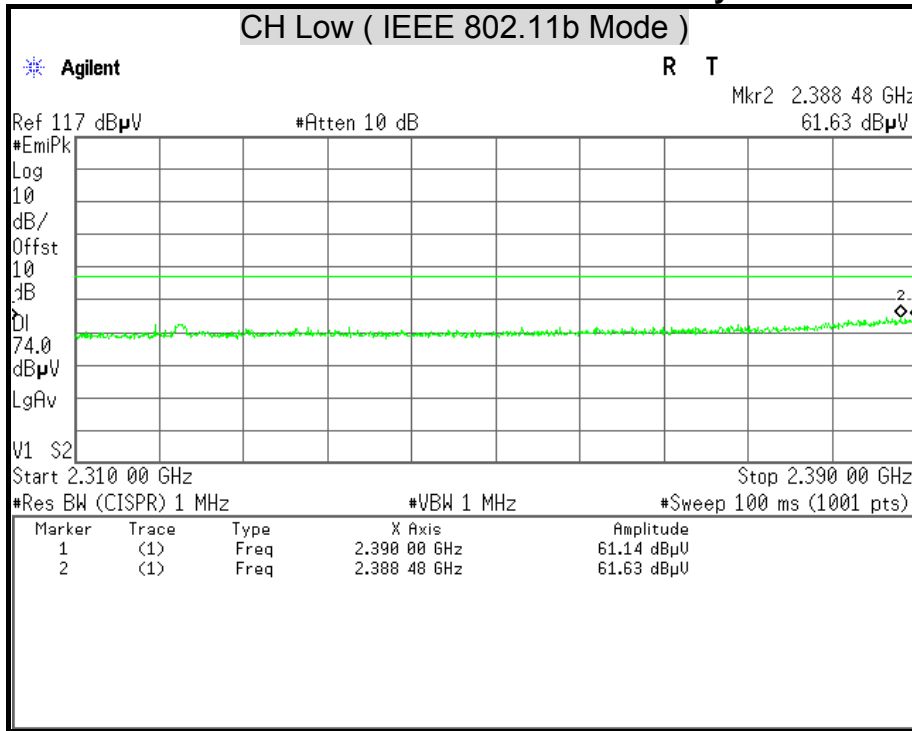

Detector Mode : Average

Polarity : Horizontal

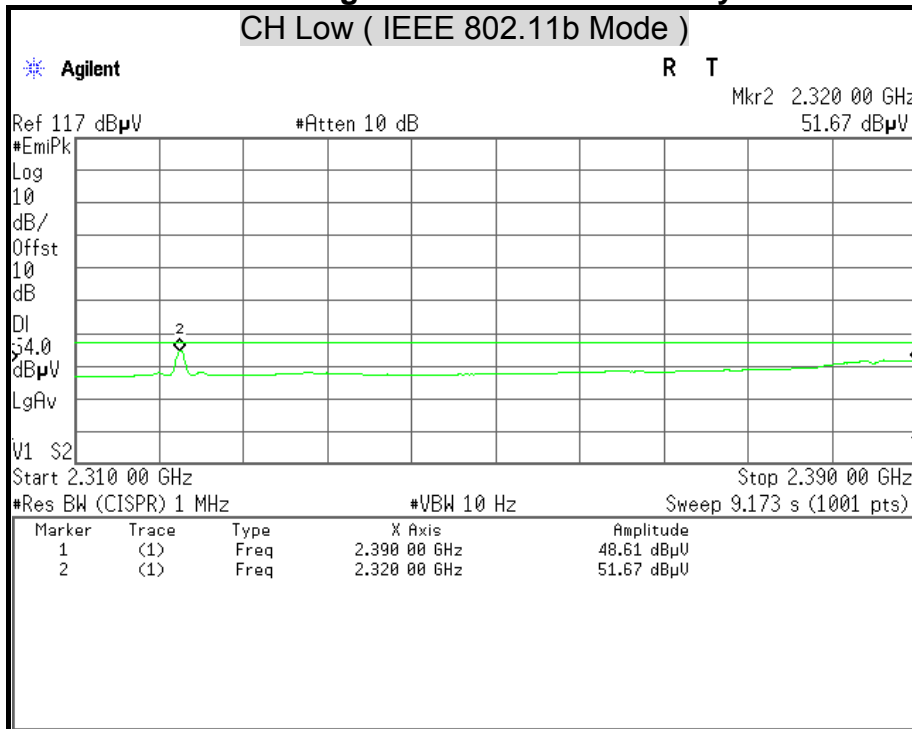



Detector Mode : Peak

Polarity : Vertical

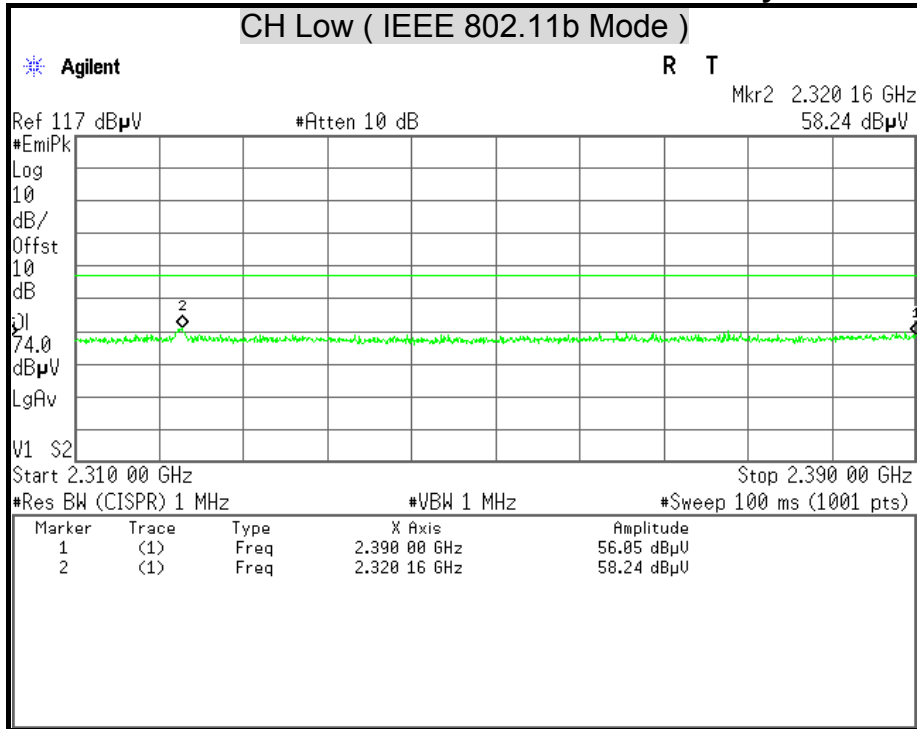

Detector Mode : Average

Polarity : Vertical

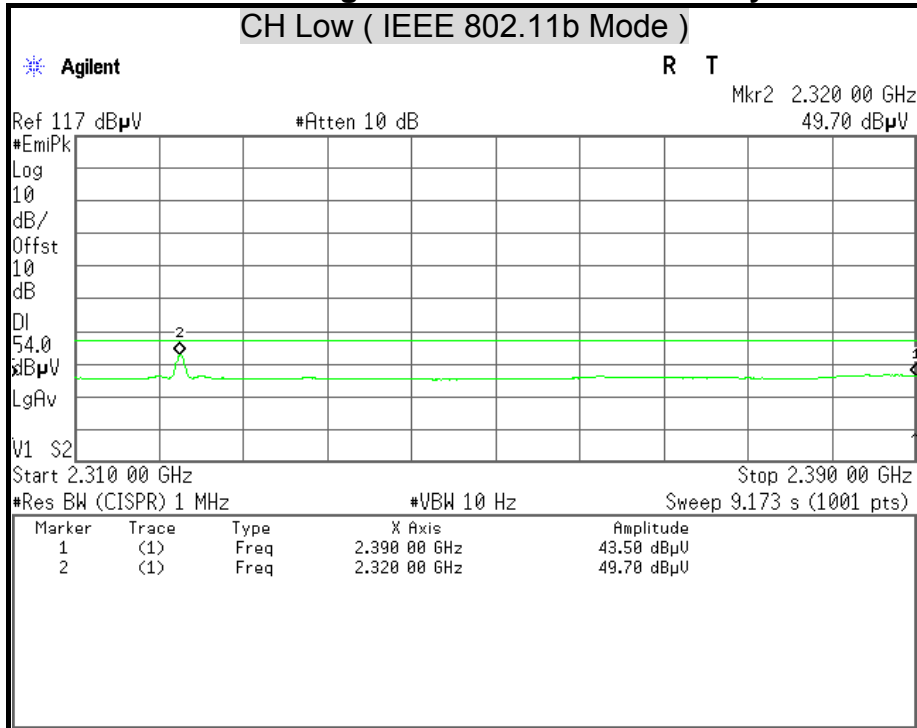



Detector Mode : Peak

Polarity : Horizontal

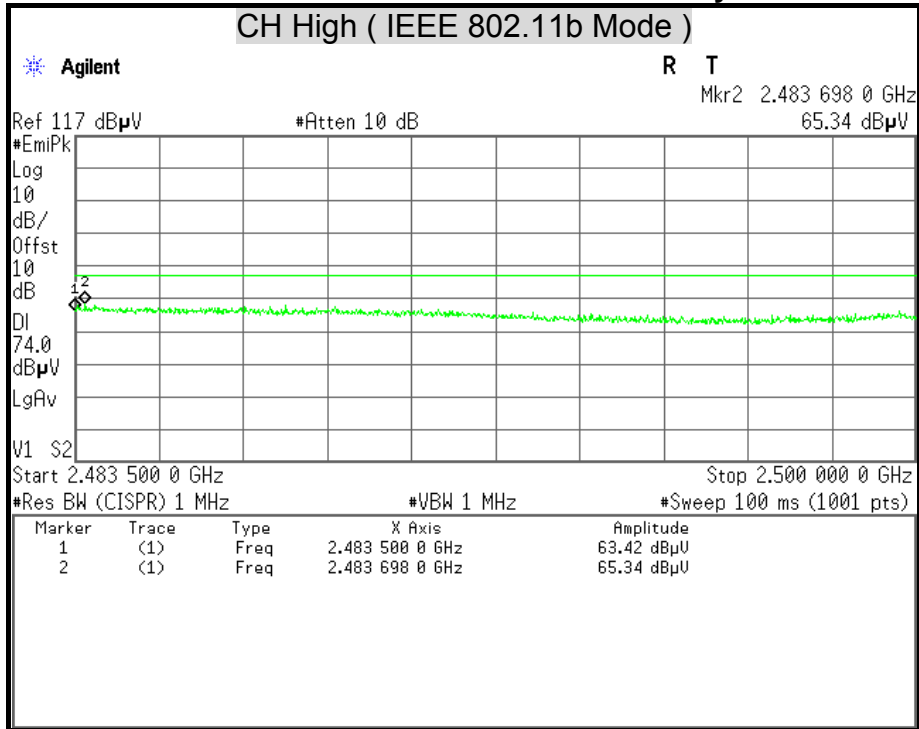

Detector Mode : Average

Polarity : Horizontal

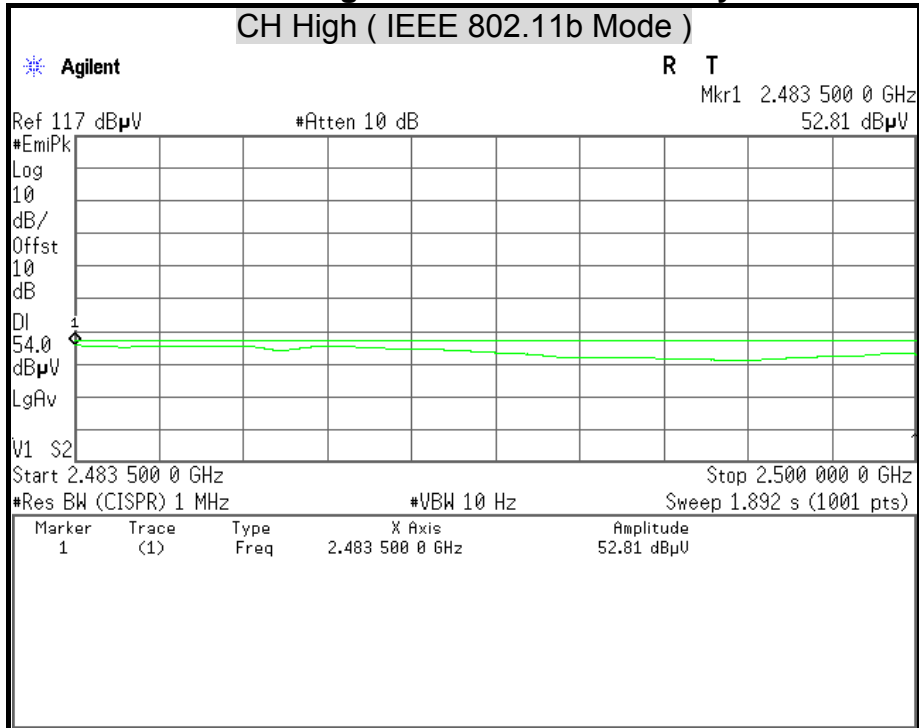



Detector Mode : Peak

Polarity : Vertical

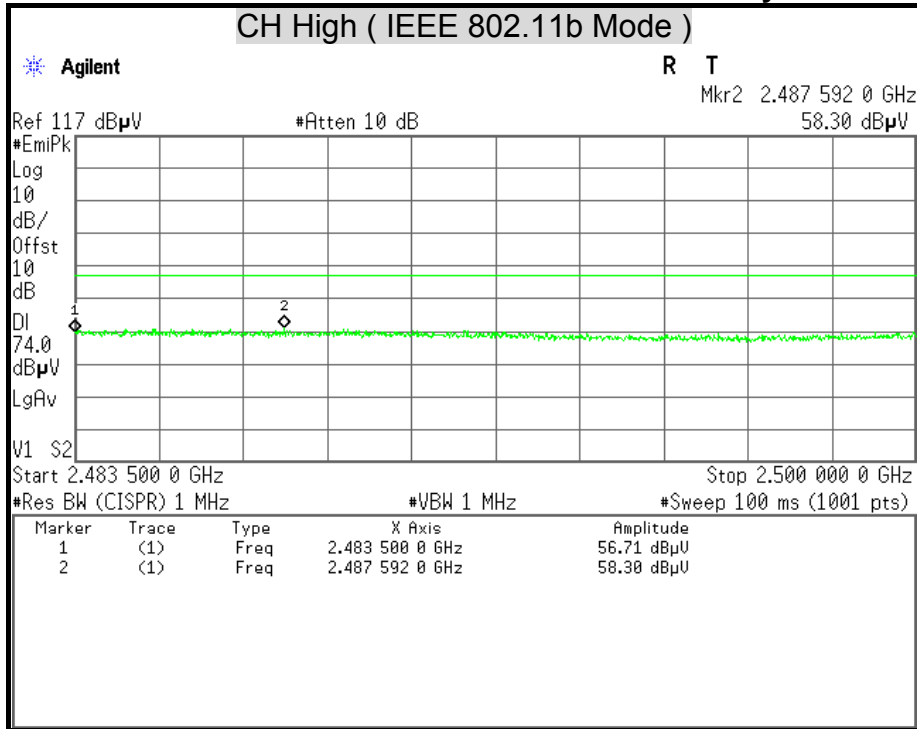

Detector Mode : Average

Polarity : Vertical

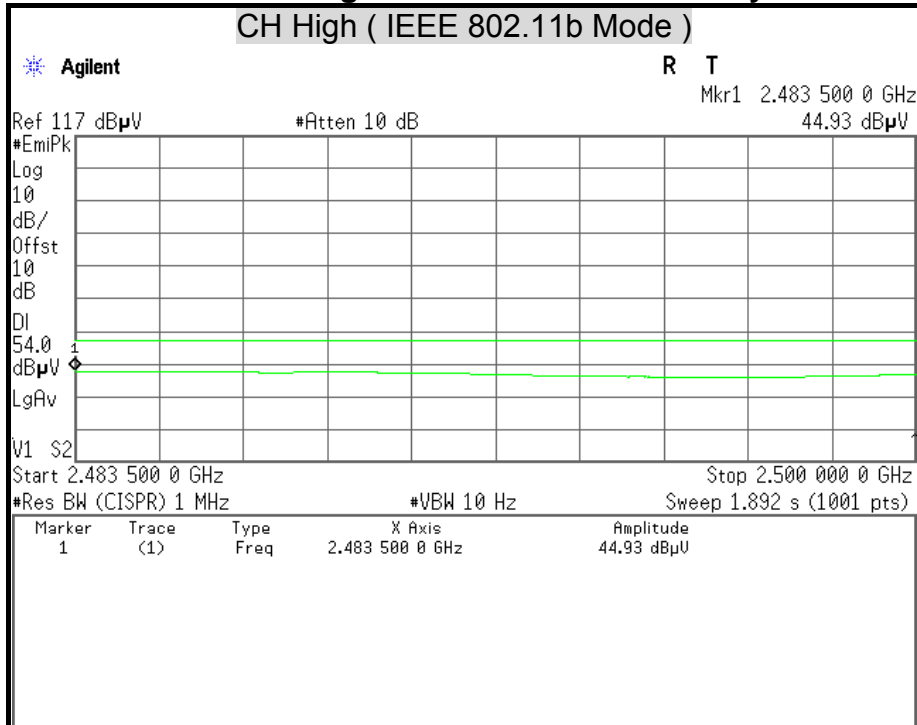



Detector Mode : Peak

Polarity : Horizontal

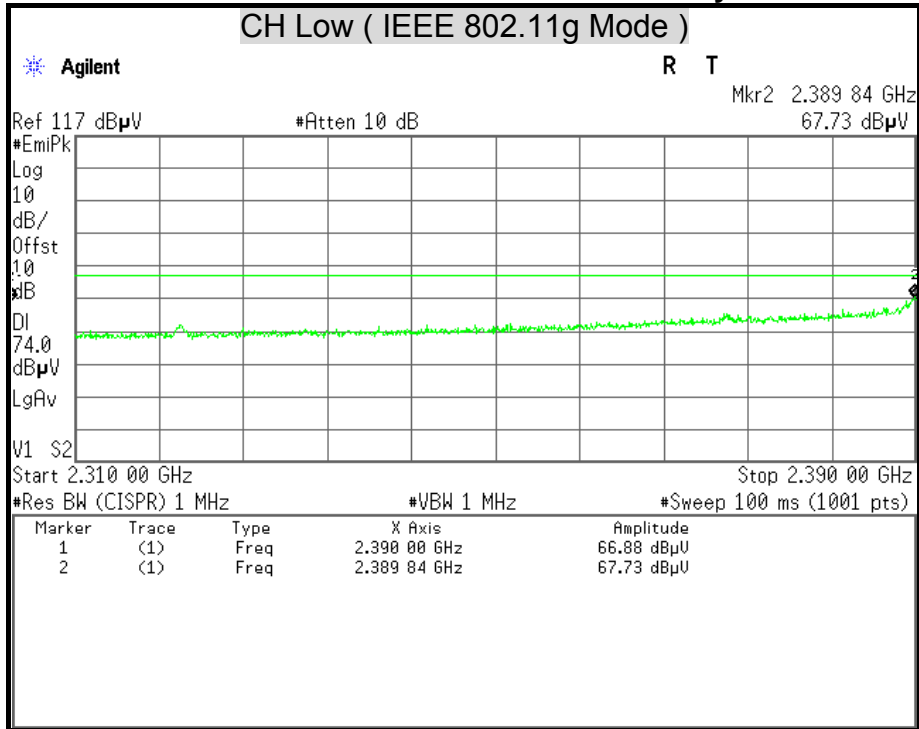

Detector Mode : Average

Polarity : Horizontal

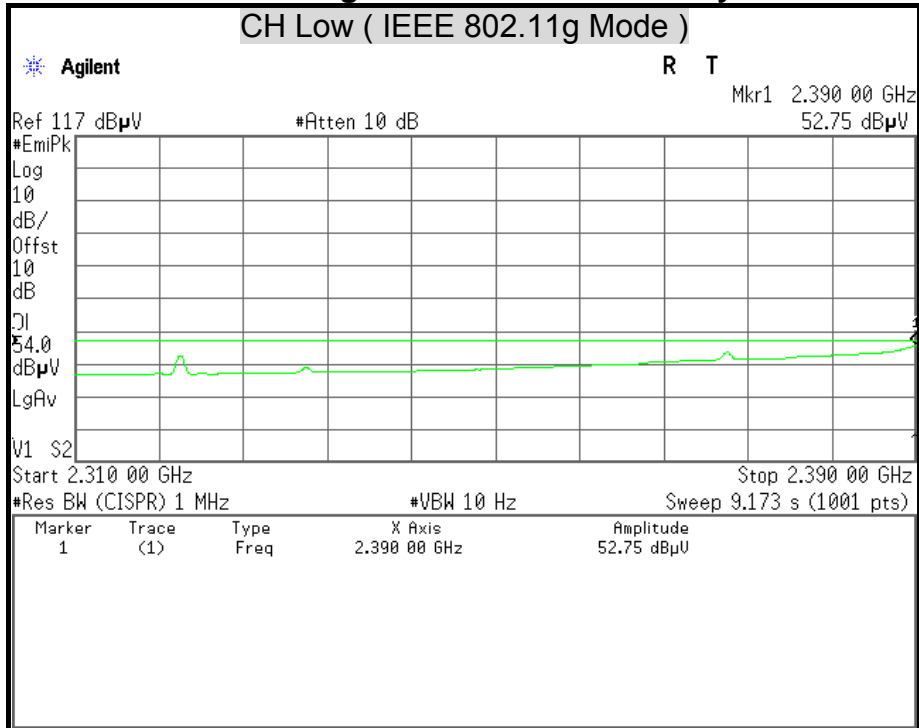



Detector Mode : Peak

Polarity : Vertical

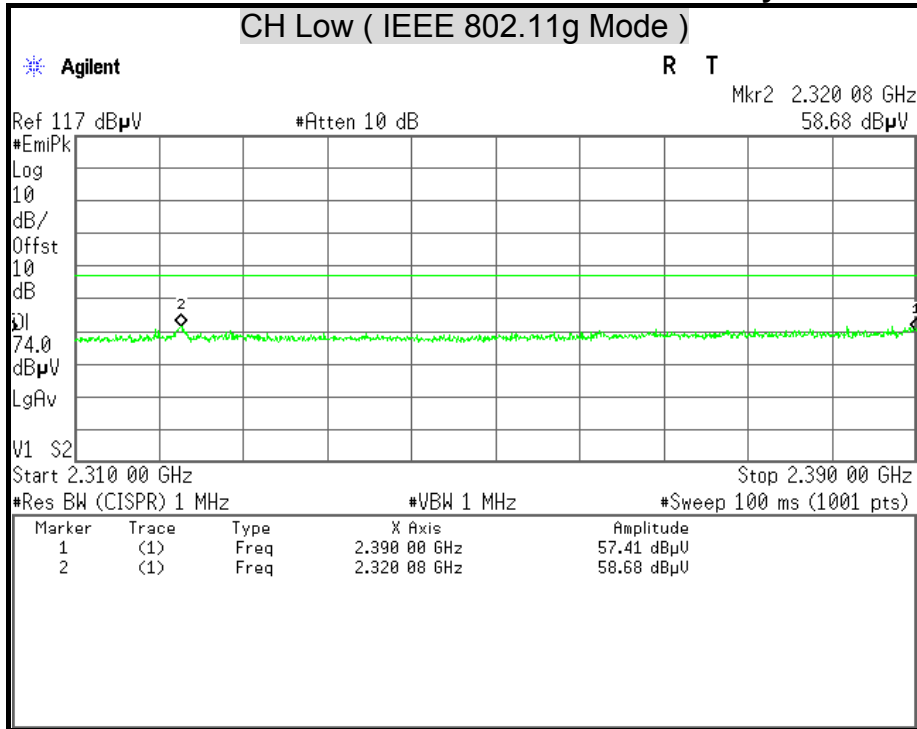

Detector Mode : Average

Polarity : Vertical

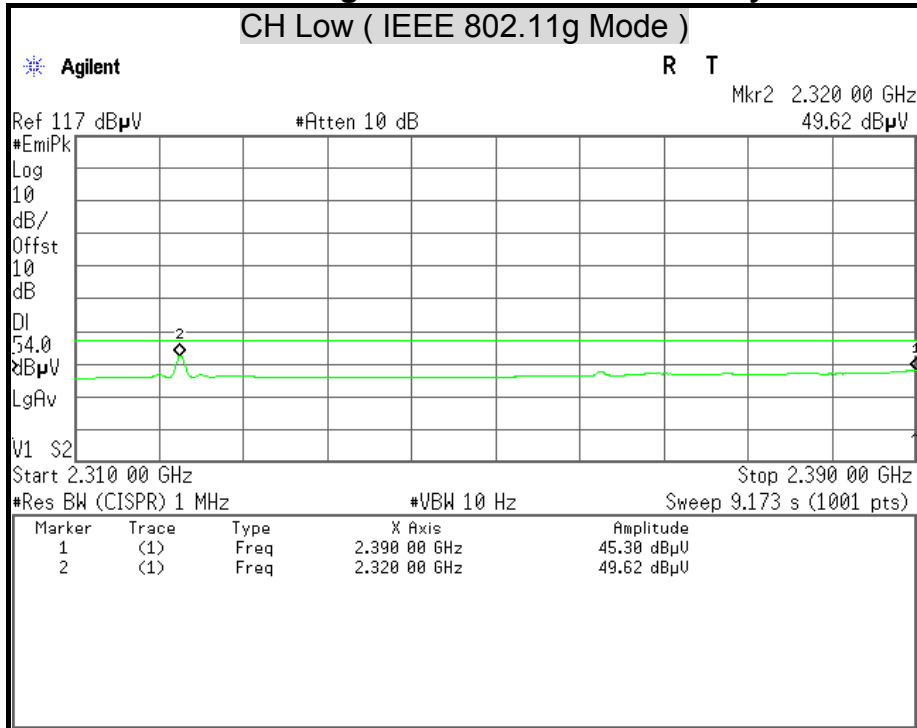





Detector Mode : Peak

Polarity : Horizontal

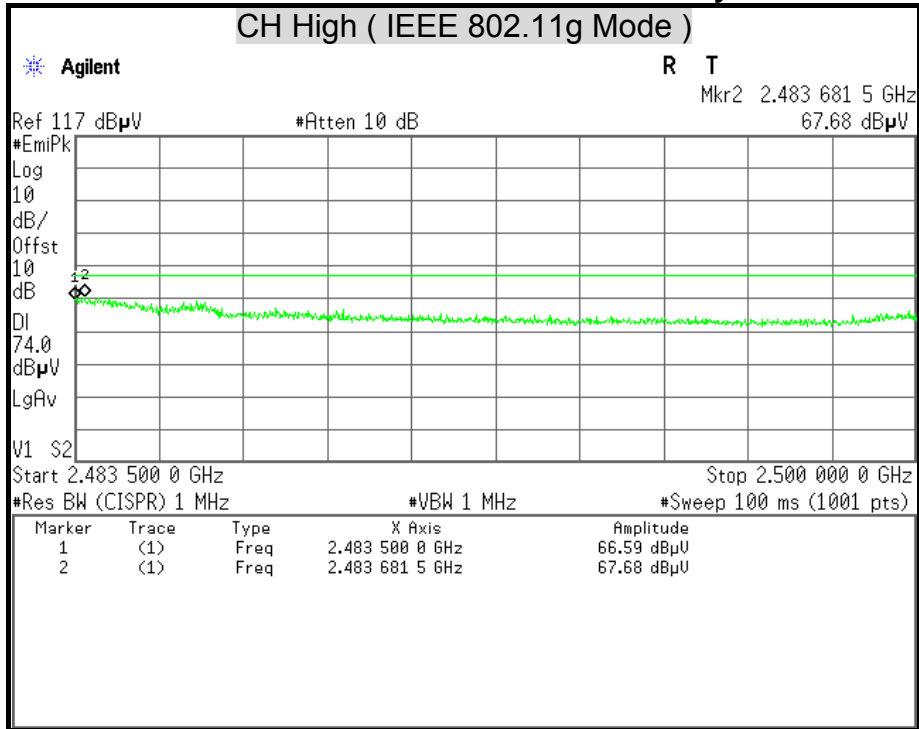

Detector Mode : Average

Polarity : Horizontal

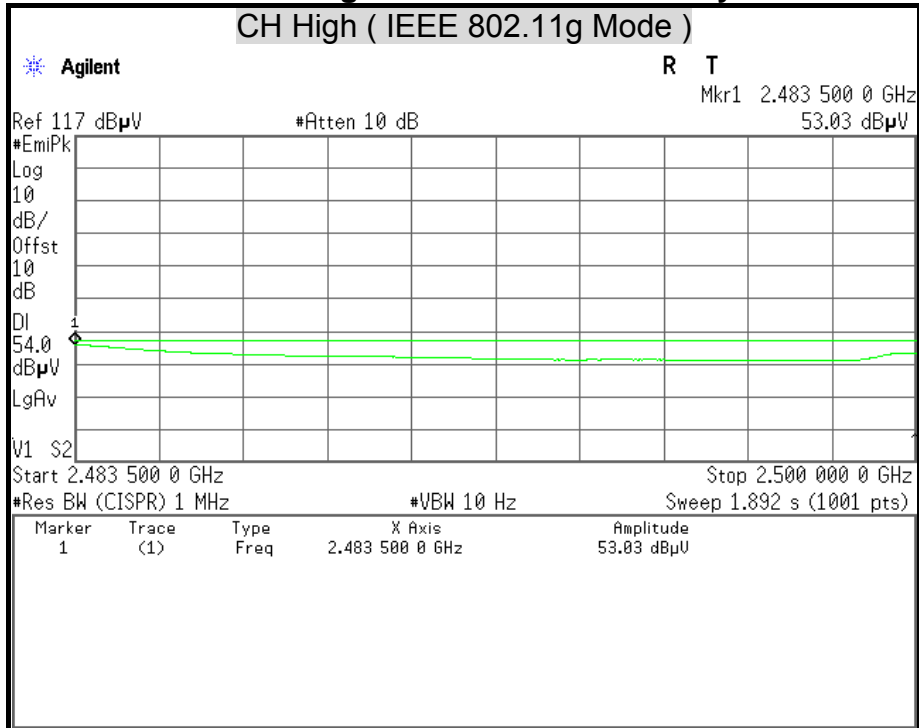



Detector Mode : Peak

Polarity : Vertical

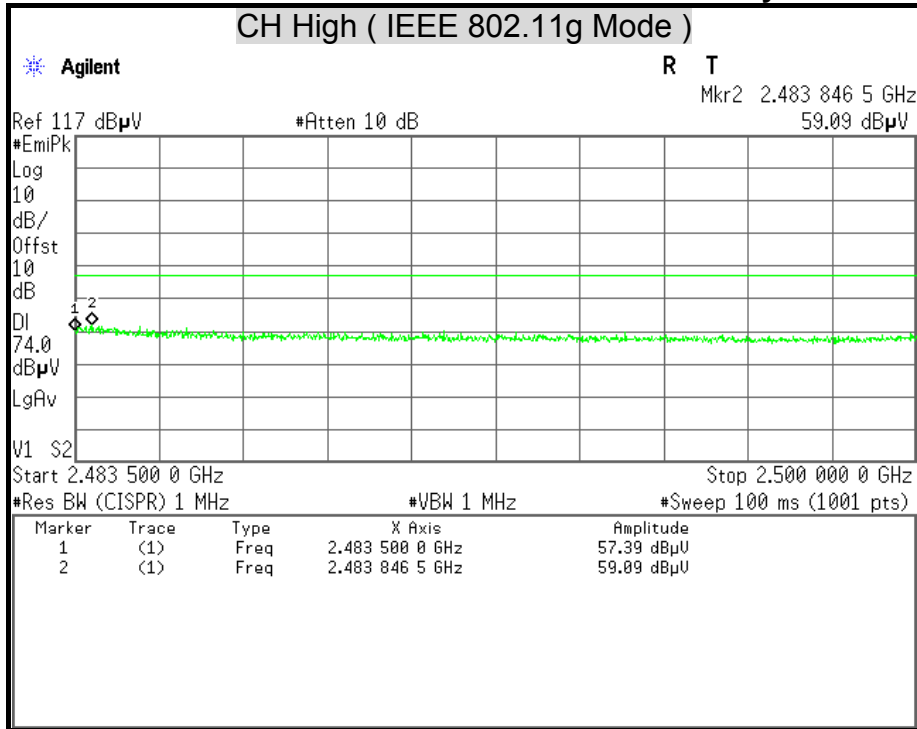

Detector Mode : Average

Polarity : Vertical

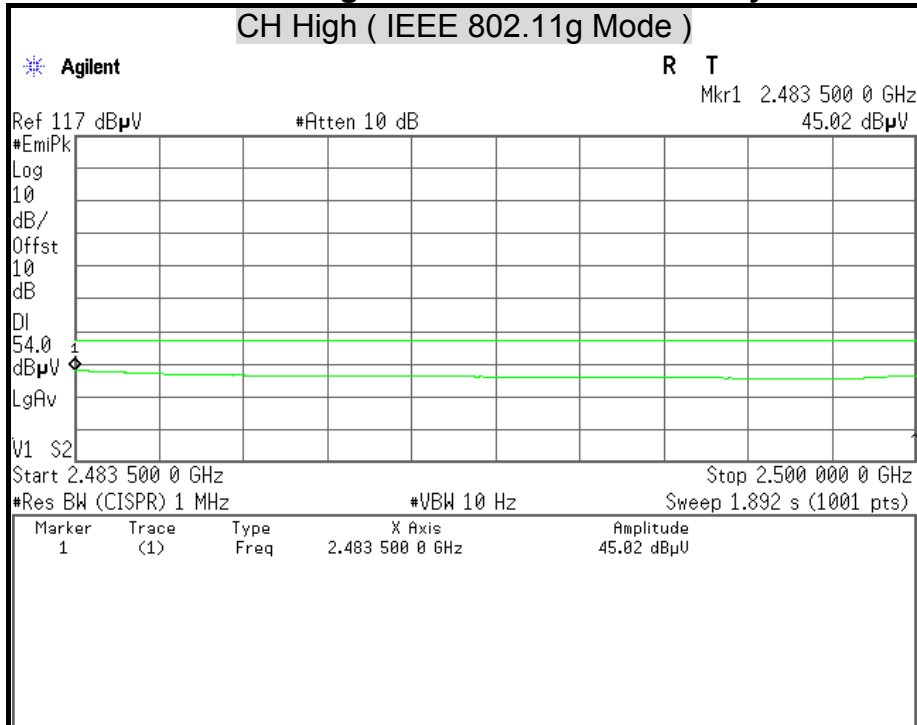



Detector Mode : Peak

Polarity : Horizontal

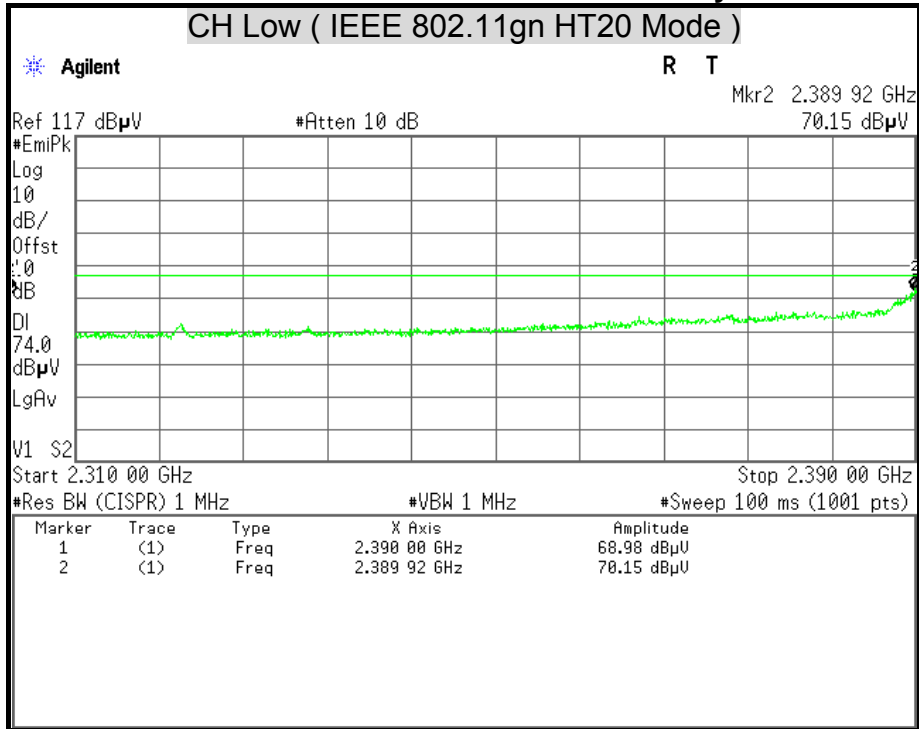

Detector Mode : Average

Polarity : Horizontal

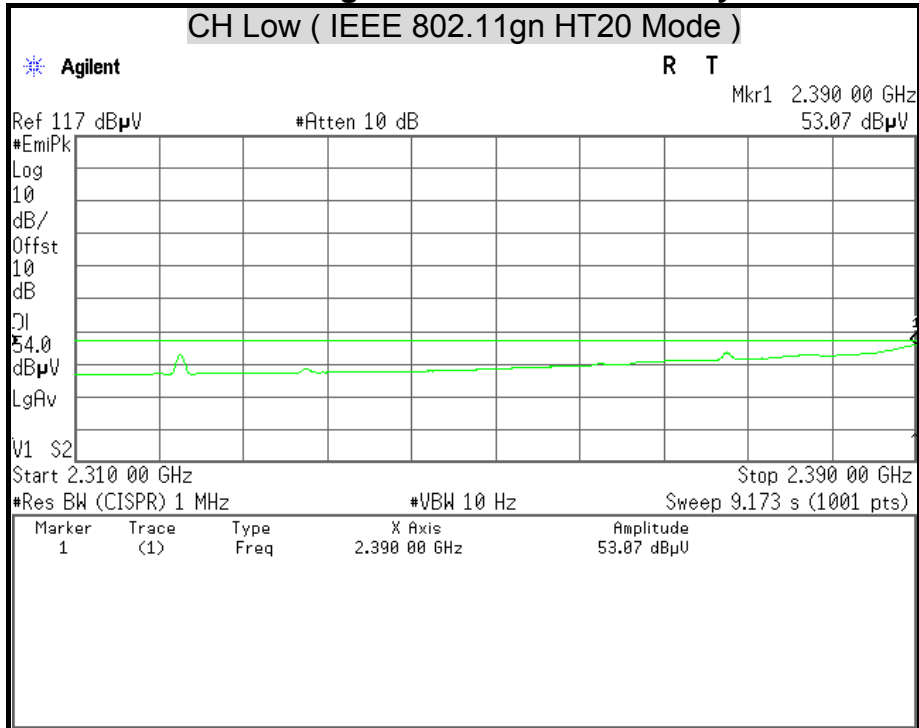



Detector Mode : Peak

Polarity : Vertical

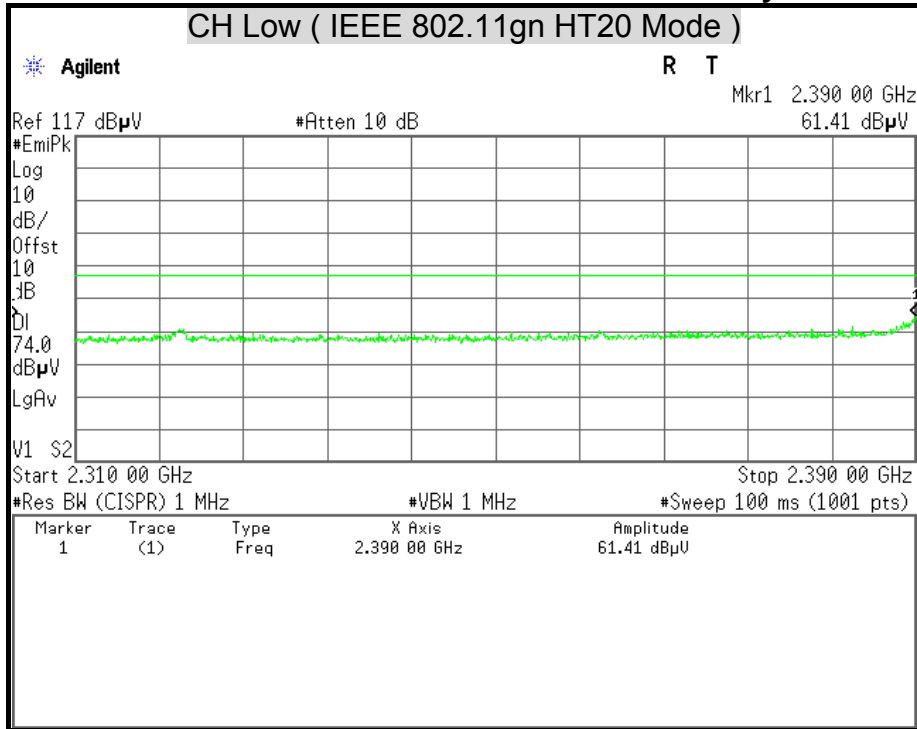

Detector Mode : Average

Polarity : Vertical

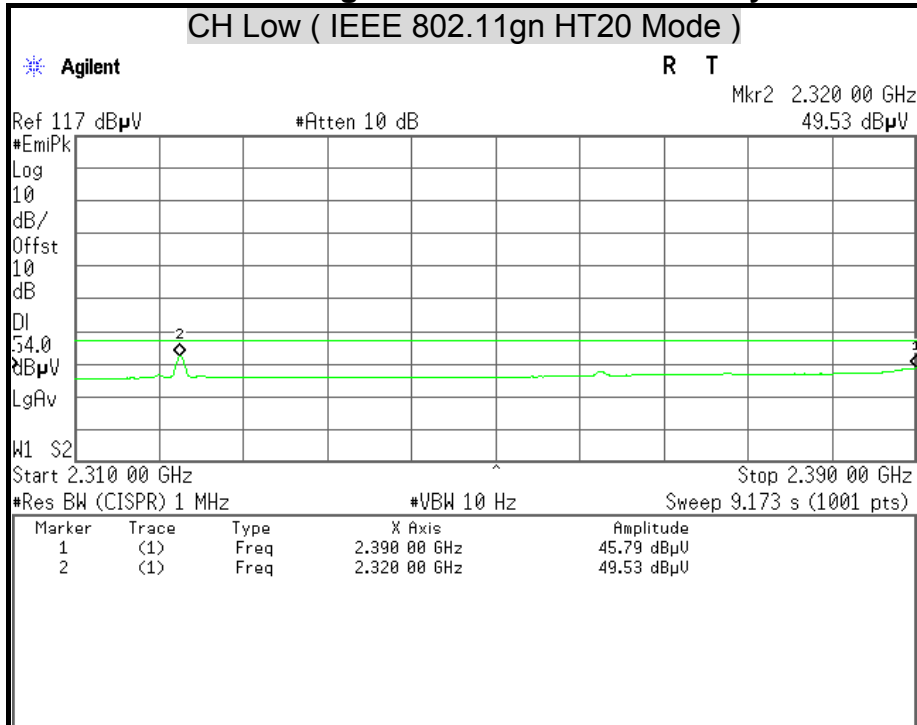



Detector Mode : Peak

Polarity : Horizontal

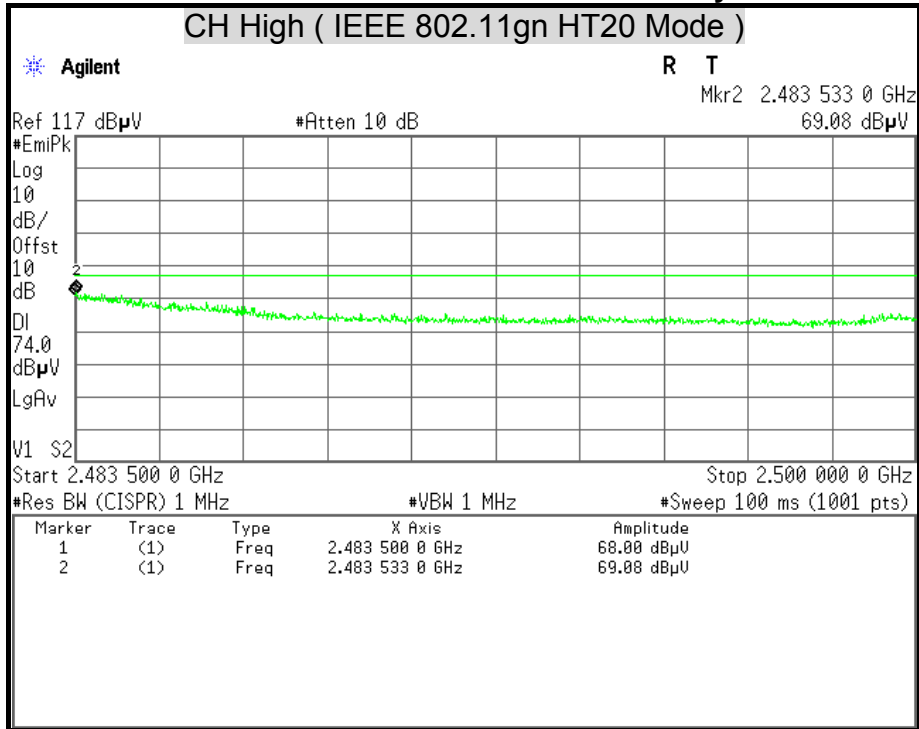

Detector Mode : Average

Polarity : Horizontal

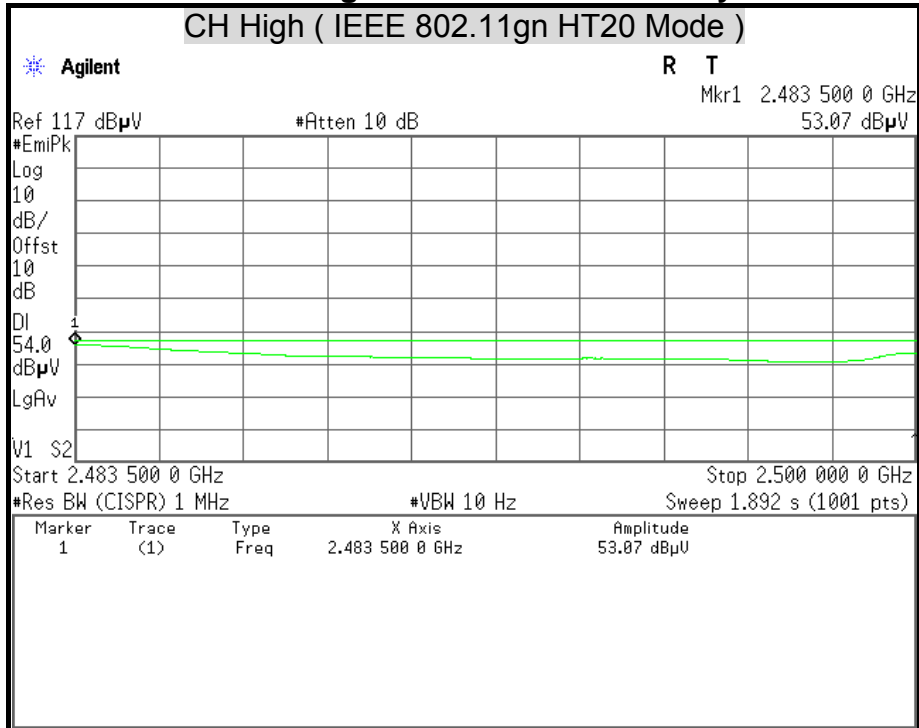



Detector Mode : Peak

Polarity : Vertical

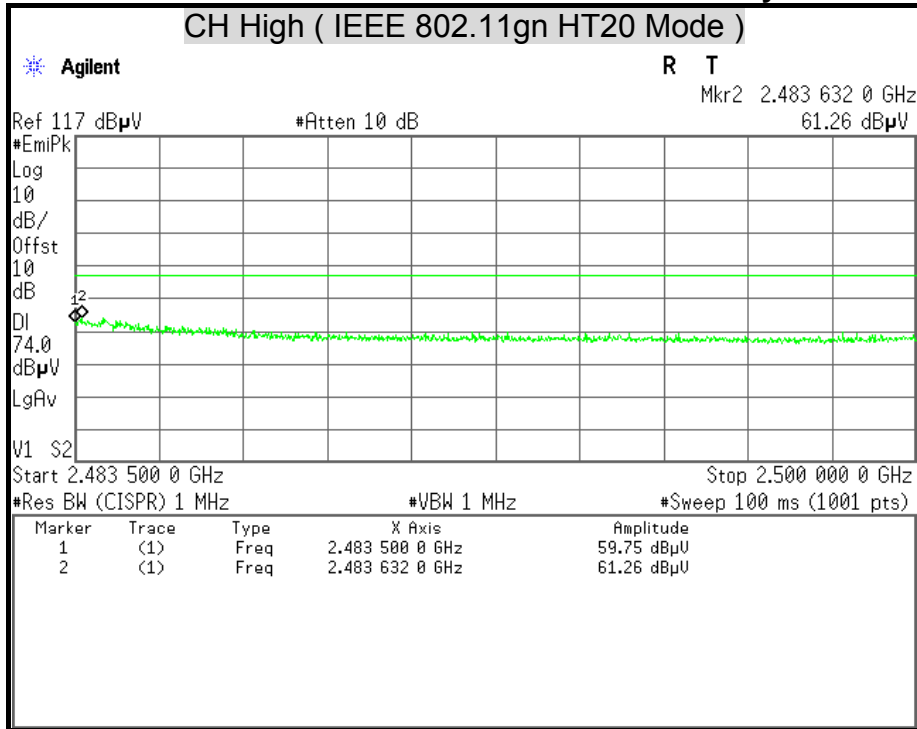

Detector Mode : Average

Polarity : Vertical

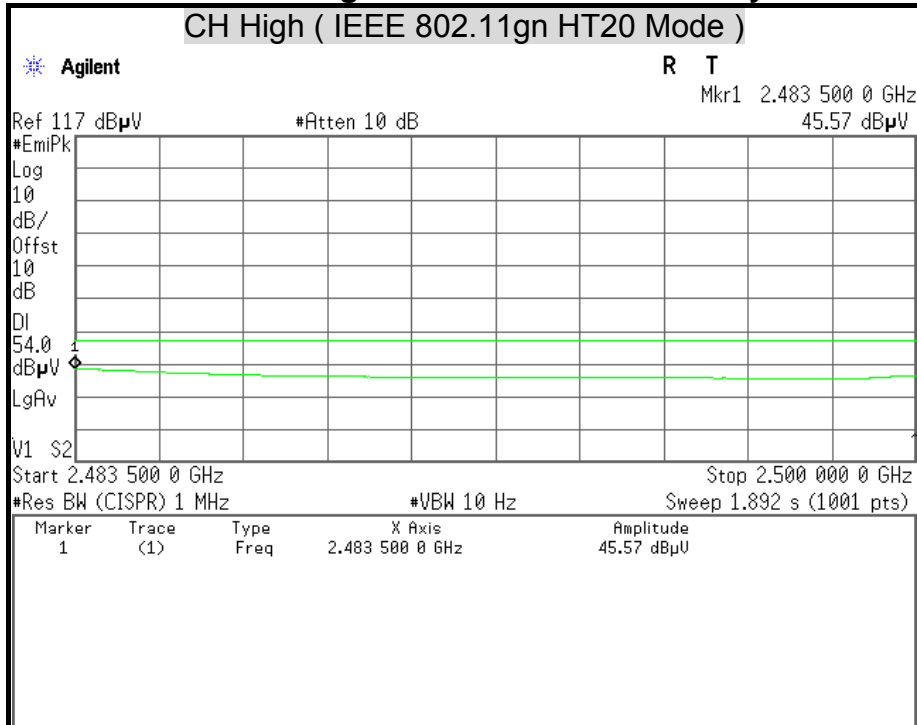



Detector Mode : Peak

Polarity : Horizontal

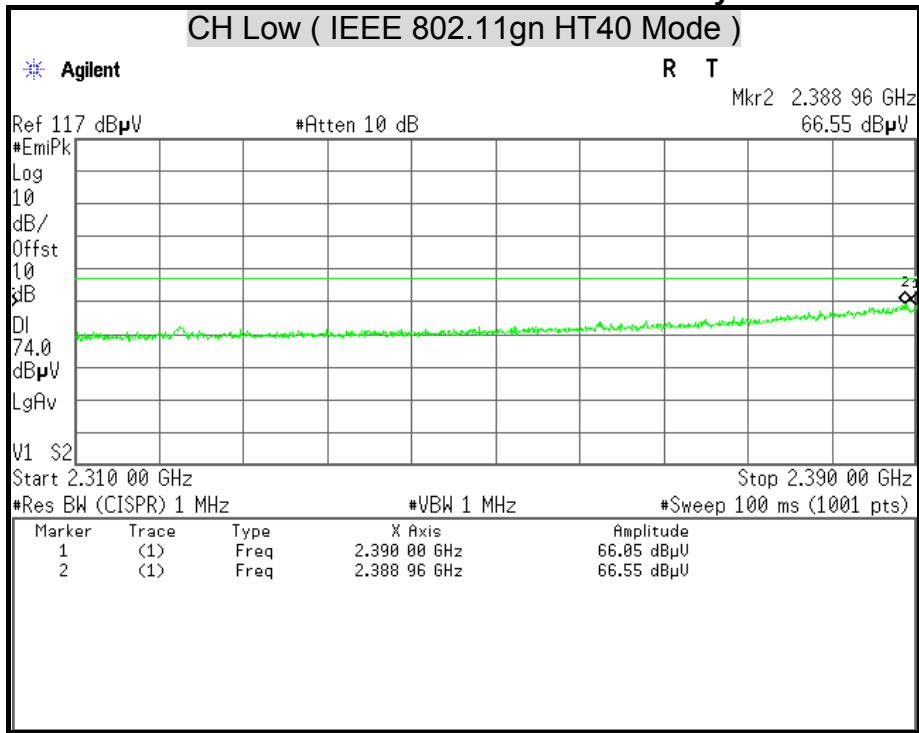

Detector Mode : Average

Polarity : Horizontal

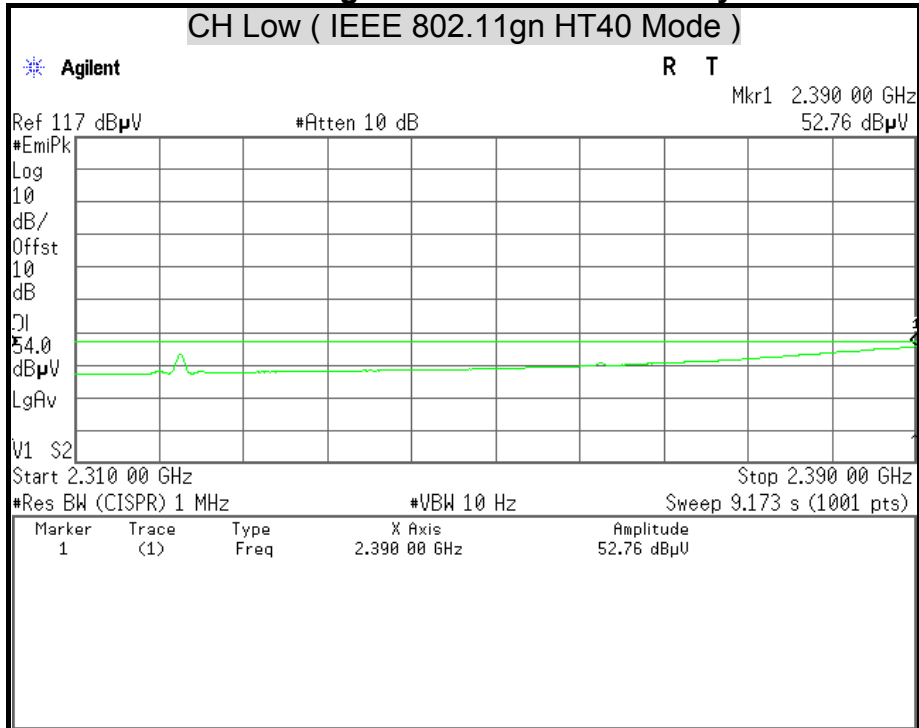



Detector Mode : Peak

Polarity : Vertical

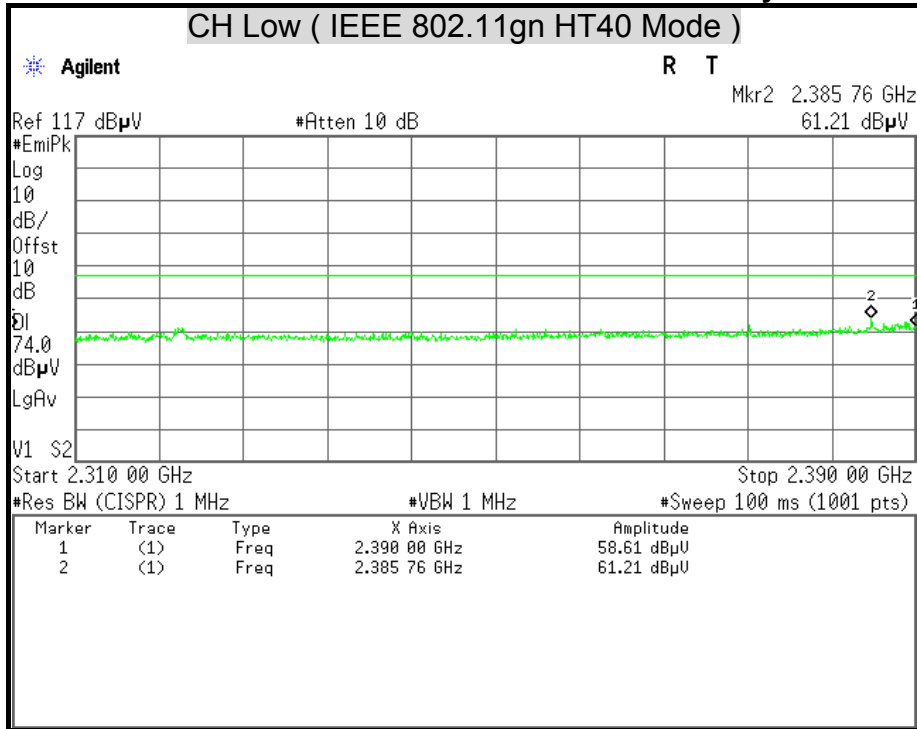

Detector Mode : Average

Polarity : Vertical

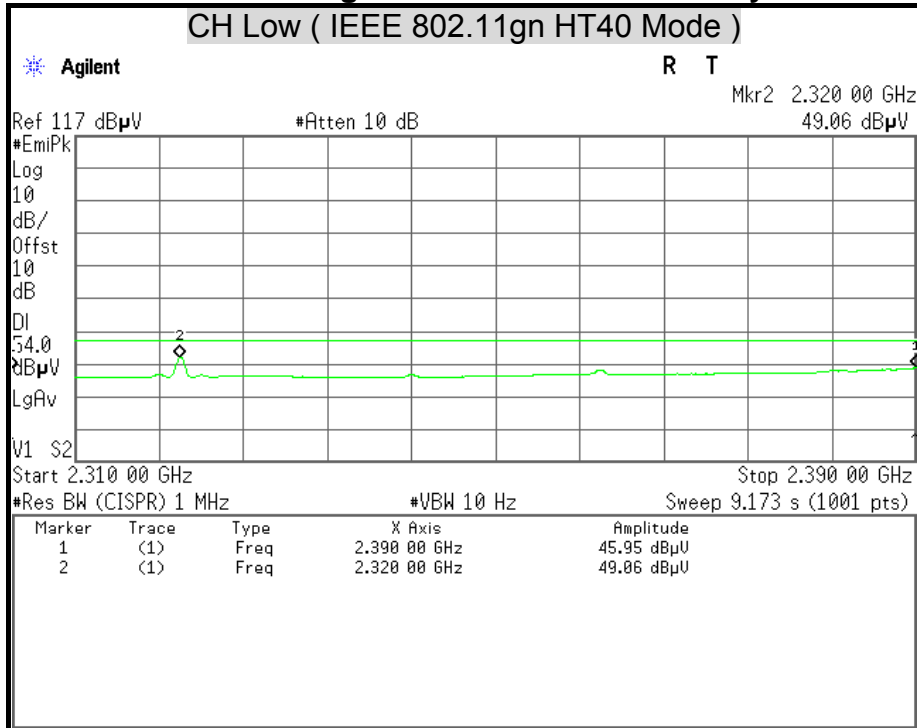





Detector Mode : Peak

Polarity : Horizontal

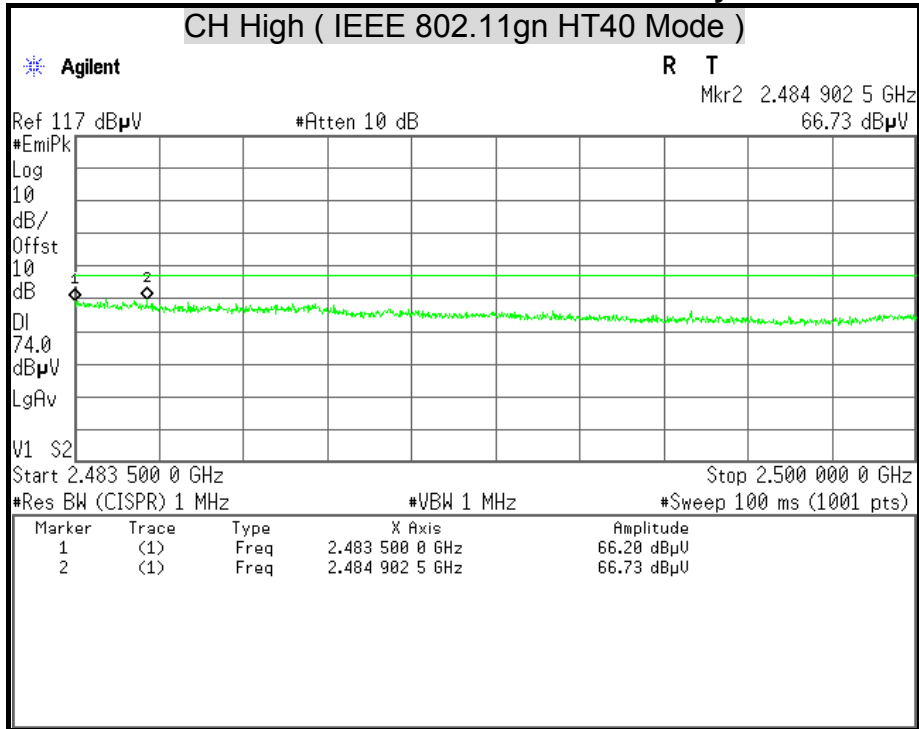

Detector Mode : Average

Polarity : Horizontal

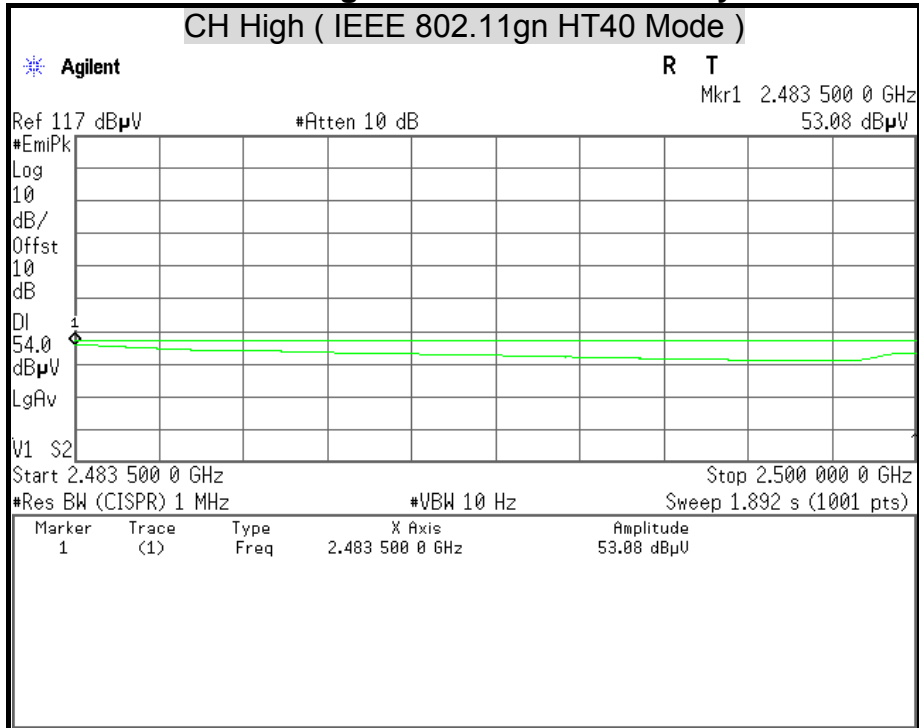



Detector Mode : Peak

Polarity : Vertical

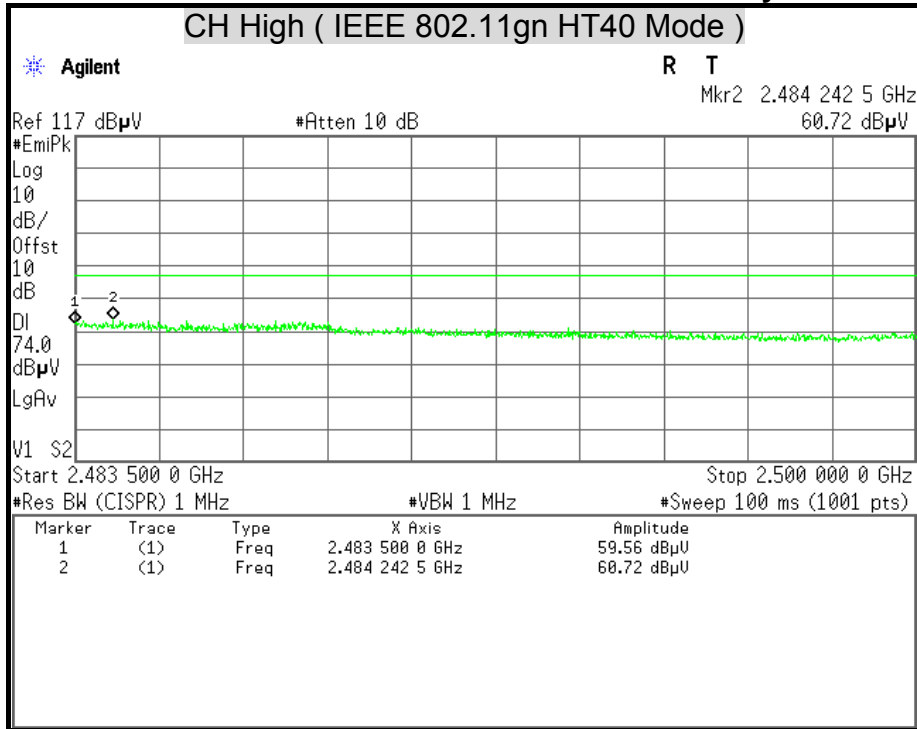

Detector Mode : Average

Polarity : Vertical

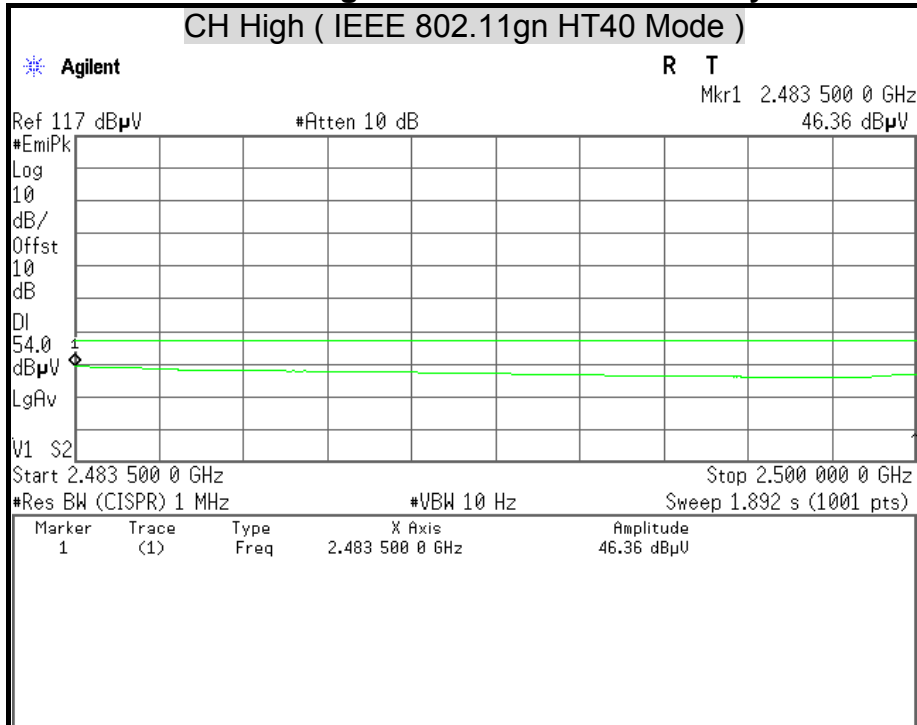



## 7.7 CONDUCTED EMISSION

### LIMITS

§ 15.207 (a) Except as shown in paragraph (b) and (c) this section, for an intentional radiator that is designed to be connected to the public utility (AC) power line, the radio frequency voltage that is conducted back onto the AC power line on any frequency or frequencies within the band 150 kHz to 30 MHz shall not exceed the limits in the following table, as measured using a 50 µH/50 ohms line impedance stabilization network (LISN). Compliance with the provisions of this paragraph shall be based on the measurement of the radio frequency voltage between each power line and ground at the power terminal. The lower limit applies at the boundary between the frequency ranges.

Frequency Range (MHz)	Conducted Limit (dBµv)	
	Quasi-peak	Average
0.15 - 0.50	66 to 56	56 to 46
0.50 - 5.00	56	46
5.00 - 30.0	60	50

### TEST EQUIPMENT

Name of Equipment	Manufacturer	Model	Serial Number	Calibration Due
L.I.S.N	SCHWARZBECK	NSLK 8127	8127465	08/06/2015
L.I.S.N	SCHWARZBECK	NSLK 8127	8127473	03/09/2016
EMI Receiver	ROHDE & SCHWARZ	ESHS 30	838550/003	11/02/2015
Pulse Limiter	ROHDE & SCHWARZ	ESH3-Z2	100111	06/30/2015

*Remark: Each piece of equipment is scheduled for calibration once a year.*



**TEST SETUP**

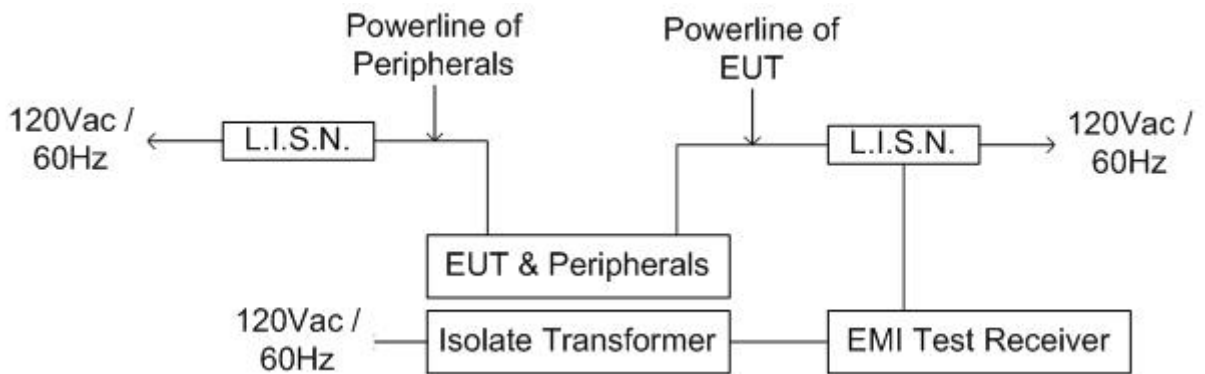
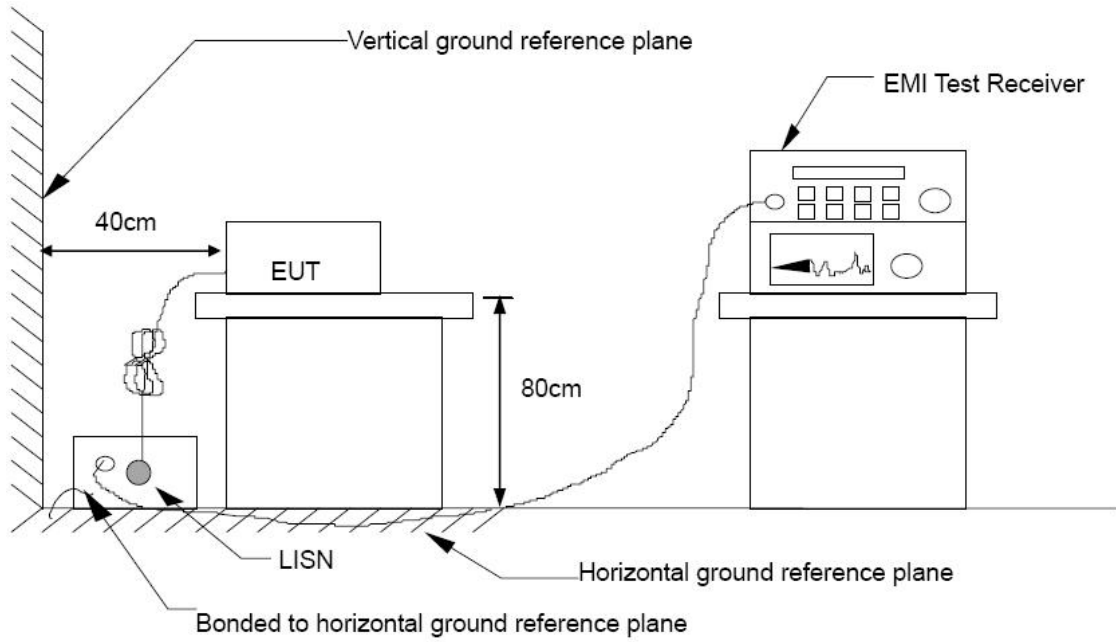



## **TEST PROCEDURE**

The basic test procedure was in accordance with ANSI C63.10:2009.

The test procedure is performed in a 4m × 3m × 2.4m (L×W×H) shielded room.

The EUT along with its peripherals were placed on a 1.0m (W) × 1.5m (L) and 0.8m in height wooden table and the EUT was adjusted to maintain a 0.4 meter space from a vertical reference plane.

The EUT was connected to power mains through a line impedance stabilization network (LISN) which provides 50 ohm coupling impedance for measuring instrument and the chassis ground was bounded to the horizontal ground plane of shielded room. All peripherals were connected to the second LISN and the chassis ground also bounded to the horizontal ground plane of shielded room.

The EUT was located so that the distance between the boundary of the EUT and the closest surface of the LISN is 0.8 m. Where a mains flexible cord was provided by the manufacturer shall be 1 m long, or if in excess of 1 m, the excess cable was folded back and forth as far as possible so as to form a bundle not exceeding 0.4 m in length.



TEST RESULTS

Product Name	300Mbps Wireless N High Power Ceiling-Mounted Access Point	Test By	Audi Chang
Test Model	WF2520	Test Date	2015/03/17
Test Mode	TX Mode	Temp. & Humidity	25.9°C, 59%

LINE

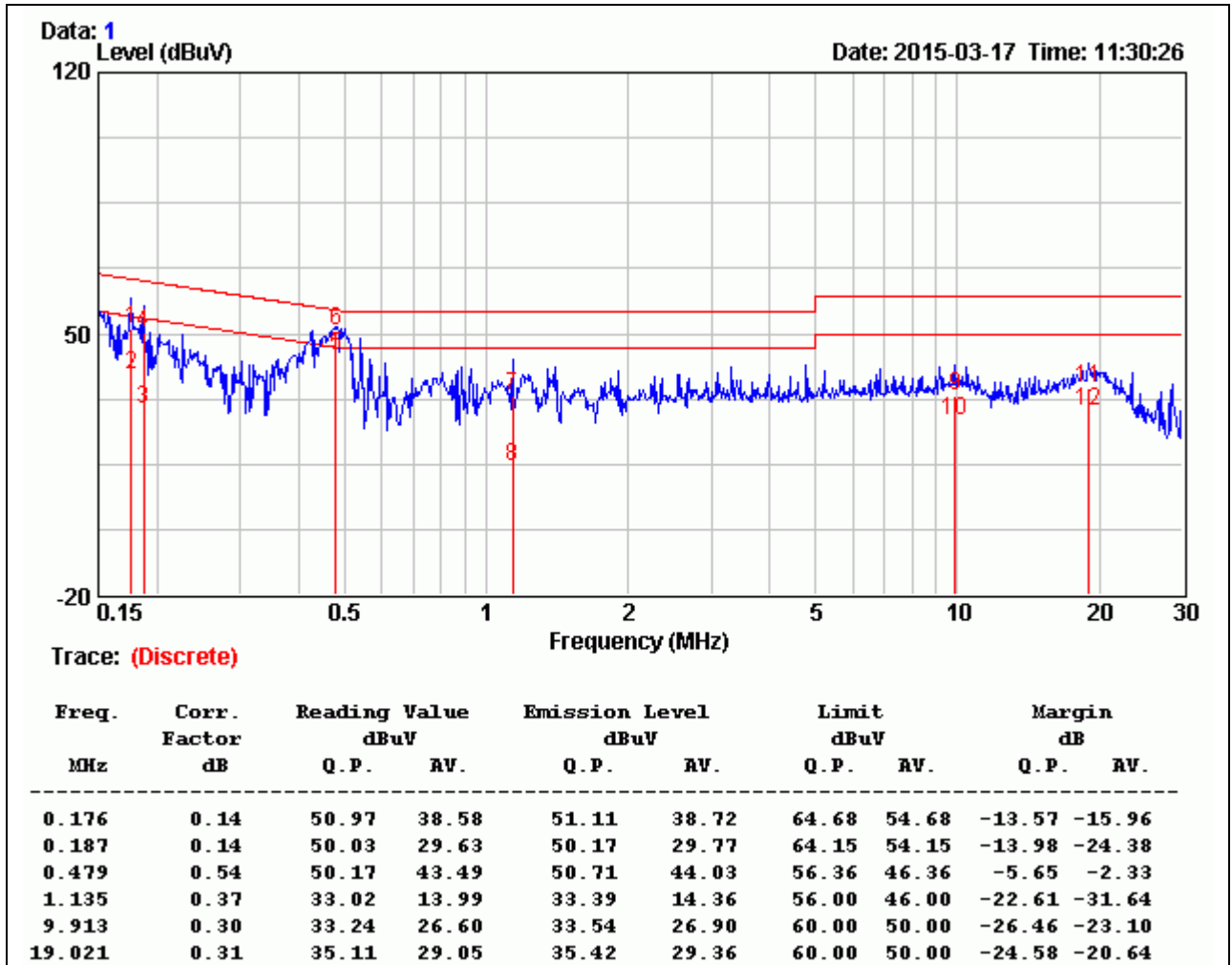

Remark:

1. Correction Factor = Insertion loss + Cable loss
2. Emission level = Reading Value + Correction factor
3. Margin value = Emission level – Limit value



<b>Product Name</b>	300Mbps Wireless N High Power Ceiling-Mounted Access Point	<b>Test By</b>	Audi Chang
<b>Test Model</b>	WF2520	<b>Test Date</b>	2015/03/17
<b>Test Mode</b>	TX Mode	<b>Temp. &amp; Humidity</b>	25.9°C, 59%

NEUTRAL

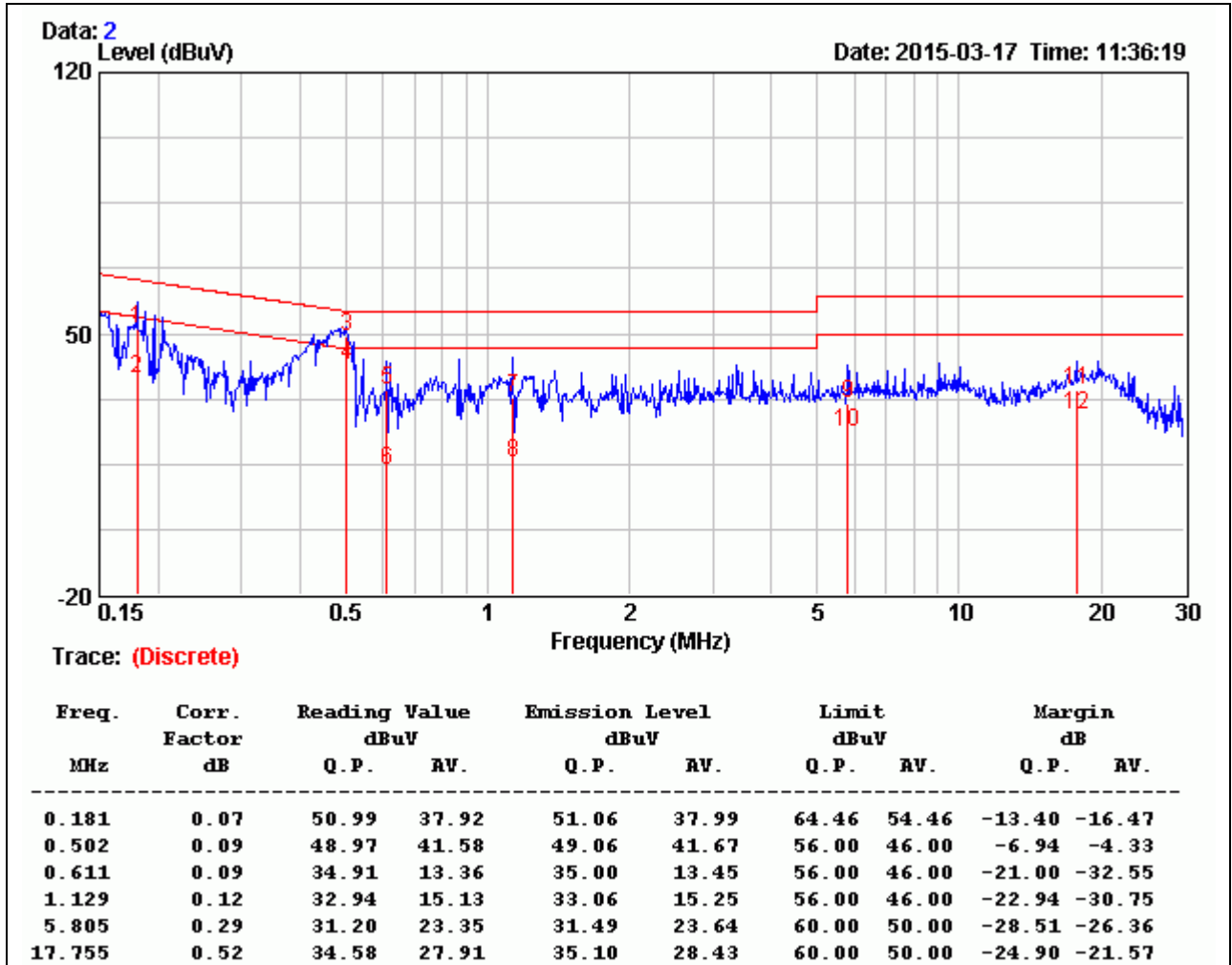

Remark:

1. Correction Factor = Insertion loss + Cable loss
2. Emission level = Reading Value + Correction factor
3. Margin value = Emission level – Limit value