



FCC Radio Test Report

FCC ID: T58WF2150RT

This report concerns (check one) : Original Grant Class I Change

Issued Date : Dec. 11, 2012
Project No. : 1211C144
Equipment : 300Mbps Wireless Dual Band USB Adapter
Model Name : WF2150
Applicant : NETIS SYSTEMS CO., LTD
Address : 9F,B Block, Tsinghua Information Park, High-tech Industrial Park, Nanshan, Shenzhen, China
Manufacturer : Shenzhen Netcore Industrial Ltd.
Address : 9F,B Block, Tsinghua Information Park, High-tech Industrial Park, Nanshan, Shenzhen, China

Tested by:

Neutron Engineering Inc. EMC Laboratory

Date of Receipt: Nov. 22, 2012

Date of Test:

Nov. 22, 2012 ~ Dec. 10, 2012

Testing Engineer :



(David Mao)

Technical Manager :

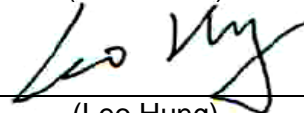

(Leo Hung)

Authorized Signatory :

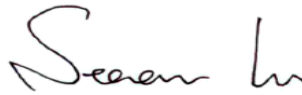

(Steven Lu)

Neutron Engineering Inc.

No.3, Jinshagang 1st Road, ShiXia, Dalang
Town, Dong Guan, China.

TEL : (0769) 8318-3000 FAX : (0769) 8319-6000



Declaration

Neutron represents to the client that testing is done in accordance with standard procedures as applicable and that test instruments used has been calibrated with the standards traceable to National Measurement Laboratory (NML) of R.O.C., or National Institute of Standards and Technology (NIST) of U.S.A.

Neutron's reports apply only to the specific samples tested under conditions. It is manufacture's responsibility to ensure that additional production units of this model are manufactured with the identical electrical and mechanical components. **Neutron** shall have no liability for any declarations, inferences or generalizations drawn by the client or others from **Neutron** issued reports.

Neutron's reports must not be used by the client to claim product endorsement by the authorities or any agency of the Government.

This report is the confidential property of the client. As a mutual protection to the clients, the public and **Neutron-self**, extracts from the test report shall not be reproduced except in full with **Neutron's** authorized written approval.

Neutron's laboratory quality assurance procedures are in compliance with the **ISO Guide 17025** requirements, and accredited by the conformity assessment authorities listed in this test report.

Limitation

For the use of the authority's logo is limited unless the Test Standard(s)/Scope(s)/Item(s) mentioned in this test report is (are) included in the conformity assessment authorities acceptance respective.



Table of Contents	Page
1 . CERTIFICATION	5
2 . SUMMARY OF TEST RESULTS	6
2.1 TEST FACILITY	7
2.2 MEASUREMENT UNCERTAINTY	7
3 . GENERAL INFORMATION	8
3.1 GENERAL DESCRIPTION OF EUT	8
3.2 DESCRIPTION OF TEST MODES	10
3.3 TABLE OF PARAMETERS OF TEXT SOFTWARE SETTING	11
3.4 BLOCK DIAGRAM SHOWING THE CONFIGURATION OF SYSTEM TESTED	12
3.5 DESCRIPTION OF SUPPORT UNITS	13
4 . EMC EMISSION TEST	14
4.1 CONDUCTED EMISSION MEASUREMENT	14
4.1.1 POWER LINE CONDUCTED EMISSION	14
4.1.2 MEASUREMENT INSTRUMENTS LIST	14
4.1.3 TEST PROCEDURE	15
4.1.4 DEVIATION FROM TEST STANDARD	15
4.1.5 TEST SETUP	15
4.1.6 EUT OPERATING CONDITIONS	15
4.1.7 TEST RESULTS	16
4.2 RADIATED EMISSION MEASUREMENT	19
4.2.1 RADIATED EMISSION LIMITS	19
4.2.2 MEASUREMENT INSTRUMENTS LIST	20
4.2.3 TEST PROCEDURE	20
4.2.4 DEVIATION FROM TEST STANDARD	20
4.2.5 TEST SETUP	21
4.2.6 EUT OPERATING CONDITIONS	21
4.2.7 TEST RESULTS-BETWEEN 30MHZ - 1000MHZ	22
4.2.8 TEST RESULTS - ABOVE 1000MHZ	25
5 . 26dB SPECTRUM BANDWIDTH	57
5.1 APPLIED PROCEDURES / LIMIT	57
5.1.1 MEASUREMENT INSTRUMENTS LIST	57
5.1.2 TEST PROCEDURE	57
5.1.3 DEVIATION FROM STANDARD	57
5.1.4 TEST SETUP	57
5.1.5 EUT OPERATION CONDITIONS	58
5.1.6 TEST RESULTS	59
6 . MAXIMUM CONDUCTED OUTPUT POWER	65



Table of Contents	Page
6.1 APPLIED PROCEDURES / LIMIT	65
6.1.1 MEASUREMENT INSTRUMENTS LIST	65
6.1.2 TEST PROCEDURE	65
6.1.3 DEVIATION FROM STANDARD	66
6.1.4 TEST SETUP	66
6.1.5 EUT OPERATION CONDITIONS	66
6.1.6 TEST RESULTS	67
7 . ANTENNA CONDUCTED SPURIOUS EMISSION	70
7.1 APPLIED PROCEDURES / LIMIT	70
7.1.1 MEASUREMENT INSTRUMENTS LIST	70
7.1.2 TEST PROCEDURE	70
7.1.3 DEVIATION FROM STANDARD	70
7.1.4 TEST SETUP	70
7.1.5 EUT OPERATION CONDITIONS	70
7.1.6 TEST RESULTS	71
8 . POWER SPECTRAL DENSITY TEST	94
8.1 APPLIED PROCEDURES / LIMIT	94
8.1.1 MEASUREMENT INSTRUMENTS LIST	94
8.1.2 TEST PROCEDURE	94
8.1.3 DEVIATION FROM STANDARD	94
8.1.4 TEST SETUP	94
8.1.5 EUT OPERATION CONDITIONS	94
9 . PEAK EXCURSION MEASUREMENT	104
9.1 APPLIED PROCEDURES / LIMIT	104
9.1.1 MEASUREMENT INSTRUMENTS LIST	104
9.1.2 TEST PROCEDURE	104
9.1.3 DEVIATION FROM STANDARD	104
9.1.4 TEST SETUP	105
9.1.5 EUT OPERATION CONDITIONS	105
9.1.6 TEST RESULTS	106
10 . FREQUENCY STABILITY MEASUREMENT	112
10.1 APPLIED PROCEDURES / LIMIT	112
10.1.1 MEASUREMENT INSTRUMENTS LIST	112
10.1.2 TEST PROCEDURE	112
10.1.3 DEVIATION FROM STANDARD	112
10.1.4 TEST SETUP	113
10.1.5 EUT OPERATION CONDITIONS	113
10.1.6 TEST RESULTS	114
11 . EUT TEST PHOTO	115



1. CERTIFICATION

Equipment : 300Mbps Wireless Dual Band USB Adapter
Brand Name : netis
Model Name : WF2150
Applicant : NETIS SYSTEMS CO., LTD
Factory : Dongguan City Netcore Network Technology Co.,Ltd.
Address : No.10-1,Sankeng Road,Qinghutou,Tangxia Town,Dongguan City
Date of Test : Nov. 22, 2012 ~ Dec. 10, 2012
Test Item : ENGINEERING SAMPLE
Standards : FCC Part15, Subpart E(15.407) / ANSI C63.4 : 2009

The above equipment has been tested and found compliance with the requirement of the relative standards by Neutron Engineering Inc. EMC Laboratory.

The test data, data evaluation, and equipment configuration contained in our test report (Ref No. NEI-FCCP-3-1211C144) were obtained utilizing the test procedures, test instruments, test sites that has been accredited by the Authority of NVLAP and TAF according to the ISO-17025 quality assessment standard and technical standard(s).

Test result included in this report is only for the 5150MHz~5250MHz Mode part of the product.



2. SUMMARY OF TEST RESULTS

Test procedures according to the technical standards:

FCC Part15, Subpart E			
Standard Section	Test Item	Judgment	Remark
15.207	AC Power Line Conducted Emissions	PASS	
15.407(a)	26dB Spectrum Bandwidth	PASS	
15.407(a)	Maximum Conducted Output Power	PASS	
15.407(a)	Power Spectral Density	PASS	
15.407(a)	Peak Excursion	PASS	
15.407(a)	Radiated Emissions	PASS	
15.407(b)	Band Edge Emissions	PASS	
15.407(b)	Frequency Stability	PASS	
15.407(g) 15.203	Antenna Requirements	PASS	

NOTE:

(1) " N/A" denotes test is not applicable in this test report.



2.1 TEST FACILITY

The test facilities used to collect the test data in this report is **DG-C02/DG-CB03** at the location of No.3,Jinshagang 1st Road, ShiXia, Dalang Town, Dong Guan, China.523792
 Neutron's test firm number for FCC 319330
 Neutron's test firm number for IC 4428B-1

2.2 MEASUREMENT UNCERTAINTY

The reported uncertainty of measurement $y \pm U$, where expanded uncertainty **U** is based on a standard uncertainty multiplied by a coverage factor of **k=2**, providing a level of confidence of approximately **95%**.

A. Conducted Measurement :

Test Site	Method	Measurement Frequency Range	U , (dB)	NOTE
DG-C02	CISPR	150 KHz ~ 30MHz	1.94	

B. Radiated Measurement :

Test Site	Method	Measurement Frequency Range	Ant. H / V	U,(dB)	NOTE
DG-CB03	CISPR	30MHz ~ 200MHz	V	3.82	
		30MHz ~ 200MHz	H	3.60	
		200MHz ~ 1,000MHz	V	3.86	
		200MHz ~ 1,000MHz	H	3.94	
		1GHz~18GHz	V	3.12	
		1GHz~18GHz	H	3.68	
		18GHz~40GHz	V	4.15	
		18GHz~40GHz	H	4.14	



3. GENERAL INFORMATION

3.1 GENERAL DESCRIPTION OF EUT

Equipment	300Mbps Wireless Dual Band USB Adapter	
Brand Name	netis	
Model Name	WF2150	
Model Difference	N/A	
Product Description	The EUT is a 300Mbps Wireless Dual Band USB Adapter.	
	Operation Frequency:	Band 1:5150MHz~5250MHz
	Modulation Type:	OFDM
	Bit Rate of Transmitter:	300Mbps
	Antenna Designation:	Please see note 3. (Page 9)
	Antenna Gain(Peak):	
	Output Power:	802.11a: 9.97 dBm 802.11n 20M: 9.93 dBm 802.11n 40M: 9.91 dBm
Based on the application, features, or specification exhibited in User's Manual, the EUT is considered as an ITE/Computing Device. More details of EUT technical specification, please refer to the User's Manual.		
Power Source	DC voltage supplied from Host System.	
Power Rating	I/P AC 120/60Hz O/P DC 5V	
Connecting I/O Port(s)	Please refer to the User's Manual	

Note:

1. For a more detailed features description, please refer to the manufacturer's specifications or the User's Manual.



2. Channel List:

802.11a / 802.11n 20M	
Band 1	
Channel	Frequency (MHz)
36	5180
40	5200
44	5220
48	5240

802.11n 40M	
Band 1	
Channel	Frequency (MHz)
38	5190
46	5230

3. Antenna Specification:

Table for Filed Antenna

Ant.	Brand	Model Name	Antenna Type	Connector	Gain (dBi)	Note
1	N/A	N/A	Printed	U.FL	0	2.4G/5G
2	N/A	N/A	Printed	U.FL	0	2.4G/5G

Note: This EUT supports MIMO 2T2R, all transmit signals are completely uncorrelated, then, **Direction gain = G_{ANT}** , that is Directional gain=4.58.

Operating Mode TX Mode	1TX	2TX
	802.11a	V (ANT1 or ANT2)
802.11n(20MHz)	-	V (ANT1 & ANT2)
802.11n(40MHz)	-	V (ANT1 & ANT2)



3.2 DESCRIPTION OF TEST MODES

To investigate the maximum EMI emission characteristics generates from EUT, the test system was pre-scanning tested base on the consideration of following EUT operation mode or test configuration mode which possible have effect on EMI emission level. Each of these EUT operation mode(s) or test configuration mode(s) mentioned above was evaluated respectively.

Pretest Test Mode	Description
Mode 1	TX A Mode / CH36, CH40, CH48(Band 1)
Mode 2	TX N20 Mode / CH36, CH40, CH48(Band 1)
Mode 3	TX N40 Mode / CH38, CH46 (Band 1)
Mode 4	Normal Link

The EUT system operated these modes were found to be the worst case during the pre-scanning test as following:

For Conducted Test	
Final Test Mode	Description
Mode 4	Normal Link

For Radiated Test	
Final Test Mode	Description
Mode 1	TX A Mode / CH36, CH40, CH48(Band 1)
Mode 2	TX N20 Mode / CH36, CH40, CH48(Band 1)
Mode 3	TX N40 Mode / CH38, CH46 (Band 1)



3.3 TABLE OF PARAMETERS OF TEXT SOFTWARE SETTING

During testing channel & power controlling software provided by the customer was used to control the operating channel as well as the output power level. The RF output power selection is for the setting of RF output power expected by the customer and is going to be fixed on the firmware of the final end product

Test software version	RT5x7xQA		
Frequency	5180 MHz	5200MHz	5240 MHz
A Mode	16	17	18
N20 Mode	13	14	15

Test software version	RT5x7xQA		
Frequency	5190 MHz	5230MHz	
N40 Mode	14	16	

3.4 BLOCK DIAGRAM SHOWING THE CONFIGURATION OF SYSTEM TESTED

Conducted Mode:

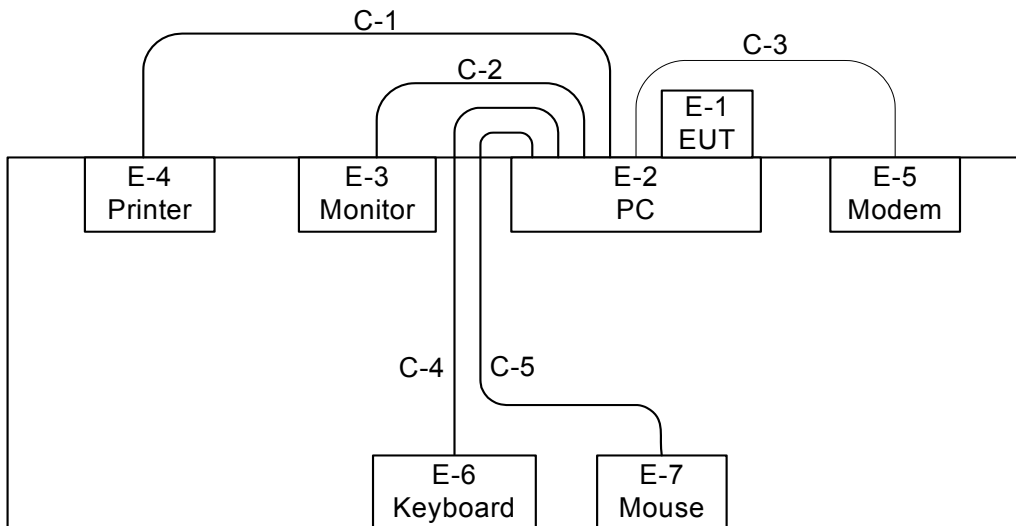

- C-1: Parallel Cable
- C-2: D-Sub Cable
- C-3: RS232 Cable
- C-4: USB Cable
- C-5: USB Cable

Radiated TX Mode:

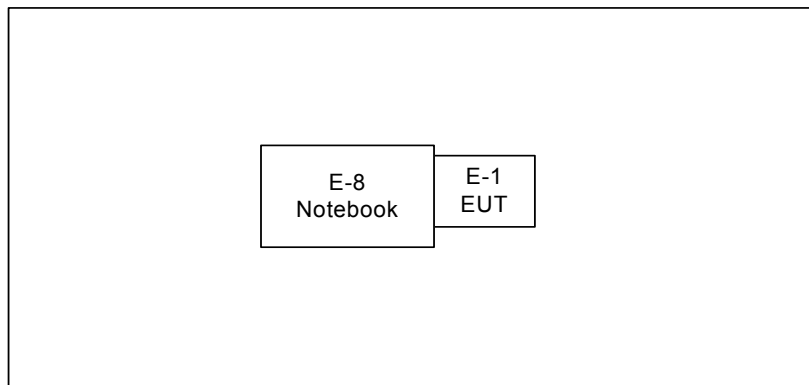



3.5 DESCRIPTION OF SUPPORT UNITS

The EUT has been tested as an independent unit together with other necessary accessories or support units. The following support units or accessories were used to form a representative test configuration during the tests.

Item	Equipment	Mfr/Brand	Model/Type No.	FCC ID	Series No.	Note
E-1	300Mbps Wireless Dual Band USB Adapter	netis	WF2150	T58WF2150RT	N/A	EUT
E-2	PC	Dell 745	DCSM	DOC	G7K832X	
E-3	LCD monitor	Dell	E177FPc	DOC	CNOFJ179-64180-6AG-1WNS	
E-4	Printer	SII	DPU-414	DOC	3018507 B	
E-5	Modem	ACEEX	DM-1414V	IFAXDM1414	0603002131	
E-6	USB Keyboard	Dell	L100	DOC	CNORH6596589 071T08NE	
E-7	USB Mouse	Dell	MO56UOA	DOC	G01003HO	
E-8	Notebook	HP	HSTNN-169A-3	DOC	RCPBRBC09-021 2	

Item	Shielded Type	Ferrite Core	Length	Note
C-1	YES	NO	1.5m	
C-2	YES	YES	1.5m	
C-3	YES	NO	1.5m	
C-4	YES	NO	1.9m	
C-5	YES	NO	1.6m	

Note:

- (1) The support equipment was authorized by Declaration of Confirmation.
- (2) For detachable type I/O cable should be specified the length in m in 『Length』 column.



4. EMC EMISSION TEST

4.1 CONDUCTED EMISSION MEASUREMENT

4.1.1 POWER LINE CONDUCTED EMISSION (Frequency Range 150KHz-30MHz)

FREQUENCY (MHz)	Class A (dBuV)		Class B (dBuV)	
	Quasi-peak	Average	Quasi-peak	Average
0.15 -0.5	79.00	66.00	66 - 56 *	56 - 46 *
0.50 -5.0	73.00	60.00	56.00	46.00
5.0 -30.0	73.00	60.00	60.00	50.00

Note:

- (1) The tighter limit applies at the band edges.
- (2) The limit of " * " marked band means the limitation decreases linearly with the logarithm of the frequency in the range.

4.1.2 MEASUREMENT INSTRUMENTS LIST

Item	Kind of Equipment	Manufacturer	Type No.	Serial No.	Last Calibration	Next Calibration
1	LISN	EMCO	3816/2	00052765	May.26.2012	May.04.2013
2	LISN	R&S	ENV216	100087	May.26.2012	May.04.2013
3	Test Cable	N/A	C_17	N/A	Mar.18.2012	Mar.28.2013
4	EMI TEST RECEIVER	R&S	ESCS30	826547/02 2	May.26.2012	May.04.2013
5	50Ω Terminator	SHX	TF2-3G-A	08122902	May.26.2012	May.04.2013

Remark: "N/A" denotes no model name, serial no. or calibration specified.
All calibration period of Equipment List is One Year.

4.1.3 TEST PROCEDURE

- a. The EUT was placed 0.8 meters from the horizontal ground plane with EUT being connected to the power mains through a line impedance stabilization network (LISN). All other support equipments powered from additional LISN(s). The LISN provide 50 Ohm/ 50uH of coupling impedance for the measuring instrument.
- b. Interconnecting cables that hang closer than 40 cm to the ground plane shall be folded back and forth in the center forming a bundle 30 to 40 cm long.
- c. I/O cables that are not connected to a peripheral shall be bundled in the center. The end of the cable may be terminated, if required, using the correct terminating impedance. The overall length shall not exceed 1 m.
- d. LISN at least 80 cm from nearest part of EUT chassis.
- e. For the actual test configuration, please refer to the related Item –EUT Test Photos.

4.1.4 DEVIATION FROM TEST STANDARD

No deviation

4.1.5 TEST SETUP

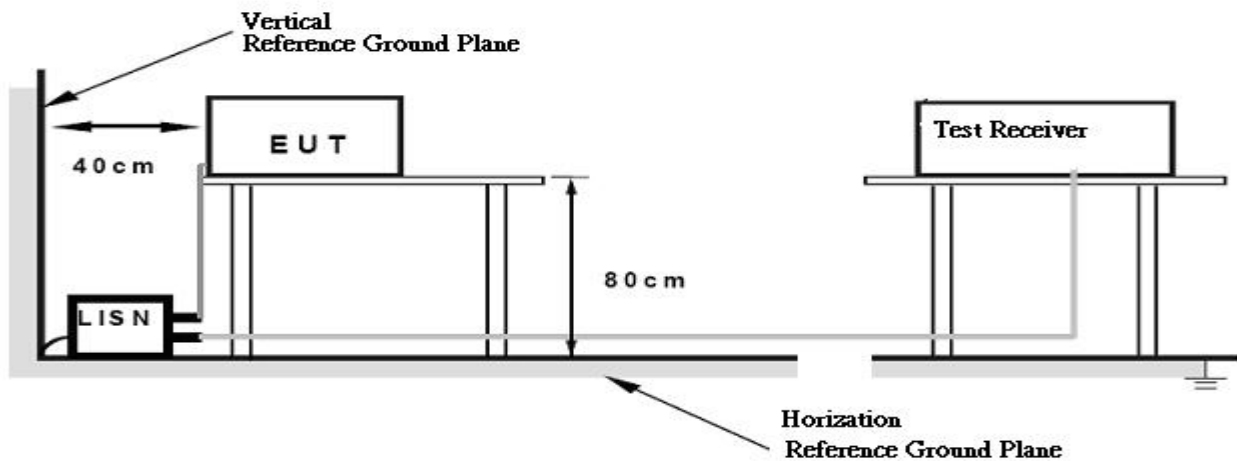

4.1.6 EUT OPERATING CONDITIONS

The EUT was configured for testing in a typical fashion (as a customer would normally use it). The EUT has been programmed to continuously transmit during test. This operating condition was tested and used to collect the included data.

The EUT was programmed to be in continuously transmitting/Normal Link mode.



4.1.7 TEST RESULTS

Remark

- (1) All readings are QP Mode value unless otherwise stated AVG in column of 'Note'. If the QP Mode Measured value compliance with the QP Limits and lower than AVG Limits, the EUT shall be deemed to meet both QP & AVG Limits and then only QP Mode was measured, but AVG Mode didn't perform. In this case, a " * " marked in AVG Mode column of Interference Voltage Measured.
- (2) Measuring frequency range from 150KHz to 30MHz.



EUT :	300Mbps Wireless Dual Band USB Adapter	Model Name :	WF2150
Temperature :	25 °C	Relative Humidity :	53 %
Pressure :	1010hPa	Test Power :	AC 120V/60Hz
Test Mode :	Normal Link	Phase:	Line

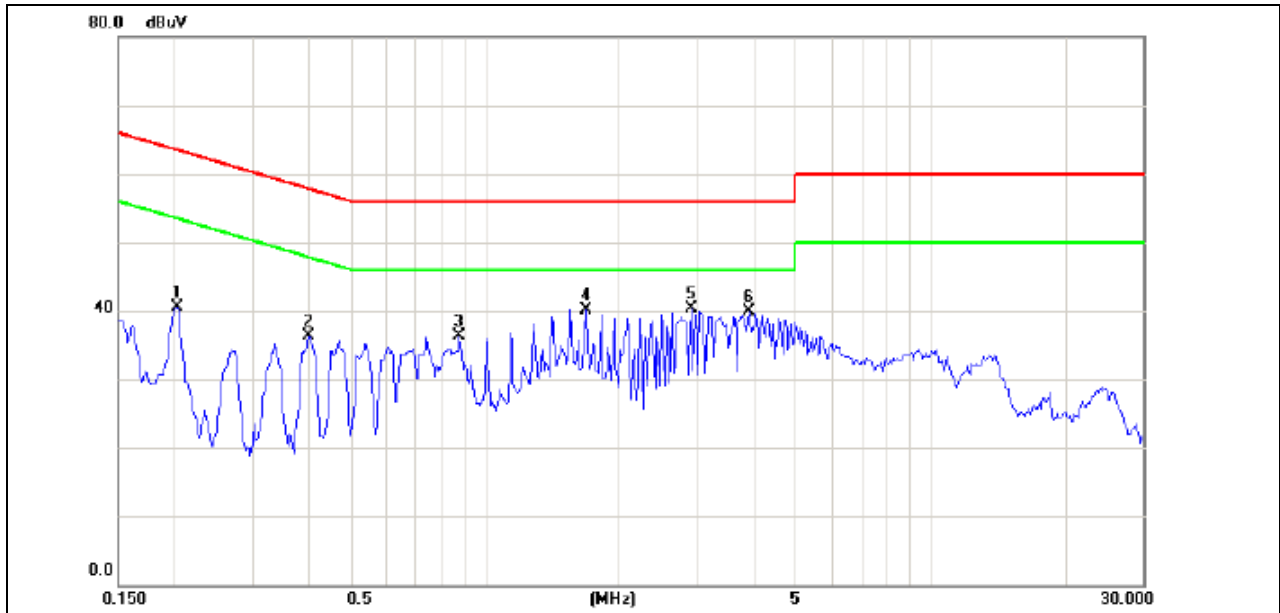

No. Mk.	Freq. MHz	Reading Level dBuV	Correct Factor dB	Measurement dBuV	Limit dBuV	Over dB	Detector	Comment
1	0.2046	30.70	9.85	40.55	63.42	-22.87	peak	
2	0.4040	26.56	9.84	36.40	57.77	-21.37	peak	
3	0.8762	26.52	9.83	36.35	56.00	-19.65	peak	
4	1.6851	30.26	9.86	40.12	56.00	-15.88	peak	
5 *	2.9000	30.38	9.89	40.27	56.00	-15.73	peak	
6	3.9100	30.02	9.92	39.94	56.00	-16.06	peak	



EUT :	300Mbps Wireless Dual Band USB Adapter	Model Name :	WF2150
Temperature :	25 °C	Relative Humidity :	53 %
Pressure :	1010hPa	Test Power :	AC 120V/60Hz
Test Mode :	Normal Link	Phase:	Neutral

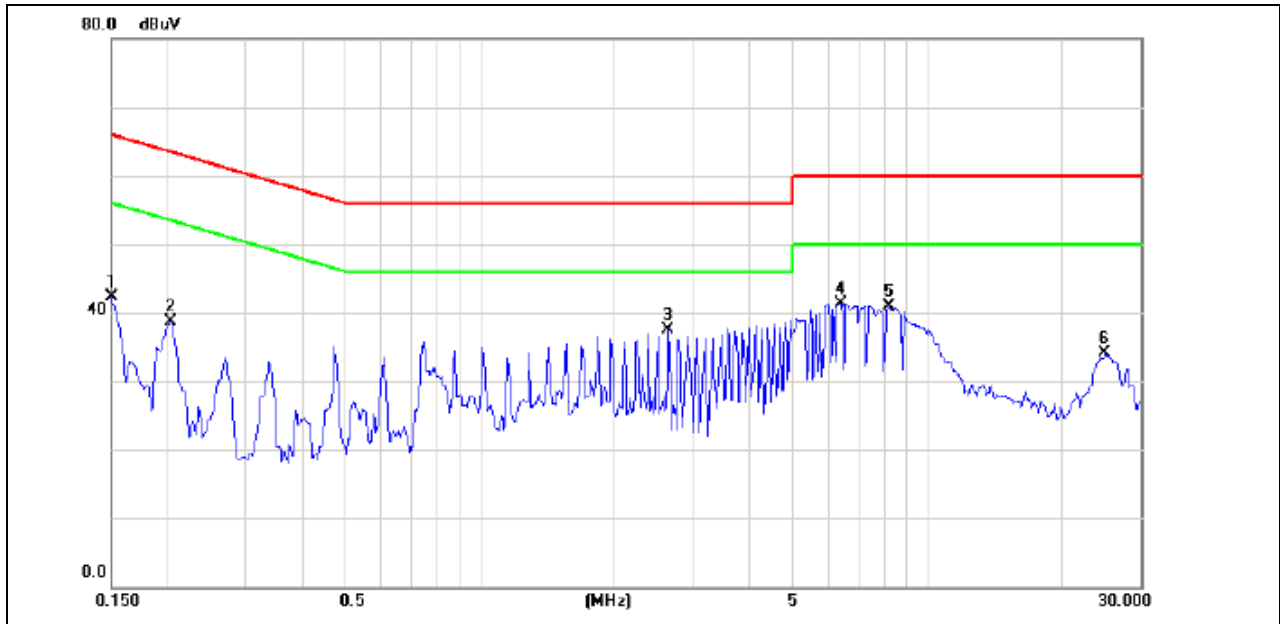

No.	Mk.	Freq. MHz	Reading Level dBuV	Correct Factor dB	Measure- ment dBuV	Limit dBuV	Over dB	Detector	Comment
1		0.1500	32.44	9.86	42.30	66.00	-23.70	peak	
2		0.2046	28.80	9.85	38.65	63.42	-24.77	peak	
3	*	2.6421	27.58	9.93	37.51	56.00	-18.49	peak	
4		6.4413	31.38	10.02	41.40	60.00	-18.60	peak	
5		8.2030	30.78	10.08	40.86	60.00	-19.14	peak	
6		25.0153	23.60	10.42	34.02	60.00	-25.98	peak	



4.2 RADIATED EMISSION MEASUREMENT

4.2.1 RADIATED EMISSION LIMITS (Frequency Range 9kHz-1000MHz)

20dBc in any 100 kHz bandwidth outside the operating frequency band. In case the emission fall within the restricted band specified on 15.205(a), then the 15.209(a) limit in the table below has to be followed.

Frequencies (MHz)	Field Strength (micorvolts/meter)	Measurement Distance (meters)
0.009~0.490	2400/F(KHz)	300
0.490~1.705	24000/F(KHz)	30
1.705~30.0	30	30
30~88	100	3
88~216	150	3
216~960	200	3
Above 960	500	3

LIMITS OF RADIATED EMISSION MEASUREMENT (Above 1000MHz)

FREQUENCY (MHz)	(dBuV/m) (at 1.5m)	
	PEAK	AVERAGE
Above 1000	80	60

Notes:

- (1) The limit for radiated test was performed according to FCC PART 15C.
- (2) The tighter limit applies at the band edges.
- (3) Emission level (dBuV/m)=20log Emission level (uV/m).
 The limits above 5GHz shall be extrapolated to the specified distance using an extrapolation factor of 20dB/decade form 3m to 1.5m
 Distance extrapolation factor = 20 log (3m/1.5m) dB ;
 Limit line = specific limits (dBuV) + 6 dB



4.2.2 MEASUREMENT INSTRUMENTS LIST

Item	Kind of Equipment	Manufacturer	Type No.	Serial No.	Last Calibration	Next Calibration
1	Antenna	Schwarbeck	VULB9160	9160-3232	Jun .04.2012	May.25.2013
2	Amplifier	HP	8447D	2944A09673	May.26.2012	May.04.2013
3	Test Receiver	R&S	ESCI	100382	May.26.2012	May.04.2013
4	Test Cable	N/A	C-01_CB03	N/A	Jul.01.2012	Jul.01.2013
5	Antenna	ETS	3115	00075789	May.26.2012	May.25.2013
6	Amplifier	Agilent	8449B	3008A02274	May.26.2012	May.04.2013
7	Spectrum	Agilent	E4408B	US39240143	Nov.25.2012	Nov.16.2013
8	Test Cable	HUBER+SUHNER	C-45	N/A	May.04.2012	May.02.2013
9	Controller	CT	SC100	N/A	N/A	N/A
10	Active Loop Antenna	R&S	HFH2-Z2	830749/020	May.26.2012	May.04.2013
11	Broad-Band Horn Antenna	Schwarzbeck	BBHA 9170	9170319	Oct.13.2012	Oct.13.2013
12	Horn Antenna	EMCO	3115	9605-4803	May.26.2012	May.25.2013

Remark: "N/A" denotes no model name, serial no. or calibration specified.

All calibration period of Equipment List is One Year.

4.2.3 TEST PROCEDURE

- a. The measuring distance of at 1.5 m shall be used for measurements at frequency up to 1GHz. For frequencies above 1GHz, any suitable measuring distance may be used.
- b. The EUT was placed on the top of a rotating table 0.8 meters above the ground at a 3 meter semi-anechoic chamber. The table was rotated 360 degrees to determine the position of the highest radiation.
- c. The height of the equipment or of the substitution antenna shall be 0.8 m; the height of the test antenna shall vary between 1 m to 4 m. Both horizontal and vertical polarizations of the antenna are set to make the measurement.
- d. The initial step in collecting conducted emission data is a spectrum analyzer peak detector mode pre-scanning the measurement frequency range. Significant peaks are then marked and then Quasi Peak detector mode re-measured.
- e. If the Peak Mode measured value compliance with and lower than Quasi Peak Mode Limit, the EUT shall be deemed to meet QP Limits and then no additional QP Mode measurement performed.
- f. For the actual test configuration, please refer to the related Item –EUT Test Photos.

4.2.4 DEVIATION FROM TEST STANDARD

No deviation

4.2.5 TEST SETUP

Radiated Emission Test Set-Up Frequency 30 - 1000MHz

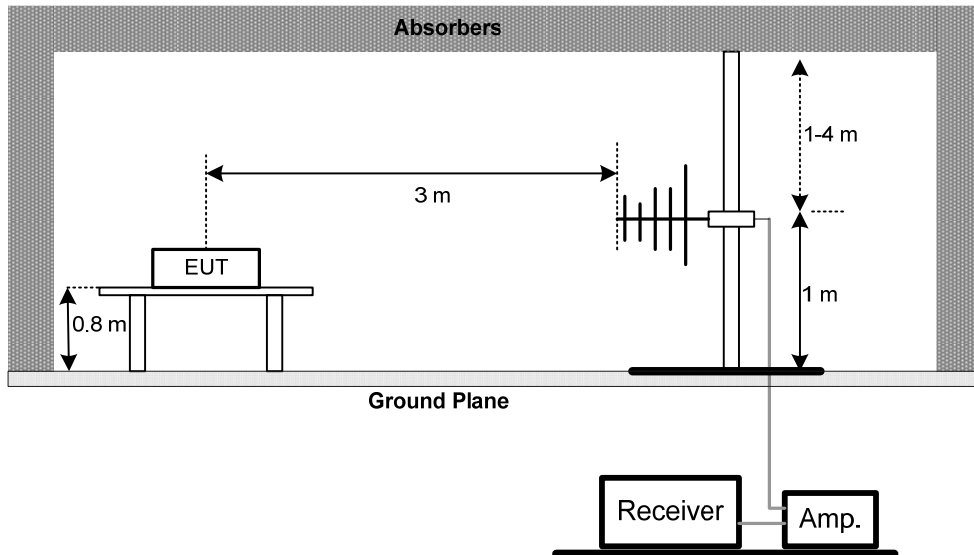

Radiated Emission Test Set-Up Frequency Above 1 GHz

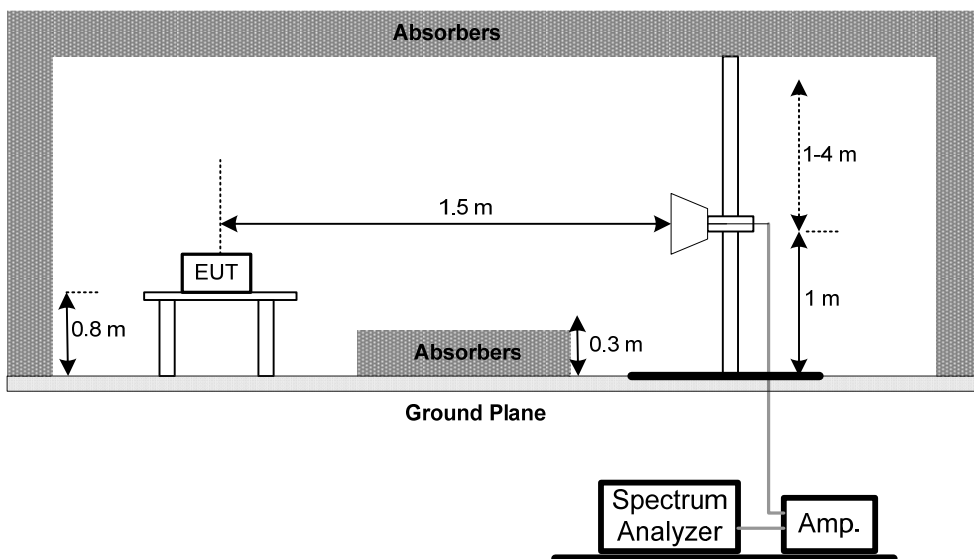

4.2.6 EUT OPERATING CONDITIONS

The EUT tested system was configured as the statements of 4.1.6 Unless otherwise a special operating condition is specified in the follows during the testing.



4.2.7 TEST RESULTS-BETWEEN 30MHZ - 1000MHZ

Remark :

- (1) Reading in which marked as QP or Peak means measurements by using are Quasi-Peak Mode or Peak Mode with Detector BW=120KHz ; SPA setting in RBW=120KHz, VBW =120KHz, Swp. Time = 0.3 sec./MHz.
- (2) All readings are Peak unless otherwise stated QP in column of 『Note』 . Peak denotes that the Peak reading compliance with the QP Limits and then QP Mode measurement didn't perform.
- (3) Measuring frequency range from 30MHz to 1000MHz.
- (4) If the peak scan value lower limit more than 20dB, then this signal data does not show in table.



EUT :	300Mbps Wireless Dual Band USB Adapter	Model Name :	WF2150
Temperature :	25°C	Relative Humidity :	58 %
Pressure :	1010 hPa	Test Voltage :	AC 120V/60Hz
Test Mode :	TX A Mode 5180MHz	Phase:	Vertical

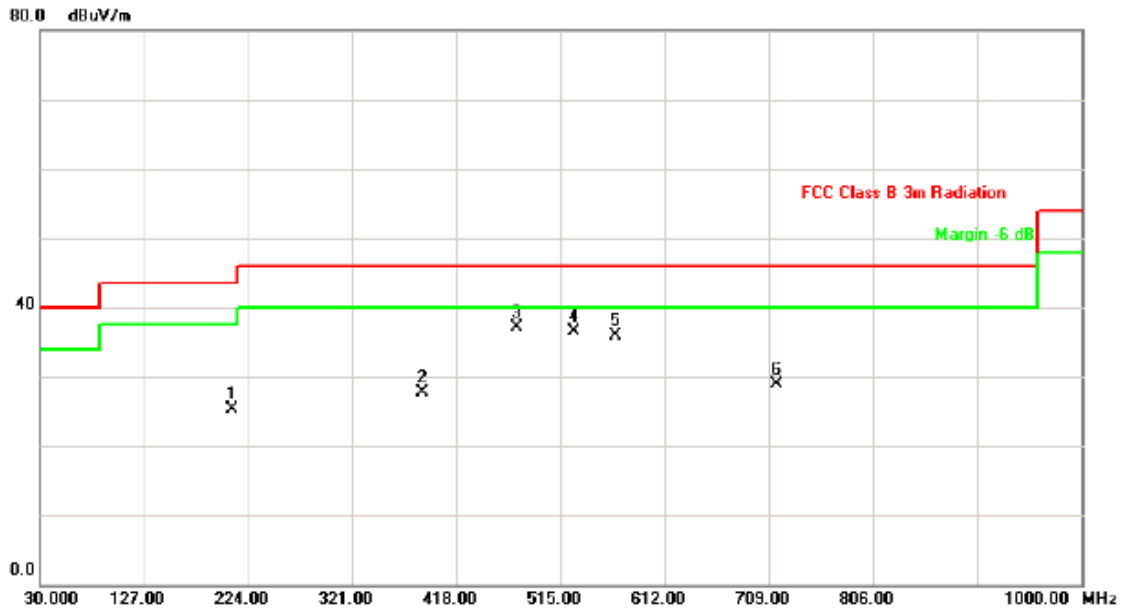

No.	Mk.	Freq. MHz	Reading Level dBuV	Correct Factor dB	Measure- ment dBuV/m	Limit dBuV/m	Over dB	Detector	Comment
1		209.4500	42.09	-16.78	25.31	43.50	-18.19	peak	
2		386.4750	38.02	-10.27	27.75	46.00	-18.25	peak	
3	*	473.7750	45.90	-8.70	37.20	46.00	-8.80	peak	
4		527.1250	43.94	-7.42	36.52	46.00	-9.48	peak	
5		565.9250	42.06	-6.25	35.81	46.00	-10.19	peak	
6		716.2750	33.45	-4.53	28.92	46.00	-17.08	peak	



EUT :	300Mbps Wireless Dual Band USB Adapter	Model Name :	WF2150
Temperature :	25°C	Relative Humidity :	58 %
Pressure :	1010 hPa	Test Voltage :	AC 120V/60Hz
Test Mode :	TX A Mode 5180MHz	Phase:	Horizontal

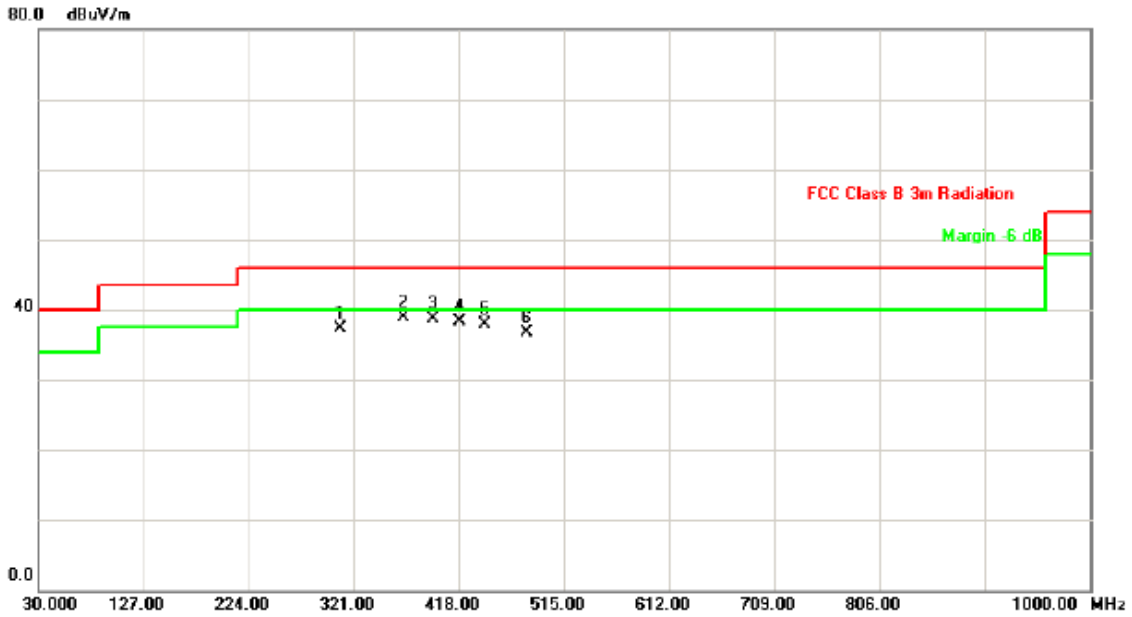

No.	Mk.	Freq. MHz	Reading Level dBuV	Correct Factor dB	Measure- ment dBuV/m	Limit dBuV/m	Over dB	Detector	Comment
1		308.8750	49.66	-12.45	37.21	46.00	-8.79	peak	
2	*	367.0750	49.77	-10.93	38.84	46.00	-7.16	peak	
3		393.7500	48.77	-10.03	38.74	46.00	-7.26	peak	
4		418.0000	47.77	-9.52	38.25	46.00	-7.75	peak	
5		442.2500	46.97	-9.14	37.83	46.00	-8.17	peak	
6		481.0500	45.25	-8.63	36.62	46.00	-9.38	peak	



4.2.8 TEST RESULTS - ABOVE 1000MHZ

EUT :	300Mbps Wireless Dual Band USB Adapter	Model Name :	WF2150
Temperature :	25 °C	Relative Humidity :	58 %
Test Voltage :	AC 120V/60Hz		
Test Mode :	Band 1/ TX A Mode 5180MHz		

Freq. (MHz)	Ant.Pol. H/V	Reading		Ant./CF CF(dB)	Act.		Limit		Note
		Peak (dBuV)	AV (dBuV)		Peak (dBuV/m)	AV (dBuV/m)	Peak (dBuV/m)	AV (dBuV/m)	
5150.00	V	26.65	15.16	40.09	66.74	55.25	80.00	60.00	X/E
5176.50	V	61.68	52.59	40.16	101.84	92.75			X/F
# 10360.25	V	47.80	34.60	13.73	61.53	48.33	74.30	60.00	X/H

Remark :

- (1) Spectrum Setting : 30MHz – 1000MHz , RBW= 100KHz, VBW=100KHz, Sweep time = 200 ms. 1GHz- 40GHz, RBW= 1MHz, VBW= 1MHz, Sweep time = Auto
- (2) All readings are Peak unless otherwise stated AV in column of 『Note』 . Peak denotes that the Peak reading compliance with the AV Limits and then AV Mode measurement didn't perform.
- (3) Measuring frequency range from 30MHz to 1000MHz or the 10th harmonic of highest fundamental frequency.“F” denotes fundamental frequency; “H” denotes spurious frequency. “E” denotes band edge frequency. (This judgment method includes the Band Edge Requirement.)
- (4) Radiated emissions measured in frequency range above 1000MHz were made with an instrument using Peak detector mode and AV detector mode of the emission .
- (5) Data of measurement within this frequency range shown “ * ” in the table above means the reading of emissions are attenuated more than 20dB below the permissible limits or the field strength is too small to be measured.
- (6) A preamp and high pass filter were used for this test in order to provide sufficient measurement sensitivity.
- (7) EUT Orthogonal Axes :
“X” - denotes Laid on Table ; ”Y” - denotes Vertical Stand ; ”Z” - denotes Side Stand
- (8) During the measurements above 1GHz it is taken care of that the EUT is always within the 3dB cone of radiation BW of the used antenna.
- (9) The limits above 5GHz shall be extrapolated to the specified distance using an extrapolation factor of 20dB/decade form 3m to 1.5m
Distance extrapolation factor = 20 log (3m/1.5m) dB ;
Limit line = specific limits (dBuV) + 6 dB
- (10) “#” The radiated frequency is out of the restricted band.



Orthogonal Axis : X
Band 1/CH36(Above 1000 MHz, Vertical)

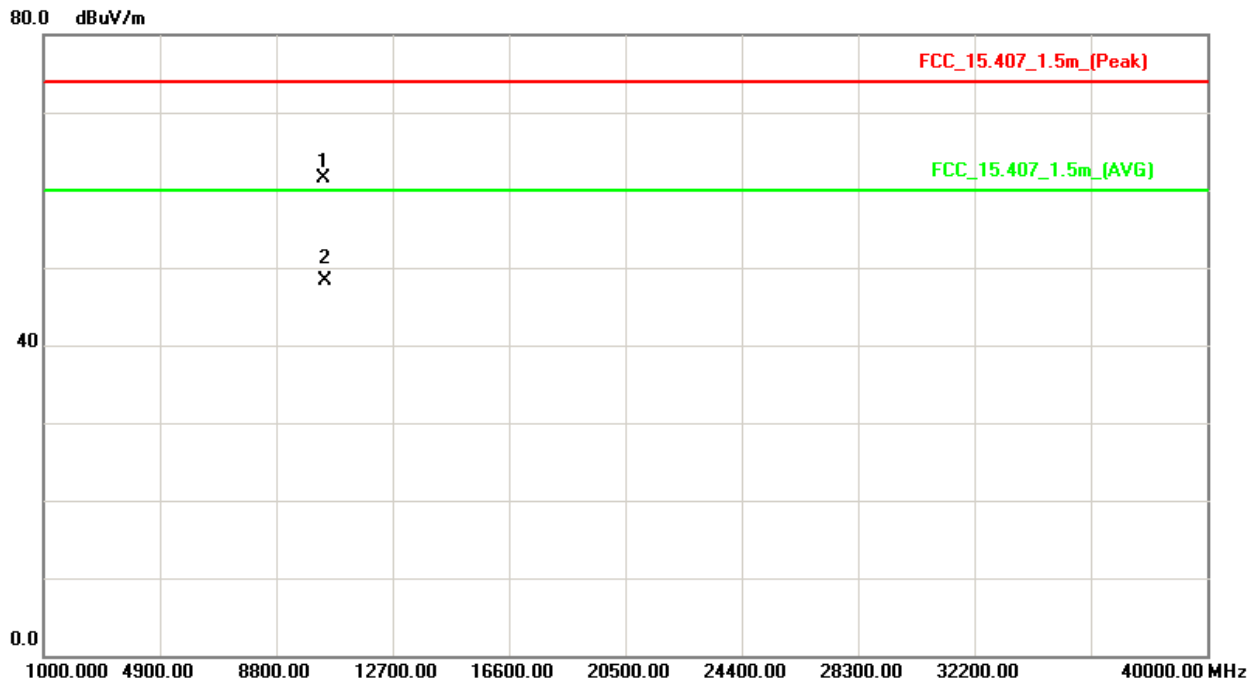
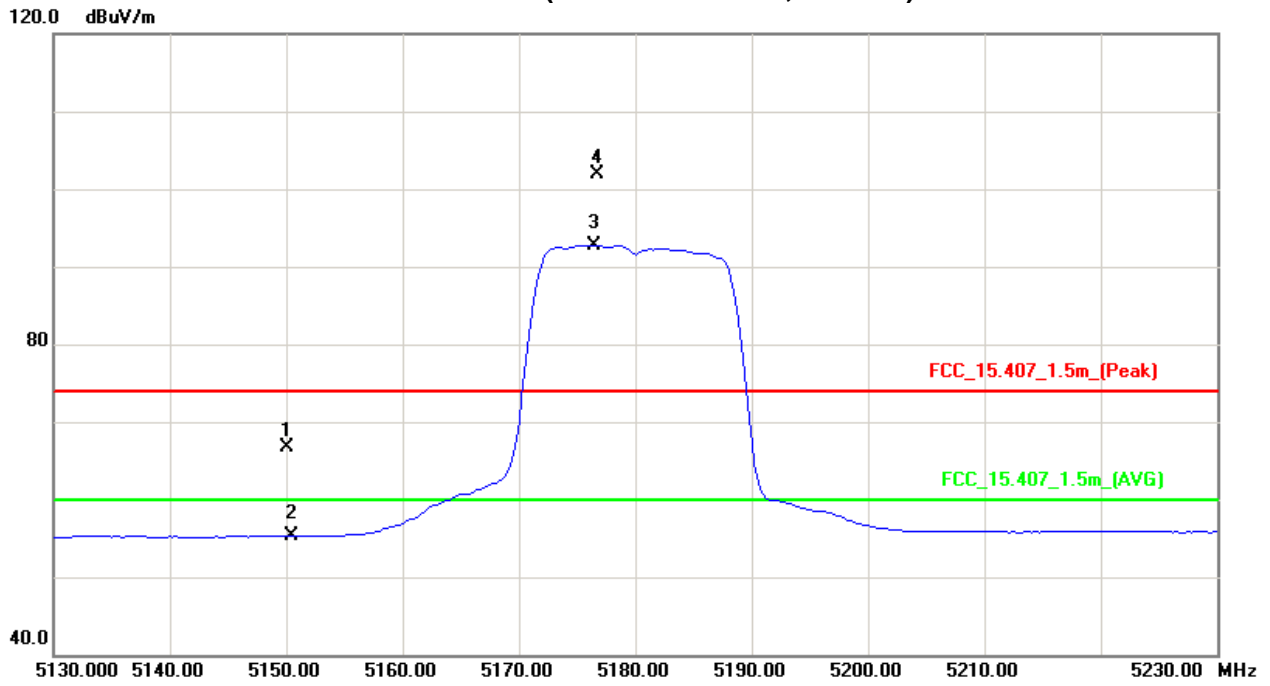



EUT :	300Mbps Wireless Dual Band USB Adapter	Model Name :	WF2150
Temperature :	25 °C	Relative Humidity :	58 %
Test Voltage :	AC 120V/60Hz		
Test Mode :	Band 1/ TX A Mode 5180MHz		

Freq. (MHz)	Ant.Pol. H/V	Reading		Ant./CF CF(dB)	Act.		Limit		Note
		Peak (dBuV)	AV (dBuV)		Peak (dBuV/m)	AV (dBuV/m)	Peak (dBuV/m)	AV (dBuV/m)	
5150.00	H	26.86	15.13	40.09	66.95	55.22	80.00	60.00	X/E
5182.25	H	60.71	51.67	40.18	100.89	91.85			X/F
# 10359.50	H	46.94	33.24	13.73	60.67	46.97	74.30	60.00	X/H

Remark :

- (1) Spectrum Setting : 30MHz – 1000MHz , RBW= 100KHz, VBW=100KHz, Sweep time = 200 ms. 1GHz- 40GHz, RBW= 1MHz, VBW= 1MHz, Sweep time = Auto
- (2) All readings are Peak unless otherwise stated AV in column of 『Note』 . Peak denotes that the Peak reading compliance with the AV Limits and then AV Mode measurement didn't perform.
- (3) Measuring frequency range from 30MHz to 1000MHz or the 10th harmonic of highest fundamental frequency. "F" denotes fundamental frequency; "H" denotes spurious frequency. "E" denotes band edge frequency. (This judgment method includes the Band Edge Requirement.)
- (4) Radiated emissions measured in frequency range above 1000MHz were made with an instrument using Peak detector mode and AV detector mode of the emission .
- (5) Data of measurement within this frequency range shown " * " in the table above means the reading of emissions are attenuated more than 20dB below the permissible limits or the field strength is too small to be measured.
- (6) A preamp and high pass filter were used for this test in order to provide sufficient measurement sensitivity.
- (7) EUT Orthogonal Axes :
"X" - denotes Laid on Table ; "Y" - denotes Vertical Stand ; "Z" - denotes Side Stand
- (8) During the measurements above 1GHz it is taken care of that the EUT is always within the 3dB cone of radiation BW of the used antenna.
- (9) The limits above 5GHz shall be extrapolated to the specified distance using an extrapolation factor of 20dB/decade form 3m to 1.5m
Distance extrapolation factor = 20 log (3m/1.5m) dB ;
Limit line = specific limits (dBuV) + 6 dB
- (10) "#" The radiated frequency is out of the restricted band.



Orthogonal Axis : X
Band 1/CH36(Above 1000 MHz, Horizontal)

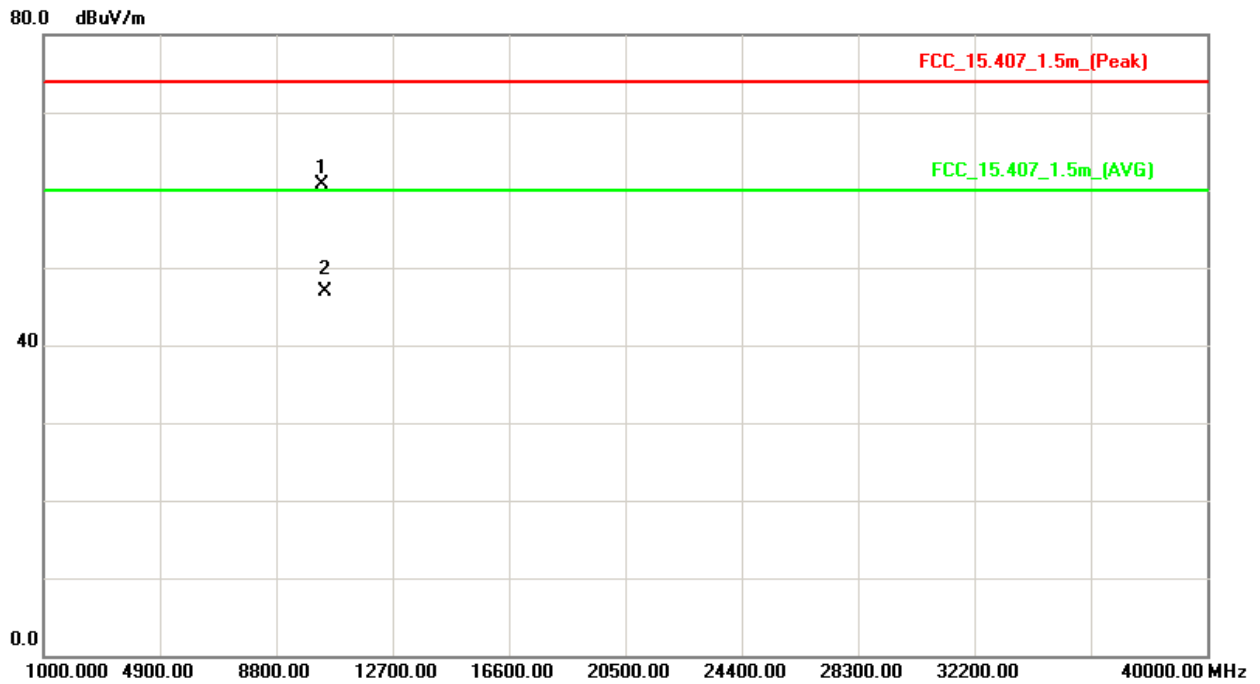
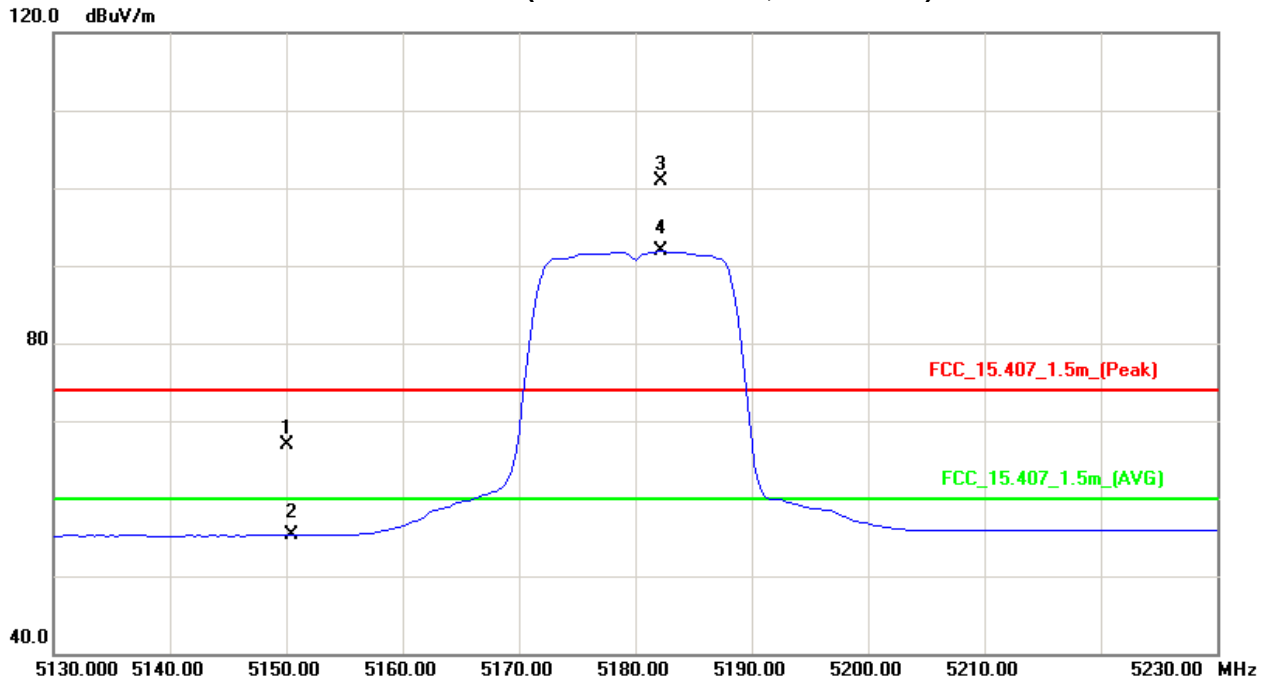



EUT :	300Mbps Wireless Dual Band USB Adapter	Model Name :	WF2150
Temperature :	25 °C	Relative Humidity :	58 %
Test Voltage :	AC 120V/60Hz		
Test Mode :	Band 1/ TX A Mode 5200MHz		

Freq. (MHz)	Ant.Pol. H/V	Reading		Ant./CF CF(dB)	Act.		Limit		Note
		Peak (dBuV)	AV (dBuV)		Peak (dBuV/m)	AV (dBuV/m)	Peak (dBuV/m)	AV (dBuV/m)	
5196.75	V	61.92	52.01	40.21	102.13	92.22			X/F
# 10400.42	V	47.26	33.14	13.78	61.04	46.92	74.30	60.00	X/H

Remark :

- (1) Spectrum Setting : 30MHz – 1000MHz , RBW= 100KHz, VBW=100KHz, Sweep time = 200 ms. 1GHz- 40GHz, RBW= 1MHz, VBW= 1MHz, Sweep time = Auto
- (2) All readings are Peak unless otherwise stated AV in column of 『Note』 . Peak denotes that the Peak reading compliance with the AV Limits and then AV Mode measurement didn't perform.
- (3) Measuring frequency range from 30MHz to 1000MHz or the 10th harmonic of highest fundamental frequency. "F" denotes fundamental frequency; "H" denotes spurious frequency. "E" denotes band edge frequency. (This judgment method includes the Band Edge Requirement.)
- (4) Radiated emissions measured in frequency range above 1000MHz were made with an instrument using Peak detector mode and AV detector mode of the emission .
- (5) Data of measurement within this frequency range shown " * " in the table above means the reading of emissions are attenuated more than 20dB below the permissible limits or the field strength is too small to be measured.
- (6) A preamp and high pass filter were used for this test in order to provide sufficient measurement sensitivity.
- (7) EUT Orthogonal Axes :
"X" - denotes Laid on Table ; "Y" - denotes Vertical Stand ; "Z" - denotes Side Stand
- (8) During the measurements above 1GHz it is taken care of that the EUT is always within the 3dB cone of radiation BW of the used antenna.
- (9) The limits above 5GHz shall be extrapolated to the specified distance using an extrapolation factor of 20dB/decade form 3m to 1.5m
Distance extrapolation factor = 20 log (3m/1.5m) dB ;
Limit line = specific limits (dBuV) + 6 dB
- (10) "#" The radiated frequency is out of the restricted band.



Orthogonal Axis : X
Band 1/CH40(Above 1000 MHz, Vertical)

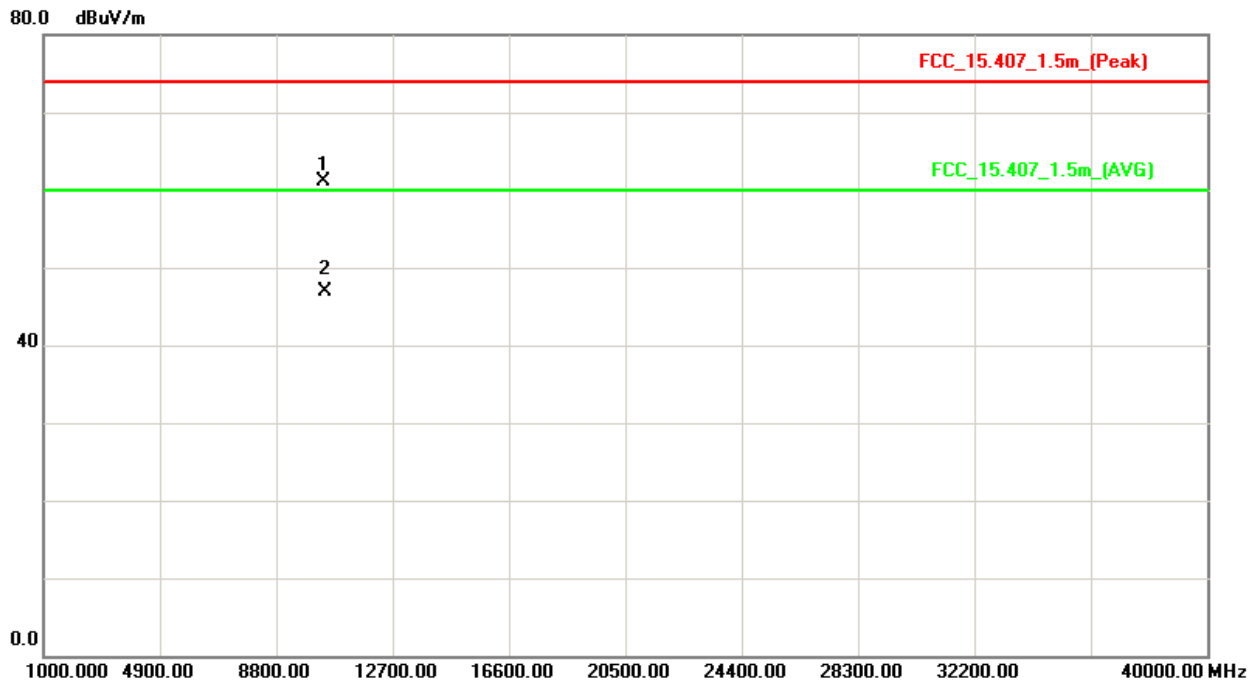
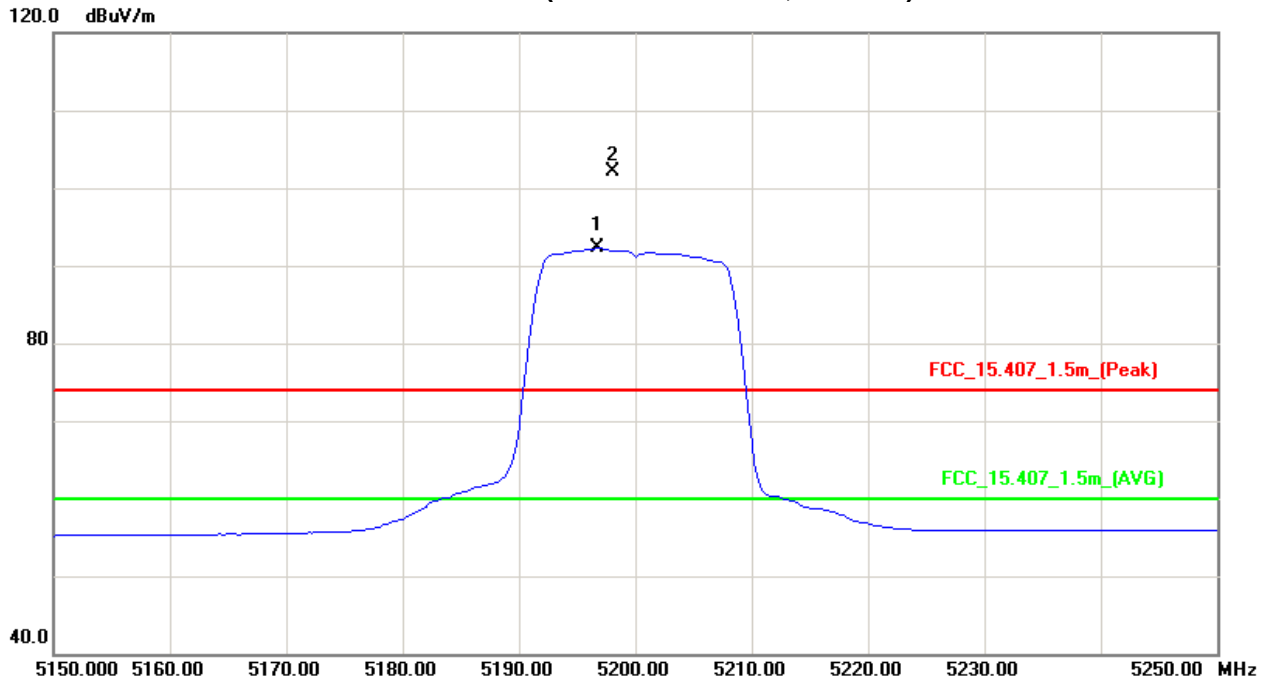



EUT :	300Mbps Wireless Dual Band USB Adapter	Model Name :	WF2150
Temperature :	25 °C	Relative Humidity :	58 %
Test Voltage :	AC 120V/60Hz		
Test Mode :	Band 1/ TX A Mode 5200MHz		

Freq. (MHz)	Ant.Pol. H/V	Reading		Ant./CF CF(dB)	Act.		Limit		Note
		Peak (dBuV)	AV (dBuV)		Peak (dBuV/m)	AV (dBuV/m)	Peak (dBuV/m)	AV (dBuV/m)	
5196.75	H	61.34	52.40	40.21	101.55	92.61			X/F
# 10400.2	H	45.56	32.17	13.78	59.34	45.95	74.30	60.00	X/H

Remark :

- (1) Spectrum Setting : 30MHz – 1000MHz , RBW= 100KHz, VBW=100KHz, Sweep time = 200 ms. 1GHz- 40GHz, RBW= 1MHz, VBW= 1MHz, Sweep time = Auto
- (2) All readings are Peak unless otherwise stated AV in column of 『Note』 . Peak denotes that the Peak reading compliance with the AV Limits and then AV Mode measurement didn't perform.
- (3) Measuring frequency range from 30MHz to 1000MHz or the 10th harmonic of highest fundamental frequency. "F" denotes fundamental frequency; "H" denotes spurious frequency. "E" denotes band edge frequency. (This judgment method includes the Band Edge Requirement.)
- (4) Radiated emissions measured in frequency range above 1000MHz were made with an instrument using Peak detector mode and AV detector mode of the emission .
- (5) Data of measurement within this frequency range shown " * " in the table above means the reading of emissions are attenuated more than 20dB below the permissible limits or the field strength is too small to be measured.
- (6) A preamp and high pass filter were used for this test in order to provide sufficient measurement sensitivity.
- (7) EUT Orthogonal Axes :
"X" - denotes Laid on Table ; "Y" - denotes Vertical Stand ; "Z" - denotes Side Stand
- (8) During the measurements above 1GHz it is taken care of that the EUT is always within the 3dB cone of radiation BW of the used antenna.
- (9) The limits above 5GHz shall be extrapolated to the specified distance using an extrapolation factor of 20dB/decade form 3m to 1.5m
Distance extrapolation factor = $20 \log (3m/1.5m)$ dB ;
Limit line = specific limits (dBuV) + 6 dB
- (10) "# " The radiated frequency is out of the restricted band.



Orthogonal Axis : X
Band 1/CH40(Above 1000 MHz, Horizontal)

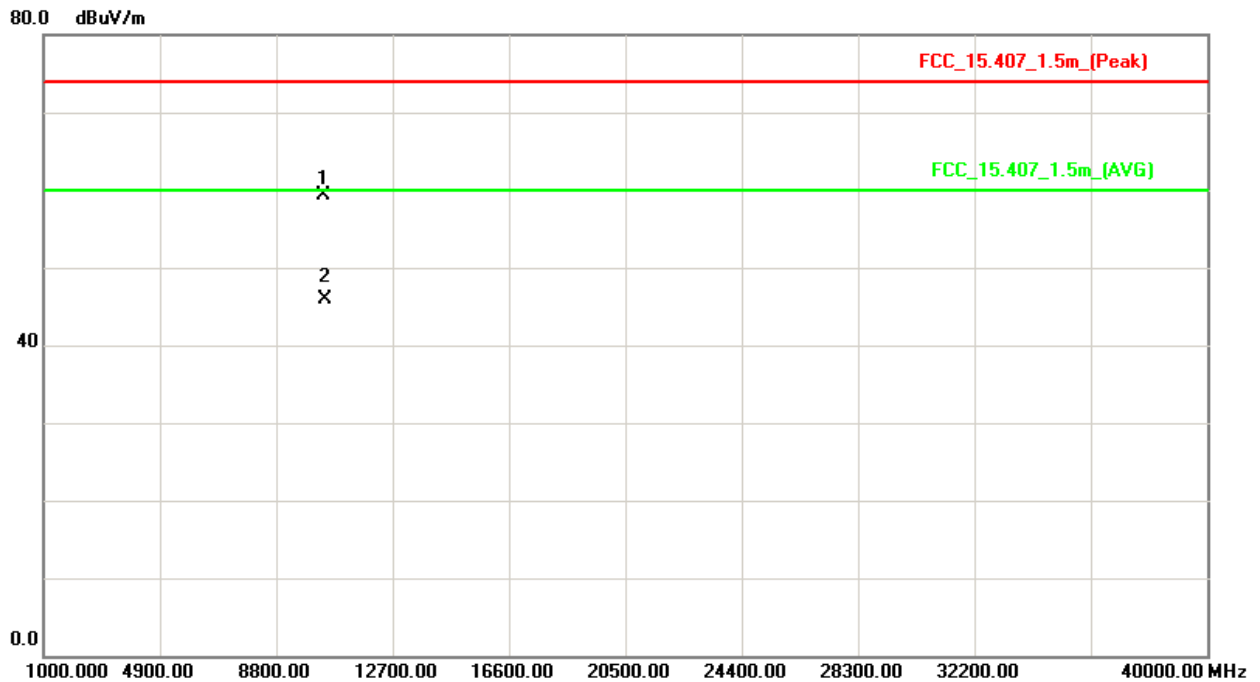
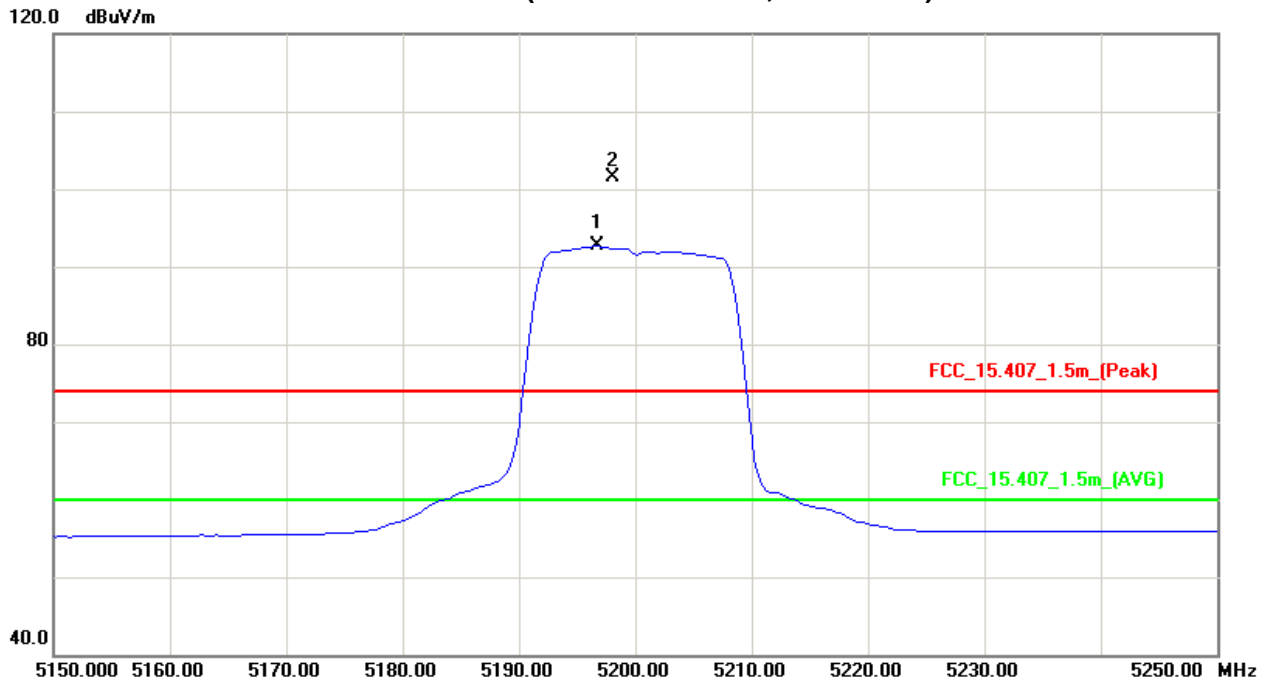



EUT :	300Mbps Wireless Dual Band USB Adapter	Model Name :	WF2150
Temperature :	25 °C	Relative Humidity :	52 %
Test Voltage :	AC 120V/60Hz		
Test Mode :	Band 1/ TX A Mode 5240MHz		

Freq. (MHz)	Ant.Pol. H/V	Reading		Ant./CF CF(dB)	Act.		Limit		Note
		Peak (dBuV)	AV (dBuV)		Peak (dBuV/m)	AV (dBuV/m)	Peak (dBuV/m)	AV (dBuV/m)	
5242.50	V	60.28	51.35	40.33	100.61	91.68			X/F
# 10481.35	V	46.98	33.16	13.87	60.85	47.03	74.30	60.00	X/H

Remark :

- (1) Spectrum Setting : 30MHz – 1000MHz , RBW= 100KHz, VBW=100KHz, Sweep time = 200 ms. 1GHz- 40GHz, RBW= 1MHz, VBW= 1MHz, Sweep time = Auto
- (2) All readings are Peak unless otherwise stated AV in column of 『Note 』 . Peak denotes that the Peak reading compliance with the AV Limits and then AV Mode measurement didn't perform.
- (3) Measuring frequency range from 30MHz to 1000MHz or the 10th harmonic of highest fundamental frequency. "F" denotes fundamental frequency; "H" denotes spurious frequency. "E" denotes band edge frequency. (This judgment method includes the Band Edge Requirement.)
- (4) Radiated emissions measured in frequency range above 1000MHz were made with an instrument using Peak detector mode and AV detector mode of the emission .
- (5) Data of measurement within this frequency range shown " * " in the table above means the reading of emissions are attenuated more than 20dB below the permissible limits or the field strength is too small to be measured.
- (6) A preamp and high pass filter were used for this test in order to provide sufficient measurement sensitivity.
- (7) EUT Orthogonal Axes :
 "X" - denotes Laid on Table ; "Y" - denotes Vertical Stand ; "Z" - denotes Side Stand
- (8) During the measurements above 1GHz it is taken care of that the EUT is always within the 3dB cone of radiation BW of the used antenna.
- (9) The limits above 5GHz shall be extrapolated to the specified distance using an extrapolation factor of 20dB/decade form 3m to 1.5m
 Distance extrapolation factor = 20 log (3m/1.5m) dB ;
 Limit line = specific limits (dBuV) + 6 dB
- (10) "#" The radiated frequency is out of the restricted band.



Orthogonal Axis : X
Band 1/CH48(Above 1000 MHz, Vertical)

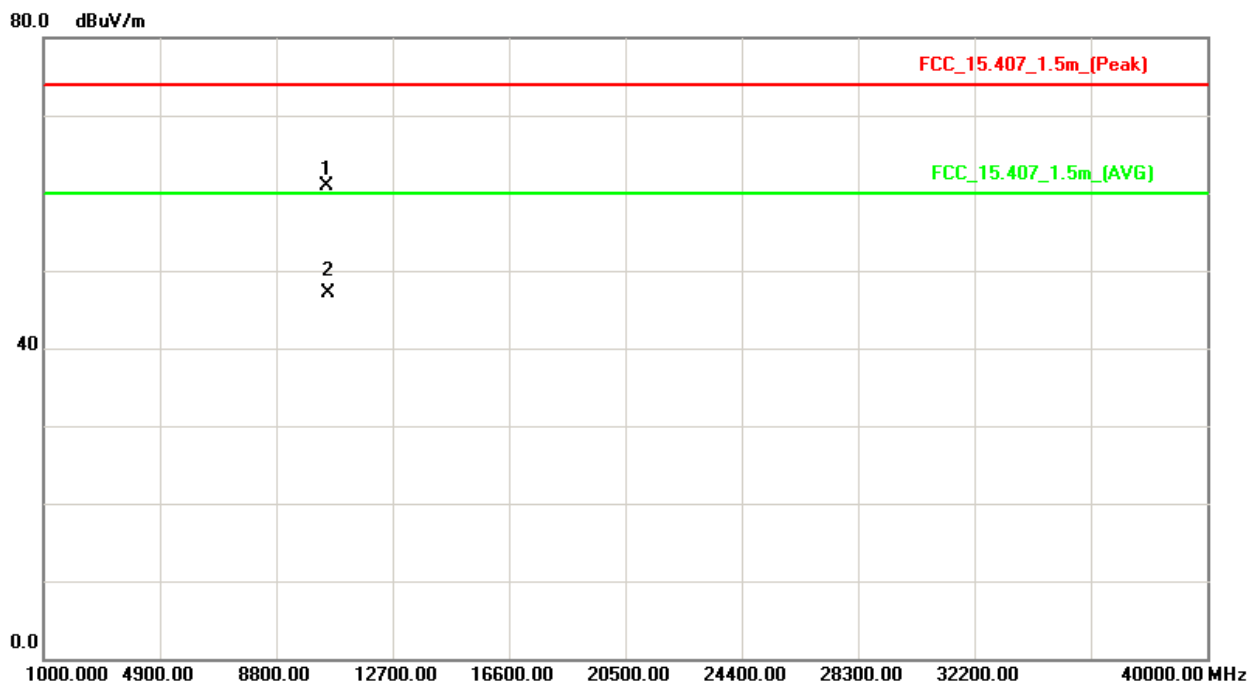
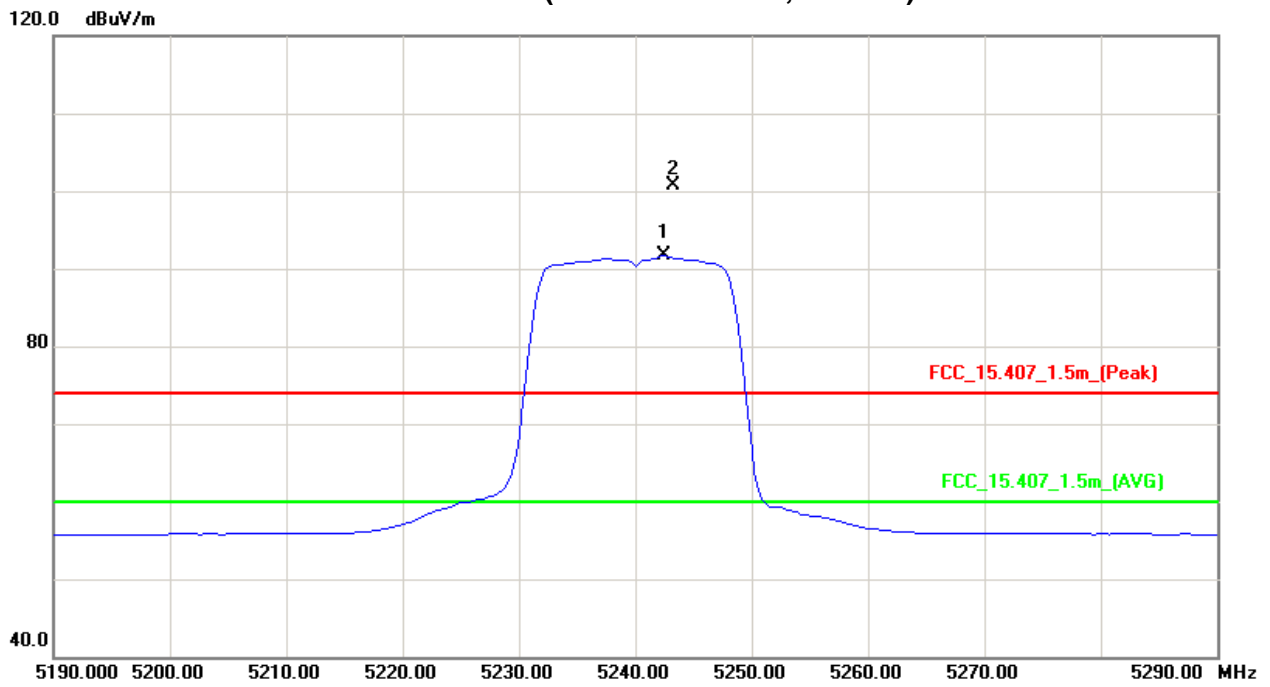



EUT :	300Mbps Wireless Dual Band USB Adapter	Model Name :	WF2150
Temperature :	25 °C	Relative Humidity :	52 %
Test Voltage :	AC 120V/60Hz		
Test Mode :	Band 1/ TX A Mode 5240MHz		

Freq. (MHz)	Ant.Pol. H/V	Reading		Ant./CF CF(dB)	Act.		Limit		Note
		Peak (dBuV)	AV (dBuV)		Peak (dBuV/m)	AV (dBuV/m)	Peak (dBuV/m)	AV (dBuV/m)	
5237.50	H	60.58	51.75	40.32	100.90	92.07			X/F
# 10480.05	H	46.42	32.52	13.87	60.29	46.39	74.30	60.00	X/H

Remark :

- (1) Spectrum Setting : 30MHz – 1000MHz , RBW= 100KHz, VBW=100KHz, Sweep time = 200 ms. 1GHz- 40GHz, RBW= 1MHz, VBW= 1MHz, Sweep time = Auto
- (2) All readings are Peak unless otherwise stated AV in column of 『Note』 . Peak denotes that the Peak reading compliance with the AV Limits and then AV Mode measurement didn't perform.
- (3) Measuring frequency range from 30MHz to 1000MHz or the 10th harmonic of highest fundamental frequency. "F" denotes fundamental frequency; "H" denotes spurious frequency. "E" denotes band edge frequency. (This judgment method includes the Band Edge Requirement.)
- (4) Radiated emissions measured in frequency range above 1000MHz were made with an instrument using Peak detector mode and AV detector mode of the emission .
- (5) Data of measurement within this frequency range shown " * " in the table above means the reading of emissions are attenuated more than 20dB below the permissible limits or the field strength is too small to be measured.
- (6) A preamp and high pass filter were used for this test in order to provide sufficient measurement sensitivity.
- (7) EUT Orthogonal Axes :
 "X" - denotes Laid on Table ; "Y" - denotes Vertical Stand ; "Z" - denotes Side Stand
- (8) During the measurements above 1GHz it is taken care of that the EUT is always within the 3dB cone of radiation BW of the used antenna.
- (9) The limits above 5GHz shall be extrapolated to the specified distance using an extrapolation factor of 20dB/decade form 3m to 1.5m
 Distance extrapolation factor = $20 \log (3m/1.5m)$ dB ;
 Limit line = specific limits (dBuV) + 6 dB
- (10) "#" The radiated frequency is out of the restricted band.



Orthogonal Axis : X
Band 1/CH48(Above 1000 MHz, Horizontal)

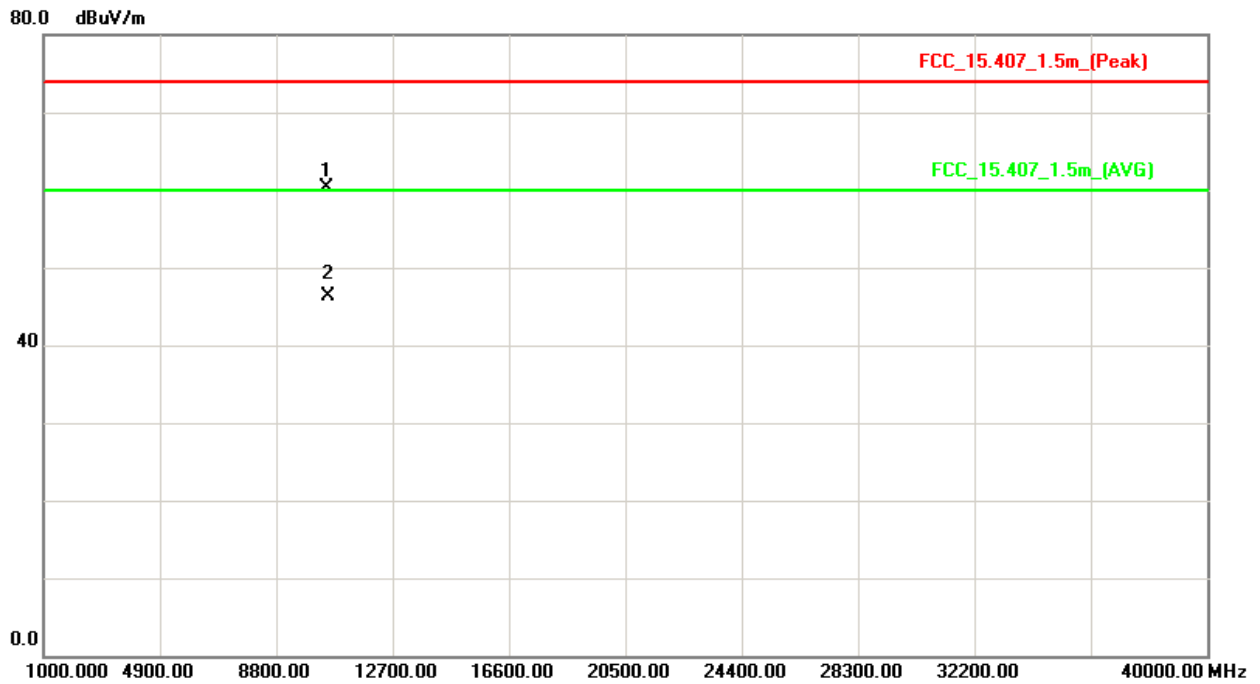
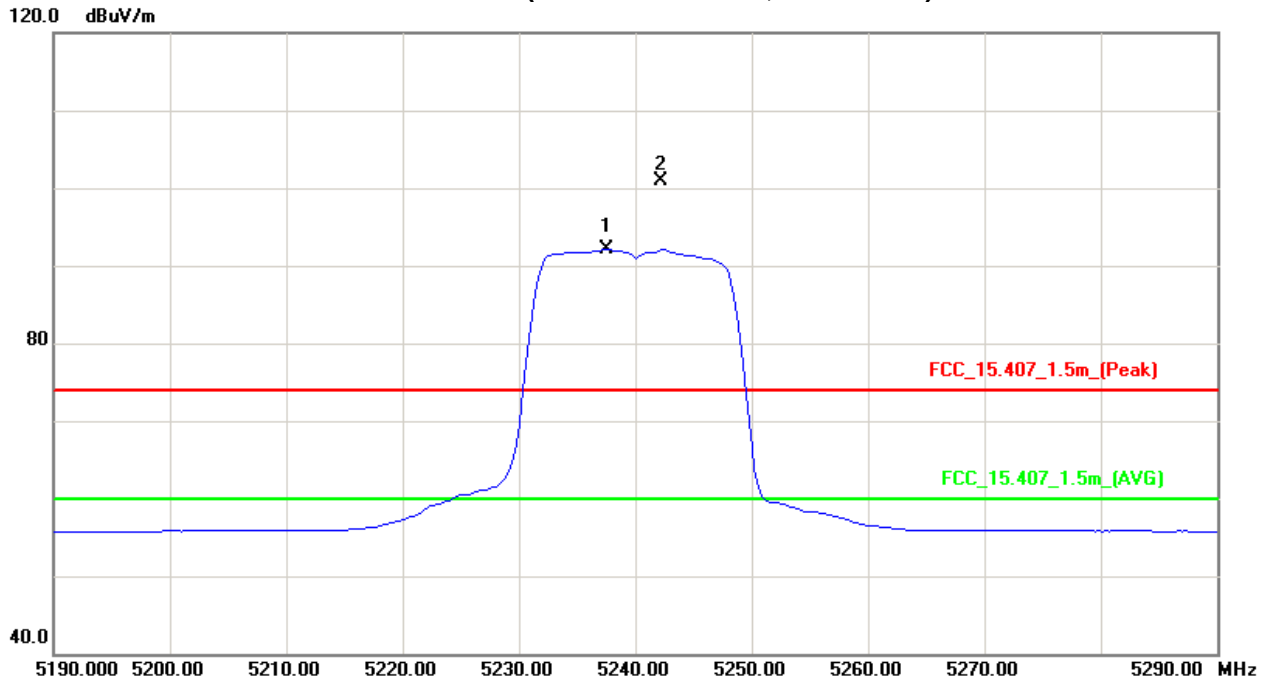



EUT :	300Mbps Wireless Dual Band USB Adapter	Model Name :	WF2150
Temperature :	25 °C	Relative Humidity :	58 %
Test Voltage :	AC 120V/60Hz		
Test Mode :	Band 1/ TX N20 Mode 5180MHz		

Freq. (MHz)	Ant.Pol. H/V	Reading		Ant./CF CF(dB)	Act.		Limit		Note
		Peak (dBuV)	AV (dBuV)		Peak (dBuV/m)	AV (dBuV/m)	Peak (dBuV/m)	AV (dBuV/m)	
5150.00	V	26.76	15.11	40.09	66.85	55.20	74.30	60.00	X/E
5174.25	V	59.09	48.77	40.15	99.24	88.92			X/F
# 10360.24	V	46.85	33.59	13.73	60.58	47.32	74.30	60.00	X/H

Remark :

- (1) Spectrum Setting : 30MHz – 1000MHz , RBW= 100KHz, VBW=100KHz, Sweep time = 200 ms. 1GHz- 40GHz, RBW= 1MHz, VBW= 1MHz, Sweep time = Auto
- (2) All readings are Peak unless otherwise stated AV in column of 『Note』 . Peak denotes that the Peak reading compliance with the AV Limits and then AV Mode measurement didn't perform.
- (3) Measuring frequency range from 30MHz to 1000MHz or the 10th harmonic of highest fundamental frequency. "F" denotes fundamental frequency; "H" denotes spurious frequency. "E" denotes band edge frequency. (This judgment method includes the Band Edge Requirement.)
- (4) Radiated emissions measured in frequency range above 1000MHz were made with an instrument using Peak detector mode and AV detector mode of the emission .
- (5) Data of measurement within this frequency range shown " * " in the table above means the reading of emissions are attenuated more than 20dB below the permissible limits or the field strength is too small to be measured.
- (6) A preamp and high pass filter were used for this test in order to provide sufficient measurement sensitivity.
- (7) EUT Orthogonal Axes :
"X" - denotes Laid on Table ; "Y" - denotes Vertical Stand ; "Z" - denotes Side Stand
- (8) During the measurements above 1GHz it is taken care of that the EUT is always within the 3dB cone of radiation BW of the used antenna.
- (9) The limits above 5GHz shall be extrapolated to the specified distance using an extrapolation factor of 20dB/decade form 3m to 1.5m
Distance extrapolation factor = 20 log (3m/1.5m) dB ;
Limit line = specific limits (dBuV) + 6 dB
- (10) "# " The radiated frequency is out of the restricted band.



Orthogonal Axis : X
Band 1/CH36(Above 1000 MHz, Vertical)

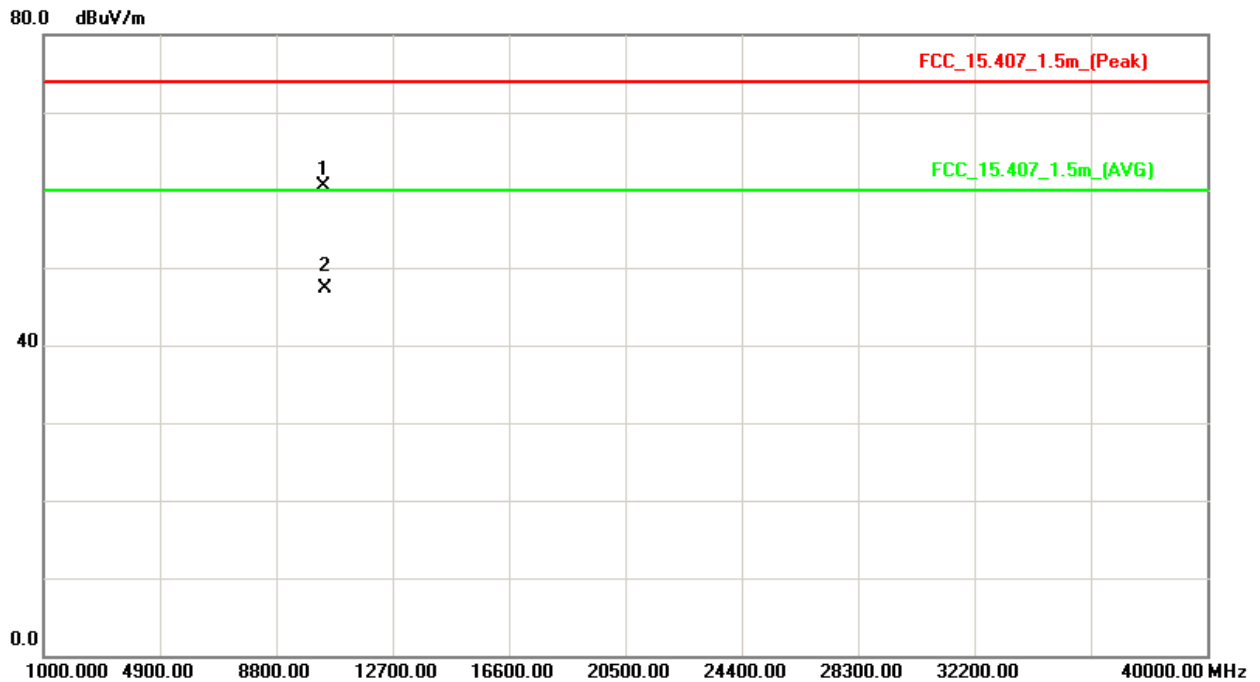
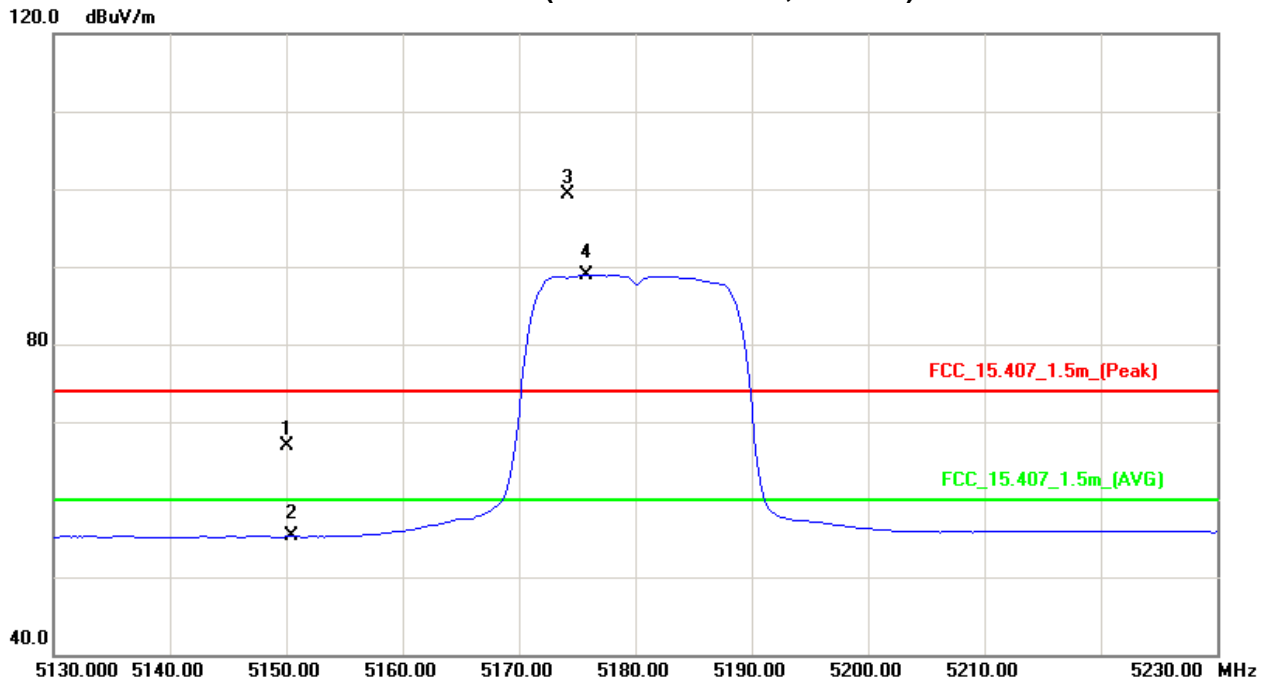



EUT :	300Mbps Wireless Dual Band USB Adapter	Model Name :	WF2150
Temperature :	25 °C	Relative Humidity :	58 %
Test Voltage :	AC 120V/60Hz		
Test Mode :	Band 1/ TX N20 Mode 5180MHz		

Freq. (MHz)	Ant.Pol. H/V	Reading		Ant./CF CF(dB)	Act.		Limit		Note
		Peak (dBuV)	AV (dBuV)		Peak (dBuV/m)	AV (dBuV/m)	Peak (dBuV/m)	AV (dBuV/m)	
5150.00	H	26.16	15.09	40.09	66.25	55.18	74.30	60.00	X/E
5181.25	H	56.41	46.58	40.18	96.59	86.76			X/F
# 10360.69	H	44.68	32.08	13.73	58.41	45.81	74.30	60.00	X/H

Remark :

- (1) Spectrum Setting : 30MHz – 1000MHz , RBW= 100KHz, VBW=100KHz, Sweep time = 200 ms. 1GHz- 40GHz, RBW= 1MHz, VBW= 1MHz, Sweep time = Auto
- (2) All readings are Peak unless otherwise stated AV in column of 『Note』 . Peak denotes that the Peak reading compliance with the AV Limits and then AV Mode measurement didn't perform.
- (3) Measuring frequency range from 30MHz to 1000MHz or the 10th harmonic of highest fundamental frequency. "F" denotes fundamental frequency; "H" denotes spurious frequency. "E" denotes band edge frequency. (This judgment method includes the Band Edge Requirement.)
- (4) Radiated emissions measured in frequency range above 1000MHz were made with an instrument using Peak detector mode and AV detector mode of the emission .
- (5) Data of measurement within this frequency range shown " * " in the table above means the reading of emissions are attenuated more than 20dB below the permissible limits or the field strength is too small to be measured.
- (6) A preamp and high pass filter were used for this test in order to provide sufficient measurement sensitivity.
- (7) EUT Orthogonal Axes :
"X" - denotes Laid on Table ; "Y" - denotes Vertical Stand ; "Z" - denotes Side Stand
- (8) During the measurements above 1GHz it is taken care of that the EUT is always within the 3dB cone of radiation BW of the used antenna.
- (9) The limits above 5GHz shall be extrapolated to the specified distance using an extrapolation factor of 20dB/decade form 3m to 1.5m
Distance extrapolation factor = 20 log (3m/1.5m) dB ;
Limit line = specific limits (dBuV) + 6 dB
- (10) "#" The radiated frequency is out of the restricted band.



Orthogonal Axis : X
Band 1/CH36(Above 1000 MHz, Horizontal)

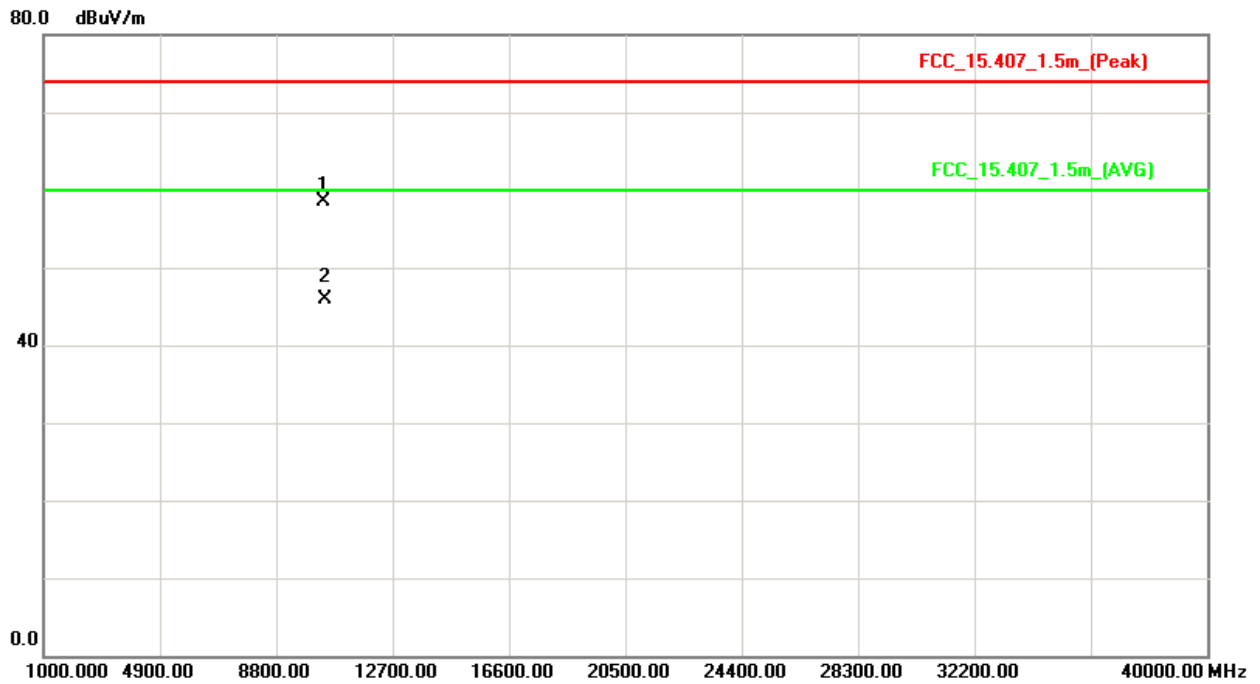
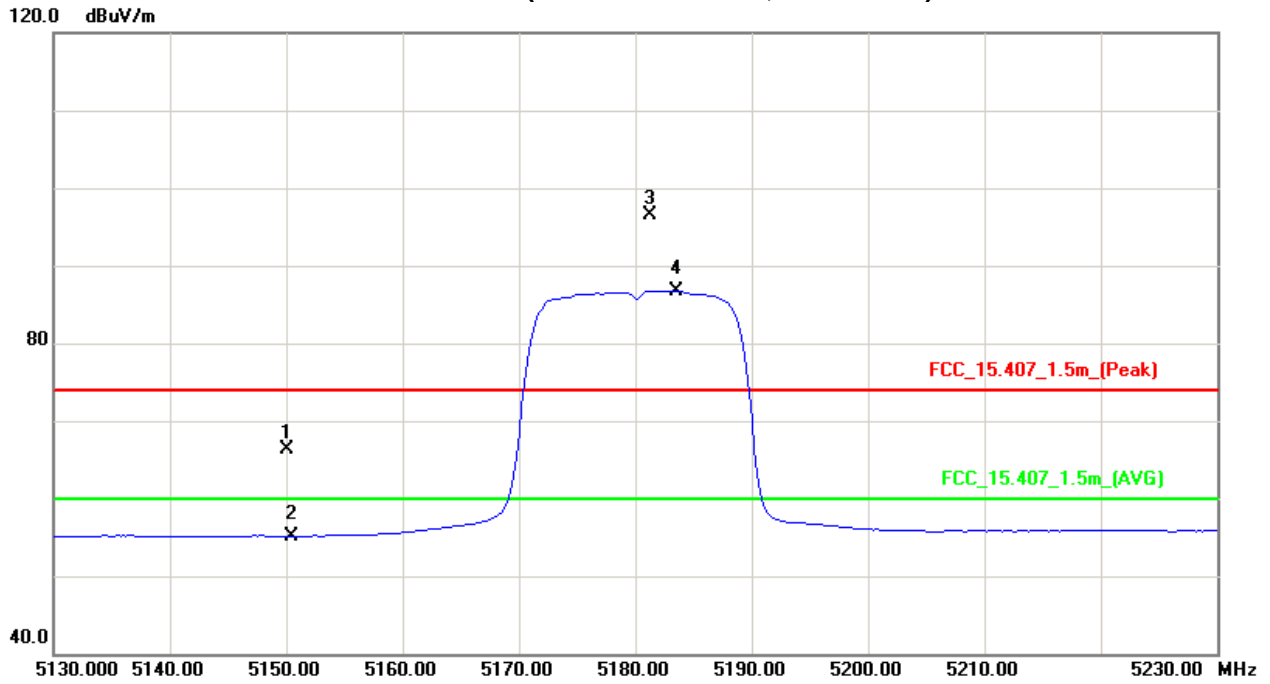



EUT :	300Mbps Wireless Dual Band USB Adapter	Model Name :	WF2150
Temperature :	25 °C	Relative Humidity :	58 %
Test Voltage :	AC 120V/60Hz		
Test Mode :	Band 1/ TX N20 Mode 5200MHz		

Freq. (MHz)	Ant.Pol. H/V	Reading		Ant./CF CF(dB)	Act.		Limit		Note
		Peak (dBuV)	AV (dBuV)		Peak (dBuV/m)	AV (dBuV/m)	Peak (dBuV/m)	AV (dBuV/m)	
5197.25	V	59.04	48.18	40.22	99.26	88.40			X/F
# 10400.32	V	47.15	33.58	13.78	60.93	47.36	74.30	60.00	X/H

Remark :

- (1) Spectrum Setting : 30MHz – 1000MHz , RBW= 100KHz, VBW=100KHz, Sweep time = 200 ms. 1GHz- 40GHz, RBW= 1MHz, VBW= 1MHz, Sweep time = Auto
- (2) All readings are Peak unless otherwise stated AV in column of 『Note』 . Peak denotes that the Peak reading compliance with the AV Limits and then AV Mode measurement didn't perform.
- (3) Measuring frequency range from 30MHz to 1000MHz or the 10th harmonic of highest fundamental frequency. "F" denotes fundamental frequency; "H" denotes spurious frequency. "E" denotes band edge frequency. (This judgment method includes the Band Edge Requirement.)
- (4) Radiated emissions measured in frequency range above 1000MHz were made with an instrument using Peak detector mode and AV detector mode of the emission .
- (5) Data of measurement within this frequency range shown " * " in the table above means the reading of emissions are attenuated more than 20dB below the permissible limits or the field strength is too small to be measured.
- (6) A preamp and high pass filter were used for this test in order to provide sufficient measurement sensitivity.
- (7) EUT Orthogonal Axes :
 "X" - denotes Laid on Table ; "Y" - denotes Vertical Stand ; "Z" - denotes Side Stand
- (8) During the measurements above 1GHz it is taken care of that the EUT is always within the 3dB cone of radiation BW of the used antenna.
- (9) The limits above 5GHz shall be extrapolated to the specified distance using an extrapolation factor of 20dB/decade form 3m to 1.5m
 Distance extrapolation factor = 20 log (3m/1.5m) dB ;
 Limit line = specific limits (dBuV) + 6 dB
- (10) "#" The radiated frequency is out of the restricted band.



Orthogonal Axis : X
Band 1/CH40(Above 1000 MHz, Vertical)

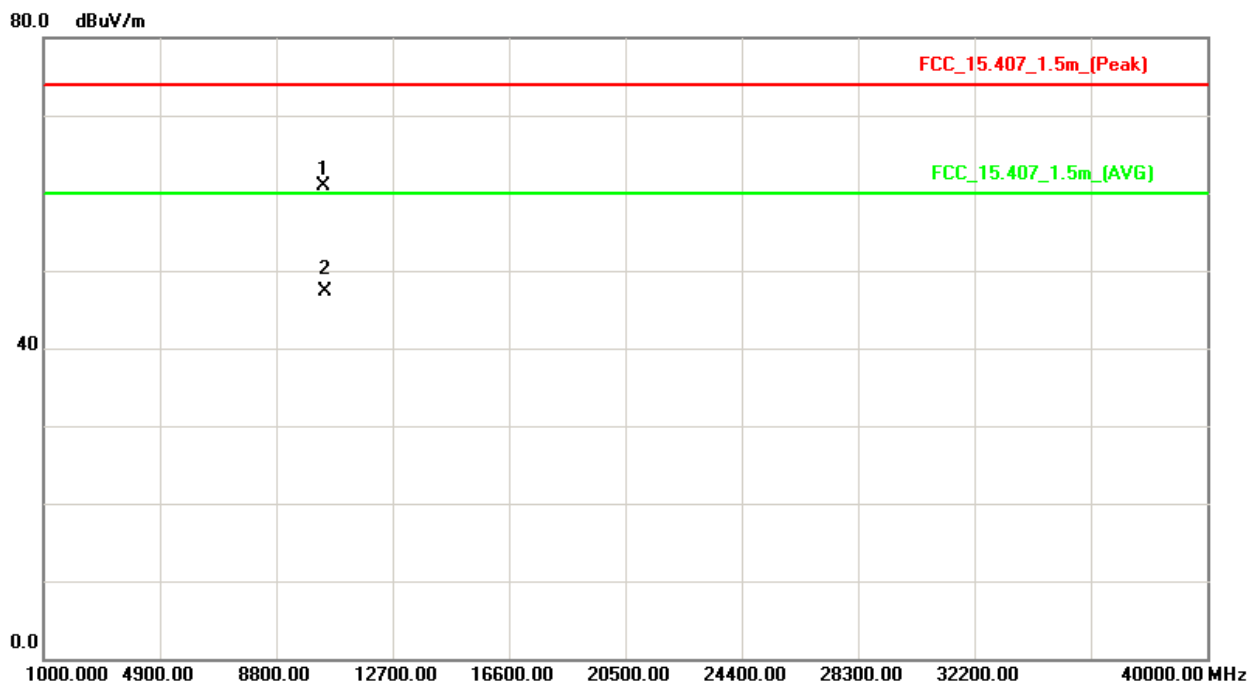
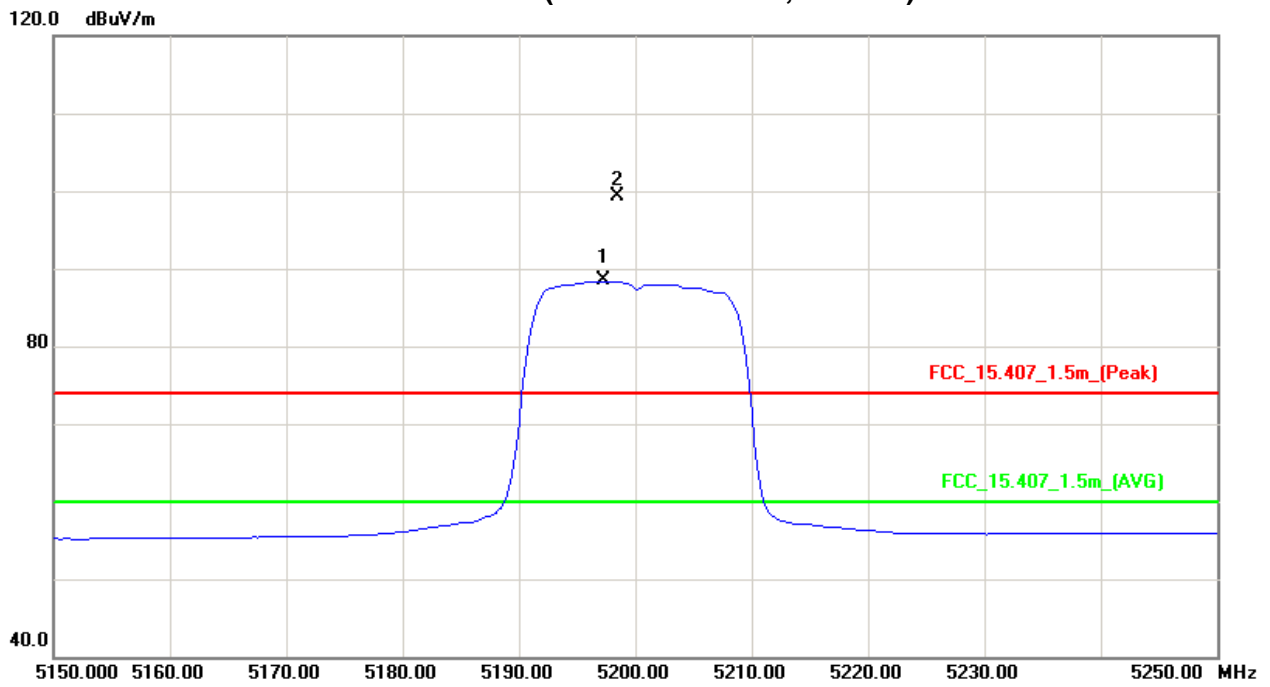



EUT :	300Mbps Wireless Dual Band USB Adapter	Model Name :	WF2150
Temperature :	25 °C	Relative Humidity :	58 %
Test Voltage :	AC 120V/60Hz		
Test Mode :	Band 1/ TX N20 Mode 5200MHz		

Freq. (MHz)	Ant.Pol. H/V	Reading		Ant./CF CF(dB)	Act.		Limit		Note
		Peak (dBuV)	AV (dBuV)		Peak (dBuV/m)	AV (dBuV/m)	Peak (dBuV/m)	AV (dBuV/m)	
5196.00	H	57.55	47.61	40.21	97.76	87.82			X/F
# 10400.14	H	44.89	31.60	13.78	58.67	45.38	74.30	60.00	X/H

Remark :

- (1) Spectrum Setting : 30MHz – 1000MHz , RBW= 100KHz, VBW=100KHz, Sweep time = 200 ms. 1GHz- 40GHz, RBW= 1MHz, VBW= 1MHz, Sweep time = Auto
- (2) All readings are Peak unless otherwise stated AV in column of 『Note』 . Peak denotes that the Peak reading compliance with the AV Limits and then AV Mode measurement didn't perform.
- (3) Measuring frequency range from 30MHz to 1000MHz or the 10th harmonic of highest fundamental frequency. "F" denotes fundamental frequency; "H" denotes spurious frequency. "E" denotes band edge frequency. (This judgment method includes the Band Edge Requirement.)
- (4) Radiated emissions measured in frequency range above 1000MHz were made with an instrument using Peak detector mode and AV detector mode of the emission .
- (5) Data of measurement within this frequency range shown " * " in the table above means the reading of emissions are attenuated more than 20dB below the permissible limits or the field strength is too small to be measured.
- (6) A preamp and high pass filter were used for this test in order to provide sufficient measurement sensitivity.
- (7) EUT Orthogonal Axes :
"X" - denotes Laid on Table ; "Y" - denotes Vertical Stand ; "Z" - denotes Side Stand
- (8) During the measurements above 1GHz it is taken care of that the EUT is always within the 3dB cone of radiation BW of the used antenna.
- (9) The limits above 5GHz shall be extrapolated to the specified distance using an extrapolation factor of 20dB/decade form 3m to 1.5m
Distance extrapolation factor = $20 \log (3m/1.5m)$ dB ;
Limit line = specific limits (dBuV) + 6 dB
- (10) "#" The radiated frequency is out of the restricted band.



Orthogonal Axis : X
Band 1/CH40(Above 1000 MHz, Horizontal)

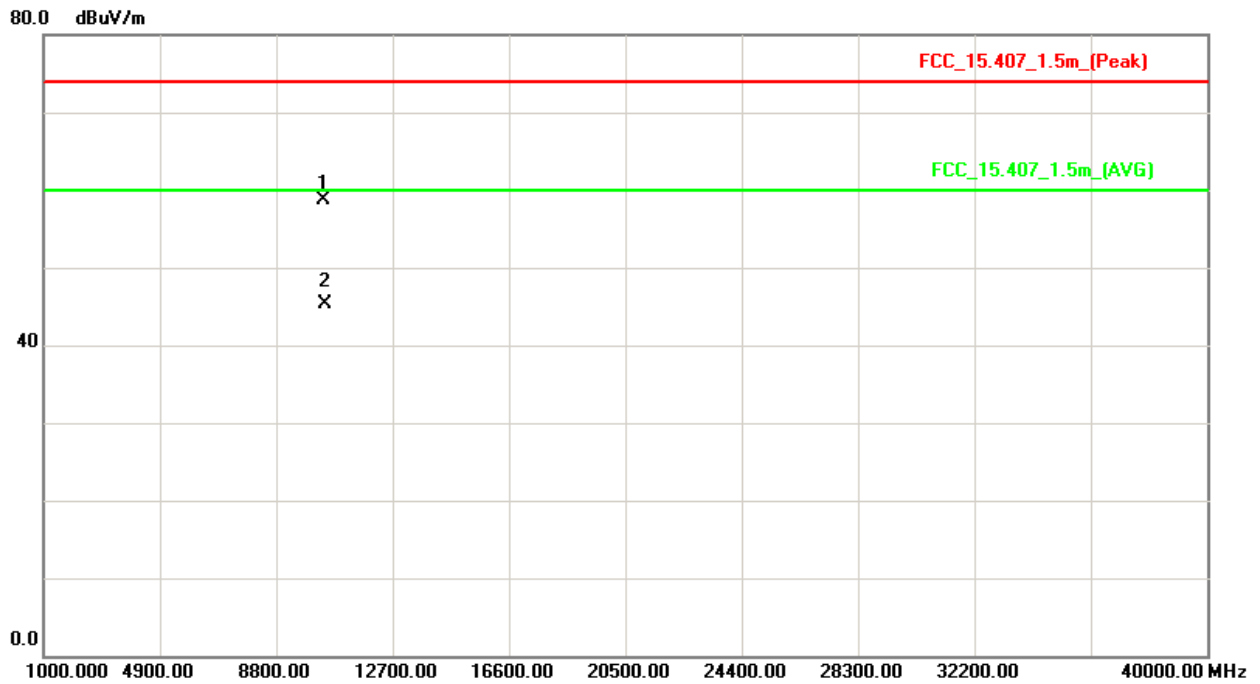
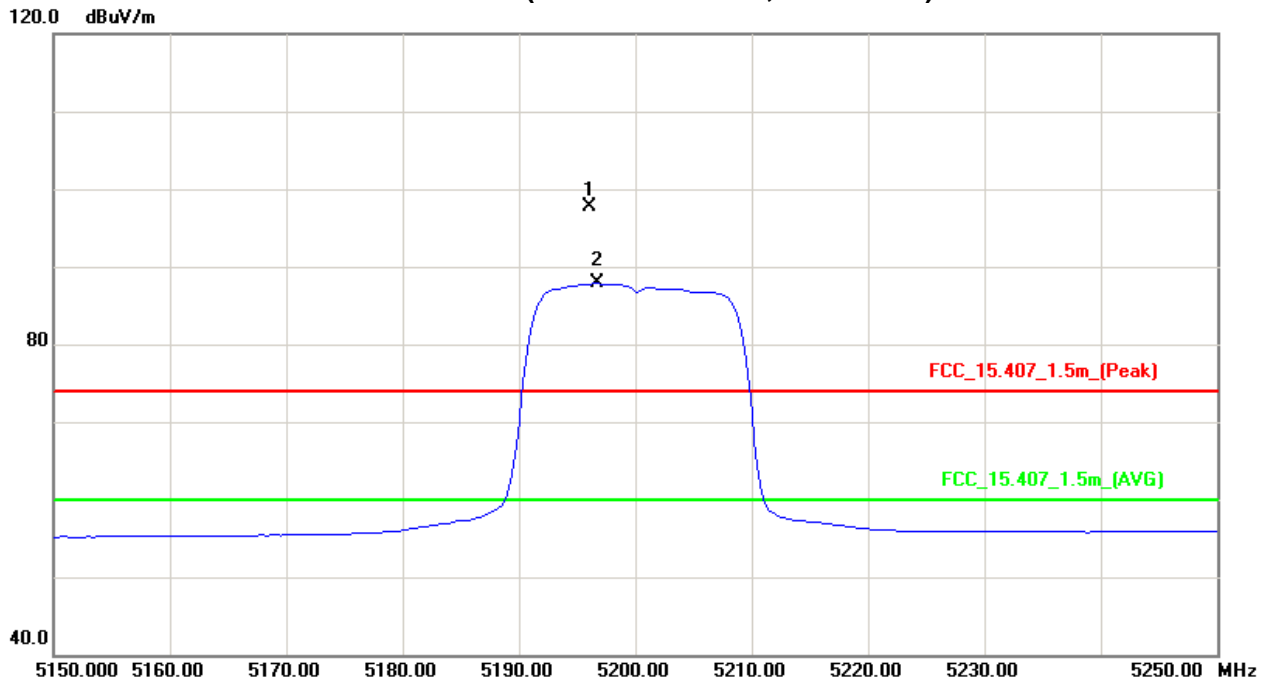



EUT :	300Mbps Wireless Dual Band USB Adapter	Model Name :	WF2150
Temperature :	25 °C	Relative Humidity :	52 %
Test Voltage :	AC 120V/60Hz		
Test Mode :	Band 1/ TX N20 Mode 5240MHz		

Freq. (MHz)	Ant.Pol. H/V	Reading		Ant./CF CF(dB)	Act.		Limit		Note
		Peak (dBuV)	AV (dBuV)		Peak (dBuV/m)	AV (dBuV/m)	Peak (dBuV/m)	AV (dBuV/m)	
5237.00	V	59.22	48.35	40.32	99.54	88.67			X/F
# 10480.41	V	46.55	32.26	13.87	60.42	46.13	74.30	60.00	X/H

Remark :

- (1) Spectrum Setting : 30MHz – 1000MHz , RBW= 100KHz, VBW=100KHz, Sweep time = 200 ms. 1GHz- 40GHz, RBW= 1MHz, VBW= 1MHz, Sweep time = Auto
- (2) All readings are Peak unless otherwise stated AV in column of 『Note 』 . Peak denotes that the Peak reading compliance with the AV Limits and then AV Mode measurement didn't perform.
- (3) Measuring frequency range from 30MHz to 1000MHz or the 10th harmonic of highest fundamental frequency. "F" denotes fundamental frequency; "H" denotes spurious frequency. "E" denotes band edge frequency. (This judgment method includes the Band Edge Requirement.)
- (4) Radiated emissions measured in frequency range above 1000MHz were made with an instrument using Peak detector mode and AV detector mode of the emission .
- (5) Data of measurement within this frequency range shown " * " in the table above means the reading of emissions are attenuated more than 20dB below the permissible limits or the field strength is too small to be measured.
- (6) A preamp and high pass filter were used for this test in order to provide sufficient measurement sensitivity.
- (7) EUT Orthogonal Axes :
 "X" - denotes Laid on Table ; "Y" - denotes Vertical Stand ; "Z" - denotes Side Stand
- (8) During the measurements above 1GHz it is taken care of that the EUT is always within the 3dB cone of radiation BW of the used antenna.
- (9) The limits above 5GHz shall be extrapolated to the specified distance using an extrapolation factor of 20dB/decade form 3m to 1.5m
 Distance extrapolation factor = 20 log (3m/1.5m) dB ;
 Limit line = specific limits (dBuV) + 6 dB
- (10) "# " The radiated frequency is out of the restricted band.



Orthogonal Axis : X
Band 1/CH48(Above 1000 MHz, Vertical)

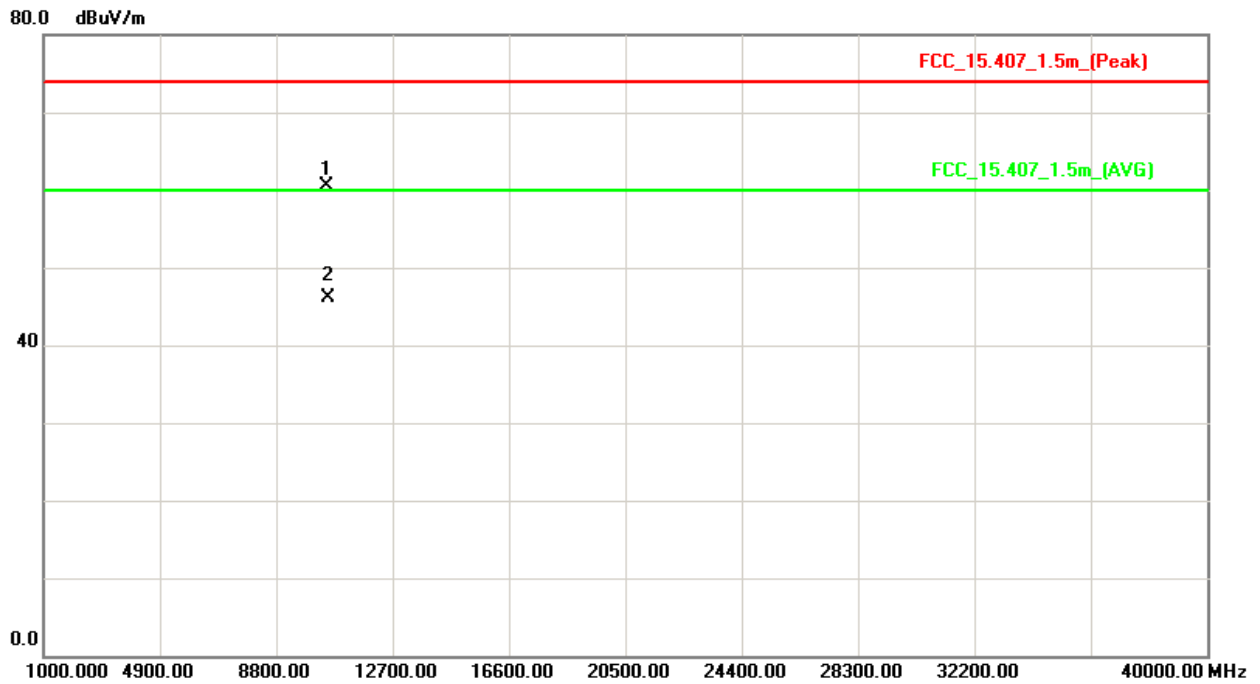
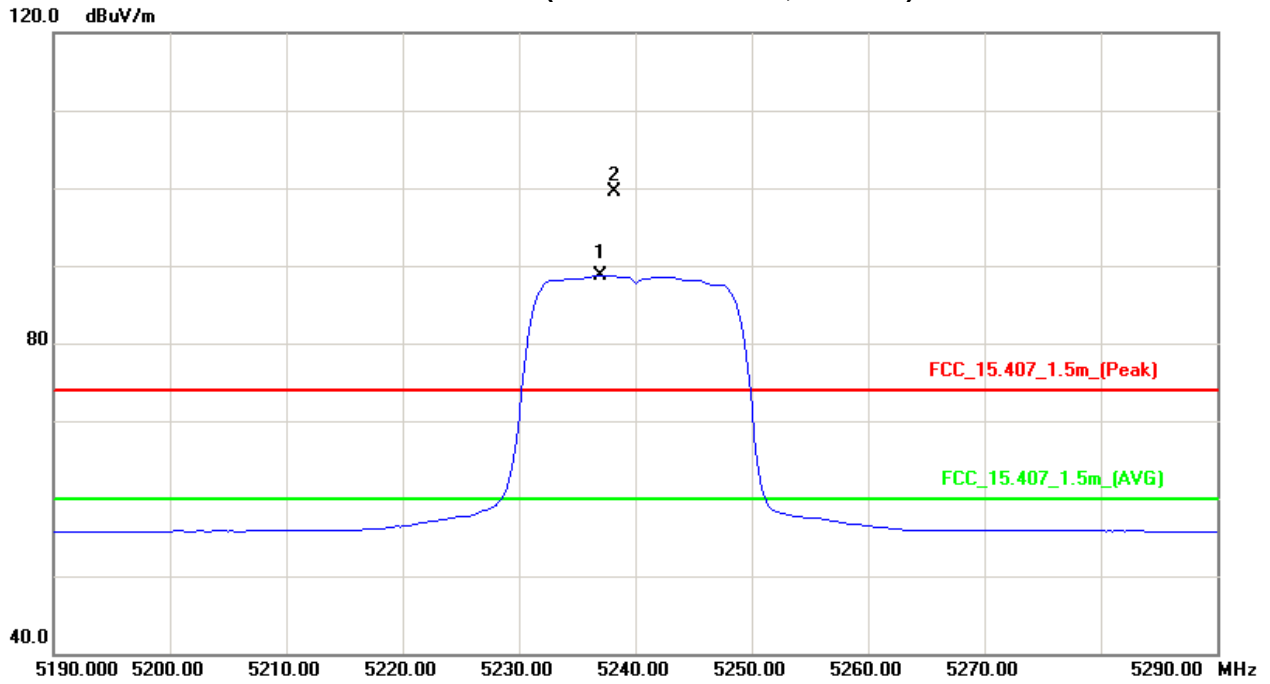



EUT :	300Mbps Wireless Dual Band USB Adapter	Model Name :	WF2150
Temperature :	25 °C	Relative Humidity :	52 %
Test Voltage :	AC 120V/60Hz		
Test Mode :	Band 1/ TX N20 Mode 5240MHz		

Freq. (MHz)	Ant.Pol. H/V	Reading		Ant./CF CF(dB)	Act.		Limit		Note
		Peak (dBuV)	AV (dBuV)		Peak (dBuV/m)	AV (dBuV/m)	Peak (dBuV/m)	AV (dBuV/m)	
5235.75	H	56.47	45.44	40.31	96.78	85.75			X/F
# 10480.52	H	45.28	31.47	13.87	59.15	45.34	74.30	60.00	X/H

Remark :

- (1) Spectrum Setting : 30MHz – 1000MHz , RBW= 100KHz, VBW=100KHz, Sweep time = 200 ms. 1GHz- 40GHz, RBW= 1MHz, VBW= 1MHz, Sweep time = Auto
- (2) All readings are Peak unless otherwise stated AV in column of 『Note』 . Peak denotes that the Peak reading compliance with the AV Limits and then AV Mode measurement didn't perform.
- (3) Measuring frequency range from 30MHz to 1000MHz or the 10th harmonic of highest fundamental frequency. "F" denotes fundamental frequency; "H" denotes spurious frequency. "E" denotes band edge frequency. (This judgment method includes the Band Edge Requirement.)
- (4) Radiated emissions measured in frequency range above 1000MHz were made with an instrument using Peak detector mode and AV detector mode of the emission .
- (5) Data of measurement within this frequency range shown " * " in the table above means the reading of emissions are attenuated more than 20dB below the permissible limits or the field strength is too small to be measured.
- (6) A preamp and high pass filter were used for this test in order to provide sufficient measurement sensitivity.
- (7) EUT Orthogonal Axes :
 "X" - denotes Laid on Table ; "Y" - denotes Vertical Stand ; "Z" - denotes Side Stand
- (8) During the measurements above 1GHz it is taken care of that the EUT is always within the 3dB cone of radiation BW of the used antenna.
- (9) The limits above 5GHz shall be extrapolated to the specified distance using an extrapolation factor of 20dB/decade form 3m to 1.5m
 Distance extrapolation factor = $20 \log (3m/1.5m)$ dB ;
 Limit line = specific limits (dBuV) + 6 dB
- (10) "#" The radiated frequency is out of the restricted band.



Orthogonal Axis : X
Band 1/CH48(Above 1000 MHz, Horizontal)

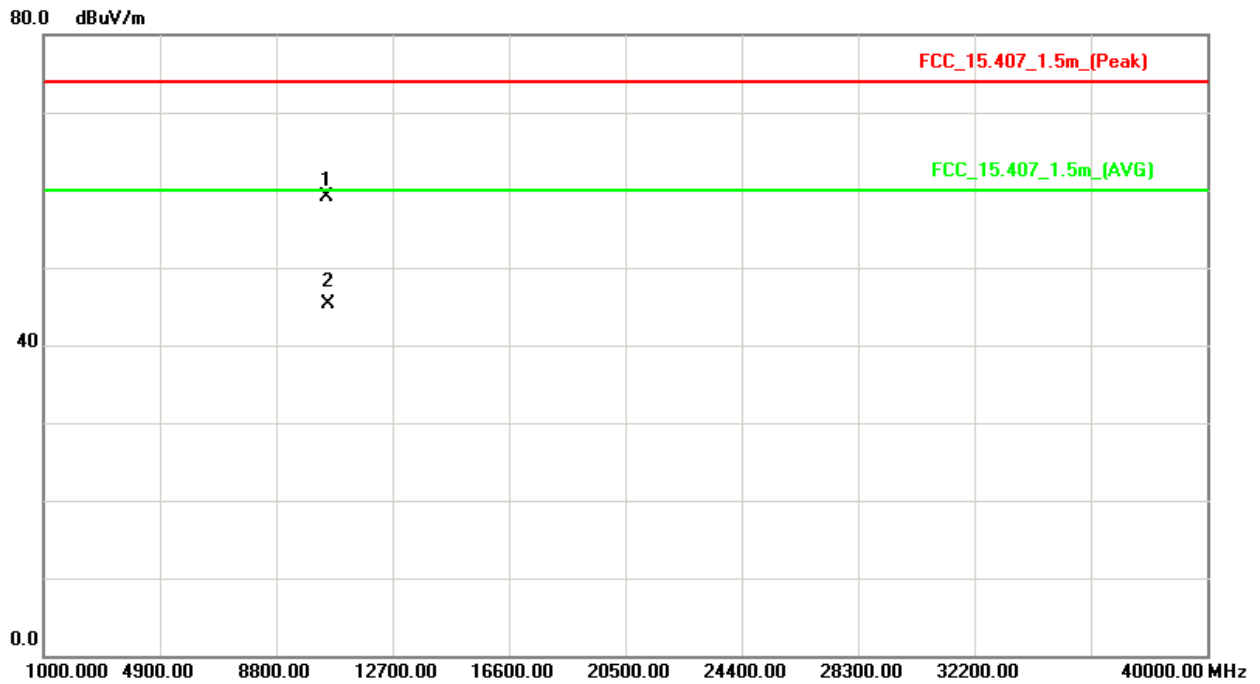
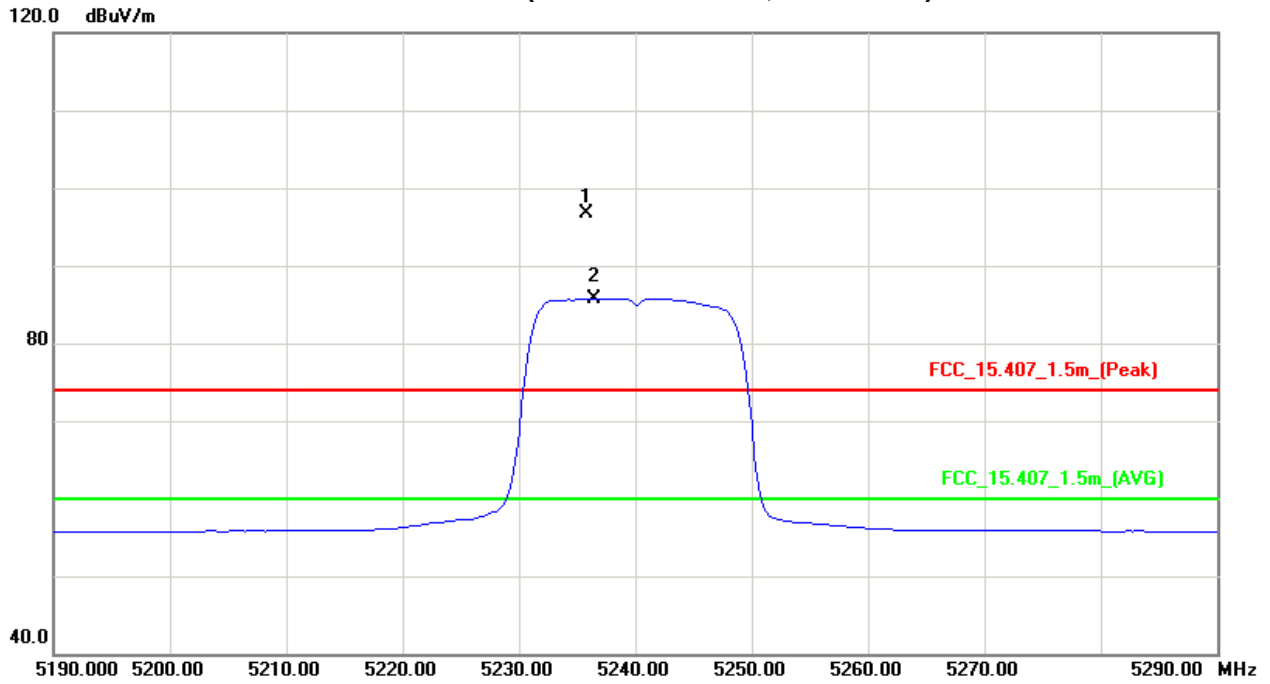



EUT :	300Mbps Wireless Dual Band USB Adapter	Model Name :	WF2150
Temperature :	25 °C	Relative Humidity :	58 %
Test Voltage :	AC 120V/60Hz		
Test Mode :	Band 1/ TX N40 Mode 5190MHz		

Freq. (MHz)	Ant.Pol. H/V	Reading		Ant./CF CF(dB)	Act.		Limit		Note
		Peak (dBuV)	AV (dBuV)		Peak (dBuV/m)	AV (dBuV/m)	Peak (dBuV/m)	AV (dBuV/m)	
5150.00	V	27.63	15.51	40.09	67.72	55.60	74.30	60.00	X/F
5186.00	V	55.59	45.01	40.18	95.77	85.19			X/E
# 10380.14	V	46.15	33.24	13.76	59.91	47.00	74.30	60.00	X/H

Remark :

- (1) Spectrum Setting : 30MHz – 1000MHz , RBW= 100KHz, VBW=100KHz, Sweep time = 200 ms. 1GHz- 40GHz, RBW= 1MHz, VBW= 1MHz, Sweep time = Auto
- (2) All readings are Peak unless otherwise stated AV in column of 『Note』 . Peak denotes that the Peak reading compliance with the AV Limits and then AV Mode measurement didn't perform.
- (3) Measuring frequency range from 30MHz to 1000MHz or the 10th harmonic of highest fundamental frequency.“F” denotes fundamental frequency; “H” denotes spurious frequency. “E” denotes band edge frequency. (This judgment method includes the Band Edge Requirement.)
- (4) Radiated emissions measured in frequency range above 1000MHz were made with an instrument using Peak detector mode and AV detector mode of the emission .
- (5) Data of measurement within this frequency range shown “ * ” in the table above means the reading of emissions are attenuated more than 20dB below the permissible limits or the field strength is too small to be measured.
- (6) A preamp and high pass filter were used for this test in order to provide sufficient measurement sensitivity.
- (7) EUT Orthogonal Axes :
“X” - denotes Laid on Table ; “Y” - denotes Vertical Stand ; “Z” - denotes Side Stand
- (8) During the measurements above 1GHz it is taken care of that the EUT is always within the 3dB cone of radiation BW of the used antenna.
- (9) The limits above 5GHz shall be extrapolated to the specified distance using an extrapolation factor of 20dB/decade form 3m to 1.5m
Distance extrapolation factor = 20 log (3m/1.5m) dB ;
Limit line = specific limits (dBuV) + 6 dB
- (10) “#” The radiated frequency is out of the restricted band.



Orthogonal Axis : X
Band 1/CH38(Above 1000 MHz, Vertical)

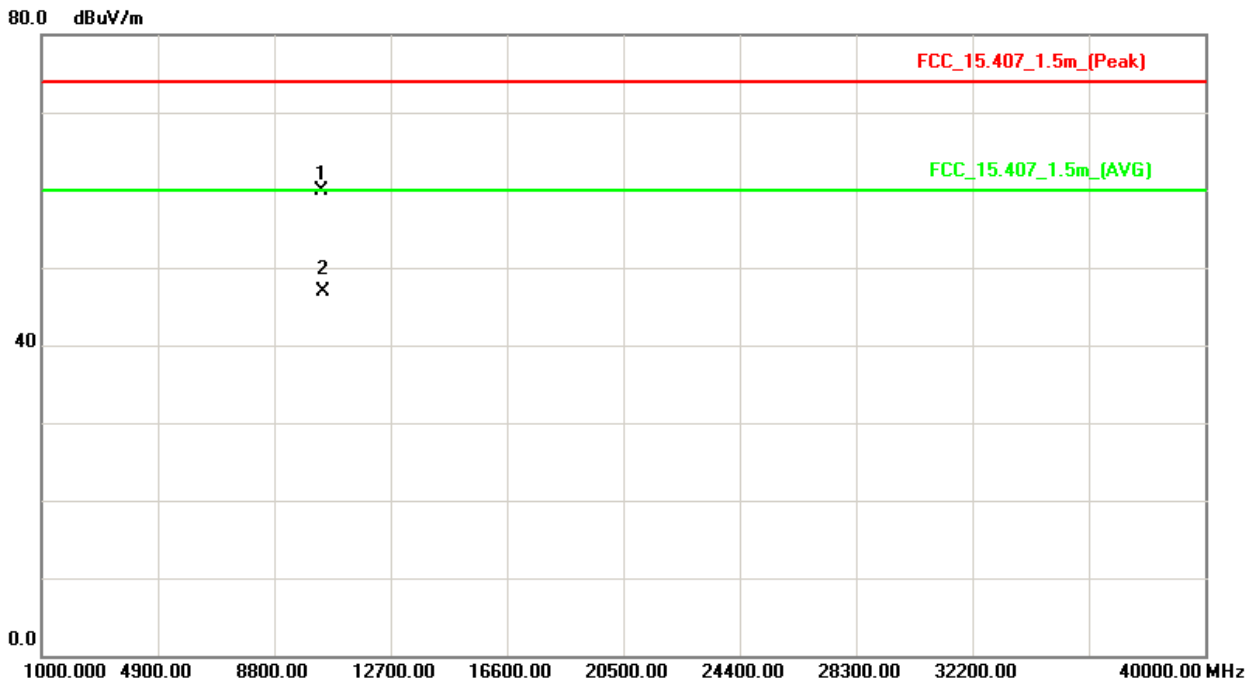
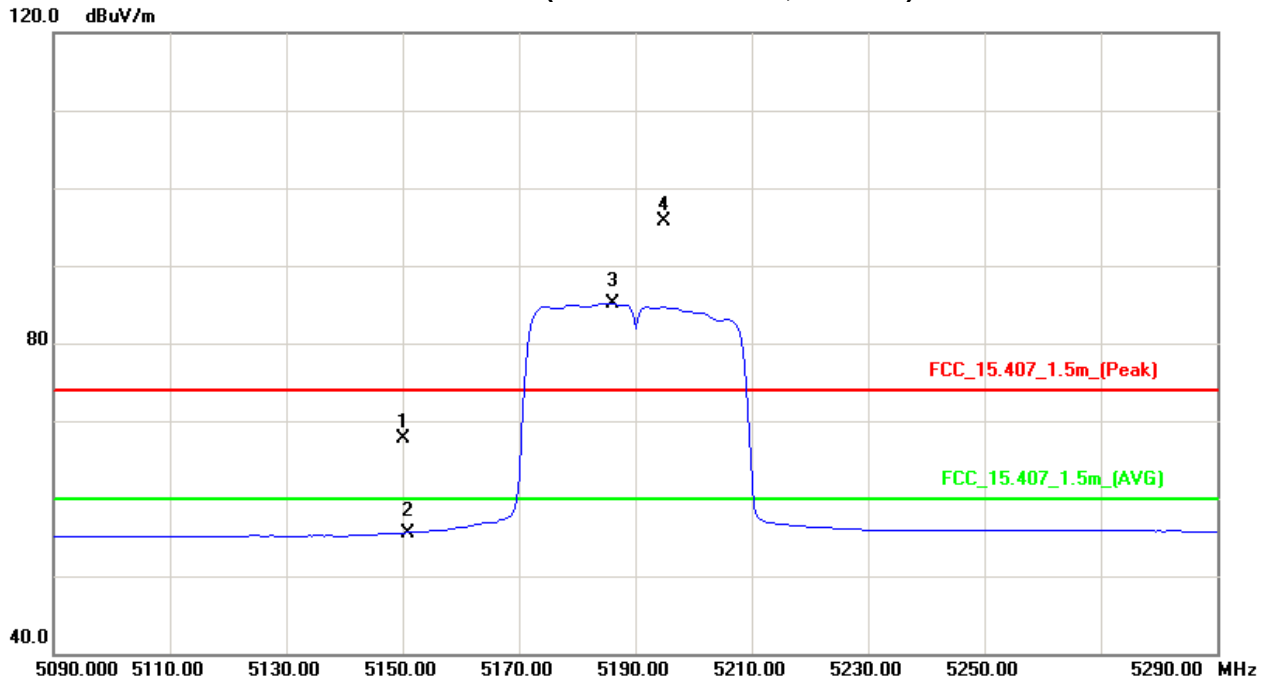



EUT :	300Mbps Wireless Dual Band USB Adapter	Model Name :	WF2150
Temperature :	25 °C	Relative Humidity :	58 %
Test Voltage :	AC 120V/60Hz		
Test Mode :	Band 1/ TX N40 Mode 5190MHz		

Freq. (MHz)	Ant.Pol. H/V	Reading		Ant./CF CF(dB)	Act.		Limit		Note
		Peak (dBuV)	AV (dBuV)		Peak (dBuV/m)	AV (dBuV/m)	Peak (dBuV/m)	AV (dBuV/m)	
5150.00	H	27.99	15.40	40.09	68.08	55.49	74.30	60.00	X/E
5179.00	H	53.97	44.07	40.16	94.13	84.23			X/F
# 10380.59	H	43.68	31.15	13.76	57.44	44.91	74.30	60.00	X/H

Remark :

- (1) Spectrum Setting : 30MHz – 1000MHz , RBW= 100KHz, VBW=100KHz, Sweep time = 200 ms. 1GHz- 40GHz, RBW= 1MHz, VBW= 1MHz, Sweep time = Auto
- (2) All readings are Peak unless otherwise stated AV in column of 『Note』 . Peak denotes that the Peak reading compliance with the AV Limits and then AV Mode measurement didn't perform.
- (3) Measuring frequency range from 30MHz to 1000MHz or the 10th harmonic of highest fundamental frequency. "F" denotes fundamental frequency; "H" denotes spurious frequency. "E" denotes band edge frequency. (This judgment method includes the Band Edge Requirement.)
- (4) Radiated emissions measured in frequency range above 1000MHz were made with an instrument using Peak detector mode and AV detector mode of the emission .
- (5) Data of measurement within this frequency range shown " * " in the table above means the reading of emissions are attenuated more than 20dB below the permissible limits or the field strength is too small to be measured.
- (6) A preamp and high pass filter were used for this test in order to provide sufficient measurement sensitivity.
- (7) EUT Orthogonal Axes :
"X" - denotes Laid on Table ; "Y" - denotes Vertical Stand ; "Z" - denotes Side Stand
- (8) During the measurements above 1GHz it is taken care of that the EUT is always within the 3dB cone of radiation BW of the used antenna.
- (9) The limits above 5GHz shall be extrapolated to the specified distance using an extrapolation factor of 20dB/decade form 3m to 1.5m
Distance extrapolation factor = 20 log (3m/1.5m) dB ;
Limit line = specific limits (dBuV) + 6 dB
- (10) "#" The radiated frequency is out of the restricted band.



Orthogonal Axis : X
Band 1/CH38(Above 1000 MHz, Horizontal)

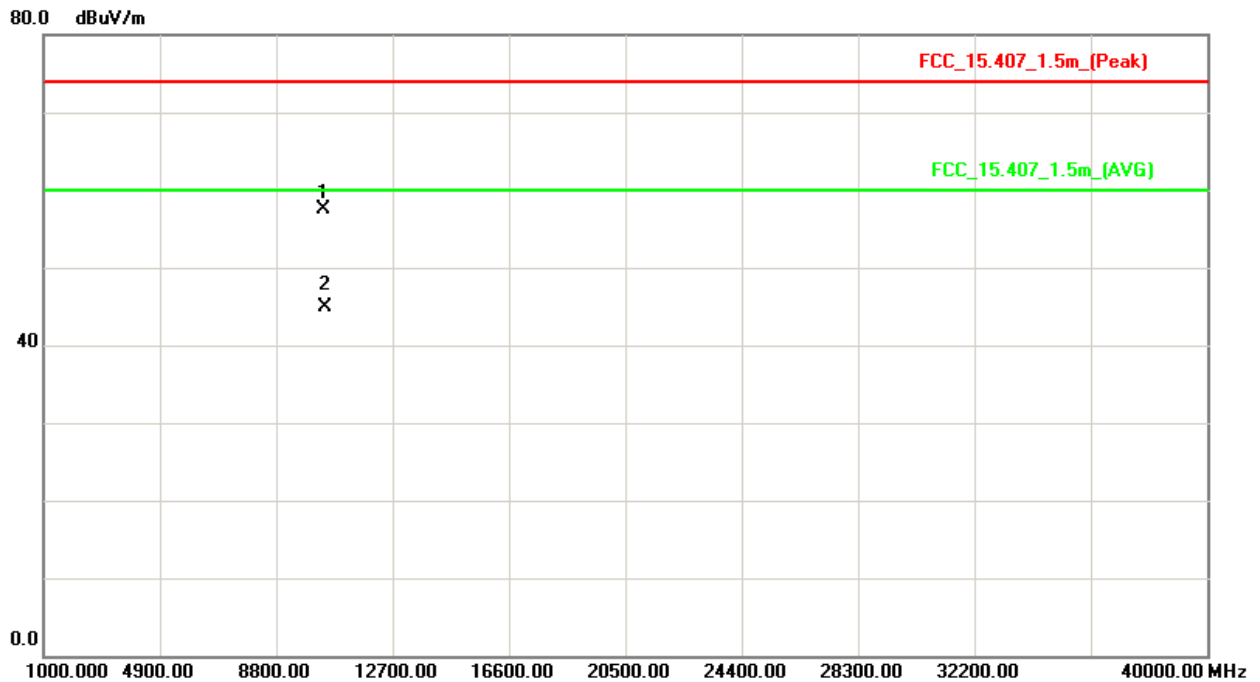
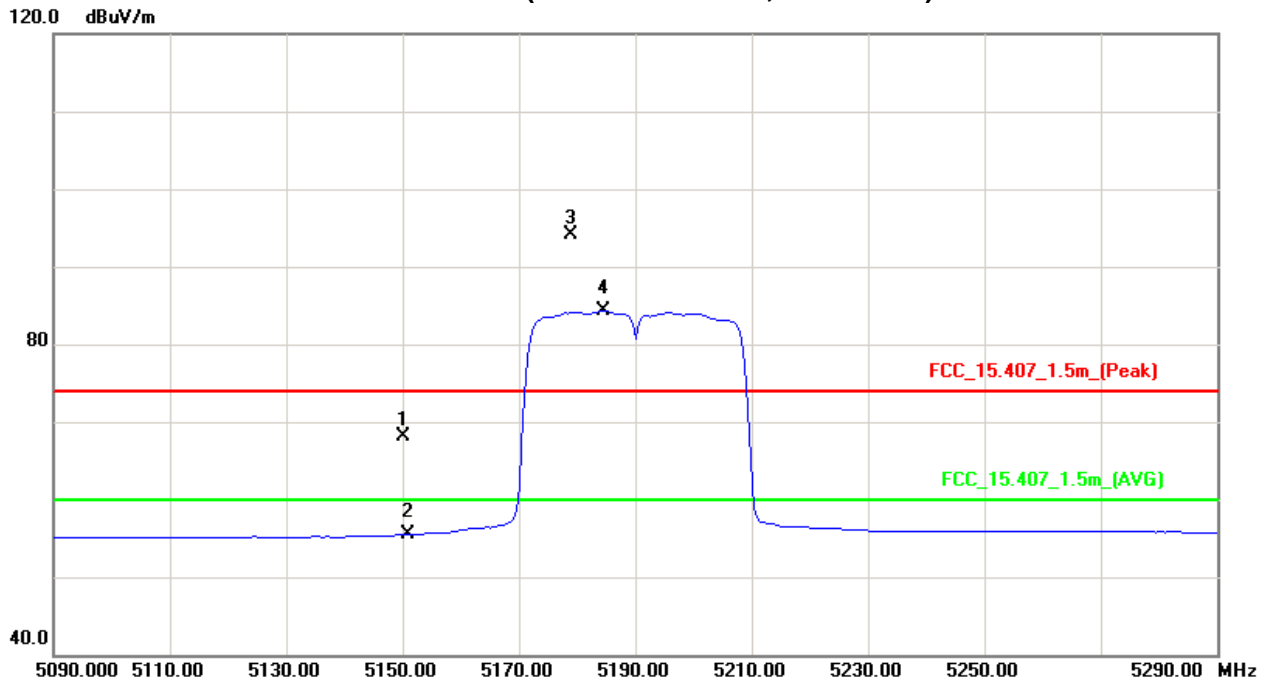



EUT :	300Mbps Wireless Dual Band USB Adapter	Model Name :	WF2150
Temperature :	25 °C	Relative Humidity :	52 %
Test Voltage :	AC 120V/60Hz		
Test Mode :	Band 1/ TX N40 Mode 5230MHz		

Freq. (MHz)	Ant.Pol. H/V	Reading		Ant./CF CF(dB)	Act.		Limit		Note
		Peak (dBuV)	AV (dBuV)		Peak (dBuV/m)	AV (dBuV/m)	Peak (dBuV/m)	AV (dBuV/m)	
5218.50	V	57.49	46.84	40.26	97.75	87.10			X/F
# 10460.47	V	45.68	33.56	13.85	59.53	47.41	74.30	60.00	X/H

Remark :

- (1) Spectrum Setting : 30MHz – 1000MHz , RBW= 100KHz, VBW=100KHz, Sweep time = 200 ms. 1GHz- 40GHz, RBW= 1MHz, VBW= 1MHz, Sweep time = Auto
- (2) All readings are Peak unless otherwise stated AV in column of 『Note』 . Peak denotes that the Peak reading compliance with the AV Limits and then AV Mode measurement didn't perform.
- (3) Measuring frequency range from 30MHz to 1000MHz or the 10th harmonic of highest fundamental frequency. "F" denotes fundamental frequency; "H" denotes spurious frequency. "E" denotes band edge frequency. (This judgment method includes the Band Edge Requirement.)
- (4) Radiated emissions measured in frequency range above 1000MHz were made with an instrument using Peak detector mode and AV detector mode of the emission .
- (5) Data of measurement within this frequency range shown " * " in the table above means the reading of emissions are attenuated more than 20dB below the permissible limits or the field strength is too small to be measured.
- (6) A preamp and high pass filter were used for this test in order to provide sufficient measurement sensitivity.
- (7) EUT Orthogonal Axes :
 "X" - denotes Laid on Table ; "Y" - denotes Vertical Stand ; "Z" - denotes Side Stand
- (8) During the measurements above 1GHz it is taken care of that the EUT is always within the 3dB cone of radiation BW of the used antenna.
- (9) The limits above 5GHz shall be extrapolated to the specified distance using an extrapolation factor of 20dB/decade form 3m to 1.5m
 Distance extrapolation factor = 20 log (3m/1.5m) dB ;
 Limit line = specific limits (dBuV) + 6 dB
- (10) "#" The radiated frequency is out of the restricted band.



Orthogonal Axis : X
Band 1/CH46(Above 1000 MHz, Vertical)

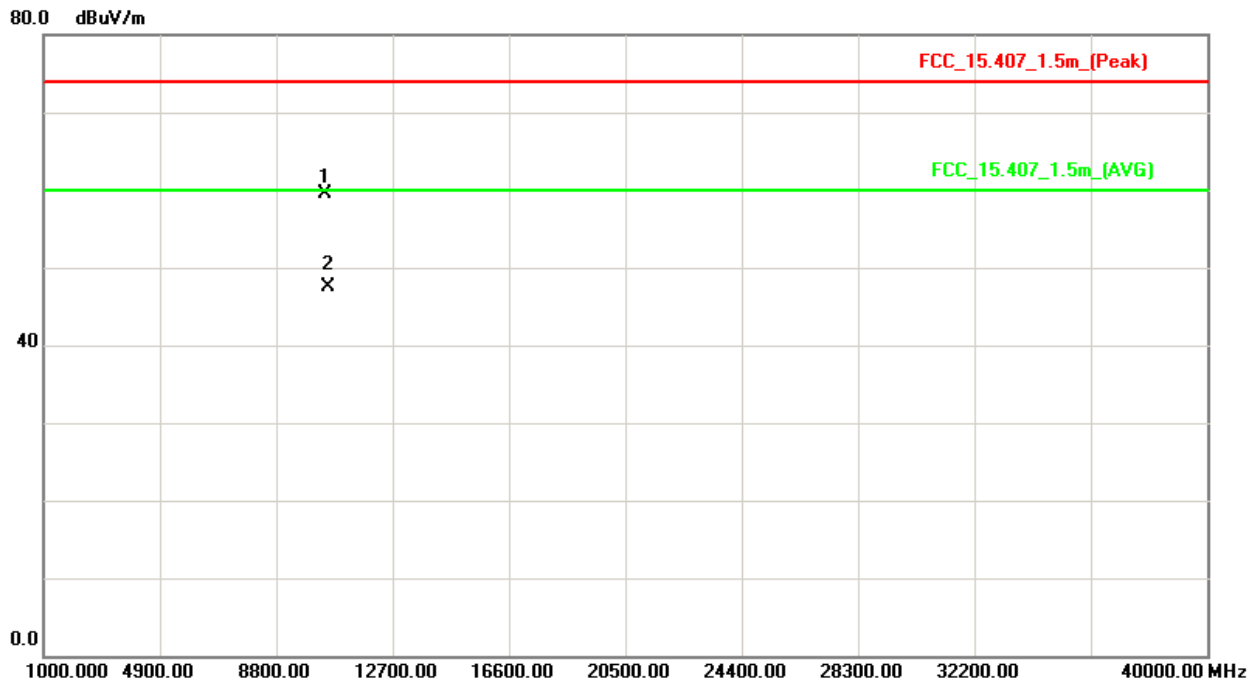
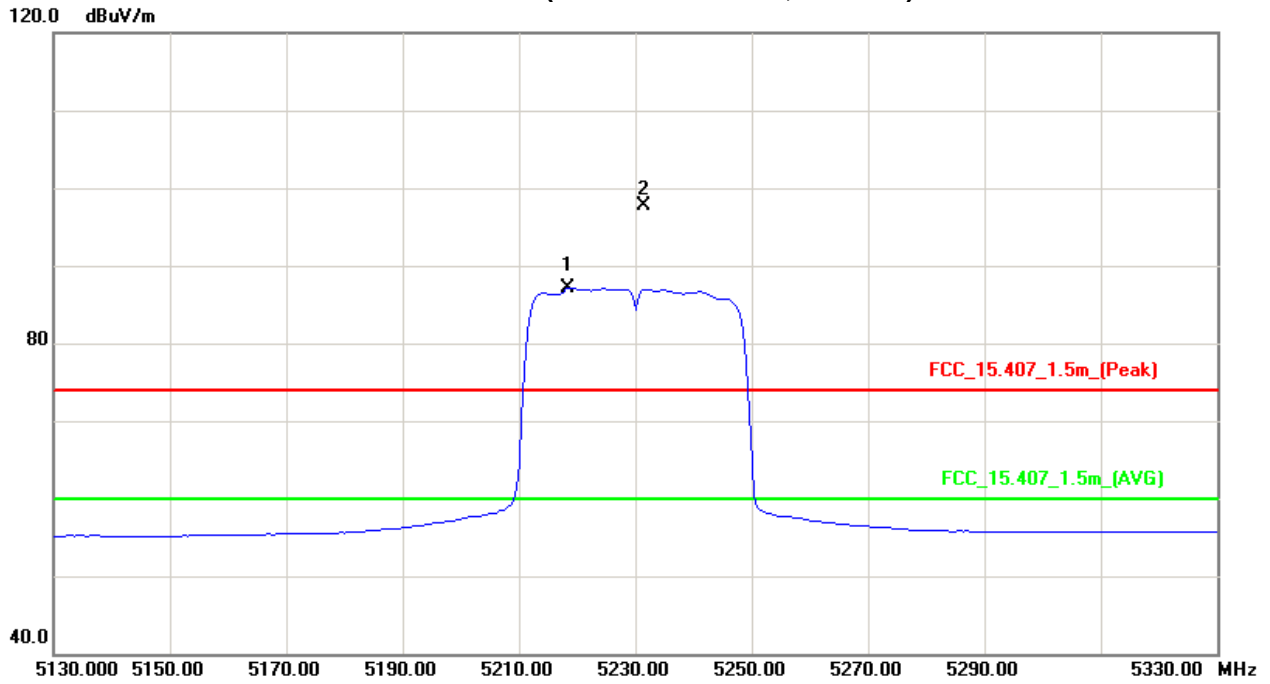



EUT :	300Mbps Wireless Dual Band USB Adapter	Model Name :	WF2150
Temperature :	25 °C	Relative Humidity :	52 %
Test Voltage :	AC 120V/60Hz		
Test Mode :	Band 1/ TX N40 Mode 5230MHz		

Freq. (MHz)	Ant.Pol. H/V	Reading		Ant./CF CF(dB)	Act.		Limit		Note
		Peak (dBuV)	AV (dBuV)		Peak (dBuV/m)	AV (dBuV/m)	Peak (dBuV/m)	AV (dBuV/m)	
5218.00	H	55.21	43.26	40.26	95.47	83.52			X/F
# 10460.64	H	44.95	32.39	13.85	58.80	46.24	74.30	60.00	X/H

Remark :

- (1) Spectrum Setting : 30MHz – 1000MHz , RBW= 100KHz, VBW=100KHz, Sweep time = 200 ms. 1GHz- 40GHz, RBW= 1MHz, VBW= 1MHz, Sweep time = Auto
- (2) All readings are Peak unless otherwise stated AV in column of 『Note』 . Peak denotes that the Peak reading compliance with the AV Limits and then AV Mode measurement didn't perform.
- (3) Measuring frequency range from 30MHz to 1000MHz or the 10th harmonic of highest fundamental frequency. "F" denotes fundamental frequency; "H" denotes spurious frequency. "E" denotes band edge frequency. (This judgment method includes the Band Edge Requirement.)
- (4) Radiated emissions measured in frequency range above 1000MHz were made with an instrument using Peak detector mode and AV detector mode of the emission .
- (5) Data of measurement within this frequency range shown " * " in the table above means the reading of emissions are attenuated more than 20dB below the permissible limits or the field strength is too small to be measured.
- (6) A preamp and high pass filter were used for this test in order to provide sufficient measurement sensitivity.
- (7) EUT Orthogonal Axes :
 "X" - denotes Laid on Table ; "Y" - denotes Vertical Stand ; "Z" - denotes Side Stand
- (8) During the measurements above 1GHz it is taken care of that the EUT is always within the 3dB cone of radiation BW of the used antenna.
- (9) The limits above 5GHz shall be extrapolated to the specified distance using an extrapolation factor of 20dB/decade form 3m to 1.5m
 Distance extrapolation factor = $20 \log (3m/1.5m)$ dB ;
 Limit line = specific limits (dBuV) + 6 dB
- (10) "#" The radiated frequency is out of the restricted band.



Orthogonal Axis : X
Band 1/CH46(Above 1000 MHz, Horizontal)

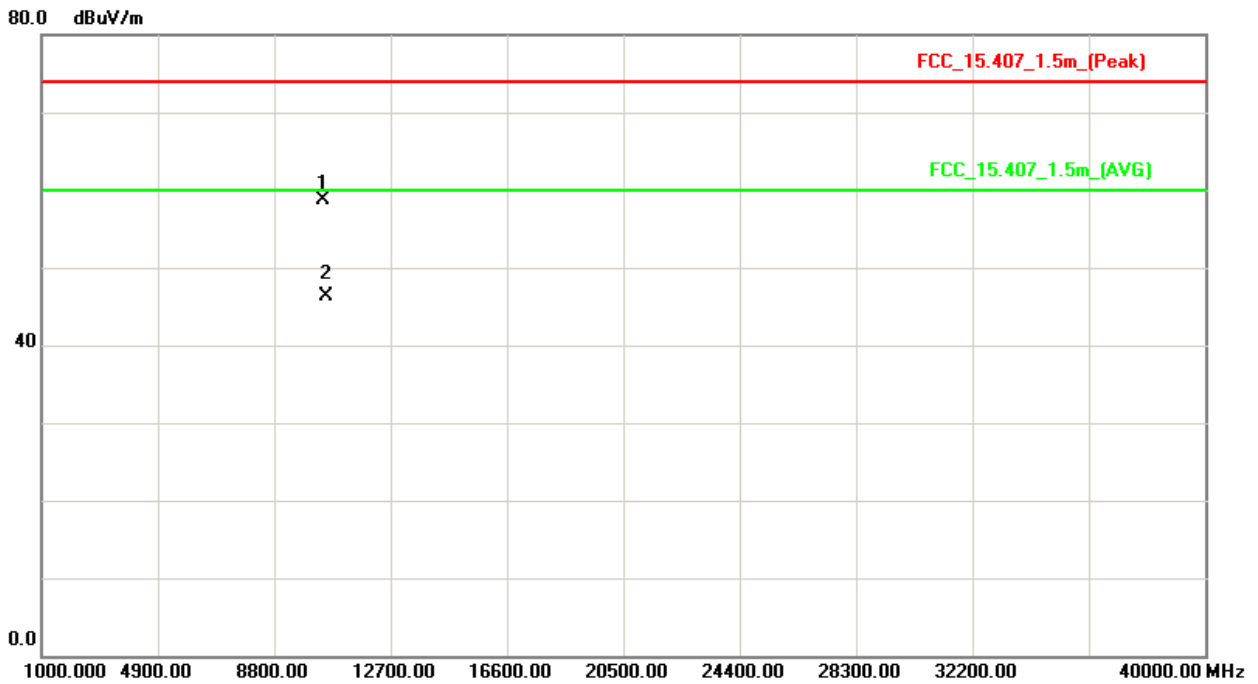
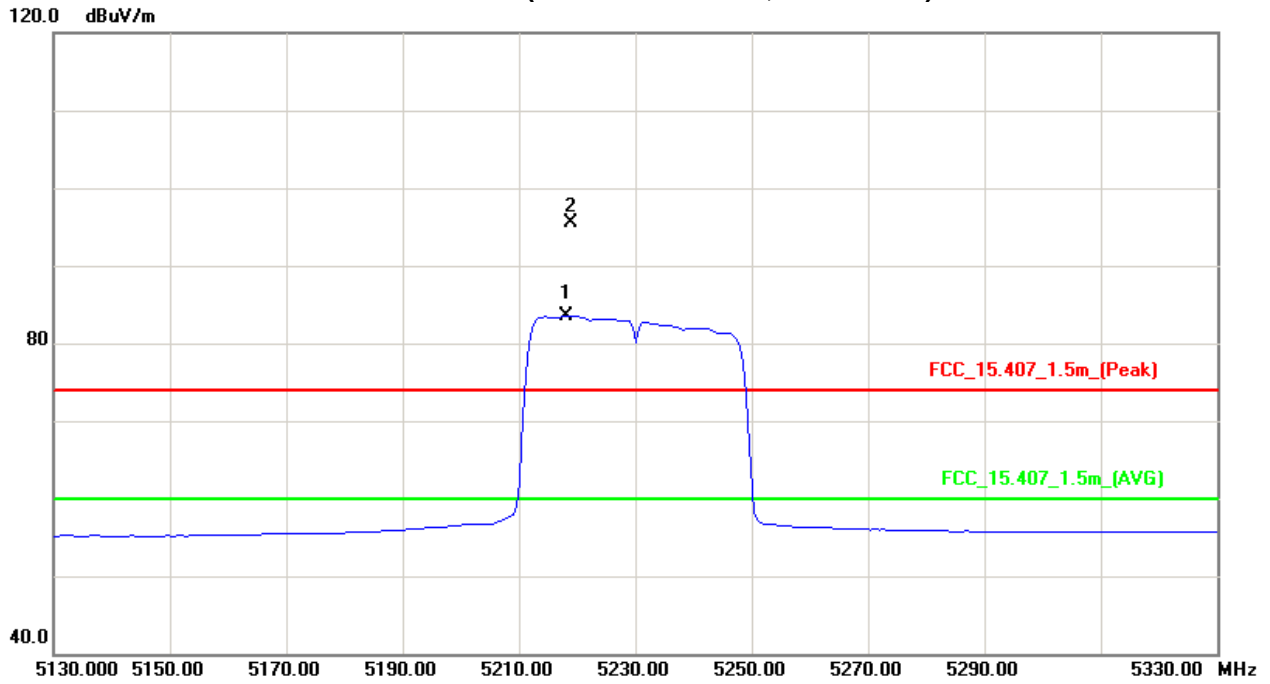



5. 26dB SPECTRUM BANDWIDTH

5.1 APPLIED PROCEDURES / LIMIT

FCC Part15, Subpart E			
Test Item	Limit	Frequency Range (MHz)	Result
26 dB Bandwidth	-----	5150MHz~5250	PASS

5.1.1 MEASUREMENT INSTRUMENTS LIST

Item	Kind of Equipment	Manufacturer	Type No.	Serial No.	Last Calibration	Next Calibration
1	Spectrum Analyzer	R&S	FSP_40	100129	Nov.25.2012	Nov.16.2013

Remark: "N/A" denotes no model name, serial no. or calibration specified.
 All calibration period of Equipment List is One Year.

5.1.2 TEST PROCEDURE

a. The EUT was directly connected to the spectrum analyzer and antenna output port as show in the block diagram below,

b.

Spectrum Parameters	Setting
Attenuation	Auto
Span Frequency	> 26dB Bandwidth
RB	300 kHz
VB	1000 kHz
Detector	Peak
Trace	Max Hold
Sweep Time	Auto

c. Measured the spectrum width with power higher than 26dB below carrier

5.1.3 DEVIATION FROM STANDARD

No deviation.

5.1.4 TEST SETUP





5.1.5 EUT OPERATION CONDITIONS

The EUT tested system was configured as the statements of 4.1.6 Unless otherwise a special operating condition is specified in the follows during the testing.



5.1.6 TEST RESULTS

EUT :	300Mbps Wireless Dual Band USB Adapter	Model Name :	WF2150
Temperature :	25 °C	Relative Humidity :	58 %
Test Voltage :	AC 120V/60Hz		
Test Mode :	Band 1/TX A Mode /CH36, CH40, CH48		

Channel	Frequency (MHz)	26dB Bandwidth (MHz)	99% Occupied Bandwidth (MHz)
CH36	5180	19.70	16.70
CH40	5210	21.40	16.80
CH48	5240	21.30	16.70

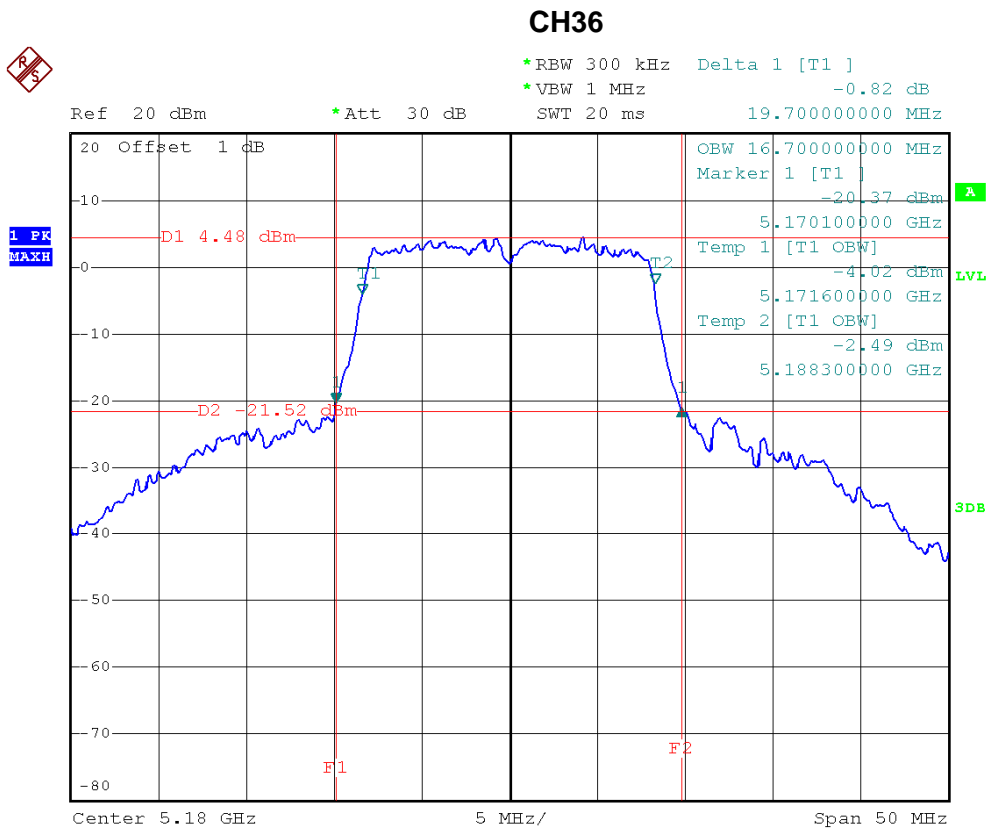

Date: 7.DEC.2012 12:48:13



CH40

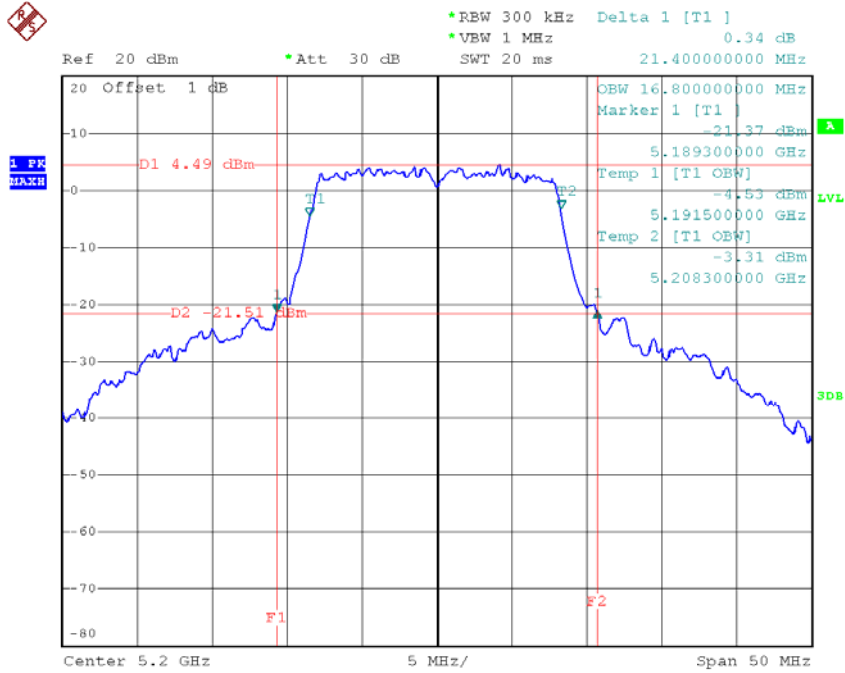

Date: 7.DEC.2012 12:51:03

CH48

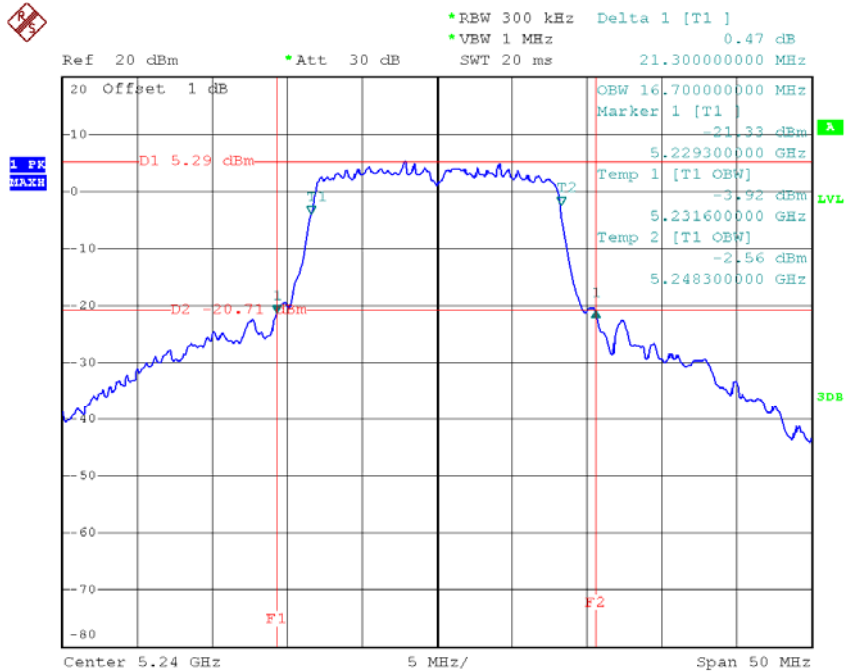

Date: 7.DEC.2012 12:53:21



EUT :	300Mbps Wireless Dual Band USB Adapter	Model Name :	WF2150
Temperature :	25 °C	Relative Humidity :	58 %
Test Voltage :	AC 120V/60Hz		
Test Mode :	Band 1/TXN20 Mode /CH36, CH40, CH48		

Channel	Frequency (MHz)	26dB Bandwidth (MHz)	99% Occupied Bandwidth (MHz)
CH36	5180	20.30	17.60
CH40	5210	20.30	17.60
CH48	5240	20.20	17.60

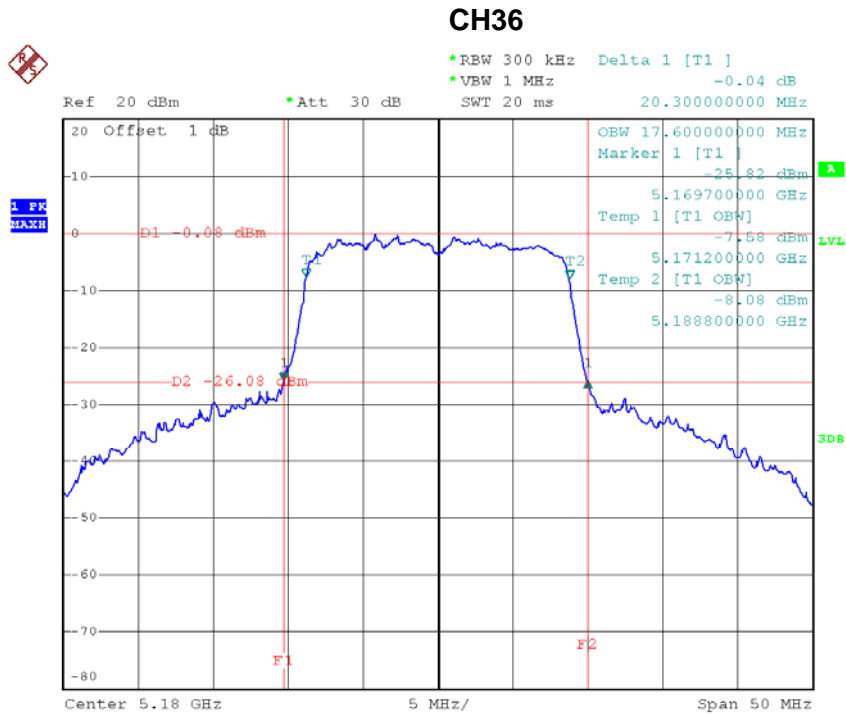

Date: 7.DEC.2012 13:39:15



CH40

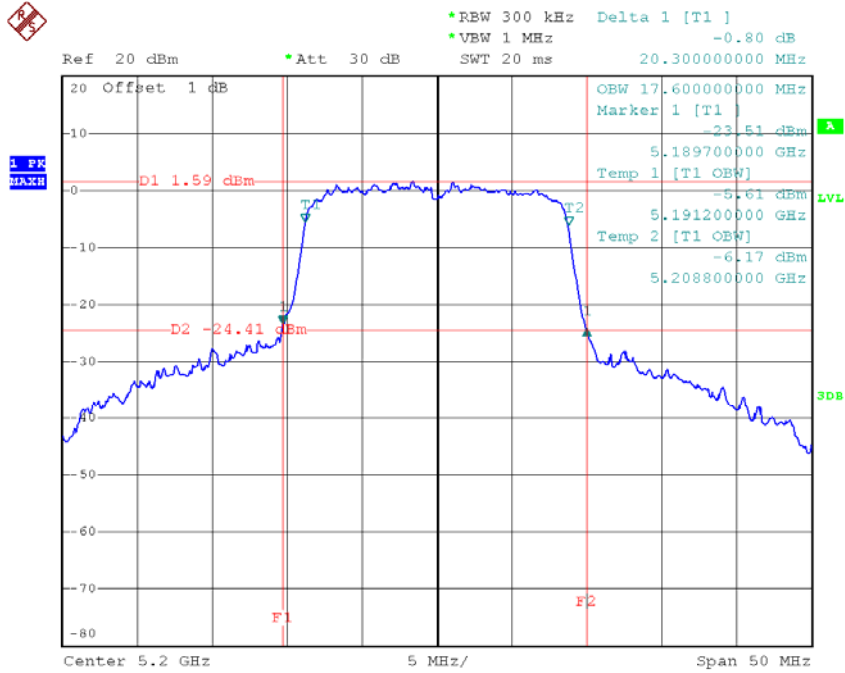

Date: 7.DEC.2012 13:10:53

CH48

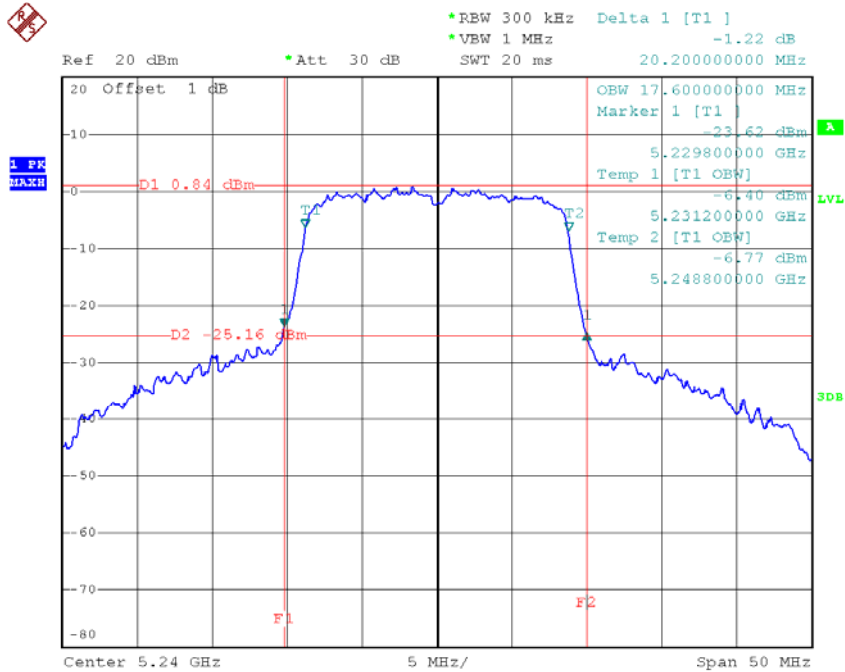

Date: 7.DEC.2012 13:11:52



EUT :	300Mbps Wireless Dual Band USB Adapter	Model Name :	WF2150
Temperature :	25 °C	Relative Humidity :	58 %
Test Voltage :	AC 120V/60Hz		
Test Mode :	Band 1/TXN40 Mode /CH38, CH46		

Channel	Frequency (MHz)	26dB Bandwidth (MHz)	99% Occupied Bandwidth (MHz)
CH38	5190	40.20	36.20
CH46	5230	40.20	36.00

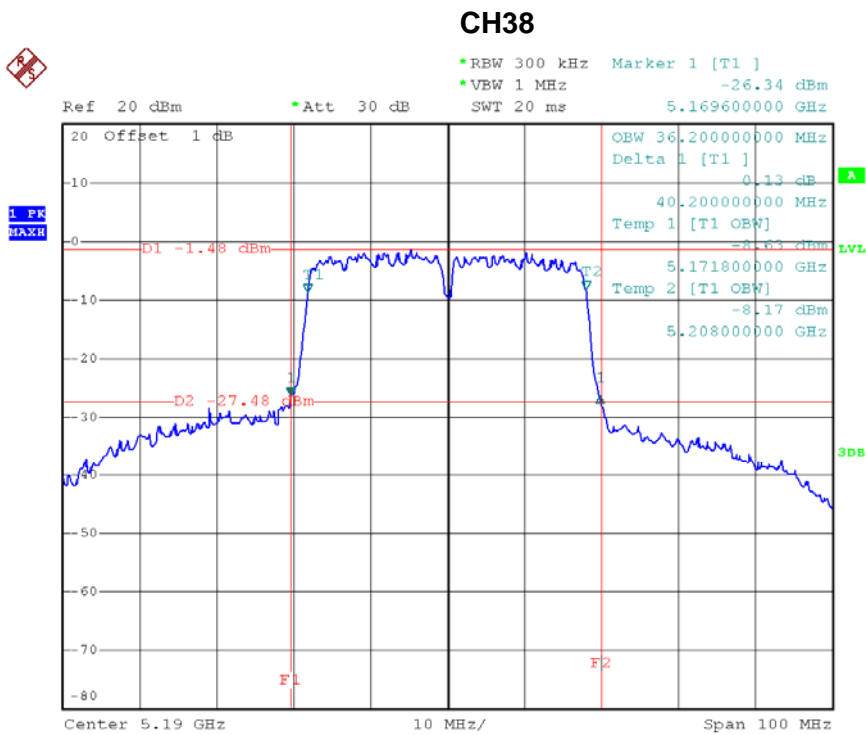

Date: 7.DEC.2012 13:19:31



CH46

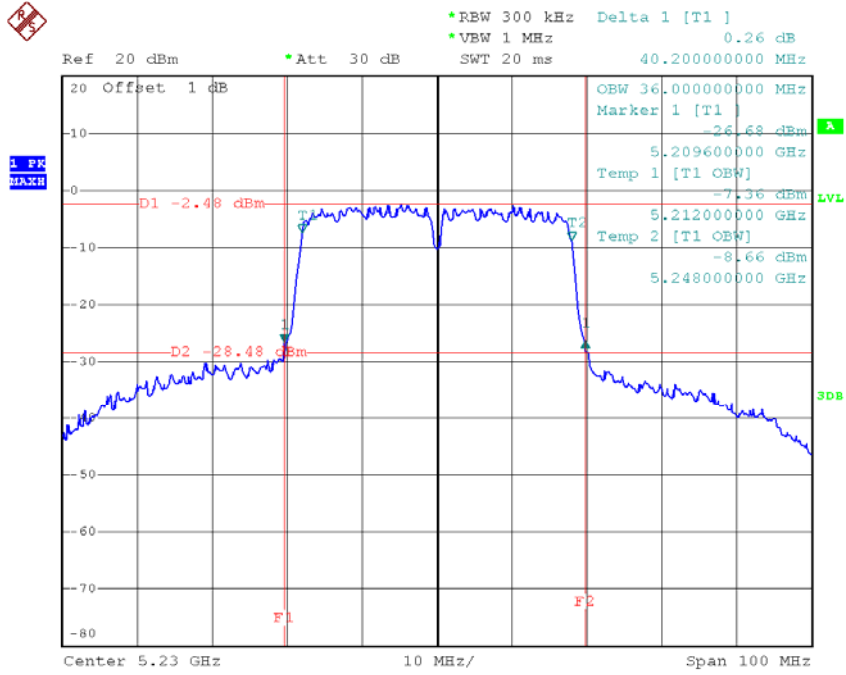

Date: 7.DEC.2012 13:20:50



6. MAXIMUM CONDUCTED OUTPUT POWER

6.1 APPLIED PROCEDURES / LIMIT

FCC Part15, Subpart E			
Test Item	Frequency Range (MHz)	Limit	Result
Peak Output Power	5150 - 5250	not exceed the lesser of 50 mW (17dBm) or 4 dBm + 10log B,	PASS

Note: where “B” is the 26 dB emissions bandwidth in MHz.

6.1.1 MEASUREMENT INSTRUMENTS LIST

Item	Kind of Equipment	Manufacturer	Type No.	Serial No.	Last Calibration	Next Calibration
1	Spectrum Analyzer	R&S	FSP_40	100129	Nov.25.2012	Nov.16.2013

Remark: “N/A” denotes no model name, serial no. or calibration specified.
All calibration period of Equipment List is One Year.

6.1.2 TEST PROCEDURE

- a. The EUT was directly connected to the spectrum analyzer and antenna output port as show in the block diagram below,
- b.

Spectrum Parameter	Setting
Attenuation	Auto
Span Frequency	Encompass the entire emissions bandwidth (EBW) of the signal
RB	1000 kHz
VB	3000 kHz (>/1/T) T:Transmission Pluse
Detector	Sample
Trace	Max Hold
Sweep Time	60s

- b. Test was performed in accordance with method #3 of FCC Public Notice DA-02-2138.



6.1.3 DEVIATION FROM STANDARD

No deviation.

6.1.4 TEST SETUP



6.1.5 EUT OPERATION CONDITIONS

The EUT tested system was configured as the statements of 4.1.6 Unless otherwise a special operating condition is specified in the follows during the testing.



6.1.6 TEST RESULTS

EUT :	300Mbps Wireless Dual Band USB Adapter	Model Name :	WF2150
Temperature :	25 °C	Relative Humidity :	58 %
Test Voltage :	AC 120V/60Hz		
Test Mode :	Band 1/TX A Mode/CH36, CH40, CH48		

Test Channel	Frequency (MHz)	Average Output Power (dBm)	LIMIT (dBm)	LIMIT (W)
CH36	5180	9.97	17.00	0.0501
CH40	5200	9.81	17.00	0.0501
CH48	5240	9.68	17.00	0.0501



EUT :	300Mbps Wireless Dual Band USB Adapter	Model Name :	WF2150
Temperature :	25 °C	Relative Humidity :	58 %
Test Voltage :	AC 120V/60Hz		
Test Mode :	Band 1/TX N20 Mode/CH36, CH40, CH48-ANT 1		

Test Channel	Frequency (MHz)	Average Output Power (dBm)	LIMIT (dBm)	LIMIT (W)
CH36	5180	6.98	17.00	0.0501
CH40	5200	6.92	17.00	0.0501
CH48	5240	6.55	17.00	0.0501

EUT :	300Mbps Wireless Dual Band USB Adapter	Model Name :	WF2150
Temperature :	25 °C	Relative Humidity :	58 %
Test Voltage :	AC 120V/60Hz		
Test Mode :	Band 1/TX N20 Mode/CH36, CH40, CH48-ANT 2		

Test Channel	Frequency (MHz)	Average Output Power (dBm)	LIMIT (dBm)	LIMIT (W)
CH36	5180	6.60	17.00	0.0501
CH40	5200	6.91	17.00	0.0501
CH48	5240	6.61	17.00	0.0501

EUT :	300Mbps Wireless Dual Band USB Adapter	Model Name :	WF2150
Temperature :	25 °C	Relative Humidity :	58 %
Pressure :	1010 hPa	Test Voltage :	AC 120V/60Hz
Test Mode :	Band 1/ TX N20 Mode /CH36, CH40, CH48 -ANT1+ANT2		

Test Channel	Frequency (MHz)	Average Output Power (dBm)	LIMIT (dBm)	LIMIT (W)
CH36	5180 MHz	9.80	17.00	0.0501
CH40	5200 MHz	9.93	17.00	0.0501
CH48	5240 MHz	9.59	17.00	0.0501



EUT :	300Mbps Wireless Dual Band USB Adapter	Model Name :	WF2150
Temperature :	25 °C	Relative Humidity :	58 %
Test Voltage :	AC 120V/60Hz		
Test Mode :	Band 1/TX N40 Mode/CH36, CH40, CH48-ANT 1		

Test Channel	Frequency (MHz)	Average Output Power (dBm)	LIMIT (dBm)	LIMIT (W)
CH38	5190	6.83	17.00	0.0501
CH46	5230	6.58	17.00	0.0501

EUT :	300Mbps Wireless Dual Band USB Adapter	Model Name :	WF2150
Temperature :	25 °C	Relative Humidity :	58 %
Test Voltage :	AC 120V/60Hz		
Test Mode :	Band 1/TX N40 Mode/CH36, CH40, CH48-ANT 2		

Test Channel	Frequency (MHz)	Average Output Power (dBm)	LIMIT (dBm)	LIMIT (W)
CH38	5190	6.96	17.00	0.0501
CH46	5230	6.81	17.00	0.0501

EUT :	300Mbps Wireless Dual Band USB Adapter	Model Name :	WF2150
Temperature :	25 °C	Relative Humidity :	58 %
Pressure :	1010 hPa	Test Voltage :	AC 120V/60Hz
Test Mode :	Band 1/ TX N40 Mode /CH38, CH46 -ANT1+ANT2		

Test Channel	Frequency (MHz)	Average Output Power (dBm)	LIMIT (dBm)	LIMIT (W)
CH38	5190 MHz	9.91	17.00	0.0501
CH46	5230 MHz	9.71	17.00	0.0501

Remark :

- (1) **The MIMO test requirement, RF conducted output power shall measure each transmitter chain by using channel power method.**
And after obtain each individual transmitter chain power, then sum the output power by using the following formula:

$$((\text{dBm}/\text{Chain 1})/10^{\wedge}\text{Log}) + ((\text{dBm}/\text{Chain 2})/10^{\wedge}\text{log}) + ((\text{dBm}/\text{ChainN})/10^{\wedge}\text{log}) =$$
Combined peak output power in mW.
- (2) **Antenna Gain=0 dBi.**
- (3) This EUT supports MIMO 2T2R, all transmit signals are completely uncorrelated, then,

$$\text{Directional gain} = G_{\text{ANT}} + 10 \log(\text{N}) \text{ dBi}$$
, that is Directional gain=3



7. ANTENNA CONDUCTED SPURIOUS EMISSION

7.1 APPLIED PROCEDURES / LIMIT

FCC Part15, Subpart E			
Test Item	Limit	Frequency Range (MHz)	Result
Antenna conducted Spurious Emission	-27 dBm/1MHz	5150 - 5250	PASS

7.1.1 MEASUREMENT INSTRUMENTS LIST

Item	Kind of Equipment	Manufacturer	Type No.	Serial No.	Last Calibration	Next Calibration
1	Spectrum Analyzer	R&S	FSP_40	100129	Nov.25.2012	Nov.16.2013

Remark: "N/A" denotes no model name, serial no. or calibration specified.
 All calibration period of Equipment List is One Year.

7.1.2 TEST PROCEDURE

a. The EUT was directly connected to the spectrum analyzer and antenna output port as show in the block diagram below,

b.

Spectrum Parameter	Setting
Attenuation	Auto
RB	1000 kHz
VB	1000 kHz
Trace	Max Hold
Sweep Time	Auto

7.1.3 DEVIATION FROM STANDARD

No deviation.

7.1.4 TEST SETUP

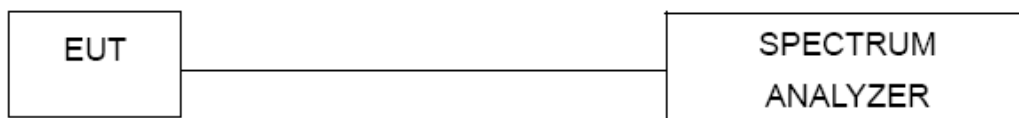

7.1.5 EUT OPERATION CONDITIONS

The EUT tested system was configured as the statements of 4.1.6 Unless otherwise a special operating condition is specified in the follows during the testing.



7.1.6 TEST RESULTS

EUT :	300Mbps Wireless Dual Band USB Adapter	Model Name :	WF2150
Temperature :	25 °C	Relative Humidity :	58 %
Test Voltage :	AC 120V/60Hz		
Test Mode :	Band 1/TX A Mode/ CH36, CH40, CH48		

Channel of Worst Data: CH36			
The max. radio frequency power in any 1000kHz bandwidth outside the frequency band		The max. radio frequency power in any 1000kHz bandwidth within the frequency band.	
FREQUENCY(MHz)	POWER(dBm)	FREQUENCY(MHz)	POWER(dBm)
5150.00	-37.92	5353.60	-46.26
Limit: -27 dBm/1MHz		Result:PASS	
Measurement method: S.A Read value+Ant gain+cable loss			



TX mode CH36

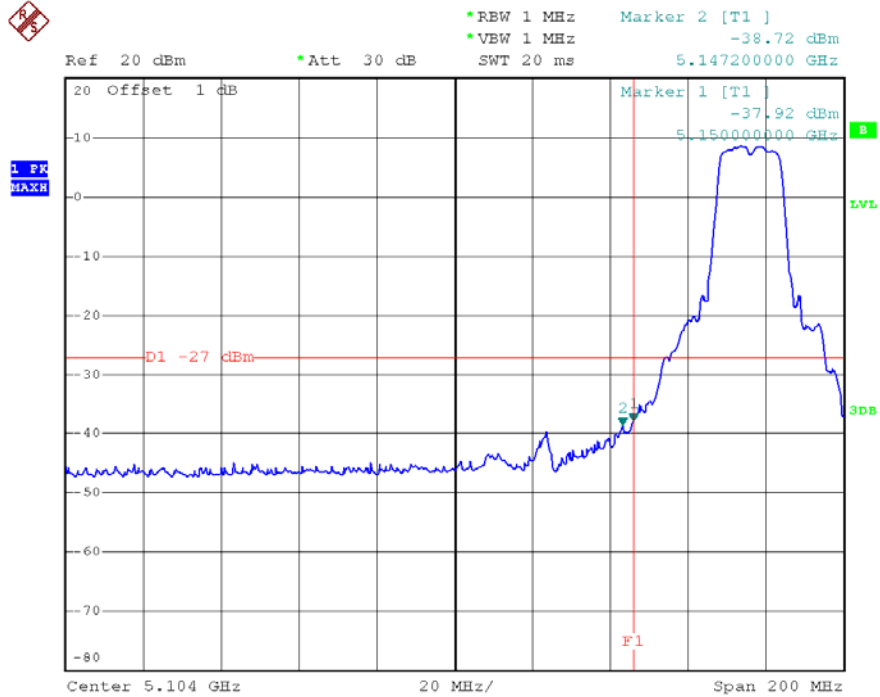

Date: 7.DEC.2012 12:44:37

TX mode CH48

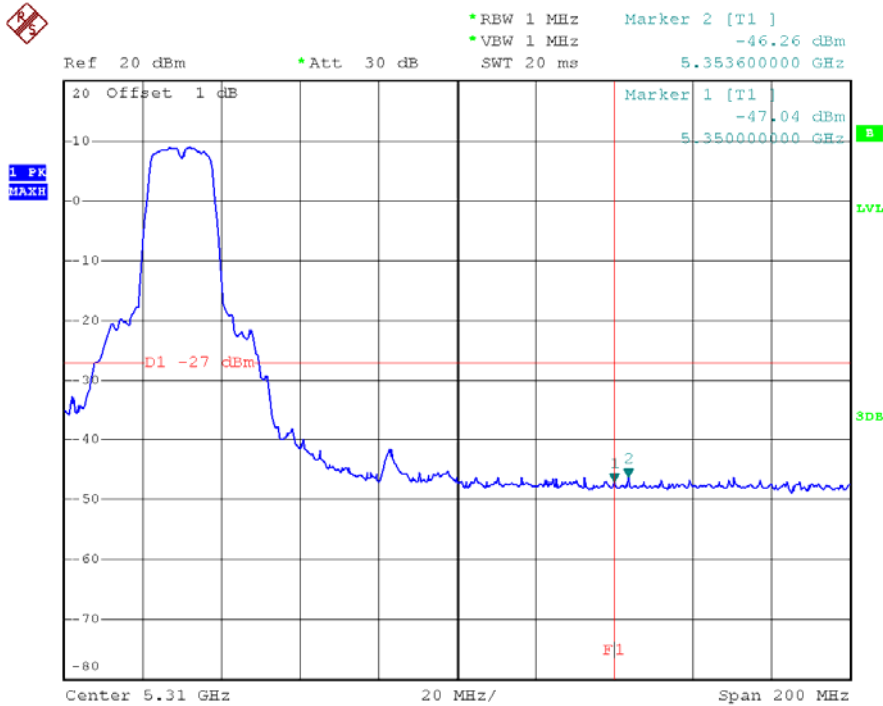

Date: 7.DEC.2012 12:46:01

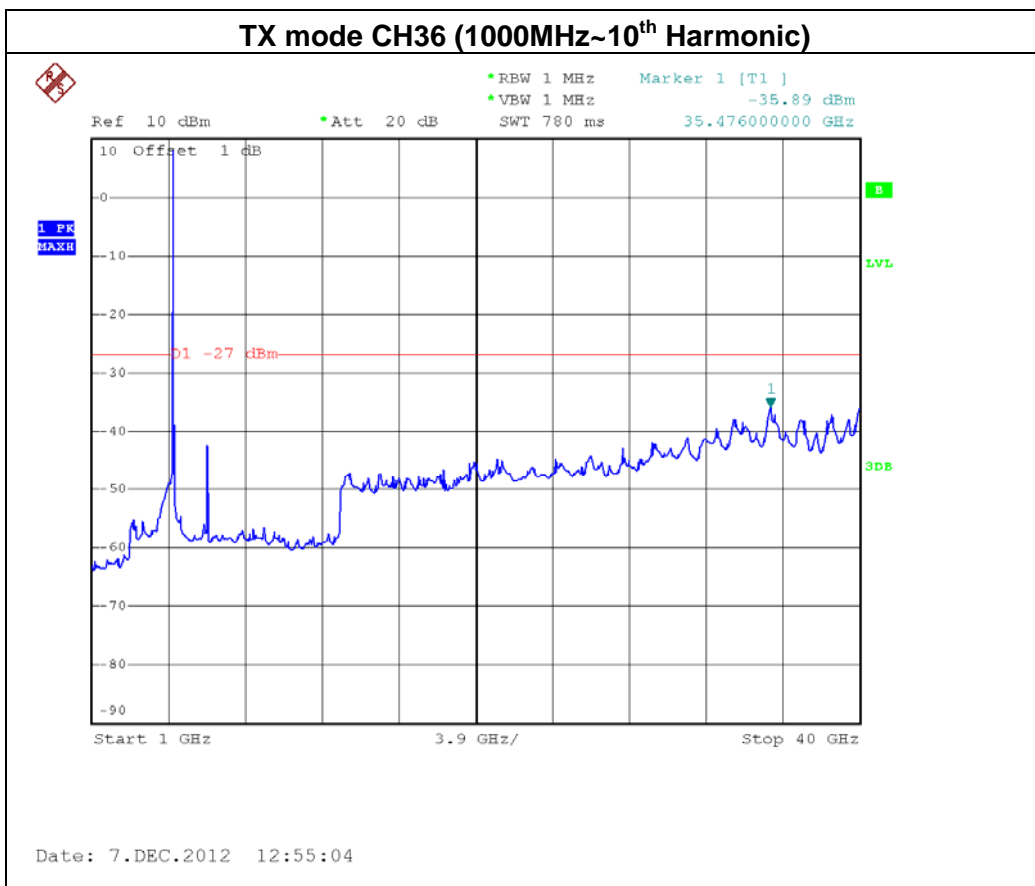
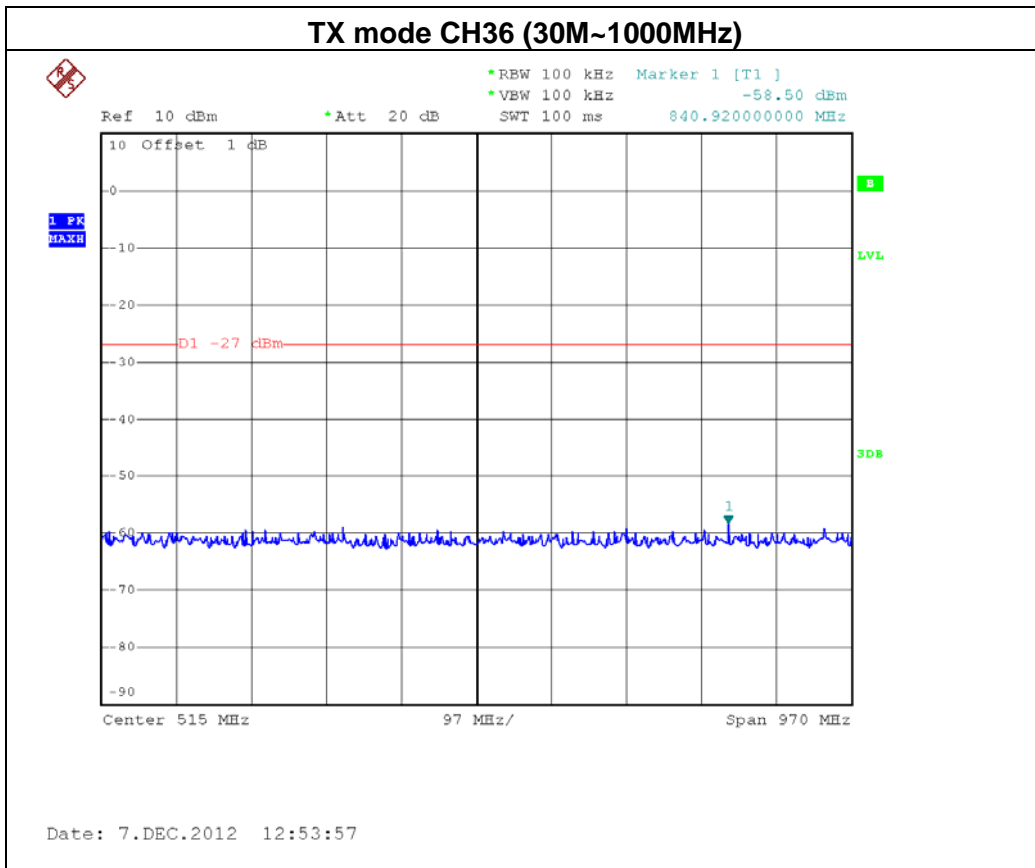

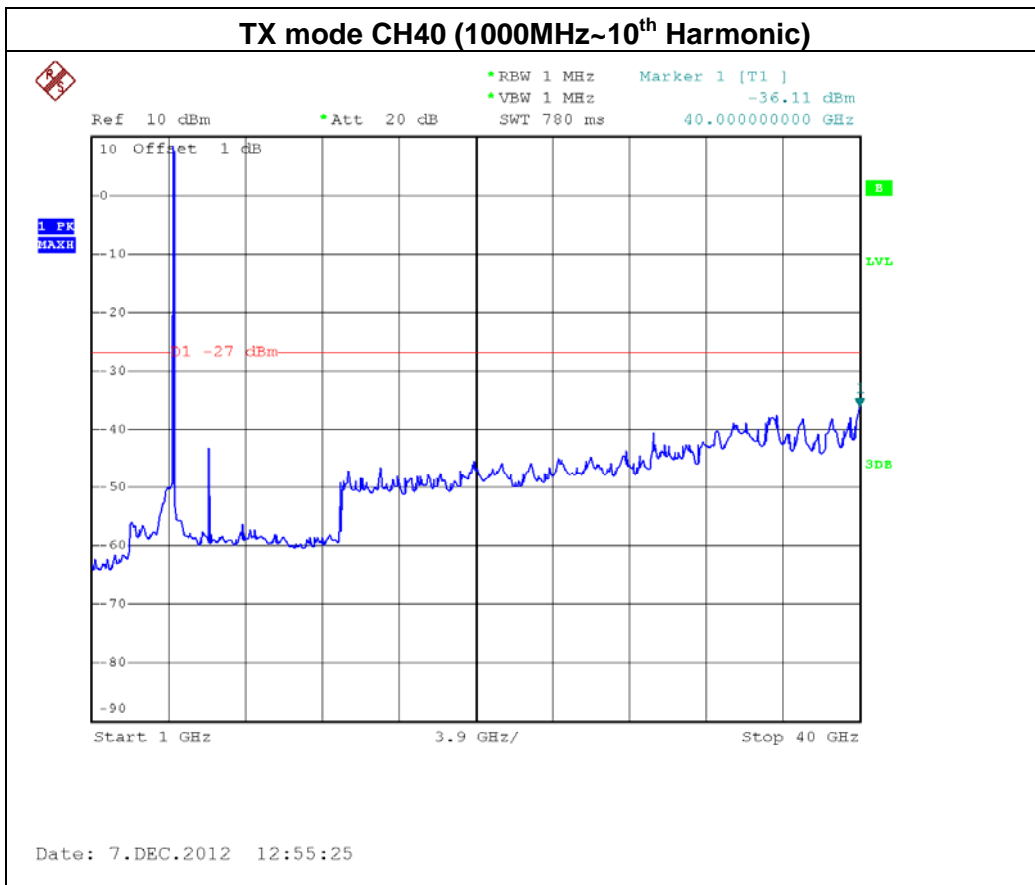
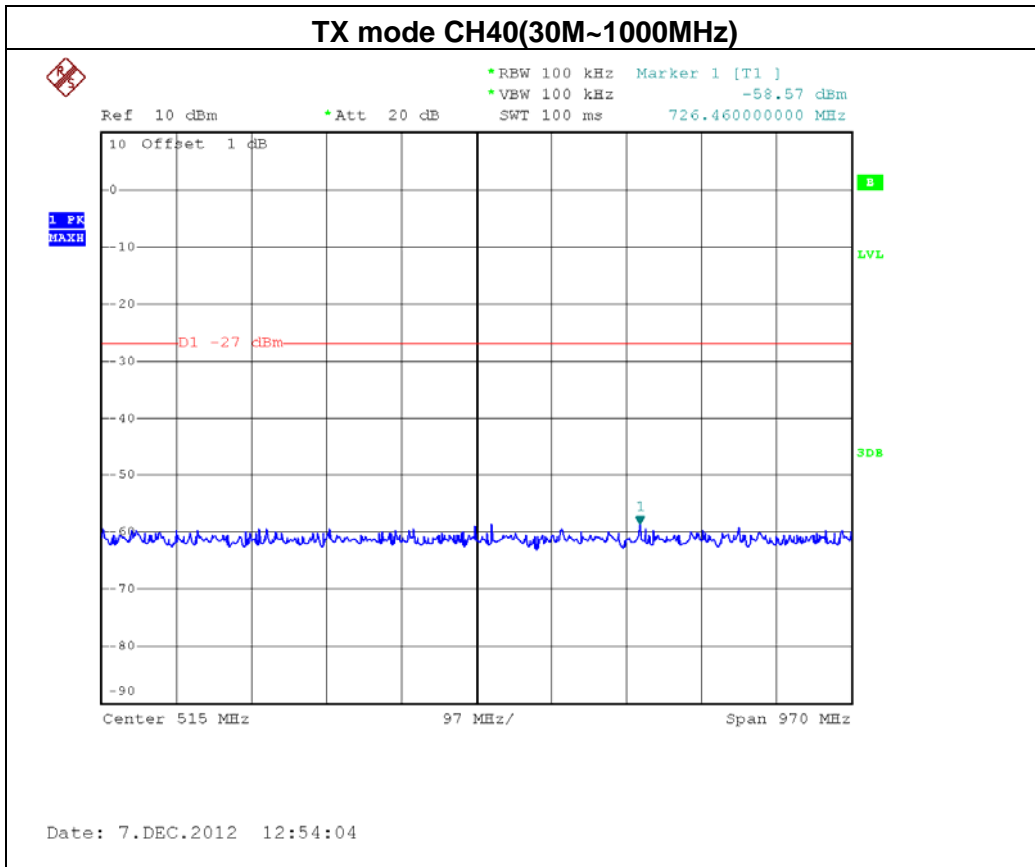

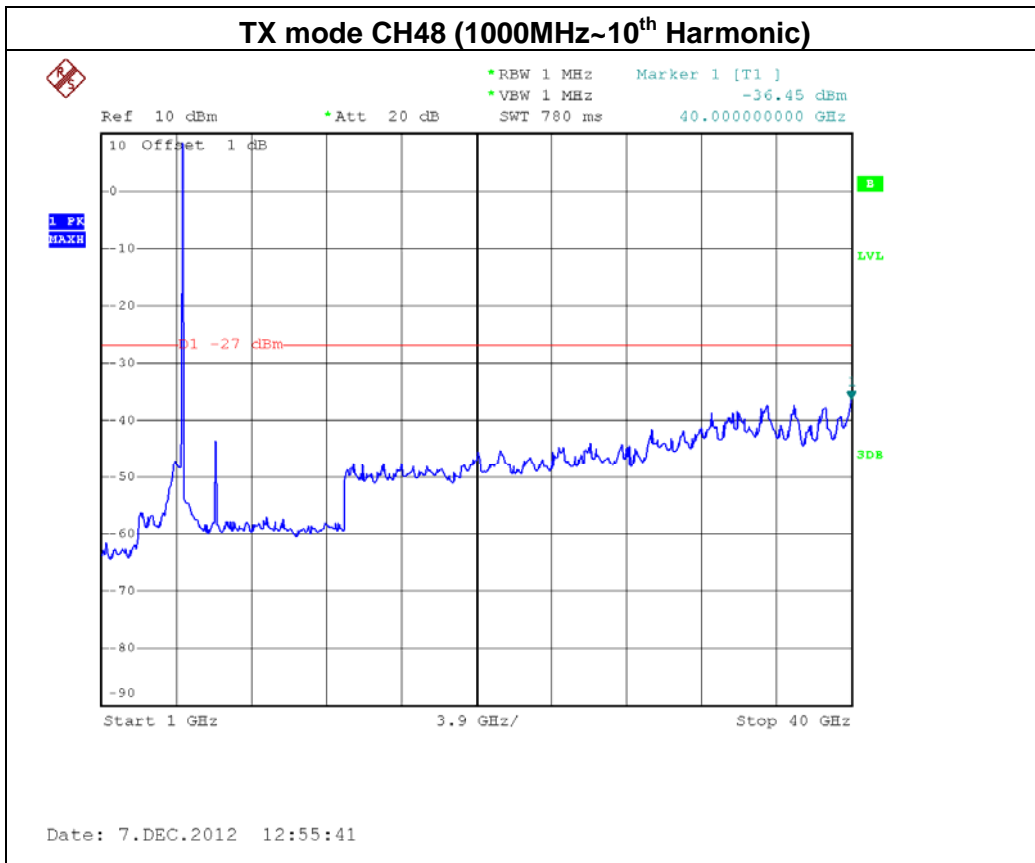
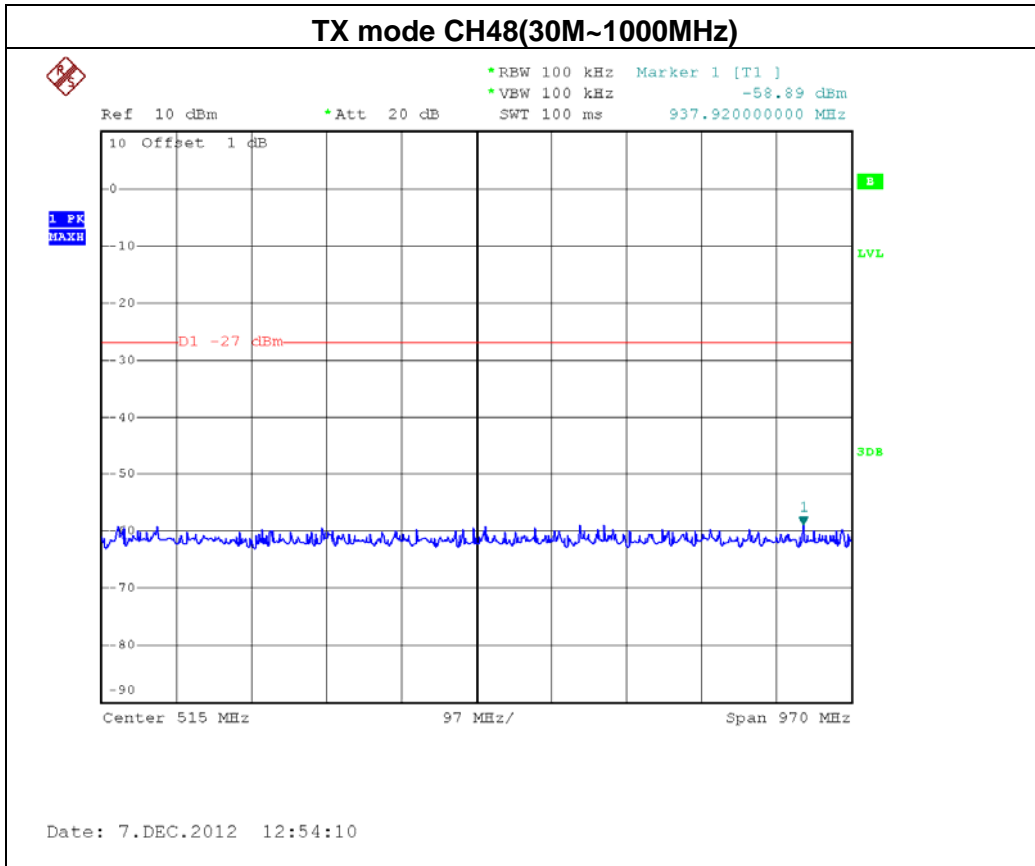



EUT :	300Mbps Wireless Dual Band USB Adapter	Model Name :	WF2150
Temperature :	25 °C	Relative Humidity :	58 %
Test Voltage :	AC 120V/60Hz		
Test Mode :	Band 1/TX N20 Mode/ H36, CH40 , CH48 -ANT 1		

Channel of Worst Data: CH36			
The max. radio frequency power in any 1000kHz bandwidth outside the frequency band		The max. radio frequency power in any 1000kHz bandwidth within the frequency band.	
FREQUENCY(MHz)	POWER(dBm)	FREQUENCY(MHz)	POWER(dBm)
5150.00	-42.56	5358.40	-46.84
Limit: -27 dBm/1MHz		Result:PASS	
Measurement method: S.A Read value+Ant gain+cable loss			



Neutron Engineering Inc.

TX mode CH36

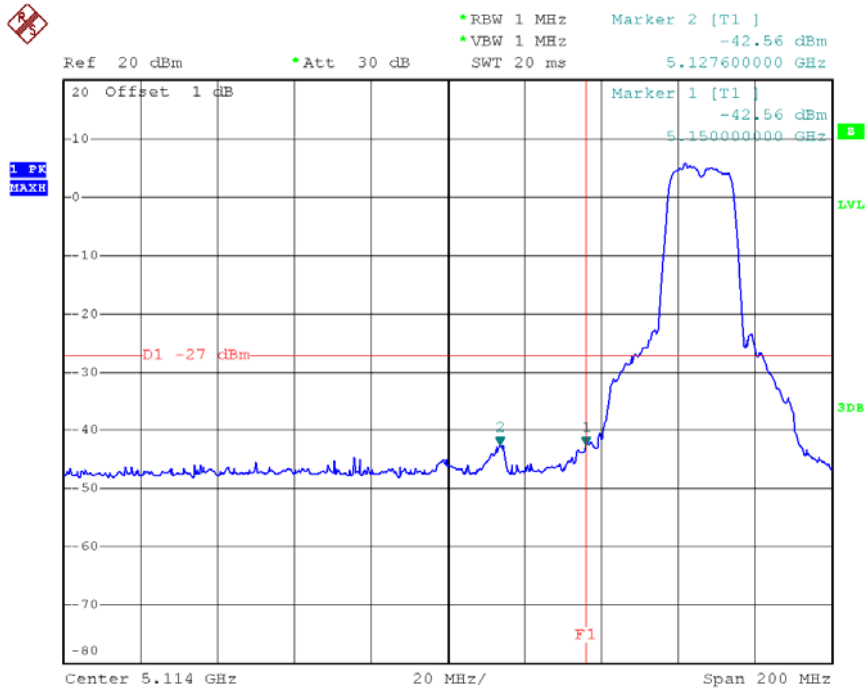

Date: 7.DEC.2012 13:00:10

TX mode CH48

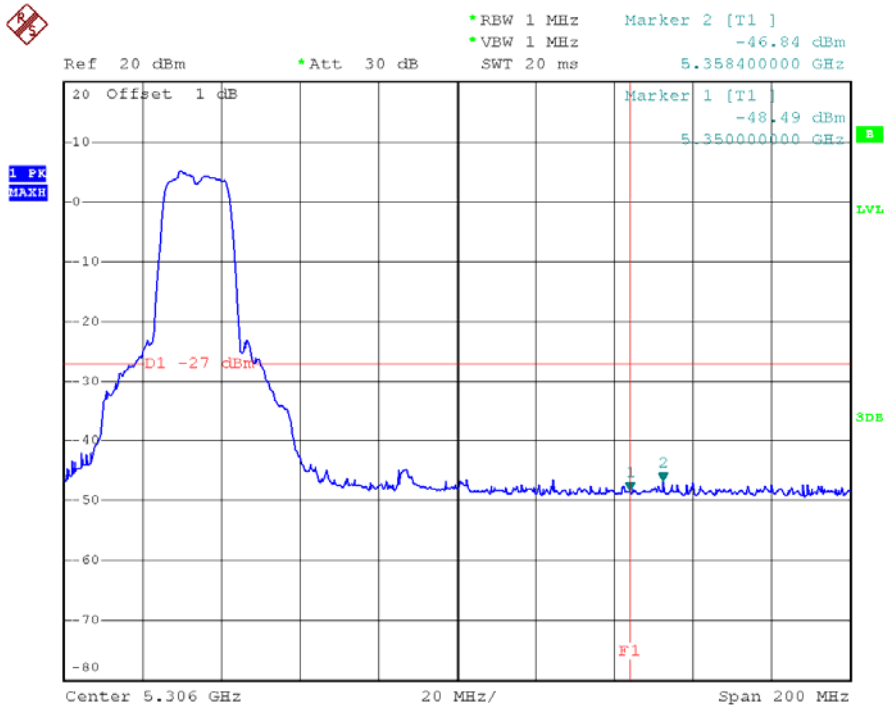

Date: 7.DEC.2012 13:01:16

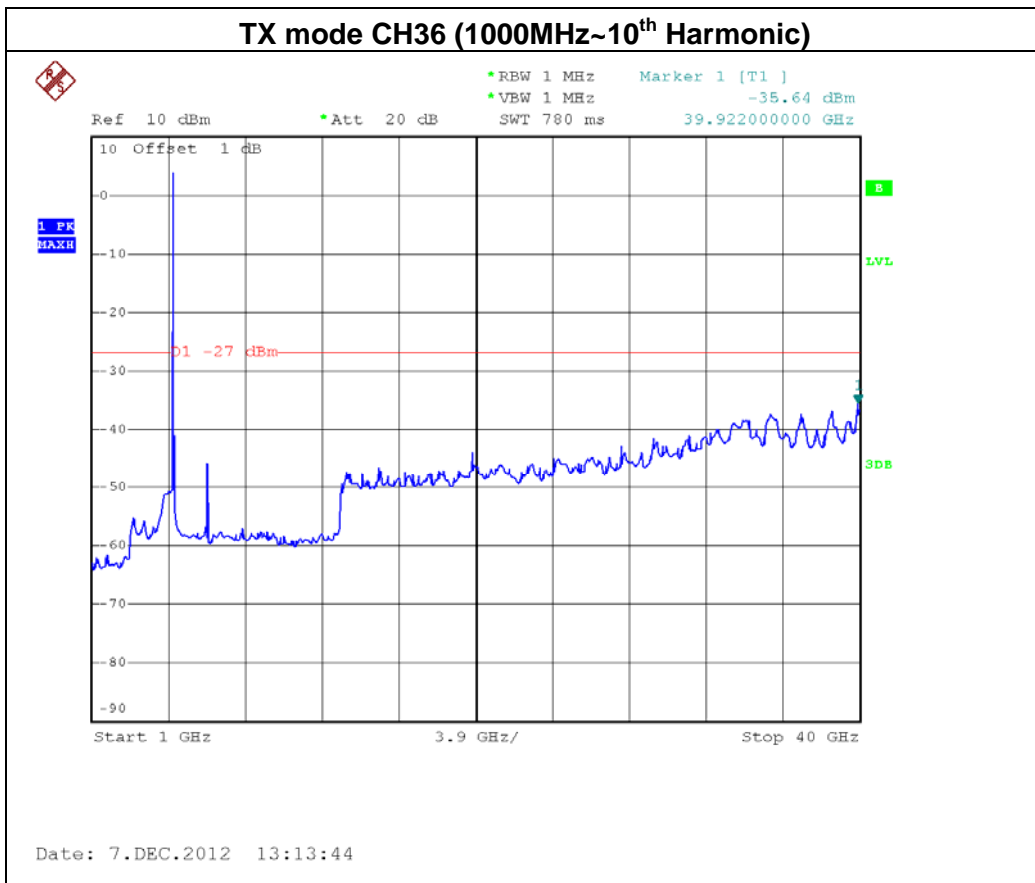
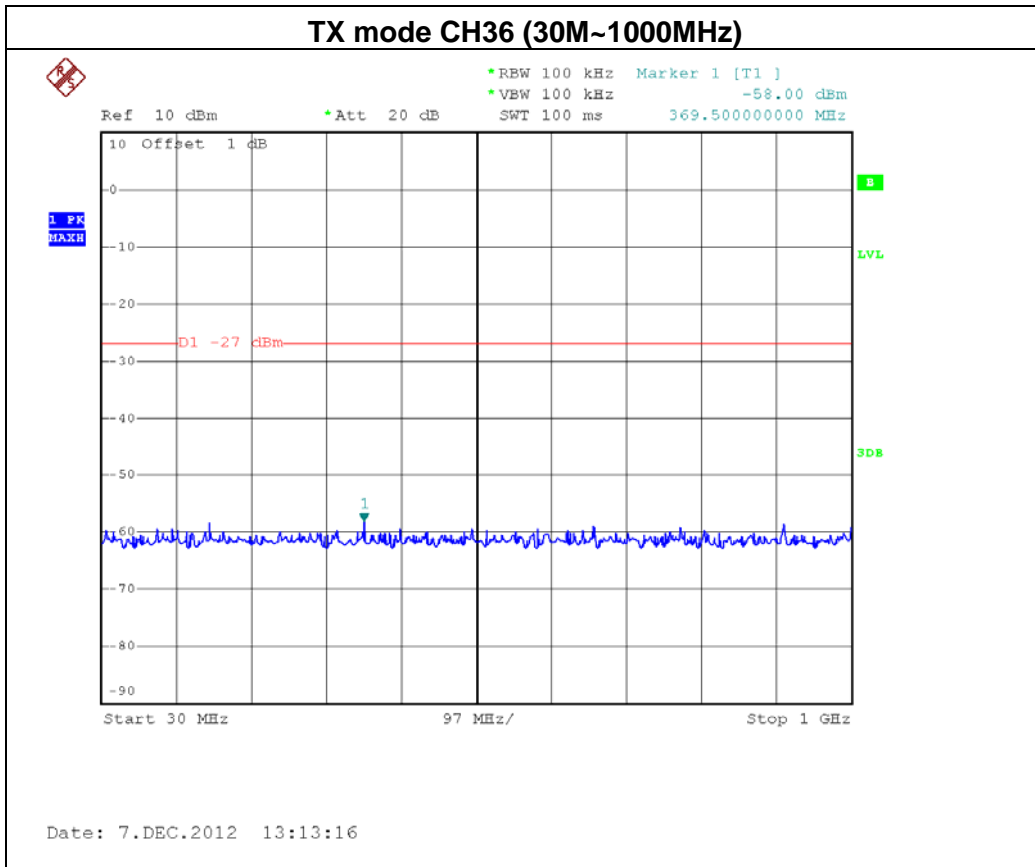

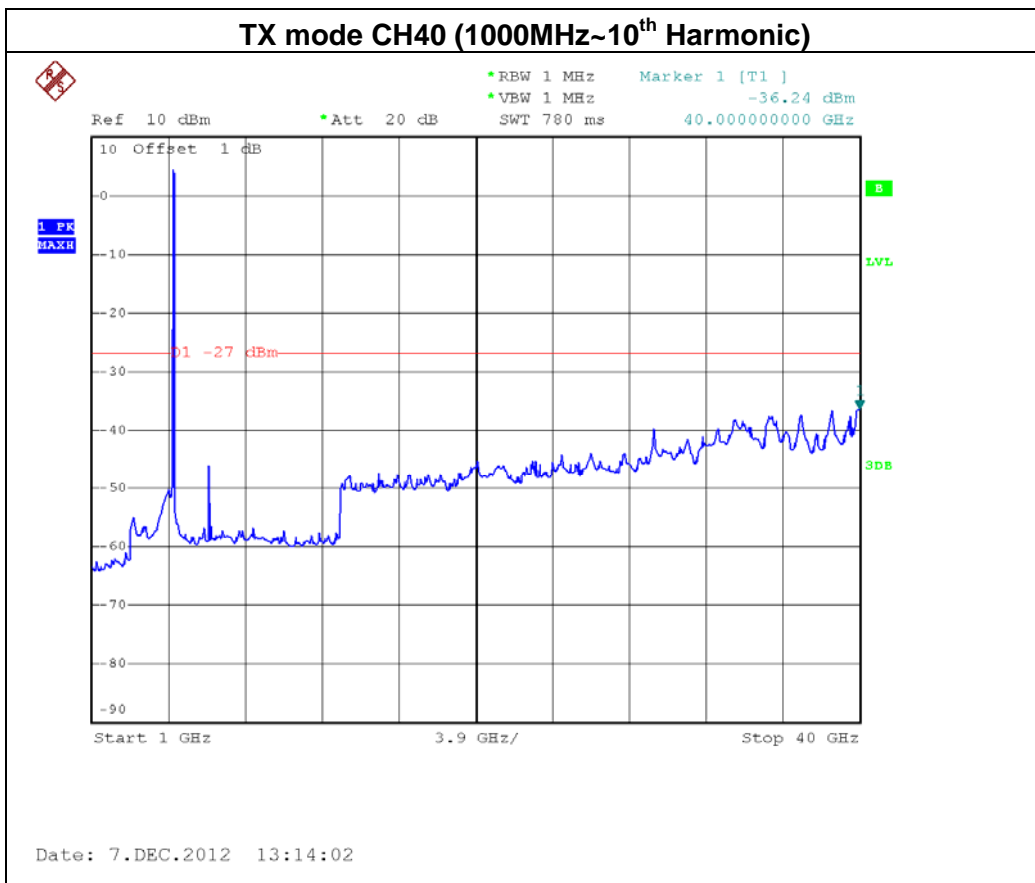
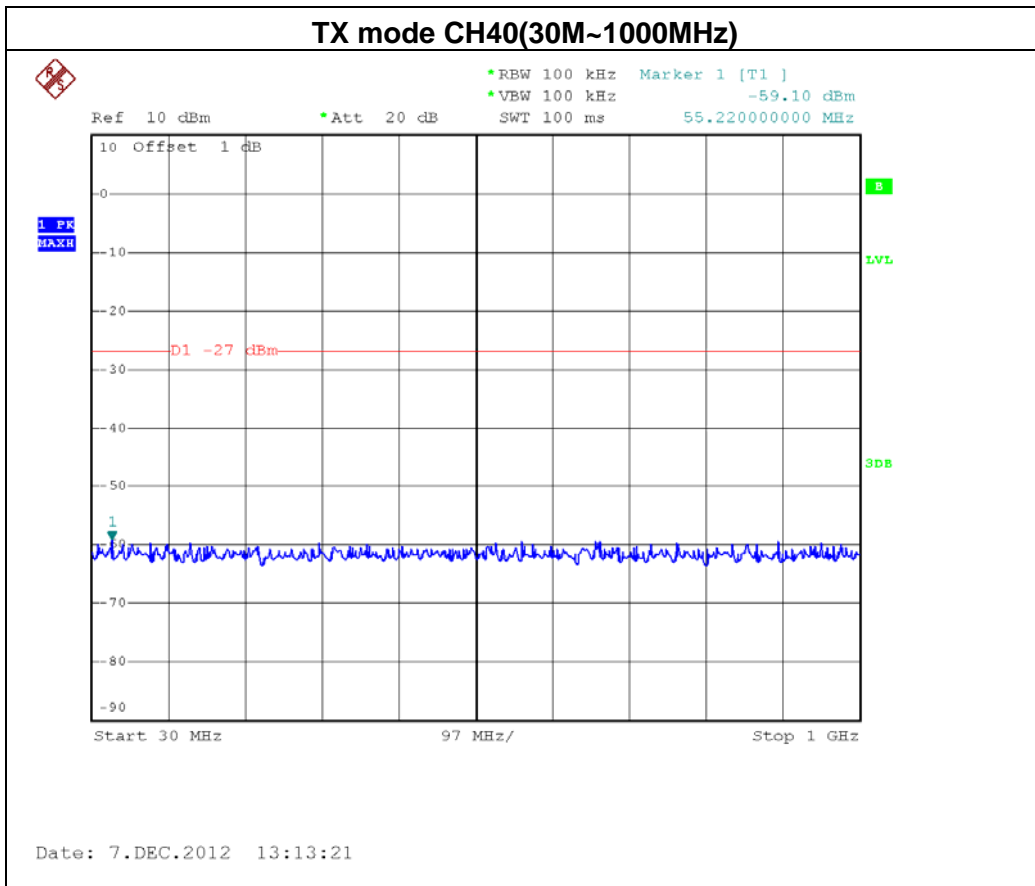

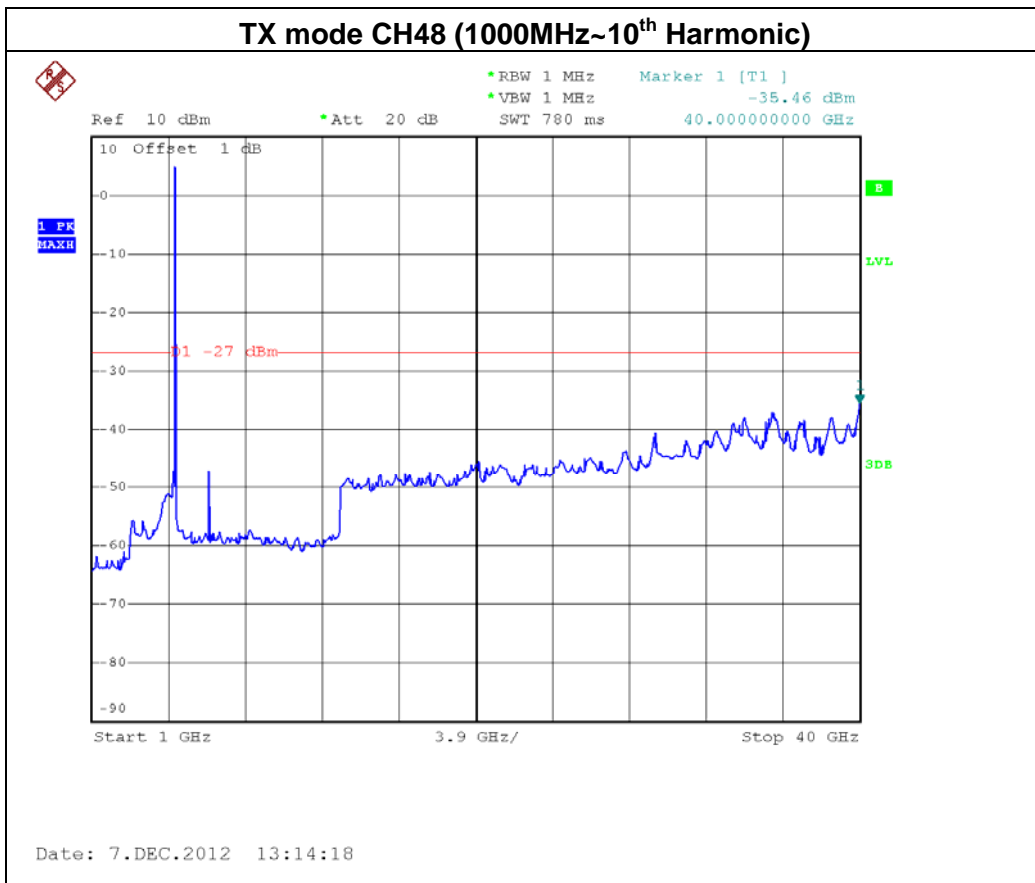
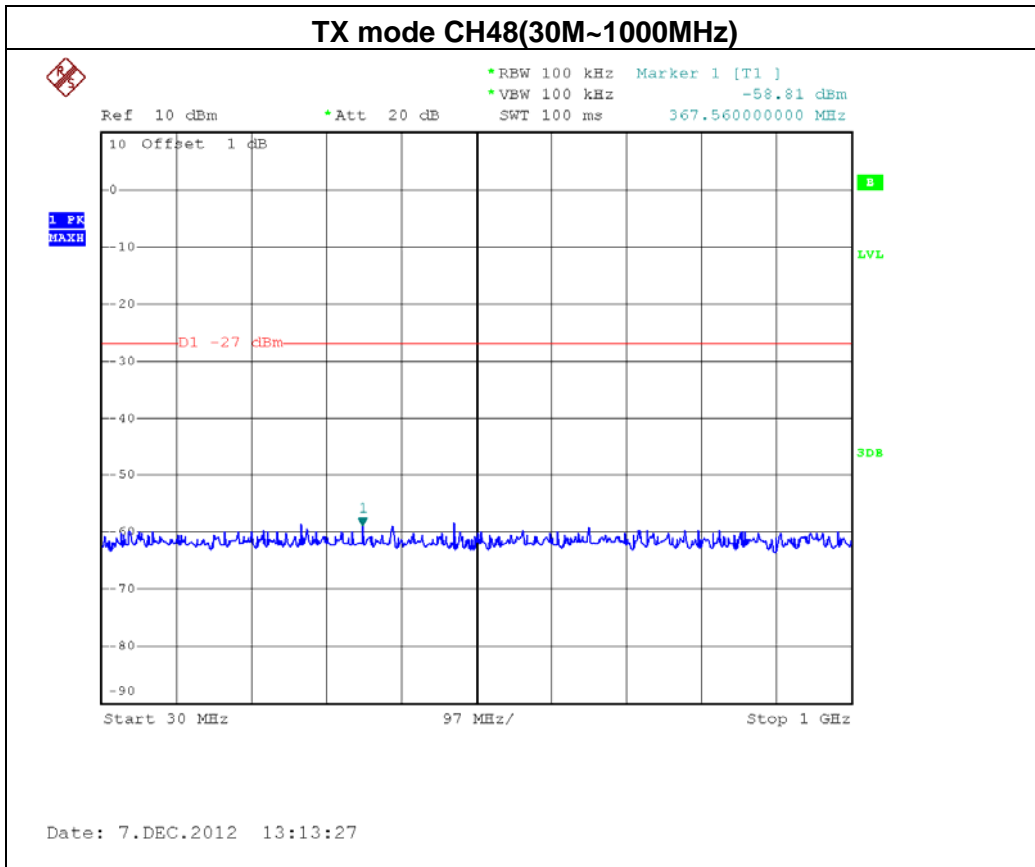



EUT :	300Mbps Wireless Dual Band USB Adapter	Model Name :	WF2150
Temperature :	25 °C	Relative Humidity :	58 %
Test Voltage :	AC 120V/60Hz		
Test Mode :	Band 1/TX N20 Mode/ H36, CH40 , CH48 -ANT 2		

Channel of Worst Data: CH36			
The max. radio frequency power in any 1000kHz bandwidth outside the frequency band		The max. radio frequency power in any 1000kHz bandwidth within the frequency band.	
FREQUENCY(MHz)	POWER(dBm)	FREQUENCY(MHz)	POWER(dBm)
5128.00	-42.57	5351.60	-46.89
Limit: -27 dBm/1MHz		Result:PASS	
Measurement method: S.A Read value+Ant gain+cable loss			



TX mode CH36

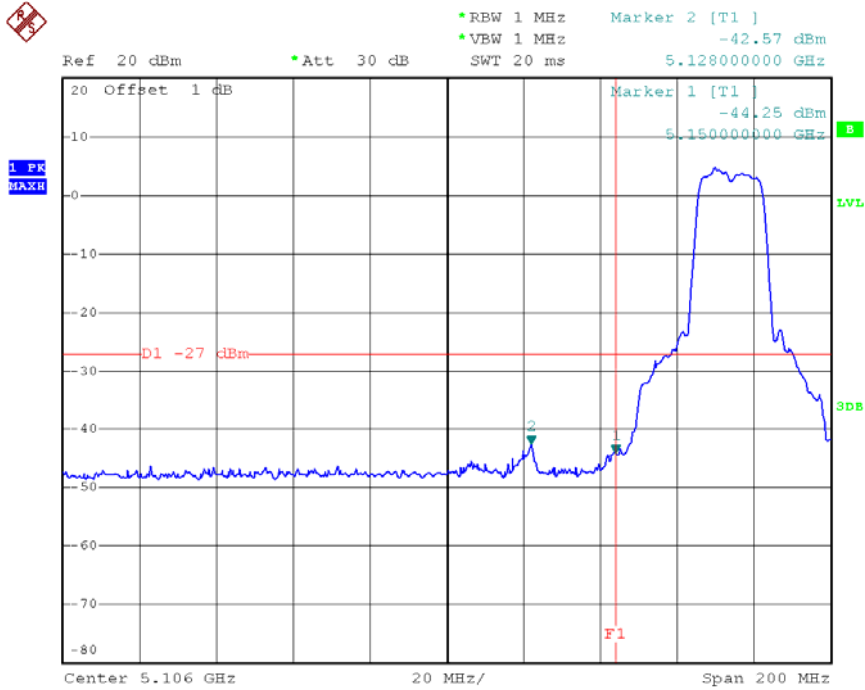

Date: 7.DEC.2012 13:45:01

TX mode CH48

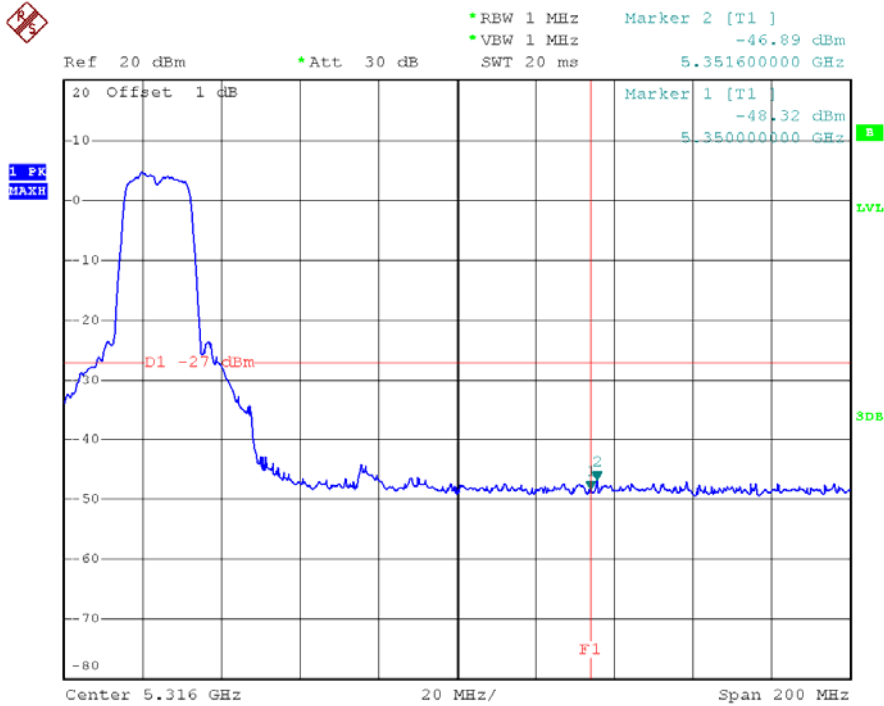

Date: 7.DEC.2012 13:45:45

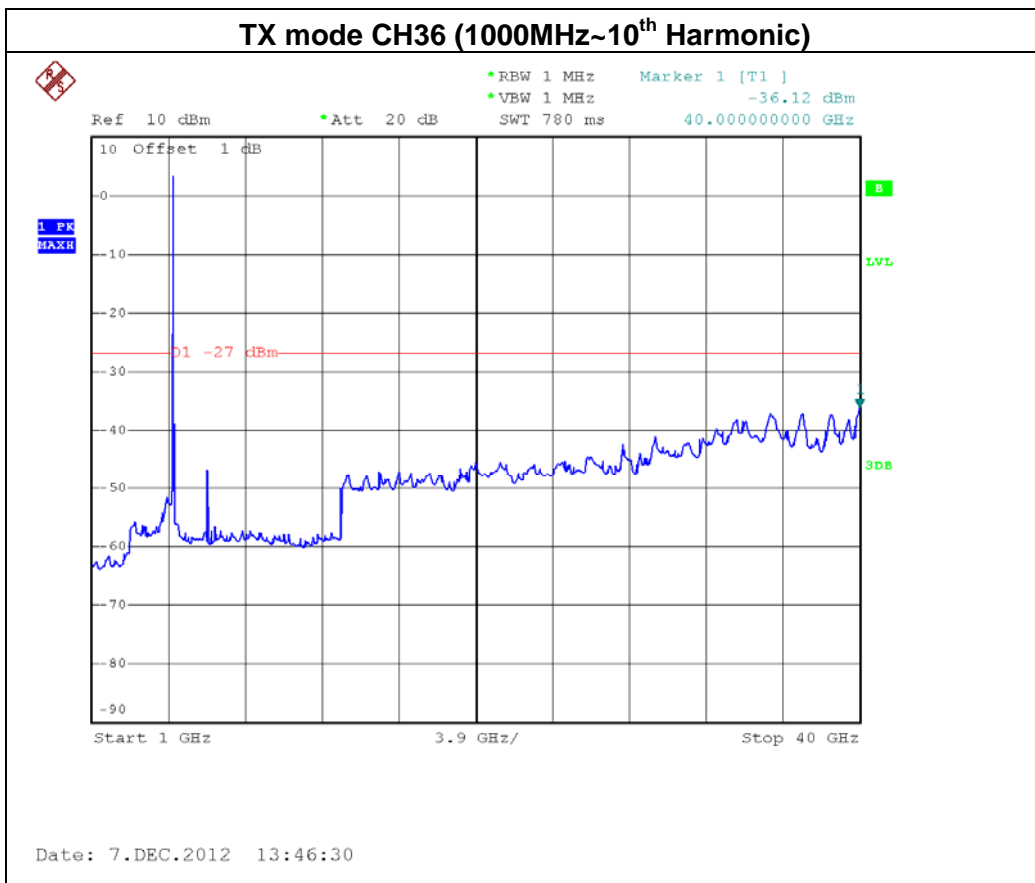
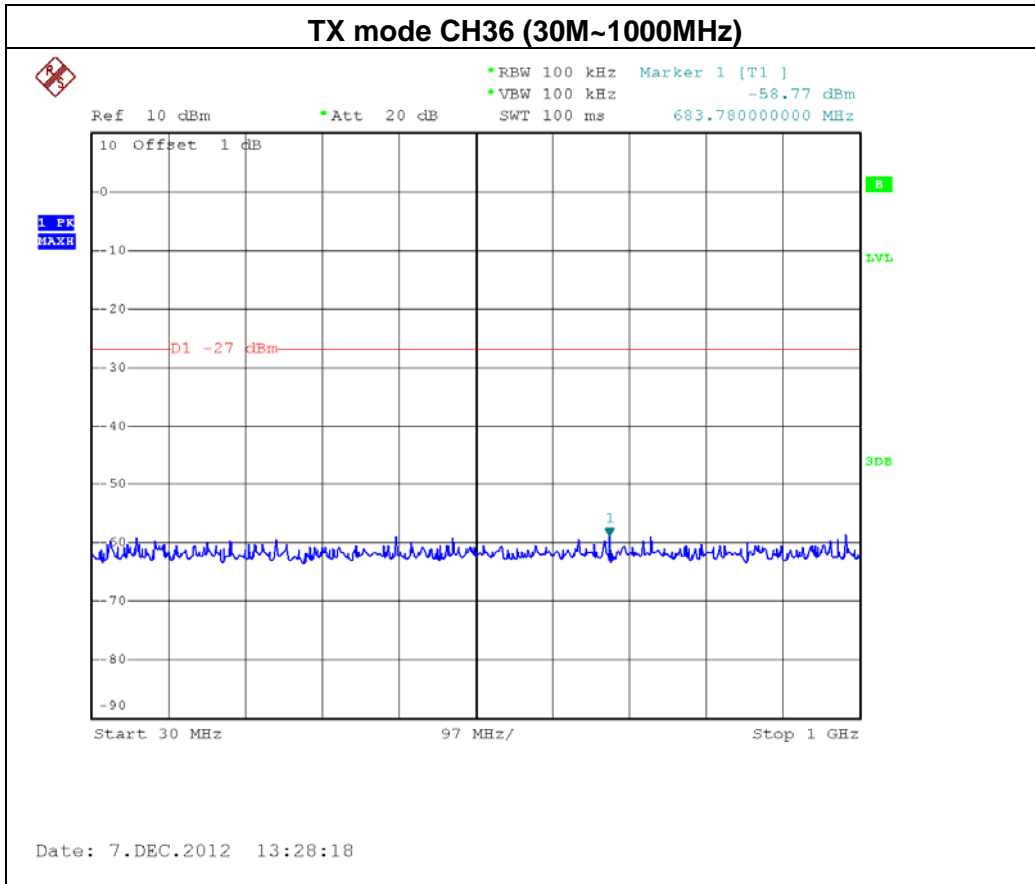

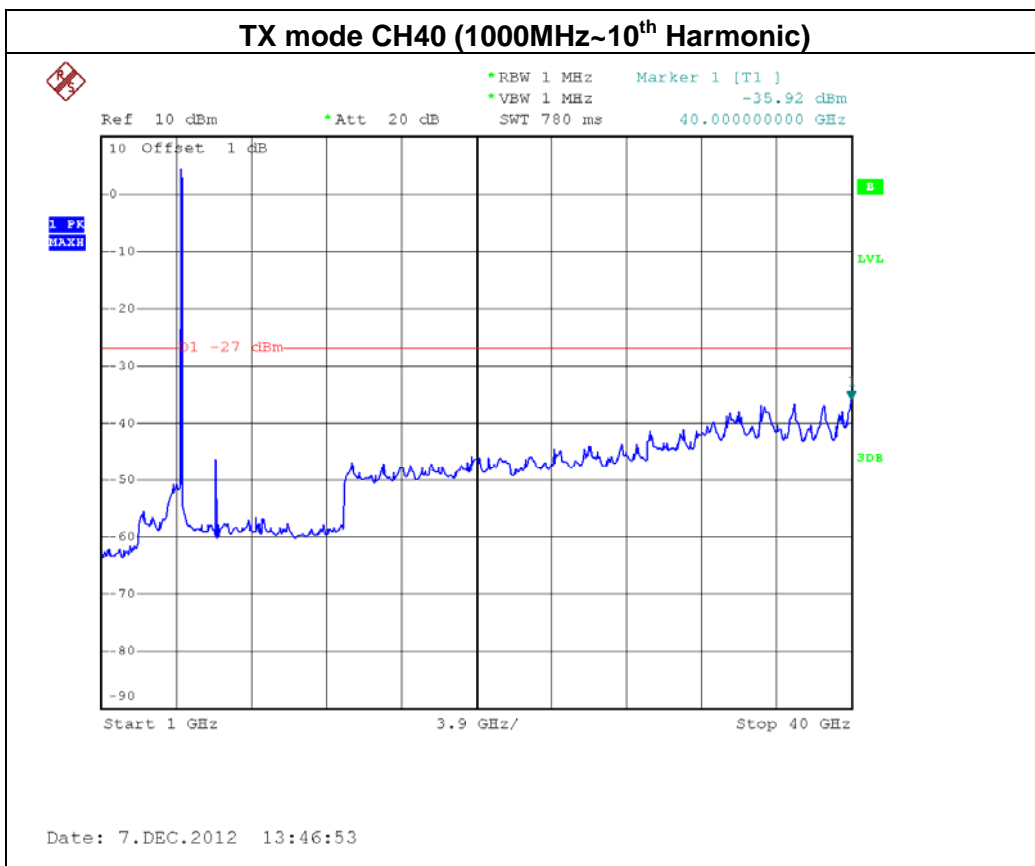
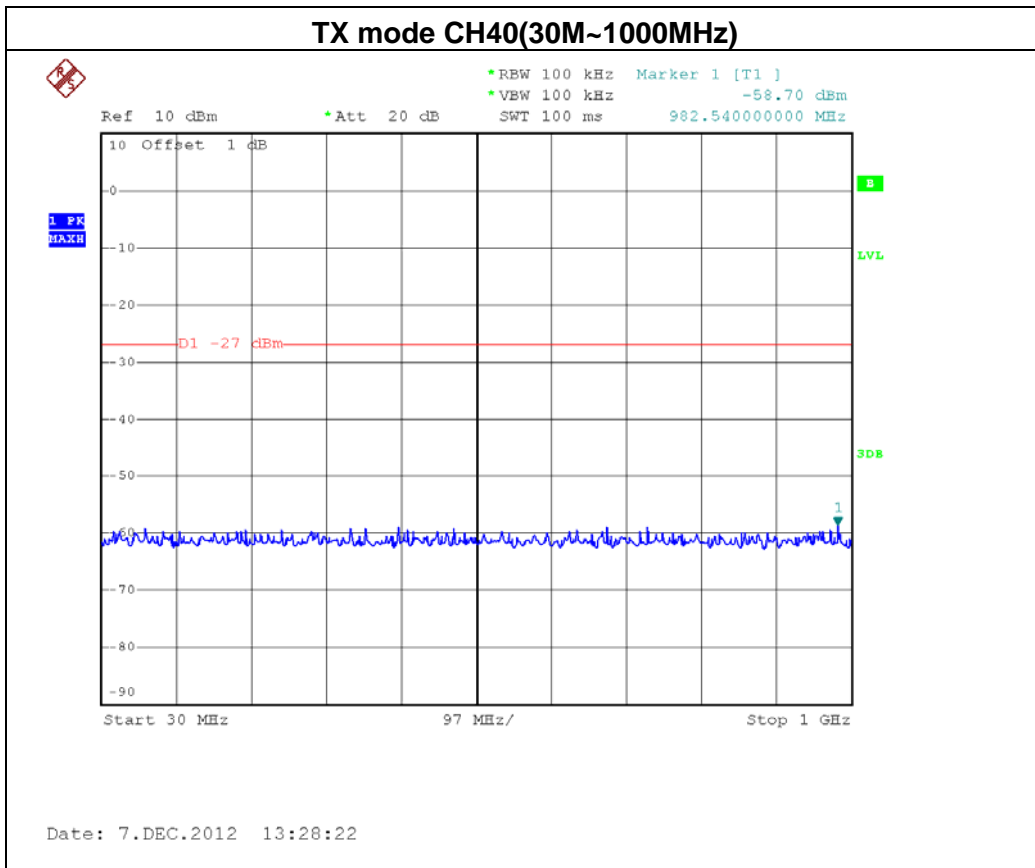

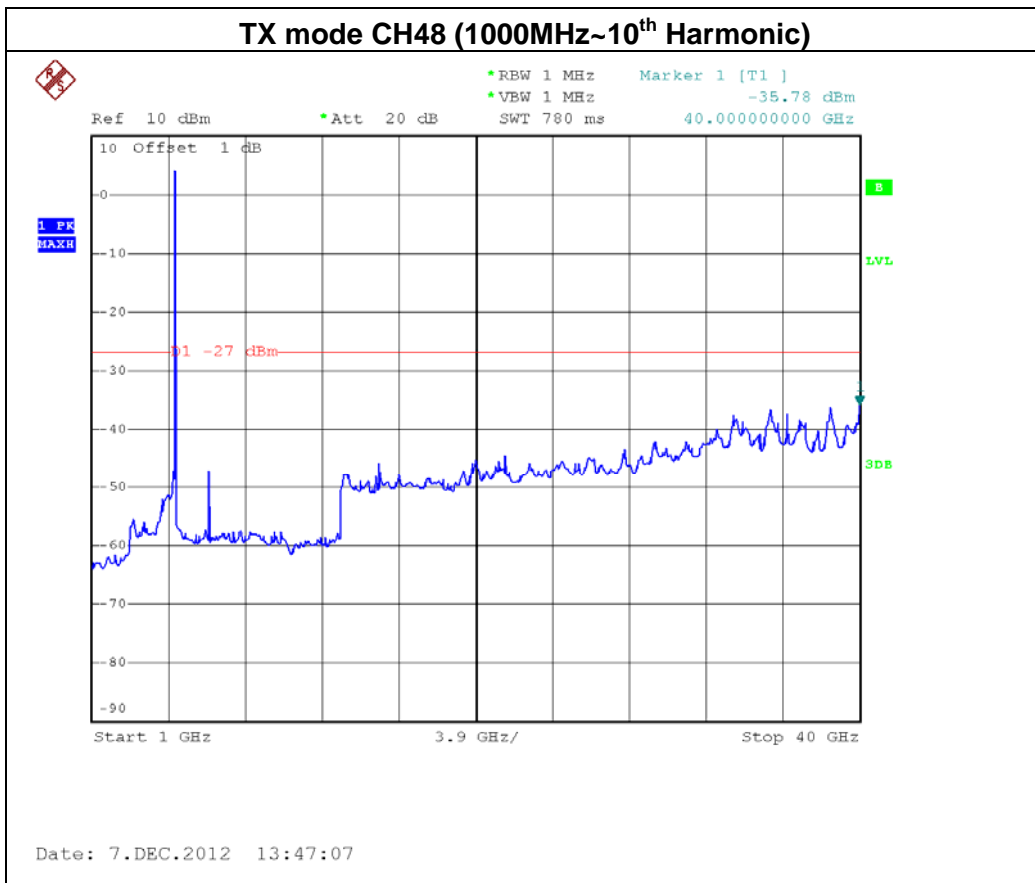
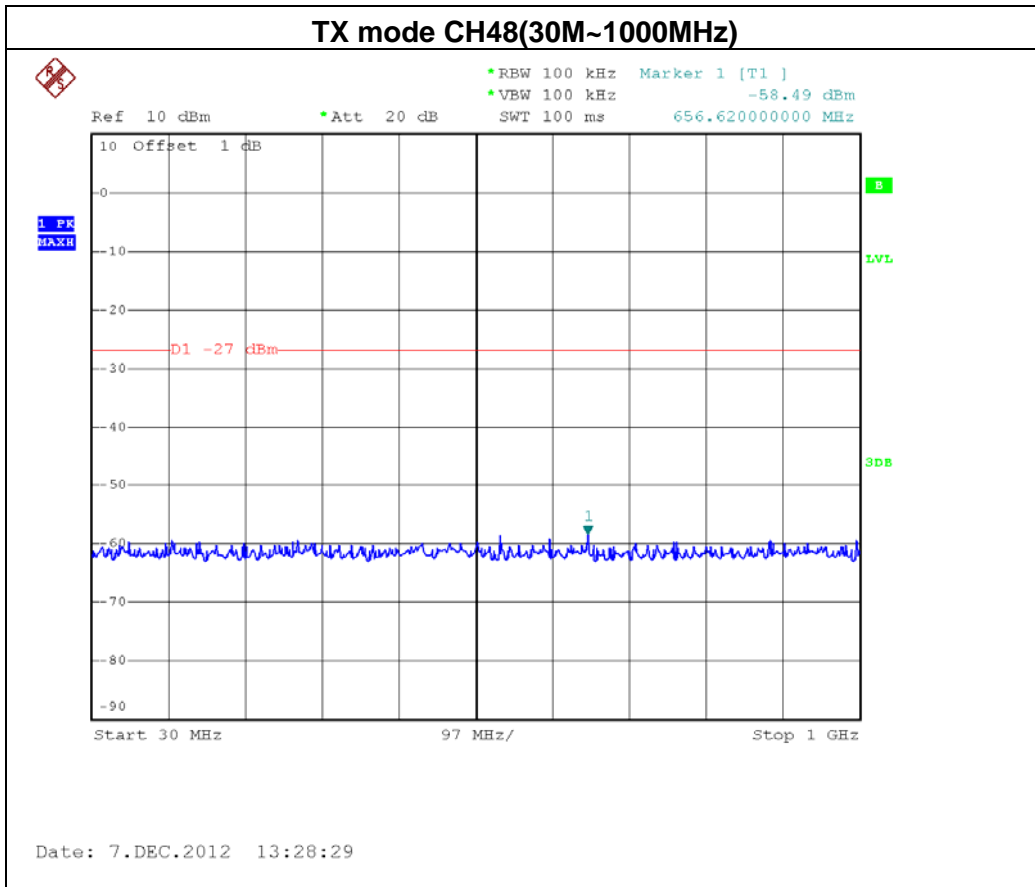



EUT :	300Mbps Wireless Dual Band USB Adapter	Model Name :	WF2150
Temperature :	25 °C	Relative Humidity :	58 %
Test Voltage :	AC 120V/60Hz		
Test Mode :	Band 1/TX N40 Mode/ CH38, CH46 -ANT 1		

Channel of Worst Data: CH38			
The max. radio frequency power in any 1000kHz bandwidth outside the frequency band		The max. radio frequency power in any 1000kHz bandwidth within the frequency band.	
FREQUENCY(MHz)	POWER(dBm)	FREQUENCY(MHz)	POWER(dBm)
5150.00	-31.41	5355.60	-47.07
Limit: -27 dBm/1MHz		Result:PASS	
Measurement method: S.A Read value+Ant gain+cable loss			



TX mode CH38

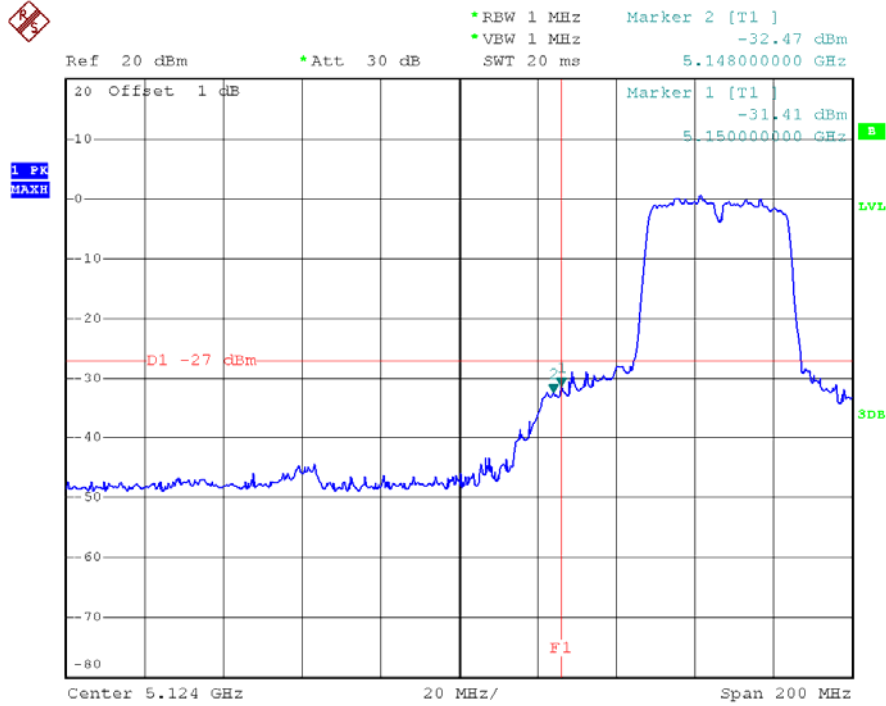

Date: 7.DEC.2012 13:24:54

TX mode CH46

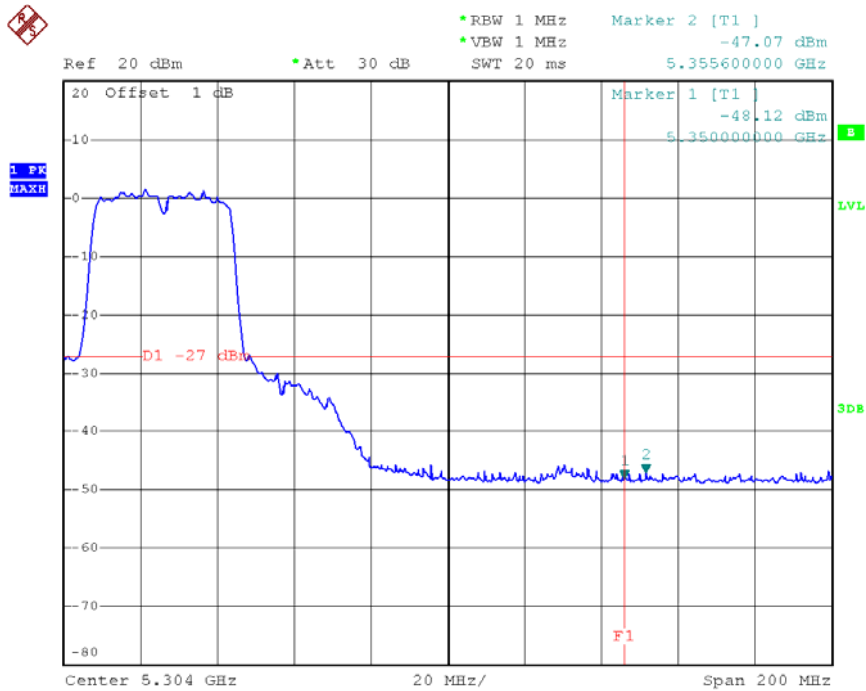

Date: 7.DEC.2012 13:23:54

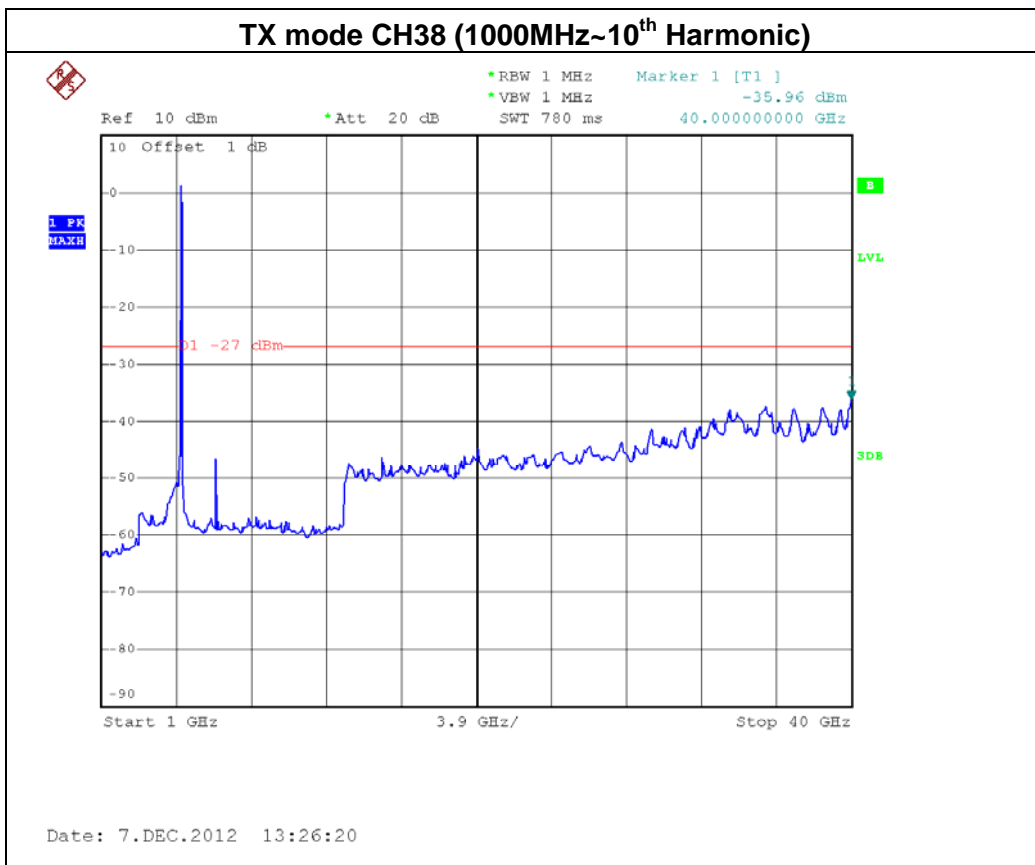
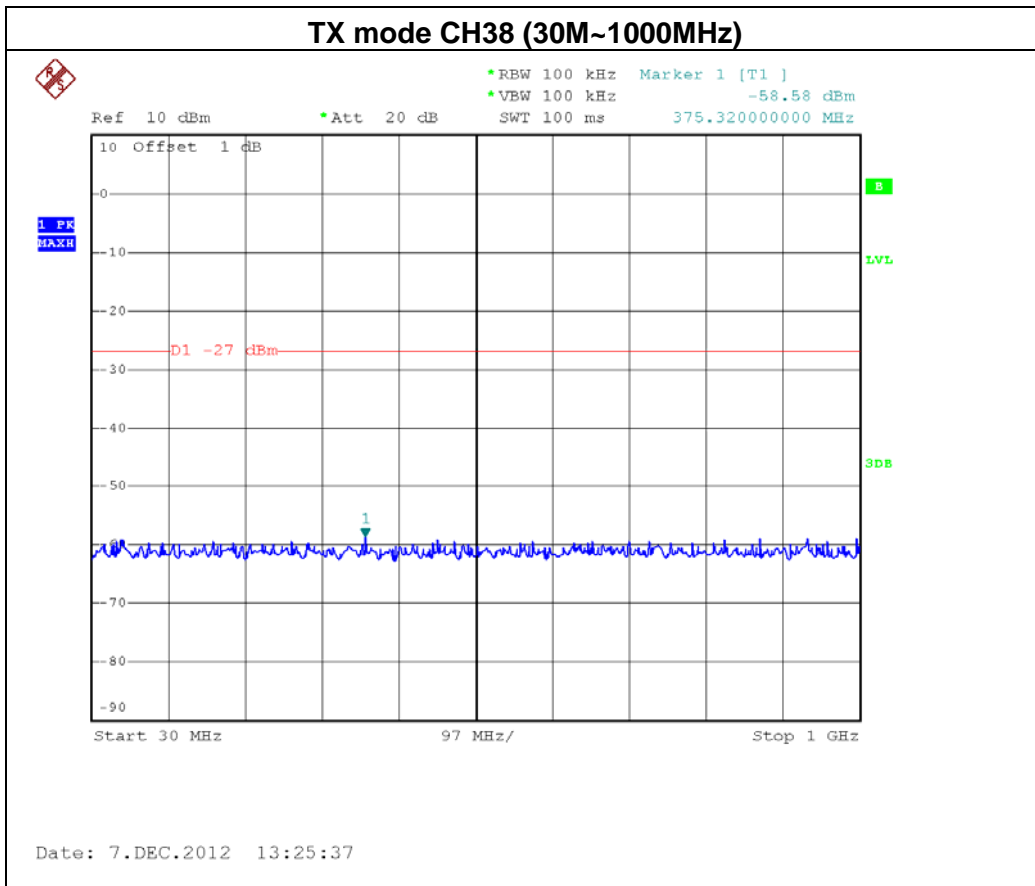

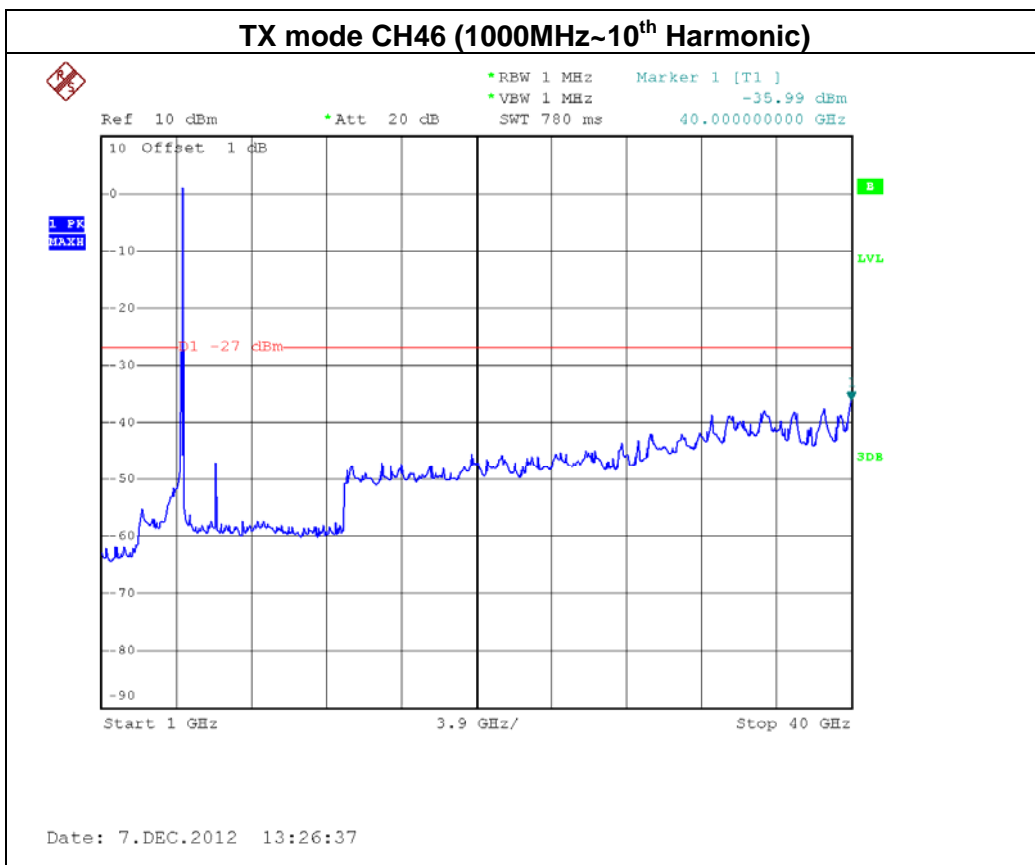
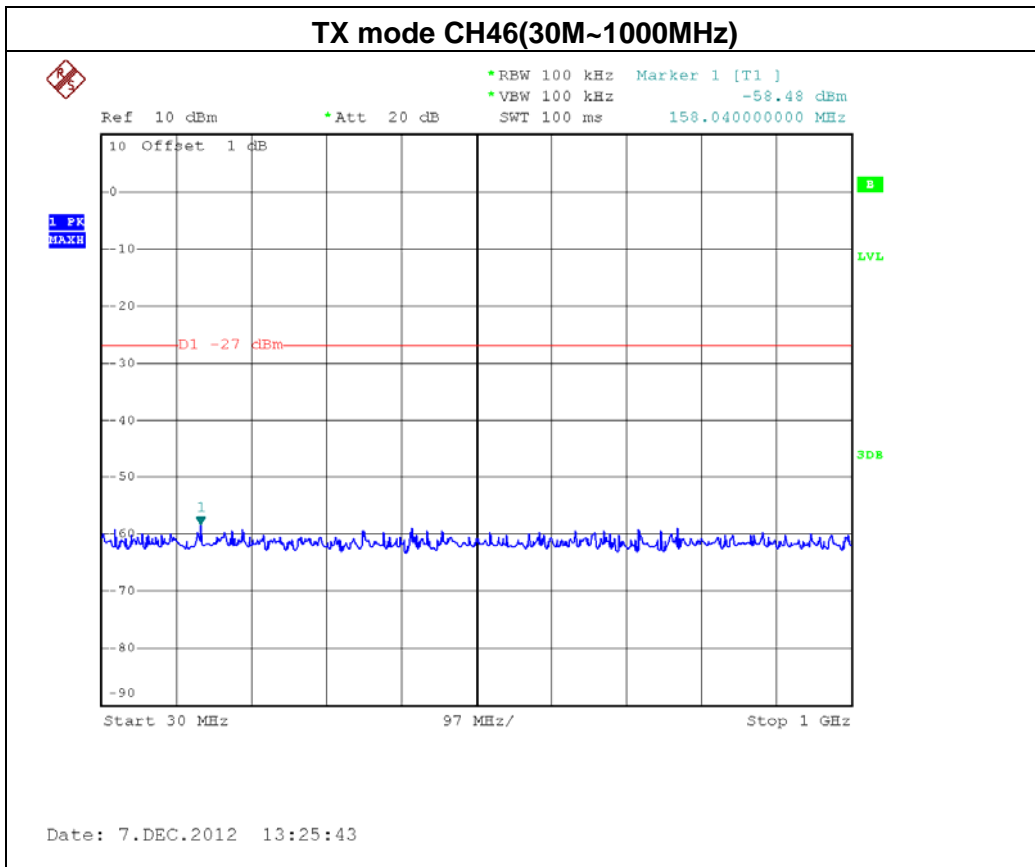



EUT :	300Mbps Wireless Dual Band USB Adapter	Model Name :	WF2150
Temperature :	25 °C	Relative Humidity :	58 %
Test Voltage :	AC 120V/60Hz		
Test Mode :	Band 1/TX N40 Mode/ CH38, CH46 -ANT 2		

Channel of Worst Data: CH38			
The max. radio frequency power in any 1000kHz bandwidth outside the frequency band		The max. radio frequency power in any 1000kHz bandwidth within the frequency band.	
FREQUENCY(MHz)	POWER(dBm)	FREQUENCY(MHz)	POWER(dBm)
5150.00	-30.64	5355.60	-46.94
Limit: -27 dBm/1MHz		Result:PASS	
Measurement method: S.A Read value+Ant gain+cable loss			



TX mode CH38

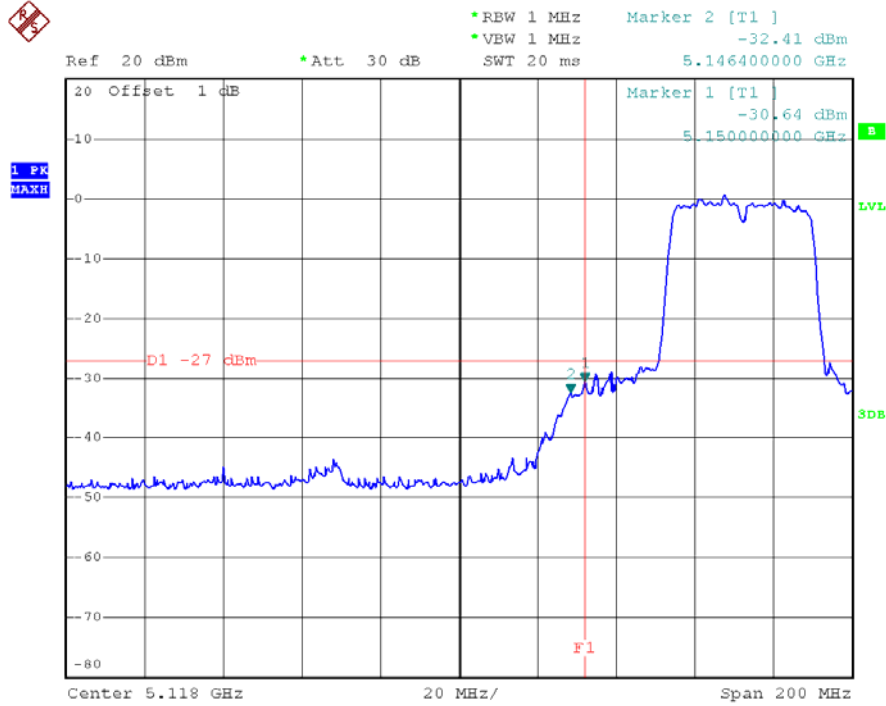

Date: 7.DEC.2012 13:31:55

TX mode CH46

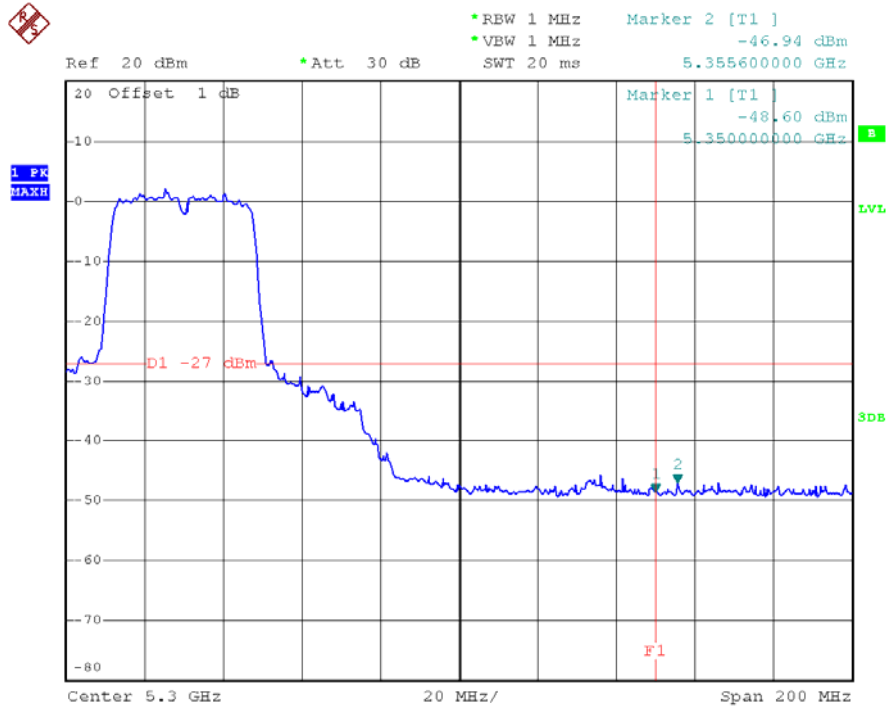

Date: 7.DEC.2012 13:32:32

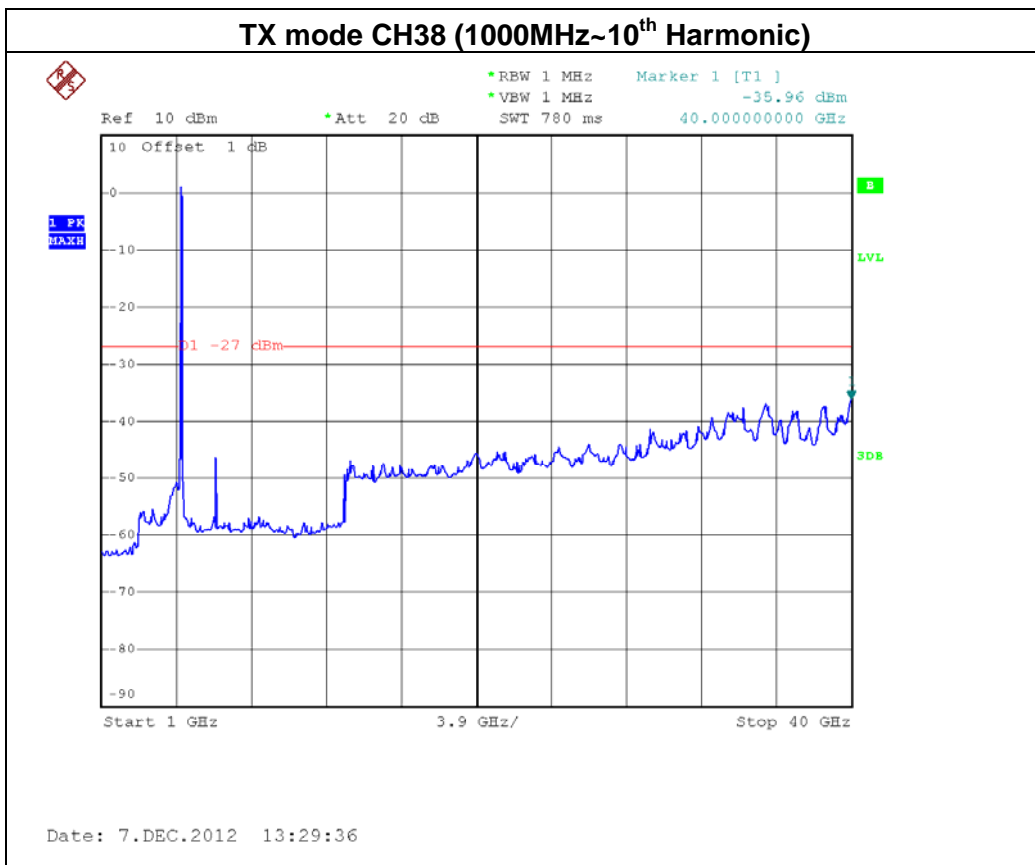
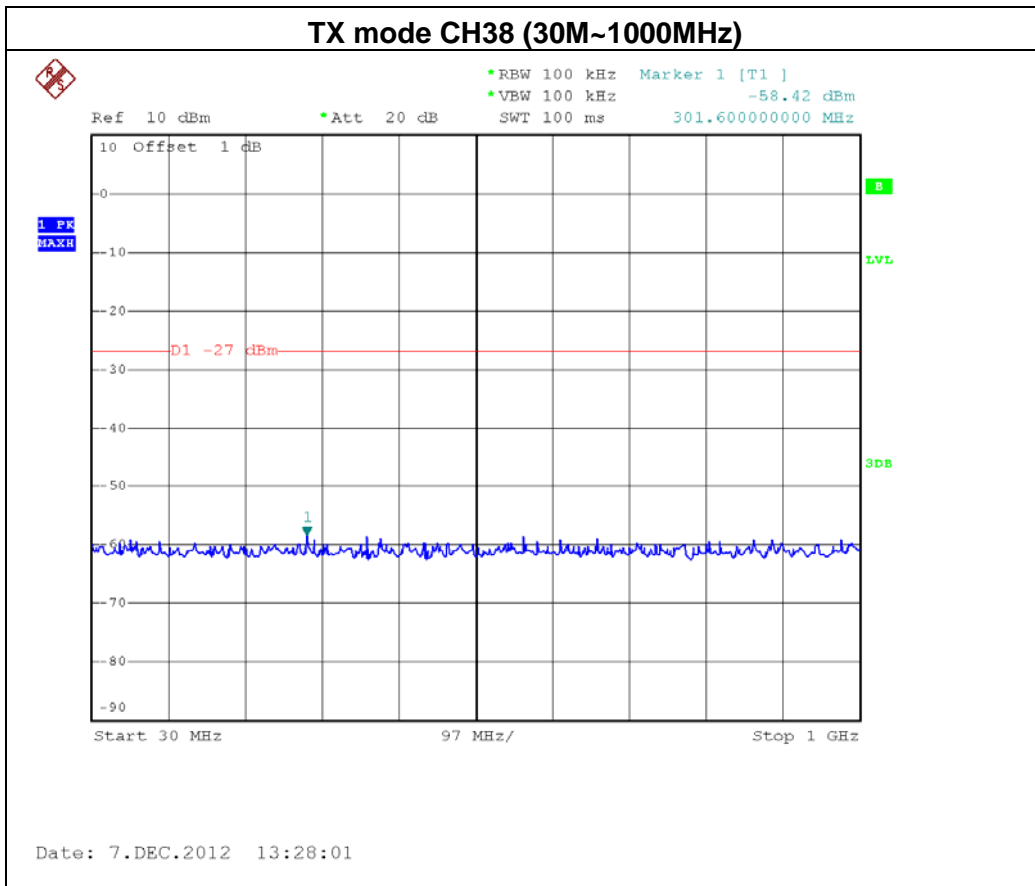

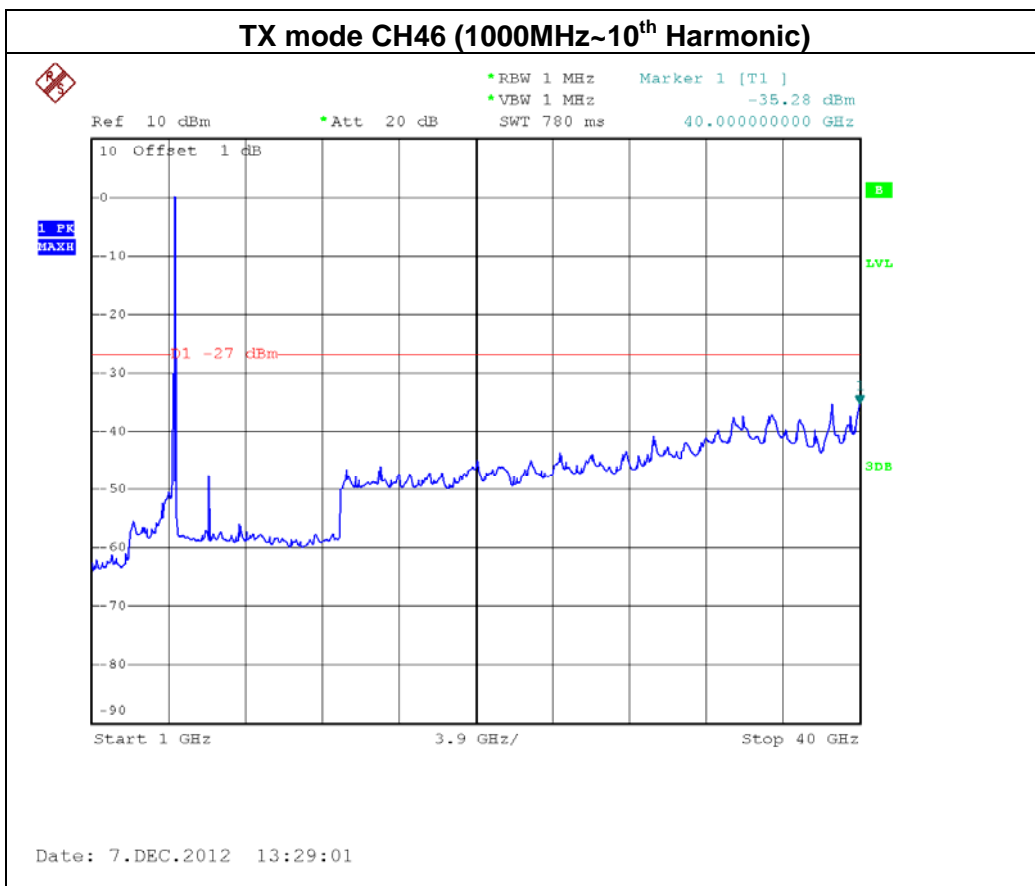
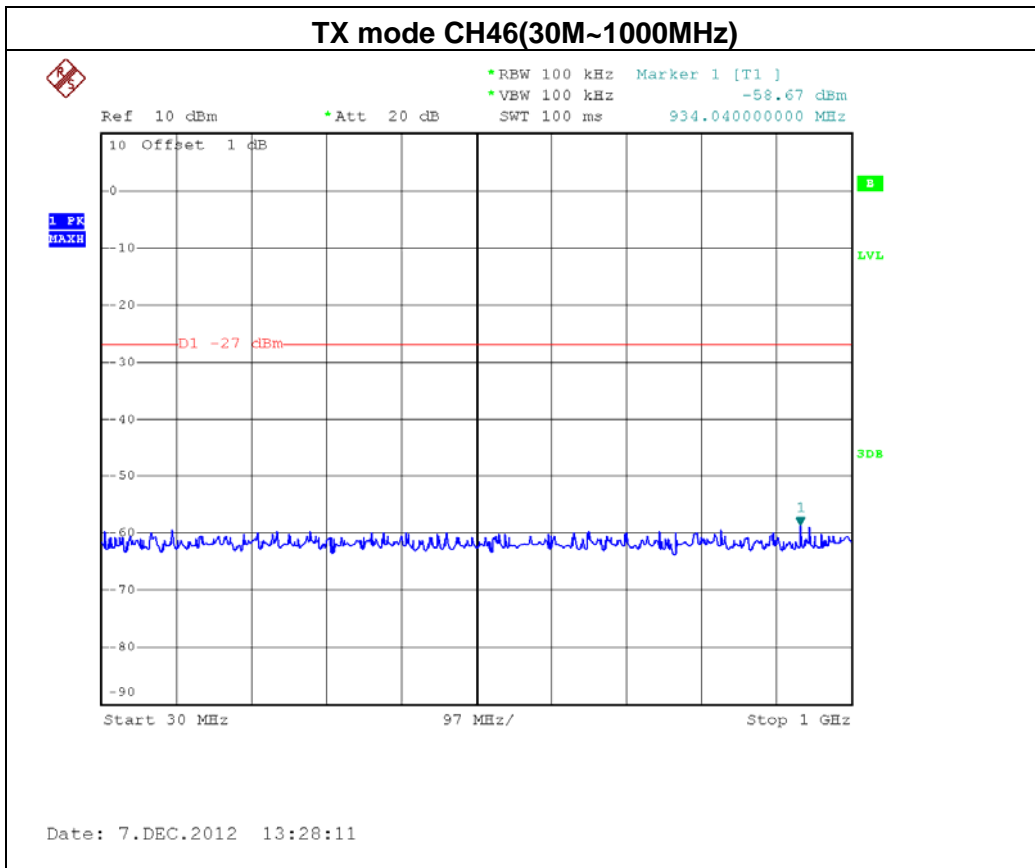



8. POWER SPECTRAL DENSITY TEST

8.1 APPLIED PROCEDURES / LIMIT

FCC Part15, Subpart E			
Test Item	Limit	Frequency Range (MHz)	Result
Power Spectral Density	4 dBm	5150 - 5250	PASS

8.1.1 MEASUREMENT INSTRUMENTS LIST

Item	Kind of Equipment	Manufacturer	Type No.	Serial No.	Last Calibration	Next Calibration
1	Spectrum Analyzer	R&S	FSP_40	100129	Nov.25.2012	Nov.16.2013

Remark: "N/A" denotes no model name, serial no. or calibration specified.
 All calibration period of Equipment List is One Year.

8.1.2 TEST PROCEDURE

a. The EUT was directly connected to the spectrum analyzer and antenna output port as show in the block diagram below,

b.

Spectrum Parameter	Setting
Attenuation	Auto
Span Frequency	Encompass the entire emissions bandwidth (EBW) of the signal
RB	1000 kHz
VB	3000 kHz
Detector	Peak
Trace	Max Hold
Sweep Time	Auto

8.1.3 DEVIATION FROM STANDARD

No deviation.

8.1.4 TEST SETUP



8.1.5 EUT OPERATION CONDITIONS

The EUT tested system was configured as the statements of 4.1.6 Unless otherwise a special operating condition is specified in the follows during the testing.



8.1.6 TEST RESULTS

EUT :	300Mbps Wireless Dual Band USB Adapter	Model Name :	WF2150
Temperature :	25 °C	Relative Humidity :	58 %
Test Voltage :	AC 120V/60Hz		
Test Mode :	Band 1/TX A Mode/CH36, CH40, CH48		

Test Channel	Frequency (MHz)	Power Density (dBm)	LIMIT (dBm)
CH36	5180	1.91	4.00
CH40	5210	2.17	4.00
CH48	5240	2.36	4.00

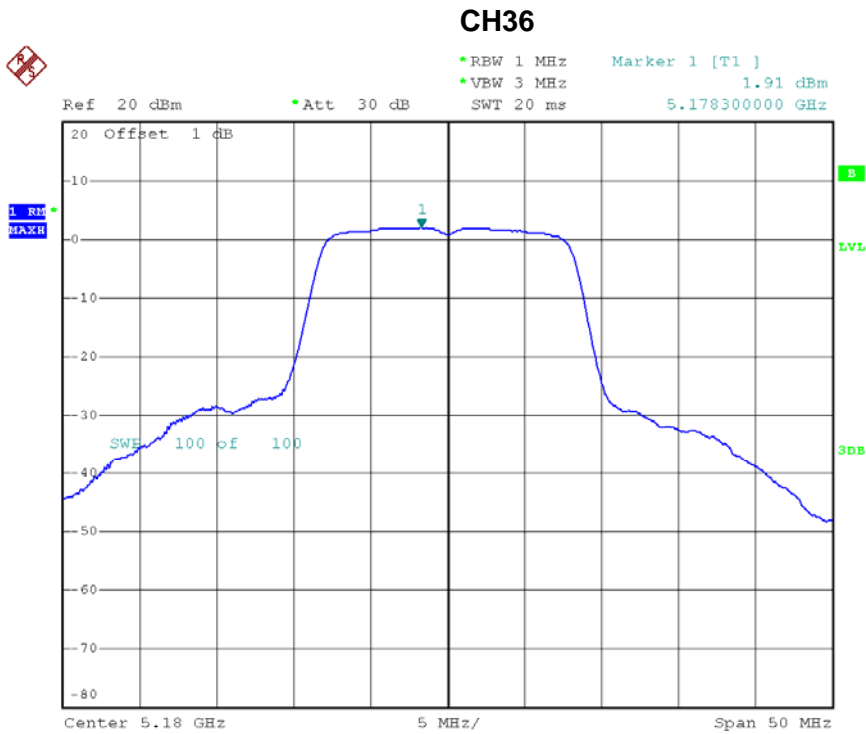

Date: 7.DEC.2012 12:57:22



CH40

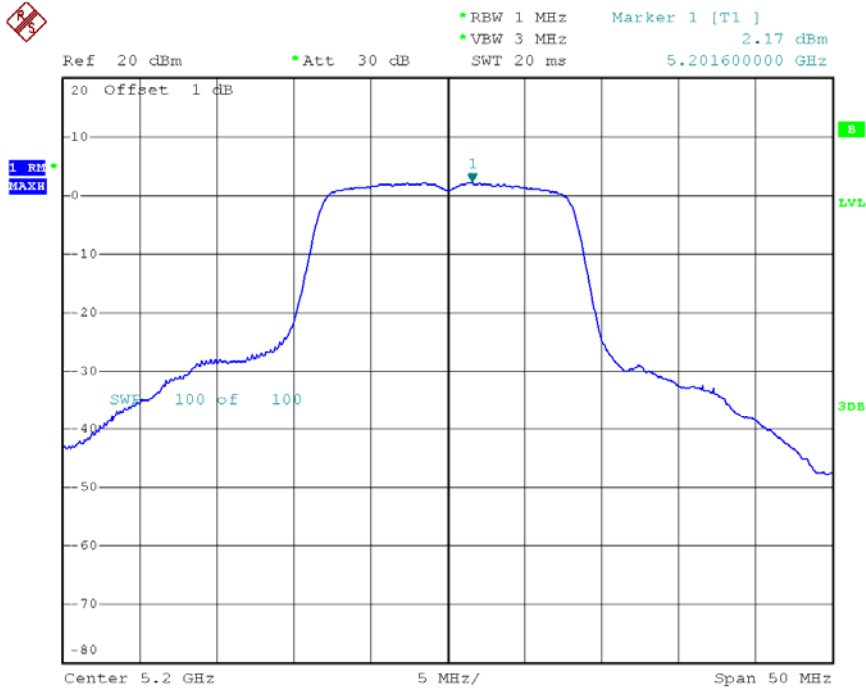

Date: 7.DEC.2012 12:57:41

CH48

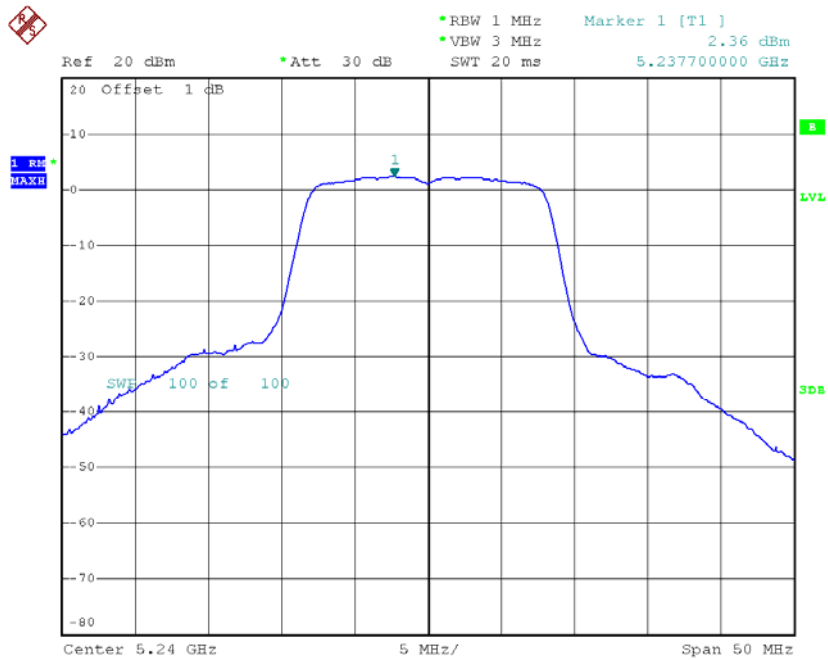

Date: 7.DEC.2012 12:58:01



EUT :	300Mbps Wireless Dual Band USB Adapter	Model Name :	WF2150
Temperature :	25 °C	Relative Humidity :	58 %
Test Voltage :	AC 120V/60Hz		
Test Mode :	Band 1/TX N20 Mode/CH36, CH40, CH48		

ANT 1			
Test Channel	Frequency (MHz)	Power Density (dBm)	LIMIT (dBm)
CH36	5180	-1.91	4.00
CH40	5210	-1.69	4.00
CH48	5240	-2.00	4.00

ANT 2			
Test Channel	Frequency (MHz)	Power Density (dBm)	LIMIT (dBm)
CH36	5180	-3.40	4.00
CH40	5210	-3.17	4.00
CH48	5240	-3.57	4.00

ANT 1+ANT 2			
Test Channel	Frequency (MHz)	Power Density (dBm)	LIMIT (dBm)
CH36	5180	0.42	4.00
CH40	5210	0.64	4.00
CH48	5240	0.30	4.00

Remark :

- (1) **The MIMO test requirement, RF conducted output power shall measure each transmitter chain by using channel power method.**
And after obtain each individual transmitter chain power, then sum the output power by using the following formula:

$$((\text{dBm}/\text{Chain 1})/10^{\wedge}\text{Log}) + ((\text{dBm}/\text{Chain 2})/10^{\wedge}\text{log}) + ((\text{dBm}/\text{ChainN})/10^{\wedge}\text{log}) =$$
Combined peak output power in mW.
- (2) **Antenna Gain=0 dBi.**
- (3) This EUT supports MIMO 2T2R, all transmit signals are completely uncorrelated, then,

$$\text{Directional gain} = G_{\text{ANT}} + 10 \log(\text{N}) \text{ dBi}$$
, that is Directional gain=3



CH36-ANT 1

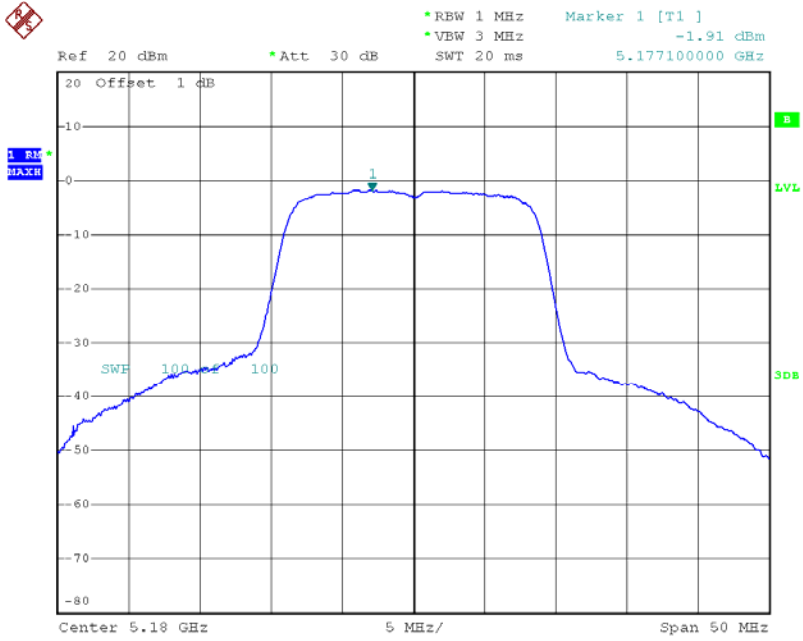

Date: 7.DEC.2012 13:15:34

CH40-ANT 1

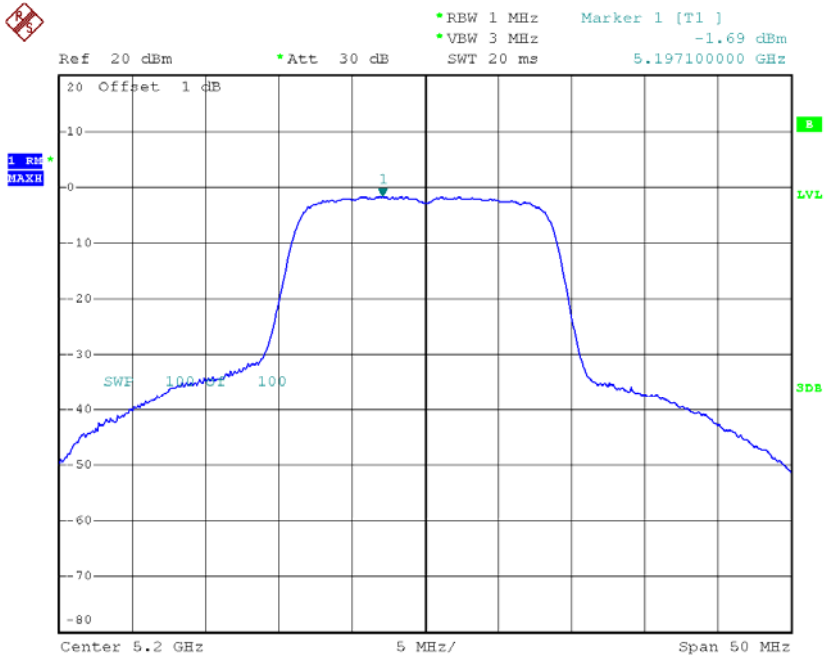

Date: 7.DEC.2012 13:15:51



CH48-ANT 1

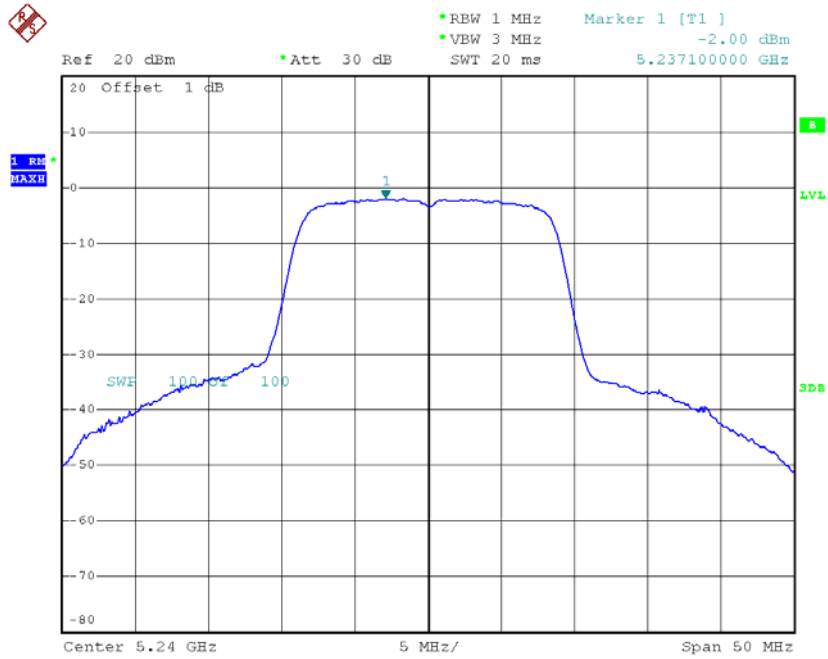

Date: 7.DEC.2012 13:16:09

CH36-ANT 2

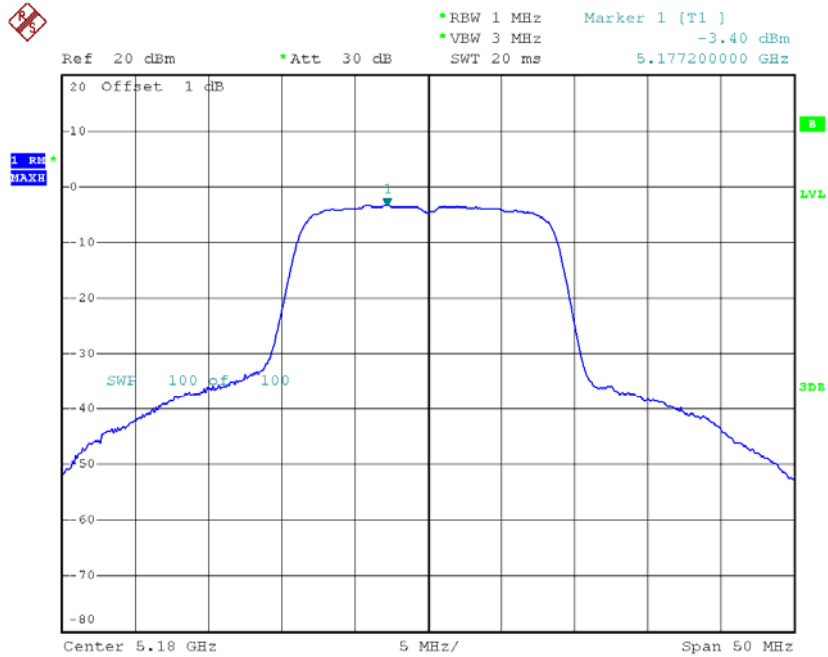

Date: 7.DEC.2012 13:40:27



CH40-ANT 2

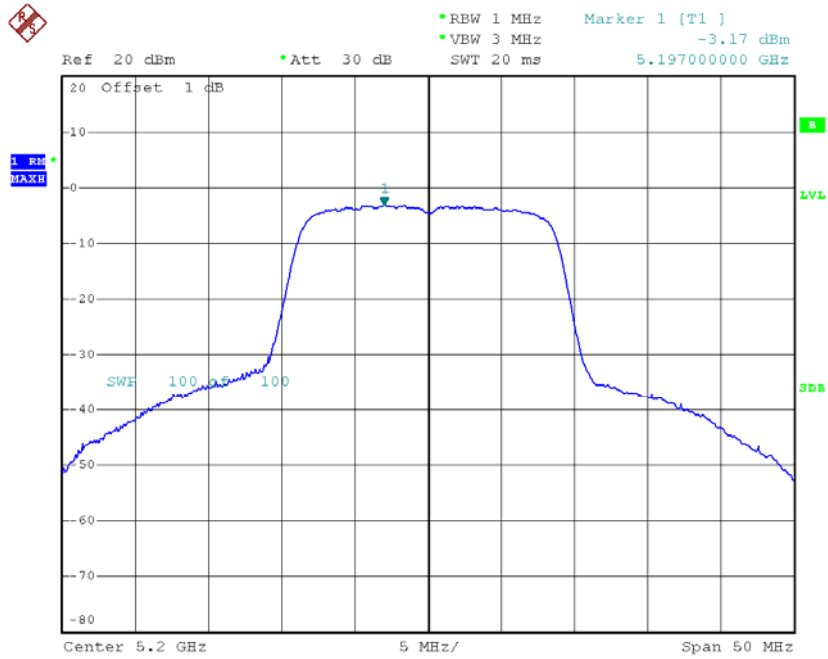

Date: 7.DEC.2012 13:40:46

CH48-ANT 2

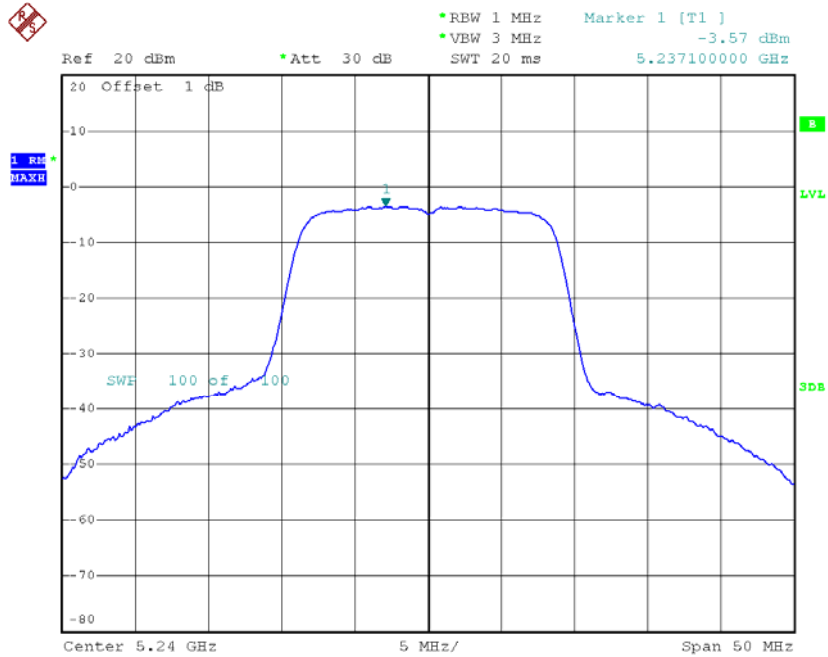

Date: 7.DEC.2012 13:42:32



EUT :	300Mbps Wireless Dual Band USB Adapter	Model Name :	WF2150
Temperature :	25 ° C	Relative Humidity :	58 %
Test Voltage :	AC 120V/60Hz		
Test Mode :	Band 1/TX N40 Mode/CH38, CH46 -ANT 1		

ANT 1			
Test Channel	Frequency (MHz)	Power Density (dBm)	LIMIT (dBm)
CH38	5190	-3.66	4.00
CH46	5230	-4.40	4.00

ANT 2			
Test Channel	Frequency (MHz)	Power Density (dBm)	LIMIT (dBm)
CH38	5190	-5.26	4.00
CH46	5230	-4.99	4.00

ANT 1+ANT 2			
Test Channel	Frequency (MHz)	Power Density (dBm)	LIMIT (dBm)
CH38	5190	-1.38	4.00
CH46	5230	-1.67	4.00

Remark :

- (1) **The MIMO test requirement, RF conducted output power shall measure each transmitter chain by using channel power method.**
And after obtain each individual transmitter chain power, then sum the output power by using the following formula:

$$((\text{dBm}/\text{Chain 1})/10^{\text{Log}}) + ((\text{dBm}/\text{Chain 2})/10^{\text{log}}) + ((\text{dBm}/\text{Chain N})/10^{\text{log}}) =$$
Combined peak output power in mW.
- (2) **Antenna Gain=0 dBi.**
- (3) This EUT supports MIMO 2T2R, all transmit signals are completely uncorrelated, then,
Directional gain = $G_{ANT} + 10 \log(N)$ dBi , that is Directional gain=3



CH38-ANT 1

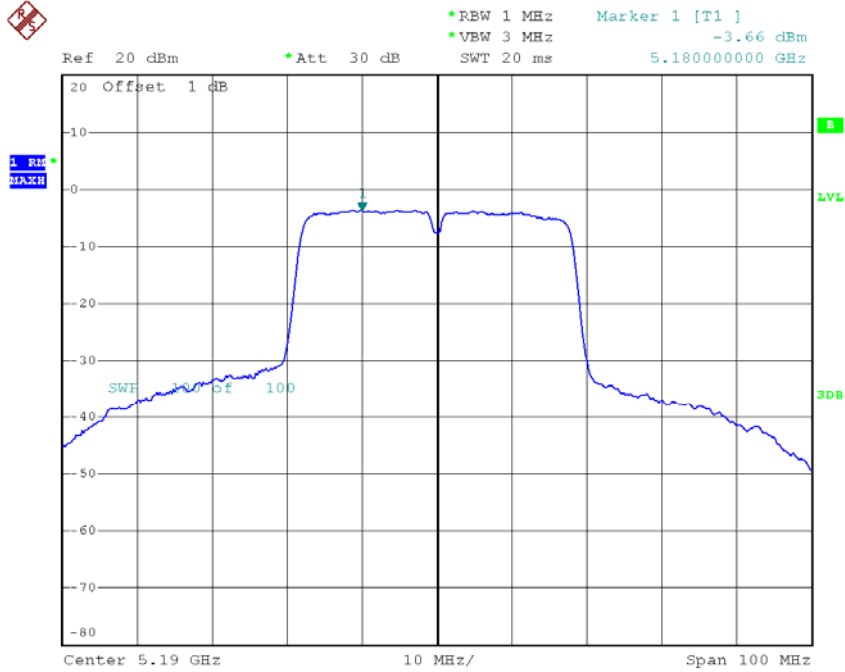

Date: 7.DEC.2012 13:18:27

CH46-ANT 1

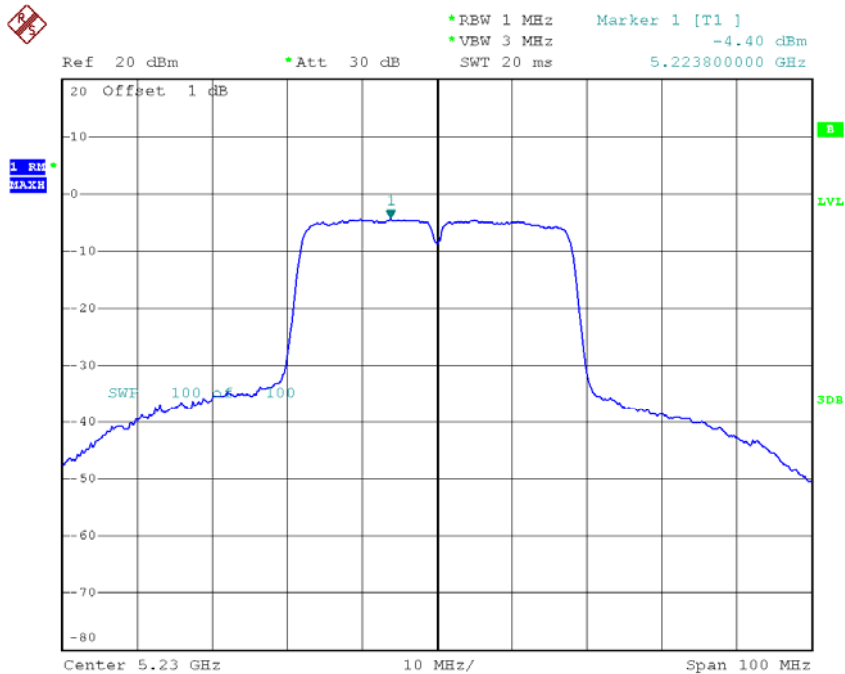

Date: 7.DEC.2012 13:22:01



CH38-ANT 2

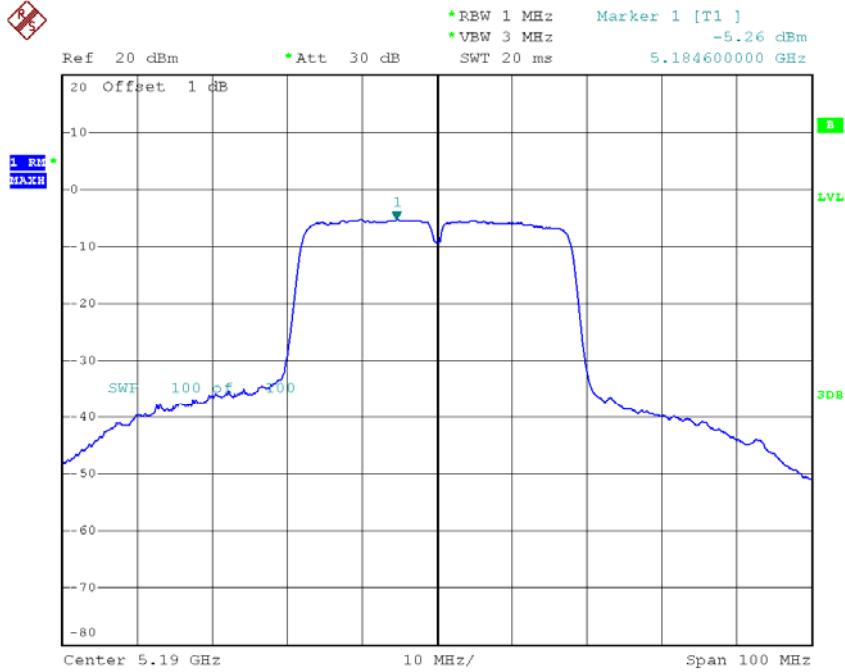

Date: 7.DEC.2012 13:35:54

CH46-ANT 2

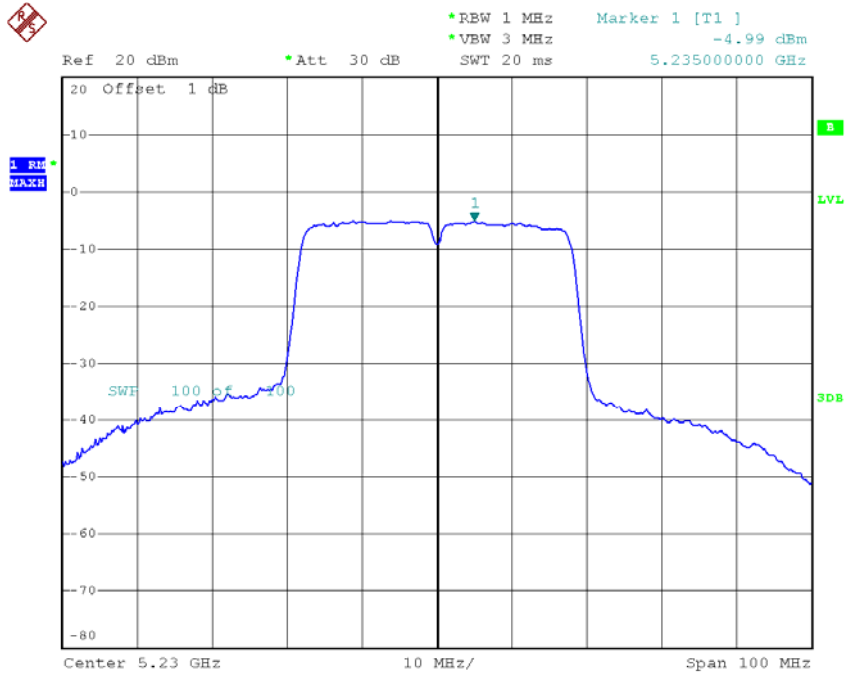

Date: 7.DEC.2012 13:35:00



9. PEAK EXCURSION MEASUREMENT

9.1 APPLIED PROCEDURES / LIMIT

FCC Part15, Subpart E			
Test Item	Limit	Frequency Range (MHz)	Result
Peak Excursion Measurement	13 dB	5150 - 5250	PASS

9.1.1 MEASUREMENT INSTRUMENTS LIST

Item	Kind of Equipment	Manufacturer	Type No.	Serial No.	Last Calibration	Next Calibration
1	Spectrum Analyzer	R&S	FSP_40	100129	Nov.25.2012	Nov.16.2013

Remark: "N/A" denotes no model name, serial no. or calibration specified.
 All calibration period of Equipment List is One Year.

9.1.2 TEST PROCEDURE

a. The EUT was directly connected to the spectrum analyzer and antenna output port as show in the block diagram below,

b.

Spectrum Parameter	Setting
Attenuation	Auto
Span Frequency	Encompass the entire emissions bandwidth (EBW) of the signal
RB	1000 kHz (Peak Trace) / 1000 kHz (Average Trace)
VB	3000 kHz (Peak Trace) / 300 kHz (Average Trace)
Detector	Peak (Peak Trace) / Sample (Average Trace)
Trace	Max Hold
Sweep Time	60s

- c. Peak Trace: Set RBW = 1 MHz, VBW ≥ 3 MHz with peak detector and maxhold settings.
- d. Average Trace: Method #3—video averaging with max hold--and sum power across the band. Set span to encompass the entire emissions bandwidth (EBW) of the signal. Set sweep trigger to "free run". Set RBW = 1 MHz. Set VBW ≥ 1/T (IEEE Band 1VBW = 300kHz ≥ 1/4μs). Use sample detector mode if bin width (i.e., span/number of points in spectrum) < 0.5 RBW. Otherwise use peak detector mode. Set max hold. Allow max hold to run for 60 seconds.

9.1.3 DEVIATION FROM STANDARD

No deviation.



9.1.4 TEST SETUP

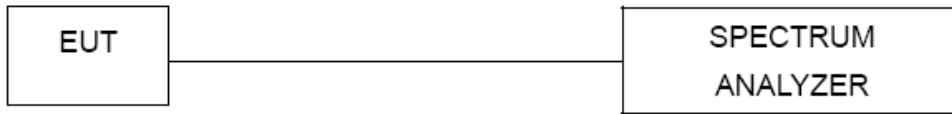

9.1.5 EUT OPERATION CONDITIONS

The EUT tested system was configured as the statements of 4.1.6 Unless otherwise a special operating condition is specified in the follows during the testing.



9.1.6 TEST RESULTS

EUT :	300Mbps Wireless Dual Band USB Adapter	Model Name :	WF2150
Temperature :	25 °C	Relative Humidity :	58 %
Test Voltage :	AC 120V/60Hz		
Test Mode :	Band 1/TX A Mode/CH36, CH40, CH48		

Test Channel	Frequency (MHz)	Peak Excursion (dB)	LIMIT (dB)
CH36	5180	4.10	13
CH40	5210	4.00	13
CH48	5240	5.50	13

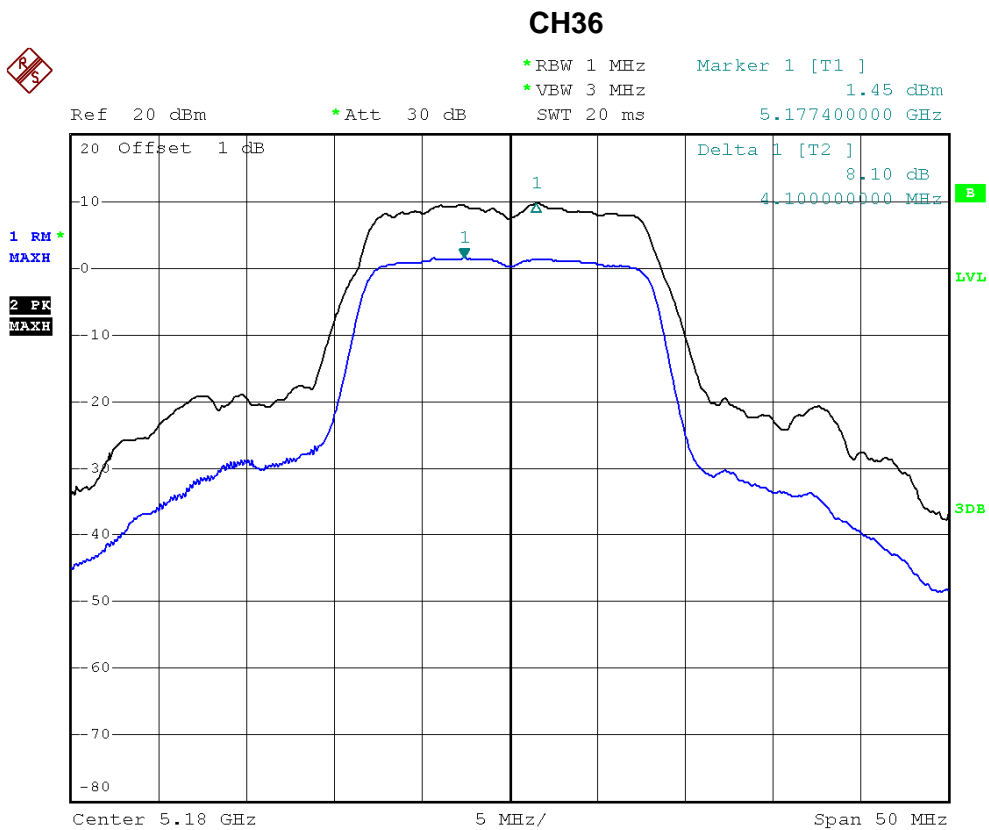

Date: 7.DEC.2012 13:53:58



CH40

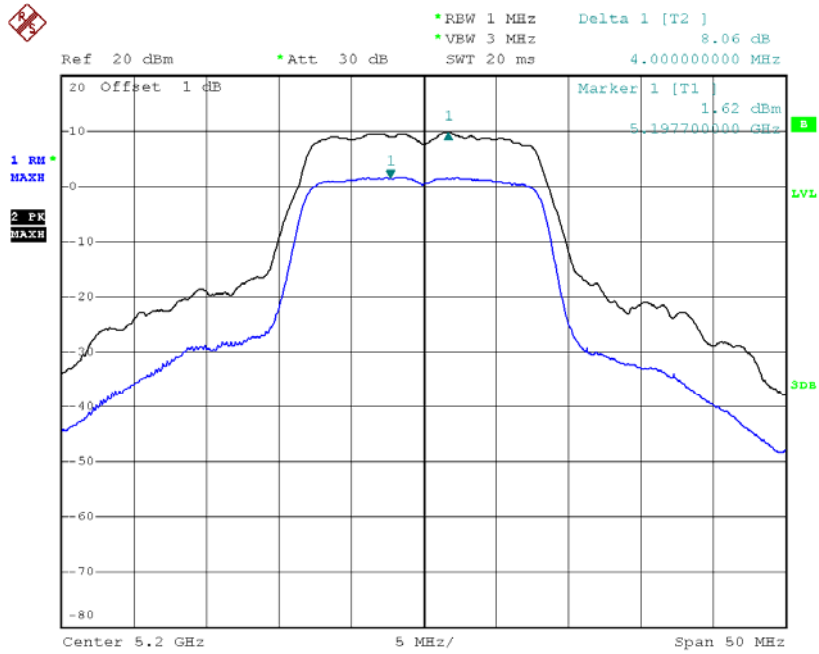

Date: 7.DEC.2012 13:54:36

CH48

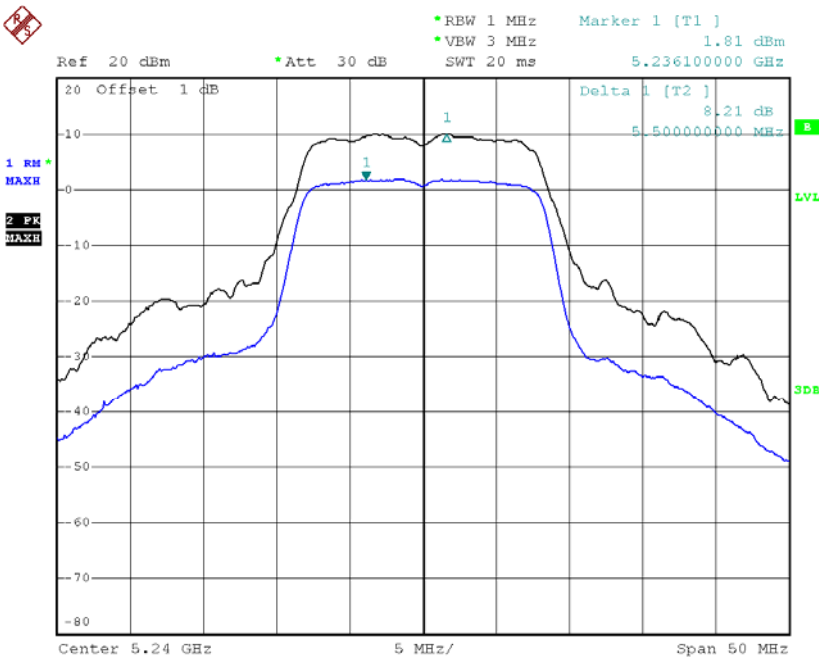

Date: 7.DEC.2012 13:55:02



EUT :	300Mbps Wireless Dual Band USB Adapter	Model Name :	WF2150
Temperature :	25 °C	Relative Humidity :	58 %
Test Voltage :	AC 120V/60Hz		
Test Mode :	Band 1/TX N20 Mode/CH36, CH40, CH48		

Test Channel	Frequency (MHz)	Peak Excursion (dB)	LIMIT (dB)
CH36	5180	4.60	13
CH40	5210	5.60	13
CH48	5240	5.50	13

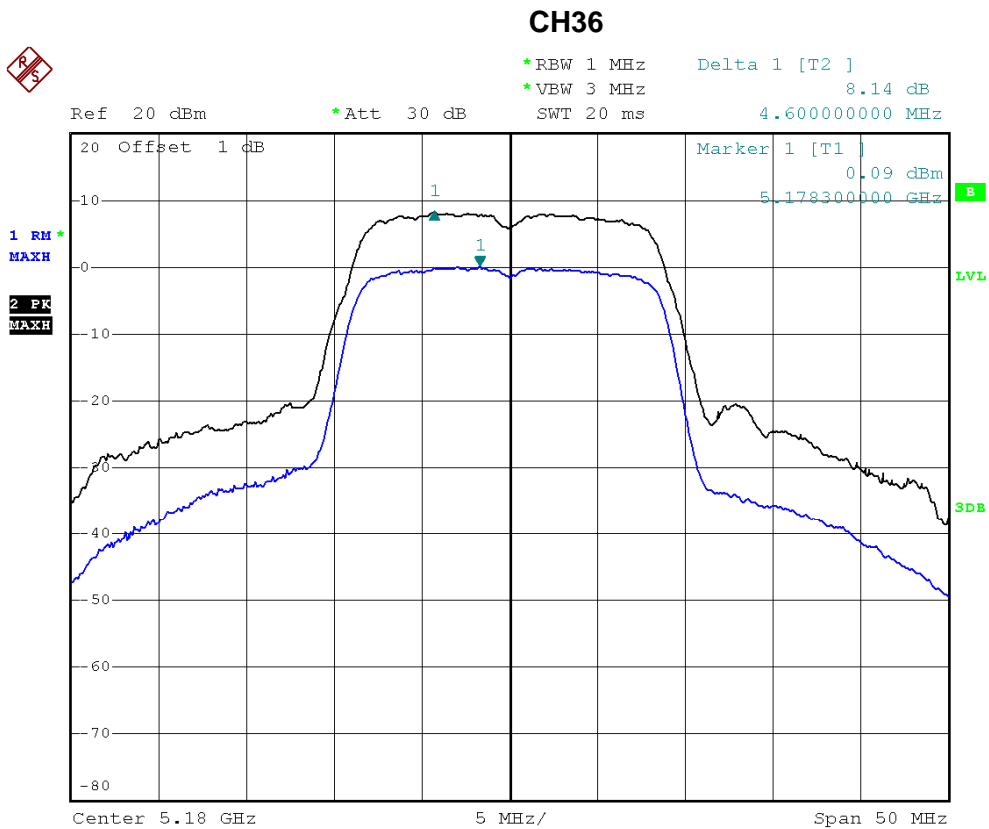

Date: 7.DEC.2012 13:55:36



CH40

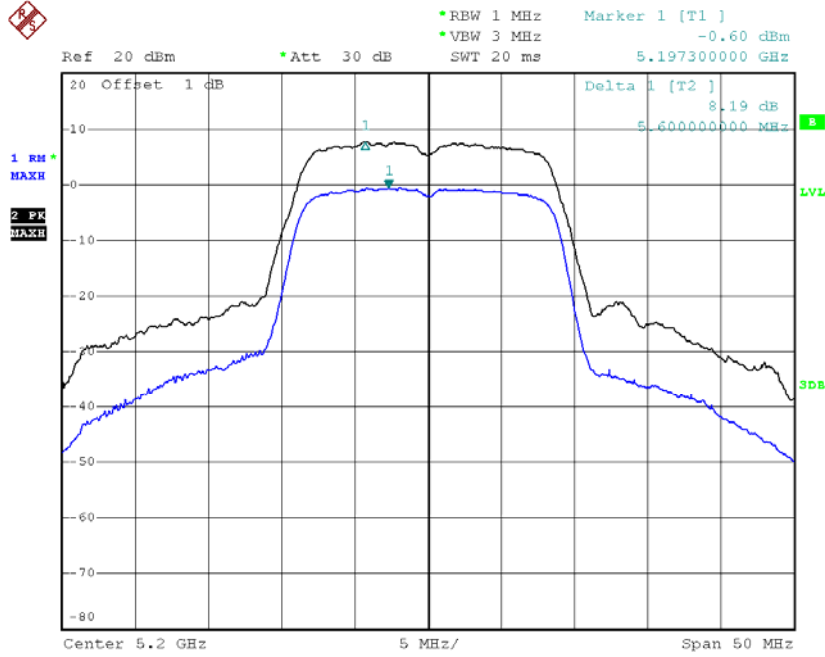

Date: 7.DEC.2012 13:55:57

CH48

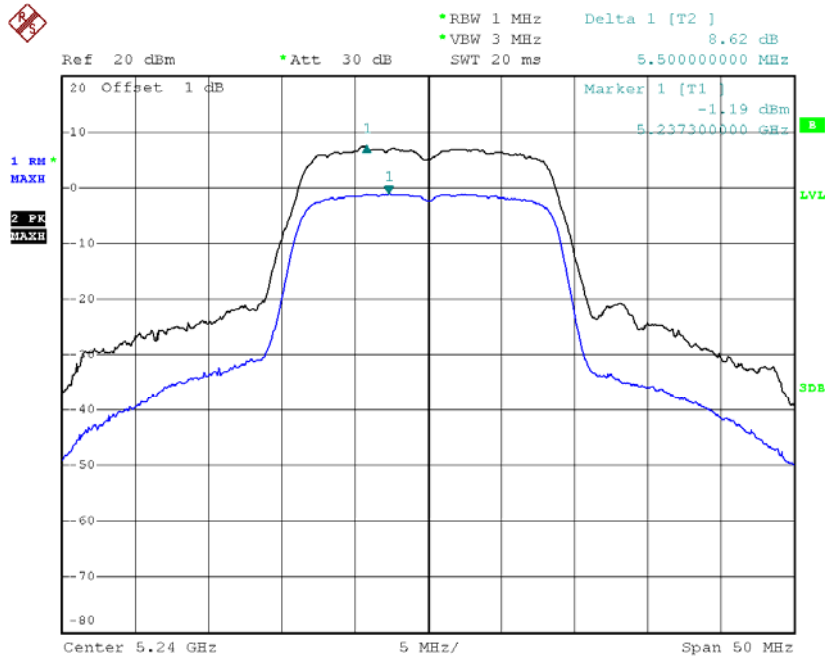

Date: 7.DEC.2012 13:56:31



EUT :	300Mbps Wireless Dual Band USB Adapter	Model Name :	WF2150
Temperature :	25 °C	Relative Humidity :	58 %
Test Voltage :	AC 120V/60Hz		
Test Mode :	Band 1/TX N40 Mode/CH38, CH46		

Test Channel	Frequency (MHz)	Peak Excursion (dB)	LIMIT (dB)
CH38	5190	5.60	13
CH46	5230	4.60	13

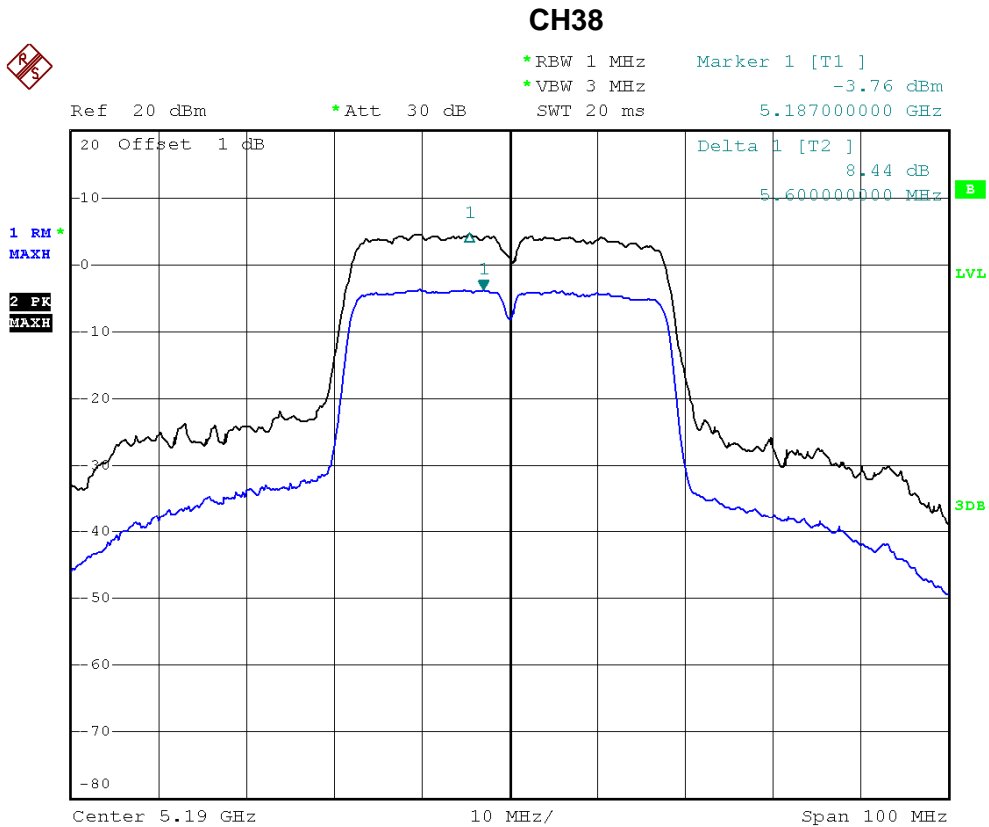

Date: 7.DEC.2012 13:57:19



CH46



*RBW 1 MHz Delta 1 [T2]
*VBW 3 MHz 8.91 dB
SWT 20 ms 4.600000000 MHz

Ref 20 dBm

*Att 30 dB

1 RM *
MAXH
2 PK
MAXH

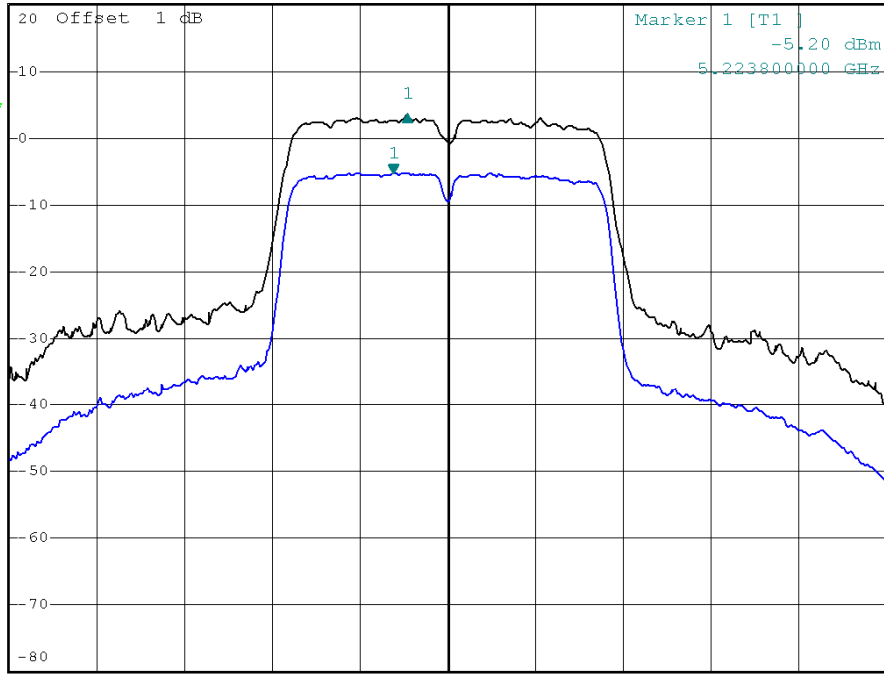

Center 5.23 GHz 10 MHz/ Span 100 MHz

Date: 7.DEC.2012 13:57:46



10. FREQUENCY STABILITY MEASUREMENT

10.1 APPLIED PROCEDURES / LIMIT

FCC Part15, Subpart E 15.407(g)			
Test Item	Limit	Frequency Range (MHz)	Result
Frequency Stability	specified in the user's manual	5150 - 5250	PASS

10.1.1 MEASUREMENT INSTRUMENTS LIST

Item	Kind of Equipment	Manufacturer	Type No.	Serial No.	Calibrated until
1	Spectrum Analyzer	R&S	FSP_40	100129	Nov.16.2013
2	Precision Oven Tester	HOLINK	H-T-1F-D	BA03101701	May.11.2013

Remark: "N/A" denotes no model name, serial no. or calibration specified.
 All calibration period of Equipment List is One Year.

10.1.2 TEST PROCEDURE

a. The EUT was directly connected to the spectrum analyzer and antenna output port as show in the block diagram below,

b.

Spectrum Parameter	Setting
Attenuation	Auto
Span Frequency	Entire absence of modulation emissions bandwidth
RB	10 kHz
VB	10 kHz
Sweep Time	Auto

c. The test extreme voltage is to change the primary supply voltage from 85 to 115 percent of the nominal value.
 d. user manual temperature is 0°C~60°C.

10.1.3 DEVIATION FROM STANDARD

No deviation.



10.1.4 TEST SETUP

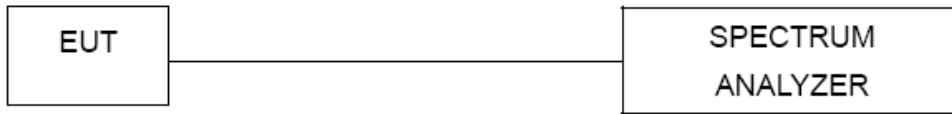

10.1.5 EUT OPERATION CONDITIONS

The EUT tested system was configured as the statements of 4.1.6 Unless otherwise a special operating condition is specified in the follows during the testing.



10.1.6 TEST RESULTS

EUT :	300Mbps Wireless Dual Band USB Adapter	Model Name :	WF2150
Temperature :	25 °C	Relative Humidity :	58 %
Test Voltage :	AC 120V/60Hz		
Test Mode :	Band 1		

Voltage vs. Frequency Stability

Voltage	Measurement Frequency (MHz)
138	5179.982000
120	5179.985000
102	5179.984000
Max. Deviation (MHz)	0.018000
Max. Deviation (ppm)	3.47

Temperature vs. Frequency Stability

Temperature	Measurement Frequency (MHz)
(°C)	5180
0	5179.982000
10	5179.984000
20	5179.981000
30	5179.983000
40	5179.980000
Max. Deviation (MHz)	0.020000
Max. Deviation (ppm)	3.86



11. EUT TEST PHOTO

Conducted Measurement Photos



Radiated Measurement Photos

