



# FCC Radio Test Report

## FCC ID: T58WF2109R1

This report concerns (check one) :  Original Grant  Class II Change

**Issued Date** : Aug. 23, 2011  
**Project No.** : 1108C127  
**Equipment** : 300Mbps Wireless-N USB Adapter  
**Model Name** : WF-2109  
**Applicant** : NETIS SYSTEMS CO., LTD.  
**Address** : 9F,B Block, Tsinghua Information Park, High-tech Industrial Park, Nanshan, Shenzhen, China  
**Manufacturer** : Shenzhen Netcore Industrial Ltd.  
**Address** : 9F,B Block, Tsinghua Information Park, High-tech Industrial Park, Nanshan, Shenzhen, China

**Tested by:**

Neutron Engineering Inc. EMC Laboratory

**Date of Receipt:** Aug. 12, 2011

**Date of Test:**

Aug. 12, 2011 ~ Aug. 22, 2011

Testing Engineer :   
(Ivan Cao)

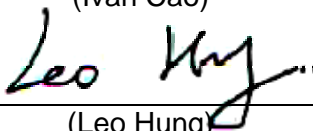
Technical Manager :   
(Leo Hung)

Authorized Signatory :   
(Steven Lu)

### **Neutron Engineering Inc.**

**No.3, Jinshagang 1st Road, ShiXia, Dalang  
Town, Dong Guan, China.  
TEL : (0769) 8318-3000 FAX : (0769) 8319-6000**



**Declaration**

**Neutron** represents to the client that testing is done in accordance with standard procedures as applicable and that test instruments used has been calibrated with the standards traceable to National Measurement Laboratory (**NML**) of **R.O.C.**, or National Institute of Standards and Technology (**NIST**) of **U.S.A.**

**Neutron's** reports apply only to the specific samples tested under conditions. It is manufacture's responsibility to ensure that additional production units of this model are manufactured with the identical electrical and mechanical components. **Neutron** shall have no liability for any declarations, inferences or generalizations drawn by the client or others from **Neutron** issued reports.

**Neutron's** reports must not be used by the client to claim product endorsement by the authorities or any agency of the Government.

This report is the confidential property of the client. As a mutual protection to the clients, the public and **Neutron-self**, extracts from the test report shall not be reproduced except in full with **Neutron's** authorized written approval.

**Neutron's** laboratory quality assurance procedures are in compliance with the **ISO Guide 17025** requirements, and accredited by the conformity assessment authorities listed in this test report.

**Limitation**

For the use of the authority's logo is limited unless the Test Standard(s)/Scope(s)/Item(s) mentioned in this test report is (are) included in the conformity assessment authorities acceptance respective.



| <b>Table of Contents</b>                                    | <b>Page</b> |
|---|-------------|
| <b>1 . CERTIFICATION</b>                                    | <b>5</b>    |
| <b>2 . SUMMARY OF TEST RESULTS</b>                          | <b>6</b>    |
| 2.1 TEST FACILITY   | 7           |
| 2.2 MEASUREMENT UNCERTAINTY                                 | 7           |
| <b>3 . GENERAL INFORMATION</b>                              | <b>8</b>    |
| 3.1 GENERAL DESCRIPTION OF EUT                              | 8           |
| 3.2 DESCRIPTION OF TEST MODES                               | 10          |
| 3.3 TABLE OF PARAMETERS OF TEXT SOFTWARE SETTING            | 11          |
| 3.4 BLOCK DIGRAM SHOWING THE CONFIGURATION OF SYSTEM TESTED | 12          |
| 3.5 DESCRIPTION OF SUPPORT UNITS (RADIATED MODE)            | 13          |
| <b>4 . EMC EMISSION TEST</b>                                | <b>15</b>   |
| 4.1 CONDUCTED EMISSION MEASUREMENT                          | 15          |
| 4.1.1 POWER LINE CONDUCTED EMISSION LIMITS                  | 15          |
| 4.1.2 MEASUREMENT INSTRUMENTS LIST AND SETTING              | 15          |
| 4.1.3 TEST PROCEDURE  | 16          |
| 4.1.4 DEVIATION FROM TEST STANDARD                          | 16          |
| 4.1.5 TEST SETUP  | 16          |
| 4.1.6 EUT OPERATING CONDITIONS                              | 16          |
| 4.1.7 TEST RESULTS  | 17          |
| 4.2 RADIATED EMISSION MEASUREMENT                           | 19          |
| 4.2.1 RADIATED EMISSION LIMITS                              | 19          |
| 4.2.2 MEASUREMENT INSTRUMENTS LIST ANS SETTING              | 20          |
| 4.2.3 TEST PROCEDURE  | 21          |
| 4.2.4 DEVIATION FROM TEST STANDARD                          | 21          |
| 4.2.5 TEST SETUP  | 22          |
| 4.2.6 EUT OPERATING CONDITIONS                              | 22          |
| 4.2.7 TEST RESULTS (BETWEEN 30 – 1000 MHZ)                  | 23          |
| 4.2.8 TEST RESULTS (ABOVE 1000 MHZ)                         | 25          |
| <b>5 . BANDWIDTH TEST</b>                                   | <b>73</b>   |
| 5.1 APPLIED PROCEDURES / LIMIT                              | 73          |
| 5.1.1 MEASUREMENT INSTRUMENTS LIST                          | 73          |
| 5.1.2 TEST PROCEDURE  | 73          |
| 5.1.3 DEVIATION FROM STANDARD                               | 73          |
| 5.1.4 TEST SETUP  | 73          |
| 5.1.5 EUT OPERATION CONDITIONS                              | 73          |
| 5.1.6 TEST RESULTS  | 74          |



| <b>Table of Contents</b>                       | <b>Page</b> |
|--|-------------|
| <b>6 . MAXIMUM OUTPUT POWER TEST</b>           | <b>82</b>   |
| <b>6.1 APPLIED PROCEDURES / LIMIT</b>          | <b>82</b>   |
| 6.1.1 MEASUREMENT INSTRUMENTS LIST             | 82          |
| 6.1.2 TEST PROCEDURE                           | 82          |
| 6.1.3 DEVIATION FROM STANDARD                  | 82          |
| 6.1.4 TEST SETUP                               | 82          |
| 6.1.5 EUT OPERATION CONDITIONS                 | 82          |
| 6.1.6 TEST RESULTS                             | 83          |
| <b>7 . ANTENNA CONDUCTED SPURIOUS EMISSION</b> | <b>96</b>   |
| <b>7.1 APPLIED PROCEDURES / LIMIT</b>          | <b>96</b>   |
| 7.1.1 MEASUREMENT INSTRUMENTS LIST             | 96          |
| 7.1.2 TEST PROCEDURE                           | 96          |
| 7.1.3 DEVIATION FROM STANDARD                  | 96          |
| 7.1.4 TEST SETUP                               | 96          |
| 7.1.5 EUT OPERATION CONDITIONS                 | 96          |
| 7.1.6 TEST RESULTS                             | 97          |
| <b>8 . POWER SPECTRAL DENSITY TEST</b>         | <b>127</b>  |
| <b>8.1 APPLIED PROCEDURES / LIMIT</b>          | <b>127</b>  |
| 8.1.1 MEASUREMENT INSTRUMENTS LIST             | 127         |
| 8.1.2 TEST PROCEDURE                           | 127         |
| 8.1.3 DEVIATION FROM STANDARD                  | 127         |
| 8.1.4 TEST SETUP                               | 127         |
| 8.1.5 EUT OPERATION CONDITIONS                 | 127         |
| 8.1.6 TEST RESULTS                             | 128         |
| <b>9 . EUT TEST PHOTO</b>                      | <b>140</b>  |



## 1. CERTIFICATION

Equipment : 300Mbps Wireless-N USB Adapter

Brand Name : netis

Model Name : WF-2109

Applicant : NETIS SYSTEMS CO., LTD.

Factory : Dongguan City Netcore Network Technology Co.,Ltd.

Address : No.10-1,Sankeng Road,Qinghutou,Tangxia Town,Dongguan City

Date of Test : Aug. 12, 2011 ~ Aug. 22, 2011

Test Item : ENGINEERING SAMPLE

Standards : FCC Part15, Subpart C(15.247) / ANSI C63.4 : 2003

The above equipment has been tested and found compliance with the requirement of the relative standards by Neutron Engineering Inc. EMC Laboratory.

The test data, data evaluation, and equipment configuration contained in our test report (Ref No. NEI-FCCP-1-1108C127) were obtained utilizing the test procedures, test instruments, test sites that has been accredited by the Authority of NVLAP and TAF according to the ISO-17025 quality assessment standard and technical standard(s).



## 2. SUMMARY OF TEST RESULTS

Test procedures according to the technical standards:

| <b>FCC Part15 (15.247) , Subpart C</b> |               |                                     |          |        |
|--|---------------|-------------------------------------|----------|--------|
| Standard                               | Section       | Test Item                           | Judgment | Remark |
|  | 15.207        | Conducted Emission                  | PASS     |        |
|  | 15.247(d)     | Antenna conducted Spurious Emission | PASS     |        |
|  | 15.247(a)(2)  | 6dB Bandwidth                       | PASS     |        |
|  | 15.247(b)(3)  | Peak Output Power                   | PASS     |        |
|  | 15.209/15.205 | Radiated Spurious Emission          | PASS     |        |
|  | 15.247(e)     | Power Spectral Density              | PASS     |        |
|  | 15.203        | Antenna Requirement                 | PASS     |        |

**NOTE:**

(1) "N/A" denotes test is not applicable in this Test Report



**2.1 TEST FACILITY**

The test facilities used to collect the test data in this report is **DG-CB03/DG-C02** at the location of No.3, Jinshagang 1st Road, ShiXia, Dalang Town, Dong Guan, China.523792  
 Neutron's test firm number is 319330

**2.2 MEASUREMENT UNCERTAINTY**

Where relevant, the following measurement uncertainty levels have been estimated for tests performed on the EUT as specified in CISPR 16-4-2:

The reported uncertainty of measurement  $y \pm U$ , where expanded uncertainty U is based on a standard uncertainty multiplied by a coverage factor of  $k=2$ , providing a level of confidence of approximately 95 %.

**A. Conducted Measurement :**

| Test Site | Method | Measurement Frequency Range | U , (dB) | NOTE |
|-----------|--------|-----------------------------|----------|------|
| DG-C02    | CISPR  | 150 KHz ~ 30MHz             | 1.94     |      |

**B. Radiated Measurement :**

| Test Site | Method | Measurement Frequency Range | Ant. H / V | U , (dB) | NOTE |
|-----------|--------|-----------------------------|------------|----------|------|
| DG-CB03   | CISPR  | 30MHz ~ 200MHz              | V          | 3.82     |      |
|           |        | 30MHz ~ 200MHz              | H          | 3.60     |      |
|           |        | 200MHz ~ 1,000MHz           | V          | 3.86     |      |
|           |        | 200MHz ~ 1,000MHz           | H          | 3.94     |      |



**3. GENERAL INFORMATION**

**3.1 GENERAL DESCRIPTION OF EUT**

|                        |  |  |
|------------------------|--|--|
| Equipment              | 300Mbps Wireless-N USB Adapter   |  |
| Brand Name             | netis  |  |
| Model Name             | WF-2109  |  |
| OEM Brand/Model Name   | N/A  |  |
| Model Difference       | N/A  |  |
| Product Description    | The EUT is a 300Mbps Wireless-N USB Adapter.   |  |
|                        | Operation Frequency:   | 2412~2462 MHz  |
|                        | Modulation Type:   | 802.11b:CCK, DQPSK, DBPSK<br>802.11g:OFDM<br>802.11n:OFDM  |
|                        | Bit Rate of Transmitter  | 802.11b:11/5.5/2/1 Mbps<br>802.11g:54/48/36/24/18/12/9/6 Mbps<br>Draft 802.11n:up to 300Mbps     |
|                        | Number of Channel  | 11 CH, Please see Note 2.<br>(please see page 9)   |
|                        | Antenna Designation:   | Please see Note 3.   |
|                        | Antenna Gain(Peak)   | (please see page 9)  |
|                        | Output Power:  | 802.11b: 13.22dBm<br>802.11g: 13.50dBm<br>802.11n(20MHz): 13.35 dBm<br>802.11n(40MHz): 13.15 dBm |
|                        | Based on the application, features, or specification exhibited in User's Manual, the EUT is considered as an ITE/Computing Device. More details of EUT technical specification, please refer to the User's Manual. |  |
|                        | Power Source   | DC Voltage supplied from Host system   |
| Power Rating           | I/P 120V/60Hz, O/P DC 5V   |  |
| Connecting I/O Port(s) | Please refer to the User's Manual  |  |
| Products Covered       | N/A  |  |
| Products Covered       | N/A  |  |

**Note:**

1. For a more detailed features description, please refer to the manufacturer's specifications or the User's Manual.





2. CH 01 – CH 11 for 802.11b, 802.11g, 802.11n(20MHz)  
 CH 03 – CH 09 for 802.11n(40MHz)

**Channel List**

| Channel | Frequency (MHz) | Channel | Frequency (MHz) | Channel | Frequency (MHz) | Channel | Frequency (MHz) |
|---------|-----------------|---------|-----------------|---------|-----------------|---------|-----------------|
| 01      | 2412            | 04      | 2427            | 07      | 2442            | 10      | 2457            |
| 02      | 2417            | 05      | 2432            | 08      | 2447            | 11      | 2462            |
| 03      | 2422            | 06      | 2437            | 09      | 2452            |         |                 |

3. Table for Filed Antenna

| Ant. | Brand | Model Name | Antenna Type | Connector | Gain (dBi) |
|------|-------|------------|--------------|-----------|------------|
| 1    | N/A   | N/A        | Printed      | N/A       | 0          |
| 2    | N/A   | N/A        | Printed      | N/A       | 0          |

4. The EUT incorporates a MIMO function. Physically, the EUT provides two completed transmitters and two receivers (2T2R).

| Operating Mode / TX Mode | 1TX              | 2TX             |
|--------------------------|------------------|-----------------|
| 802.11b                  | V (ANT1 or ANT2) | -               |
| 802.11g                  | V (ANT1 or ANT2) | -               |
| 802.11n(20MHz)           | -                | V (ANT1 & ANT2) |
| 802.11n(40MHz)           | -                | V (ANT1 & ANT2) |



**3.2 DESCRIPTION OF TEST MODES**

To investigate the maximum EMI emission characteristics generates from EUT, the test system was pre-scanning tested base on the consideration of following EUT operation mode or test configuration mode which possible have effect on EMI emission level. Each of these EUT operation mode(s) or test configuration mode(s) mentioned above was evaluated respectively.

| Pretest Mode | Description                      |
|--------------|----------------------------------|
| Mode 1       | TX B MODE CHANNEL 01//06/11      |
| Mode 2       | TX G MODE CHANNEL 01/06/11       |
| Mode 3       | TX N-20MHZ MODE CHANNEL 01/06/11 |
| Mode 4       | TX N-40MHZ MODE CHANNEL 03/06/09 |
| Mode 5       | Normal Link                      |

The EUT system operated these modes were found to be the worst case during the pre-scanning test as Following:

| For Conducted Test |             |
|--------------------|-------------|
| Final Test Mode    | Description |
| Mode 5             | Normal Link |

| For Radiated Test |                                  |
|-------------------|----------------------------------|
| Final Test Mode   | Description                      |
| Mode 1            | TX B MODE CHANNEL 01/06/11       |
| Mode 2            | TX G MODE CHANNEL 01/06/11       |
| Mode 3            | TX N-20MHZ MODE CHANNEL 01/06/11 |
| Mode 4            | TX N-40MHZ MODE CHANNEL 03/06/09 |

Note:

- (1) The measurements are performed at the highest, middle, lowest available channels.
- (2) During the output power test, all data rates have been investigated and the highest output powers were recorded are as follows:  
 802.11b mode: DBPSK (1Mbps)  
 802.11g mode: OFDM (6Mbps)  
 802.11n HT20/HT40 mode : MCS8 (6Mbps)  
 For radiated emission tests, the highest output powers were set for final test.
- (3) Worst-case mode and channel used for 30-1000 MHz radiated and power line conducted emissions was the mode and channel with the highest output power, that was determined to be 11G Channel 01



**3.3 TABLE OF PARAMETERS OF TEXT SOFTWARE SETTING**

During testing channel & power controlling software provided by the customer was used to control the operating channel as well as the output power level. The RF output power selection is for the setting of RF output power expected by the customer and is going to be fixed on the firmware of the final end product power parameters of WLAN

| Test software Version | Test Program: RT3x7xQA |                 |                 |
|-----------------------|------------------------|-----------------|-----------------|
| <b>Frequency</b>      | <b>2412 MHz</b>        | <b>2437 MHz</b> | <b>2462 MHz</b> |
| IEEE 802.11b DSSS     | 40                     | 40              | 40              |
| IEEE 802.11g OFDM     | 48                     | 48              | 48              |

| Test software Version  | Test Program: RT3x7xQA |                 |                 |
|------------------------|------------------------|-----------------|-----------------|
| <b>Frequency (MHz)</b> | <b>2412 MHz</b>        | <b>2437 MHz</b> | <b>2462 MHz</b> |
| IEEE 802.11n (20MHz)   | 48(ANT1)               | 48(ANT1)        | 48(ANT1)        |
|                        | 48(ANT2)               | 48(ANT2)        | 48(ANT2)        |
| <b>Frequency (MHz)</b> | <b>2422 MHz</b>        | <b>2437 MHz</b> | <b>2452 MHz</b> |
| IEEE 802.11n (40MHz)   | 48(ANT1)               | 48(ANT1)        | 48(ANT1)        |
|                        | 48(ANT2)               | 48(ANT2)        | 48(ANT2)        |



### 3.4 BLOCK DIGRAM SHOWING THE CONFIGURATION OF SYSTEM TESTED

#### Radiated TX Mode:

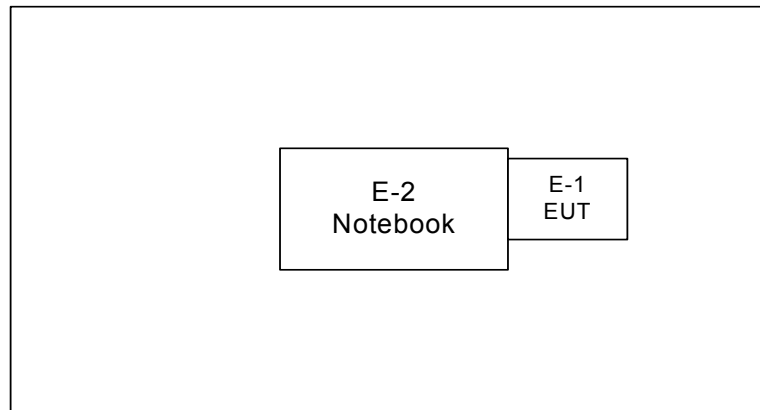

#### Conducted Mode:

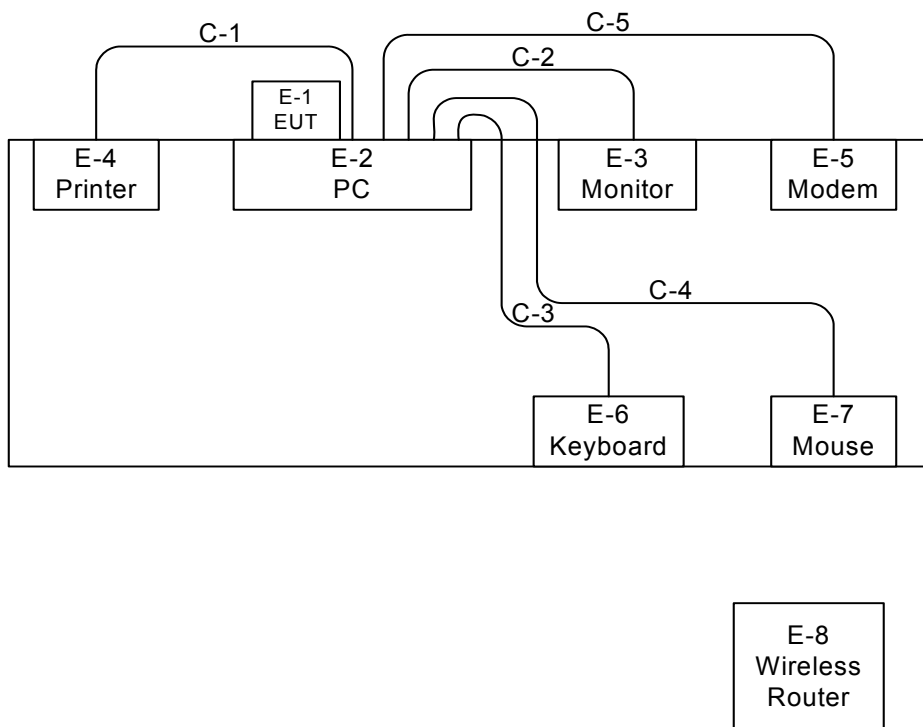

- C-1: Parallel Cable
- C-2: D-Sub Cable
- C-3: USB Cable
- C-4: USB Cable
- C-5: RS232 Cable



**3.5 DESCRIPTION OF SUPPORT UNITS (RADIATED MODE)**

The EUT has been tested as an independent unit together with other necessary accessories or support units. The following support units or accessories were used to form a representative test configuration during the tests.

| Item | Equipment                      | Mfr/Brand | Model/Type No. | FCC ID      | Series No. | Note |
|------|--------------------------------|-----------|----------------|-------------|------------|------|
| E-1  | 300Mbps Wireless-N USB Adapter | netis     | WF-2109        | T58WF2109R1 | N/A        | EUT  |
| E-2  | Notebook                       | DELL      | 1420           | DOC         | N/A        |      |
|      |                                |           |                |             |            |      |
|      |                                |           |                |             |            |      |
|      |                                |           |                |             |            |      |
|      |                                |           |                |             |            |      |
|      |                                |           |                |             |            |      |
|      |                                |           |                |             |            |      |

| Item | Shielded Type | Ferrite Core | Length | Note |
|------|---------------|--------------|--------|------|
|      |               |              |        |      |
|      |               |              |        |      |
|      |               |              |        |      |
|      |               |              |        |      |
|      |               |              |        |      |
|      |               |              |        |      |
|      |               |              |        |      |
|      |               |              |        |      |

Note:

- (1) The support equipment was authorized by Declaration of Confirmation.
- (2) For detachable type I/O cable should be specified the length in cm in 『Length』 column.



**3.6 DESCRIPTION OF SUPPORT UNITS (CONDUCTED MODE)**

The EUT has been tested as an independent unit together with other necessary accessories or support units. The following support units or accessories were used to form a representative test configuration during the tests.

| Item | Equipment                      | Mfr/Brand | Model/Type No. | FCC ID      | Series No.                  | Note |
|------|--------------------------------|-----------|----------------|-------------|-----------------------------|------|
| E-1  | 300Mbps Wireless-N USB Adapter | netis     | WF-2109        | T58WF2109R1 | N/A                         | EUT  |
| E-2  | PC                             | Dell 745  | DCSM           | DOC         | G7K832X                     |      |
| E-3  | LCD monitor                    | Dell      | E177FPc        | DOC         | CNOFJ179-641<br>80-6AG-1WNS |      |
| E-4  | Printer                        | Lenovo    | M630           | DOC         | SP00335371                  |      |
| E-5  | Modem                          | Lenovo    | LEM56SP        | DOC         | 004000137896                |      |
| E-6  | USB Keyboard                   | Dell      | L100           | DOC         | CNORH659658<br>9071T08NE    |      |
| E-7  | USB Mouse                      | Dell      | MO56UOA        | DOC         | FQJ000BS                    |      |
| E-8  | ROUTER                         | Tenda     | W268R          | DOC         | N/A                         |      |
|      |                                |           |                |             |                             |      |
|      |                                |           |                |             |                             |      |

| Item | Shielded Type | Ferrite Core | Length | Note |
|------|---------------|--------------|--------|------|
| C-1  | YES           | NO           | 1.8M   |      |
| C-2  | YES           | YES          | 1.8M   |      |
| C-3  | YES           | YES          | 1.8M   |      |
| C-4  | YES           | NO           | 1.8M   |      |
| C-5  | NO            | NO           | 1.8M   |      |
|      |               |              |        |      |
|      |               |              |        |      |
|      |               |              |        |      |

Note:

- (1) The support equipment was authorized by Declaration of Confirmation.
- (2) For detachable type I/O cable should be specified the length in cm in 『Length』 column.



**4. EMC EMISSION TEST**

**4.1 CONDUCTED EMISSION MEASUREMENT**

**4.1.1 POWER LINE CONDUCTED EMISSION Limits (Frequency Range 150KHz-30MHz)**

| FREQUENCY (MHz) | Class A (dBuV) |         | Class B (dBuV) |           | Standard |
|-----------------|----------------|---------|----------------|-----------|----------|
|                 | Quasi-peak     | Average | Quasi-peak     | Average   |          |
| 0.15 -0.5       | 79.00          | 66.00   | 66 - 56 *      | 56 - 46 * | CISPR    |
| 0.50 -5.0       | 73.00          | 60.00   | 56.00          | 46.00     | CISPR    |
| 5.0 -30.0       | 73.00          | 60.00   | 60.00          | 50.00     | CISPR    |

|           |       |       |           |           |     |
|-----------|-------|-------|-----------|-----------|-----|
| 0.15 -0.5 | 79.00 | 66.00 | 66 - 56 * | 56 - 46 * | FCC |
| 0.50 -5.0 | 73.00 | 60.00 | 56.00     | 46.00     | FCC |
| 5.0 -30.0 | 73.00 | 60.00 | 60.00     | 50.00     | FCC |

Note:

- (1) The tighter limit applies at the band edges.
- (2) The limit of " \* " marked band means the limitation decreases linearly with the logarithm of the frequency in the range.

**4.1.2 MEASUREMENT INSTRUMENTS LIST AND SETTING**

| Item | Kind of Equipment | Manufacturer | Type No. | Serial No. | Calibrated until |
|------|-------------------|--------------|----------|------------|------------------|
| 1    | LISN              | EMCO         | 3816/2   | 00052765   | May.26.2012      |
| 2    | LISN              | R&S          | ENV216   | 100087     | May.26.2012      |
| 3    | Test Cable        | N/A          | C_17     | N/A        | Mar.30.2012      |
| 4    | EMI TEST RECEIVER | R&S          | ESCS30   | 826547/022 | May.26.2012      |
| 5    | 50Ω Terminator    | SHX          | TF2-3G-A | 08122902   | May.26.2012      |

Remark: " N/A" denotes No Model Name. , Serial No. or No Calibration specified.

The following table is the setting of the receiver

| Receiver Parameters | Setting  |
|---------------------|----------|
| Attenuation         | 10 dB    |
| Start Frequency     | 0.15 MHz |
| Stop Frequency      | 30 MHz   |
| IF Bandwidth        | 9 kHz    |

#### 4.1.3 TEST PROCEDURE

- a. The EUT was placed 0.8 meters from the horizontal ground plane with EUT being connected to the power mains through a line impedance stabilization network (LISN). All other support equipments powered from additional LISN(s). The LISN provide 50 Ohm/ 50uH of coupling impedance for the measuring instrument.
- b. Interconnecting cables that hang closer than 40 cm to the ground plane shall be folded back and forth in the center forming a bundle 30 to 40 cm long.
- c. I/O cables that are not connected to a peripheral shall be bundled in the center. The end of the cable may be terminated, if required, using the correct terminating impedance. The overall length shall not exceed 1 m.
- d. LISN at least 80 cm from nearest part of EUT chassis.
- e. For the actual test configuration, please refer to the related Item –EUT Test Photos.

#### 4.1.4 DEVIATION FROM TEST STANDARD

No deviation

#### 4.1.5 TEST SETUP

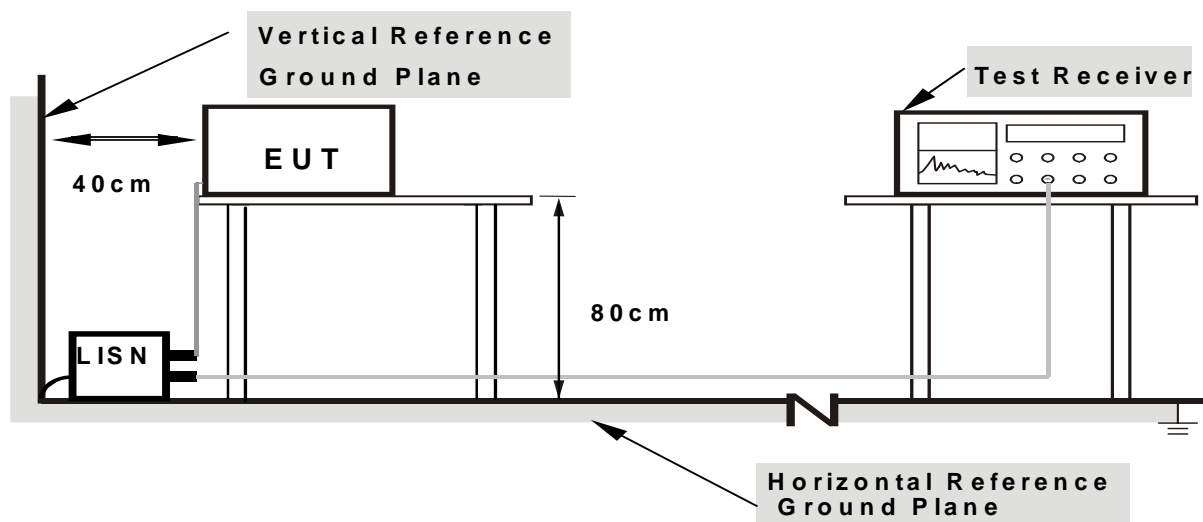

**Note: 1. Support units were connected to second LISN.**

**2. Both of LISNs (AMN) are 80 cm from EUT and at least 80 cm from other units and other metal planes**

#### 4.1.6 EUT OPERATING CONDITIONS

The EUT was configured for testing in a typical fashion (as a customer would normally use it). The EUT has been programmed to continuously transmit during test. This operating condition was tested and used to collect the included data.

The EUT was programmed to be in continuously transmitting mode.





**4.1.7 TEST RESULTS**

|               |                                |                     |              |
|---------------|--------------------------------|---------------------|--------------|
| EUT :         | 300Mbps Wireless-N USB Adapter | Model Name :        | WF-2109      |
| Temperature : | 25 °C                          | Relative Humidity : | 55%          |
| Pressure :    | 1010hPa                        | Test Power :        | AC 120V/60Hz |
| Test Mode :   | Normal Link                    |                     |              |

| Freq. (MHz) | Terminal L/N | Measured(dBuV) |         | Limits(dBuV) |         | Margin (dB) | Note |
|-------------|--------------|----------------|---------|--------------|---------|-------------|------|
|             |              | QP-Mode        | AV-Mode | QP-Mode      | AV-Mode |             |      |
| 0.16        | Line         | 50.64          | *       | 65.52        | 55.52   | -14.88      | (QP) |
| 0.22        | Line         | 48.80          | *       | 62.66        | 52.66   | -13.86      | (QP) |
| 0.25        | Line         | 46.76          | *       | 61.69        | 51.69   | -14.93      | (QP) |
| 0.47        | Line         | 42.30          | *       | 56.44        | 46.44   | -14.14      | (QP) |
| 0.91        | Line         | 38.03          | *       | 56.00        | 46.00   | -17.97      | (QP) |
| 12.32       | Line         | 44.86          | *       | 60.00        | 50.00   | -15.14      | (QP) |

**Remark**

- (1) All readings are QP Mode value unless otherwise stated AVG in column of 'Note'. If the QP Mode Measured value compliance with the QP Limits and lower than AVG Limits, the EUT shall be deemed to meet both QP & AVG Limits and then only QP Mode was measured, but AVG Mode didn't perform. In this case, a "\*" marked in AVG Mode column of Interference Voltage Measured.
- (2) Measuring frequency range from 150KHz to 30MHz.

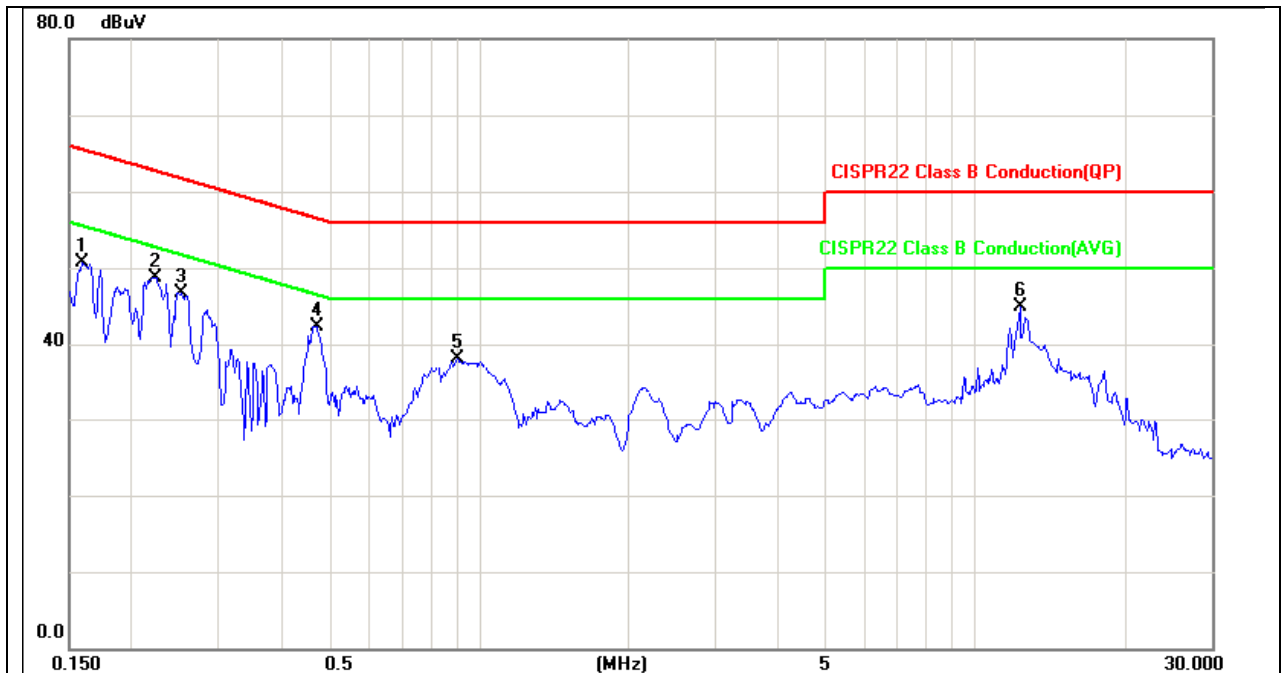



|               |                                |                     |              |
|---------------|--------------------------------|---------------------|--------------|
| EUT :         | 300Mbps Wireless-N USB Adapter | Model Name :        | WF-2109      |
| Temperature : | 25 °C                          | Relative Humidity : | 55%          |
| Pressure :    | 1010hPa                        | Test Power :        | AC 120V/60Hz |
| Test Mode :   | Normal Link                    |                     |              |

| Freq. (MHz) | Terminal L/N | Measured(dBuV) |         | Limits(dBuV) |         | Margin (dB) | Note |
|-------------|--------------|----------------|---------|--------------|---------|-------------|------|
|             |              | QP-Mode        | AV-Mode | QP-Mode      | AV-Mode |             |      |
| 0.16        | Neutral      | 50.24          | *       | 65.48        | 55.48   | -15.24      | (QP) |
| 0.22        | Neutral      | 48.29          | *       | 62.81        | 52.81   | -14.52      | (QP) |
| 0.47        | Neutral      | 41.47          | *       | 56.58        | 46.58   | -15.11      | (QP) |
| 0.83        | Neutral      | 35.95          | *       | 56.00        | 46.00   | -20.05      | (QP) |
| 1.58        | Neutral      | 38.17          | *       | 56.00        | 46.00   | -17.83      | (QP) |
| 12.52       | Neutral      | 44.28          | *       | 60.00        | 50.00   | -15.72      | (QP) |

**Remark**

- (1) All readings are QP Mode value unless otherwise stated AVG in column of 'Note'. If the QP Mode Measured value compliance with the QP Limits and lower than AVG Limits, the EUT shall be deemed to meet both QP & AVG Limits and then only QP Mode was measured, but AVG Mode didn't perform. In this case, a "\*" marked in AVG Mode column of Interference Voltage Measured.
- (2) Measuring frequency range from 150KHz to 30MHz.

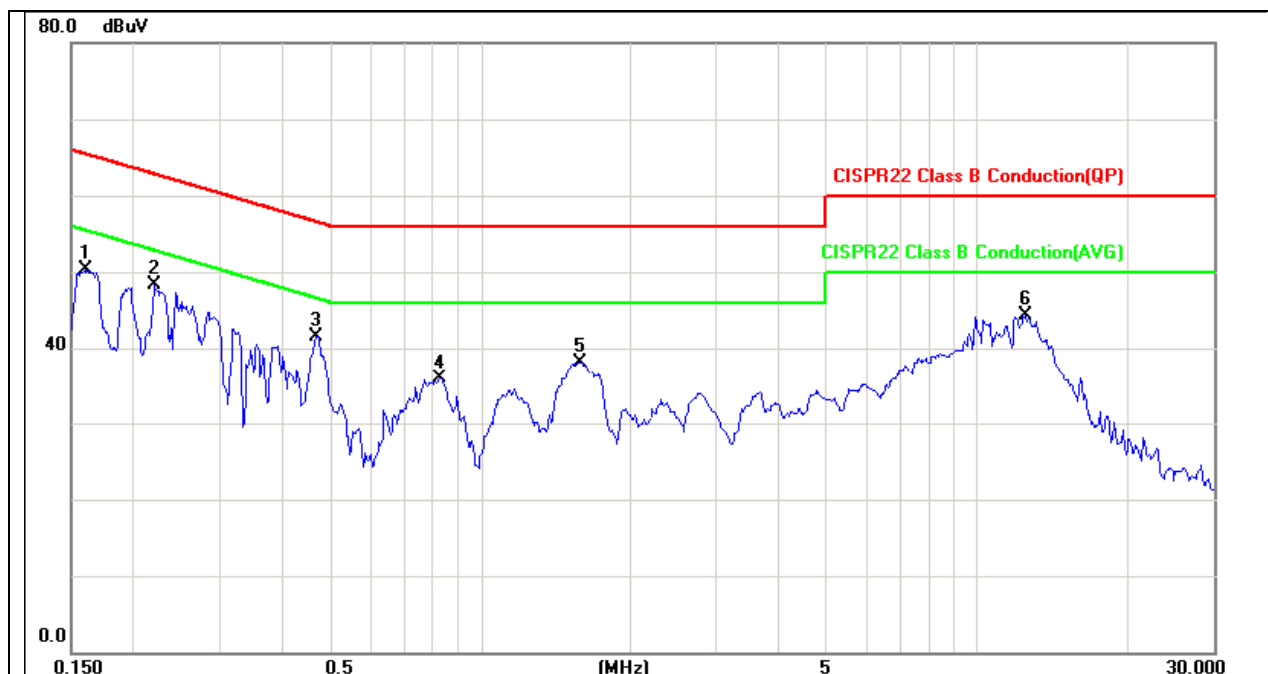



**4.2 RADIATED EMISSION MEASUREMENT**

**4.2.1 RADIATED EMISSION LIMITS (Frequency Range 9KHz-1000MHz)**

20dBc in any 100 kHz bandwidth outside the operating frequency band. In case the emission fall within the restricted band specified on 15.205(a), then the 15.209(a) limit in the table below has to be followed.

| Frequencies (MHz) | Field Strength (micorvolts/meter) | Measurement Distance (meters) |
|-------------------|-----------------------------------|-------------------------------|
| 0.009~0.490       | 2400/F(KHz)                       | 300                           |
| 0.490~1.705       | 24000/F(KHz)                      | 30                            |
| 1.705~30.0        | 30                                | 30                            |
| 30~88             | 100                               | 3                             |
| 88~216            | 150                               | 3                             |
| 216~960           | 200                               | 3                             |
| Above 960         | 500                               | 3                             |

LIMITS OF RADIATED EMISSION MEASUREMENT (Above 1000MHz)

| FREQUENCY (MHz) | (dBuV/m) (at 3m) |         |
|-----------------|------------------|---------|
|                 | PEAK             | AVERAGE |
| Above 1000      | 74               | 54      |

Notes:

- (1) The limit for radiated test was performed according to FCC PART 15C.
- (2) The tighter limit applies at the band edges.
- (3) Emission level (dBuV/m)=20log Emission level (uV/m).

FREQUENCY RANGE OF RADIATED MEASUREMENT (For unintentional radiators)

| Highest frequency generated or Upper frequency of measurement used in the device or on which the device operates or tunes (MHz) | Range (MHz)   |
|---|---|
| Below 1.705   | 30  |
| 1.705 – 108   | 1000  |
| 108 – 500   | 2000  |
| 500 – 1000  | 5000  |
| Above 1000  | 5 <sup>th</sup> harmonic of the highest frequency or 40 GHz, whichever is lower |



**4.2.2 MEASUREMENT INSTRUMENTS LIST AND SETTING**

| Item | Kind of Equipment       | Manufacturer | Type No.  | Serial No. | Calibrated until |
|------|-------------------------|--------------|-----------|------------|------------------|
| 1    | Horn Antenna            | ETS          | 3115      | 00075789   | May.26.2012      |
| 2    | Amplifier               | Agilent      | 8449B     | 3008A02274 | May.26.2012      |
| 3    | Spectrum                | Agilent      | E4408B    | US39240143 | Nov.26.2011      |
| 4    | Test Cable              | HUBER+SUHNER | C-45      | N/A        | May.04.2012      |
| 5    | Bi-log Antenna          | Schwarzbeck  | VULB9160  | 9160-3232  | Jun .04.2012     |
| 6    | Amplifier               | HP           | 8447D     | 2944A09673 | May.26.2012      |
| 7    | Test Receiver           | R&S          | ESCI      | 100382     | May.26.2012      |
| 8    | Test Cable              | N/A          | C-01_CB03 | N/A        | Jul.01.2012      |
| 9    | Controller              | CT           | SC100     | N/A        | N/A              |
| 10   | Triple Loop Antenna     | R&S          | HFH2-Z2   | 830749/020 | May.26.2012      |
| 11   | Broad-Band Horn Antenna | Schwarzbeck  | BBHA 9170 | 9170319    | May.11.2012      |

Remark: " N/A" denotes No Model Name / Serial No. and No Calibration specified.

| Spectrum Parameter                       | Setting  |
|--|--|
| Attenuation                              | Auto   |
| Start Frequency                          | 1000 MHz                                       |
| Stop Frequency                           | 10th carrier harmonic                          |
| RB / VB<br>(Emission in restricted band) | 1MHz / 1MHz for Peak, 1 MHz / 10Hz for Average |

| Receiver Parameter     | Setting                          |
|------------------------|----------------------------------|
| Attenuation            | Auto                             |
| Start ~ Stop Frequency | 9kHz~150kHz / RB 200Hz for QP    |
| Start ~ Stop Frequency | 150kHz~30MHz / RB 9kHz for QP    |
| Start ~ Stop Frequency | 30MHz~1000MHz / RB 120kHz for QP |



#### **4.2.3 TEST PROCEDURE**

- a. The measuring distance of at 3 m shall be used for measurements at frequency up to 1GHz. For frequencies above 1GHz, any suitable measuring distance may be used.
- b. The EUT was placed on the top of a rotating table 0.8 meters above the ground at a 3 meter semi-anechoic chamber. The table was rotated 360 degrees to determine the position of the highest radiation.
- c. The height of the equipment or of the substitution antenna shall be 0.8 m; the height of the test antenna shall vary between 1 m to 4 m. Both horizontal and vertical polarizations of the antenna are set to make the measurement.
- d. The initial step in collecting conducted emission data is a spectrum analyzer peak detector mode pre-scanning the measurement frequency range. Significant peaks are then marked and then Quasi Peak detector mode re-measured.
- e. If the Peak Mode measured value compliance with and lower than Quasi Peak Mode Limit, the EUT shall be deemed to meet QP Limits and then no additional QP Mode measurement performed.
- f. For the actual test configuration, please refer to the related Item –EUT Test Photos.

#### **4.2.4 DEVIATION FROM TEST STANDARD**

No deviation

**4.2.5 TEST SETUP**

(A) Radiated Emission Test Set-Up Frequency Below 1 GHz

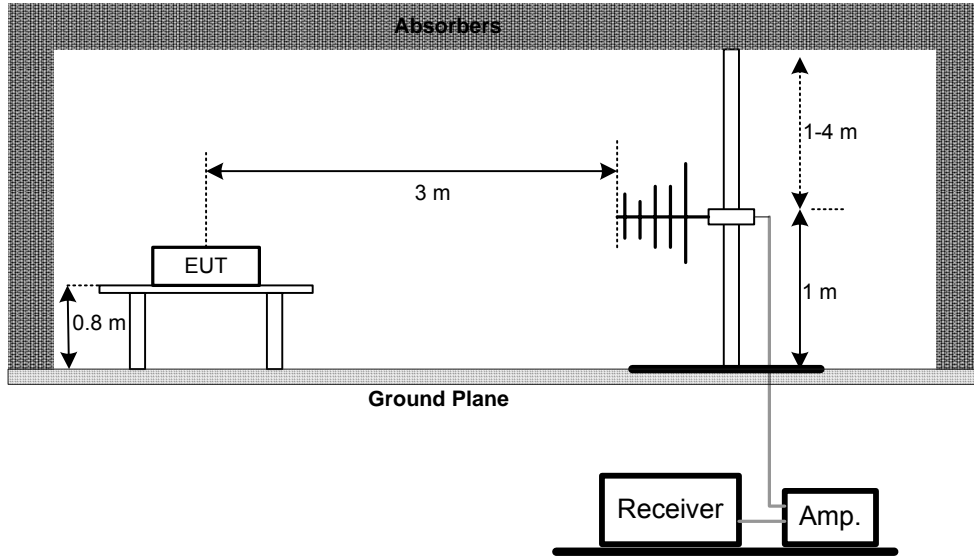

(B) Radiated Emission Test Set-Up Frequency Above 1 GHz

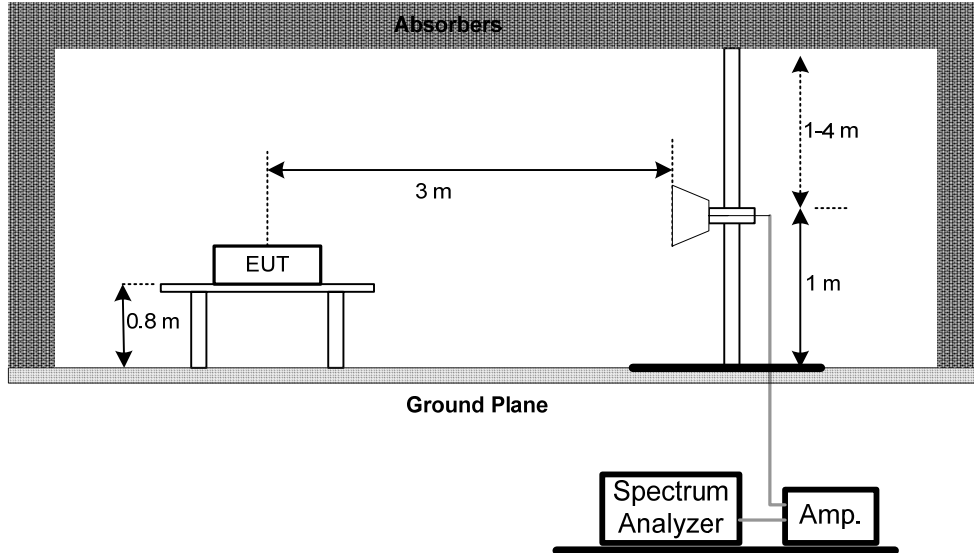

**4.2.6 EUT OPERATING CONDITIONS**

The EUT tested system was configured as the statements of 4.1.6 Unless otherwise a special operating condition is specified in the follows during the testing.



**4.2.7 TEST RESULTS (BETWEEN 30 – 1000 MHZ)**

|               |                                |                     |              |
|---------------|--------------------------------|---------------------|--------------|
| EUT :         | 300Mbps Wireless-N USB Adapter | Model Name :        | WF-2109      |
| Temperature : | 25 °C                          | Relative Humidity : | 58 %         |
| Pressure :    | 1010 hPa                       | Test Voltage :      | AC 120V/60Hz |
| Test Mode :   | TX G MODE CHANNEL 01           |                     |              |

| Freq. (MHz) | Ant. H/V | Reading(RA) (dBuV) | Corr.Factor(CF) (dB) | Measured(FS) (dBuV/m) | Limits(QP) (dBuV/m) | Margin (dB) | Note |
|-------------|----------|--------------------|----------------------|-----------------------|---------------------|-------------|------|
| 38.73       | V        | 46.68              | -15.05               | 31.63                 | 40.00               | - 8.37      |      |
| 188.11      | V        | 54.24              | -23.84               | 30.40                 | 43.50               | - 13.10     |      |
| 480.08      | V        | 45.43              | -13.10               | 32.33                 | 46.00               | - 13.67     |      |
| 513.06      | V        | 46.64              | -12.01               | 34.63                 | 46.00               | - 11.37     |      |
| 633.34      | V        | 42.90              | -10.03               | 32.87                 | 46.00               | - 13.13     |      |
| 705.12      | V        | 38.81              | -7.41                | 31.40                 | 46.00               | - 14.60     |      |

**Remark :**

- (1) Reading in which marked as QP or Peak means measurements by using are Quasi-Peak Mode or Peak Mode with Detector BW=120KHz ; SPA setting in RBW=120KHz, VBW =120KHz, Swp. Time = 0.3 sec./MHz ◦
- (2) All readings are Peak unless otherwise stated QP in column of 『Note』 . Peak denotes that the Peak reading compliance with the QP Limits and then QP Mode measurement didn't perform ◦
- (3) Measuring frequency range from 30MHz to 1000MHz ◦
- (4) If the peak scan value lower limit more than 20dB, then this signal data does not show in table ◦

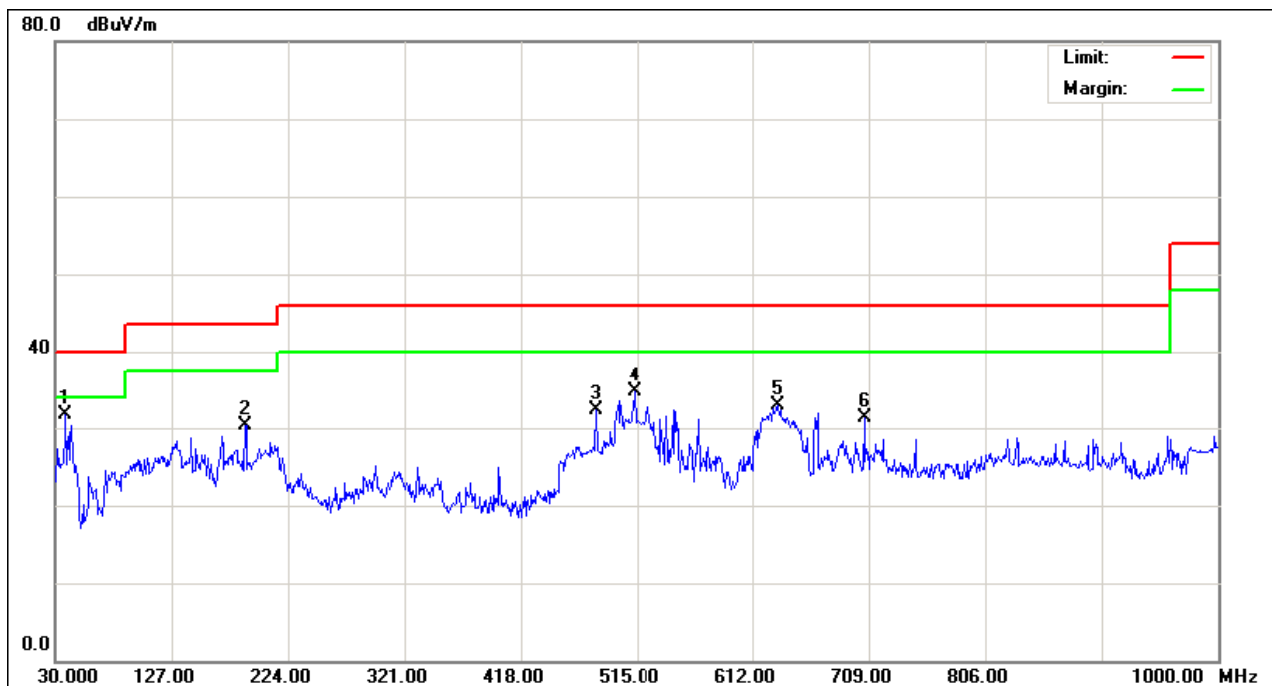



|               |                                |                     |              |
|---------------|--------------------------------|---------------------|--------------|
| EUT :         | 300Mbps Wireless-N USB Adapter | Model Name :        | WF-2109      |
| Temperature : | 25 °C                          | Relative Humidity : | 58 %         |
| Pressure :    | 1010 hPa                       | Test Voltage :      | AC 120V/60Hz |
| Test Mode :   | TX G MODE CHANNEL 01           |                     |              |

| Freq. (MHz) | Ant. H/V | Reading(RA) (dBuV) | Corr.Factor(CF) (dB) | Measured(FS) (dBuV/m) | Limits(QP) (dBuV/m) | Margin (dB) | Note |
|-------------|----------|--------------------|----------------------|-----------------------|---------------------|-------------|------|
| 165.80      | H        | 54.00              | -21.06               | 32.94                 | 43.50               | - 10.56     |      |
| 231.76      | H        | 53.84              | -20.11               | 33.73                 | 46.00               | - 12.27     |      |
| 296.75      | H        | 51.50              | -17.12               | 34.38                 | 46.00               | - 11.62     |      |
| 481.05      | H        | 47.76              | -13.06               | 34.70                 | 46.00               | - 11.30     |      |
| 666.32      | H        | 42.96              | -8.83                | 34.13                 | 46.00               | - 11.87     |      |
| 831.22      | H        | 36.85              | -5.40                | 31.45                 | 46.00               | - 14.55     |      |

**Remark :**

- (1) Reading in which marked as QP or Peak means measurements by using are Quasi-Peak Mode or Peak Mode with Detector BW=120KHz ; SPA setting in RBW=120KHz, VBW =120KHz, Swp. Time = 0.3 sec./MHz ◦
- (2) All readings are Peak unless otherwise stated QP in column of 『Note』 . Peak denotes that the Peak reading compliance with the QP Limits and then QP Mode measurement didn't perform ◦
- (3) Measuring frequency range from 30MHz to 1000MHz ◦
- (4) If the peak scan value lower limit more than 20dB, then this signal data does not show in table ◦

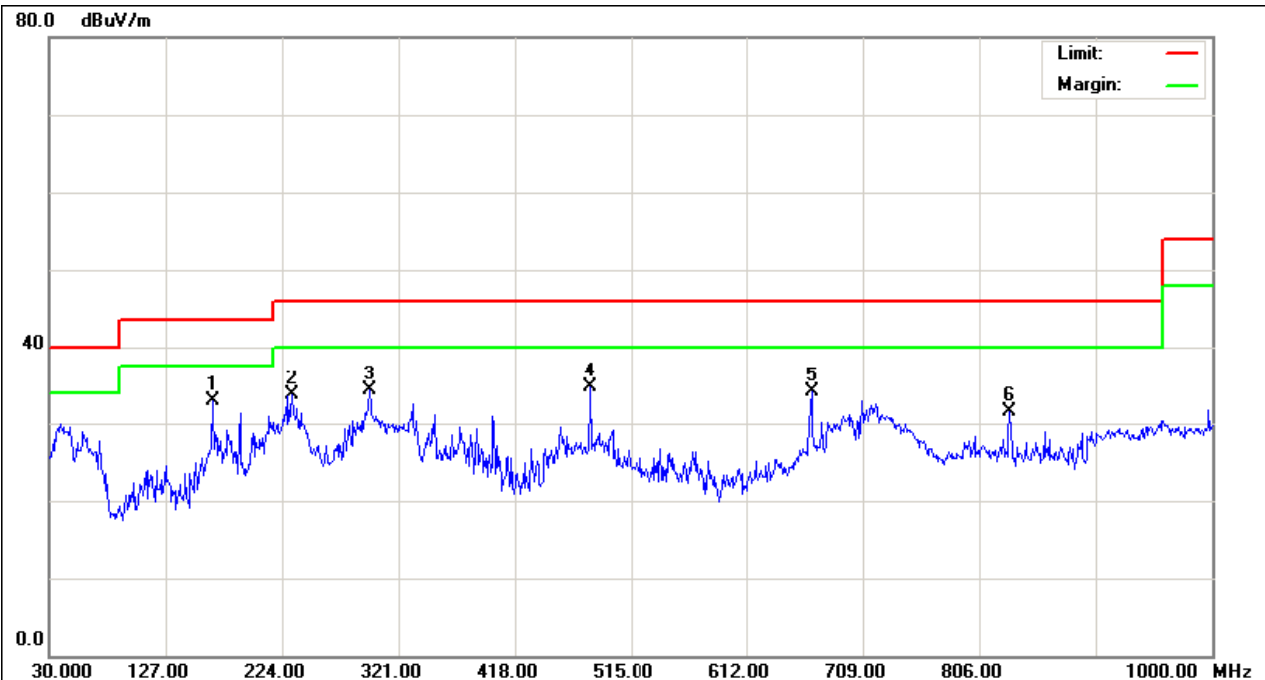





**4.2.8 TEST RESULTS (ABOVE 1000 MHZ)**

|               |                                |                     |              |
|---------------|--------------------------------|---------------------|--------------|
| EUT :         | 300Mbps Wireless-N USB Adapter | Model Name :        | WF-2109      |
| Temperature : | 25 °C                          | Relative Humidity : | 51 %         |
| Pressure :    | 1010 hPa                       | Test Voltage :      | AC 120V/60Hz |
| Test Mode :   | TX B MODE 2412MHz              |                     |              |

| Freq.<br>(MHz) | Ant.Pol.<br>H/V | Reading        |              | Ant./CF<br>CF(dB) | Act              |                | Limit            |                | Note       |
|----------------|-----------------|----------------|--------------|-------------------|------------------|----------------|------------------|----------------|------------|
|                |                 | Peak<br>(dBuV) | AV<br>(dBuV) |                   | Peak<br>(dBuV/m) | AV<br>(dBuV/m) | Peak<br>(dBuV/m) | AV<br>(dBuV/m) |            |
| 2390.00        | V               | 21.40          | 11.70        | 31.54             | 52.94            | 43.24          | 74.00            | 54.00          | X/E        |
| <b>2411.63</b> | <b>V</b>        | <b>64.58</b>   | <b>60.36</b> | <b>31.57</b>      | <b>96.15</b>     | <b>91.93</b>   |                  |                | <b>X/F</b> |
| 4824.12        | V               | 47.62          | 42.46        | 6.00              | 53.62            | 48.46          | 74.00            | 54.00          | X/H        |

Remark :

- (1) All readings are Peak unless otherwise stated QP in column of 『Note』 . Peak denotes that the Peak reading compliance with the QP Limits and then QP Mode measurement didn't perform ◦
- (2) Measuring frequency range from 30MHz to 1000MHz or the 10th harmonic of highest fundamental frequency ◦ "F" denotes fundamental frequency; "H" denotes spurious frequency. "E" denotes band edge frequency. (This judgment method includes the Band Edge Requirement.)
- (3) Radiated emissions measured in frequency range above 1000MHz were made with an instrument using Peak detector mode and AV detector mode of the emission ◦
- (4) Data of measurement within this frequency range shown " \* " in the table above means the reading of emissions are attenuated more than 20dB below the permissible limits or the field strength is too small to be measured.
- (5) A preamp and high pass filter were used for this test in order to provide sufficient measurement sensitivity.
- (6) EUT Orthogonal Axis :  
"X" - denotes Laid on Table ; "Y" - denotes Vertical Stand ; "Z" - denotes Side Stand
- (7) During the measurements above 1 GHz it is taken care of that the EUT is always within the 3 dB cone of radiation BW of the used antenna



TX CH01 (Above 1000 MHz, Vertical)

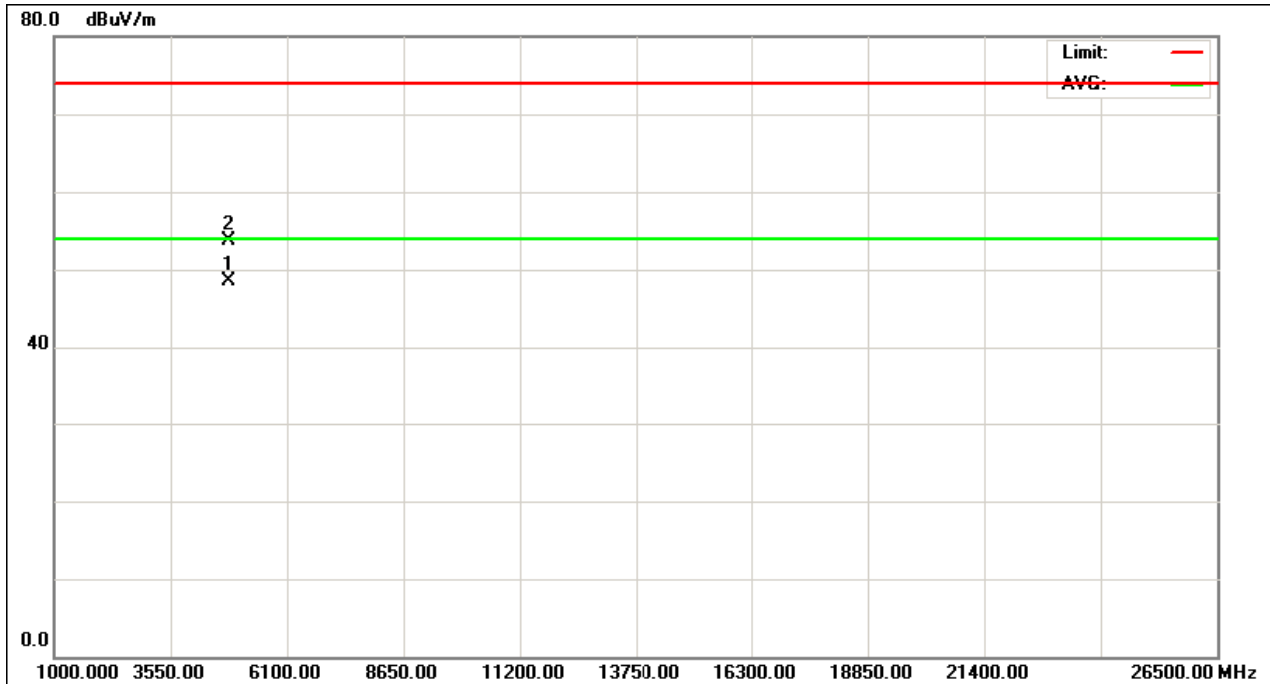
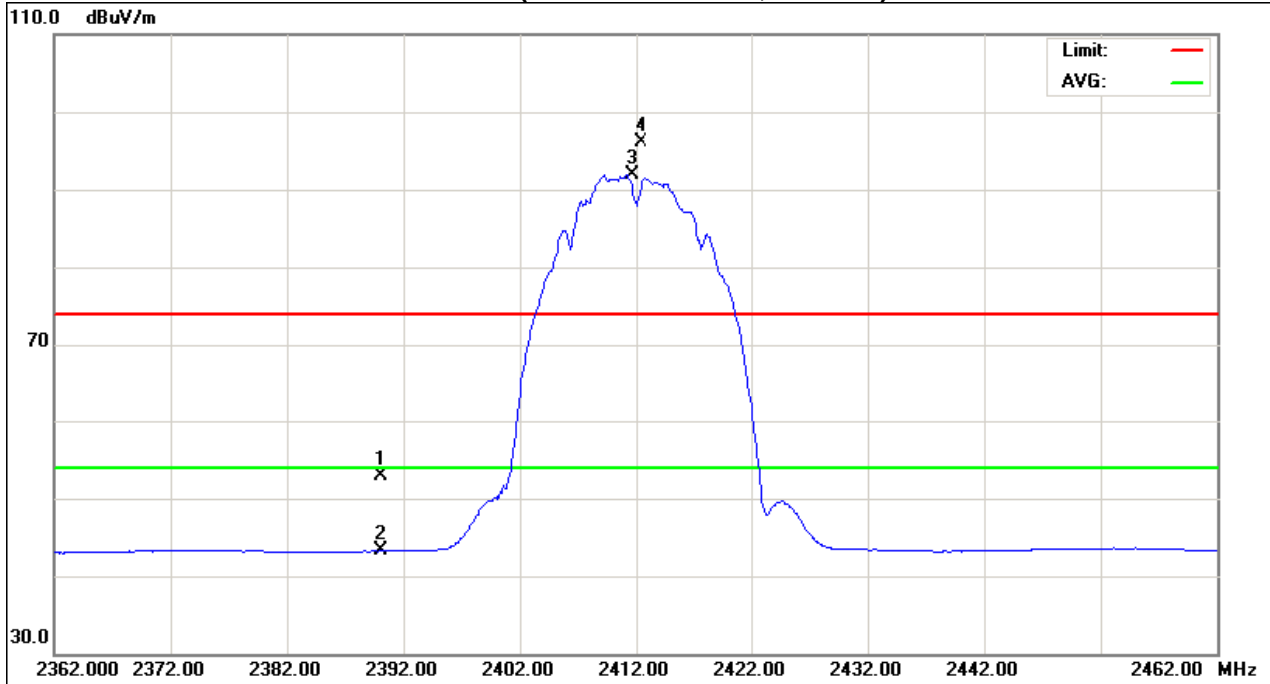



|               |                                |                     |              |
|---------------|--------------------------------|---------------------|--------------|
| EUT :         | 300Mbps Wireless-N USB Adapter | Model Name :        | WF-2109      |
| Temperature : | 25 °C                          | Relative Humidity : | 51 %         |
| Pressure :    | 1010 hPa                       | Test Voltage :      | AC 120V/60Hz |
| Test Mode :   | TX B MODE 2412MHz              |                     |              |

| Freq.          | Ant.Pol. | Reading      |              | Ant./CF      | Act          |              | Limit    |          | Note       |
|----------------|----------|--------------|--------------|--------------|--------------|--------------|----------|----------|------------|
|                |          | Peak         | AV           |              | Peak         | AV           | Peak     | AV       |            |
| (MHz)          | H/V      | (dBuV)       | (dBuV)       | CF(dB)       | (dBuV/m)     | (dBuV/m)     | (dBuV/m) | (dBuV/m) |            |
| 2390.00        | H        | 21.89        | 11.73        | 31.54        | 53.43        | 43.27        | 74.00    | 54.00    | X/E        |
| <b>2411.02</b> | <b>H</b> | <b>67.39</b> | <b>63.85</b> | <b>31.57</b> | <b>98.96</b> | <b>95.42</b> |          |          | <b>X/F</b> |
| 4824.17        | H        | 43.06        | 38.90        | 6.00         | 49.06        | 44.90        | 74.00    | 54.00    | X/H        |

Remark :

- (1) All readings are Peak unless otherwise stated QP in column of 『Note』 . Peak denotes that the Peak reading compliance with the QP Limits and then QP Mode measurement didn't perform ◦
- (2) Measuring frequency range from 30MHz to 1000MHz or the 10th harmonic of highest fundamental frequency ◦ "F" denotes fundamental frequency; "H" denotes spurious frequency. "E" denotes band edge frequency. (This judgment method includes the Band Edge Requirement.)
- (3) Radiated emissions measured in frequency range above 1000MHz were made with an instrument using Peak detector mode and AV detector mode of the emission ◦
- (4) Data of measurement within this frequency range shown " \* " in the table above means the reading of emissions are attenuated more than 20dB below the permissible limits or the field strength is too small to be measured.
- (5) A preamp and high pass filter were used for this test in order to provide sufficient measurement sensitivity.
- (6) EUT Orthogonal Axis :  
"X" - denotes Laid on Table ; "Y" - denotes Vertical Stand ; "Z" - denotes Side Stand
- (7) During the measurements above 1 GHz it is taken care of that the EUT is always within the 3 dB cone of radiation BW of the used antenna



TX CH01 (Above 1000 MHz, Horizontal)

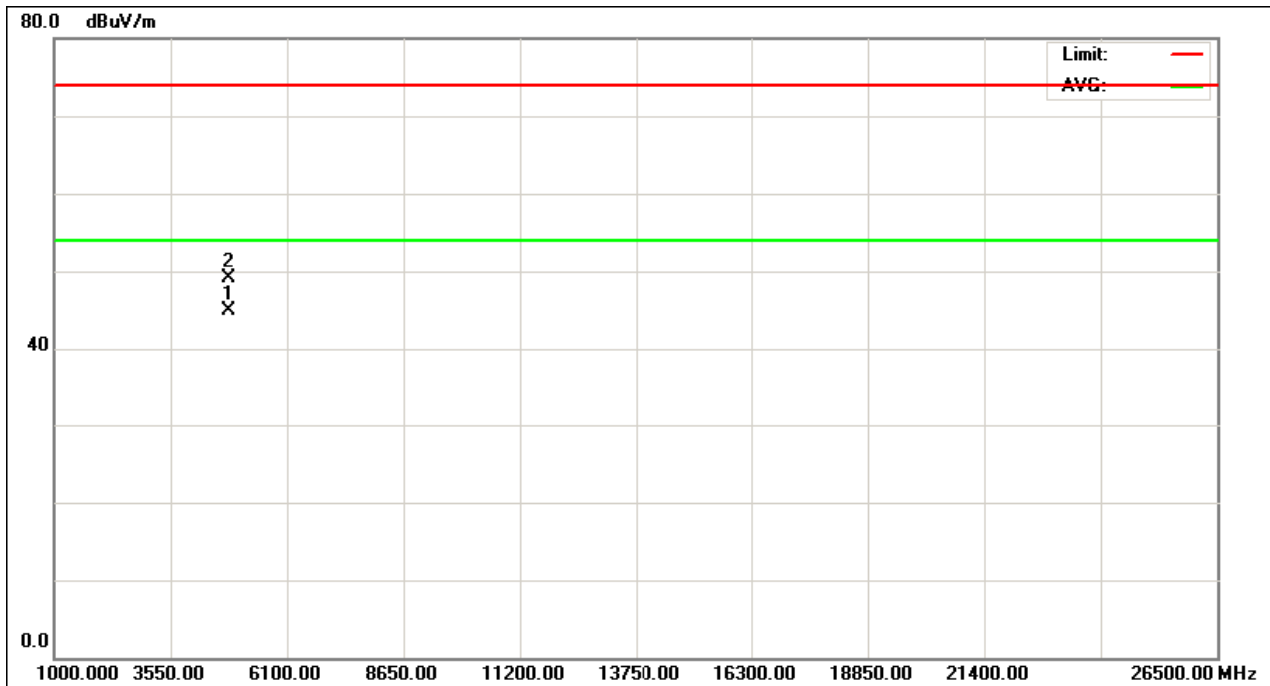
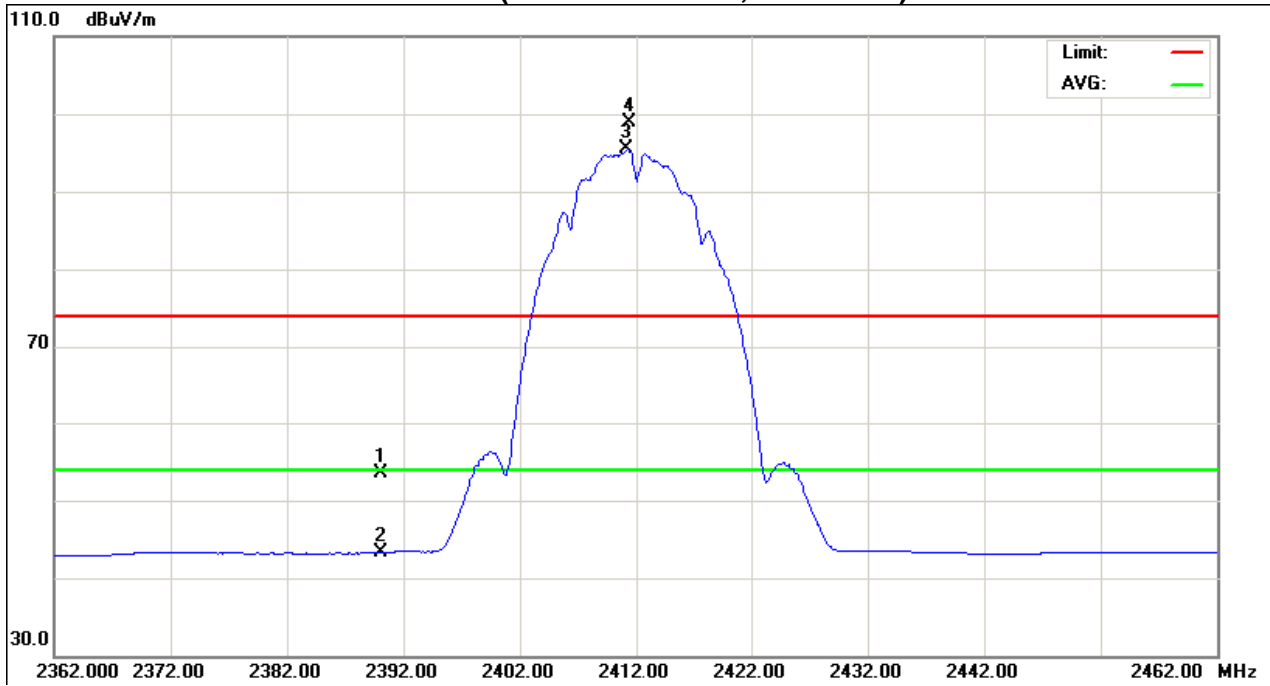



|               |                                |                     |              |
|---------------|--------------------------------|---------------------|--------------|
| EUT :         | 300Mbps Wireless-N USB Adapter | Model Name :        | WF-2109      |
| Temperature : | 25 °C                          | Relative Humidity : | 51 %         |
| Pressure :    | 1010 hPa                       | Test Voltage :      | AC 120V/60Hz |
| Test Mode :   | TX B MODE 2437MHz              |                     |              |

| Freq.          | Ant.Pol. | Reading      |              | Ant./CF      | Act.         |              | Limit    |          | Note       |
|----------------|----------|--------------|--------------|--------------|--------------|--------------|----------|----------|------------|
|                |          | Peak         | AV           |              | Peak         | AV           | Peak     | AV       |            |
| (MHz)          | H/V      | (dBuV)       | (dBuV)       | CF(dB)       | (dBuV/m)     | (dBuV/m)     | (dBuV/m) | (dBuV/m) |            |
| <b>2435.20</b> | <b>V</b> | <b>63.74</b> | <b>59.88</b> | <b>31.62</b> | <b>95.36</b> | <b>91.50</b> |          |          | <b>X/F</b> |
| 4874.16        | V        | 44.81        | 40.56        | 6.15         | 50.96        | 46.71        | 74.00    | 54.00    | X/H        |

Remark :

- (1) All readings are Peak unless otherwise stated QP in column of 『Note』 . Peak denotes that the Peak reading compliance with the QP Limits and then QP Mode measurement didn't perform ◦
- (2) Measuring frequency range from 30MHz to 1000MHz or the 10th harmonic of highest fundamental frequency ◦ “F” denotes fundamental frequency; “H” denotes spurious frequency. “E” denotes band edge frequency. (This judgment method includes the Band Edge Requirement.)
- (3) Radiated emissions measured in frequency range above 1000MHz were made with an instrument using Peak detector mode and AV detector mode of the emission ◦
- (4) Data of measurement within this frequency range shown “ \* ” in the table above means the reading of emissions are attenuated more than 20dB below the permissible limits or the field strength is too small to be measured.
- (5) A preamp and high pass filter were used for this test in order to provide sufficient measurement sensitivity.
- (6) EUT Orthogonal Axis :  
 “X” - denotes Laid on Table ; “Y” - denotes Vertical Stand ; “Z” - denotes Side Stand
- (7) During the measurements above 1 GHz it is taken care of that the EUT is always within the 3 dB cone of radiation BW of the used antenna



TX CH06 (Above 1000 MHz, Vertical)

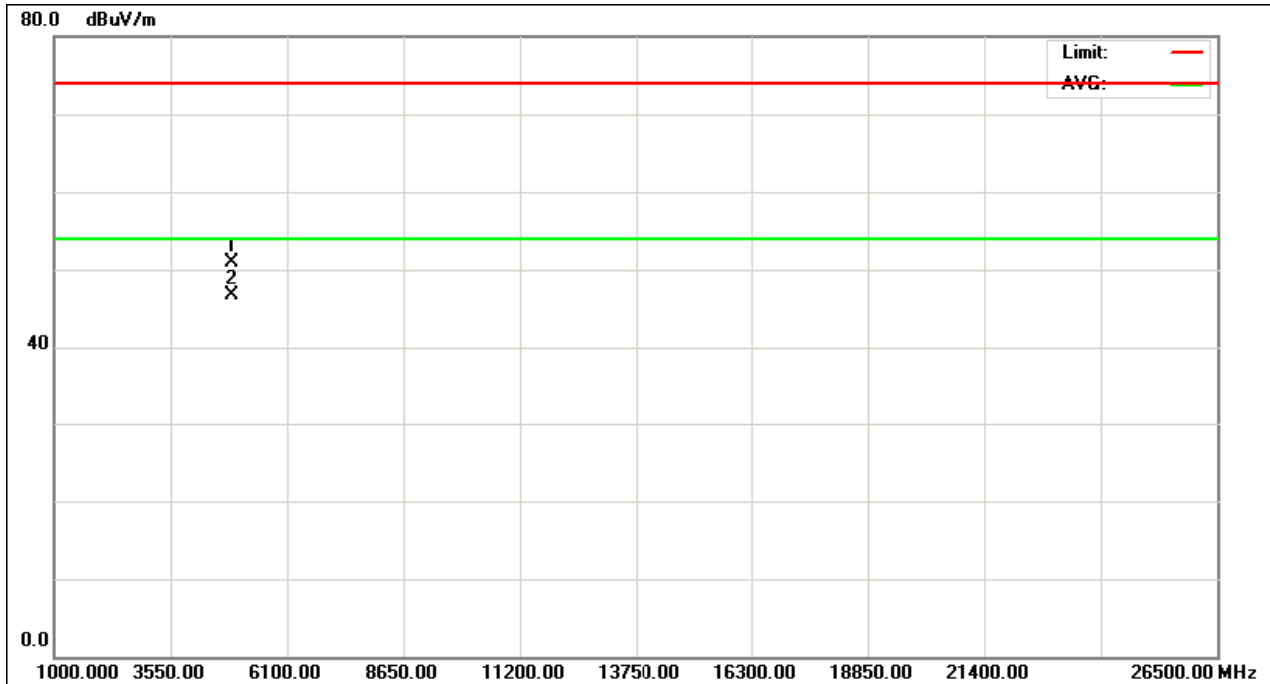
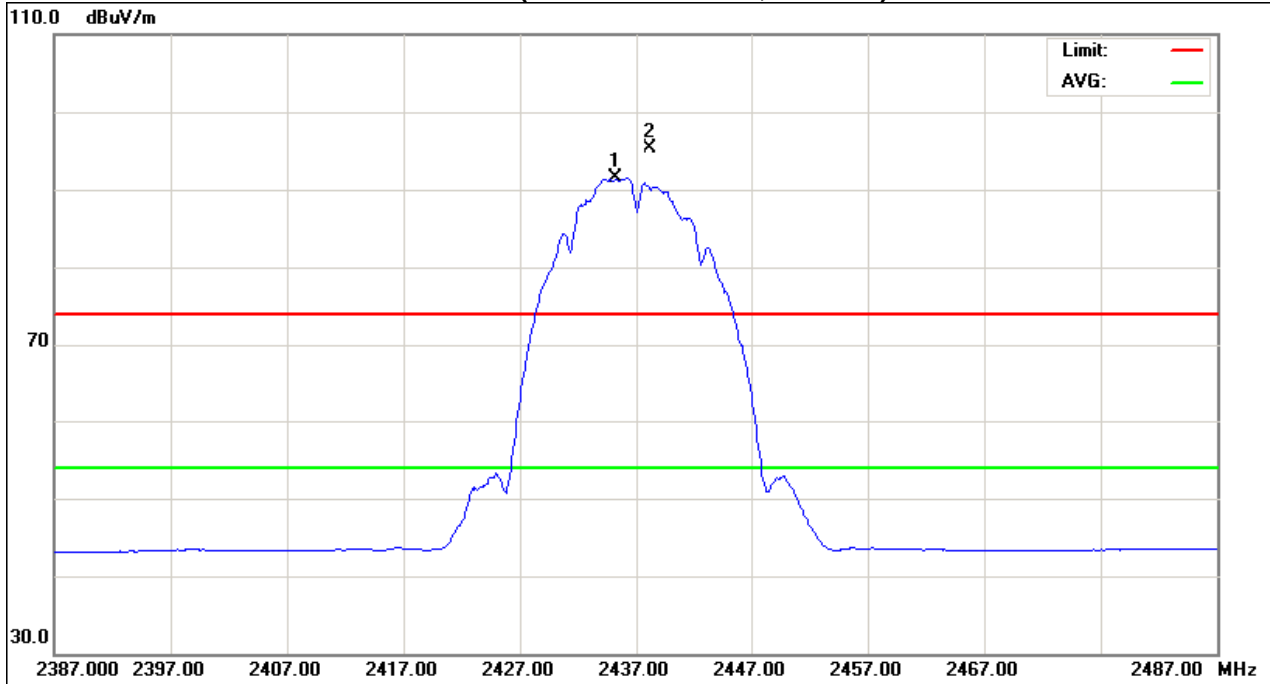



|               |                                |                     |              |
|---------------|--------------------------------|---------------------|--------------|
| EUT :         | 300Mbps Wireless-N USB Adapter | Model Name :        | WF-2109      |
| Temperature : | 25 °C                          | Relative Humidity : | 51 %         |
| Pressure :    | 1010 hPa                       | Test Voltage :      | AC 120V/60Hz |
| Test Mode :   | TX B MODE 2437MHz              |                     |              |

| Freq.          | Ant.Pol. | Reading      |              | Ant./CF      | Act.         |              | Limit    |          | Note       |
|----------------|----------|--------------|--------------|--------------|--------------|--------------|----------|----------|------------|
|                |          | Peak         | AV           |              | Peak         | AV           | Peak     | AV       |            |
| (MHz)          | H/V      | (dBuV)       | (dBuV)       | CF(dB)       | (dBuV/m)     | (dBuV/m)     | (dBuV/m) | (dBuV/m) |            |
| <b>2436.55</b> | <b>H</b> | <b>68.20</b> | <b>64.46</b> | <b>31.62</b> | <b>99.82</b> | <b>96.08</b> |          |          | <b>X/F</b> |
| 4874.11        | H        | 41.27        | 34.94        | 6.15         | 47.42        | 41.09        | 74.00    | 54.00    | X/H        |

Remark :

- (1) All readings are Peak unless otherwise stated QP in column of 『Note』 . Peak denotes that the Peak reading compliance with the QP Limits and then QP Mode measurement didn't perform ◦
- (2) Measuring frequency range from 30MHz to 1000MHz or the 10th harmonic of highest fundamental frequency ◦ "F" denotes fundamental frequency; "H" denotes spurious frequency. "E" denotes band edge frequency. (This judgment method includes the Band Edge Requirement.)
- (3) Radiated emissions measured in frequency range above 1000MHz were made with an instrument using Peak detector mode and AV detector mode of the emission ◦
- (4) Data of measurement within this frequency range shown " \* " in the table above means the reading of emissions are attenuated more than 20dB below the permissible limits or the field strength is too small to be measured.
- (5) A preamp and high pass filter were used for this test in order to provide sufficient measurement sensitivity.
- (6) EUT Orthogonal Axis :  
"X" - denotes Laid on Table ; "Y" - denotes Vertical Stand ; "Z" - denotes Side Stand
- (7) During the measurements above 1 GHz it is taken care of that the EUT is always within the 3 dB cone of radiation BW of the used antenna



TX CH06 (Above 1000 MHz, Horizontal)

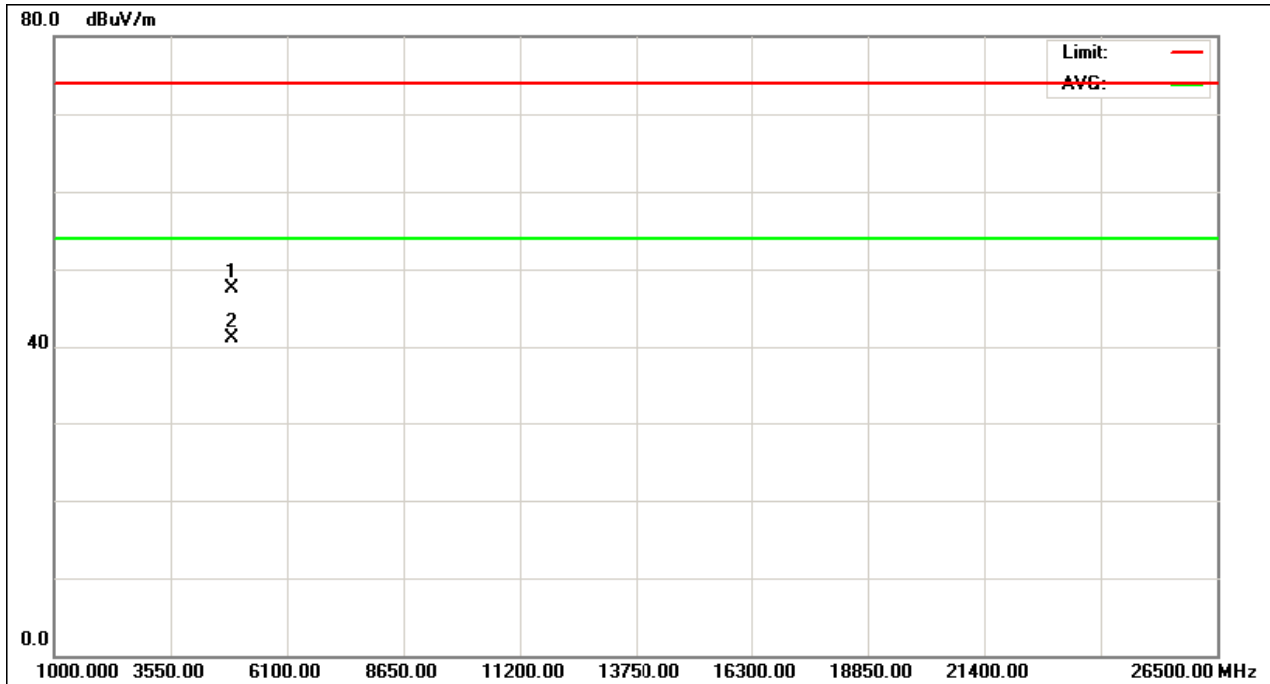
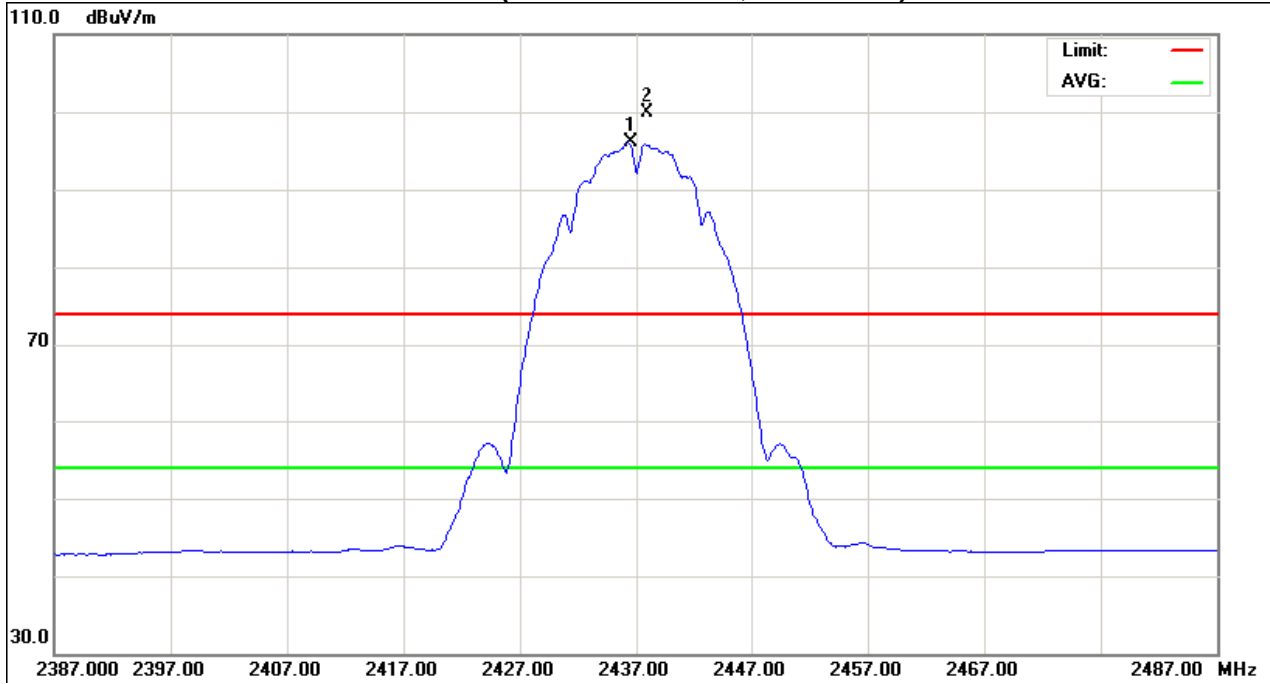





|               |                                |                     |              |
|---------------|--------------------------------|---------------------|--------------|
| EUT :         | 300Mbps Wireless-N USB Adapter | Model Name :        | WF-2109      |
| Temperature : | 25 °C                          | Relative Humidity : | 51 %         |
| Pressure :    | 1010 hPa                       | Test Voltage :      | AC 120V/60Hz |
| Test Mode :   | TX B MODE 2462MHz              |                     |              |

| Freq.          | Ant.Pol. | Reading      |              | Ant./CF      | Act.         |              | Limit    |          | Note       |
|----------------|----------|--------------|--------------|--------------|--------------|--------------|----------|----------|------------|
|                |          | Peak         | AV           |              | Peak         | AV           | Peak     | AV       |            |
| (MHz)          | H/V      | (dBuV)       | (dBuV)       | CF(dB)       | (dBuV/m)     | (dBuV/m)     | (dBuV/m) | (dBuV/m) |            |
| <b>2462.80</b> | <b>V</b> | <b>65.13</b> | <b>60.54</b> | <b>31.66</b> | <b>96.79</b> | <b>92.20</b> |          |          | <b>X/F</b> |
| 2483.50        | V        | 22.90        | 12.38        | 31.70        | 54.60        | 44.08        | 74.00    | 54.00    | X/E        |
| 4944.01        | V        | 45.79        | 39.37        | 6.35         | 52.14        | 45.72        | 74.00    | 54.00    | X/H        |

Remark :

- (1) All readings are Peak unless otherwise stated QP in column of 『Note』 . Peak denotes that the Peak reading compliance with the QP Limits and then QP Mode measurement didn't perform ◦
- (2) Measuring frequency range from 30MHz to 1000MHz or the 10th harmonic of highest fundamental frequency ◦ "F" denotes fundamental frequency; "H" denotes spurious frequency. "E" denotes band edge frequency. (This judgment method includes the Band Edge Requirement.)
- (3) Radiated emissions measured in frequency range above 1000MHz were made with an instrument using Peak detector mode and AV detector mode of the emission ◦
- (4) Data of measurement within this frequency range shown " \* " in the table above means the reading of emissions are attenuated more than 20dB below the permissible limits or the field strength is too small to be measured.
- (5) A preamp and high pass filter were used for this test in order to provide sufficient measurement sensitivity.
- (6) EUT Orthogonal Axis :  
 "X" - denotes Laid on Table ; "Y" - denotes Vertical Stand ; "Z" - denotes Side Stand
- (7) During the measurements above 1 GHz it is taken care of that the EUT is always within the 3 dB cone of radiation BW of the used antenna



TX CH11 (Above 1000 MHz, Vertical)

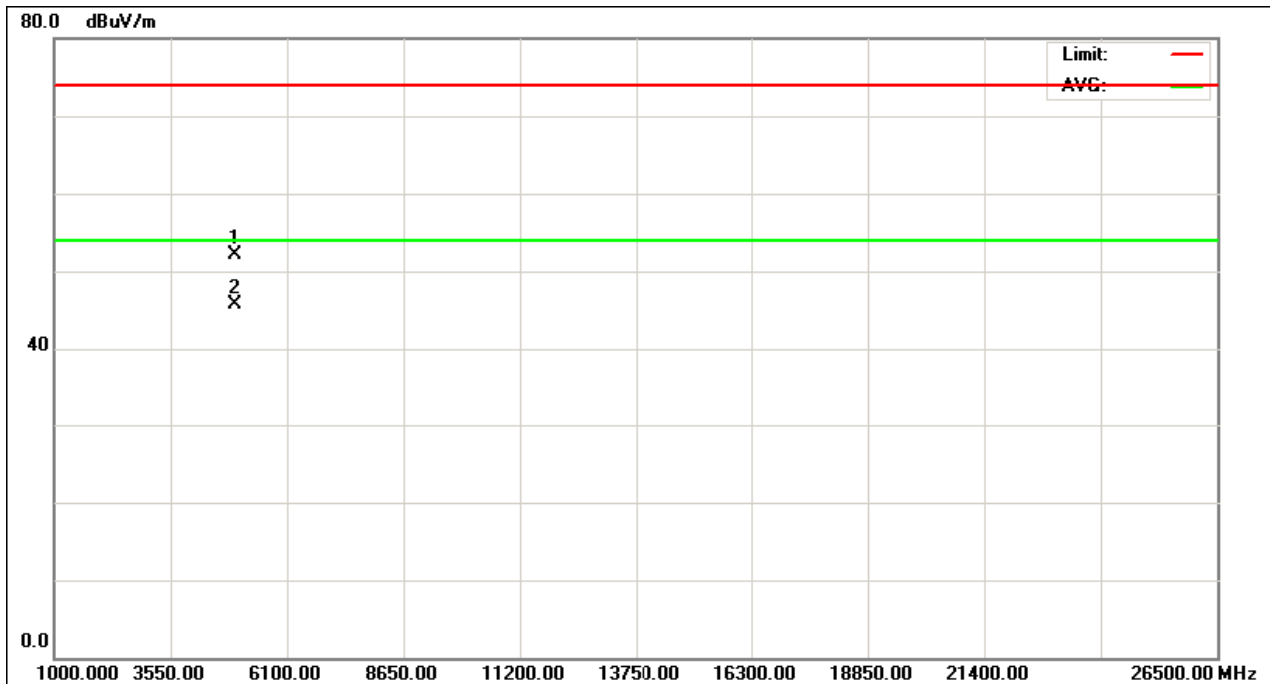
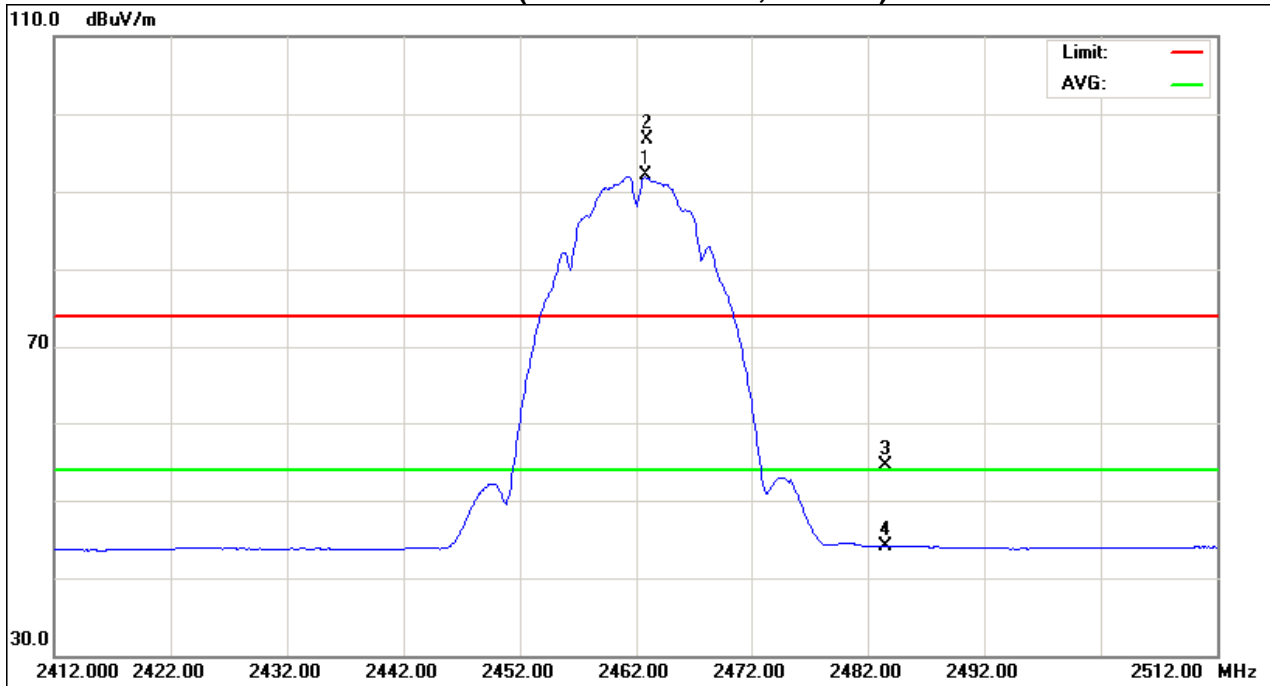



|               |                                |                     |              |
|---------------|--------------------------------|---------------------|--------------|
| EUT :         | 300Mbps Wireless-N USB Adapter | Model Name :        | WF-2109      |
| Temperature : | 25 °C                          | Relative Humidity : | 51 %         |
| Pressure :    | 1010 hPa                       | Test Voltage :      | AC 120V/60Hz |
| Test Mode :   | TX B MODE 2462MHz              |                     |              |

| Freq.          | Ant.Pol. | Reading      |              | Ant./CF      | Act.         |              | Limit    |          | Note       |
|----------------|----------|--------------|--------------|--------------|--------------|--------------|----------|----------|------------|
|                |          | Peak         | AV           |              | Peak         | AV           | Peak     | AV       |            |
| (MHz)          | H/V      | (dBuV)       | (dBuV)       | CF(dB)       | (dBuV/m)     | (dBuV/m)     | (dBuV/m) | (dBuV/m) |            |
| <b>2461.00</b> | <b>H</b> | <b>66.89</b> | <b>62.87</b> | <b>31.65</b> | <b>98.54</b> | <b>94.52</b> |          |          | <b>X/F</b> |
| 2483.50        | H        | 23.43        | 11.95        | 31.70        | 55.13        | 43.65        | 74.00    | 54.00    | X/E        |
| 4923.92        | H        | 39.42        | 33.57        | 6.30         | 45.72        | 39.87        | 74.00    | 54.00    | X/H        |

Remark :

- (1) All readings are Peak unless otherwise stated QP in column of 『Note』 . Peak denotes that the Peak reading compliance with the QP Limits and then QP Mode measurement didn't perform ◦
- (2) Measuring frequency range from 30MHz to 1000MHz or the 10th harmonic of highest fundamental frequency ◦ "F" denotes fundamental frequency; "H" denotes spurious frequency. "E" denotes band edge frequency. (This judgment method includes the Band Edge Requirement.)
- (3) Radiated emissions measured in frequency range above 1000MHz were made with an instrument using Peak detector mode and AV detector mode of the emission ◦
- (4) Data of measurement within this frequency range shown " \* " in the table above means the reading of emissions are attenuated more than 20dB below the permissible limits or the field strength is too small to be measured.
- (5) A preamp and high pass filter were used for this test in order to provide sufficient measurement sensitivity.
- (6) EUT Orthogonal Axis :  
"X" - denotes Laid on Table ; "Y" - denotes Vertical Stand ; "Z" - denotes Side Stand
- (7) During the measurements above 1 GHz it is taken care of that the EUT is always within the 3 dB cone of radiation BW of the used antenna



TX CH11 (Above 1000 MHz, Horizontal)

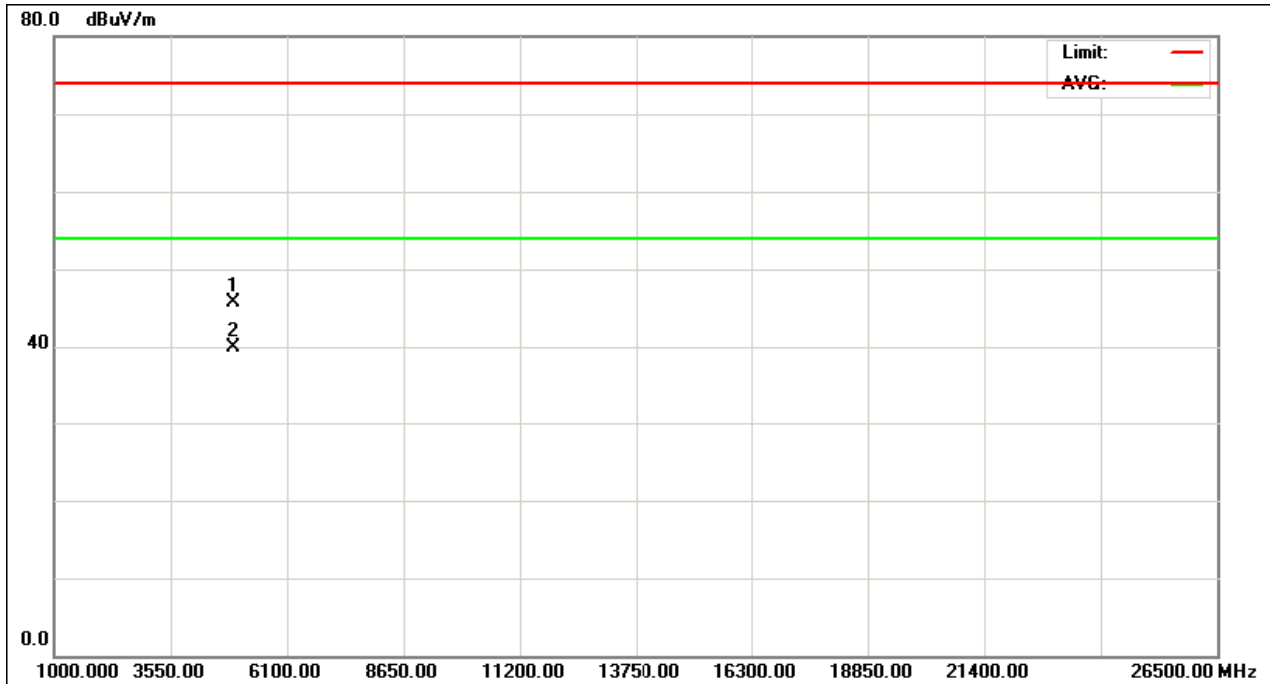
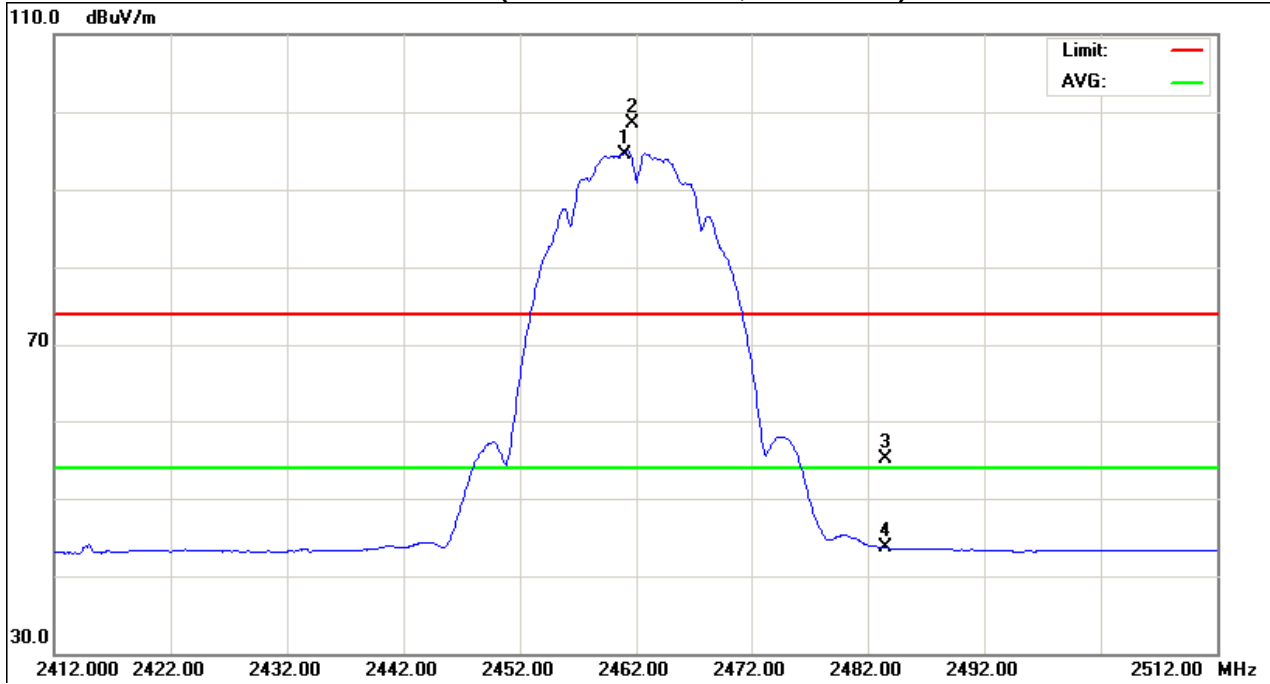



|               |                                |                     |              |
|---------------|--------------------------------|---------------------|--------------|
| EUT :         | 300Mbps Wireless-N USB Adapter | Model Name :        | WF-2109      |
| Temperature : | 25 °C                          | Relative Humidity : | 51 %         |
| Pressure :    | 1010 hPa                       | Test Voltage :      | AC 120V/60Hz |
| Test Mode :   | TX G MODE 2412MHz              |                     |              |

| Freq.<br>(MHz) | Ant.Pol.<br>H/V | Reading        |              | Ant./CF<br>CF(dB) | Act.             |                | Limit            |                | Note       |
|----------------|-----------------|----------------|--------------|-------------------|------------------|----------------|------------------|----------------|------------|
|                |                 | Peak<br>(dBuV) | AV<br>(dBuV) |                   | Peak<br>(dBuV/m) | AV<br>(dBuV/m) | Peak<br>(dBuV/m) | AV<br>(dBuV/m) |            |
| 2390.00        | V               | 22.57          | 11.49        | 31.54             | 54.11            | 43.03          | 74.00            | 54.00          | X/E        |
| <b>2407.41</b> | <b>V</b>        | <b>67.10</b>   | <b>58.15</b> | <b>31.57</b>      | <b>98.67</b>     | <b>89.72</b>   |                  |                | <b>X/F</b> |
| 4824.10        | V               | 44.42          | 37.54        | 6.00              | 50.42            | 43.45          | 74.00            | 54.00          | X/H        |

Remark :

- (1) All readings are Peak unless otherwise stated QP in column of 『Note』 . Peak denotes that the Peak reading compliance with the QP Limits and then QP Mode measurement didn't perform ◦
- (2) Measuring frequency range from 30MHz to 1000MHz or the 10th harmonic of highest fundamental frequency ◦ "F" denotes fundamental frequency; "H" denotes spurious frequency. "E" denotes band edge frequency. (This judgment method includes the Band Edge Requirement.)
- (3) Radiated emissions measured in frequency range above 1000MHz were made with an instrument using Peak detector mode and AV detector mode of the emission ◦
- (4) Data of measurement within this frequency range shown " \* " in the table above means the reading of emissions are attenuated more than 20dB below the permissible limits or the field strength is too small to be measured.
- (5) A preamp and high pass filter were used for this test in order to provide sufficient measurement sensitivity.
- (6) EUT Orthogonal Axis :  
"X" - denotes Laid on Table ; "Y" - denotes Vertical Stand ; "Z" - denotes Side Stand
- (7) During the measurements above 1 GHz it is taken care of that the EUT is always within the 3 dB cone of radiation BW of the used antenna



TX CH01 (Above 1000 MHz, Vertical)

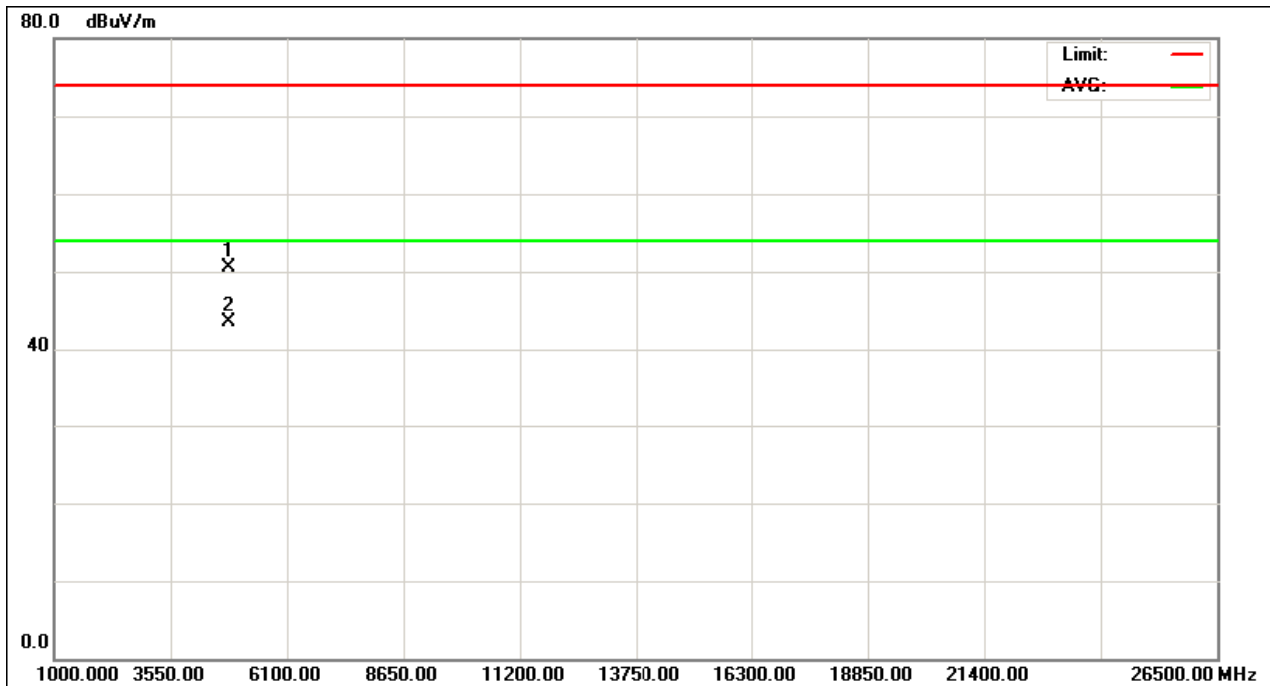
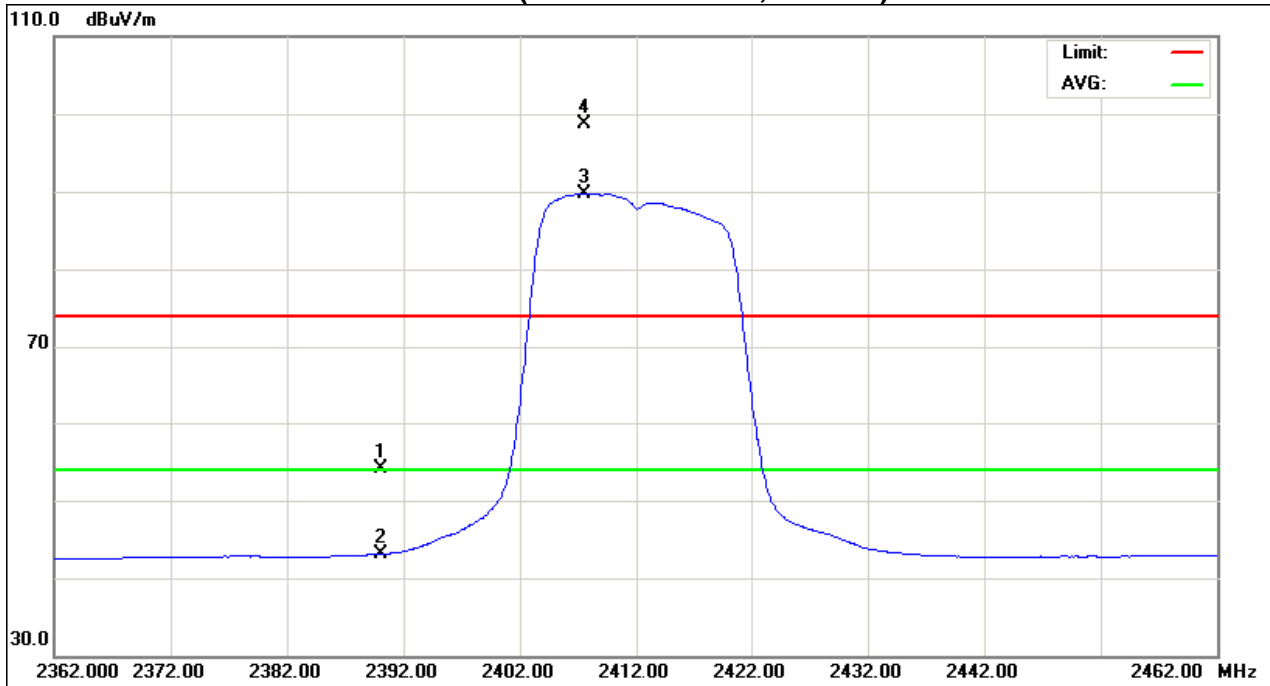



|               |                                |                     |              |
|---------------|--------------------------------|---------------------|--------------|
| EUT :         | 300Mbps Wireless-N USB Adapter | Model Name :        | WF-2109      |
| Temperature : | 25 °C                          | Relative Humidity : | 51 %         |
| Pressure :    | 1010 hPa                       | Test Voltage :      | AC 120V/60Hz |
| Test Mode :   | TX G MODE 2412MHz              |                     |              |

| Freq.<br>(MHz) | Ant.Pol.<br>H/V | Reading        |              | Ant./CF<br>CF(dB) | Act              |                | Limit            |                | Note       |
|----------------|-----------------|----------------|--------------|-------------------|------------------|----------------|------------------|----------------|------------|
|                |                 | Peak<br>(dBuV) | AV<br>(dBuV) |                   | Peak<br>(dBuV/m) | AV<br>(dBuV/m) | Peak<br>(dBuV/m) | AV<br>(dBuV/m) |            |
| 2390.00        | H               | 22.77          | 12.22        | 31.54             | 54.31            | 43.76          | 74.00            | 54.00          | X/E        |
| <b>2408.98</b> | <b>H</b>        | <b>69.33</b>   | <b>60.56</b> | <b>31.57</b>      | <b>100.90</b>    | <b>92.13</b>   |                  |                | <b>X/F</b> |
| 4824.13        | H               | 39.71          | 33.32        | 6.00              | 45.71            | 39.32          | 74.00            | 54.00          | X/H        |

Remark :

- (1) All readings are Peak unless otherwise stated QP in column of 『Note』 . Peak denotes that the Peak reading compliance with the QP Limits and then QP Mode measurement didn't perform ◦
- (2) Measuring frequency range from 30MHz to 1000MHz or the 10th harmonic of highest fundamental frequency ◦ "F" denotes fundamental frequency; "H" denotes spurious frequency. "E" denotes band edge frequency. (This judgment method includes the Band Edge Requirement.)
- (3) Radiated emissions measured in frequency range above 1000MHz were made with an instrument using Peak detector mode and AV detector mode of the emission ◦
- (4) Data of measurement within this frequency range shown " \* " in the table above means the reading of emissions are attenuated more than 20dB below the permissible limits or the field strength is too small to be measured.
- (5) A preamp and high pass filter were used for this test in order to provide sufficient measurement sensitivity.
- (6) EUT Orthogonal Axis :  
"X" - denotes Laid on Table ; "Y" - denotes Vertical Stand ; "Z" - denotes Side Stand
- (7) During the measurements above 1 GHz it is taken care of that the EUT is always within the 3 dB cone of radiation BW of the used antenna



TX CH01 (Above 1000 MHz, Horizontal)

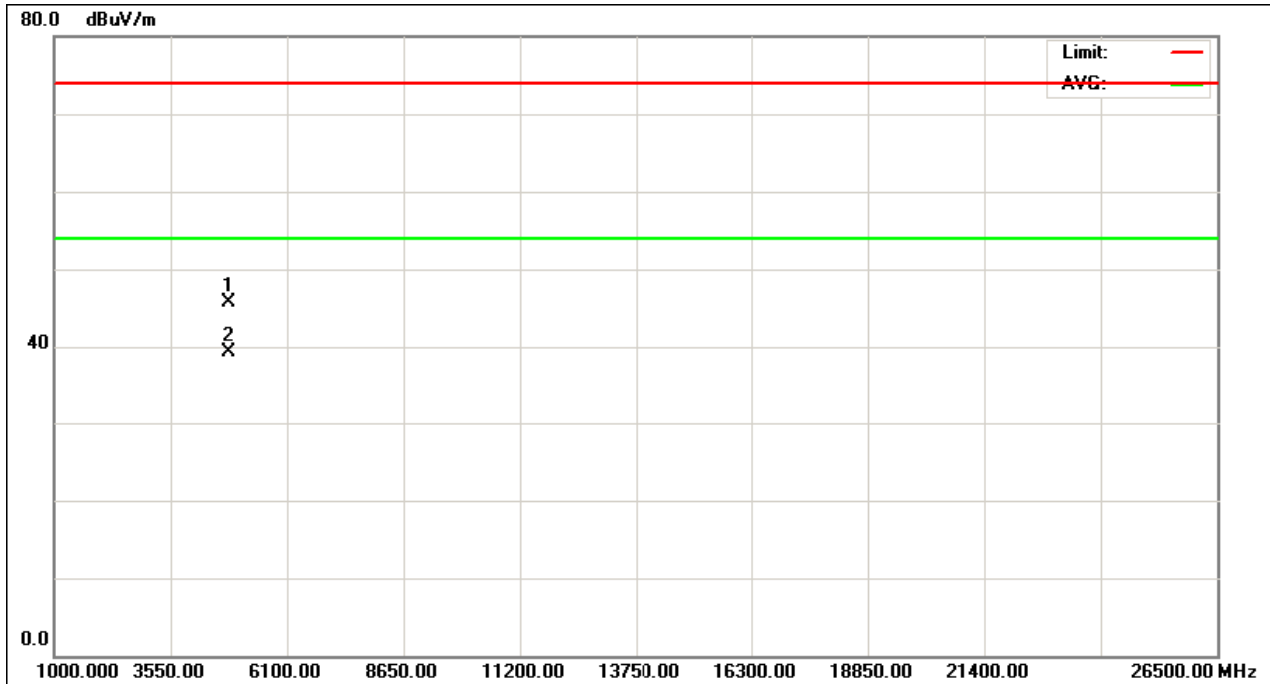
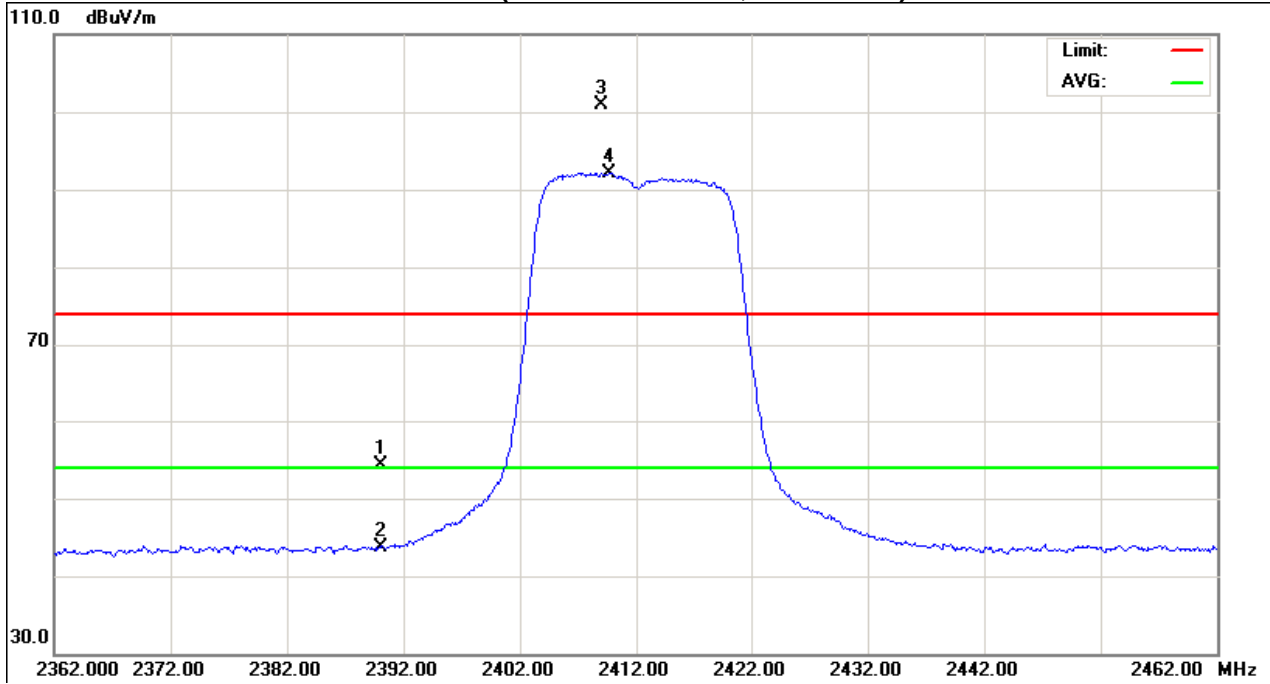





|               |                                |                     |              |
|---------------|--------------------------------|---------------------|--------------|
| EUT :         | 300Mbps Wireless-N USB Adapter | Model Name :        | WF-2109      |
| Temperature : | 25 °C                          | Relative Humidity : | 51 %         |
| Pressure :    | 1010 hPa                       | Test Voltage :      | AC 120V/60Hz |
| Test Mode :   | TX G MODE 2437MHz              |                     |              |

| Freq.<br>(MHz) | Ant.Pol.<br>H/V | Reading        |              | Ant./CF<br>CF(dB) | Act              |                | Limit            |                | Note       |
|----------------|-----------------|----------------|--------------|-------------------|------------------|----------------|------------------|----------------|------------|
|                |                 | Peak<br>(dBuV) | AV<br>(dBuV) |                   | Peak<br>(dBuV/m) | AV<br>(dBuV/m) | Peak<br>(dBuV/m) | AV<br>(dBuV/m) |            |
| <b>2430.33</b> | <b>V</b>        | <b>64.86</b>   | <b>55.91</b> | <b>31.61</b>      | <b>96.47</b>     | <b>87.52</b>   |                  |                | <b>X/F</b> |
| 4874.18        | V               | 40.59          | 33.51        | 6.15              | 46.74            | 39.66          | 74.00            | 54.00          | X/H        |

Remark :

- (1) All readings are Peak unless otherwise stated QP in column of 『Note』 . Peak denotes that the Peak reading compliance with the QP Limits and then QP Mode measurement didn't perform ◦
- (2) Measuring frequency range from 30MHz to 1000MHz or the 10th harmonic of highest fundamental frequency ◦ "F" denotes fundamental frequency; "H" denotes spurious frequency. "E" denotes band edge frequency. (This judgment method includes the Band Edge Requirement.)
- (3) Radiated emissions measured in frequency range above 1000MHz were made with an instrument using Peak detector mode and AV detector mode of the emission ◦
- (4) Data of measurement within this frequency range shown " \* " in the table above means the reading of emissions are attenuated more than 20dB below the permissible limits or the field strength is too small to be measured.
- (5) A preamp and high pass filter were used for this test in order to provide sufficient measurement sensitivity.
- (6) EUT Orthogonal Axis :  
"X" - denotes Laid on Table ; "Y" - denotes Vertical Stand ; "Z" - denotes Side Stand
- (7) During the measurements above 1 GHz it is taken care of that the EUT is always within the 3 dB cone of radiation BW of the used antenna



TX CH06 (Above 1000 MHz, Vertical)

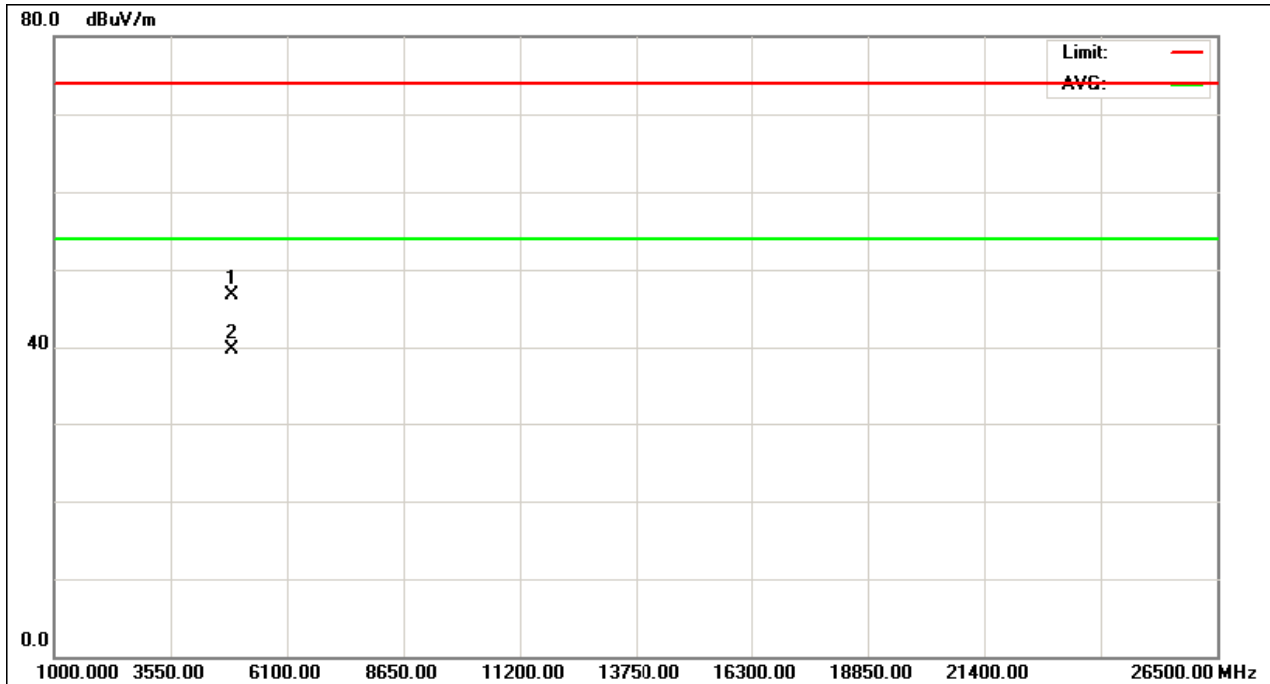
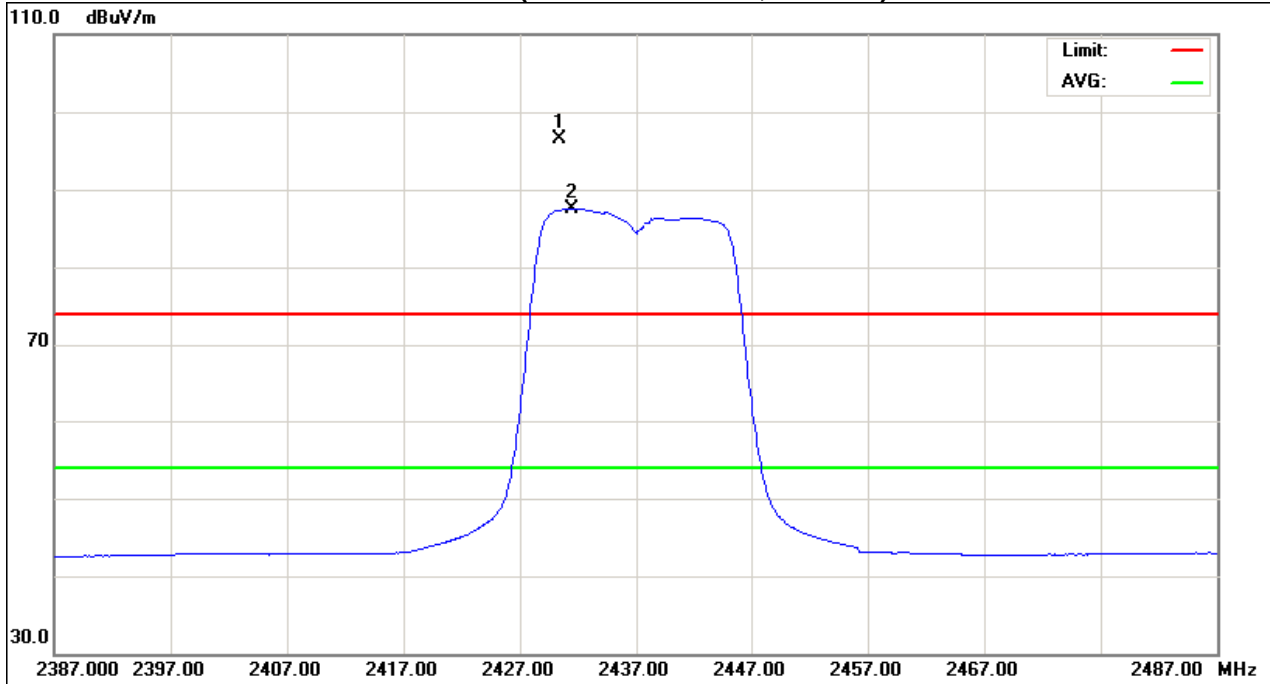



|               |                                |                     |              |
|---------------|--------------------------------|---------------------|--------------|
| EUT :         | 300Mbps Wireless-N USB Adapter | Model Name :        | WF-2109      |
| Temperature : | 25 °C                          | Relative Humidity : | 51 %         |
| Pressure :    | 1010 hPa                       | Test Voltage :      | AC 120V/60Hz |
| Test Mode :   | TX G MODE 2437MHz              |                     |              |

| Freq.          | Ant.Pol. | Reading      |              | Ant./CF      | Act.         |              | Limit    |          | Note       |
|----------------|----------|--------------|--------------|--------------|--------------|--------------|----------|----------|------------|
|                |          | Peak         | AV           |              | Peak         | AV           | Peak     | AV       |            |
| (MHz)          | H/V      | (dBuV)       | (dBuV)       | CF(dB)       | (dBuV/m)     | (dBuV/m)     | (dBuV/m) | (dBuV/m) |            |
| <b>2434.26</b> | <b>H</b> | <b>68.15</b> | <b>59.29</b> | <b>31.62</b> | <b>99.77</b> | <b>90.91</b> |          |          | <b>X/F</b> |
| 4874.05        | H        | 40.37        | 35.94        | 6.15         | 46.52        | 42.09        | 74.00    | 54.00    | X/H        |

Remark :

- (1) All readings are Peak unless otherwise stated QP in column of 『Note』 . Peak denotes that the Peak reading compliance with the QP Limits and then QP Mode measurement didn't perform ◦
- (2) Measuring frequency range from 30MHz to 1000MHz or the 10th harmonic of highest fundamental frequency ◦ "F" denotes fundamental frequency; "H" denotes spurious frequency. "E" denotes band edge frequency. (This judgment method includes the Band Edge Requirement.)
- (3) Radiated emissions measured in frequency range above 1000MHz were made with an instrument using Peak detector mode and AV detector mode of the emission ◦
- (4) Data of measurement within this frequency range shown " \* " in the table above means the reading of emissions are attenuated more than 20dB below the permissible limits or the field strength is too small to be measured.
- (5) A preamp and high pass filter were used for this test in order to provide sufficient measurement sensitivity.
- (6) EUT Orthogonal Axis :  
 "X" - denotes Laid on Table ; "Y" - denotes Vertical Stand ; "Z" - denotes Side Stand
- (7) During the measurements above 1 GHz it is taken care of that the EUT is always within the 3 dB cone of radiation BW of the used antenna



TX CH06 (Above 1000 MHz, Horizontal)

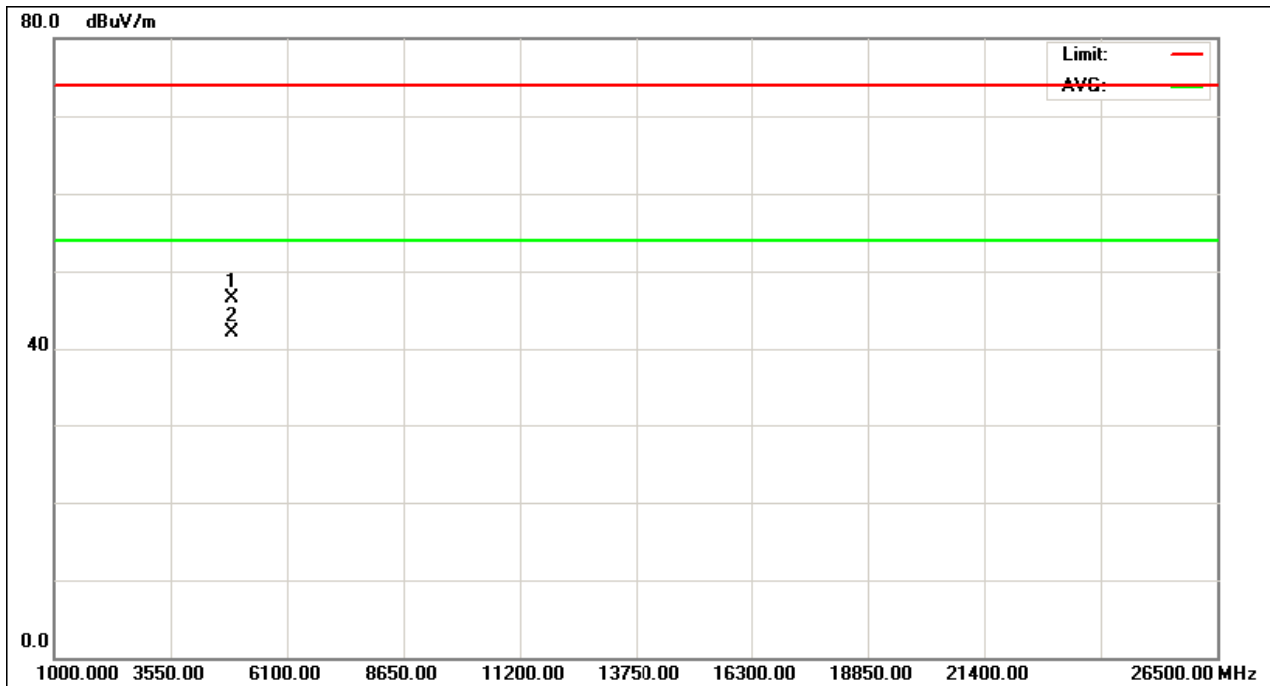
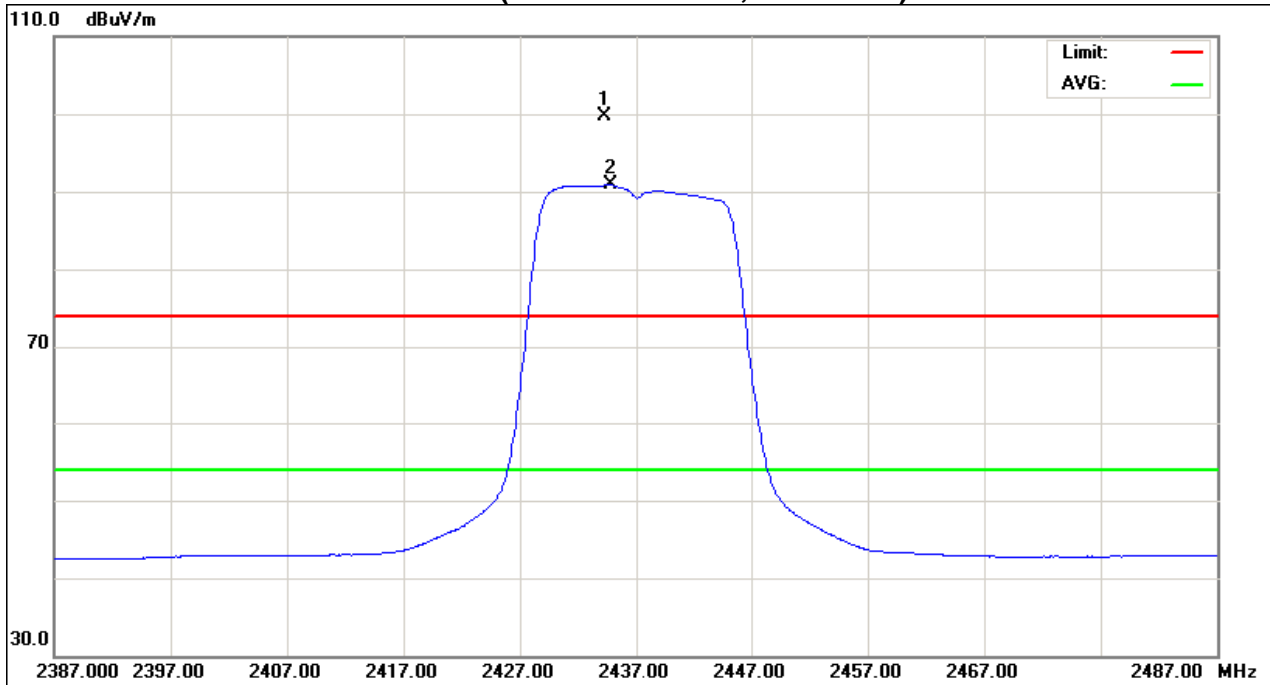



|               |                                |                     |              |
|---------------|--------------------------------|---------------------|--------------|
| EUT :         | 300Mbps Wireless-N USB Adapter | Model Name :        | WF-2109      |
| Temperature : | 25 °C                          | Relative Humidity : | 51 %         |
| Pressure :    | 1010 hPa                       | Test Voltage :      | AC 120V/60Hz |
| Test Mode :   | TX G MODE 2462MHz              |                     |              |

| Freq.          | Ant.Pol. | Reading      |              | Ant./CF      | Act.         |              | Limit    |          | Note       |
|----------------|----------|--------------|--------------|--------------|--------------|--------------|----------|----------|------------|
|                |          | Peak         | AV           |              | Peak         | AV           | Peak     | AV       |            |
| (MHz)          | H/V      | (dBuV)       | (dBuV)       | CF(dB)       | (dBuV/m)     | (dBuV/m)     | (dBuV/m) | (dBuV/m) |            |
| <b>2465.63</b> | <b>V</b> | <b>64.12</b> | <b>55.67</b> | <b>31.66</b> | <b>95.78</b> | <b>87.33</b> |          |          | <b>X/F</b> |
| 2483.50        | V        | 23.92        | 12.77        | 31.70        | 55.62        | 44.47        | 74.00    | 54.00    | X/E        |
| 4944.08        | V        | 37.09        | 32.36        | 6.35         | 43.44        | 38.71        | 74.00    | 54.00    | X/H        |

Remark :

- (1) All readings are Peak unless otherwise stated QP in column of 『Note』 . Peak denotes that the Peak reading compliance with the QP Limits and then QP Mode measurement didn't perform ◦
- (2) Measuring frequency range from 30MHz to 1000MHz or the 10th harmonic of highest fundamental frequency ◦ "F" denotes fundamental frequency; "H" denotes spurious frequency. "E" denotes band edge frequency. (This judgment method includes the Band Edge Requirement.)
- (3) Radiated emissions measured in frequency range above 1000MHz were made with an instrument using Peak detector mode and AV detector mode of the emission ◦
- (4) Data of measurement within this frequency range shown " \* " in the table above means the reading of emissions are attenuated more than 20dB below the permissible limits or the field strength is too small to be measured.
- (5) A preamp and high pass filter were used for this test in order to provide sufficient measurement sensitivity.
- (6) EUT Orthogonal Axis :  
 "X" - denotes Laid on Table ; "Y" - denotes Vertical Stand ; "Z" - denotes Side Stand
- (7) During the measurements above 1 GHz it is taken care of that the EUT is always within the 3 dB cone of radiation BW of the used antenna



TX CH11 (Above 1000 MHz, Vertical)

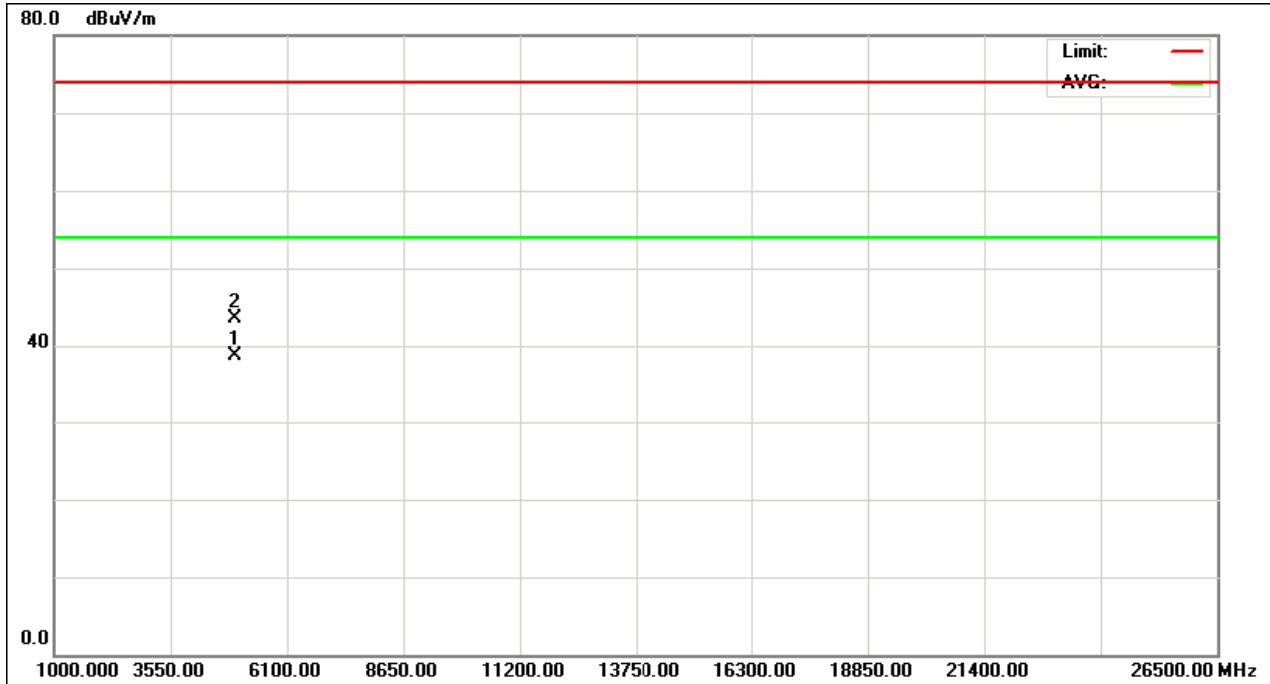
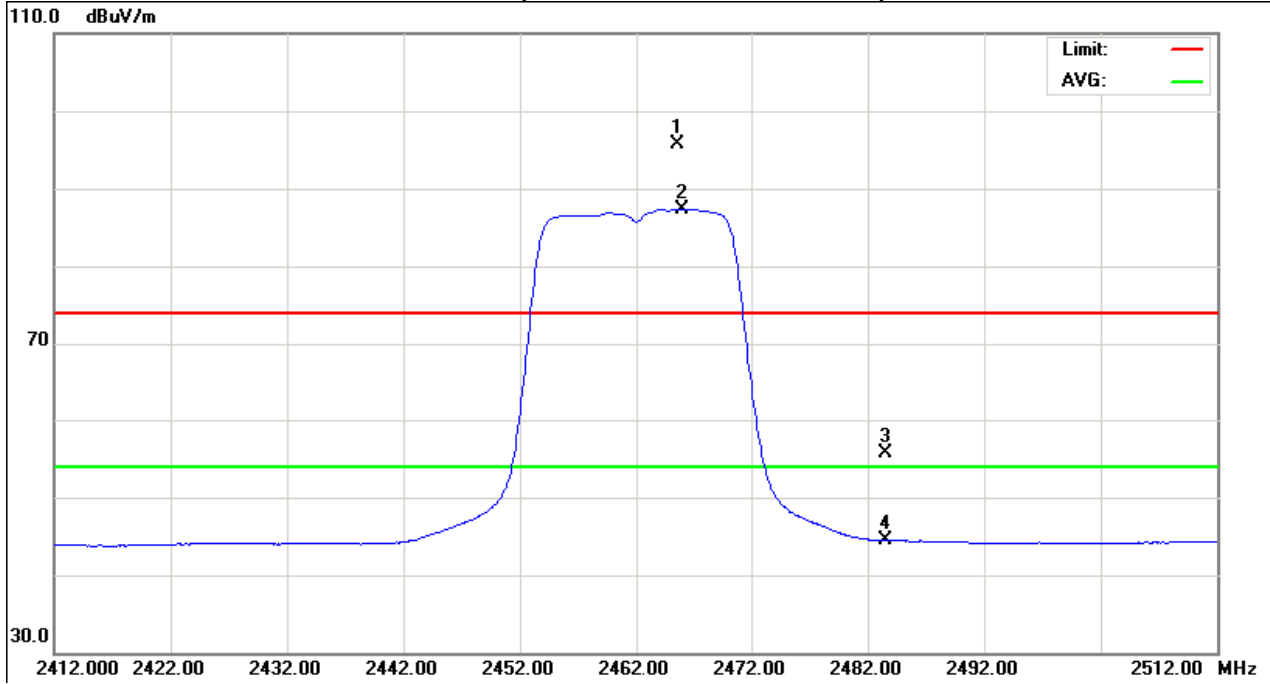



|               |                                |                     |              |
|---------------|--------------------------------|---------------------|--------------|
| EUT :         | 300Mbps Wireless-N USB Adapter | Model Name :        | WF-2109      |
| Temperature : | 25 °C                          | Relative Humidity : | 51 %         |
| Pressure :    | 1010 hPa                       | Test Voltage :      | AC 120V/60Hz |
| Test Mode :   | TX G MODE 2462MHz              |                     |              |

| Freq.          | Ant.Pol. | Reading      |              | Ant./CF      | Act.         |              | Limit    |          | Note       |
|----------------|----------|--------------|--------------|--------------|--------------|--------------|----------|----------|------------|
|                |          | Peak         | AV           |              | Peak         | AV           | Peak     | AV       |            |
| (MHz)          | H/V      | (dBuV)       | (dBuV)       | CF(dB)       | (dBuV/m)     | (dBuV/m)     | (dBuV/m) | (dBuV/m) |            |
| <b>2456.13</b> | <b>H</b> | <b>67.48</b> | <b>58.65</b> | <b>31.65</b> | <b>99.13</b> | <b>90.30</b> |          |          | <b>X/F</b> |
| 2483.50        | H        | 23.88        | 11.80        | 31.70        | 55.58        | 43.50        | 74.00    | 54.00    | X/E        |
| 4923.91        | H        | 37.84        | 31.71        | 6.30         | 44.14        | 38.01        | 74.00    | 54.00    | X/H        |

**Remark :**

- (1) All readings are Peak unless otherwise stated QP in column of 『Note』 . Peak denotes that the Peak reading compliance with the QP Limits and then QP Mode measurement didn't perform ◦
- (2) Measuring frequency range from 30MHz to 1000MHz or the 10th harmonic of highest fundamental frequency ◦ "F" denotes fundamental frequency; "H" denotes spurious frequency. "E" denotes band edge frequency. (This judgment method includes the Band Edge Requirement.)
- (3) Radiated emissions measured in frequency range above 1000MHz were made with an instrument using Peak detector mode and AV detector mode of the emission ◦
- (4) Data of measurement within this frequency range shown " \* " in the table above means the reading of emissions are attenuated more than 20dB below the permissible limits or the field strength is too small to be measured.
- (5) A preamp and high pass filter were used for this test in order to provide sufficient measurement sensitivity.
- (6) EUT Orthogonal Axis :  
 "X" - denotes Laid on Table ; "Y" - denotes Vertical Stand ; "Z" - denotes Side Stand
- (7) During the measurements above 1 GHz it is taken care of that the EUT is always within the 3 dB cone of radiation BW of the used antenna



TX CH11 (Above 1000 MHz, Horizontal)

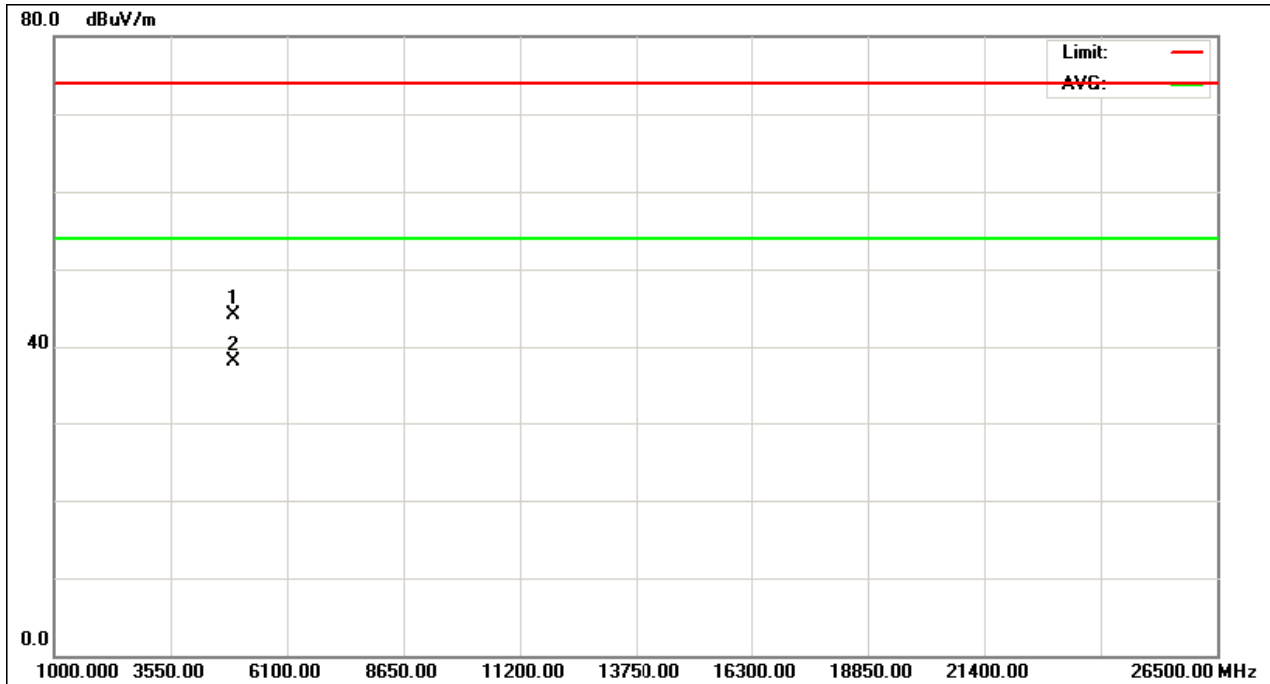
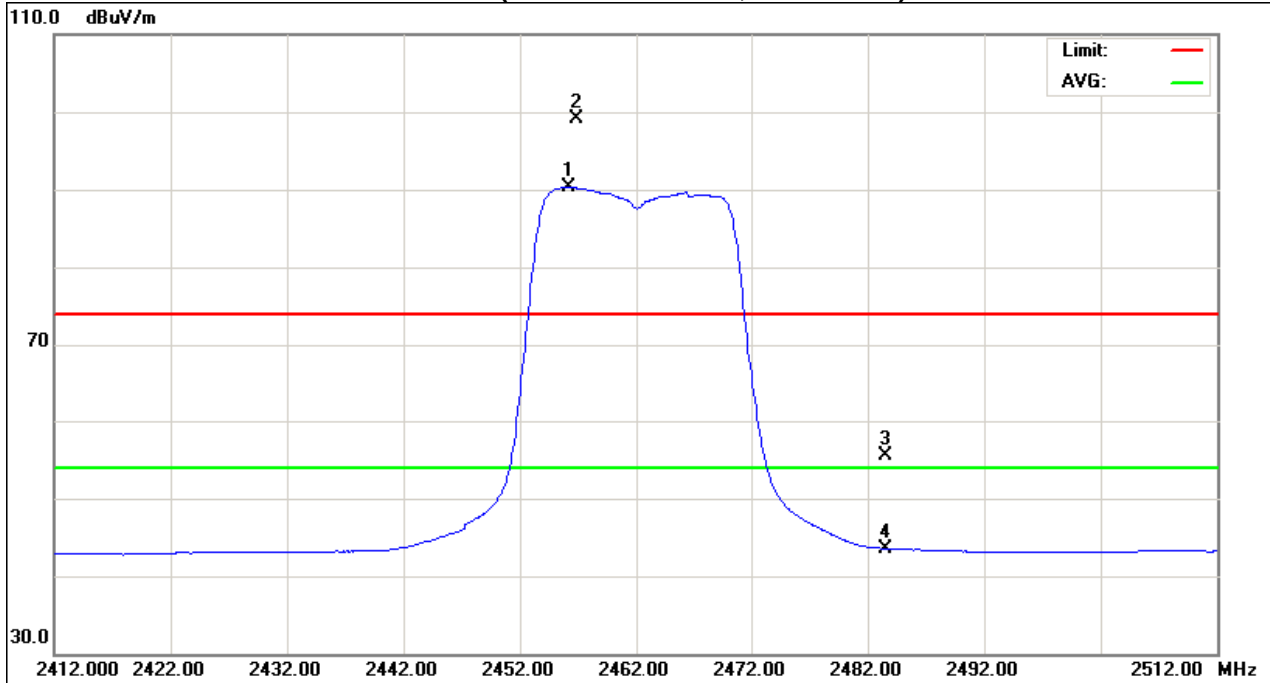





|               |                                |                     |              |
|---------------|--------------------------------|---------------------|--------------|
| EUT :         | 300Mbps Wireless-N USB Adapter | Model Name :        | WF-2109      |
| Temperature : | 25 °C                          | Relative Humidity : | 51 %         |
| Pressure :    | 1010 hPa                       | Test Voltage :      | AC 120V/60Hz |
| Test Mode :   | TX N-20M MODE 2412MHz          |                     |              |

| Freq.          | Ant.Pol. | Reading      |              | Ant./CF      | Act.         |              | Limit    |          | Note       |
|----------------|----------|--------------|--------------|--------------|--------------|--------------|----------|----------|------------|
|                |          | Peak         | AV           |              | Peak         | AV           | Peak     | AV       |            |
| (MHz)          | H/V      | (dBuV)       | (dBuV)       | CF(dB)       | (dBuV/m)     | (dBuV/m)     | (dBuV/m) | (dBuV/m) |            |
| 2390.00        | V        | 20.77        | 11.49        | 31.54        | 52.31        | 43.03        | 74.00    | 54.00    | X/E        |
| <b>2408.92</b> | <b>V</b> | <b>66.32</b> | <b>56.55</b> | <b>31.57</b> | <b>97.89</b> | <b>88.12</b> |          |          | <b>X/F</b> |
| 4824.01        | V        | 43.32        | 36.54        | 6.00         | 49.32        | 42.54        | 74.00    | 54.00    | X/H        |

Remark :

- (1) All readings are Peak unless otherwise stated QP in column of 『Note』 . Peak denotes that the Peak reading compliance with the QP Limits and then QP Mode measurement didn't perform ◦
- (2) Measuring frequency range from 30MHz to 1000MHz or the 10th harmonic of highest fundamental frequency ◦ "F" denotes fundamental frequency; "H" denotes spurious frequency. "E" denotes band edge frequency. (This judgment method includes the Band Edge Requirement.)
- (3) Radiated emissions measured in frequency range above 1000MHz were made with an instrument using Peak detector mode and AV detector mode of the emission ◦
- (4) Data of measurement within this frequency range shown " \* " in the table above means the reading of emissions are attenuated more than 20dB below the permissible limits or the field strength is too small to be measured.
- (5) A preamp and high pass filter were used for this test in order to provide sufficient measurement sensitivity.
- (6) EUT Orthogonal Axis :  
"X" - denotes Laid on Table ; "Y" - denotes Vertical Stand ; "Z" - denotes Side Stand
- (7) During the measurements above 1 GHz it is taken care of that the EUT is always within the 3 dB cone of radiation BW of the used antenna



TX CH01 (Above 1000 MHz, Vertical)

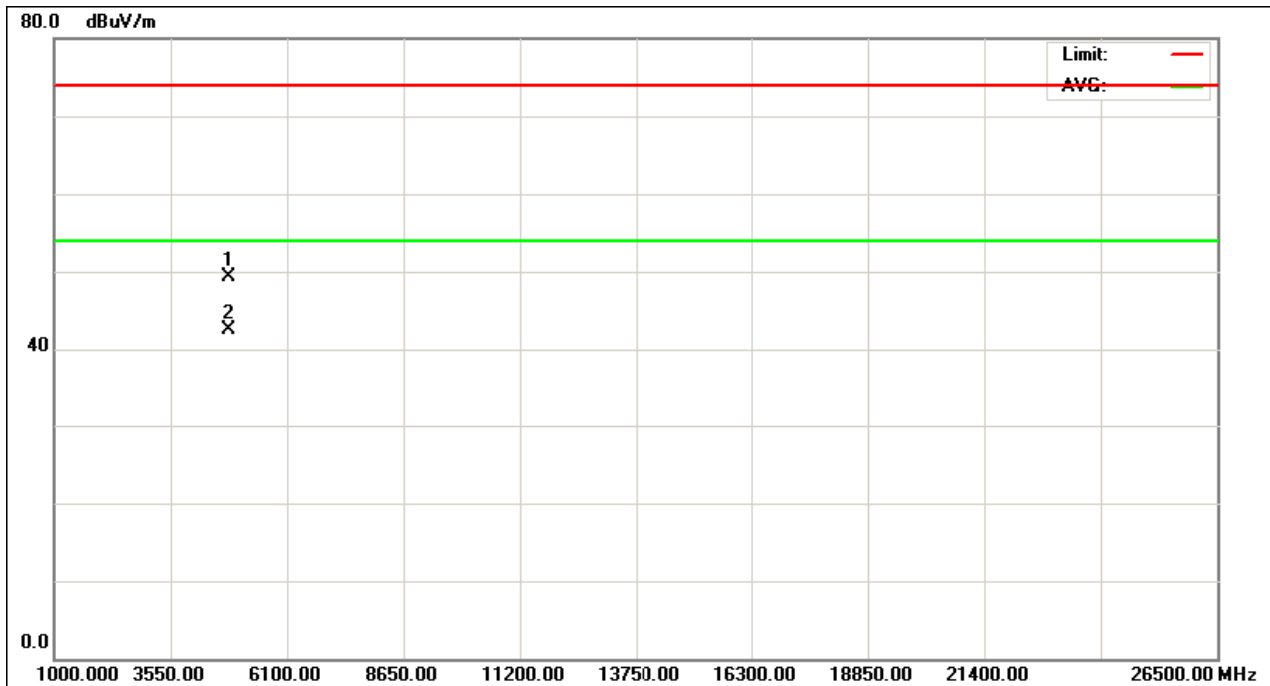
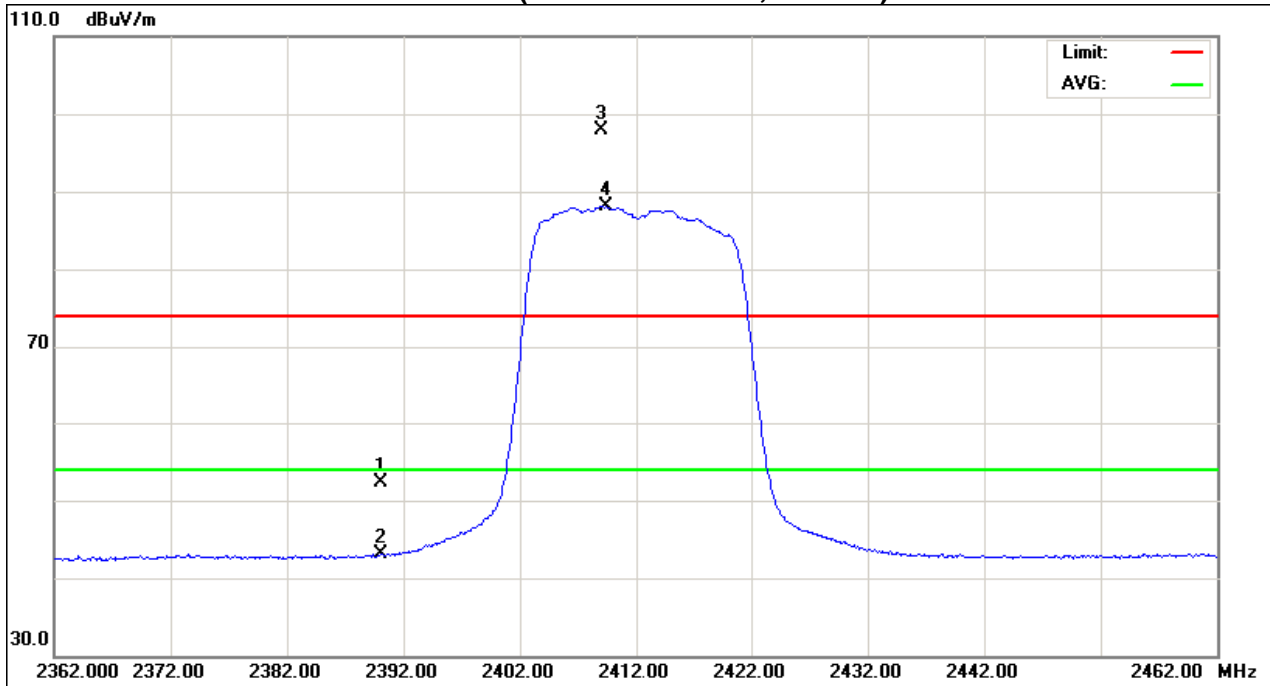



|               |                                |                     |              |
|---------------|--------------------------------|---------------------|--------------|
| EUT :         | 300Mbps Wireless-N USB Adapter | Model Name :        | WF-2109      |
| Temperature : | 25 °C                          | Relative Humidity : | 51 %         |
| Pressure :    | 1010 hPa                       | Test Voltage :      | AC 120V/60Hz |
| Test Mode :   | TX N-20M MODE 2412MHz          |                     |              |

| Freq.          | Ant.Pol. | Reading      |              | Ant./CF      | Act.         |              | Limit    |          | Note       |
|----------------|----------|--------------|--------------|--------------|--------------|--------------|----------|----------|------------|
|                |          | Peak         | AV           |              | Peak         | AV           | Peak     | AV       |            |
| (MHz)          | H/V      | (dBuV)       | (dBuV)       | CF(dB)       | (dBuV/m)     | (dBuV/m)     | (dBuV/m) | (dBuV/m) |            |
| 2390.00        | H        | 22.81        | 11.67        | 31.54        | 54.35        | 43.21        | 74.00    | 54.00    | X/E        |
| <b>2408.26</b> | <b>H</b> | <b>67.34</b> | <b>57.13</b> | <b>31.57</b> | <b>98.91</b> | <b>88.70</b> |          |          | <b>X/F</b> |
| 4824.11        | H        | 39.54        | 32.06        | 6.00         | 45.54        | 38.06        | 74.00    | 54.00    | X/H        |

Remark :

- (1) All readings are Peak unless otherwise stated QP in column of 『Note』 . Peak denotes that the Peak reading compliance with the QP Limits and then QP Mode measurement didn't perform ◦
- (2) Measuring frequency range from 30MHz to 1000MHz or the 10th harmonic of highest fundamental frequency ◦ "F" denotes fundamental frequency; "H" denotes spurious frequency. "E" denotes band edge frequency. (This judgment method includes the Band Edge Requirement.)
- (3) Radiated emissions measured in frequency range above 1000MHz were made with an instrument using Peak detector mode and AV detector mode of the emission ◦
- (4) Data of measurement within this frequency range shown " \* " in the table above means the reading of emissions are attenuated more than 20dB below the permissible limits or the field strength is too small to be measured.
- (5) A preamp and high pass filter were used for this test in order to provide sufficient measurement sensitivity.
- (6) EUT Orthogonal Axis :  
 "X" - denotes Laid on Table ; "Y" - denotes Vertical Stand ; "Z" - denotes Side Stand
- (7) During the measurements above 1 GHz it is taken care of that the EUT is always within the 3 dB cone of radiation BW of the used antenna



TX CH01 (Above 1000 MHz, Horizontal)

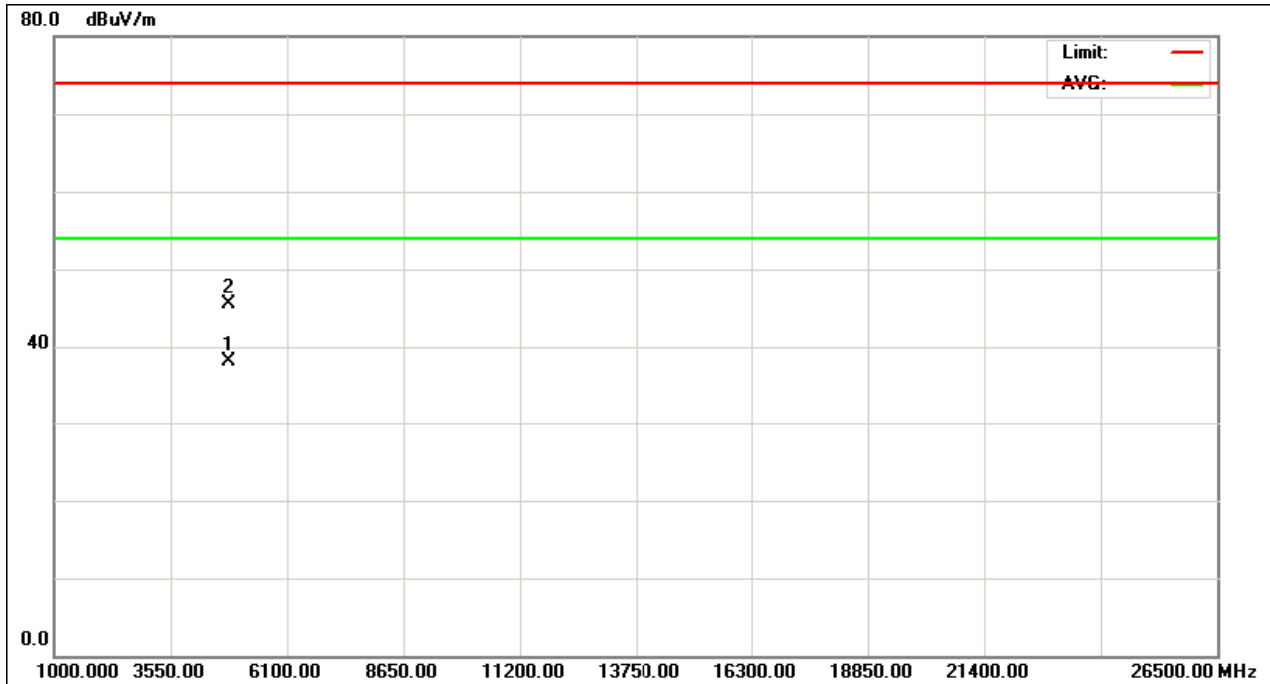
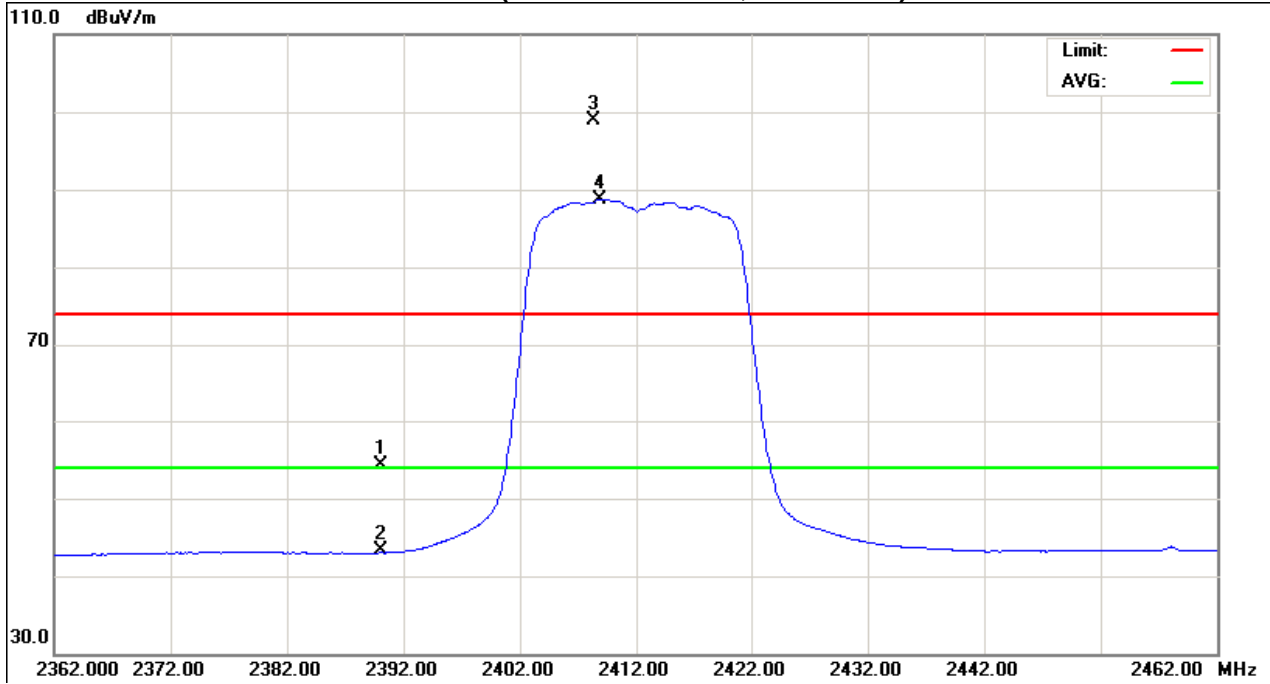



|               |                                |                     |              |
|---------------|--------------------------------|---------------------|--------------|
| EUT :         | 300Mbps Wireless-N USB Adapter | Model Name :        | WF-2109      |
| Temperature : | 25 °C                          | Relative Humidity : | 51 %         |
| Pressure :    | 1010 hPa                       | Test Voltage :      | AC 120V/60Hz |
| Test Mode :   | TX N-20M MODE 2437MHz          |                     |              |

| Freq.<br>(MHz) | Ant.Pol.<br>H/V | Reading        |              | Ant./CF<br>CF(dB) | Act.             |                | Limit            |                | Note       |
|----------------|-----------------|----------------|--------------|-------------------|------------------|----------------|------------------|----------------|------------|
|                |                 | Peak<br>(dBuV) | AV<br>(dBuV) |                   | Peak<br>(dBuV/m) | AV<br>(dBuV/m) | Peak<br>(dBuV/m) | AV<br>(dBuV/m) |            |
| <b>2431.33</b> | <b>V</b>        | <b>63.04</b>   | <b>53.80</b> | <b>31.61</b>      | <b>94.66</b>     | <b>85.41</b>   |                  |                | <b>X/F</b> |
| 4874.14        | V               | 42.06          | 37.93        | 6.15              | 48.21            | 44.08          | 74.00            | 54.00          | X/H        |

Remark :

- (1) All readings are Peak unless otherwise stated QP in column of 『Note』 . Peak denotes that the Peak reading compliance with the QP Limits and then QP Mode measurement didn't perform ◦
- (2) Measuring frequency range from 30MHz to 1000MHz or the 10th harmonic of highest fundamental frequency ◦ "F" denotes fundamental frequency; "H" denotes spurious frequency. "E" denotes band edge frequency. (This judgment method includes the Band Edge Requirement.)
- (3) Radiated emissions measured in frequency range above 1000MHz were made with an instrument using Peak detector mode and AV detector mode of the emission ◦
- (4) Data of measurement within this frequency range shown " \* " in the table above means the reading of emissions are attenuated more than 20dB below the permissible limits or the field strength is too small to be measured.
- (5) A preamp and high pass filter were used for this test in order to provide sufficient measurement sensitivity.
- (6) EUT Orthogonal Axis :  
"X" - denotes Laid on Table ; "Y" - denotes Vertical Stand ; "Z" - denotes Side Stand
- (7) During the measurements above 1 GHz it is taken care of that the EUT is always within the 3 dB cone of radiation BW of the used antenna



TX CH06 (Above 1000 MHz, Vertical)

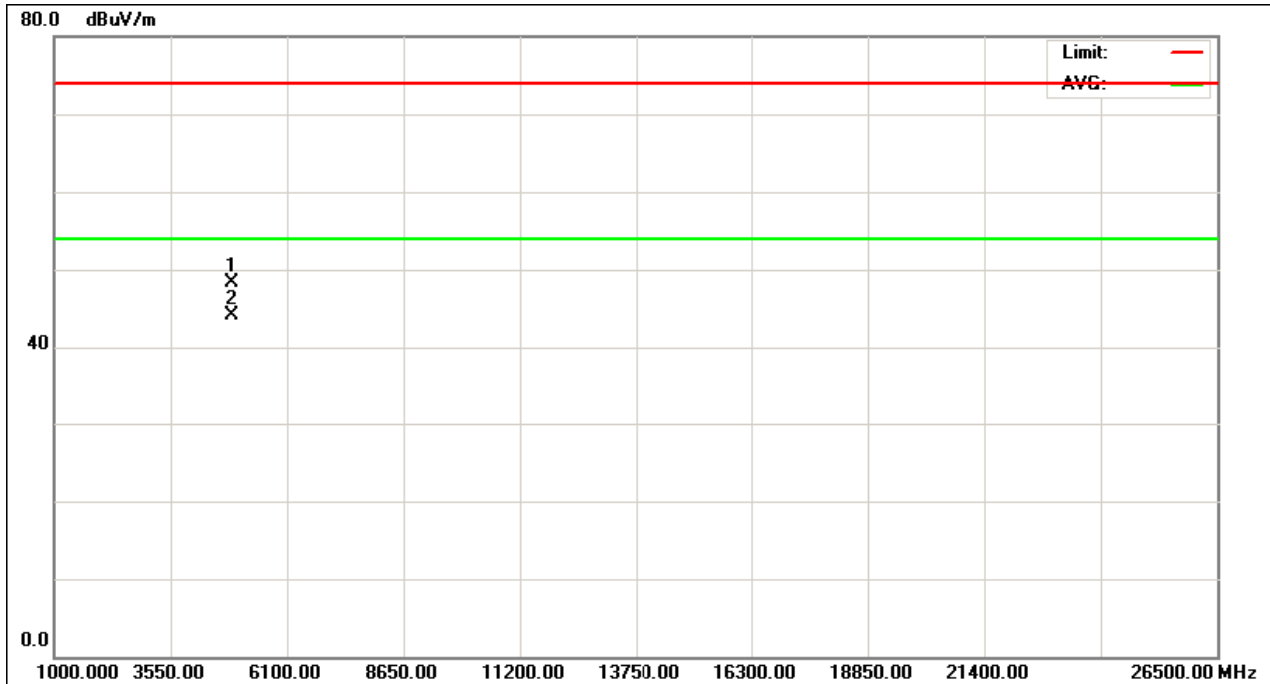
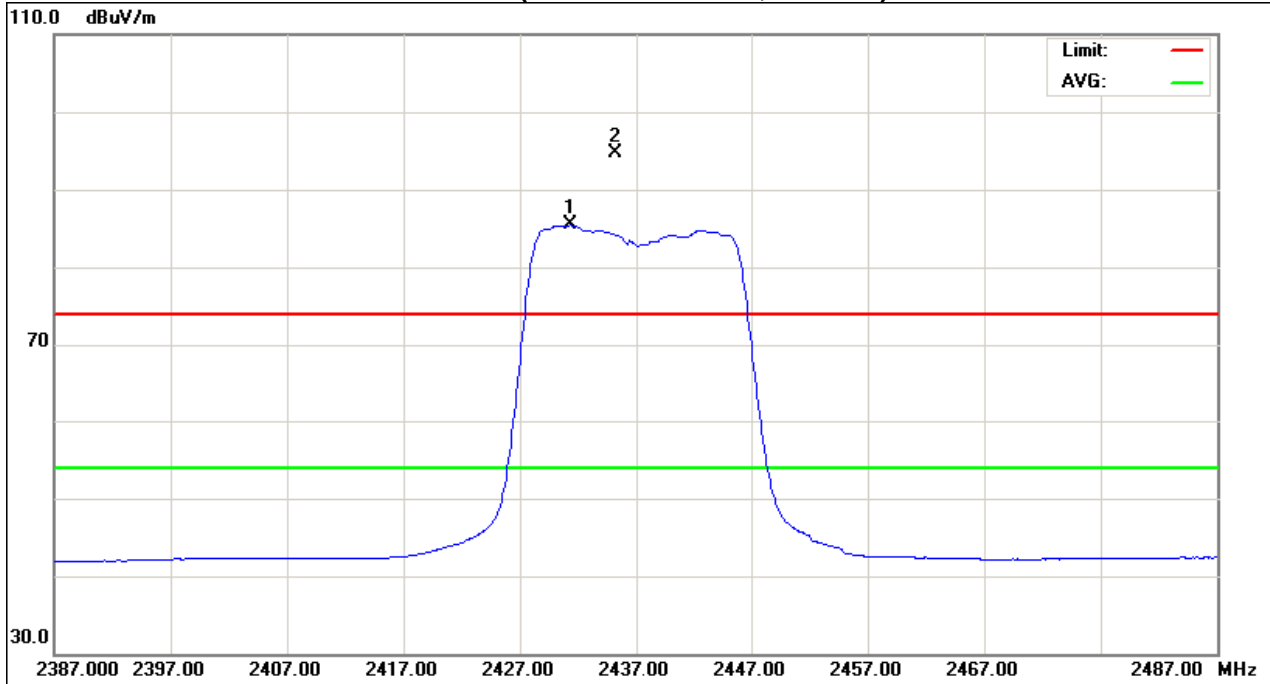



|               |                                |                     |              |
|---------------|--------------------------------|---------------------|--------------|
| EUT :         | 300Mbps Wireless-N USB Adapter | Model Name :        | WF-2109      |
| Temperature : | 25 °C                          | Relative Humidity : | 51 %         |
| Pressure :    | 1010 hPa                       | Test Voltage :      | AC 120V/60Hz |
| Test Mode :   | TX N-20M MODE 2437MHz          |                     |              |

| Freq.          | Ant.Pol. | Reading      |              | Ant./CF      | Act.          |              | Limit    |          | Note       |
|----------------|----------|--------------|--------------|--------------|---------------|--------------|----------|----------|------------|
|                |          | Peak         | AV           |              | Peak          | AV           | Peak     | AV       |            |
| (MHz)          | H/V      | (dBuV)       | (dBuV)       | CF(dB)       | (dBuV/m)      | (dBuV/m)     | (dBuV/m) | (dBuV/m) |            |
| <b>2434.20</b> | <b>H</b> | <b>68.98</b> | <b>59.09</b> | <b>31.62</b> | <b>100.60</b> | <b>90.71</b> |          |          | <b>X/F</b> |
| 4874.05        | H        | 40.42        | 32.87        | 6.15         | 46.57         | 39.02        | 74.00    | 54.00    | X/H        |

Remark :

- (1) All readings are Peak unless otherwise stated QP in column of 『Note』 . Peak denotes that the Peak reading compliance with the QP Limits and then QP Mode measurement didn't perform ◦
- (2) Measuring frequency range from 30MHz to 1000MHz or the 10th harmonic of highest fundamental frequency ◦ "F" denotes fundamental frequency; "H" denotes spurious frequency. "E" denotes band edge frequency. (This judgment method includes the Band Edge Requirement.)
- (3) Radiated emissions measured in frequency range above 1000MHz were made with an instrument using Peak detector mode and AV detector mode of the emission ◦
- (4) Data of measurement within this frequency range shown " \* " in the table above means the reading of emissions are attenuated more than 20dB below the permissible limits or the field strength is too small to be measured.
- (5) A preamp and high pass filter were used for this test in order to provide sufficient measurement sensitivity.
- (6) EUT Orthogonal Axis :  
 "X" - denotes Laid on Table ; "Y" - denotes Vertical Stand ; "Z" - denotes Side Stand
- (7) During the measurements above 1 GHz it is taken care of that the EUT is always within the 3 dB cone of radiation BW of the used antenna



TX CH06 (Above 1000 MHz, Horizontal)

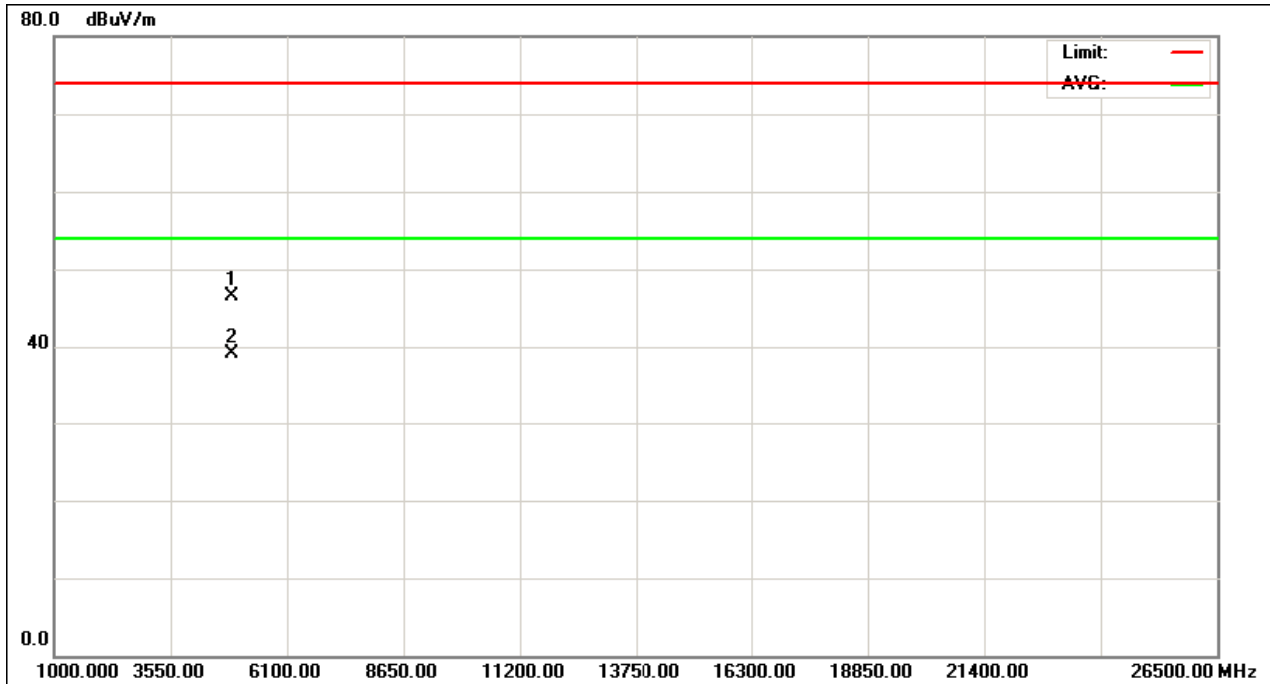
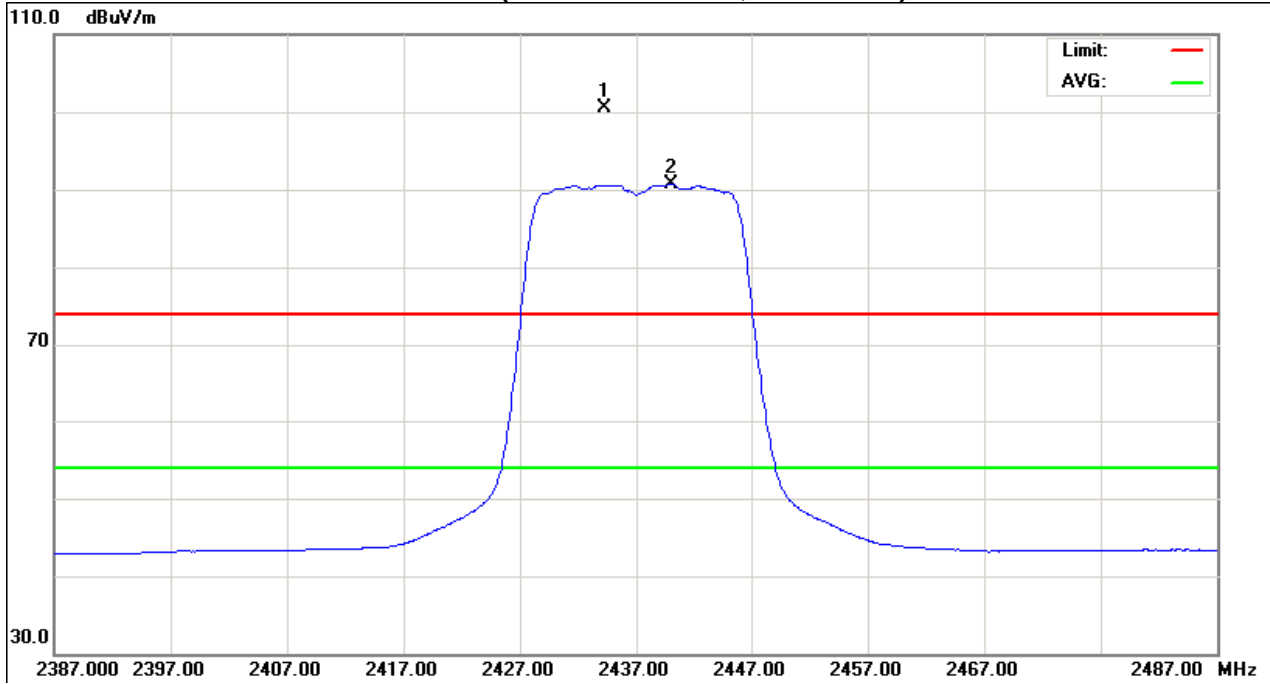





|               |                                |                     |              |
|---------------|--------------------------------|---------------------|--------------|
| EUT :         | 300Mbps Wireless-N USB Adapter | Model Name :        | WF-2109      |
| Temperature : | 25 °C                          | Relative Humidity : | 51 %         |
| Pressure :    | 1010 hPa                       | Test Voltage :      | AC 120V/60Hz |
| Test Mode :   | TX N-20M MODE 2462MHz          |                     |              |

| Freq.          | Ant.Pol. | Reading      |              | Ant./CF      | Act.         |              | Limit    |          | Note       |
|----------------|----------|--------------|--------------|--------------|--------------|--------------|----------|----------|------------|
|                |          | Peak         | AV           |              | Peak         | AV           | Peak     | AV       |            |
| (MHz)          | H/V      | (dBuV)       | (dBuV)       | CF(dB)       | (dBuV/m)     | (dBuV/m)     | (dBuV/m) | (dBuV/m) |            |
| <b>2459.52</b> | <b>V</b> | <b>62.40</b> | <b>52.94</b> | <b>31.65</b> | <b>94.05</b> | <b>84.60</b> |          |          | <b>X/F</b> |
| 2483.50        | V        | 23.96        | 11.32        | 31.70        | 55.66        | 43.02        | 74.00    | 54.00    | X/E        |
| 4944.10        | V        | 43.27        | 33.91        | 6.35         | 49.62        | 40.26        | 74.00    | 54.00    | X/H        |

Remark :

- (1) All readings are Peak unless otherwise stated QP in column of 『Note』 . Peak denotes that the Peak reading compliance with the QP Limits and then QP Mode measurement didn't perform ◦
- (2) Measuring frequency range from 30MHz to 1000MHz or the 10th harmonic of highest fundamental frequency ◦ "F" denotes fundamental frequency; "H" denotes spurious frequency. "E" denotes band edge frequency. (This judgment method includes the Band Edge Requirement.)
- (3) Radiated emissions measured in frequency range above 1000MHz were made with an instrument using Peak detector mode and AV detector mode of the emission ◦
- (4) Data of measurement within this frequency range shown " \* " in the table above means the reading of emissions are attenuated more than 20dB below the permissible limits or the field strength is too small to be measured.
- (5) A preamp and high pass filter were used for this test in order to provide sufficient measurement sensitivity.
- (6) EUT Orthogonal Axis :  
"X" - denotes Laid on Table ; "Y" - denotes Vertical Stand ; "Z" - denotes Side Stand
- (7) During the measurements above 1 GHz it is taken care of that the EUT is always within the 3 dB cone of radiation BW of the used antenna



TX CH11 (Above 1000 MHz, Vertical)

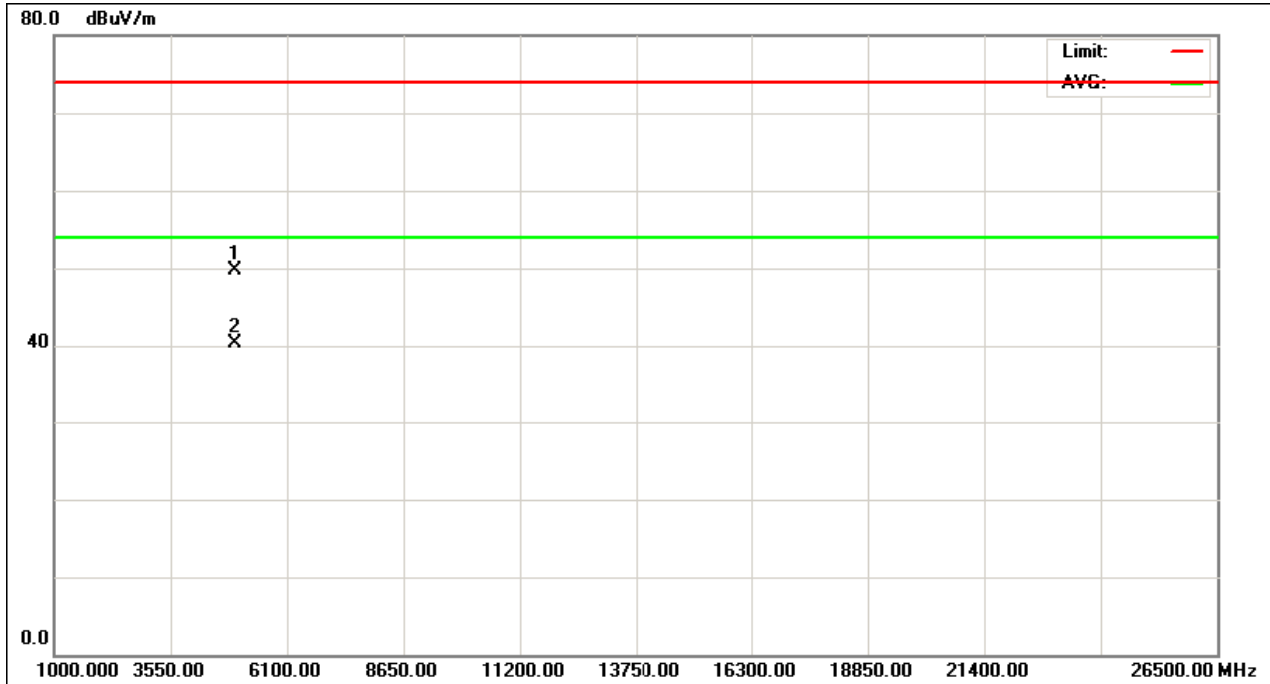
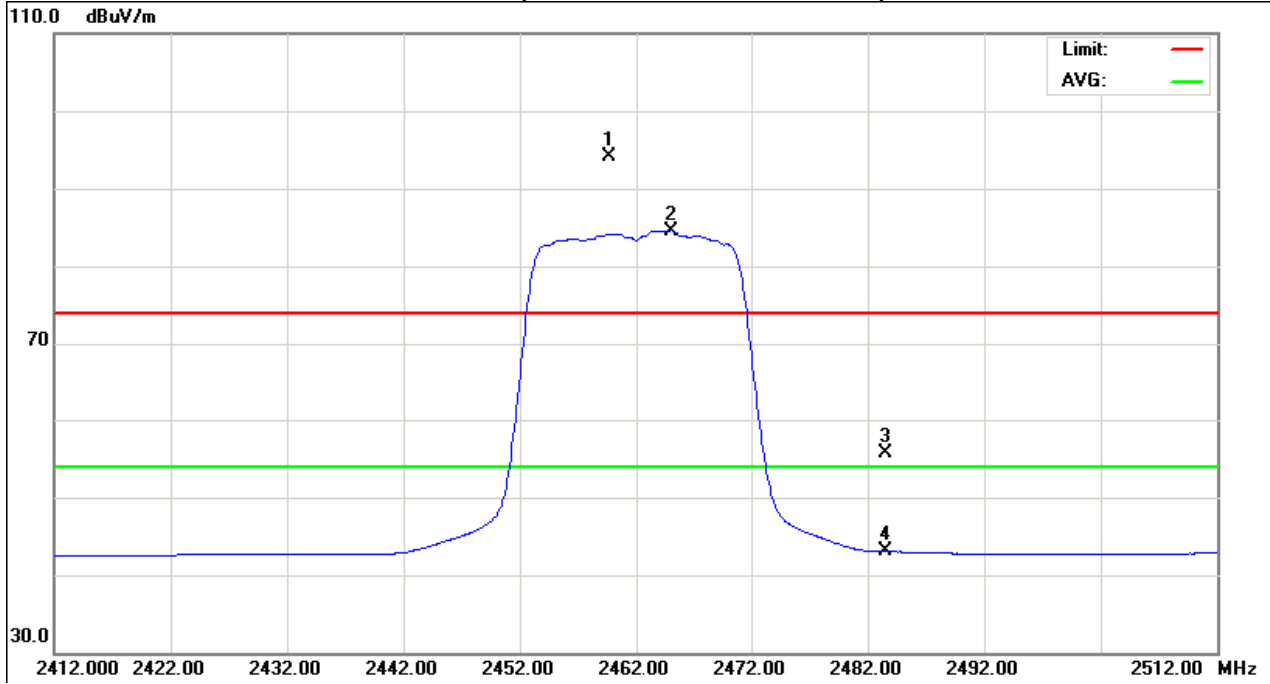



|               |                                |                     |              |
|---------------|--------------------------------|---------------------|--------------|
| EUT :         | 300Mbps Wireless-N USB Adapter | Model Name :        | WF-2109      |
| Temperature : | 25 °C                          | Relative Humidity : | 51 %         |
| Pressure :    | 1010 hPa                       | Test Voltage :      | AC 120V/60Hz |
| Test Mode :   | TX N-20M MODE 2462MHz          |                     |              |

| Freq.          | Ant.Pol. | Reading      |              | Ant./CF      | Act.         |              | Limit    |          | Note       |
|----------------|----------|--------------|--------------|--------------|--------------|--------------|----------|----------|------------|
|                |          | Peak         | AV           |              | Peak         | AV           | Peak     | AV       |            |
| (MHz)          | H/V      | (dBuV)       | (dBuV)       | CF(dB)       | (dBuV/m)     | (dBuV/m)     | (dBuV/m) | (dBuV/m) |            |
| <b>2456.36</b> | <b>H</b> | <b>68.24</b> | <b>59.56</b> | <b>31.65</b> | <b>99.89</b> | <b>91.21</b> |          |          | <b>X/F</b> |
| 2483.50        | H        | 23.76        | 13.10        | 31.70        | 55.46        | 44.80        | 74.00    | 54.00    | X/E        |
| 4923.96        | H        | 37.94        | 31.30        | 6.30         | 44.24        | 37.60        | 74.00    | 54.00    | X/H        |

Remark :

- (1) All readings are Peak unless otherwise stated QP in column of 『Note』 . Peak denotes that the Peak reading compliance with the QP Limits and then QP Mode measurement didn't perform ◦
- (2) Measuring frequency range from 30MHz to 1000MHz or the 10th harmonic of highest fundamental frequency ◦ "F" denotes fundamental frequency; "H" denotes spurious frequency. "E" denotes band edge frequency. (This judgment method includes the Band Edge Requirement.)
- (3) Radiated emissions measured in frequency range above 1000MHz were made with an instrument using Peak detector mode and AV detector mode of the emission ◦
- (4) Data of measurement within this frequency range shown " \* " in the table above means the reading of emissions are attenuated more than 20dB below the permissible limits or the field strength is too small to be measured.
- (5) A preamp and high pass filter were used for this test in order to provide sufficient measurement sensitivity.
- (6) EUT Orthogonal Axis :  
"X" - denotes Laid on Table ; "Y" - denotes Vertical Stand ; "Z" - denotes Side Stand
- (7) During the measurements above 1 GHz it is taken care of that the EUT is always within the 3 dB cone of radiation BW of the used antenna



TX CH11 (Above 1000 MHz, Horizontal)

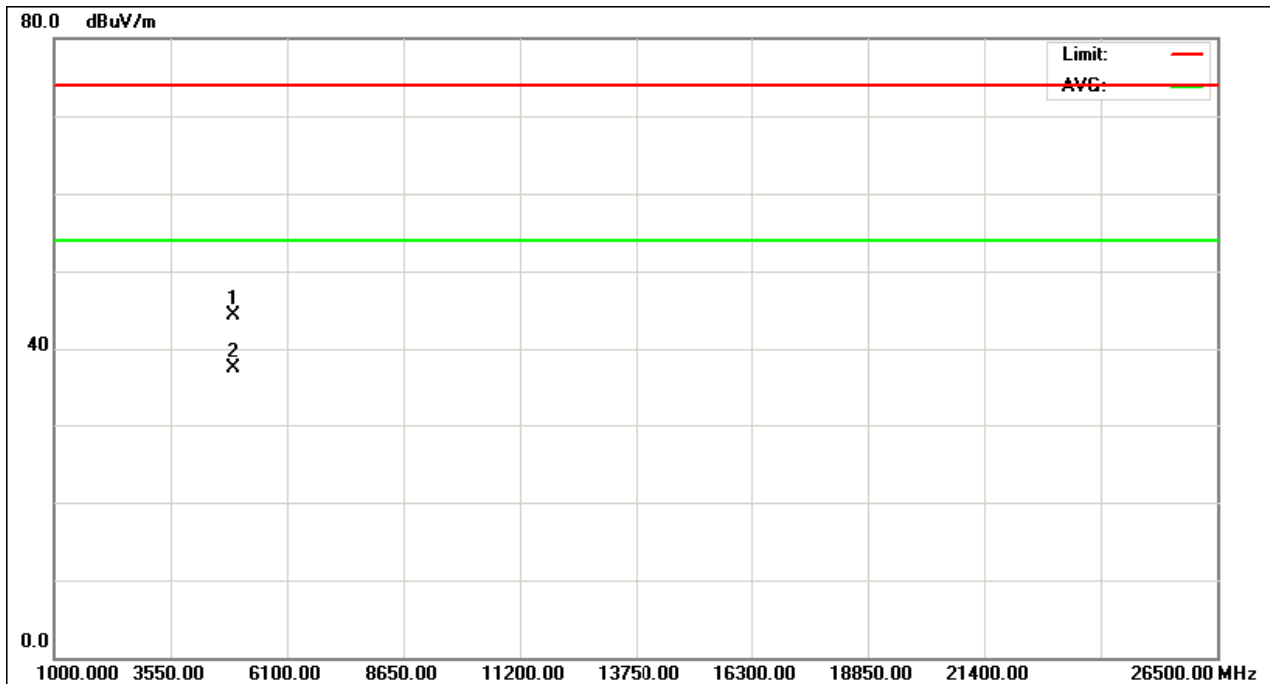
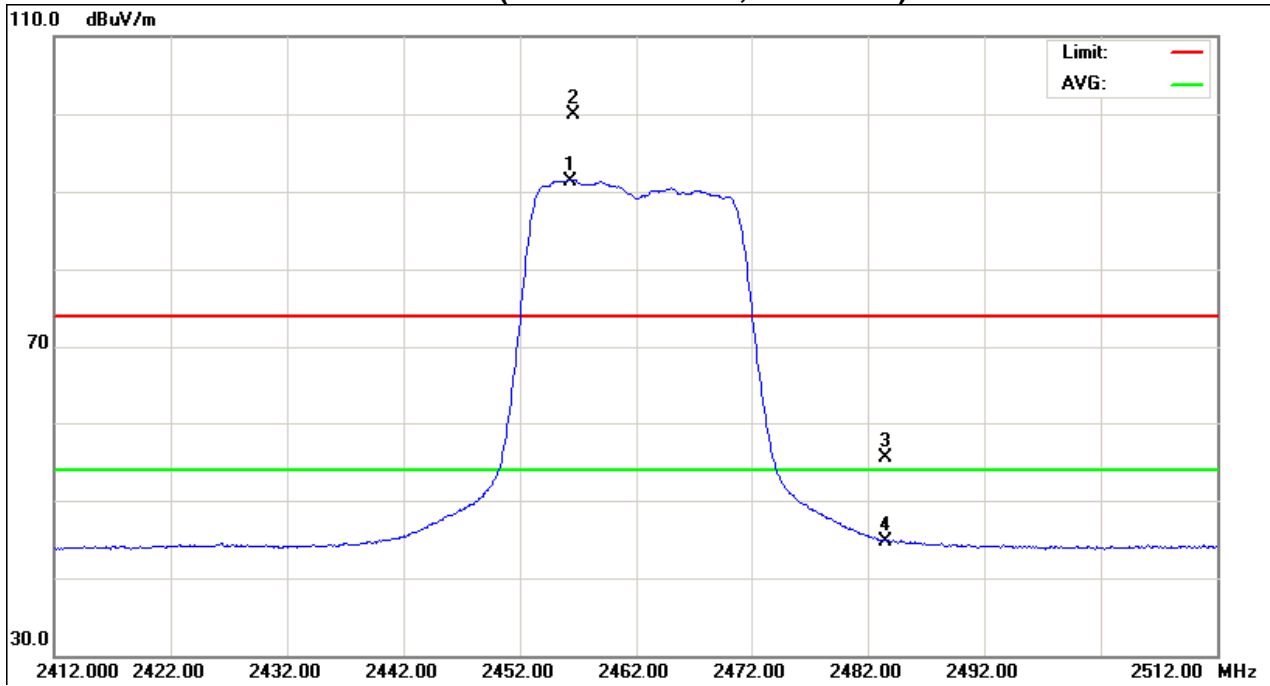



|               |                                |                     |              |
|---------------|--------------------------------|---------------------|--------------|
| EUT :         | 300Mbps Wireless-N USB Adapter | Model Name :        | WF-2109      |
| Temperature : | 25 °C                          | Relative Humidity : | 51 %         |
| Pressure :    | 1010 hPa                       | Test Voltage :      | AC 120V/60Hz |
| Test Mode :   | TX N-40M MODE 2422MHz          |                     |              |

| Freq.          | Ant.Pol. | Reading      |              | Ant./CF      | Act.         |              | Limit    |          | Note       |
|----------------|----------|--------------|--------------|--------------|--------------|--------------|----------|----------|------------|
|                |          | Peak         | AV           |              | Peak         | AV           | Peak     | AV       |            |
| (MHz)          | H/V      | (dBuV)       | (dBuV)       | CF(dB)       | (dBuV/m)     | (dBuV/m)     | (dBuV/m) | (dBuV/m) |            |
| 2390.00        | V        | 23.38        | 12.21        | 31.54        | 54.92        | 43.75        | 74.00    | 54.00    | X/E        |
| <b>2407.20</b> | <b>V</b> | <b>64.12</b> | <b>54.82</b> | <b>31.57</b> | <b>95.70</b> | <b>86.39</b> |          |          | <b>X/F</b> |
| 4844.01        | V        | 41.97        | 36.09        | 6.06         | 48.05        | 42.15        | 74.00    | 54.00    | X/H        |

Remark :

- (1) All readings are Peak unless otherwise stated QP in column of 『Note』 . Peak denotes that the Peak reading compliance with the QP Limits and then QP Mode measurement didn't perform ◦
- (2) Measuring frequency range from 30MHz to 1000MHz or the 10th harmonic of highest fundamental frequency ◦ "F" denotes fundamental frequency; "H" denotes spurious frequency. "E" denotes band edge frequency. (This judgment method includes the Band Edge Requirement.)
- (3) Radiated emissions measured in frequency range above 1000MHz were made with an instrument using Peak detector mode and AV detector mode of the emission ◦
- (4) Data of measurement within this frequency range shown " \* " in the table above means the reading of emissions are attenuated more than 20dB below the permissible limits or the field strength is too small to be measured.
- (5) A preamp and high pass filter were used for this test in order to provide sufficient measurement sensitivity.
- (6) EUT Orthogonal Axis :  
"X" - denotes Laid on Table ; "Y" - denotes Vertical Stand ; "Z" - denotes Side Stand
- (7) During the measurements above 1 GHz it is taken care of that the EUT is always within the 3 dB cone of radiation BW of the used antenna



TX CH03 (Above 1000 MHz, Vertical)

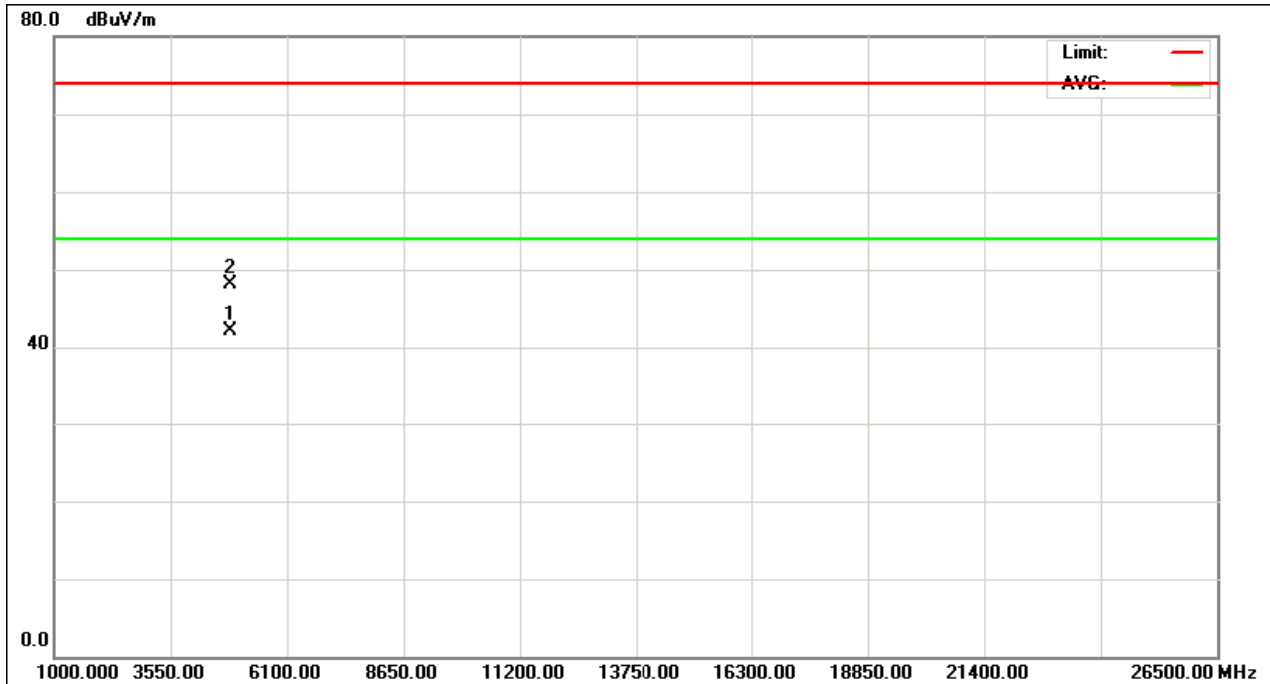
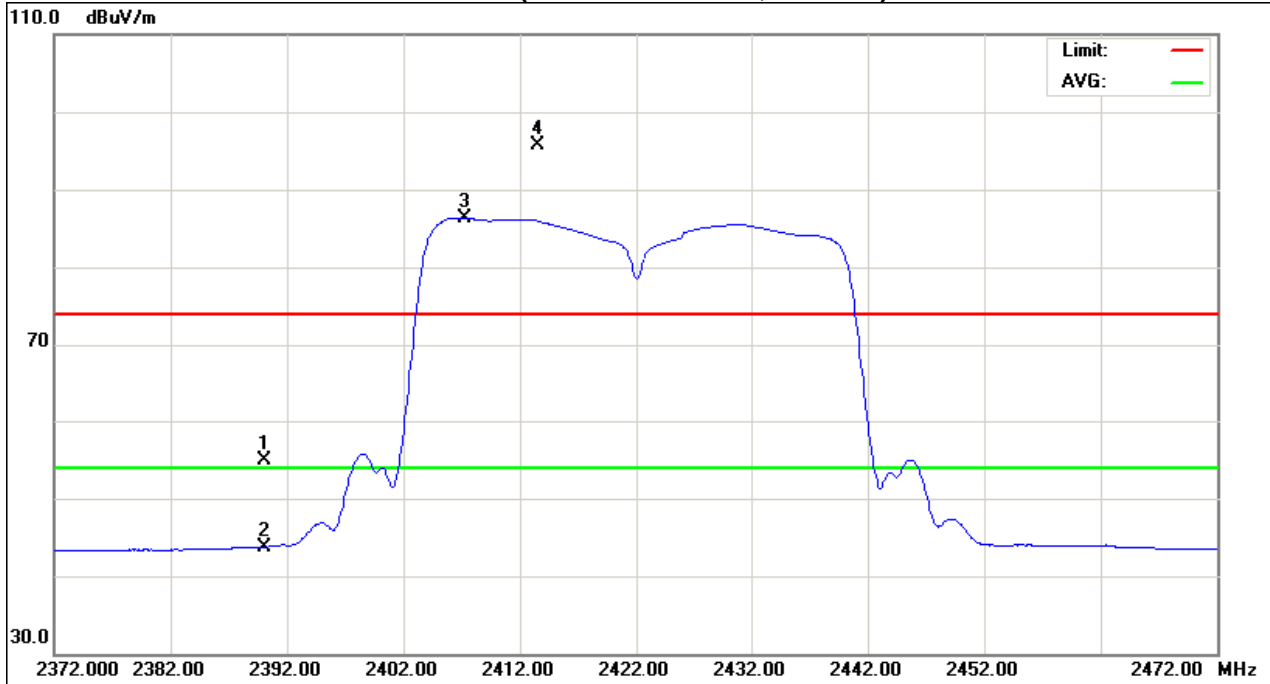



|               |                                |                     |              |
|---------------|--------------------------------|---------------------|--------------|
| EUT :         | 300Mbps Wireless-N USB Adapter | Model Name :        | WF-2109      |
| Temperature : | 25 °C                          | Relative Humidity : | 51 %         |
| Pressure :    | 1010 hPa                       | Test Voltage :      | AC 120V/60Hz |
| Test Mode :   | TX N-40M MODE 2422MHZ          |                     |              |

| Freq.          | Ant.Pol. | Reading      |              | Ant./CF      | Act.          |              | Limit    |          | Note       |
|----------------|----------|--------------|--------------|--------------|---------------|--------------|----------|----------|------------|
|                |          | Peak         | AV           |              | Peak          | AV           | Peak     | AV       |            |
| (MHz)          | H/V      | (dBuV)       | (dBuV)       | CF(dB)       | (dBuV/m)      | (dBuV/m)     | (dBuV/m) | (dBuV/m) |            |
| 2390.00        | H        | 26.03        | 13.09        | 31.54        | 57.57         | 44.63        | 74.00    | 54.00    | X/E        |
| <b>2430.16</b> | <b>H</b> | <b>69.06</b> | <b>58.39</b> | <b>31.61</b> | <b>100.67</b> | <b>90.00</b> |          |          | <b>X/F</b> |
| 4843.97        | H        | 38.96        | 31.66        | 6.06         | 45.02         | 37.72        | 74.00    | 54.00    | X/H        |

Remark :

- (1) All readings are Peak unless otherwise stated QP in column of 『Note』 . Peak denotes that the Peak reading compliance with the QP Limits and then QP Mode measurement didn't perform ◦
- (2) Measuring frequency range from 30MHz to 1000MHz or the 10th harmonic of highest fundamental frequency ◦ "F" denotes fundamental frequency; "H" denotes spurious frequency. "E" denotes band edge frequency. (This judgment method includes the Band Edge Requirement.)
- (3) Radiated emissions measured in frequency range above 1000MHz were made with an instrument using Peak detector mode and AV detector mode of the emission ◦
- (4) Data of measurement within this frequency range shown " \* " in the table above means the reading of emissions are attenuated more than 20dB below the permissible limits or the field strength is too small to be measured.
- (5) A preamp and high pass filter were used for this test in order to provide sufficient measurement sensitivity.
- (6) EUT Orthogonal Axis :  
 "X" - denotes Laid on Table ; "Y" - denotes Vertical Stand ; "Z" - denotes Side Stand
- (7) During the measurements above 1 GHz it is taken care of that the EUT is always within the 3 dB cone of radiation BW of the used antenna



TX CH03 (Above 1000 MHz, Horizontal)

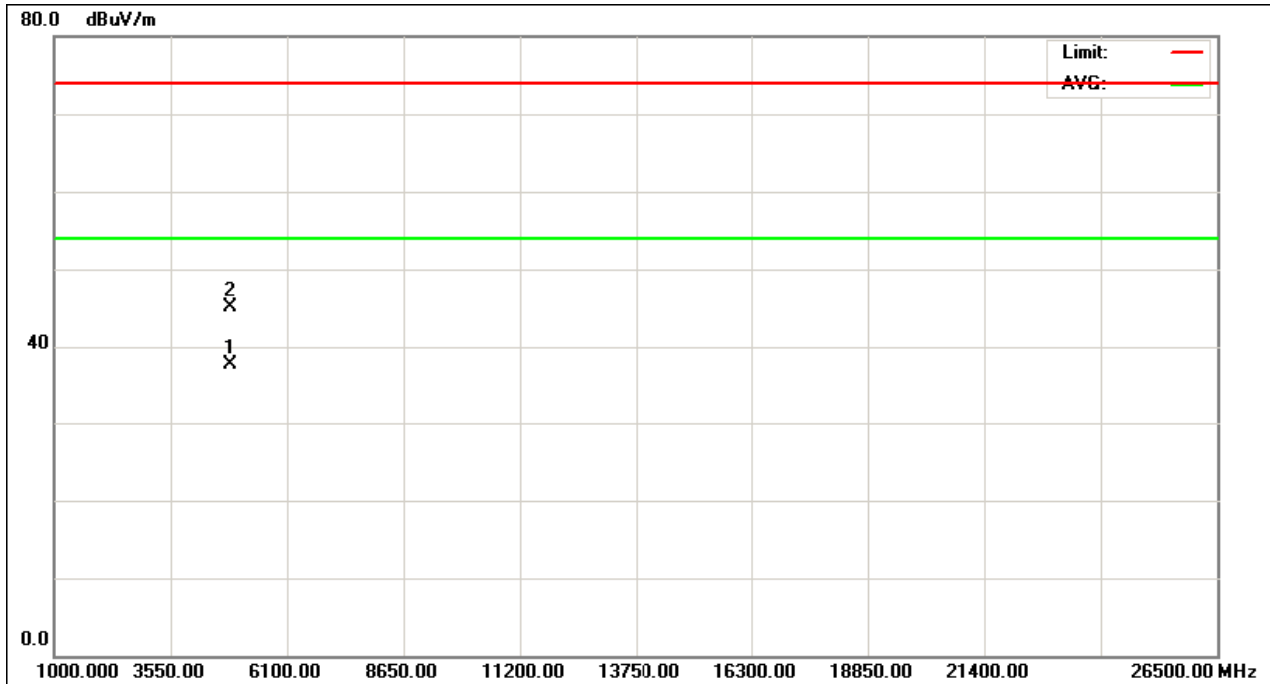
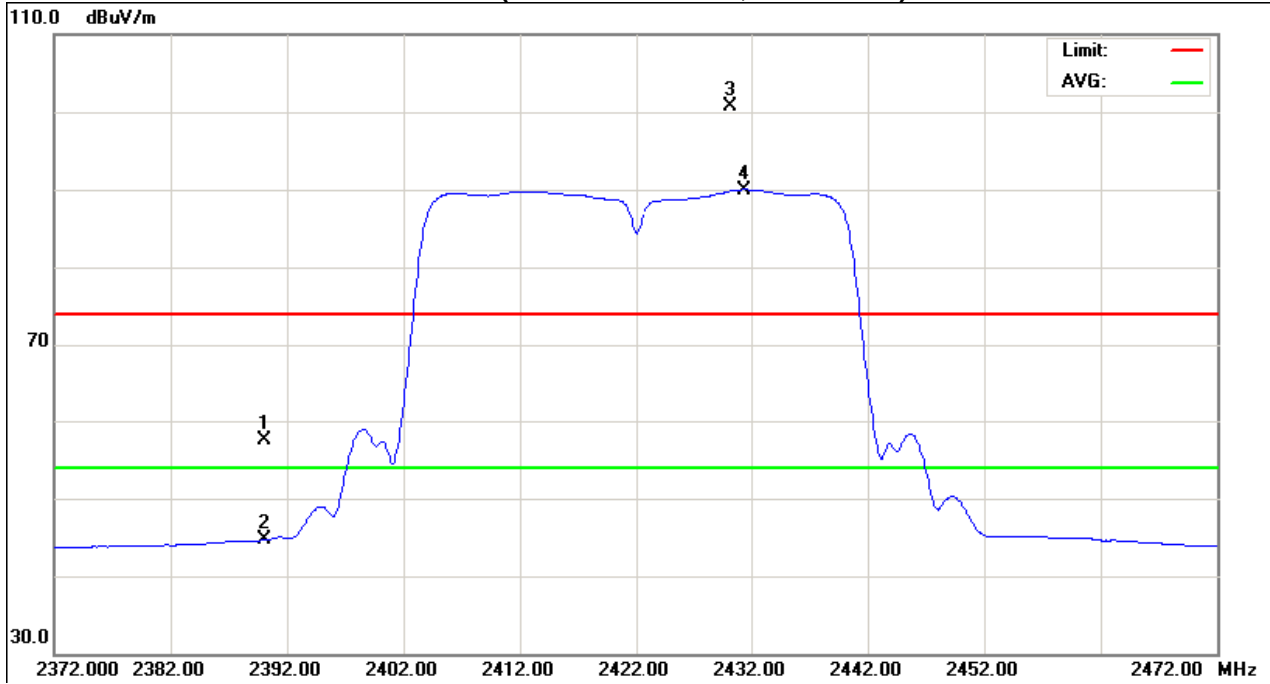





|               |                                |                     |              |
|---------------|--------------------------------|---------------------|--------------|
| EUT :         | 300Mbps Wireless-N USB Adapter | Model Name :        | WF-2109      |
| Temperature : | 25 °C                          | Relative Humidity : | 51 %         |
| Pressure :    | 1010 hPa                       | Test Voltage :      | AC 120V/60Hz |
| Test Mode :   | TX N-40M MODE 2437MHz          |                     |              |

| Freq.<br>(MHz) | Ant.Pol.<br>H/V | Reading        |              | Ant./CF<br>CF(dB) | Act              |                | Limit            |                | Note       |
|----------------|-----------------|----------------|--------------|-------------------|------------------|----------------|------------------|----------------|------------|
|                |                 | Peak<br>(dBuV) | AV<br>(dBuV) |                   | Peak<br>(dBuV/m) | AV<br>(dBuV/m) | Peak<br>(dBuV/m) | AV<br>(dBuV/m) |            |
| <b>2428.30</b> | <b>V</b>        | <b>59.78</b>   | <b>50.94</b> | <b>31.61</b>      | <b>91.39</b>     | <b>82.55</b>   |                  |                | <b>X/F</b> |
| 4874.02        | V               | 42.68          | 33.26        | 6.15              | 48.83            | 39.41          | 74.00            | 54.00          | X/H        |

Remark :

- (1) All readings are Peak unless otherwise stated QP in column of 『Note』 . Peak denotes that the Peak reading compliance with the QP Limits and then QP Mode measurement didn't perform ◦
- (2) Measuring frequency range from 30MHz to 1000MHz or the 10th harmonic of highest fundamental frequency ◦ "F" denotes fundamental frequency; "H" denotes spurious frequency. "E" denotes band edge frequency. (This judgment method includes the Band Edge Requirement.)
- (3) Radiated emissions measured in frequency range above 1000MHz were made with an instrument using Peak detector mode and AV detector mode of the emission ◦
- (4) Data of measurement within this frequency range shown " \* " in the table above means the reading of emissions are attenuated more than 20dB below the permissible limits or the field strength is too small to be measured.
- (5) A preamp and high pass filter were used for this test in order to provide sufficient measurement sensitivity.
- (6) EUT Orthogonal Axis :  
"X" - denotes Laid on Table ; "Y" - denotes Vertical Stand ; "Z" - denotes Side Stand
- (7) During the measurements above 1 GHz it is taken care of that the EUT is always within the 3 dB cone of radiation BW of the used antenna



TX CH06 (Above 1000 MHz, Vertical)

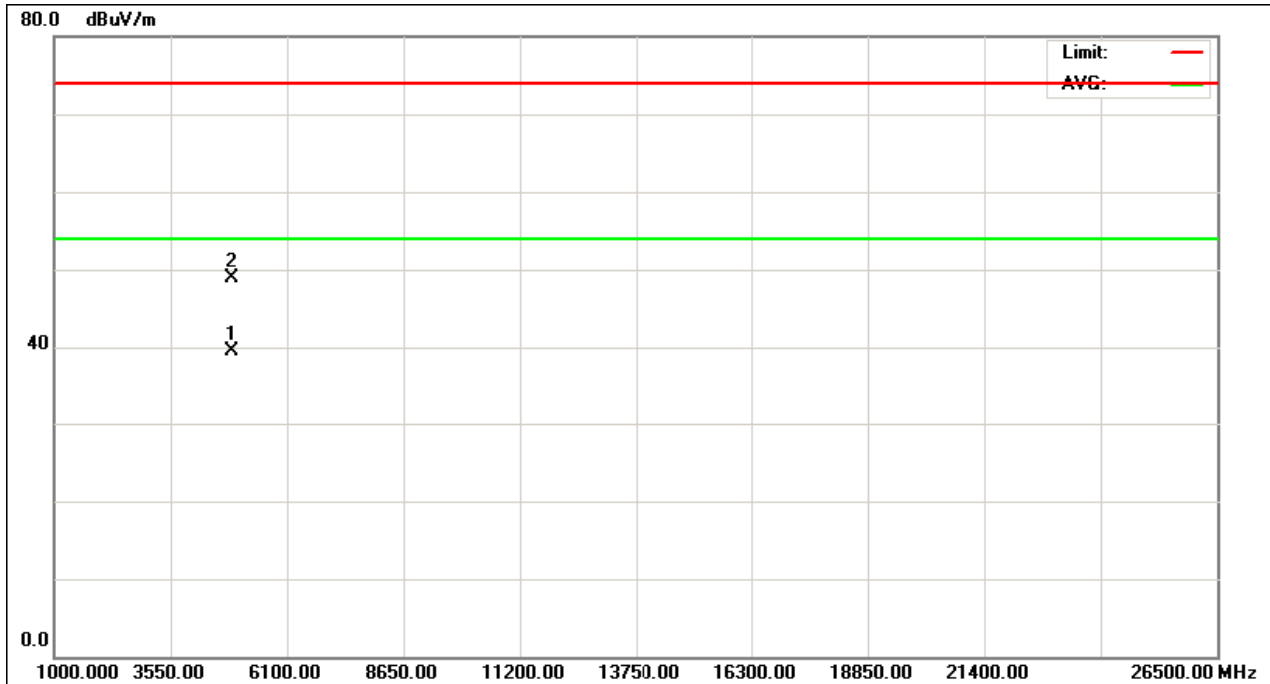
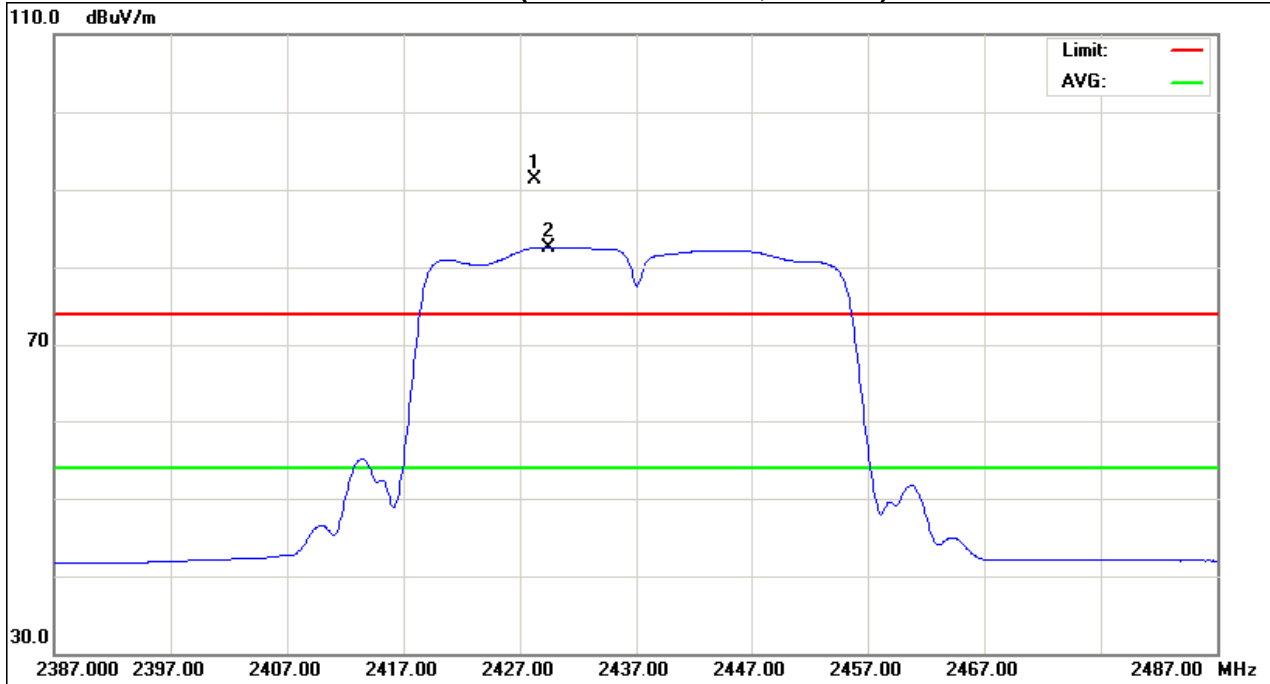



|               |                                |                     |              |
|---------------|--------------------------------|---------------------|--------------|
| EUT :         | 300Mbps Wireless-N USB Adapter | Model Name :        | WF-2109      |
| Temperature : | 25 °C                          | Relative Humidity : | 51 %         |
| Pressure :    | 1010 hPa                       | Test Voltage :      | AC 120V/60Hz |
| Test Mode :   | TX N-40M MODE 2437MHz          |                     |              |

| Freq.          | Ant.Pol. | Reading      |              | Ant./CF      | Act.         |              | Limit    |          | Note       |
|----------------|----------|--------------|--------------|--------------|--------------|--------------|----------|----------|------------|
|                |          | Peak         | AV           |              | Peak         | AV           | Peak     | AV       |            |
| (MHz)          | H/V      | (dBuV)       | (dBuV)       | CF(dB)       | (dBuV/m)     | (dBuV/m)     | (dBuV/m) | (dBuV/m) |            |
| <b>2432.72</b> | <b>H</b> | <b>65.80</b> | <b>56.76</b> | <b>31.61</b> | <b>97.41</b> | <b>88.37</b> |          |          | <b>X/F</b> |
| 4874.16        | H        | 37.80        | 31.12        | 6.15         | 43.95        | 37.27        | 74.00    | 54.00    | X/H        |

Remark :

- (1) All readings are Peak unless otherwise stated QP in column of 『Note』 . Peak denotes that the Peak reading compliance with the QP Limits and then QP Mode measurement didn't perform ◦
- (2) Measuring frequency range from 30MHz to 1000MHz or the 10th harmonic of highest fundamental frequency ◦ "F" denotes fundamental frequency; "H" denotes spurious frequency. "E" denotes band edge frequency. (This judgment method includes the Band Edge Requirement.)
- (3) Radiated emissions measured in frequency range above 1000MHz were made with an instrument using Peak detector mode and AV detector mode of the emission ◦
- (4) Data of measurement within this frequency range shown " \* " in the table above means the reading of emissions are attenuated more than 20dB below the permissible limits or the field strength is too small to be measured.
- (5) A preamp and high pass filter were used for this test in order to provide sufficient measurement sensitivity.
- (6) EUT Orthogonal Axis :  
"X" - denotes Laid on Table ; "Y" - denotes Vertical Stand ; "Z" - denotes Side Stand
- (7) During the measurements above 1 GHz it is taken care of that the EUT is always within the 3 dB cone of radiation BW of the used antenna



TX CH06 (Above 1000 MHz, Horizontal)

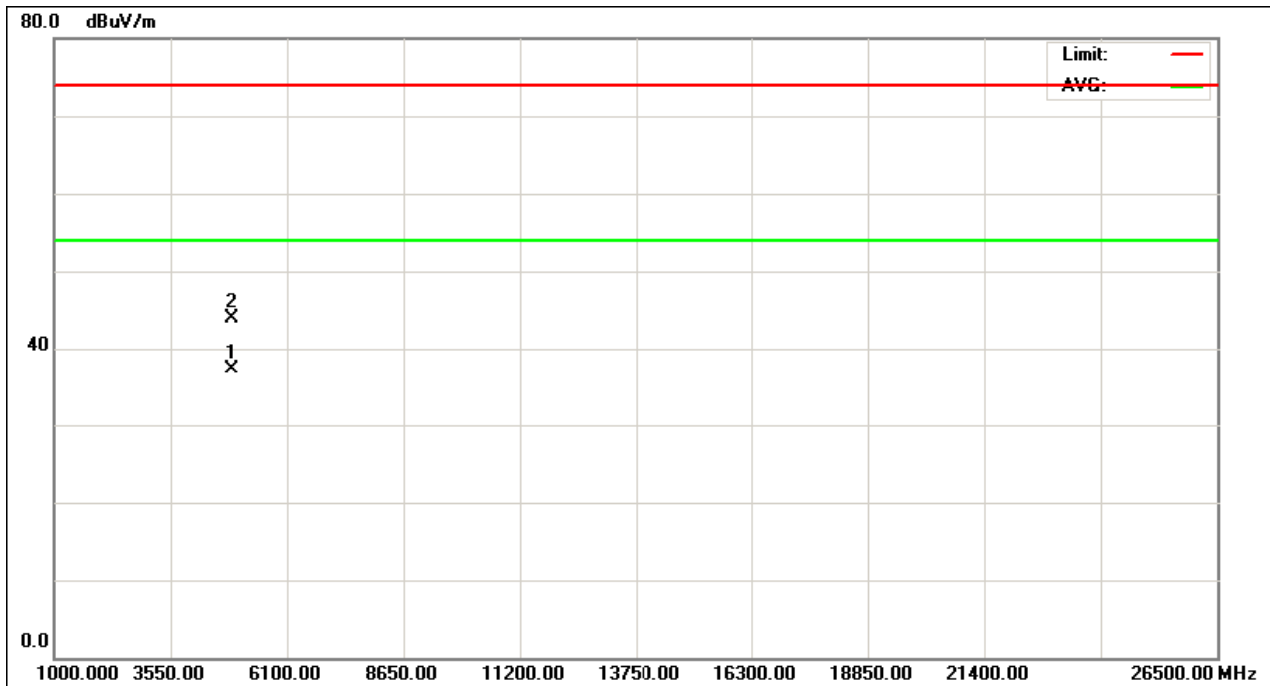
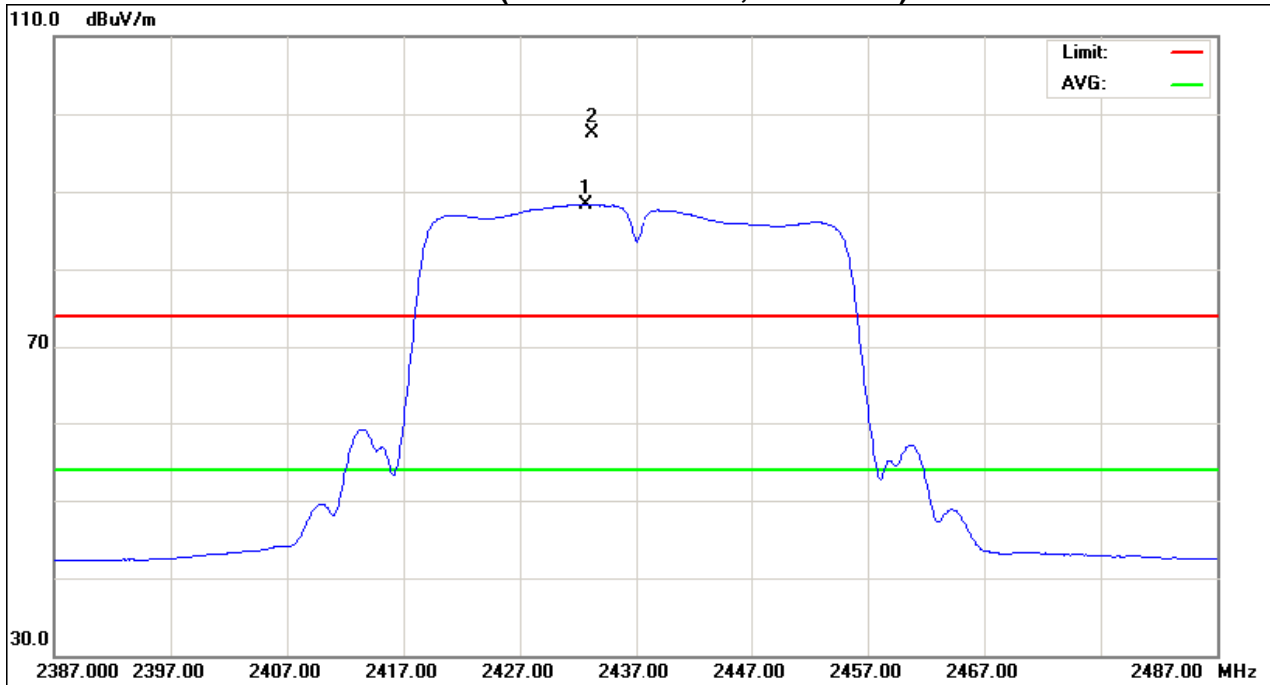



|               |                                |                     |              |
|---------------|--------------------------------|---------------------|--------------|
| EUT :         | 300Mbps Wireless-N USB Adapter | Model Name :        | WF-2109      |
| Temperature : | 25 °C                          | Relative Humidity : | 51 %         |
| Pressure :    | 1010 hPa                       | Test Voltage :      | AC 120V/60Hz |
| Test Mode :   | TX N-40M MODE 2452MHz          |                     |              |

| Freq.          | Ant.Pol. | Reading      |              | Ant./CF      | Act.         |              | Limit    |          | Note       |
|----------------|----------|--------------|--------------|--------------|--------------|--------------|----------|----------|------------|
|                |          | Peak         | AV           |              | Peak         | AV           | Peak     | AV       |            |
| (MHz)          | H/V      | (dBuV)       | (dBuV)       | CF(dB)       | (dBuV/m)     | (dBuV/m)     | (dBuV/m) | (dBuV/m) |            |
| <b>2442.75</b> | <b>V</b> | <b>60.76</b> | <b>51.57</b> | <b>31.63</b> | <b>92.39</b> | <b>83.20</b> |          |          | <b>X/F</b> |
| 2483.50        | V        | 22.23        | 11.72        | 31.70        | 53.93        | 43.42        | 74.00    | 54.00    | X/E        |
| 4904.03        | V        | 41.40        | 32.83        | 6.23         | 47.63        | 39.06        | 74.00    | 54.00    | X/H        |

Remark :

- (1) All readings are Peak unless otherwise stated QP in column of 『Note』 . Peak denotes that the Peak reading compliance with the QP Limits and then QP Mode measurement didn't perform ◦
- (2) Measuring frequency range from 30MHz to 1000MHz or the 10th harmonic of highest fundamental frequency ◦ "F" denotes fundamental frequency; "H" denotes spurious frequency. "E" denotes band edge frequency. (This judgment method includes the Band Edge Requirement.)
- (3) Radiated emissions measured in frequency range above 1000MHz were made with an instrument using Peak detector mode and AV detector mode of the emission ◦
- (4) Data of measurement within this frequency range shown " \* " in the table above means the reading of emissions are attenuated more than 20dB below the permissible limits or the field strength is too small to be measured.
- (5) A preamp and high pass filter were used for this test in order to provide sufficient measurement sensitivity.
- (6) EUT Orthogonal Axis :  
 "X" - denotes Laid on Table ; "Y" - denotes Vertical Stand ; "Z" - denotes Side Stand
- (7) During the measurements above 1 GHz it is taken care of that the EUT is always within the 3 dB cone of radiation BW of the used antenna



TX CH09 (Above 1000 MHz, Vertical)

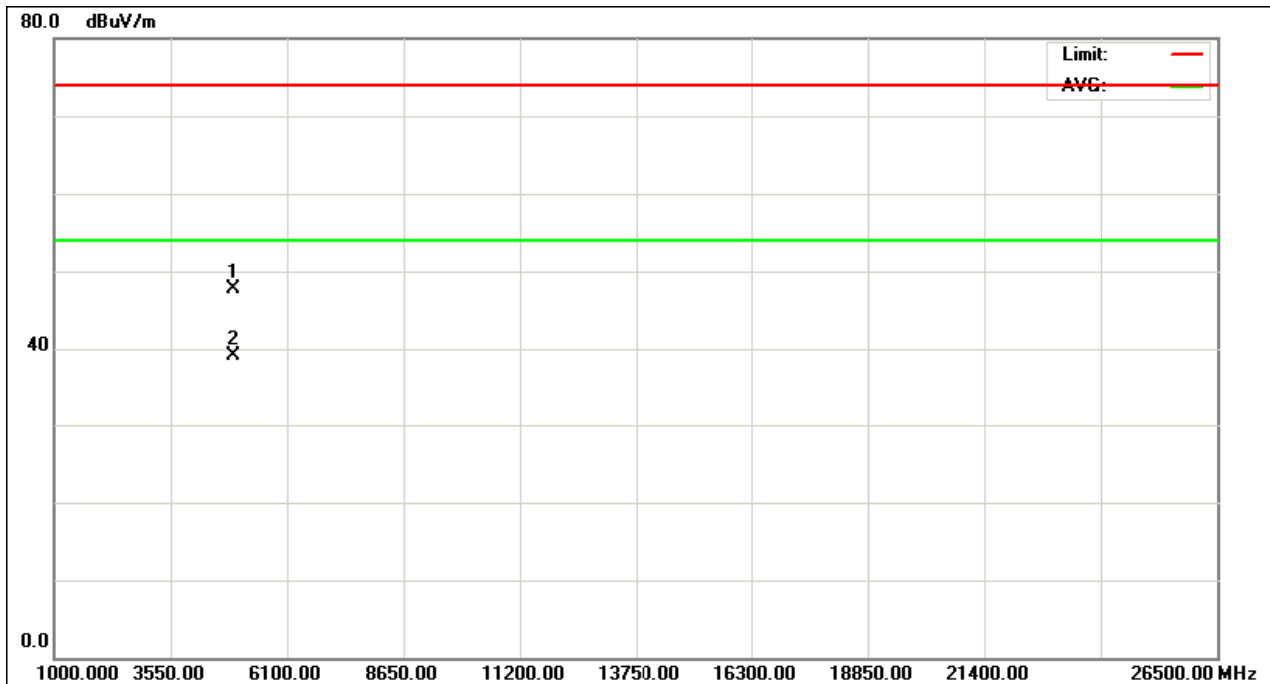
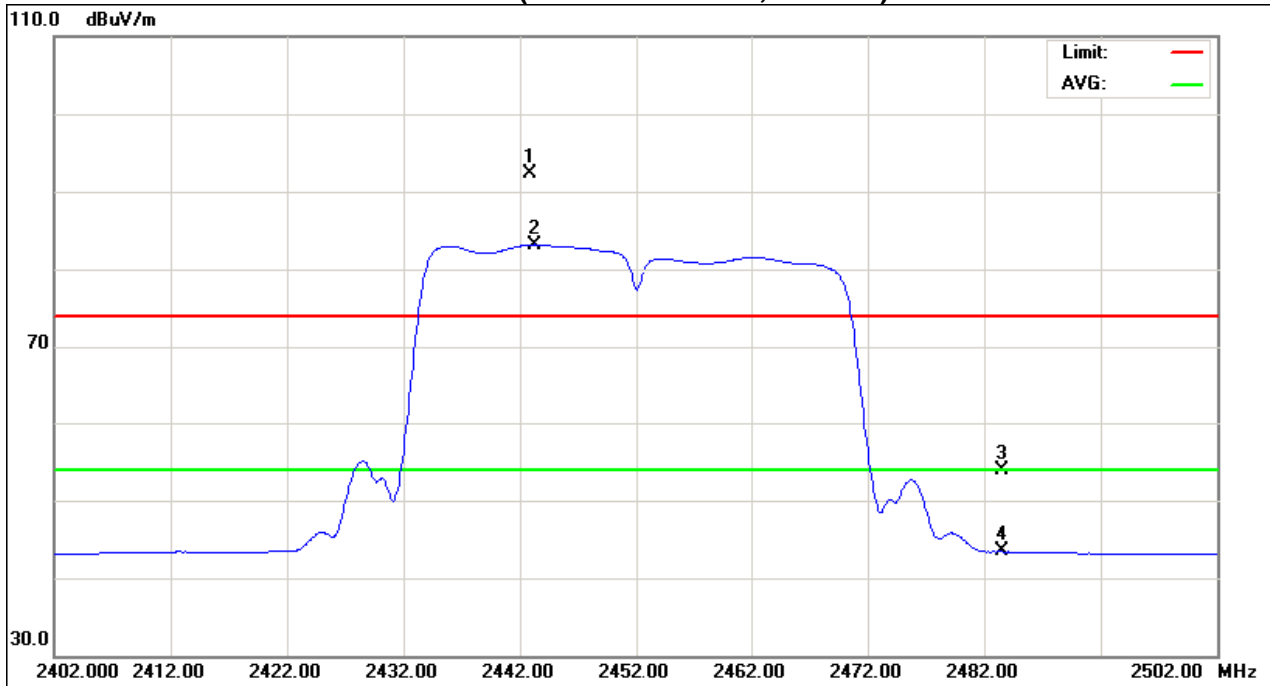



|               |                                |                     |              |
|---------------|--------------------------------|---------------------|--------------|
| EUT :         | 300Mbps Wireless-N USB Adapter | Model Name :        | WF-2109      |
| Temperature : | 25 °C                          | Relative Humidity : | 51 %         |
| Pressure :    | 1010 hPa                       | Test Voltage :      | AC 120V/60Hz |
| Test Mode :   | TX N-40M MODE 2452MHz          |                     |              |

| Freq.          | Ant.Pol. | Reading      |              | Ant./CF      | Act.         |              | Limit    |          | Note       |
|----------------|----------|--------------|--------------|--------------|--------------|--------------|----------|----------|------------|
|                |          | Peak         | AV           |              | Peak         | AV           | Peak     | AV       |            |
| (MHz)          | H/V      | (dBuV)       | (dBuV)       | CF(dB)       | (dBuV/m)     | (dBuV/m)     | (dBuV/m) | (dBuV/m) |            |
| <b>2437.20</b> | <b>H</b> | <b>66.28</b> | <b>57.07</b> | <b>31.62</b> | <b>97.90</b> | <b>88.69</b> |          |          | <b>X/F</b> |
| 2483.50        | H        | 23.51        | 12.40        | 31.70        | 55.21        | 44.10        | 74.00    | 54.00    | X/E        |
| 4903.96        | H        | 38.79        | 31.57        | 6.23         | 45.02        | 37.80        | 74.00    | 54.00    | X/H        |

Remark :

- (1) All readings are Peak unless otherwise stated QP in column of 『Note』 . Peak denotes that the Peak reading compliance with the QP Limits and then QP Mode measurement didn't perform ◦
- (2) Measuring frequency range from 30MHz to 1000MHz or the 10th harmonic of highest fundamental frequency ◦ "F" denotes fundamental frequency; "H" denotes spurious frequency. "E" denotes band edge frequency. (This judgment method includes the Band Edge Requirement.)
- (3) Radiated emissions measured in frequency range above 1000MHz were made with an instrument using Peak detector mode and AV detector mode of the emission ◦
- (4) Data of measurement within this frequency range shown " \* " in the table above means the reading of emissions are attenuated more than 20dB below the permissible limits or the field strength is too small to be measured.
- (5) A preamp and high pass filter were used for this test in order to provide sufficient measurement sensitivity.
- (6) EUT Orthogonal Axis :  
 "X" - denotes Laid on Table ; "Y" - denotes Vertical Stand ; "Z" - denotes Side Stand
- (7) During the measurements above 1 GHz it is taken care of that the EUT is always within the 3 dB cone of radiation BW of the used antenna



TX CH09 (Above 1000 MHz, Horizontal)

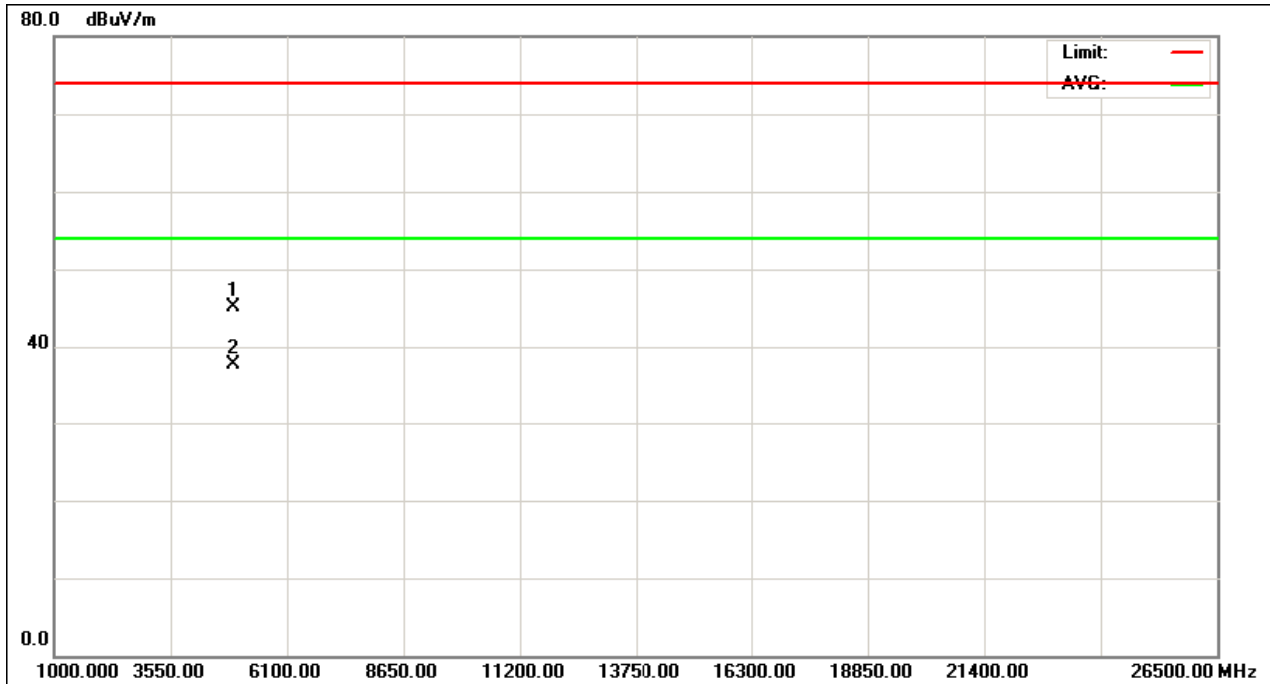
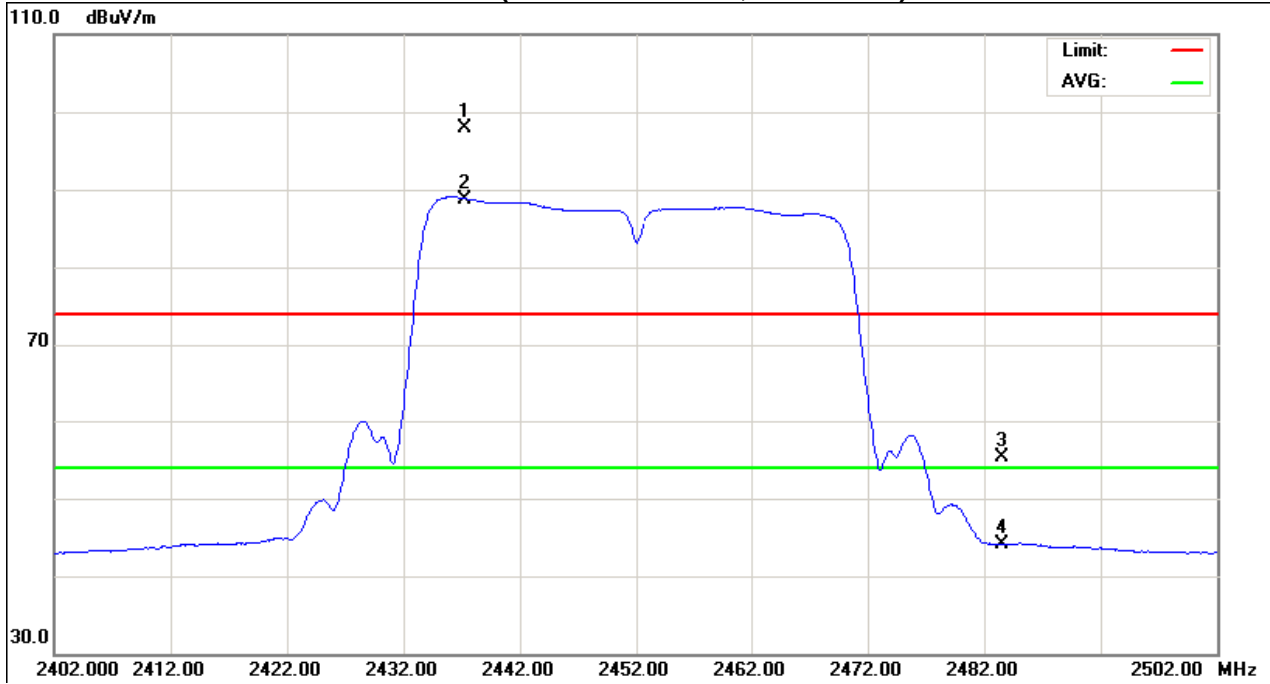





**5. BANDWIDTH TEST**

**5.1 Applied procedures / limit**

| FCC Part15 (15.247) , Subpart C |           |   |                       |        |
|---------------------------------|-----------|---|-----------------------|--------|
| Section                         | Test Item | Limit                                   | Frequency Range (MHz) | Result |
| 15.247(a)(2)                    | Bandwidth | $\geq 500\text{KHz}$<br>(6dB bandwidth) | 2400-2483.5           | PASS   |

**5.1.1 MEASUREMENT INSTRUMENTS LIST**

| Item | Kind of Equipment | Manufacturer | Type No. | Serial No. | Calibrated until |
|------|-------------------|--------------|----------|------------|------------------|
| 1    | Spectrum Analyzer | R&S          | FSP 40   | 100185     | Nov.26.2011      |

Remark: " N/A" denotes No Model Name. , Serial No. or No Calibration specified.

**5.1.2 TEST PROCEDURE**

- a. The EUT was directly connected to the spectrum analyzer and antenna output port as show in the block diagram below,
- b. Spectrum Setting : RBW= 100KHz, VBW=100KHz, Sweep time = 5 ms.

**5.1.3 DEVIATION FROM STANDARD**

No deviation.

**5.1.4 TEST SETUP**

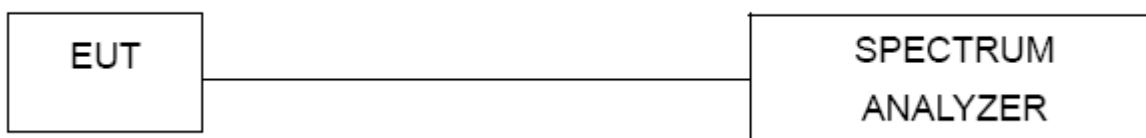

**5.1.5 EUT OPERATION CONDITIONS**

The EUT tested system was configured as the statements of 4.1.6 Unless otherwise a special operating condition is specified in the follows during the testing.



5.1.6 TEST RESULTS

|               |                                |                     |              |
|---------------|--------------------------------|---------------------|--------------|
| EUT :         | 300Mbps Wireless-N USB Adapter | Model Name. :       | WF-2109      |
| Temperature : | 24 °C                          | Relative Humidity : | 60 %         |
| Pressure :    | 1016 hPa                       | Test Voltage :      | AC 120V/60Hz |
| Test Mode :   | TX B MODE /CH01, CH06, CH11    |                     |              |

| Test Channel | Frequency (MHz) | Bandwidth (MHz) | LIMIT (MHz) |
|--------------|-----------------|-----------------|-------------|
| CH01         | 2412            | 10.10           | >=500KHz    |
| CH06         | 2437            | 10.10           | >=500KHz    |
| CH11         | 2462            | 10.10           | >=500KHz    |

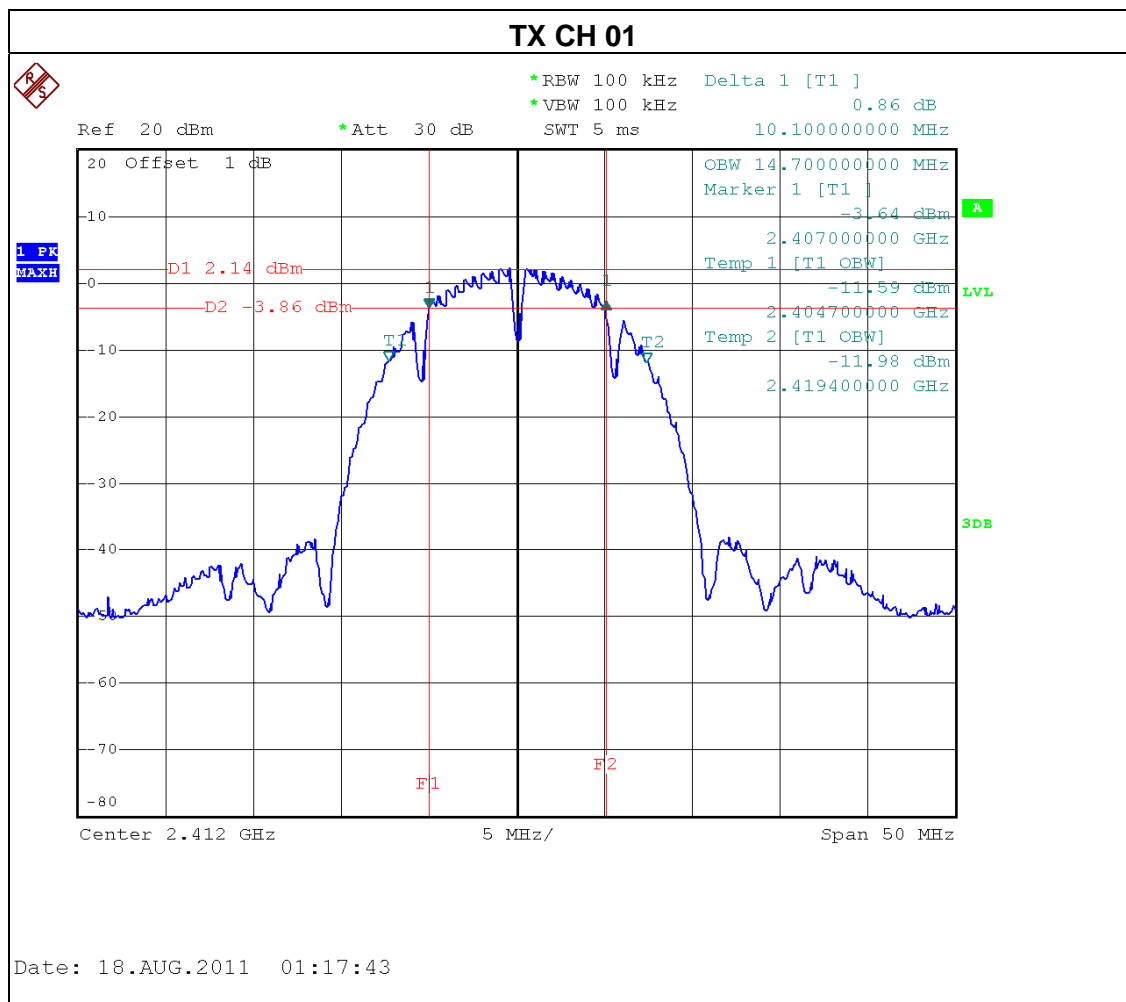

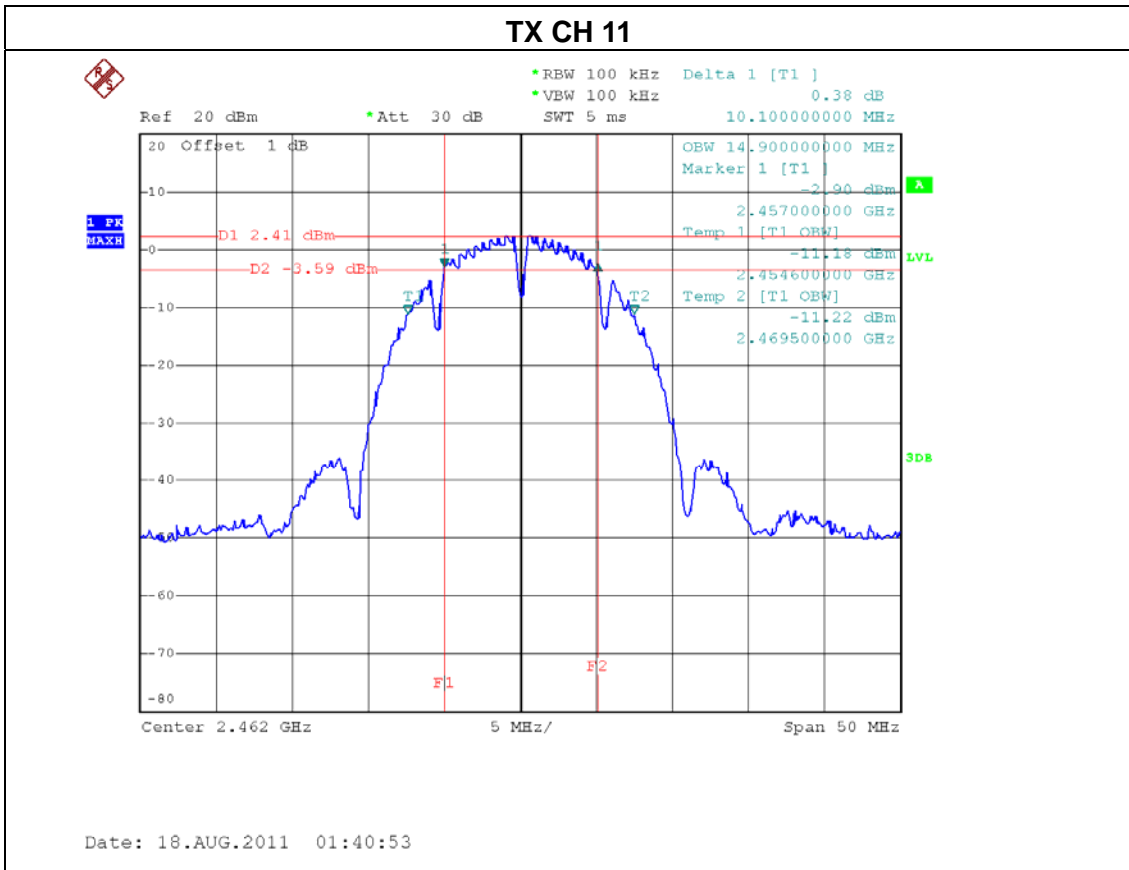
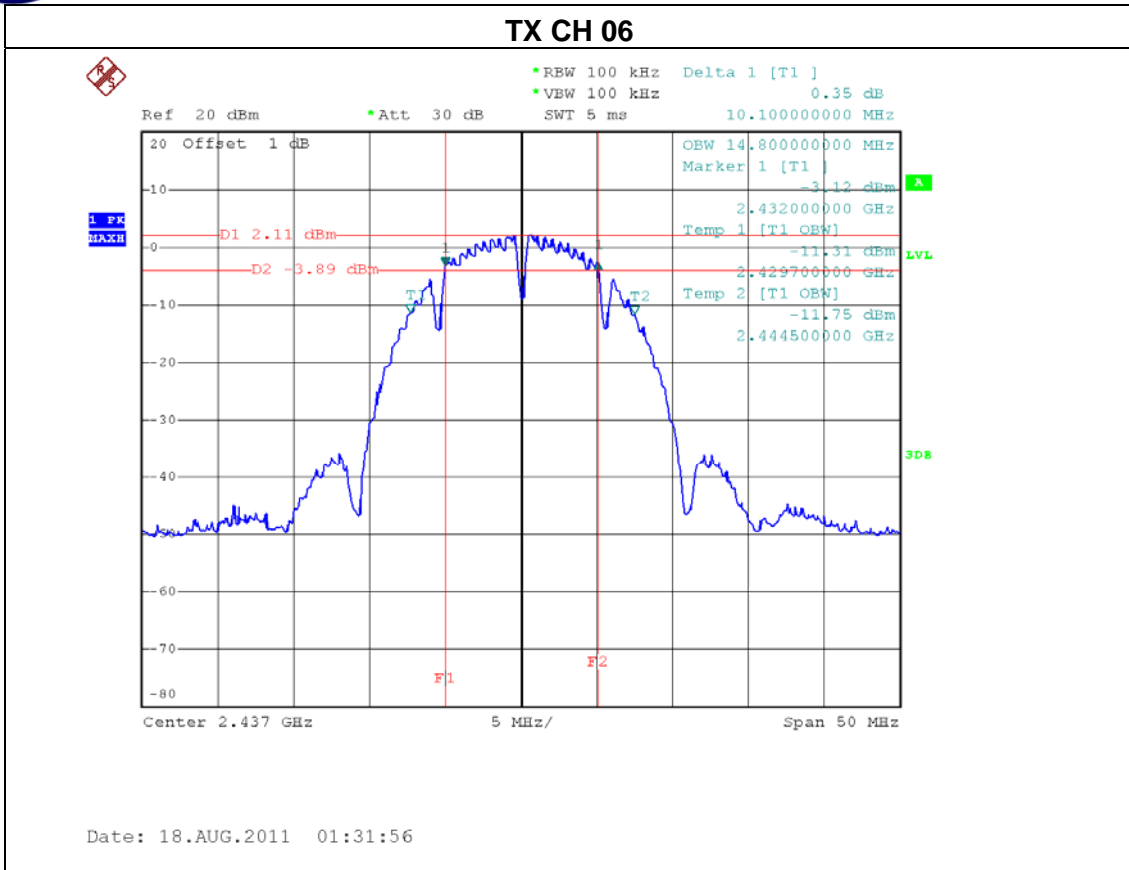



|               |                                |                     |              |
|---------------|--------------------------------|---------------------|--------------|
| EUT :         | 300Mbps Wireless-N USB Adapter | Model Name. :       | WF-2109      |
| Temperature : | 24 °C                          | Relative Humidity : | 60 %         |
| Pressure :    | 1016 hPa                       | Test Voltage :      | AC 120V/60Hz |
| Test Mode :   | TX G MODE /CH01, CH06, CH11    |                     |              |

| Test Channel | Frequency (MHz) | Bandwidth (MHz) | LIMIT (MHz) |
|--------------|-----------------|-----------------|-------------|
| CH01         | 2412            | 16.60           | >=500KHz    |
| CH06         | 2437            | 16.60           | >=500KHz    |
| CH11         | 2462            | 16.90           | >=500KHz    |

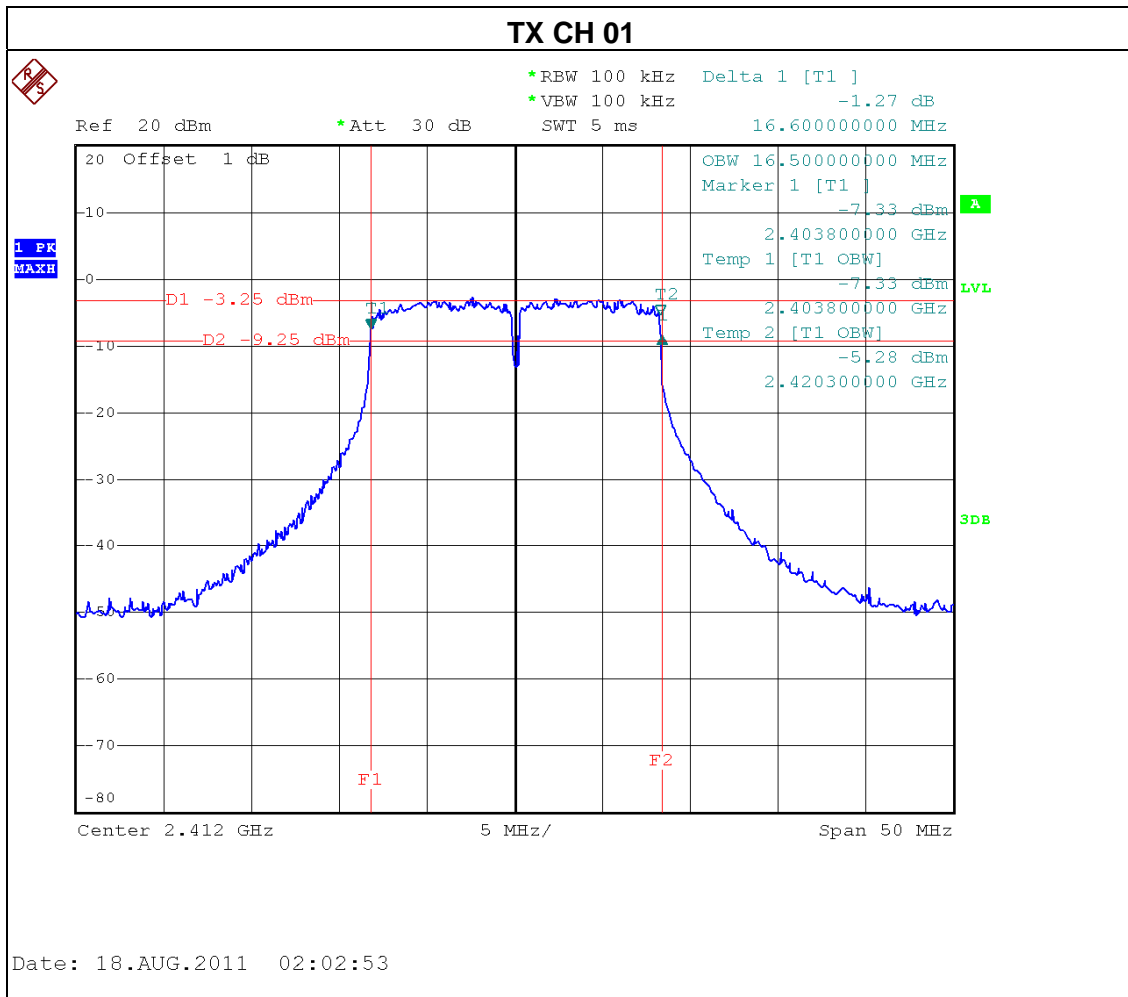

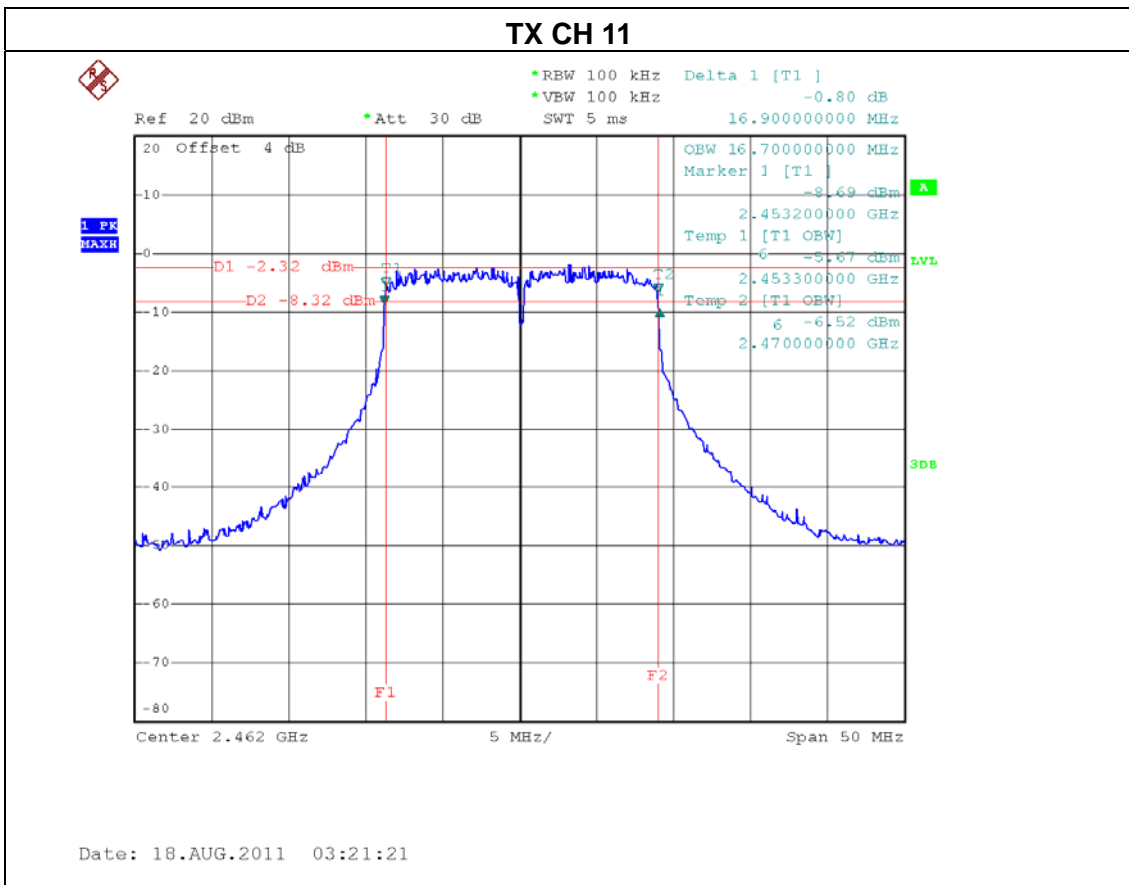
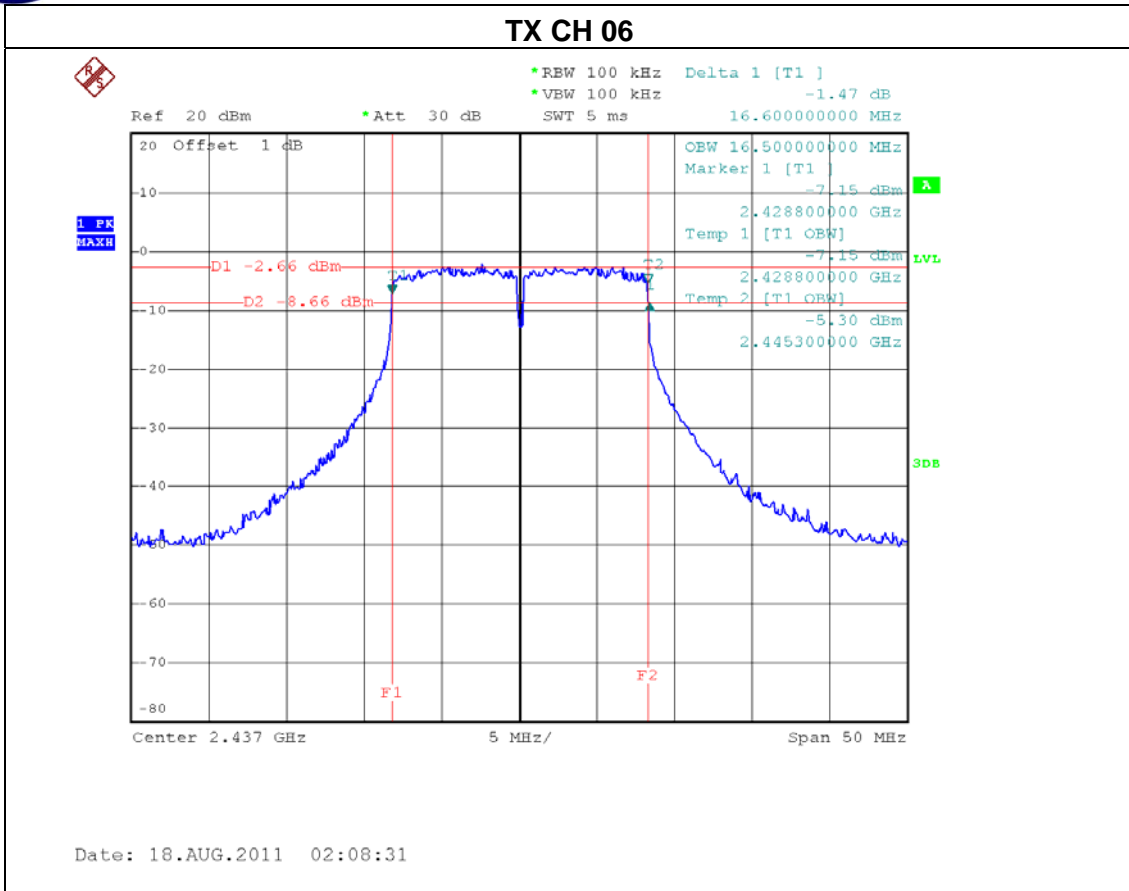



|               |                                    |                     |              |
|---------------|------------------------------------|---------------------|--------------|
| EUT :         | 300Mbps Wireless-N USB Adapter     | Model Name. :       | WF-2109      |
| Temperature : | 24 °C                              | Relative Humidity : | 60 %         |
| Pressure :    | 1016 hPa                           | Test Voltage :      | AC 120V/60Hz |
| Test Mode :   | TX N MODE -20MHz/ CH01, CH06, CH11 |                     |              |

| Test Channel | Frequency (MHz) | Bandwidth (MHz) | LIMIT (MHz) |
|--------------|-----------------|-----------------|-------------|
| CH01         | 2412            | 17.80           | >=500KHz    |
| CH06         | 2437            | 17.60           | >=500KHz    |
| CH11         | 2462            | 17.90           | >=500KHz    |

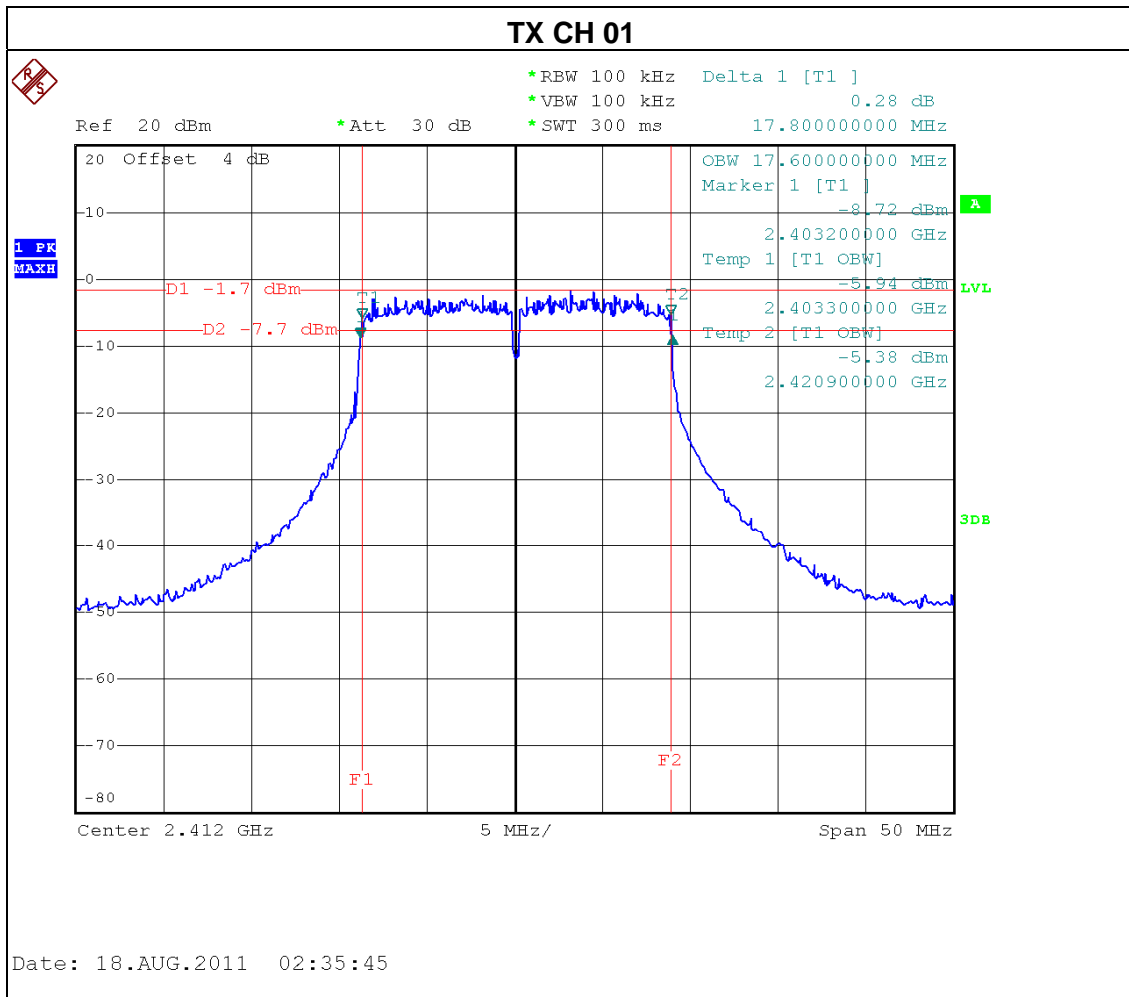

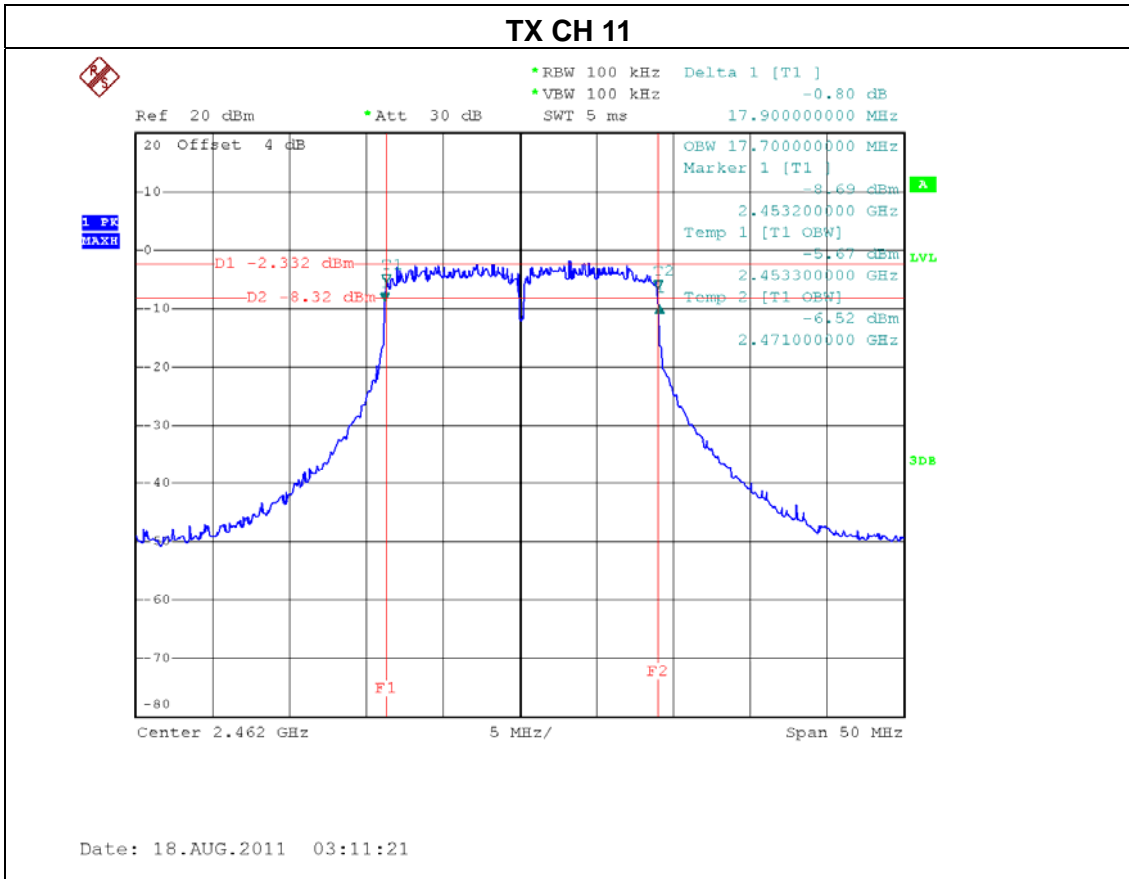
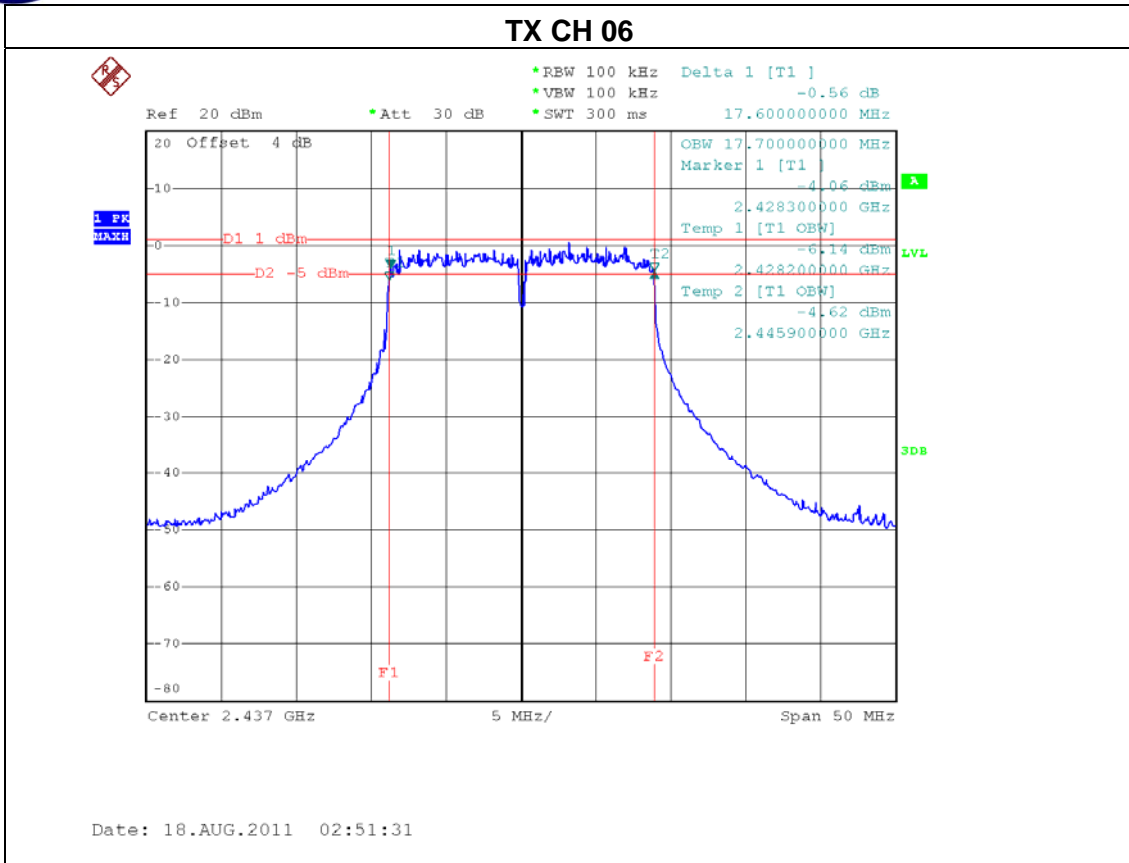



|               |                                    |                     |              |
|---------------|------------------------------------|---------------------|--------------|
| EUT :         | 300Mbps Wireless-N USB Adapter     | Model Name. :       | WF-2109      |
| Temperature : | 24 °C                              | Relative Humidity : | 60 %         |
| Pressure :    | 1016 hPa                           | Test Voltage :      | AC 120V/60Hz |
| Test Mode :   | TX N MODE -40MHz/ CH03, CH06, CH09 |                     |              |

| Test Channel | Frequency (MHz) | Bandwidth (MHz) | LIMIT (MHz) |
|--------------|-----------------|-----------------|-------------|
| CH03         | 2422            | 36.60           | >=500KHz    |
| CH06         | 2437            | 36.60           | >=500KHz    |
| CH09         | 2452            | 36.60           | >=500KHz    |

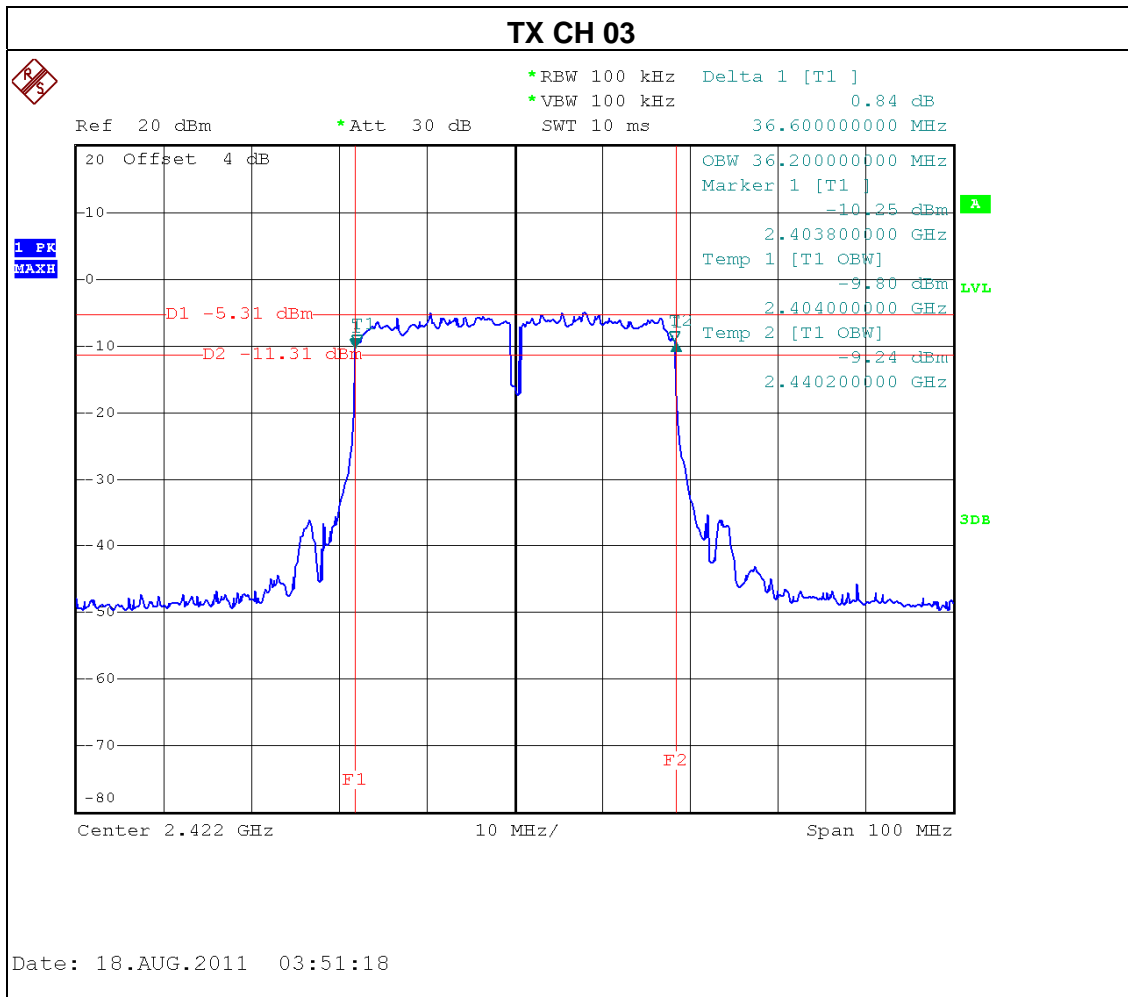



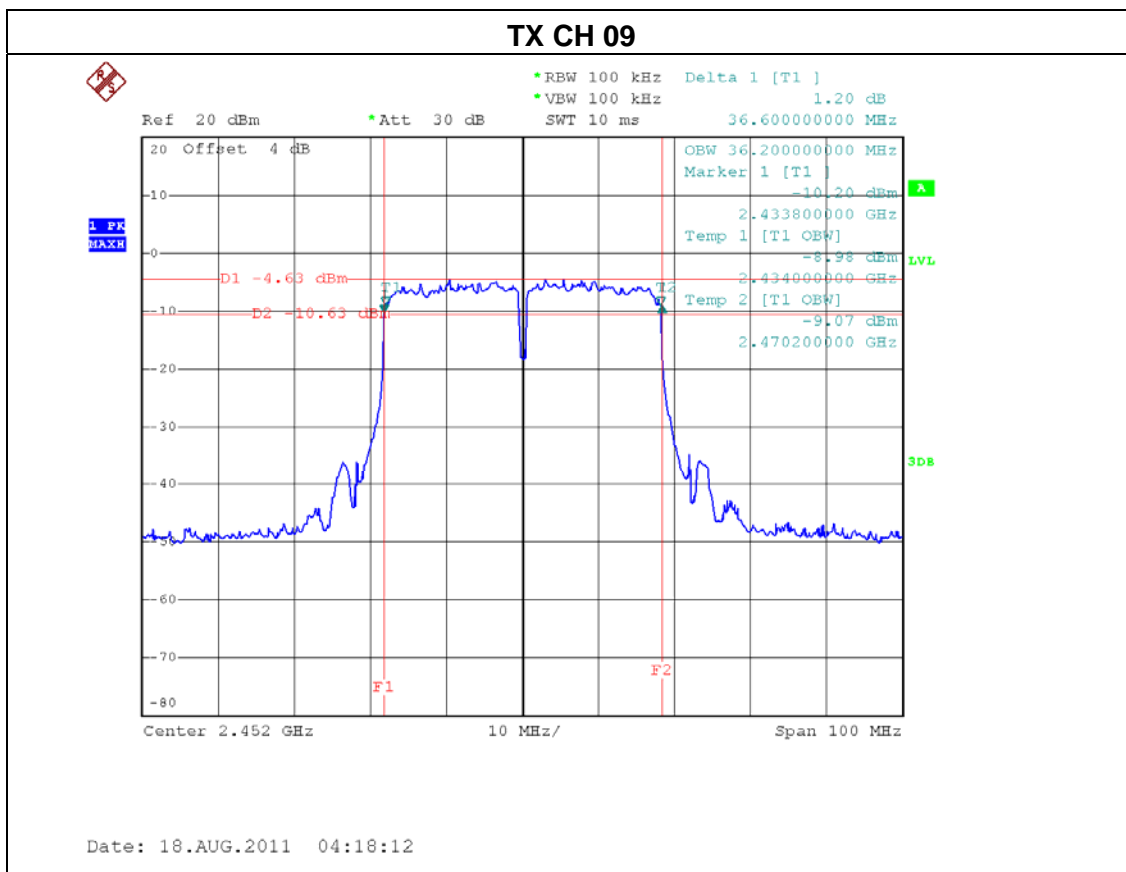
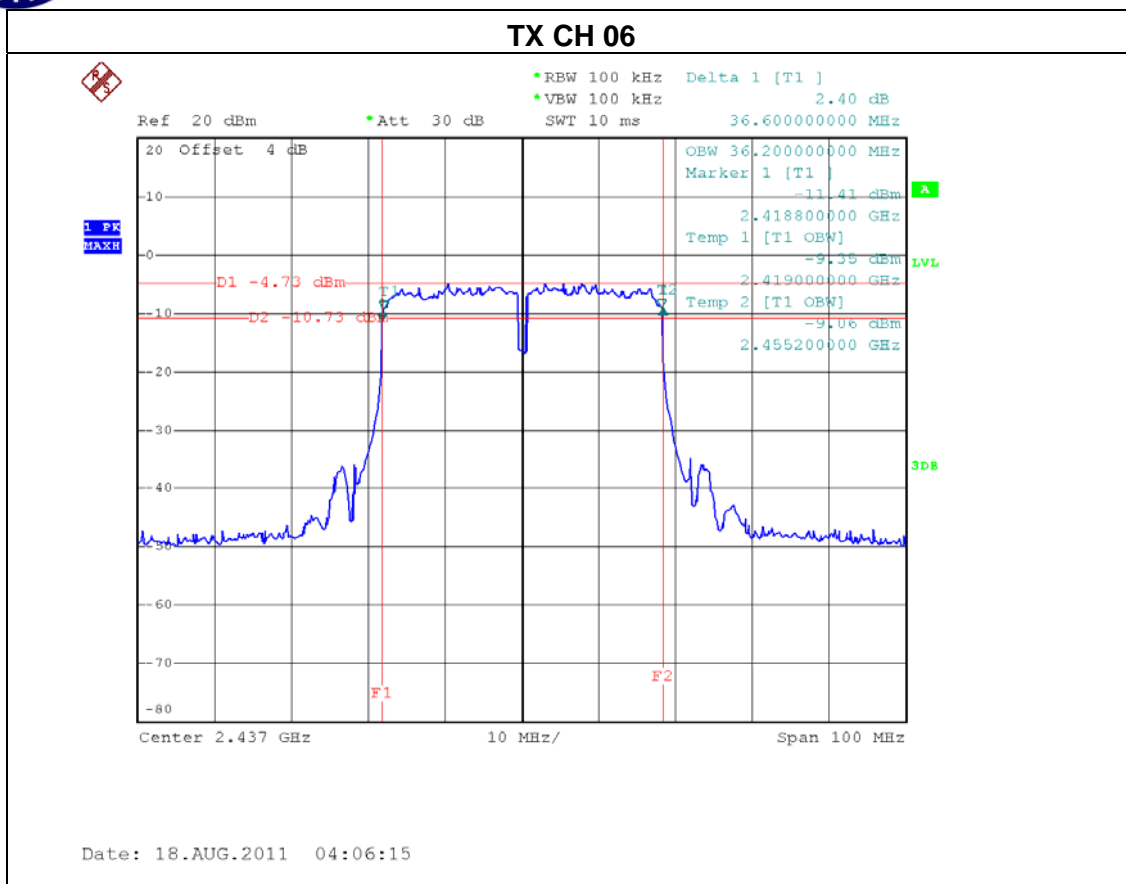



**6. MAXIMUM OUTPUT POWER TEST**

**6.1 Applied procedures / limit**

| FCC Part15 (15.247) , Subpart C |                      |                 |                       |        |
|---------------------------------|----------------------|-----------------|-----------------------|--------|
| Section                         | Test Item            | Limit           | Frequency Range (MHz) | Result |
| 15.247(b)(3)                    | Maximum Output Power | 1 watt or 30dBm | 2400-2483.5           | PASS   |

**6.1.1 MEASUREMENT INSTRUMENTS LIST**

| Item | Kind of Equipment | Manufacturer | Type No. | Serial No. | Calibrated until |
|------|-------------------|--------------|----------|------------|------------------|
| 1    | Spectrum Analyzer | R&S          | FSP 40   | 100185     | Nov.26.2011      |

Remark: " N/A" denotes No Model Name. , Serial No. or No Calibration specified.

**6.1.2 TEST PROCEDURE**

- a. The EUT was directly connected to the spectrum analyzer and antenna output port as show in the block diagram below,
- b. Spectrum Setting : RBW= 1MHz, VBW=3MHz, Sample detector, Sweep time = 5 ms.

**6.1.3 DEVIATION FROM STANDARD**

No deviation.

**6.1.4 TEST SETUP**



**6.1.5 EUT OPERATION CONDITIONS**

The EUT tested system was configured as the statements of 4.1.6 Unless otherwise a special operating condition is specified in the follows during the testing. Transmit output power was measured while the host equipment supply voltage was varied from 85 % to 115 % of the nominal rated supply voltage. No change in transmit output power was observed.



6.1.6 TEST RESULTS

|               |                                |                     |              |
|---------------|--------------------------------|---------------------|--------------|
| EUT :         | 300Mbps Wireless-N USB Adapter | Model Name :        | WF-2109      |
| Temperature : | 24 °C                          | Relative Humidity : | 60 %         |
| Pressure :    | 1016 hPa                       | Test Voltage :      | AC 120V/60Hz |
| Test Mode :   | TX B MODE /CH01, CH06, CH11    |                     |              |

Maximum Output Power

| Test Channel | Frequency (MHz) | Output Power (dBm) | LIMIT (dBm) | LIMIT (W) |
|--------------|-----------------|--------------------|-------------|-----------|
| CH01         | 2412 MHz        | 13.01              | 30          | 1         |
| CH06         | 2437 MHz        | 13.22              | 30          | 1         |
| CH11         | 2462 MHz        | 13.22              | 30          | 1         |

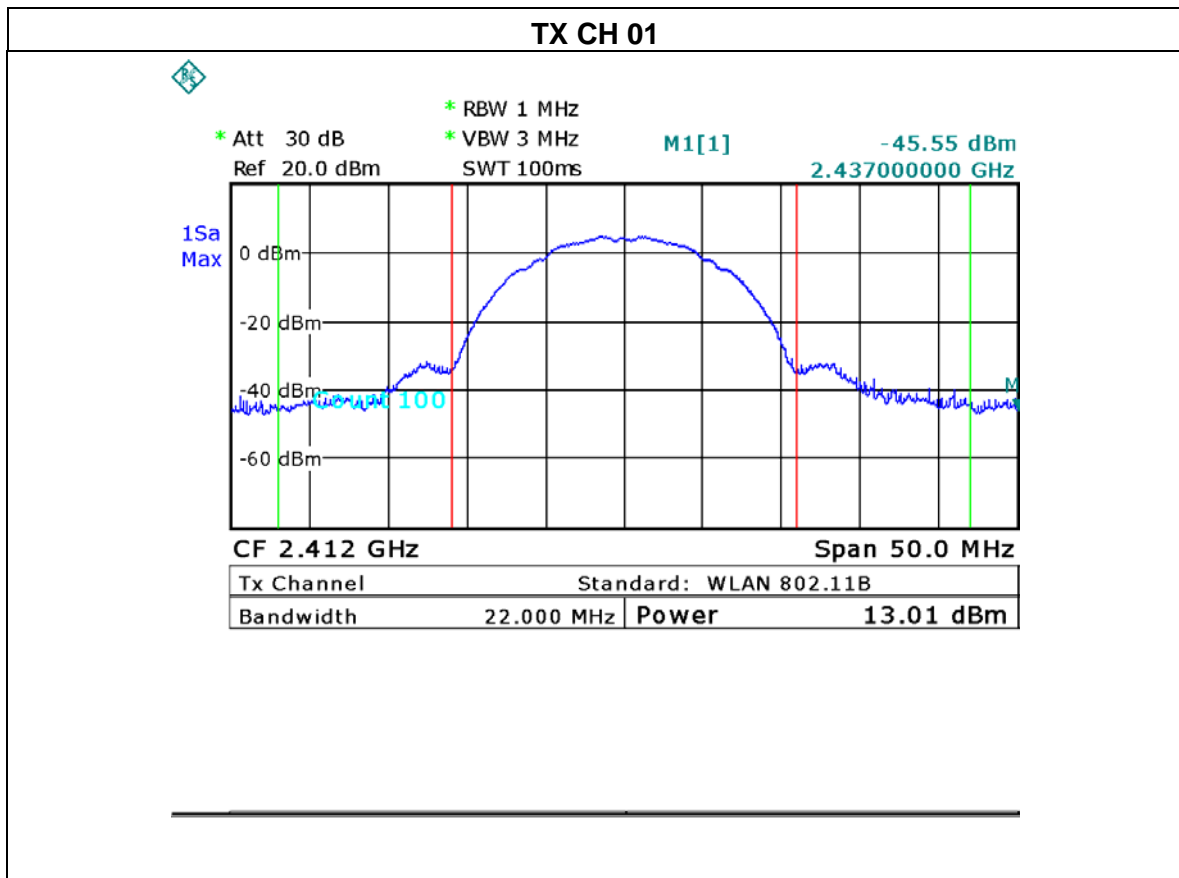

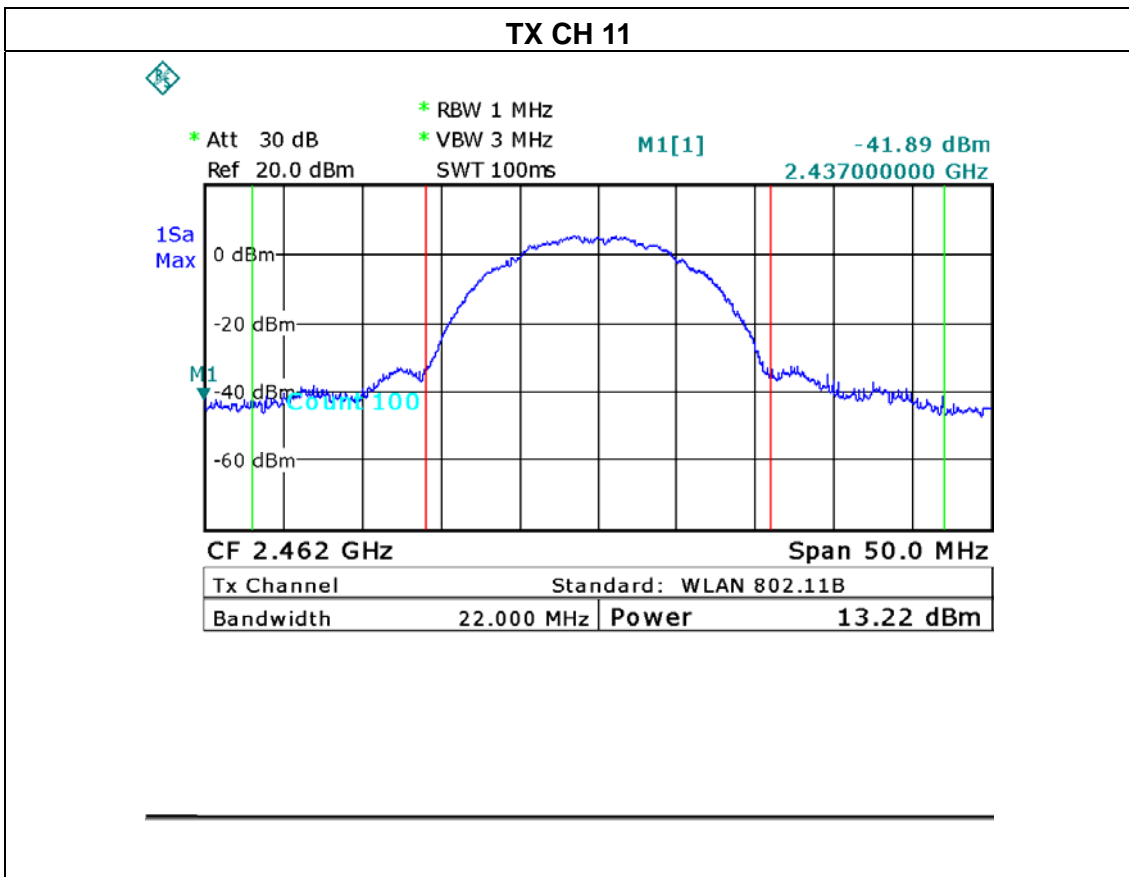
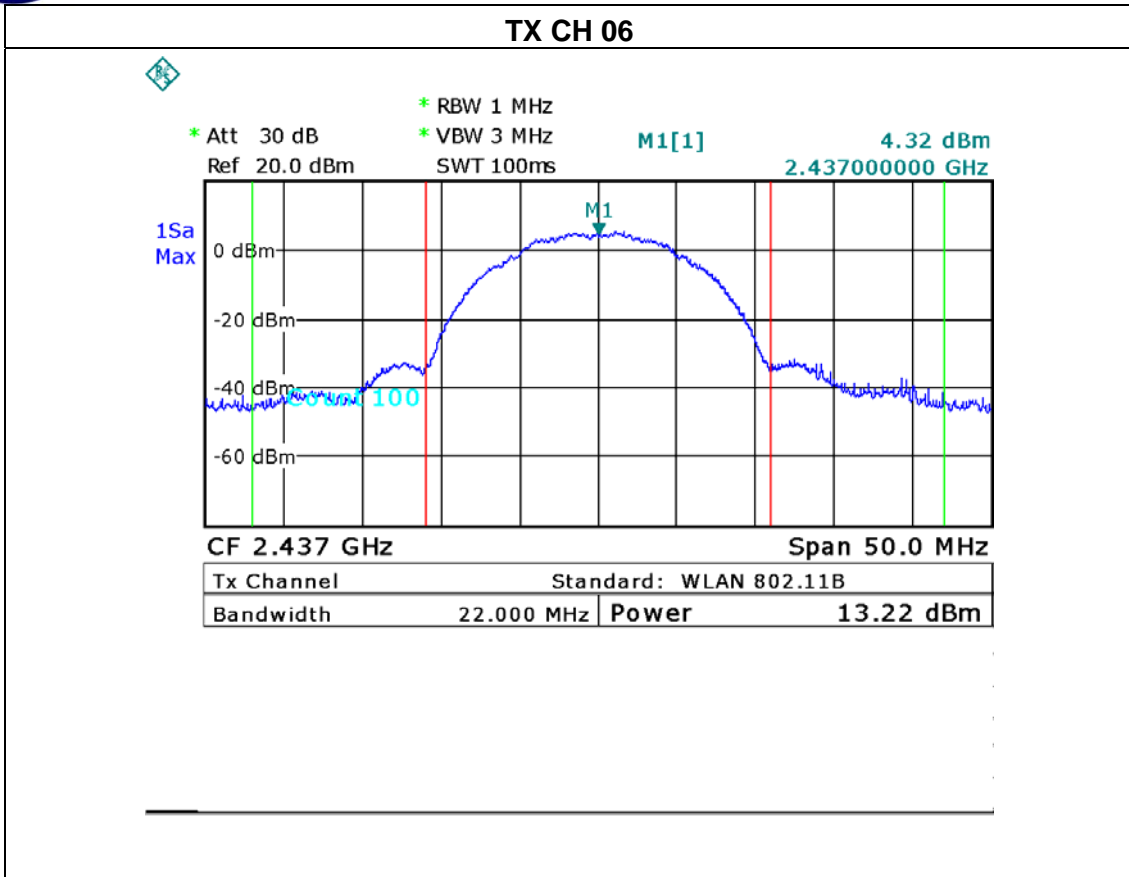



|               |                                |                     |              |
|---------------|--------------------------------|---------------------|--------------|
| EUT :         | 300Mbps Wireless-N USB Adapter | Model Name :        | WF-2109      |
| Temperature : | 24 °C                          | Relative Humidity : | 60 %         |
| Pressure :    | 1016 hPa                       | Test Voltage :      | AC 120V/60Hz |
| Test Mode :   | TX G MODE /CH01, CH06, CH11    |                     |              |

**Maximum Output Power**

| Test Channel | Frequency (MHz) | Output Power (dBm) | LIMIT (dBm) | LIMIT (W) |
|--------------|-----------------|--------------------|-------------|-----------|
| CH01         | 2412 MHz        | 13.50              | 30          | 1         |
| CH06         | 2437 MHz        | 13.24              | 30          | 1         |
| CH11         | 2462 MHz        | 13.12              | 30          | 1         |

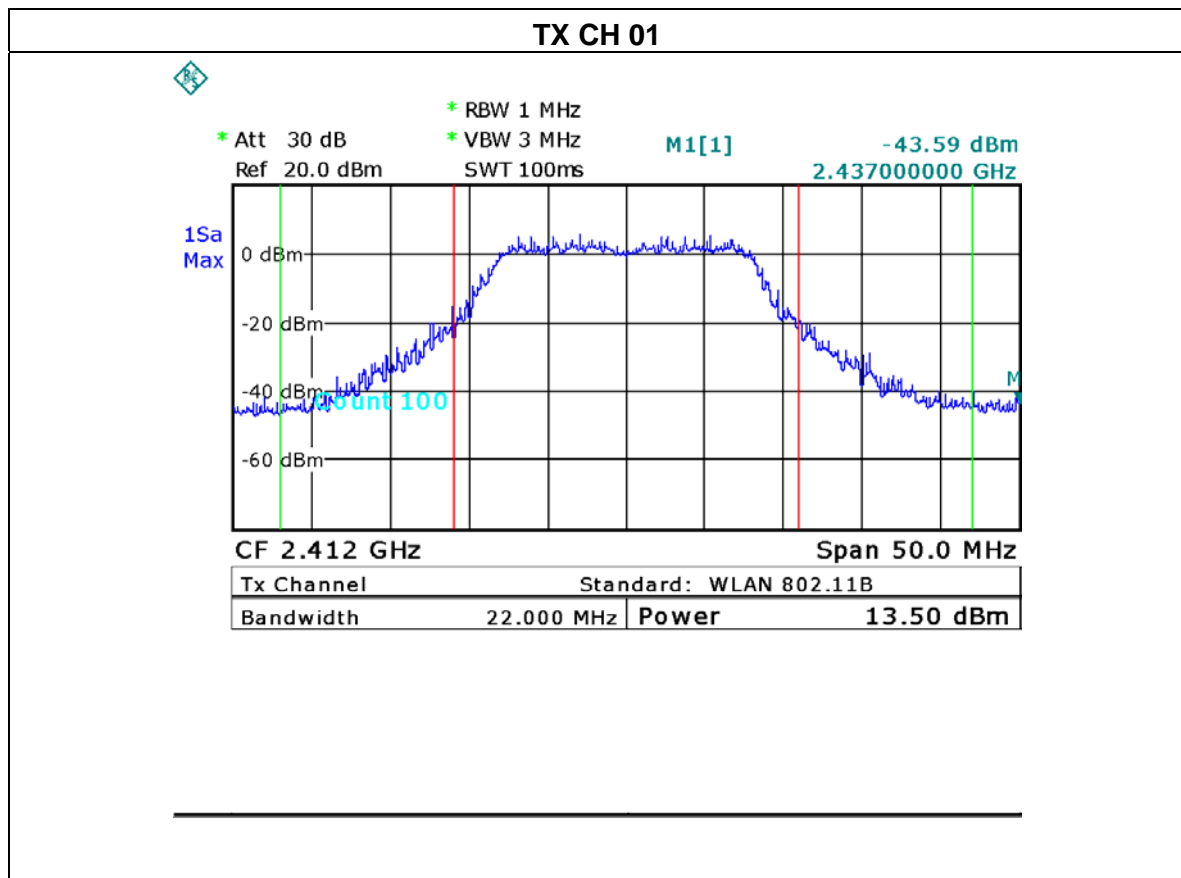

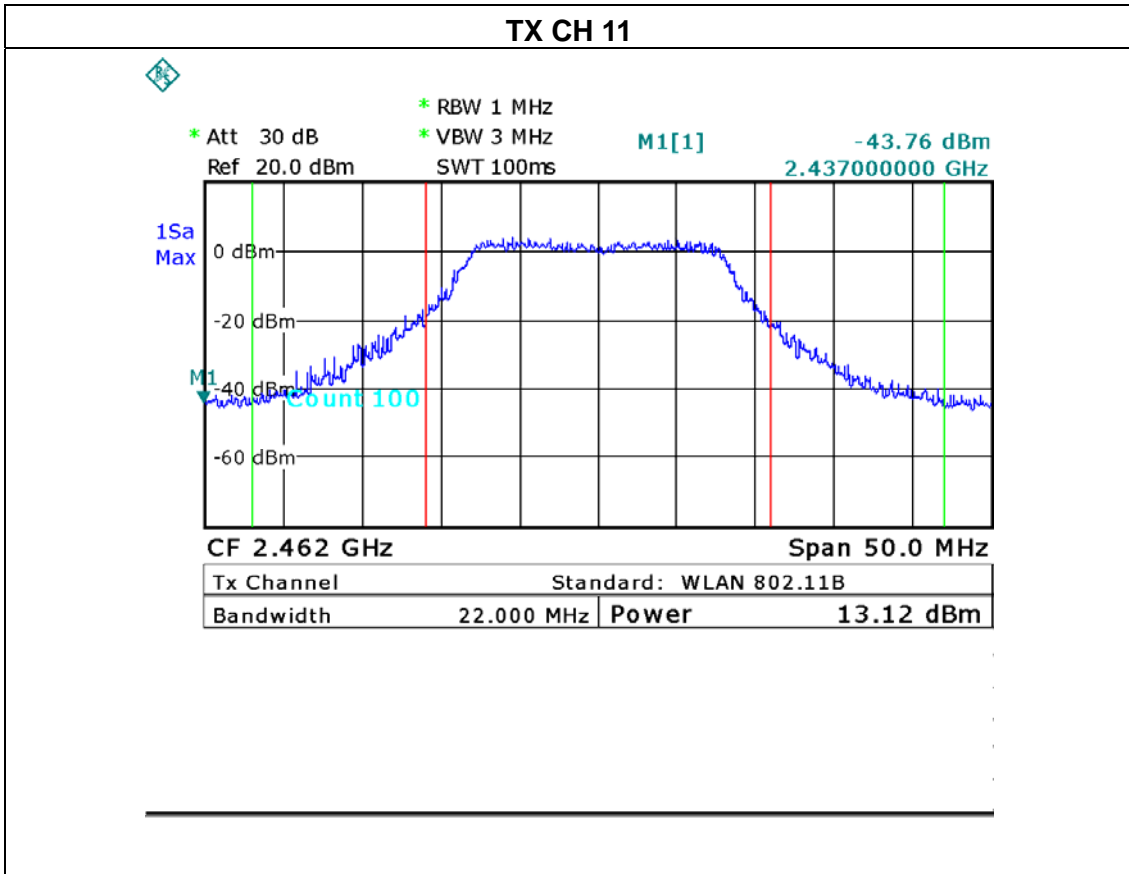
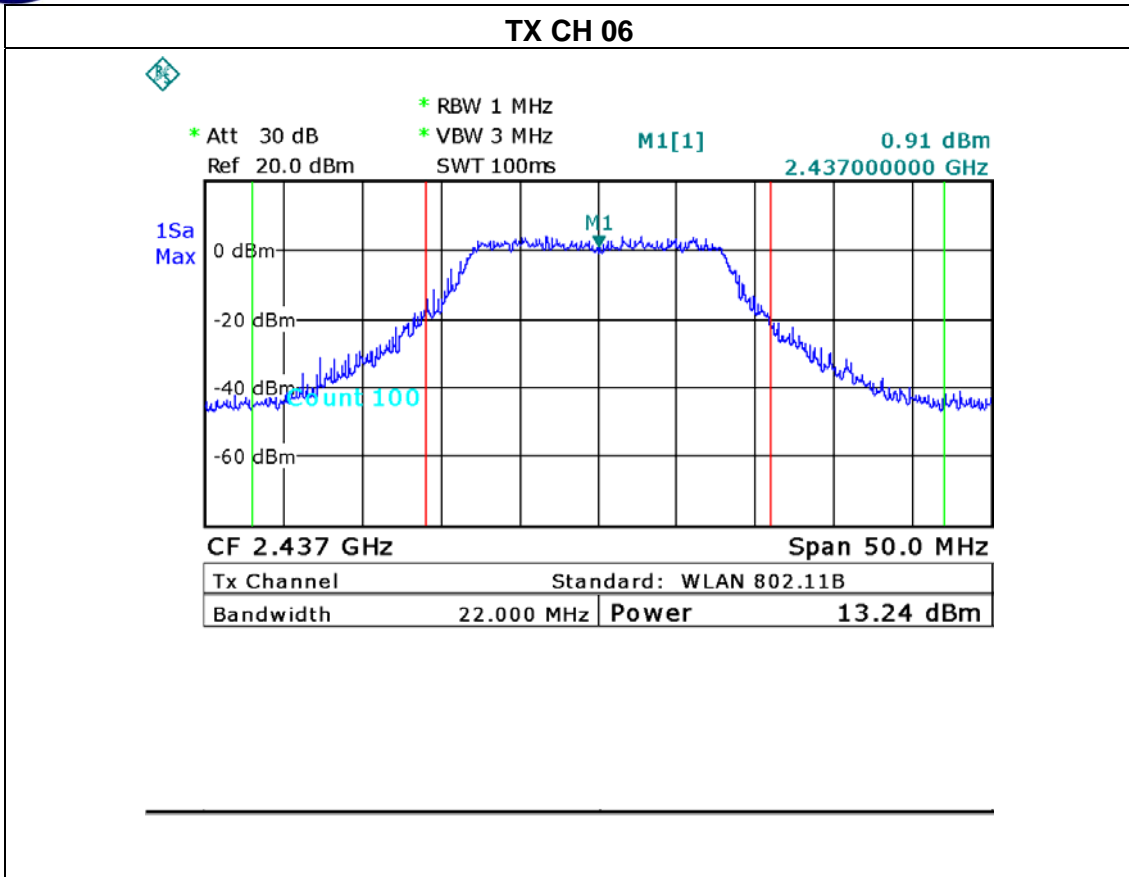



|               |                                      |                     |              |
|---------------|--------------------------------------|---------------------|--------------|
| EUT :         | 300Mbps Wireless-N USB Adapter       | Model Name :        | WF-2109      |
| Temperature : | 24 °C                                | Relative Humidity : | 60 %         |
| Pressure :    | 1016 hPa                             | Test Voltage :      | AC 120V/60Hz |
| Test Mode :   | TX N-20M MODE /CH01, CH06, CH11-ANT1 |                     |              |

**Maximum Output Power**

| Test Channel | Frequency (MHz) | Output Power (dBm) | LIMIT (dBm) | LIMIT (W) |
|--------------|-----------------|--------------------|-------------|-----------|
| CH01         | 2412 MHz        | 9.96               | 30          | 1         |
| CH06         | 2437 MHz        | 10.33              | 30          | 1         |
| CH11         | 2462 MHz        | 10.04              | 30          | 1         |

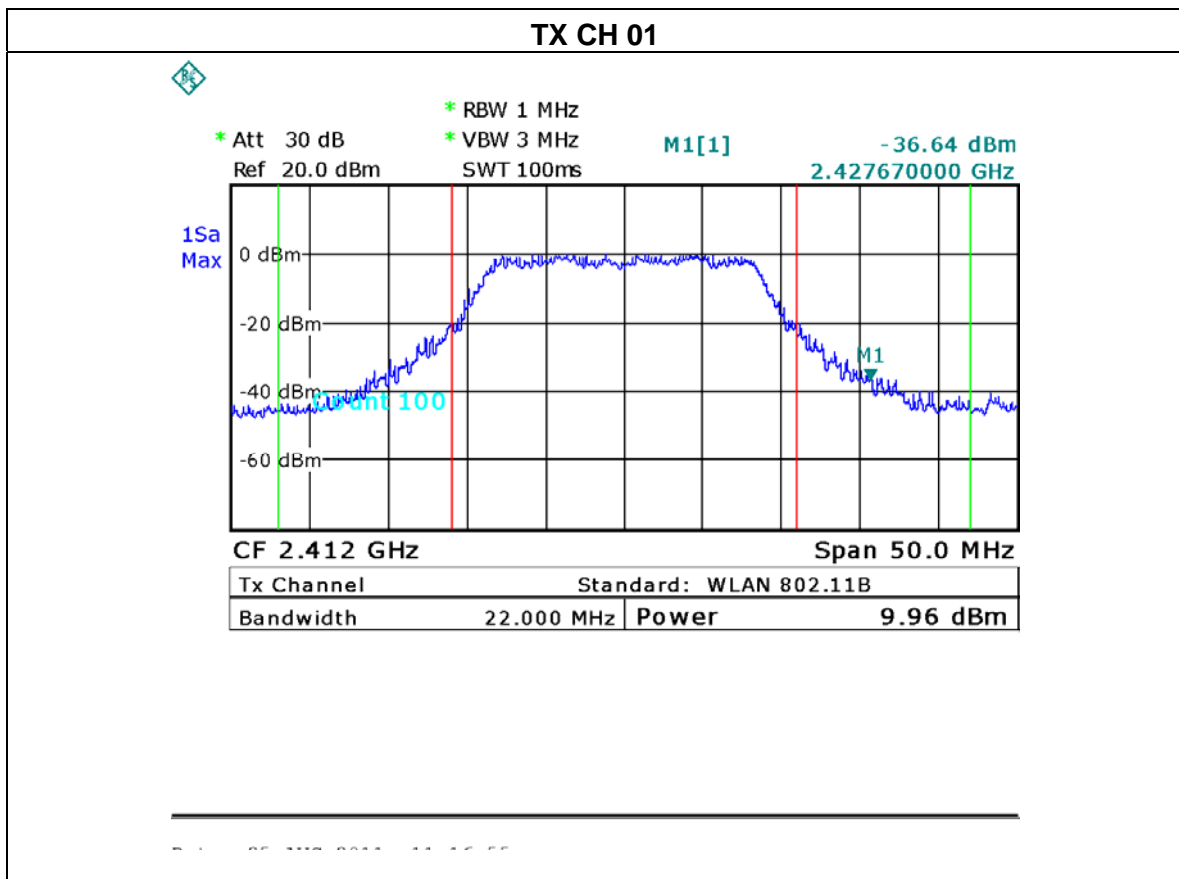

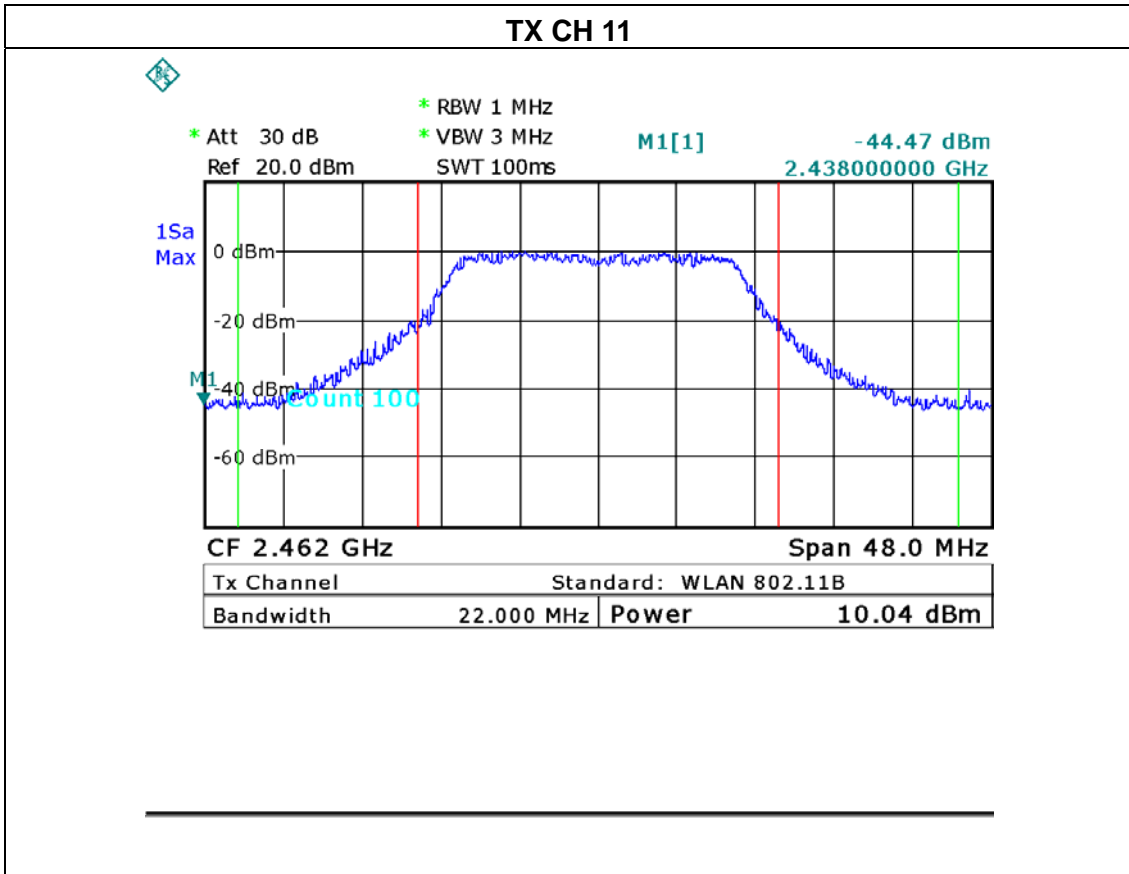
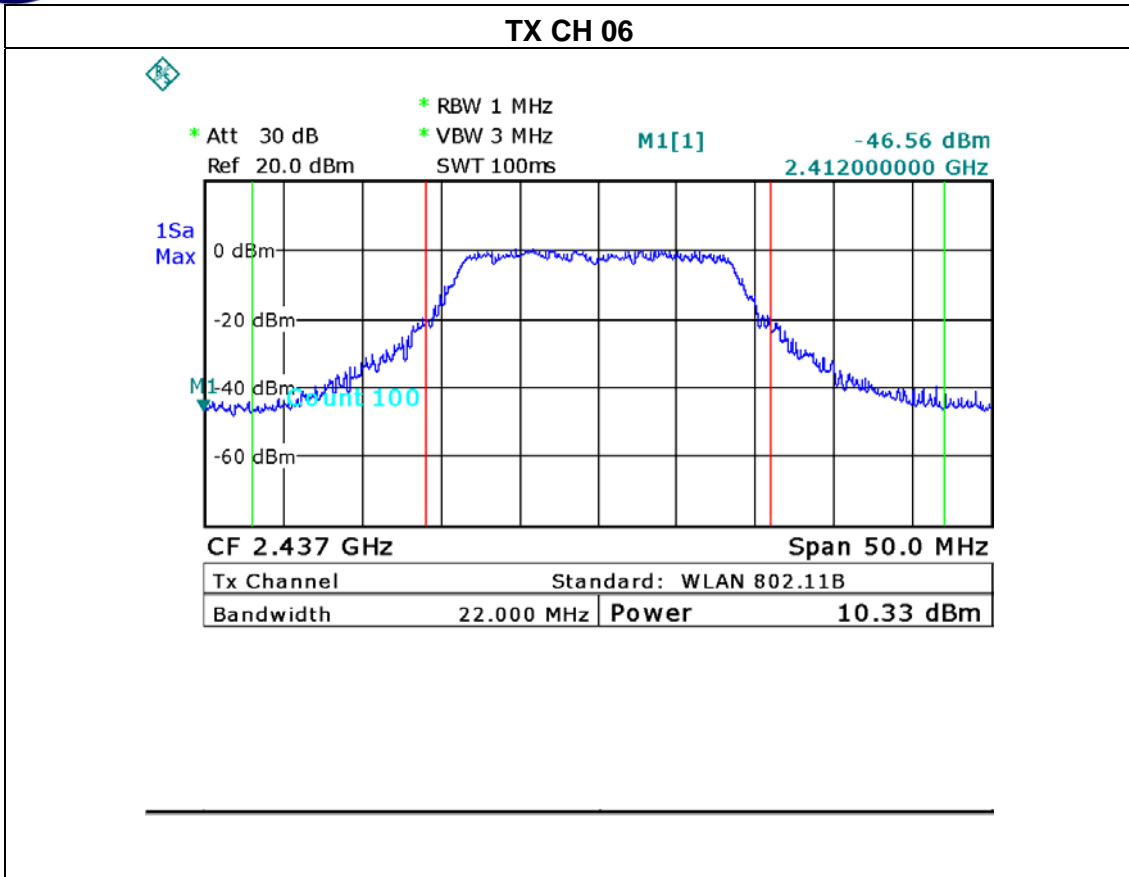





|               |                                      |                     |              |
|---------------|--------------------------------------|---------------------|--------------|
| EUT :         | 300Mbps Wireless-N USB Adapter       | Model Name :        | WF-2109      |
| Temperature : | 24 °C                                | Relative Humidity : | 60 %         |
| Pressure :    | 1016 hPa                             | Test Voltage :      | AC 120V/60Hz |
| Test Mode :   | TX N-20M MODE /CH01, CH06, CH11-ANT2 |                     |              |

**Maximum Output Power**

| Test Channel | Frequency (MHz) | Output Power (dBm) | LIMIT (dBm) | LIMIT (W) |
|--------------|-----------------|--------------------|-------------|-----------|
| CH01         | 2412 MHz        | 10.06              | 30          | 1         |
| CH06         | 2437 MHz        | 10.35              | 30          | 1         |
| CH11         | 2462 MHz        | 10.10              | 30          | 1         |

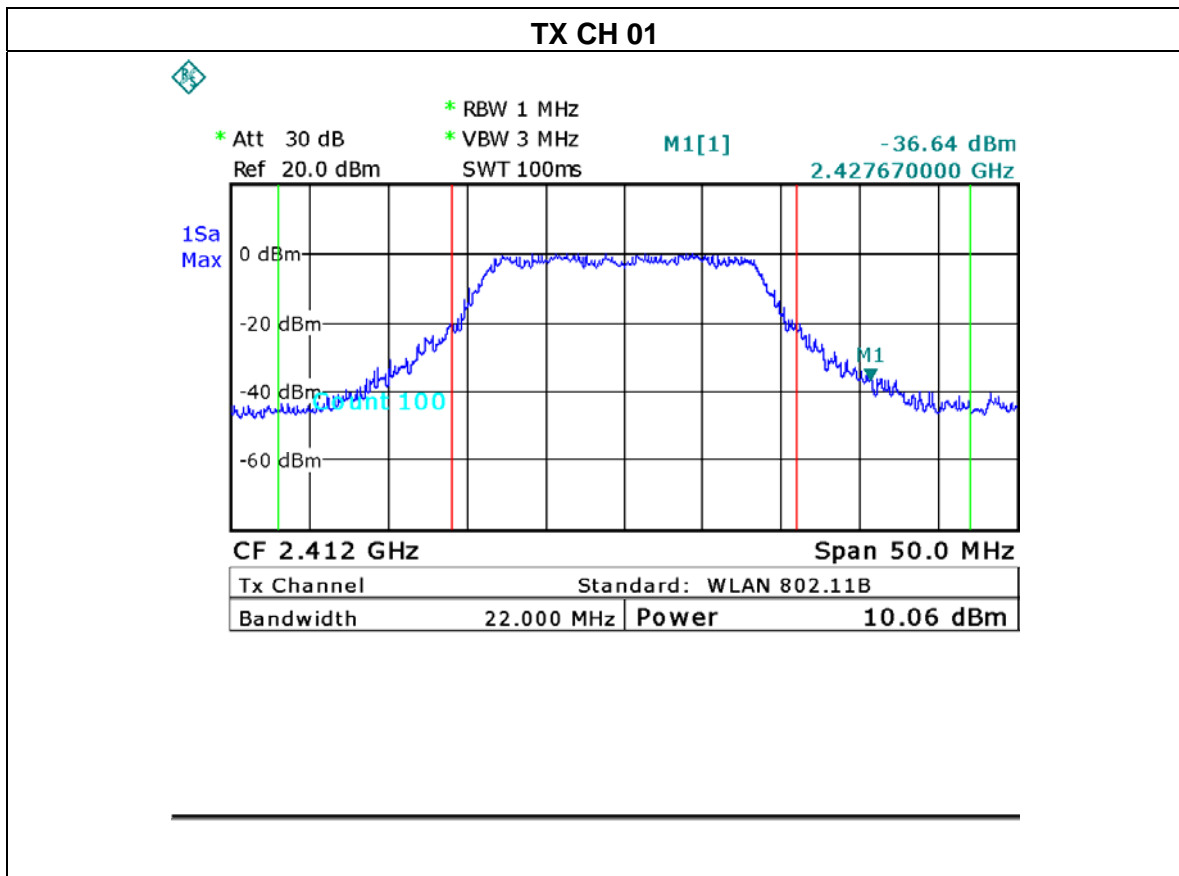

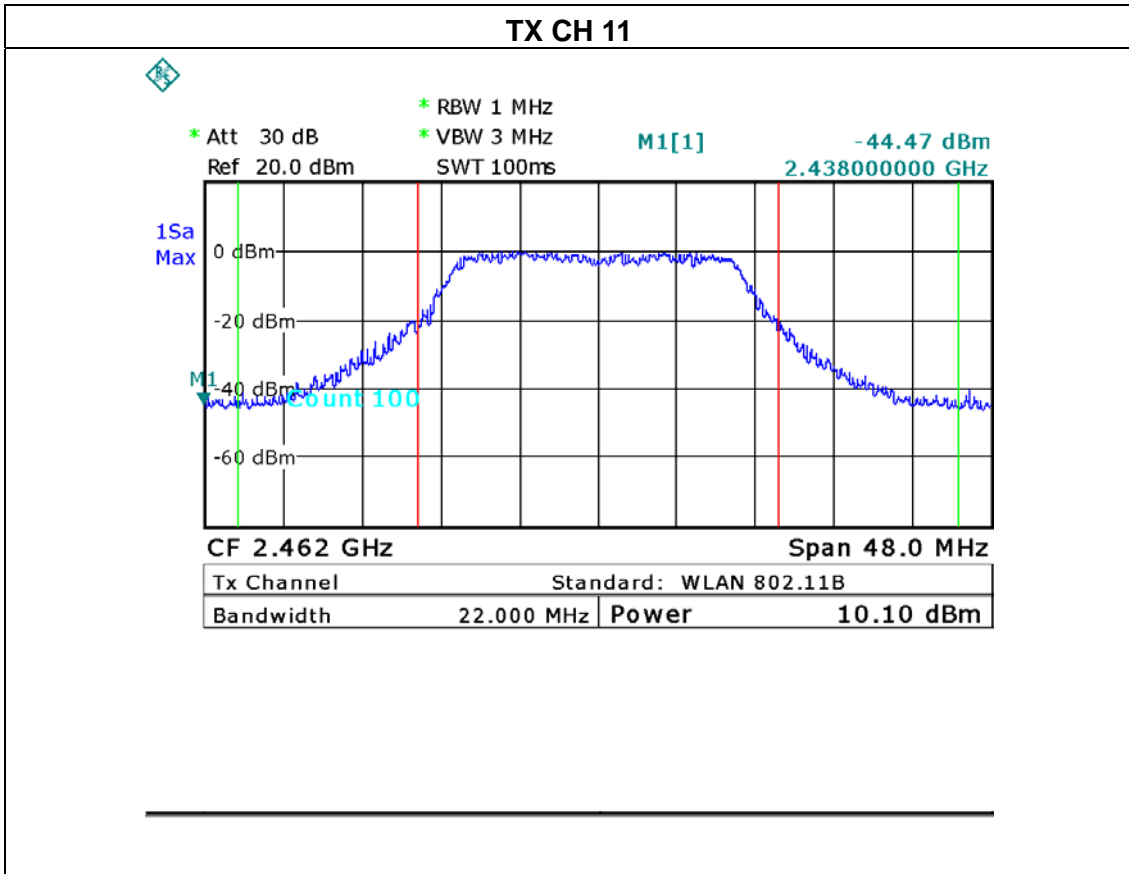
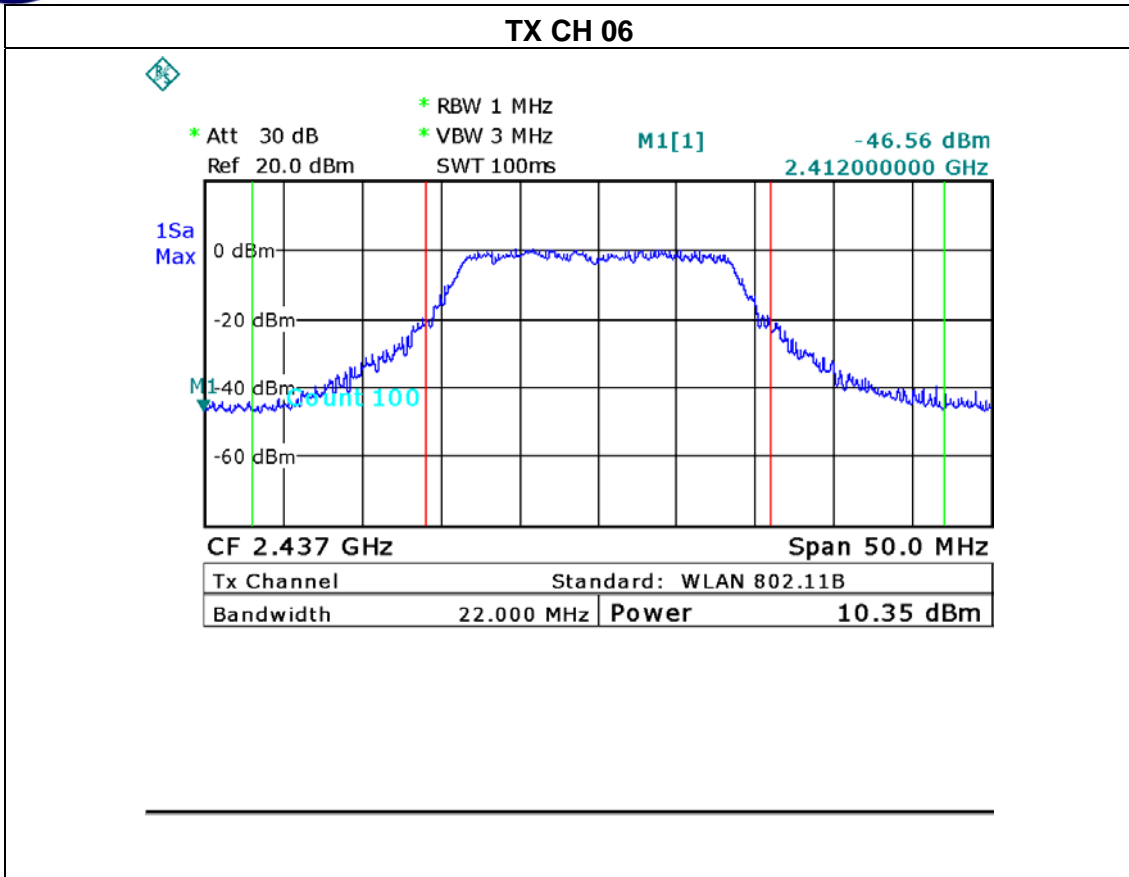



|               |   |                     |              |
|---------------|---|---------------------|--------------|
| EUT :         | 300Mbps Wireless-N USB Adapter          | Model Name :        | WF-2109      |
| Temperature : | 24 °C                                   | Relative Humidity : | 60 %         |
| Pressure :    | 1016 hPa                                | Test Voltage :      | AC 120V/60Hz |
| Test Mode :   | TX N-40M MODE /CH03, CH06, CH09 - ANT 1 |                     |              |

**Maximum Output Power**

| Test Channel | Frequency (MHz) | Output Power (dBm) | LIMIT (dBm) | LIMIT (W) |
|--------------|-----------------|--------------------|-------------|-----------|
| CH03         | 2422 MHz        | 9.99               | 30          | 1         |
| CH06         | 2437 MHz        | 10.03              | 30          | 1         |
| CH09         | 2452 MHz        | 10.10              | 30          | 1         |

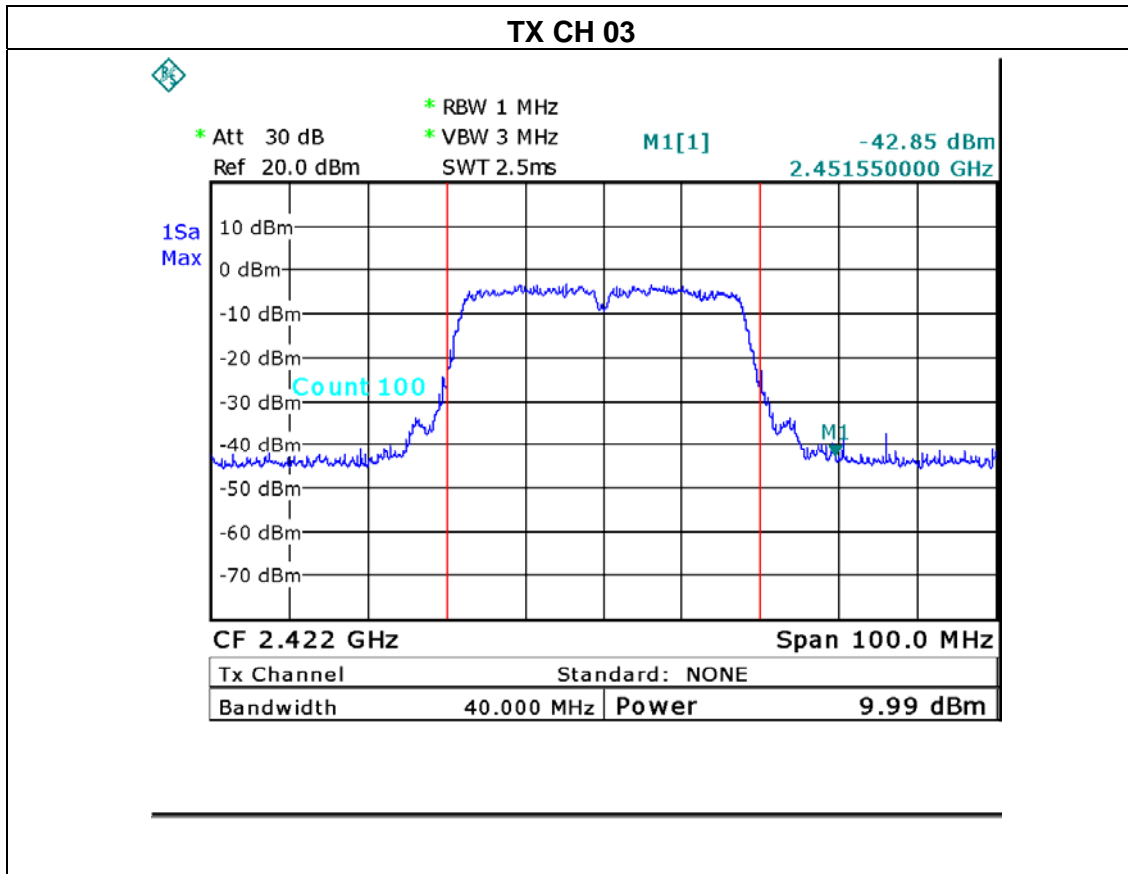

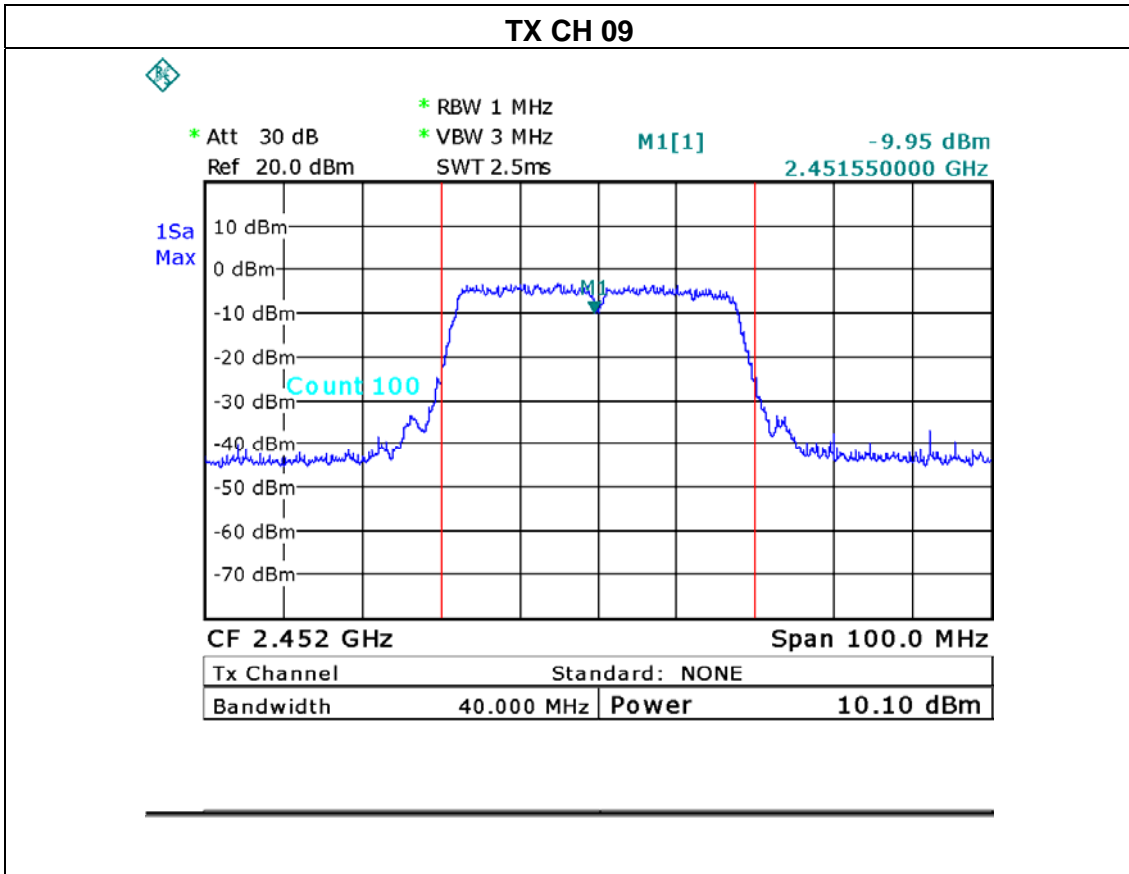
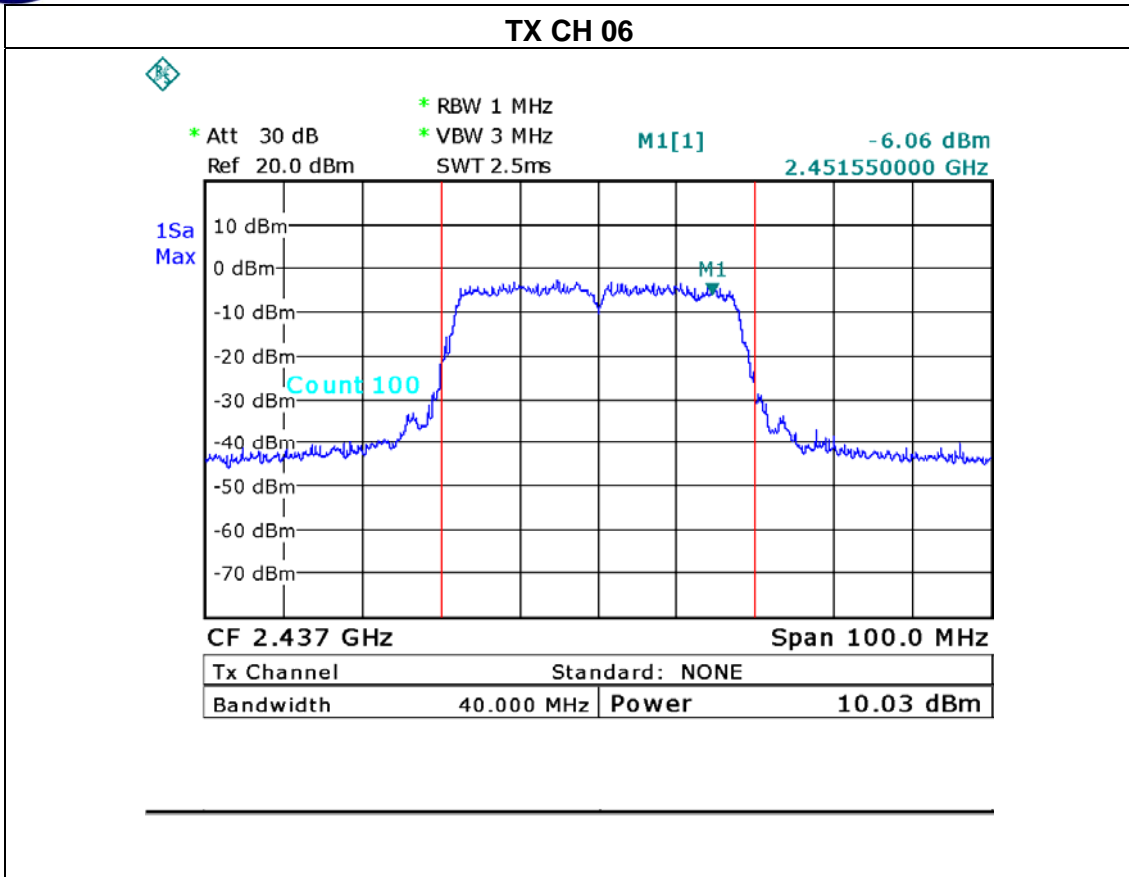



|               |   |                     |              |
|---------------|---|---------------------|--------------|
| EUT :         | 300Mbps Wireless-N USB Adapter          | Model Name :        | WF-2109      |
| Temperature : | 24 °C                                   | Relative Humidity : | 60 %         |
| Pressure :    | 1016 hPa                                | Test Voltage :      | AC 120V/60Hz |
| Test Mode :   | TX N-40M MODE /CH03, CH06, CH09 - ANT 2 |                     |              |

**Maximum Output Power**

| Test Channel | Frequency (MHz) | Output Power (dBm) | LIMIT (dBm) | LIMIT (W) |
|--------------|-----------------|--------------------|-------------|-----------|
| CH03         | 2422 MHz        | 10.05              | 30          | 1         |
| CH06         | 2437 MHz        | 10.12              | 30          | 1         |
| CH09         | 2452 MHz        | 10.18              | 30          | 1         |

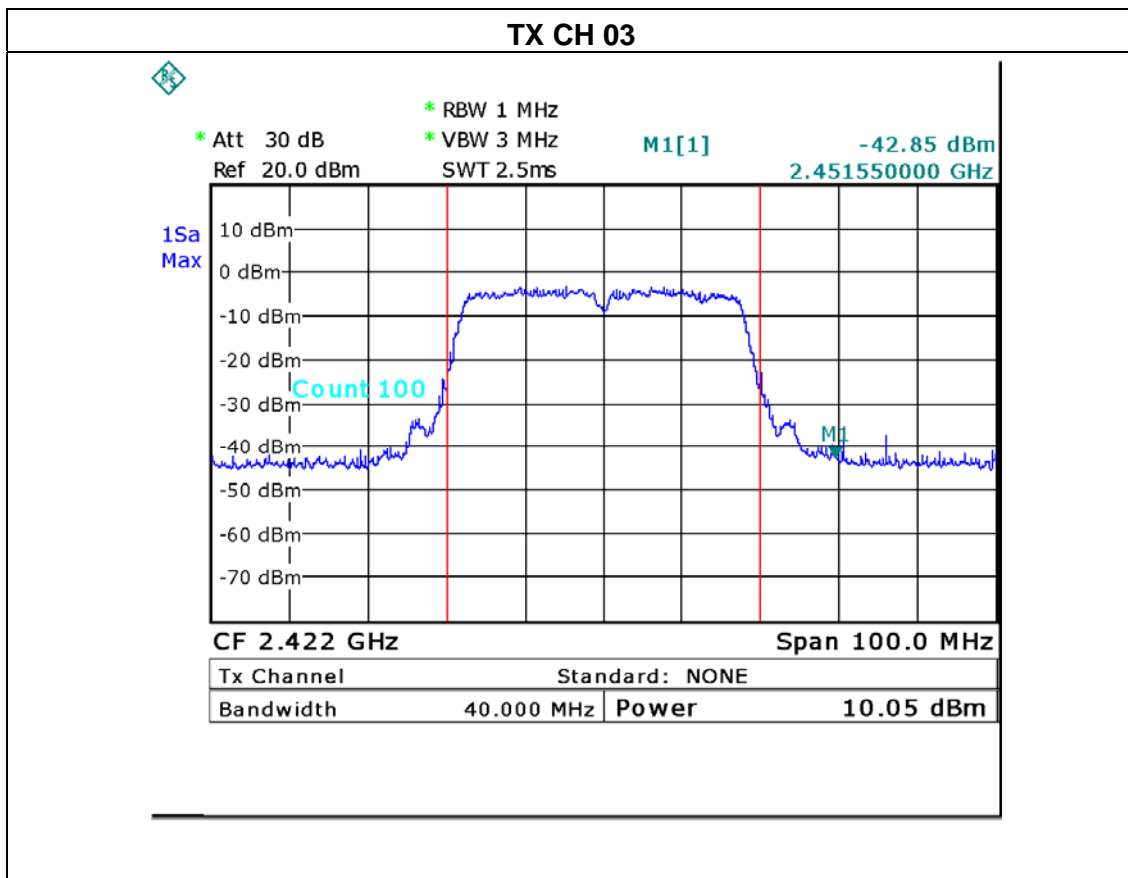

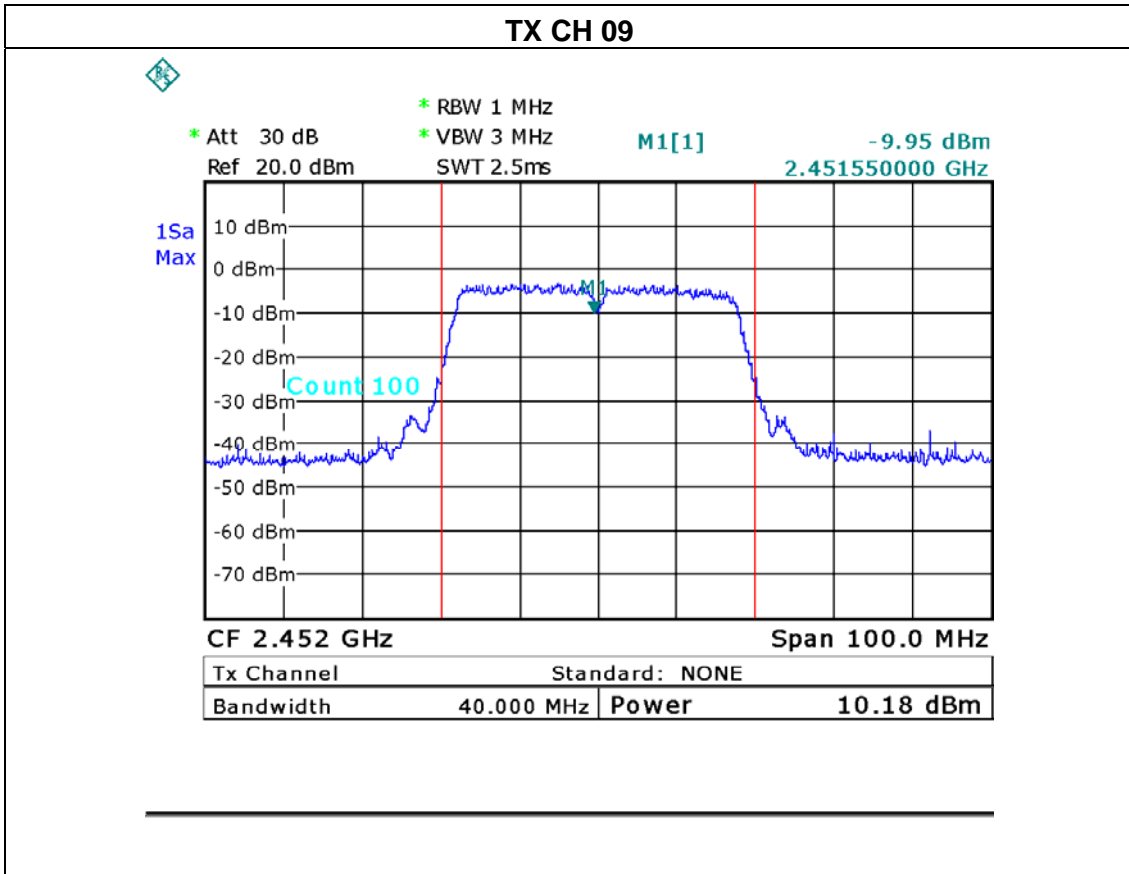
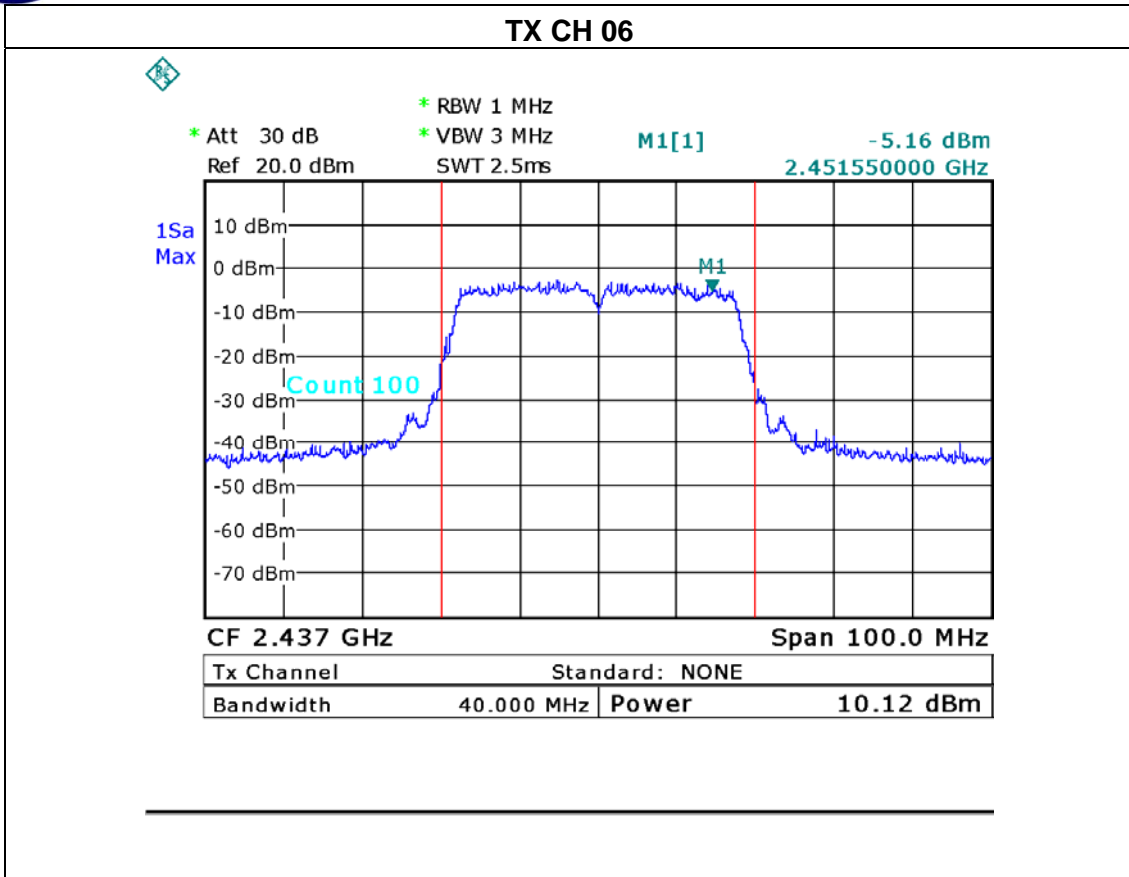



|               |  |                     |              |
|---------------|--|---------------------|--------------|
| EUT :         | 300Mbps Wireless-N USB Adapter                 | Model Name :        | WF-2109      |
| Temperature : | 24 °C  | Relative Humidity : | 60 %         |
| Pressure :    | 1016 hPa                                       | Test Voltage :      | AC 120V/60Hz |
| Test Mode :   | TX N-20M MODE /CH01, CH06, CH11 - ANT 1+ ANT 2 |                     |              |

**Maximum Output Power**

| Test Channel | Frequency (MHz) | Output Power (dBm) | LIMIT (dBm) | LIMIT (W) |
|--------------|-----------------|--------------------|-------------|-----------|
| CH01         | 2412 MHz        | 13.02              | 30          | 1         |
| CH06         | 2437 MHz        | 13.35              | 30          | 1         |
| CH11         | 2462 MHz        | 13.08              | 30          | 1         |

|               |  |                     |              |
|---------------|--|---------------------|--------------|
| EUT :         | 300Mbps Wireless-N USB Adapter                 | Model Name :        | WF-2109      |
| Temperature : | 24 °C  | Relative Humidity : | 60 %         |
| Pressure :    | 1016 hPa                                       | Test Voltage :      | AC 120V/60Hz |
| Test Mode :   | TX N-40M MODE /CH03, CH06, CH09 - ANT 1+ ANT 2 |                     |              |

**Maximum Output Power**

| Test Channel | Frequency (MHz) | Output Power (dBm) | LIMIT (dBm) | LIMIT (W) |
|--------------|-----------------|--------------------|-------------|-----------|
| CH03         | 2422 MHz        | 13.03              | 30          | 1         |
| CH06         | 2437 MHz        | 13.09              | 30          | 1         |
| CH09         | 2452 MHz        | 13.15              | 30          | 1         |

Note: Each antenna port was measured individually, and the aggregated power was summed up mathematically.

Remark :

- (1) **The MIMO test requirement, RF conducted output power shall measure each transmitter chain by using channel power method.**  
**And after obtain each individual transmitter chain power, then sum the output power by using the following formula:**  

$$((\text{dBm}/\text{Chain 1})/10^{\text{Log}}) + ((\text{dBm}/\text{Chain 2})/10^{\text{log}}) + ((\text{dBm}/\text{ChainN})/10^{\text{log}}) =$$
**Combined peak output power in mW.**
- (2) **Antenna Gain=0 dBi.**



**7. ANTENNA CONDUCTED SPURIOUS EMISSION**

**7.1 Applied procedures / limit**

30dBc in any 100 kHz bandwidth outside the operating frequency band. In case the emission fall within the restricted band specified on 15.205(a), then the 15.209(a) limit in the table below has to be followed.

| Frequencies (MHz) | Field Strength (micorvolts/meter) | Measurement Distance (meters) |
|-------------------|-----------------------------------|-------------------------------|
| 0.009~0.490       | 2400/F(KHz)                       | 300                           |
| 0.490~1.705       | 24000/F(KHz)                      | 30                            |
| 1.705~30.0        | 30                                | 30                            |
| 30~88             | 100                               | 3                             |
| 88~216            | 150                               | 3                             |
| 216~960           | 200                               | 3                             |
| Above 960         | 500                               | 3                             |

**7.1.1 MEASUREMENT INSTRUMENTS LIST**

| Item | Kind of Equipment | Manufacturer | Type No. | Serial No. | Calibrated until |
|------|-------------------|--------------|----------|------------|------------------|
| 1    | Spectrum Analyzer | R&S          | FSP 40   | 100185     | Nov.26.2011      |

Remark: " N/A" denotes No Model Name. , Serial No. or No Calibration specified.

**7.1.2 TEST PROCEDURE**

- a. The EUT was directly connected to the spectrum analyzer and antenna output port as show in the block diagram below,
- b. Spectrum Setting : RBW= 100KHz, VBW=100KHz, Sweep time = 10 ms.

**7.1.3 DEVIATION FROM STANDARD**

No deviation.

**7.1.4 TEST SETUP**



**7.1.5 EUT OPERATION CONDITIONS**

The EUT tested system was configured as the statements of 4.1.6 Unless otherwise a special operating condition is specified in the follows during the testing.





**7.1.6 TEST RESULTS**

|               |                                |                     |              |
|---------------|--------------------------------|---------------------|--------------|
| EUT :         | 300Mbps Wireless-N USB Adapter | Model Name :        | WF-2109      |
| Temperature : | 24 °C                          | Relative Humidity : | 60 %         |
| Pressure :    | 1016 hPa                       | Test Voltage :      | AC 120V/60Hz |
| Test Mode :   | TX B MODE /CH01, CH06 , CH11   |                     |              |

| Channel of Worst Data: CH11   |            |  |            |
|---|------------|--|------------|
| The max. radio frequency power in any 100kHz bandwidth outside the frequency band   |            | The max. radio frequency power in any 100 kHz bandwidth within the frequency band. |            |
| FREQUENCY(MHz)  | POWER(dBm) | FREQUENCY(MHz)   | POWER(dBm) |
| 2374.00   | -48.30     | 2485.20  | -46.67     |
| Result  |            |  |            |
| In any 100kHz bandwidth outside the frequency band, the radio frequency power is at least 30dB below that in the 100kHz bandwidth within the band that contains the highest level of the desired power. |            |  |            |

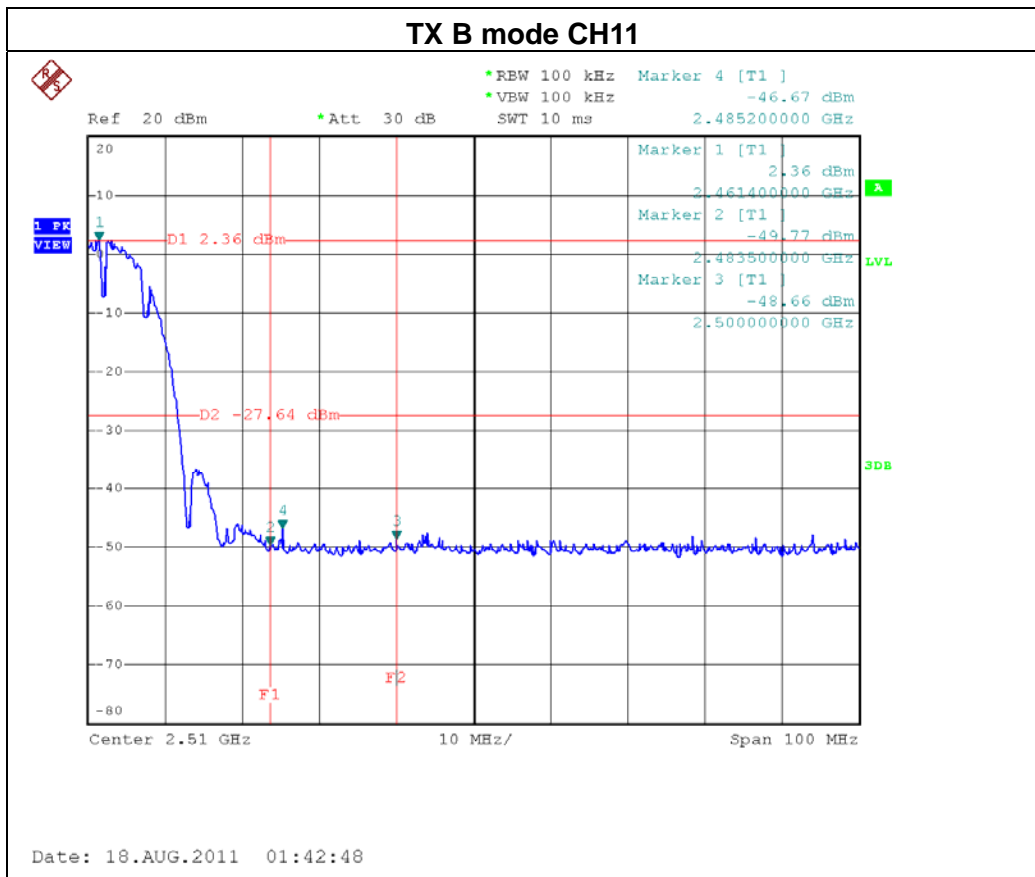
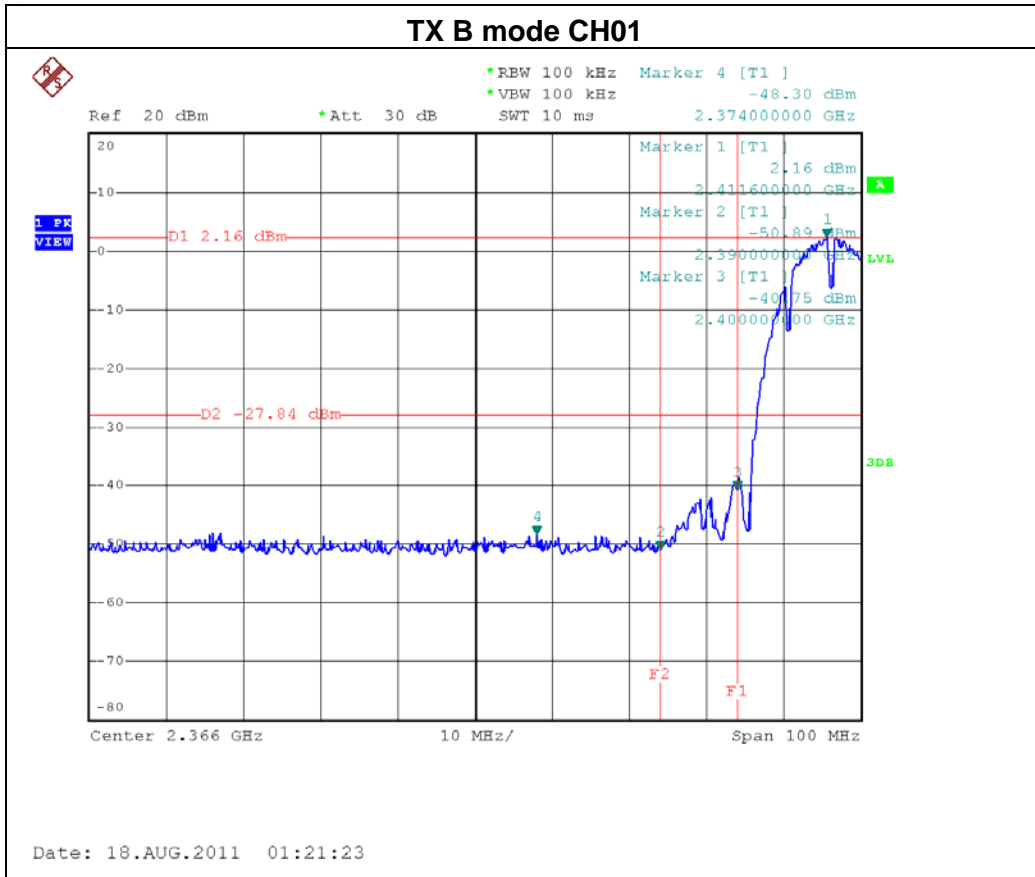

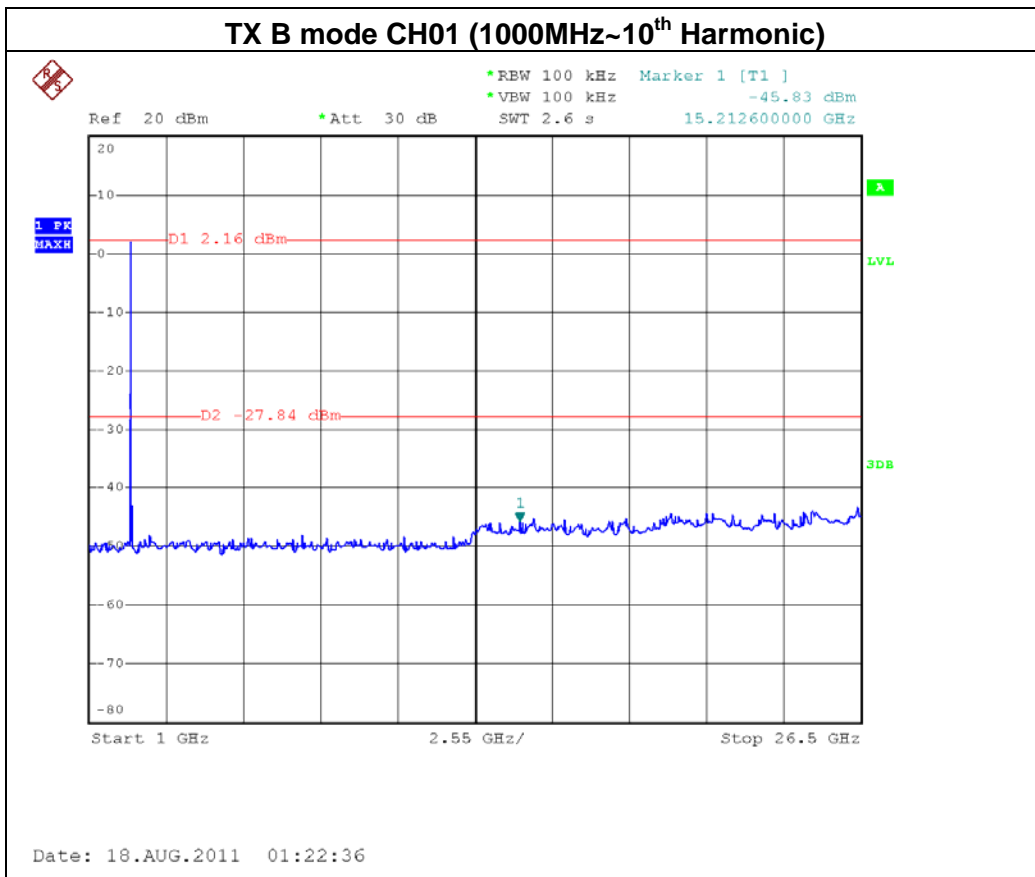
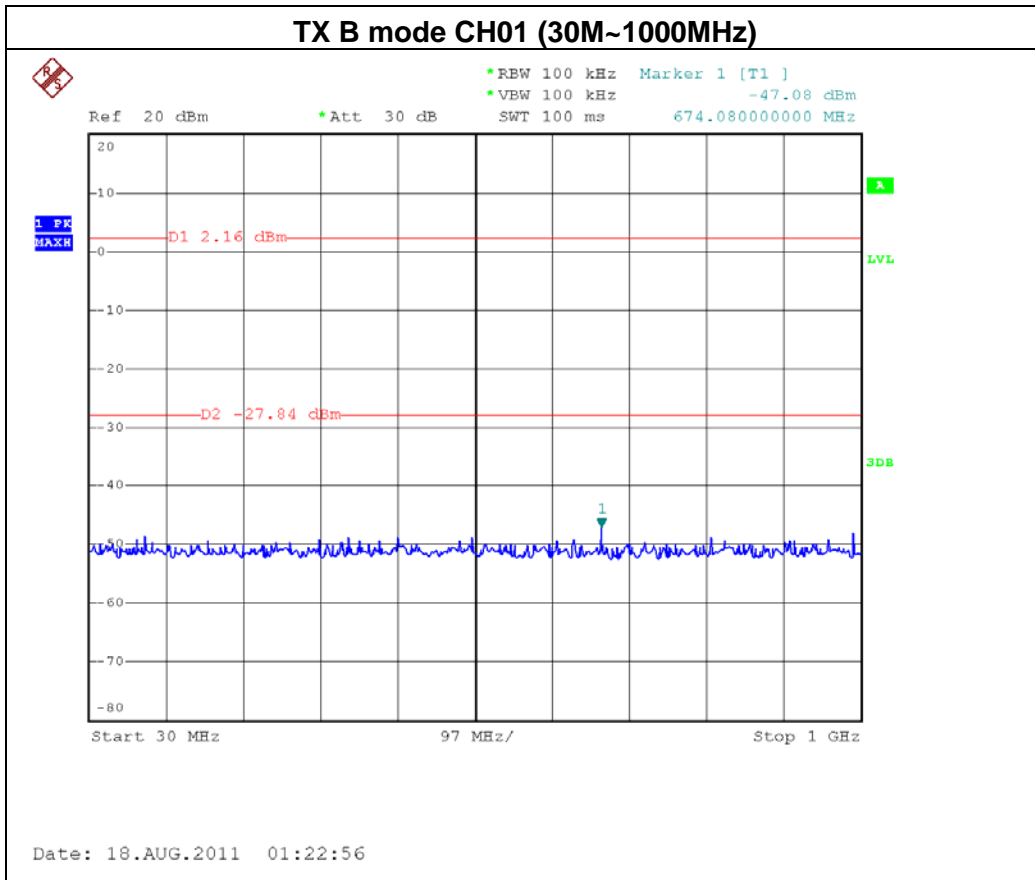

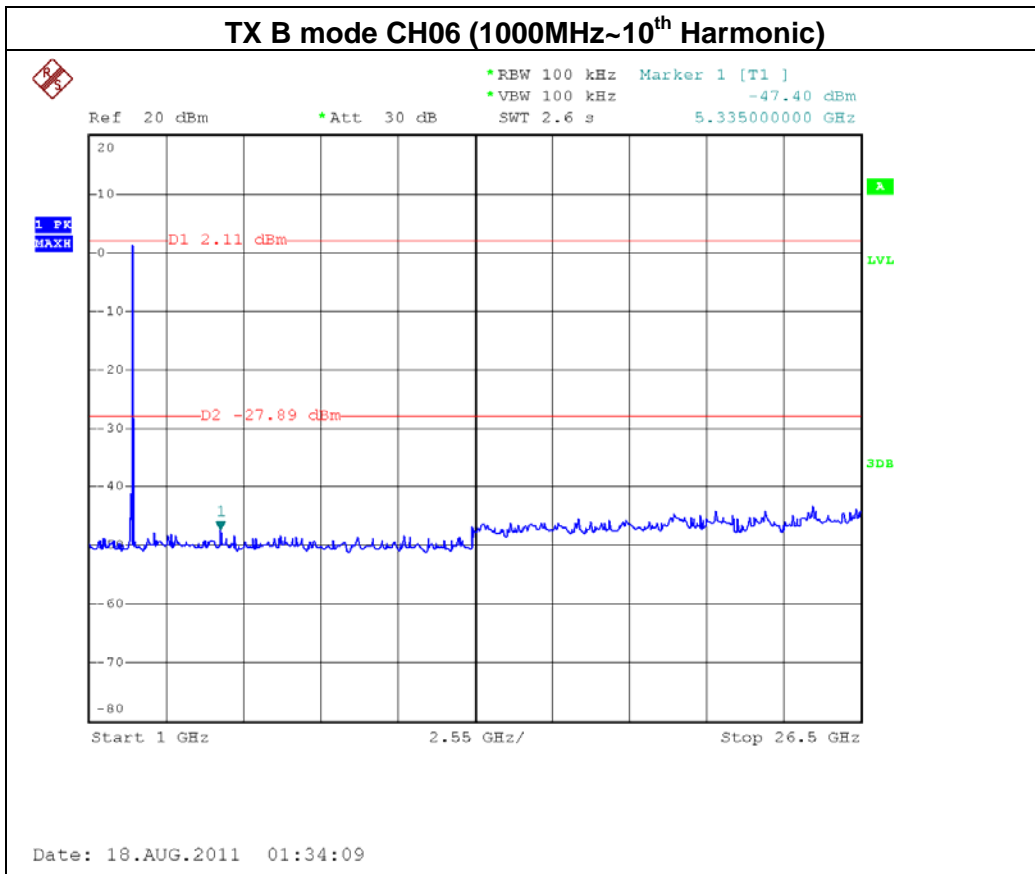
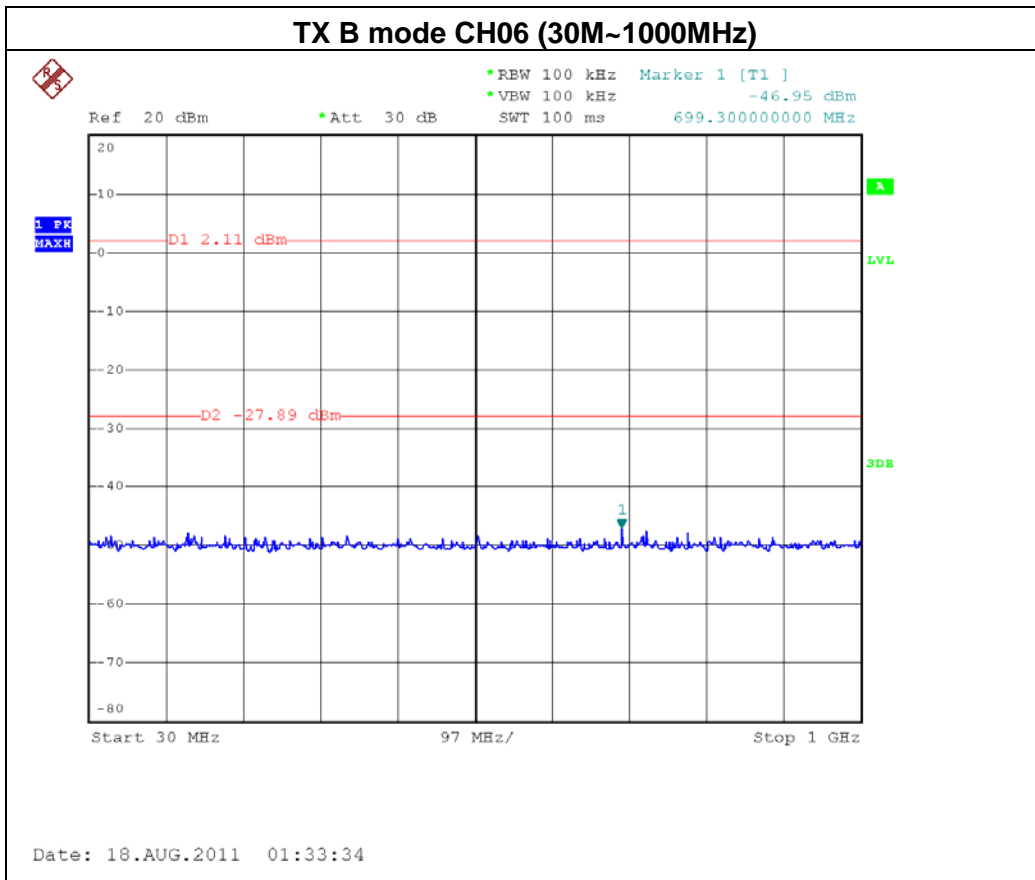

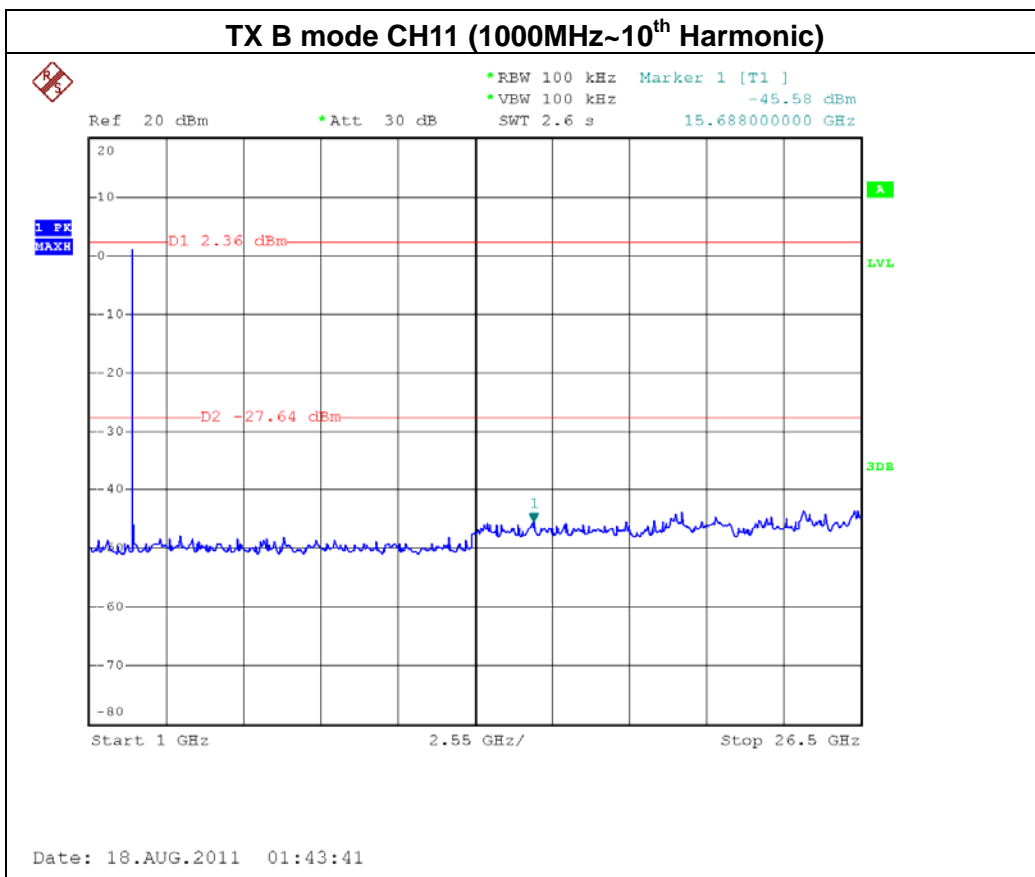
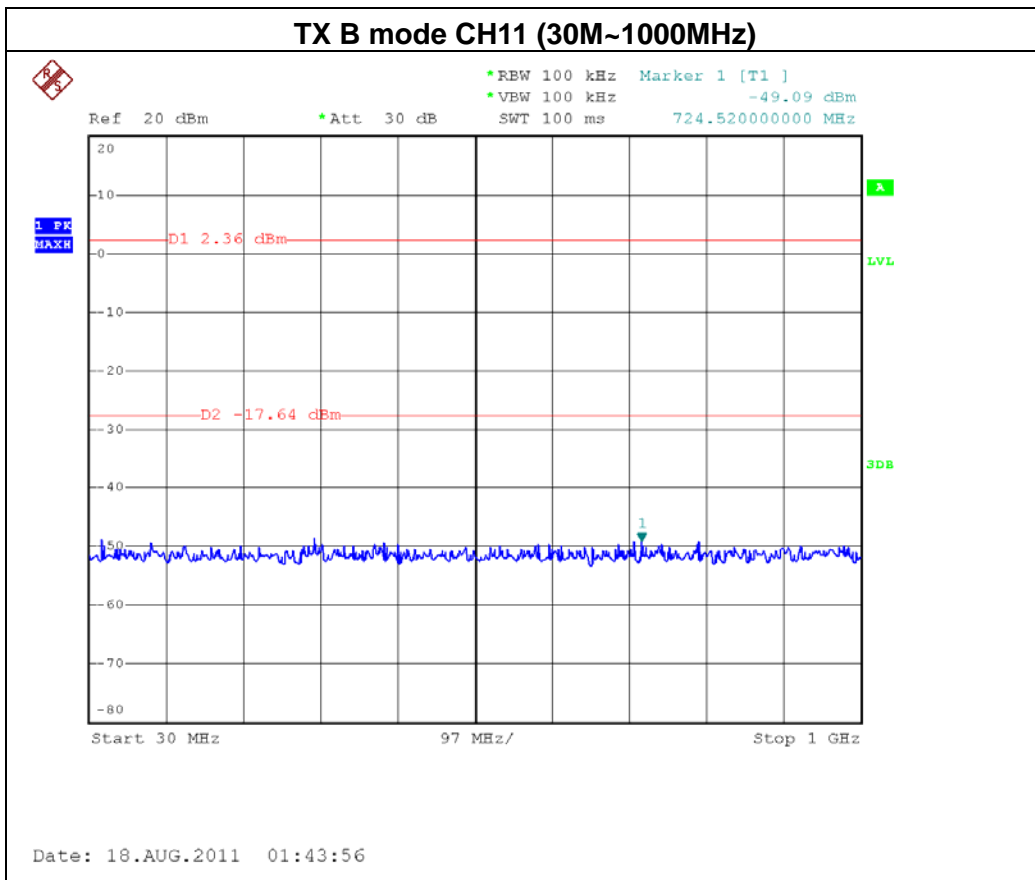



|               |                                |                     |              |
|---------------|--------------------------------|---------------------|--------------|
| EUT :         | 300Mbps Wireless-N USB Adapter | Model Name :        | WF-2109      |
| Temperature : | 24 °C                          | Relative Humidity : | 60 %         |
| Pressure :    | 1016 hPa                       | Test Voltage :      | AC 120V/60Hz |
| Test Mode :   | TX G MODE / CH01, CH06 , CH11  |                     |              |

| Channel of Worst Data: CH11   |            |  |            |
|---|------------|--|------------|
| The max. radio frequency power in any 100kHz bandwidth outside the frequency band |            | The max. radio frequency power in any 100 kHz bandwidth within the frequency band. |            |
| FREQUENCY(MHz)  | POWER(dBm) | FREQUENCY(MHz)   | POWER(dBm) |
| 2387.40   | -47.92     | 2485.60  | -45.50     |

**Result**

In any 100kHz bandwidth outside the frequency band, the radio frequency power is at least 30dB below that in the 100kHz bandwidth within the band that contains the highest level of the desired power.

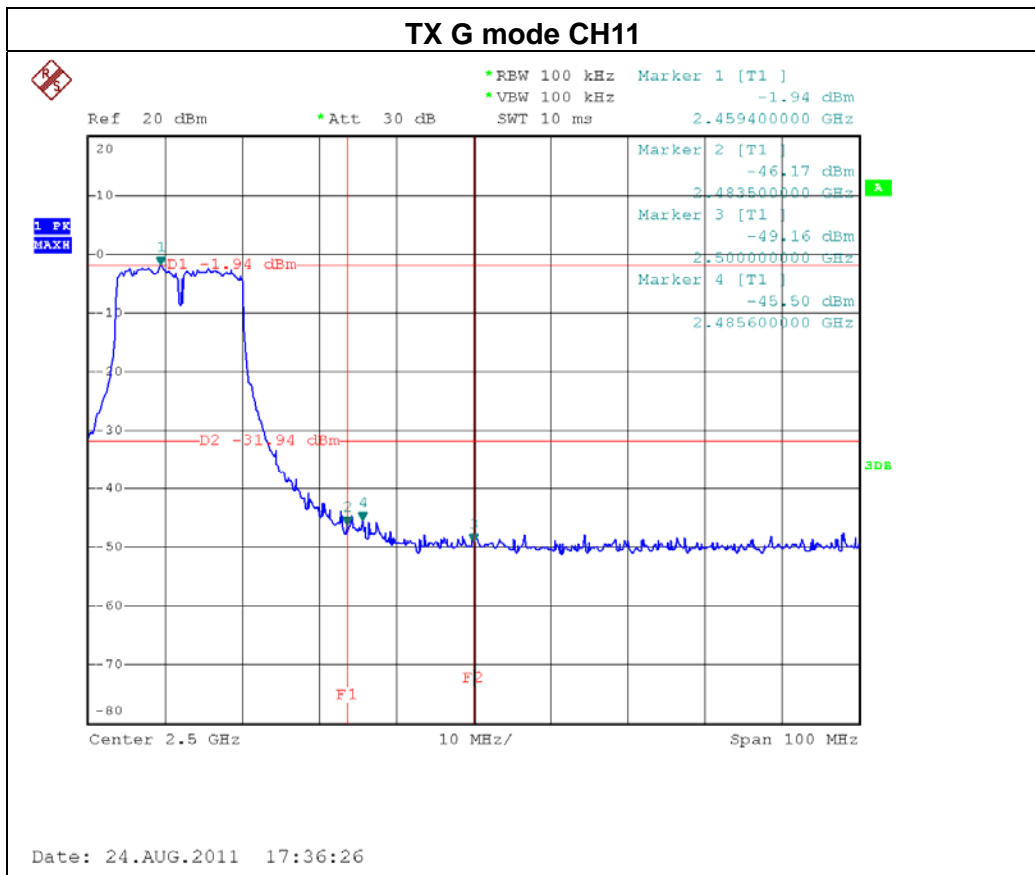
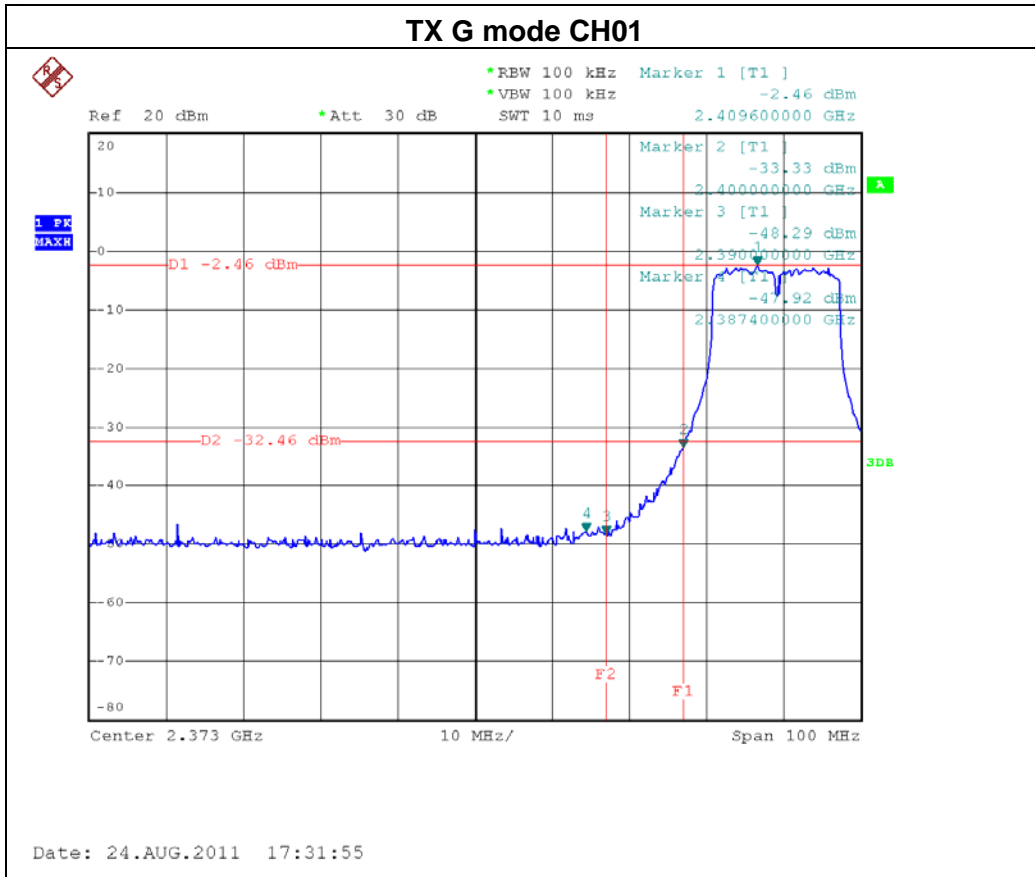

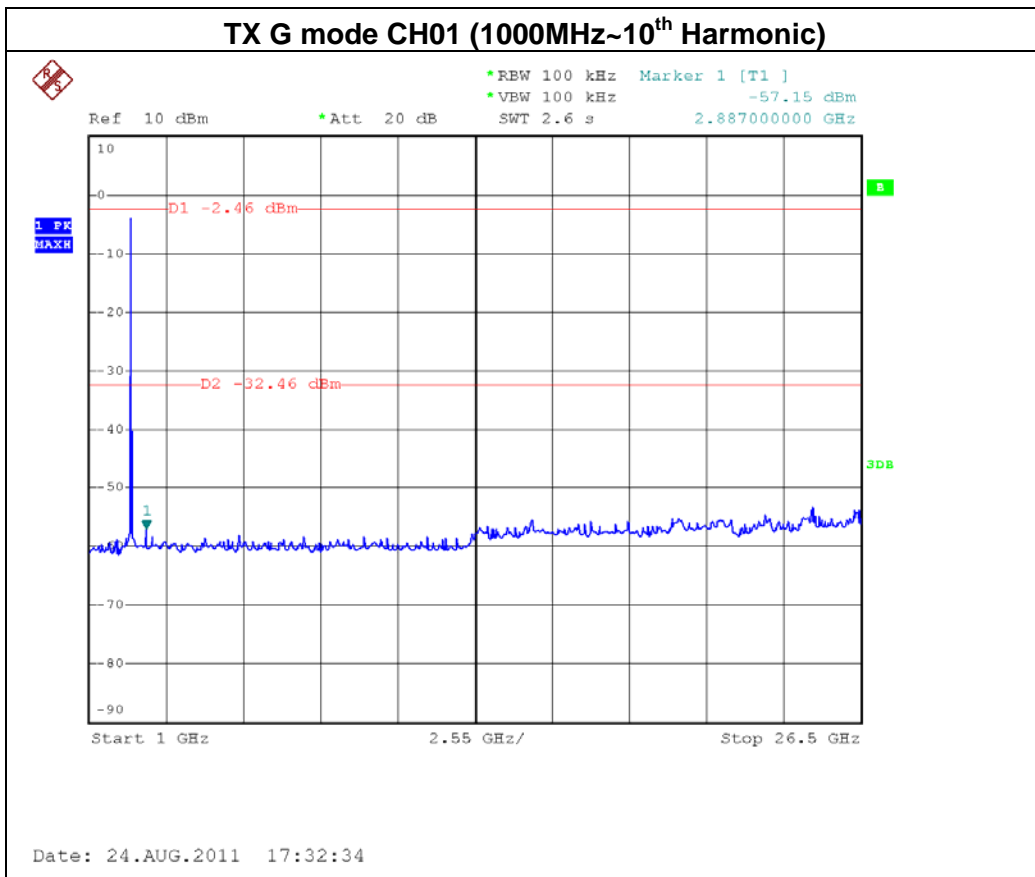
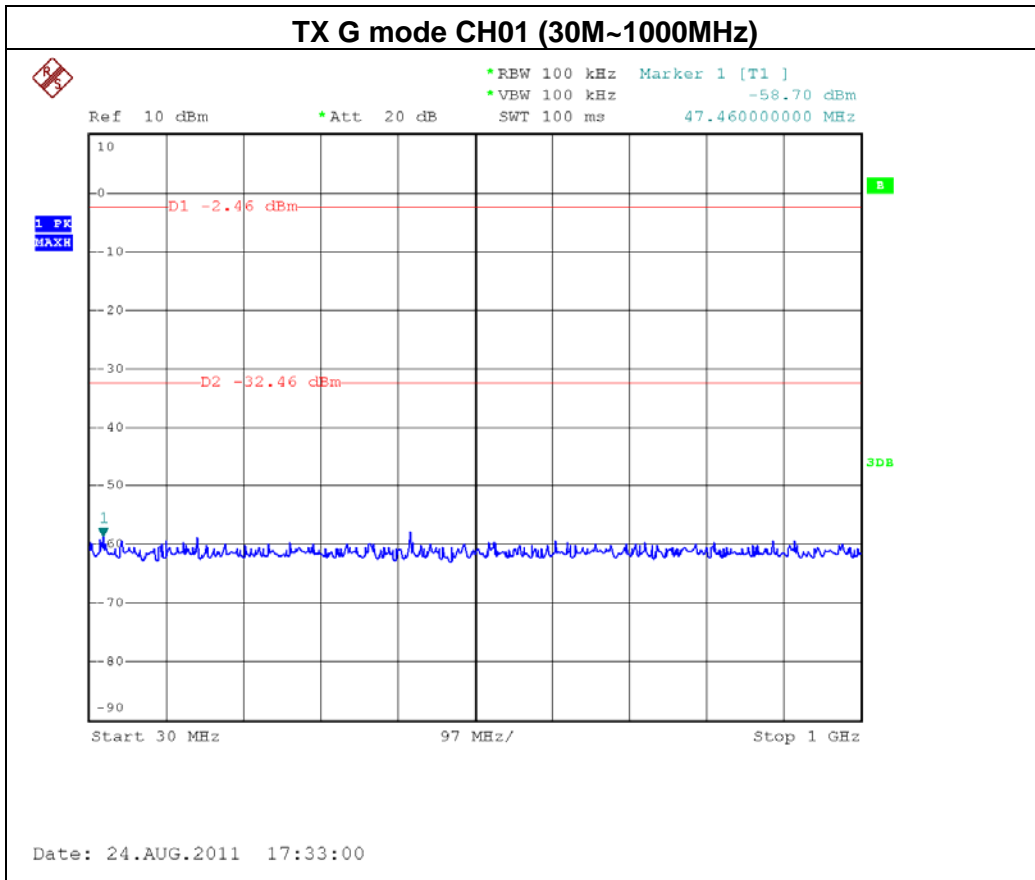



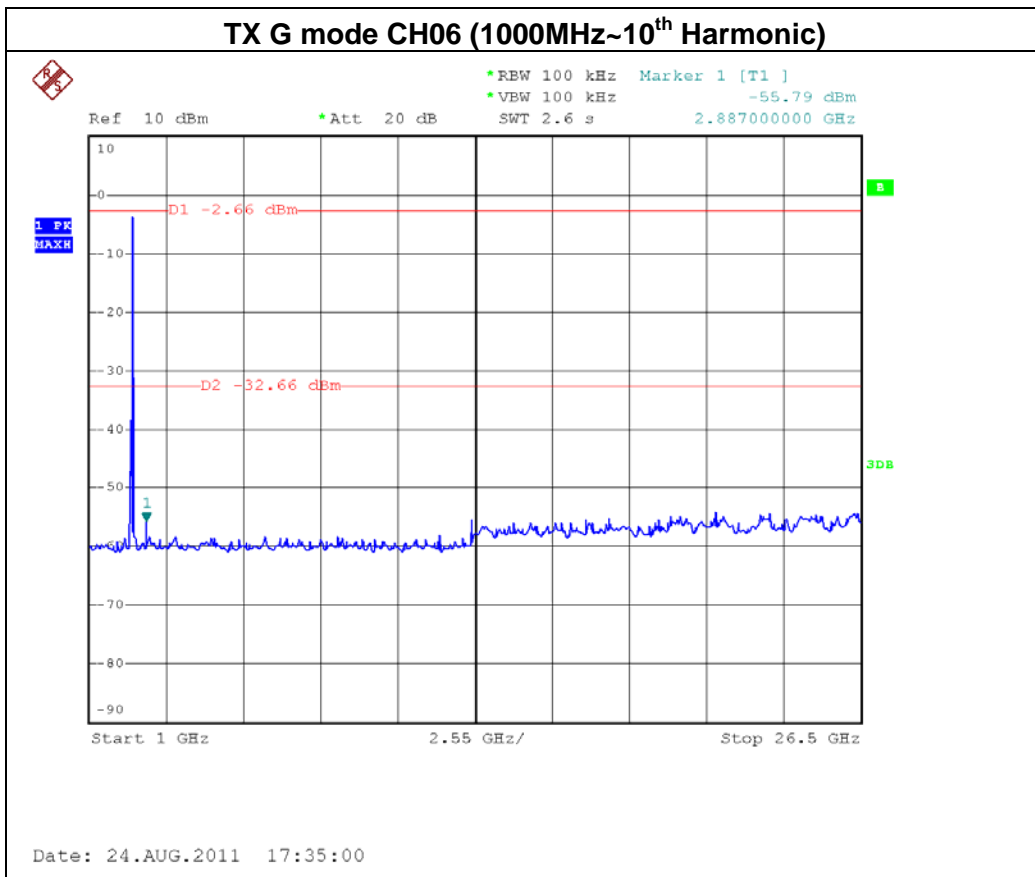
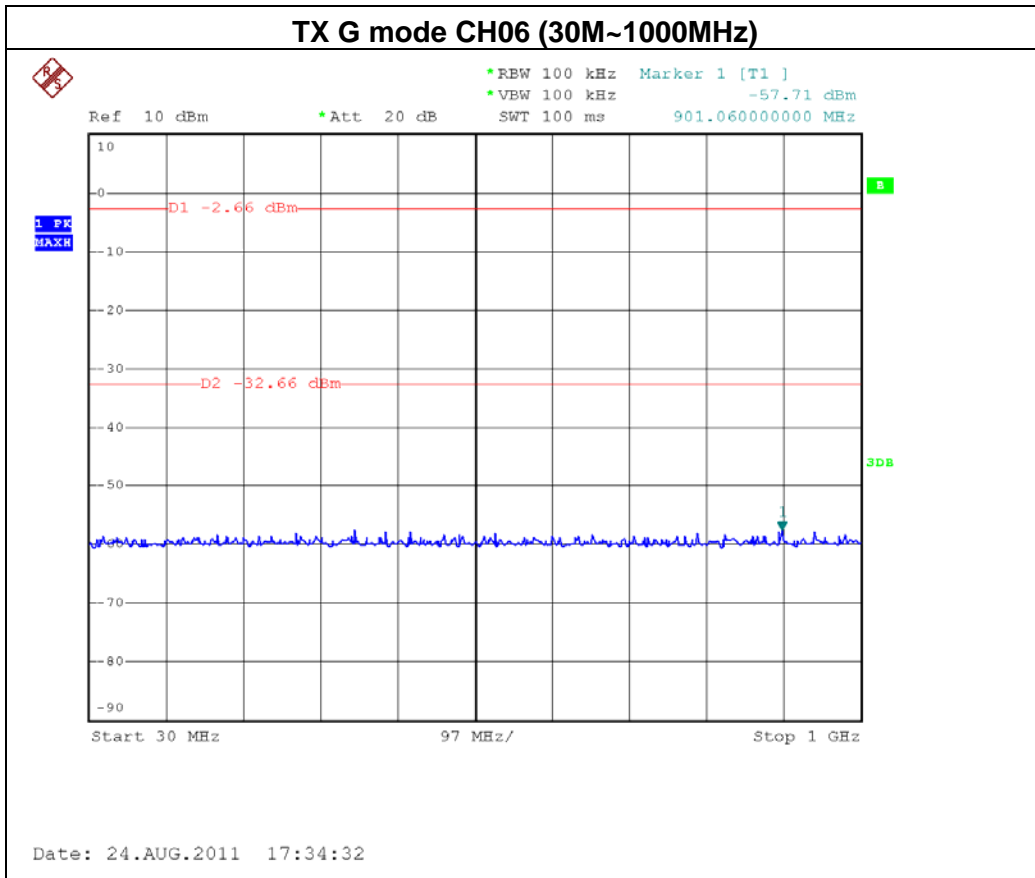

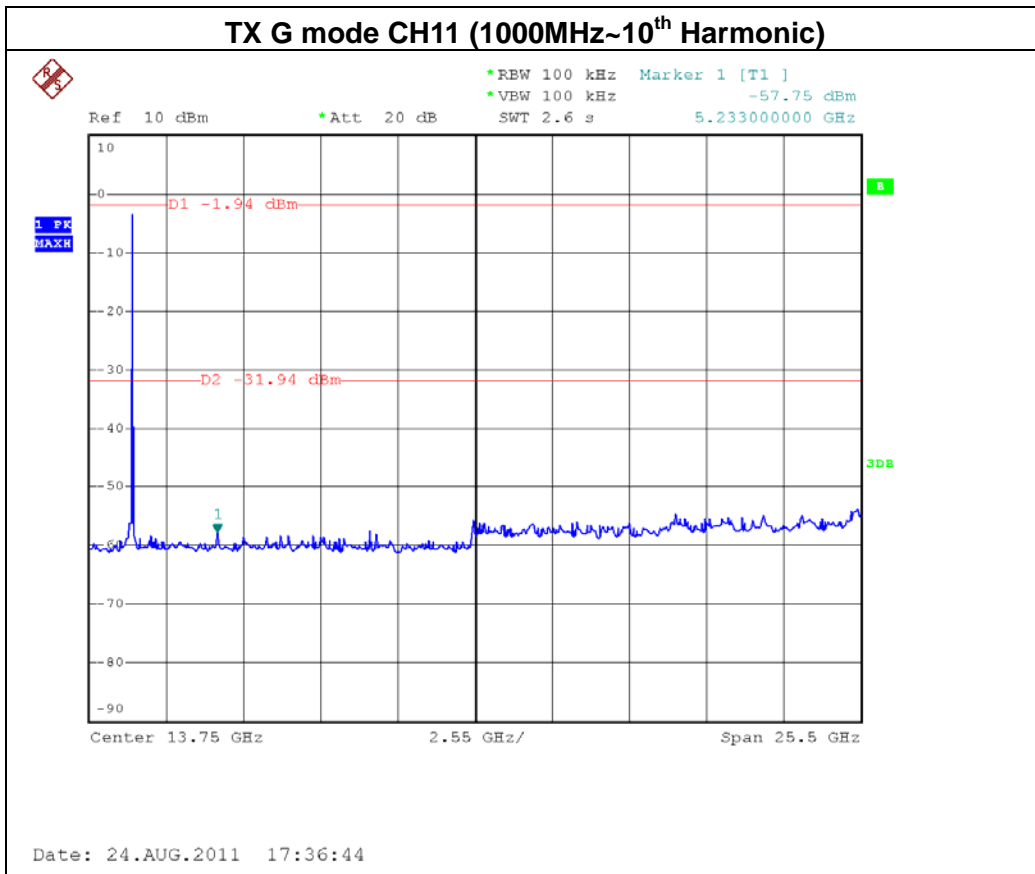
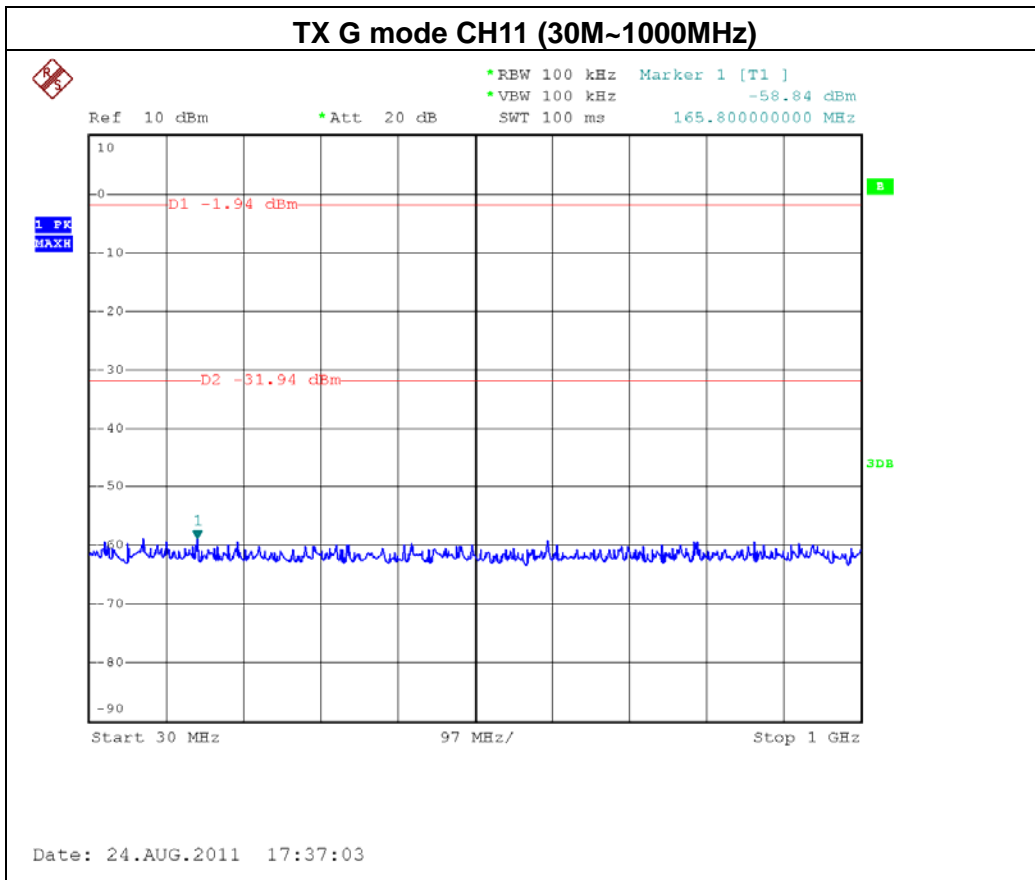



|               |  |                     |              |
|---------------|--|---------------------|--------------|
| EUT :         | 300Mbps Wireless-N USB Adapter                             | Model Name :        | WF-2109      |
| Temperature : | 24 °C  | Relative Humidity : | 60 %         |
| Pressure :    | 1016 hPa   | Test Voltage :      | AC 120V/60Hz |
| Test Mode :   | TX N-20M MODE / CH01, CH06 , CH11 <b>ANT1 (Worst Case)</b> |                     |              |

Channel of Worst Data: CH11

|   |  |
|---|--|
| The max. radio frequency power in any 100kHz bandwidth outside the frequency band | The max. radio frequency power in any 100 kHz bandwidth within the frequency band. |
|---|--|

| FREQUENCY(MHz) | POWER(dBm) | FREQUENCY(MHz) | POWER(dBm) |
|----------------|------------|----------------|------------|
| 2390.00        | -47.44     | 2487.20        | -46.27     |

Result

In any 100kHz bandwidth outside the frequency band, the radio frequency power is at least 30dB below that in the 100kHz bandwidth within the band that contains the highest level of the desired power.

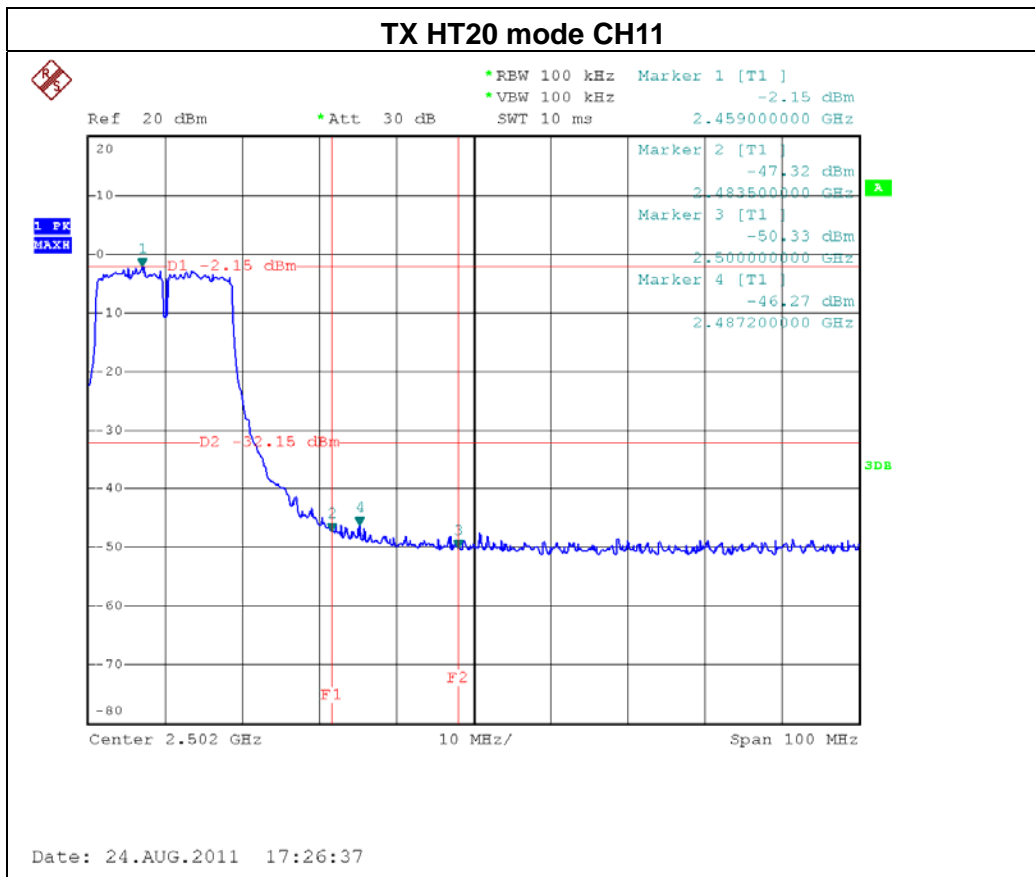
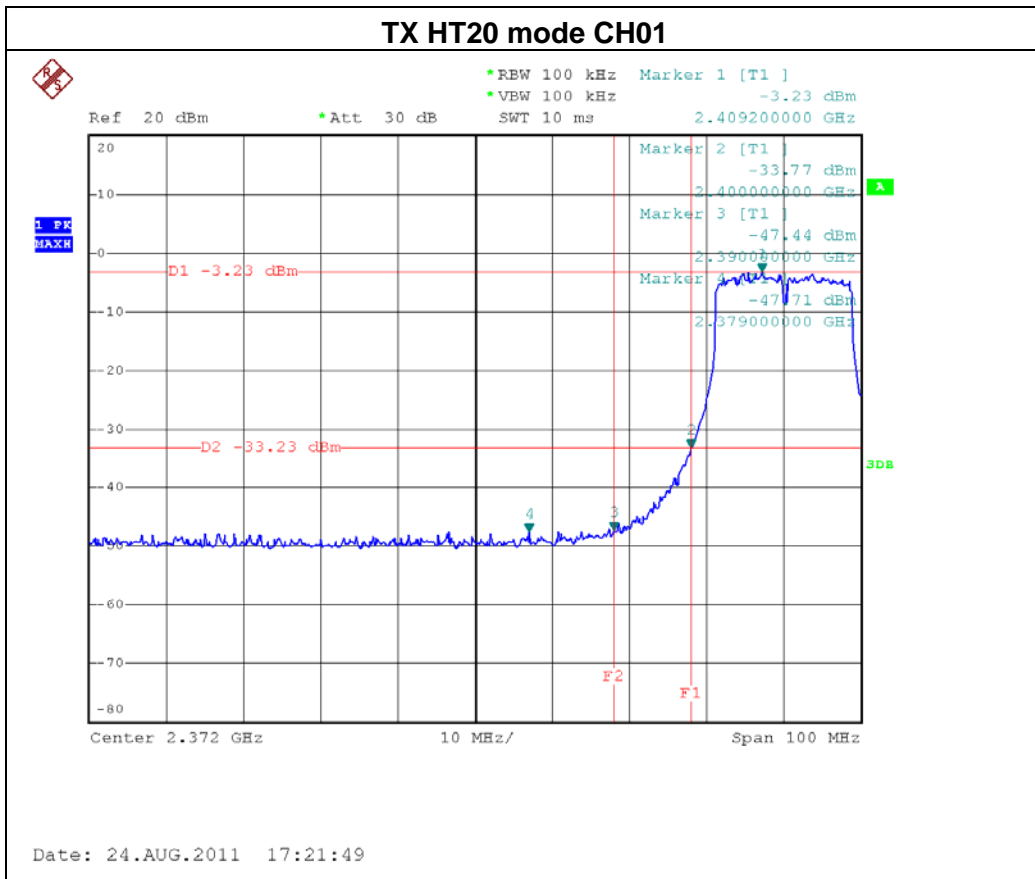

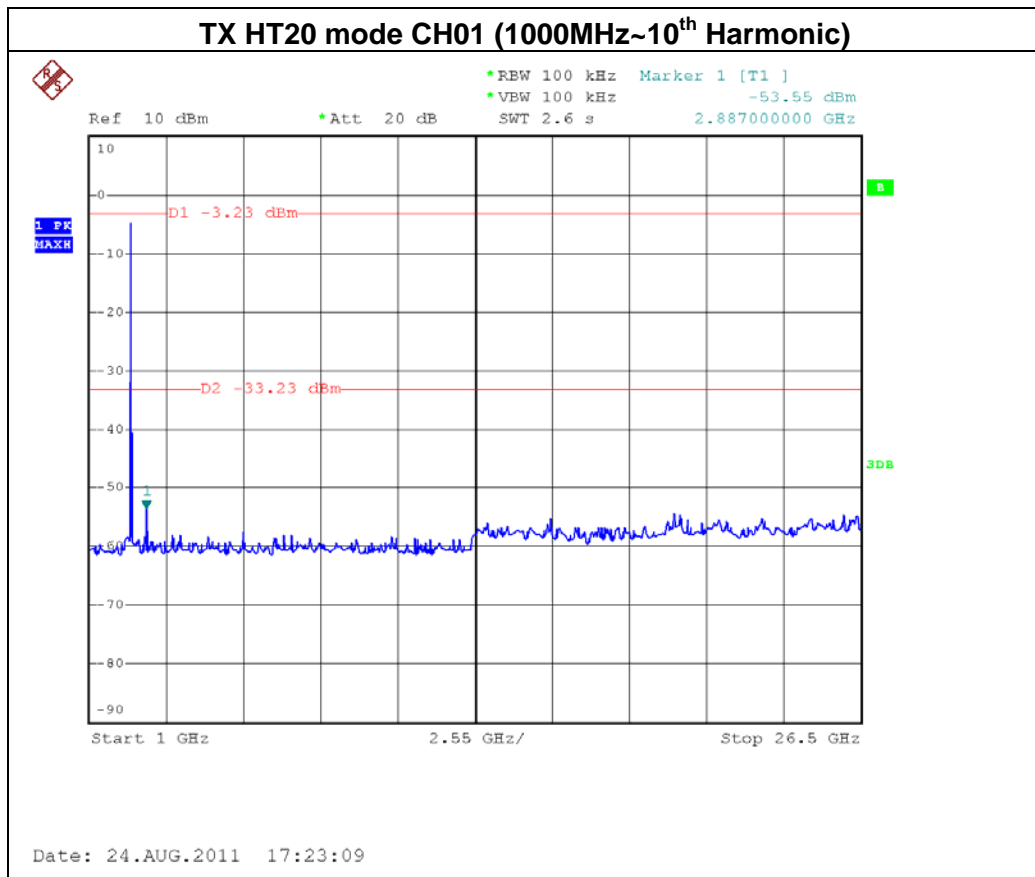
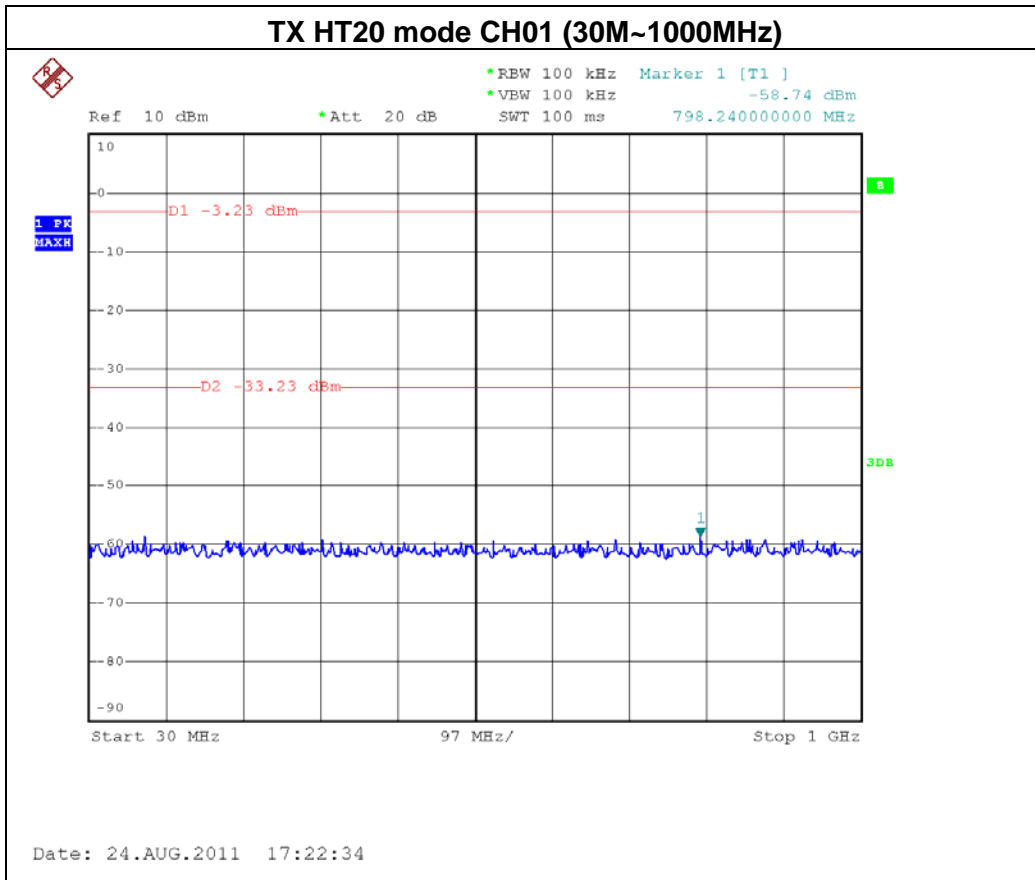

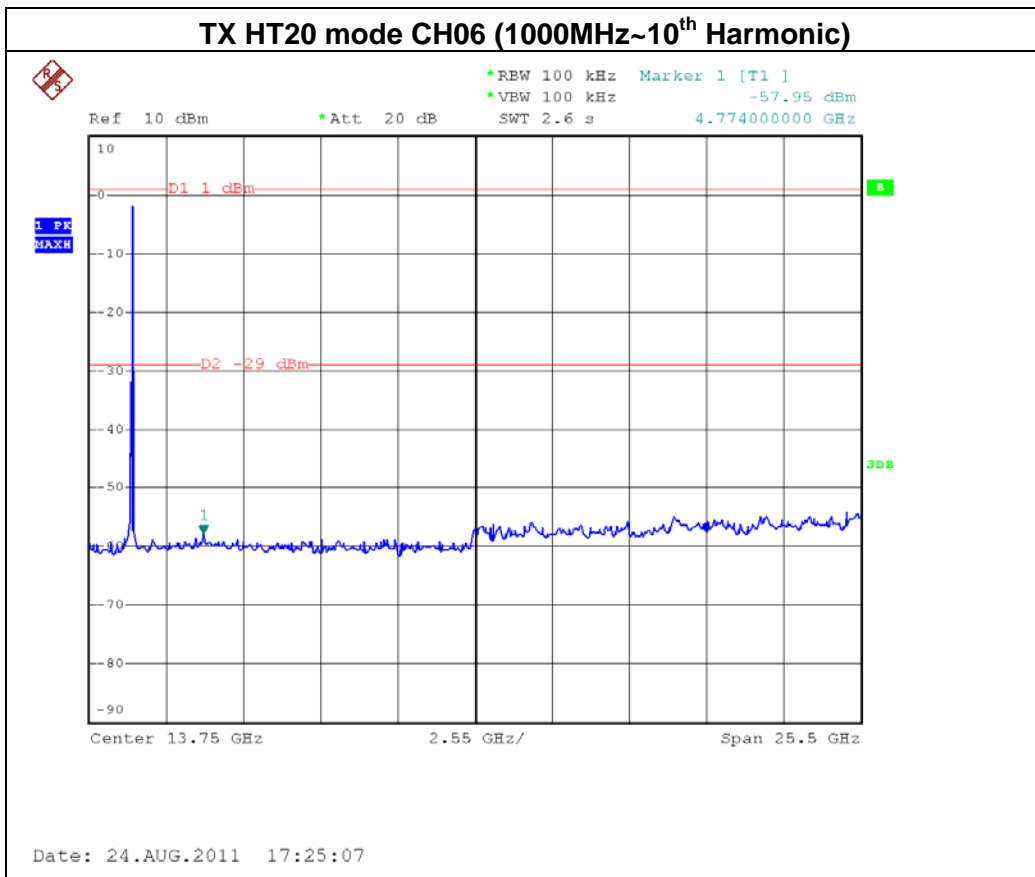
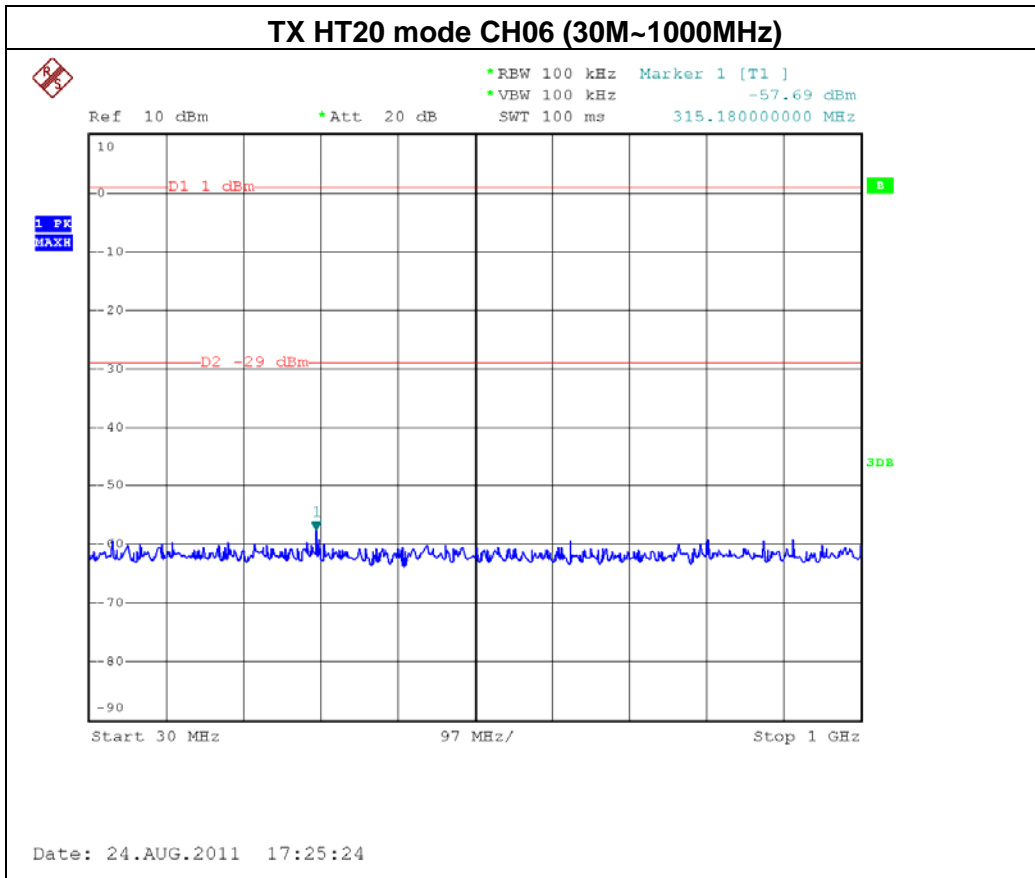

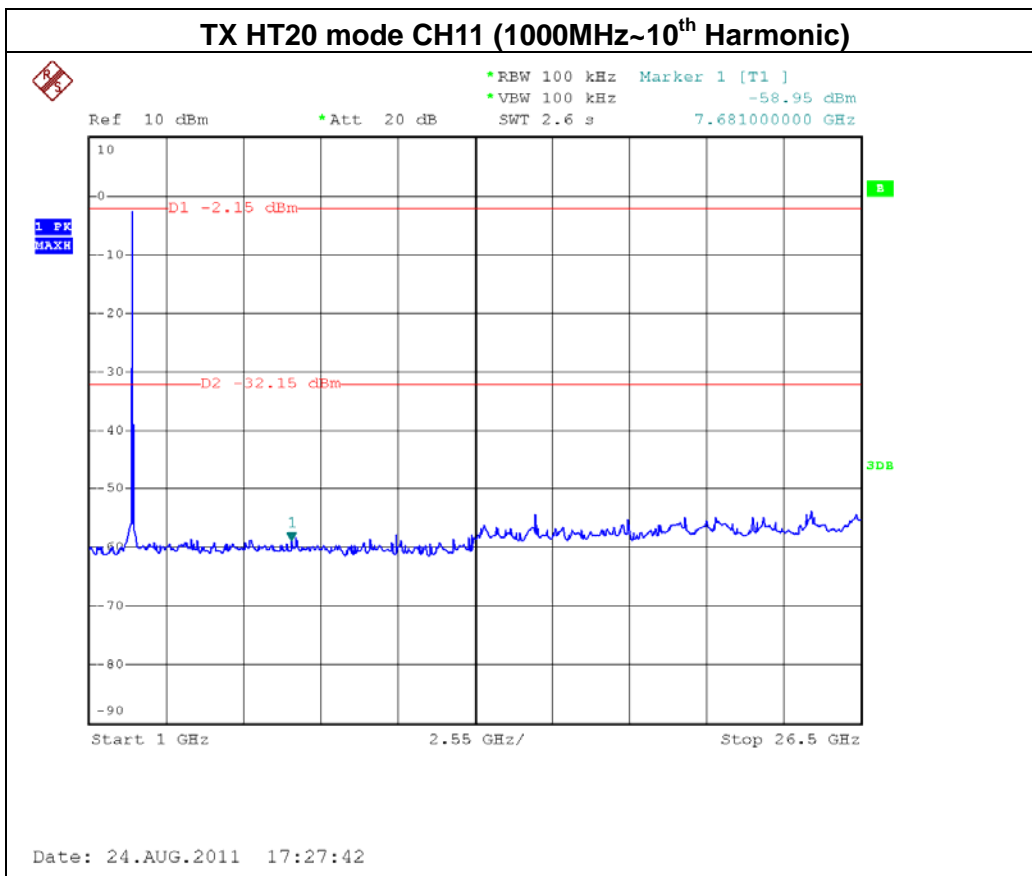
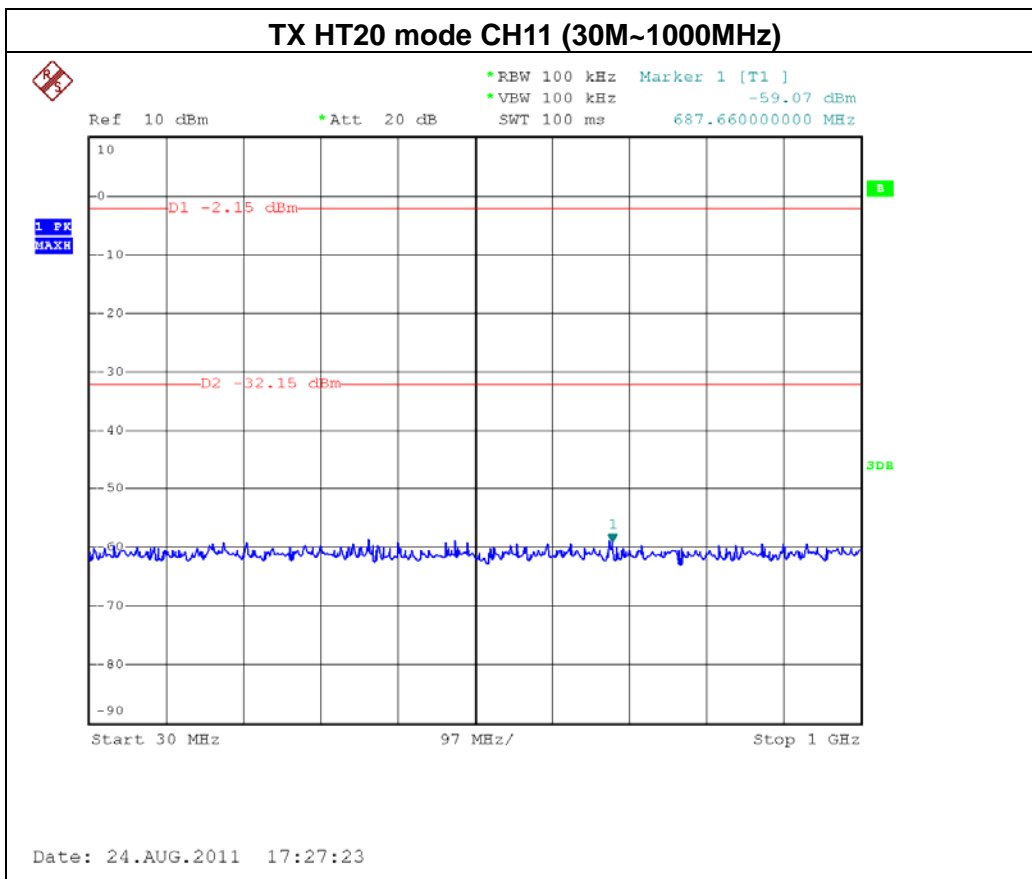



|               |   |                     |              |
|---------------|---|---------------------|--------------|
| EUT :         | 300Mbps Wireless-N USB Adapter                | Model Name :        | WF-2109      |
| Temperature : | 24 °C   | Relative Humidity : | 60 %         |
| Pressure :    | 1016 hPa                                      | Test Voltage :      | AC 120V/60Hz |
| Test Mode :   | TX N-20M MODE / CH01, CH06 , CH11 <b>ANT2</b> |                     |              |

Channel of Worst Data: CH11

|   |  |
|---|--|
| The max. radio frequency power in any 100kHz bandwidth outside the frequency band | The max. radio frequency power in any 100 kHz bandwidth within the frequency band. |
|---|--|

| FREQUENCY(MHz) | POWER(dBm) | FREQUENCY(MHz) | POWER(dBm) |
|----------------|------------|----------------|------------|
| 2378.40        | -46.88     | 2485.80        | -46.83     |

Result

In any 100kHz bandwidth outside the frequency band, the radio frequency power is at least 30dB below that in the 100kHz bandwidth within the band that contains the highest level of the desired power.



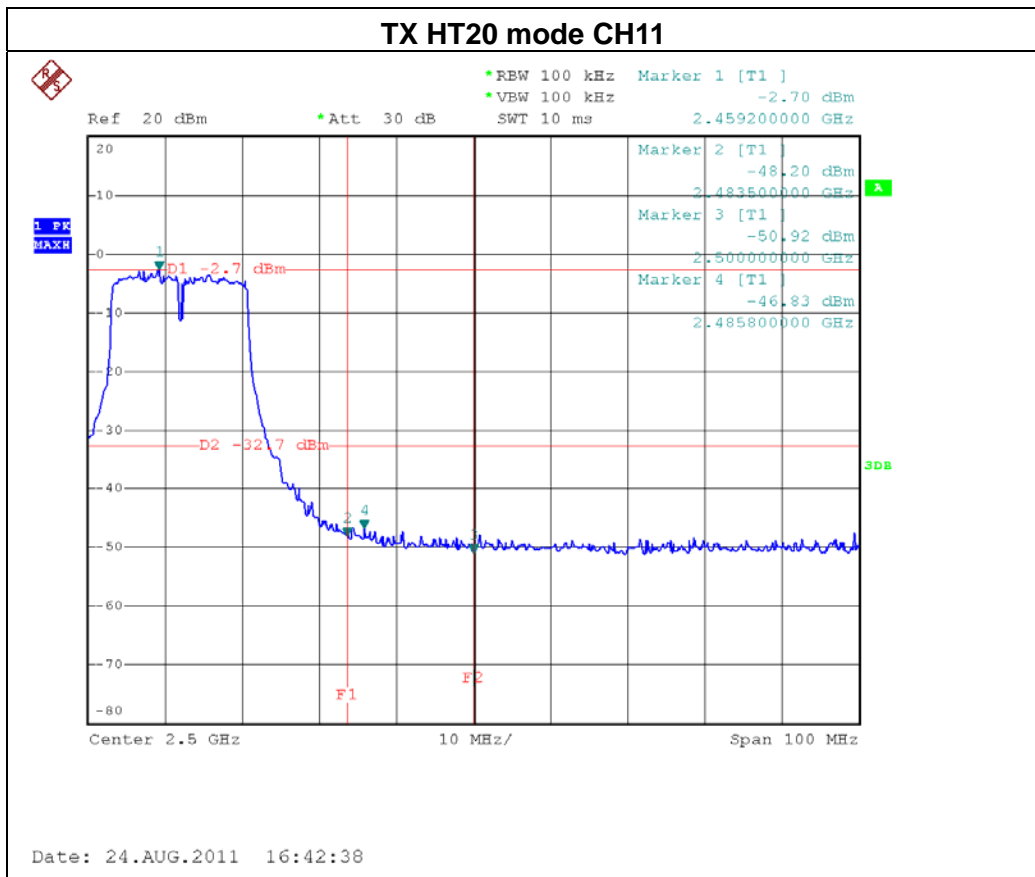
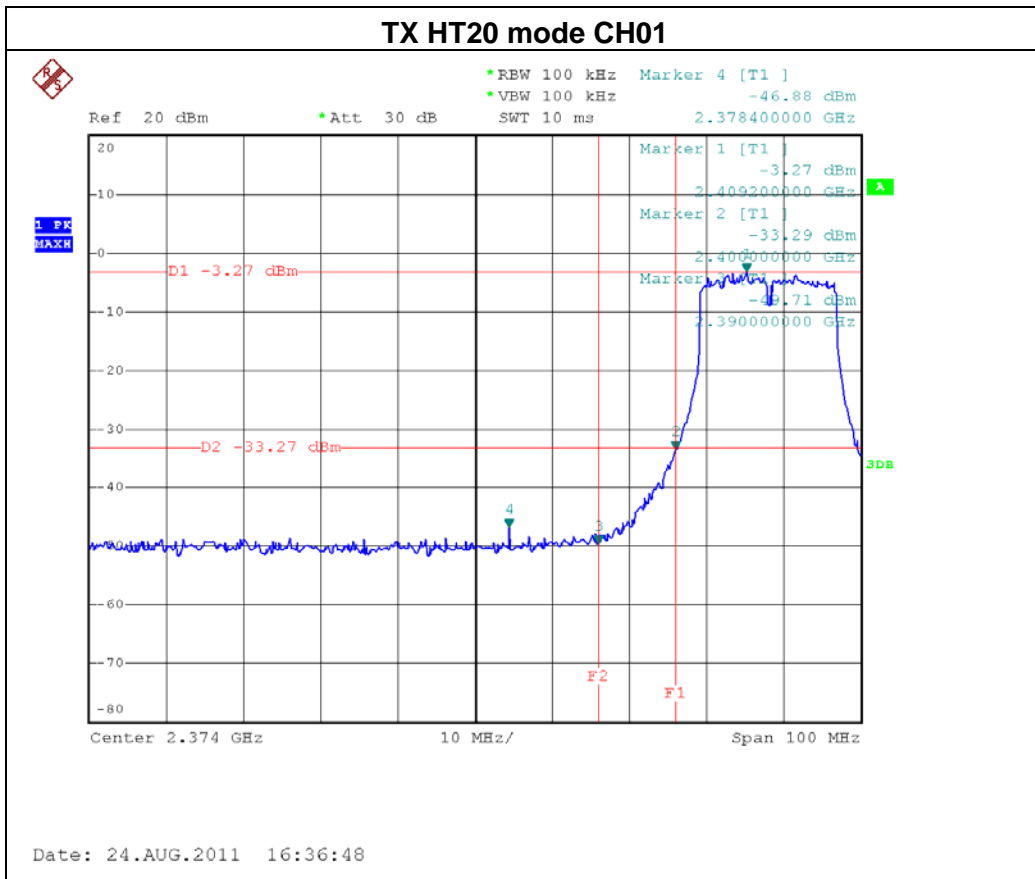

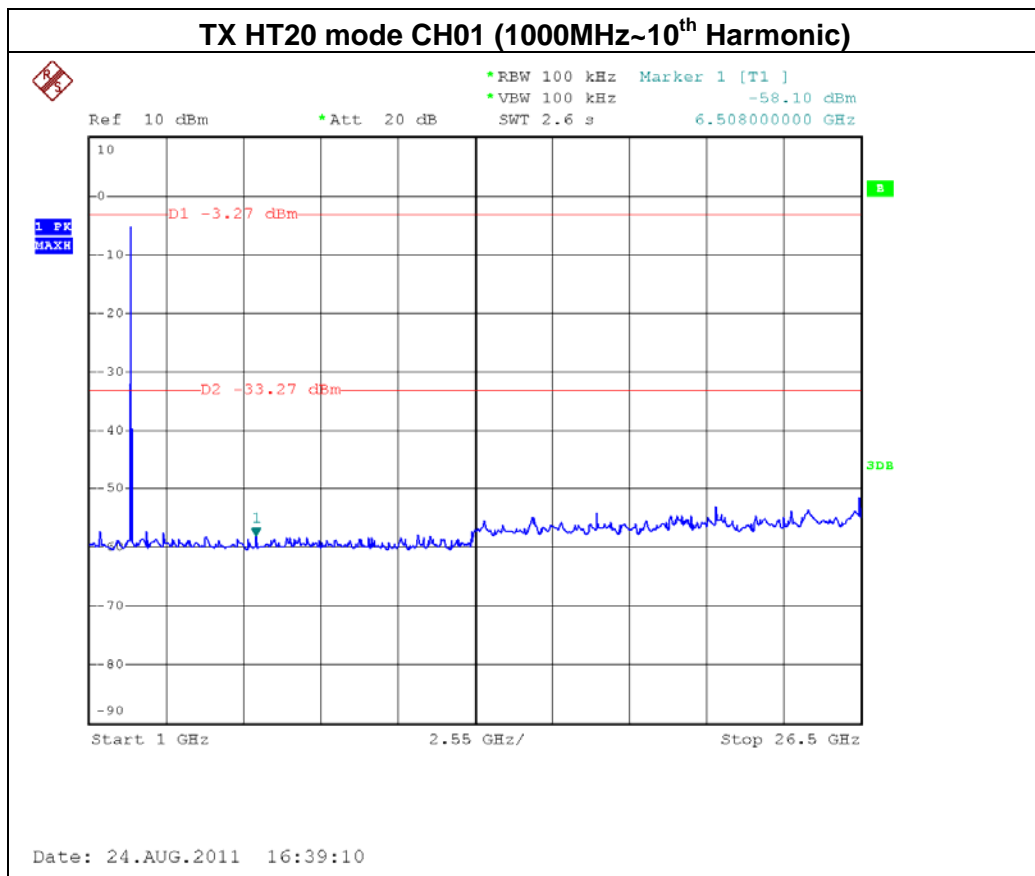
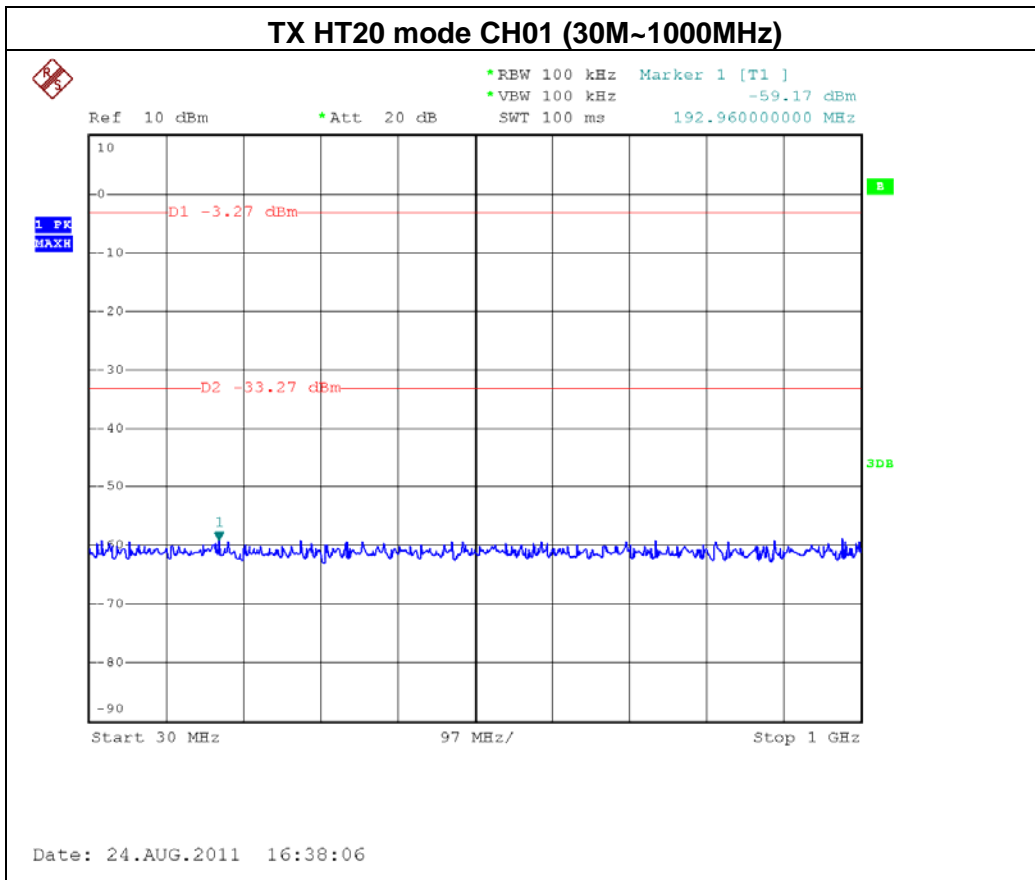

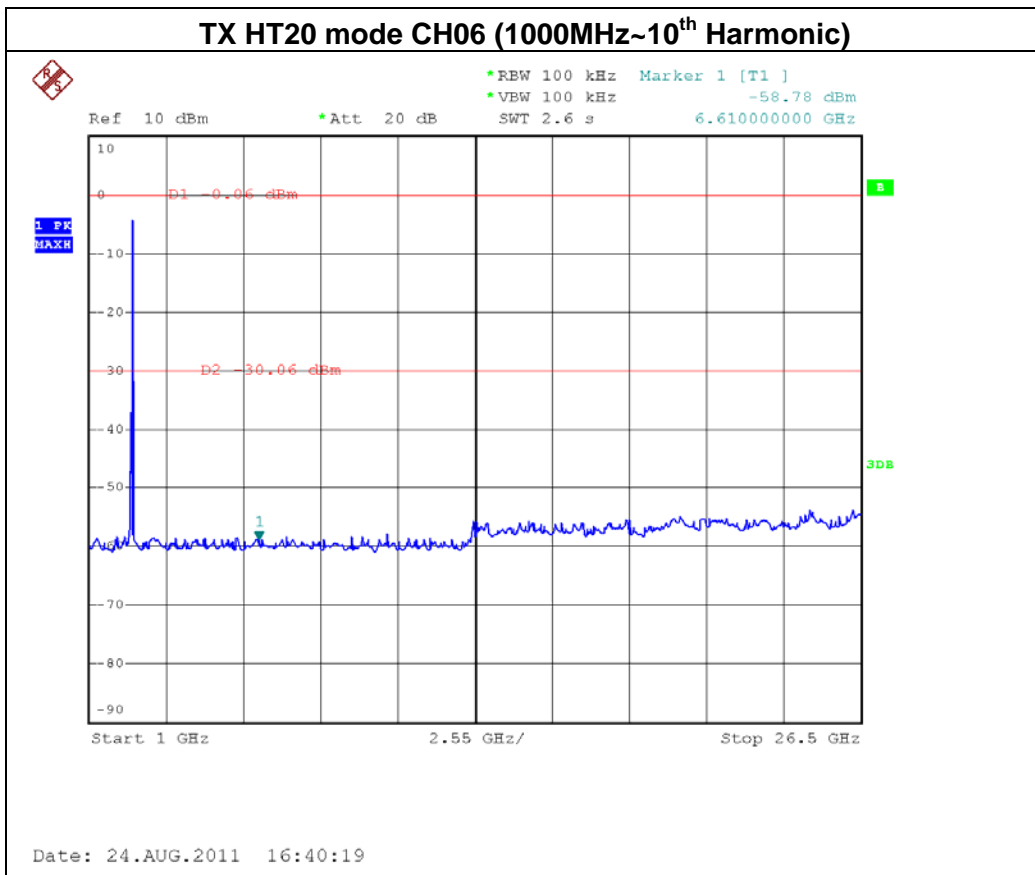
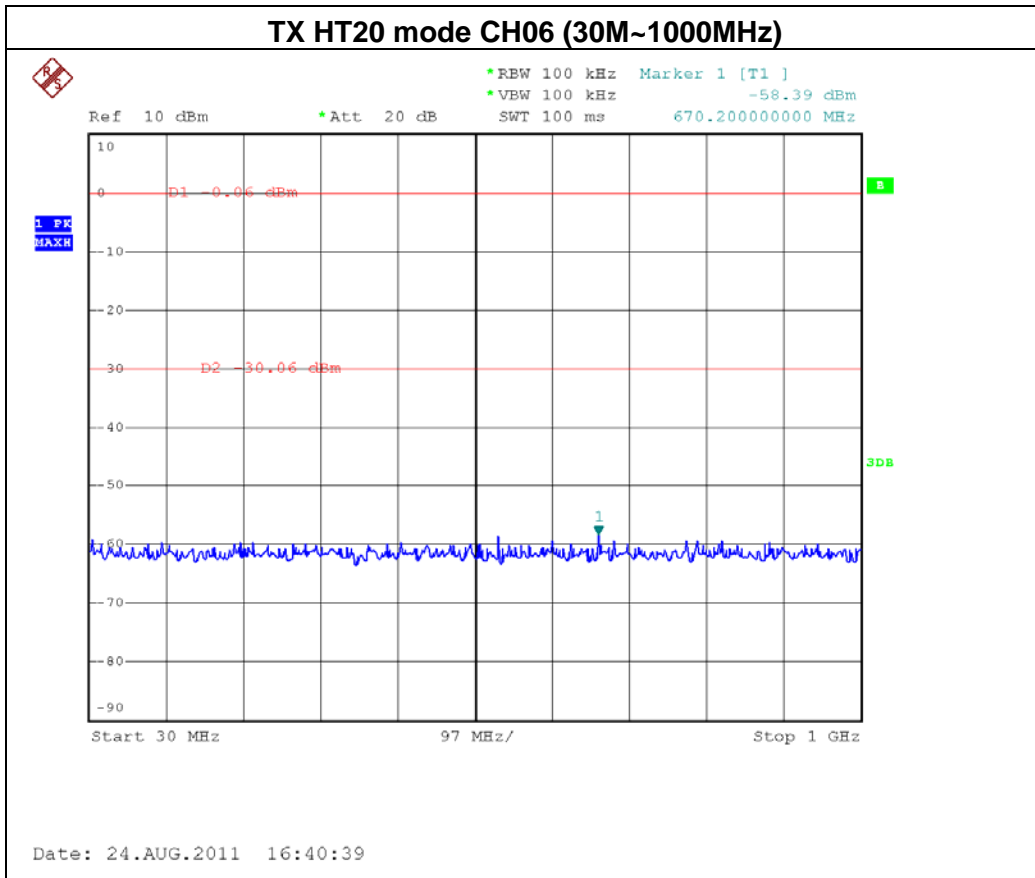

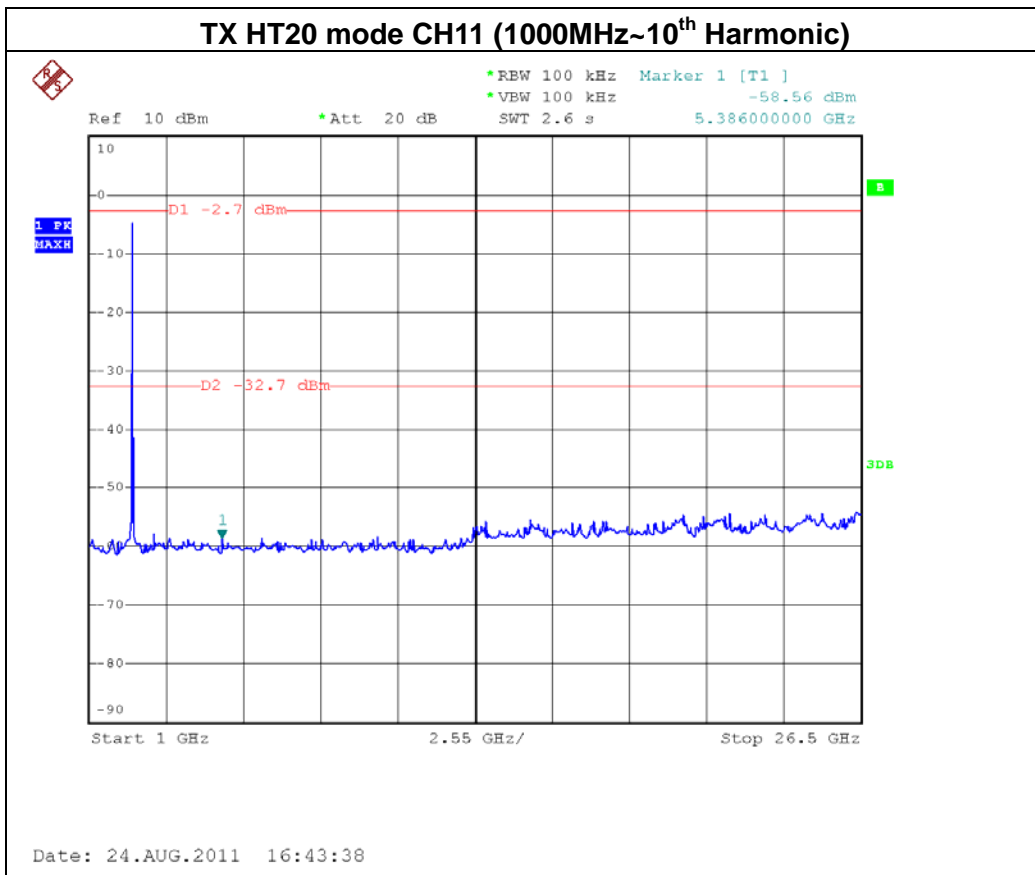
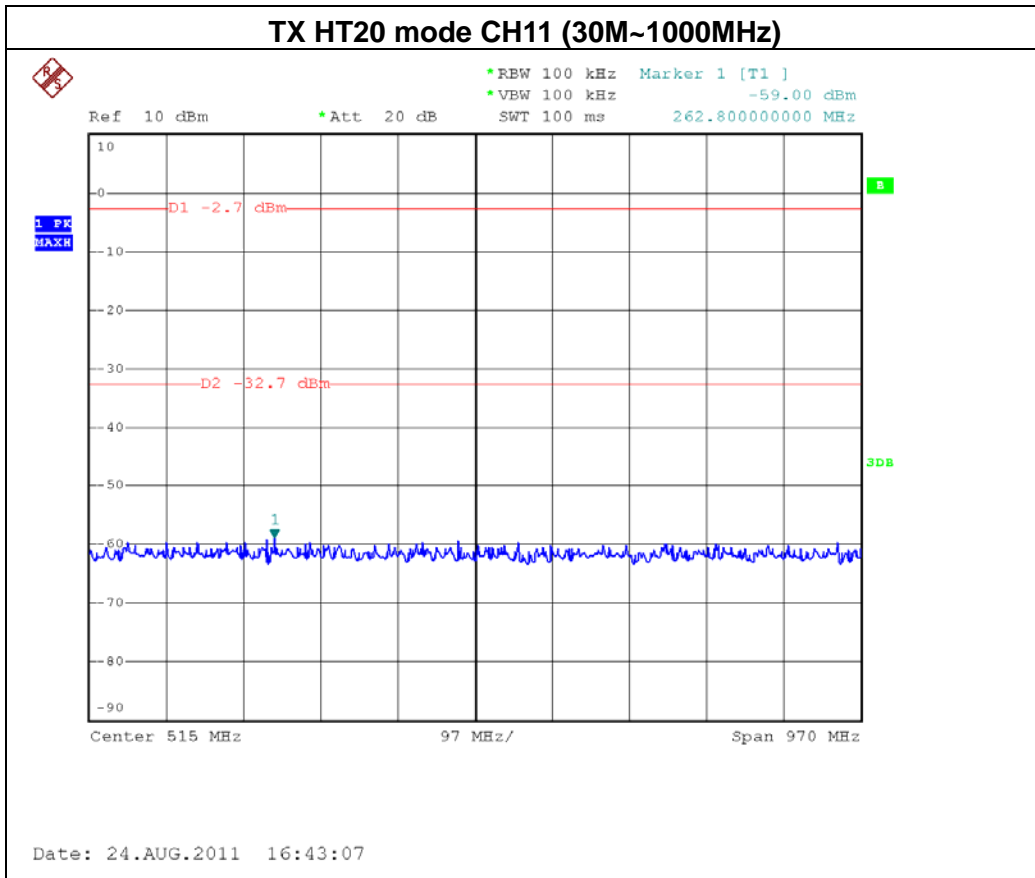



|               |   |                     |              |
|---------------|---|---------------------|--------------|
| EUT :         | 300Mbps Wireless-N USB Adapter              | Model Name :        | WF-2109      |
| Temperature : | 24 °C                                       | Relative Humidity : | 60 %         |
| Pressure :    | 1016 hPa                                    | Test Voltage :      | AC 120V/60Hz |
| Test Mode :   | TX N-40M MODE /CH03, CH06, CH09 <b>ANT1</b> |                     |              |

Channel of Worst Data: CH03

|   |  |
|---|--|
| The max. radio frequency power in any 100kHz bandwidth outside the frequency band | The max. radio frequency power in any 100 kHz bandwidth within the frequency band. |
|---|--|

| FREQUENCY(MHz) | POWER(dBm) | FREQUENCY(MHz) | POWER(dBm) |
|----------------|------------|----------------|------------|
| 2390.00        | -44.73     | 2485.40        | -46.37     |

Result

In any 100kHz bandwidth outside the frequency band, the radio frequency power is at least 30dB below that in the 100kHz bandwidth within the band that contains the highest level of the desired power.

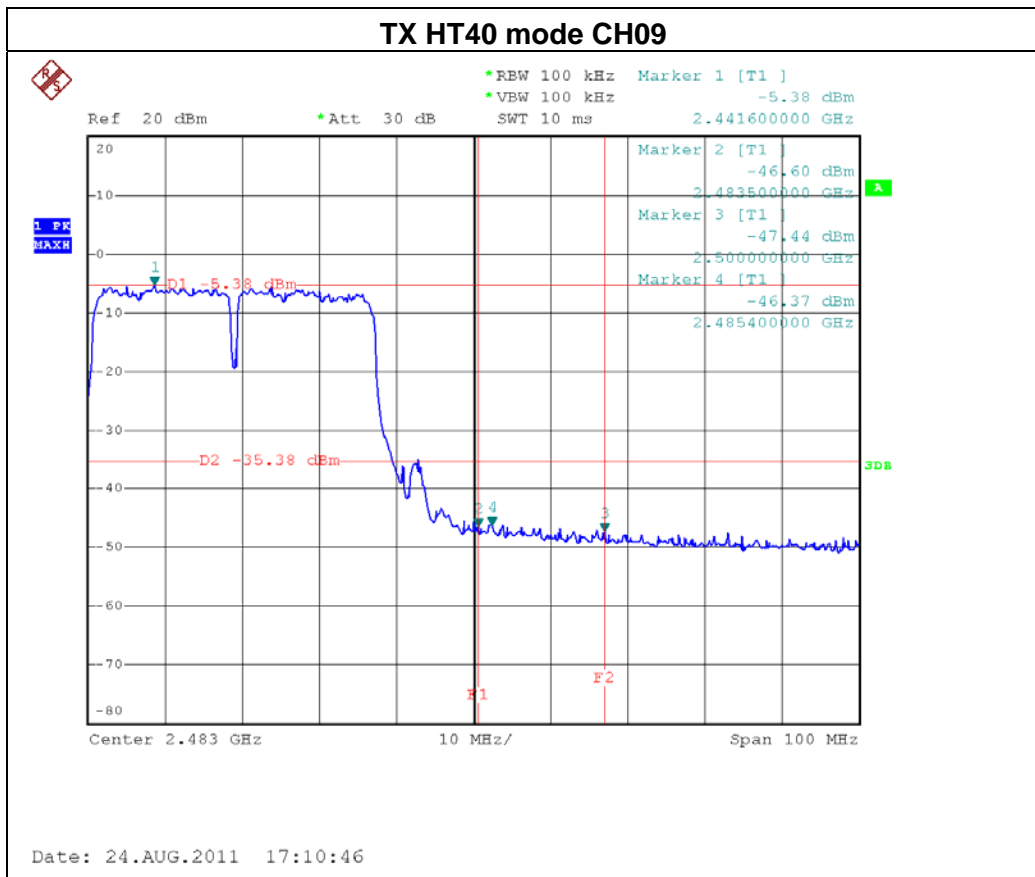
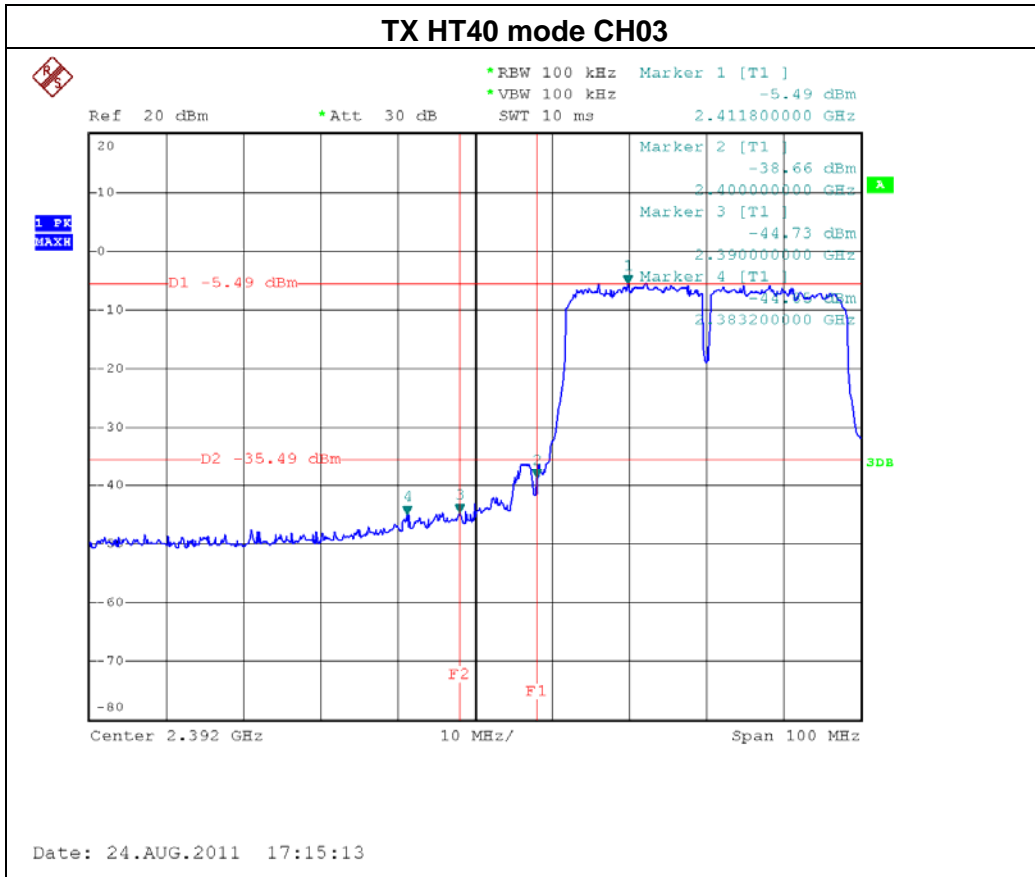

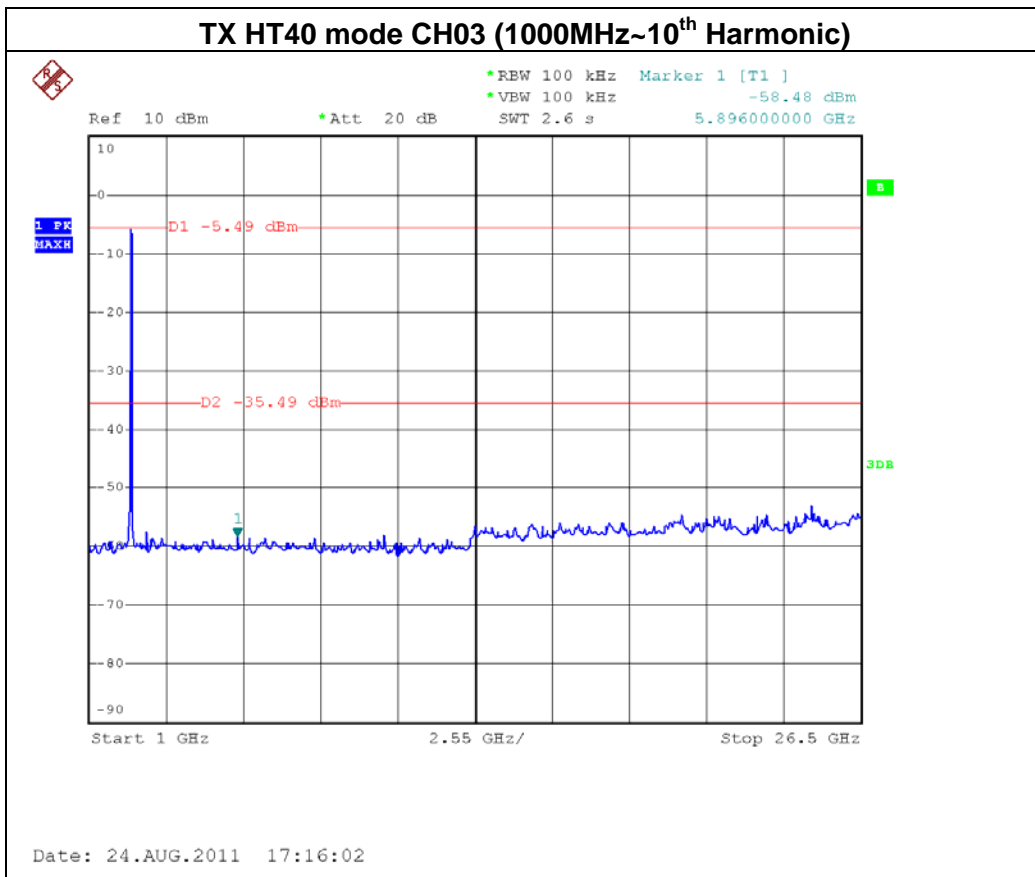
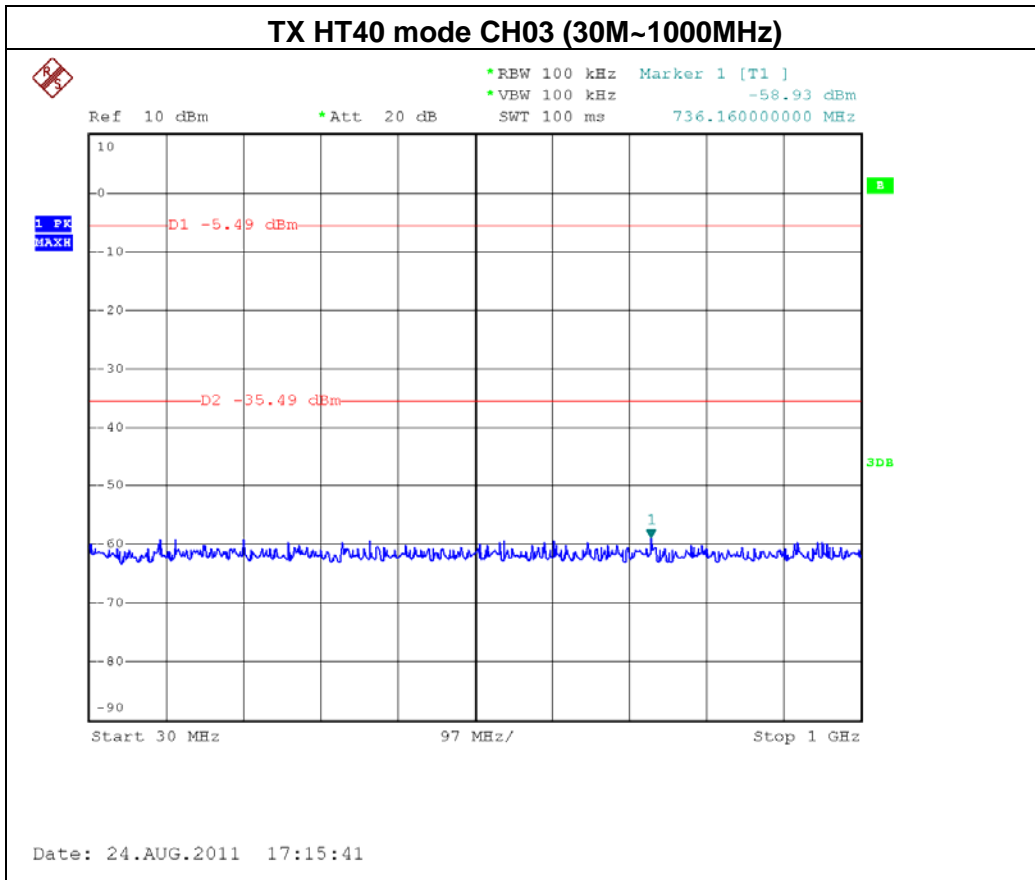

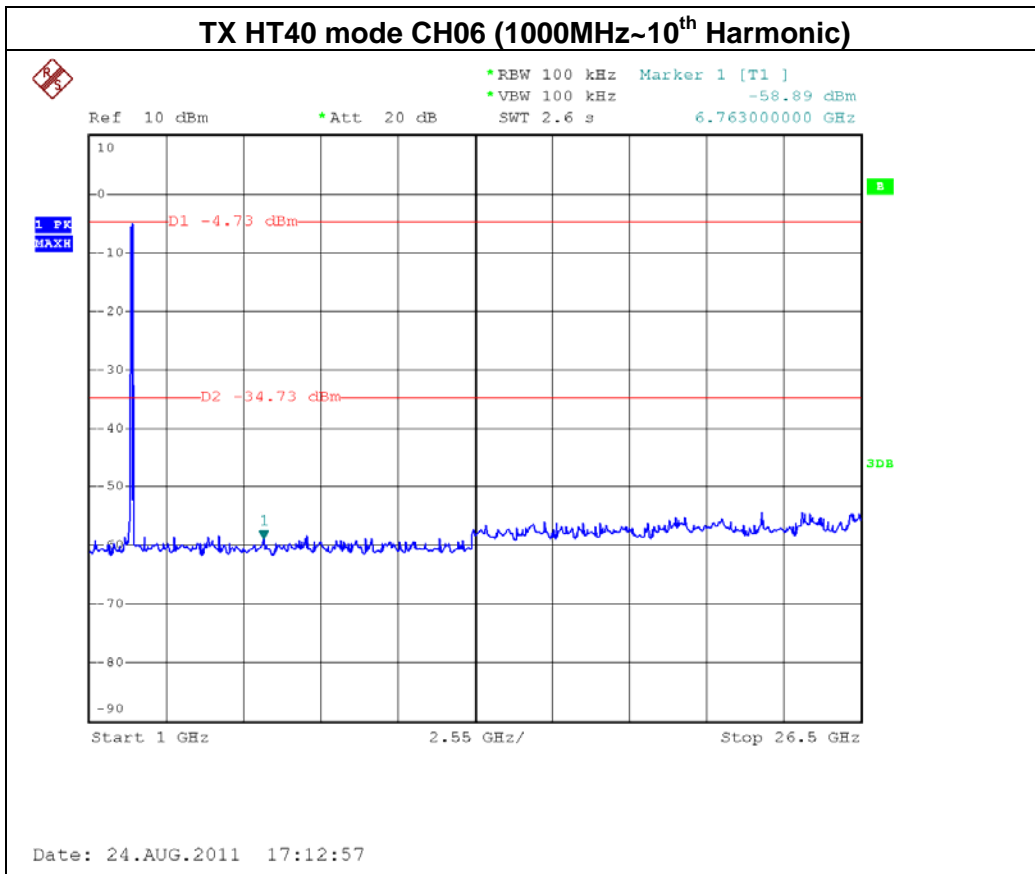
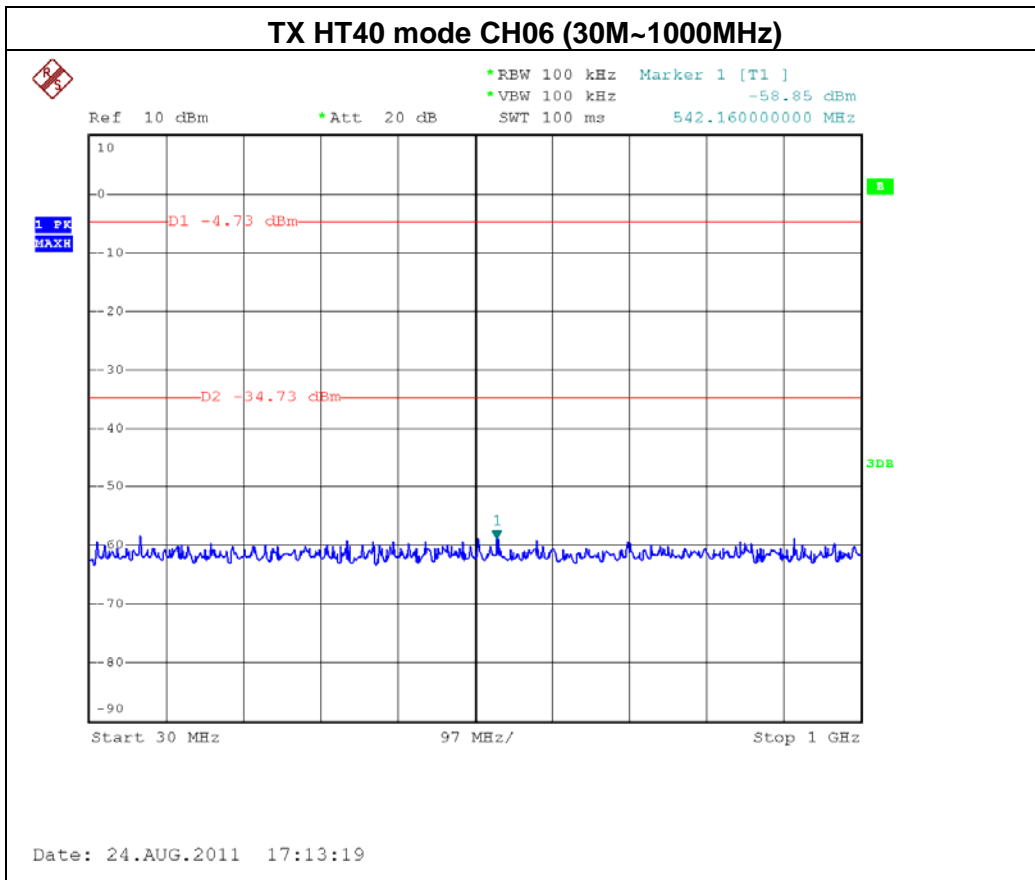



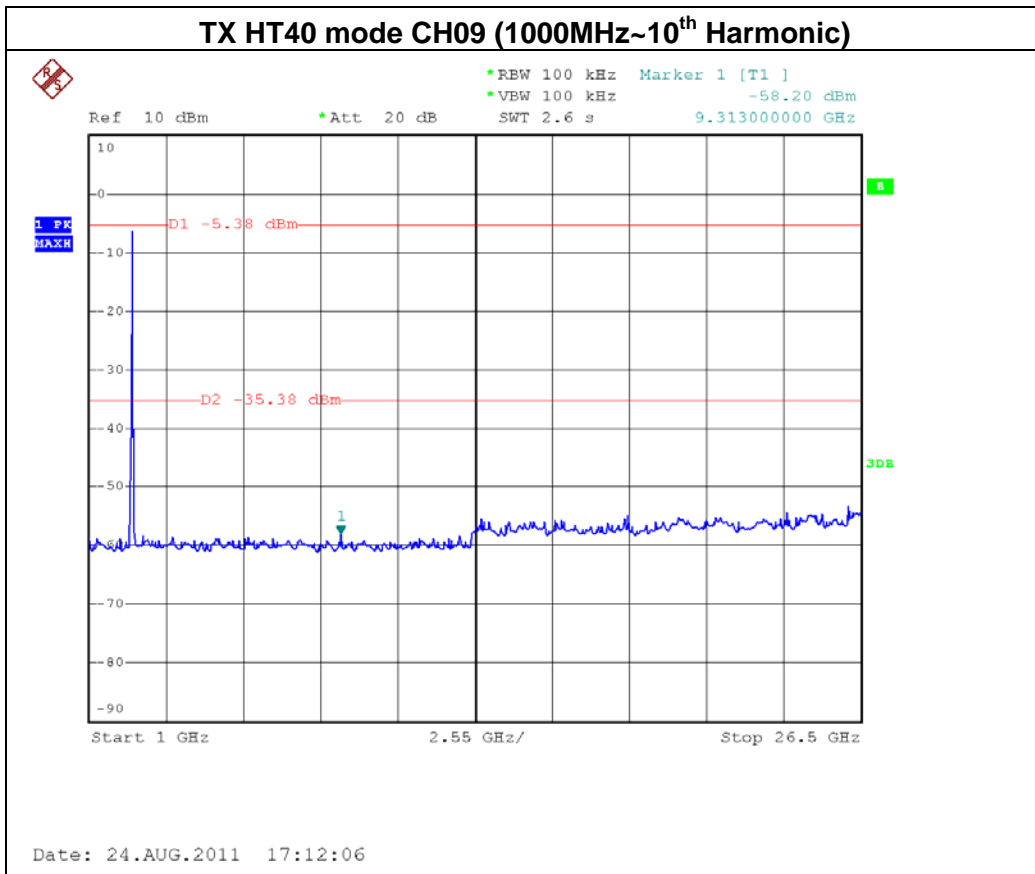
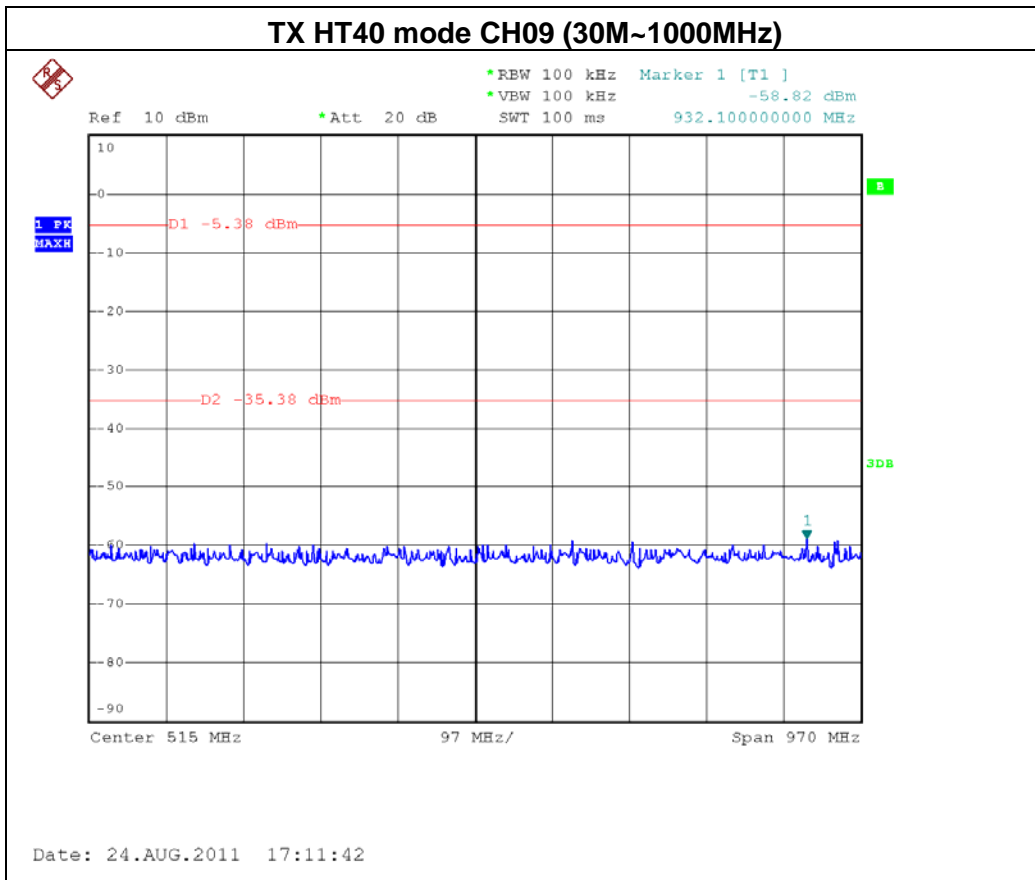



|               |  |                     |              |
|---------------|--|---------------------|--------------|
| EUT :         | 300Mbps Wireless-N USB Adapter                           | Model Name :        | WF-2109      |
| Temperature : | 24 °C  | Relative Humidity : | 60 %         |
| Pressure :    | 1016 hPa   | Test Voltage :      | AC 120V/60Hz |
| Test Mode :   | TX N-40M MODE /CH03, CH06, CH09 <b>ANT2 (Worst Case)</b> |                     |              |

| Channel of Worst Data: CH09   |            |  |            |
|---|------------|--|------------|
| The max. radio frequency power in any 100kHz bandwidth outside the frequency band |            | The max. radio frequency power in any 100 kHz bandwidth within the frequency band. |            |
| FREQUENCY(MHz)  | POWER(dBm) | FREQUENCY(MHz)   | POWER(dBm) |
| 2388.20   | -44.49     | 2485.20  | -44.36     |

**Result**

In any 100kHz bandwidth outside the frequency band, the radio frequency power is at least 30dB below that in the 100kHz bandwidth within the band that contains the highest level of the desired power.

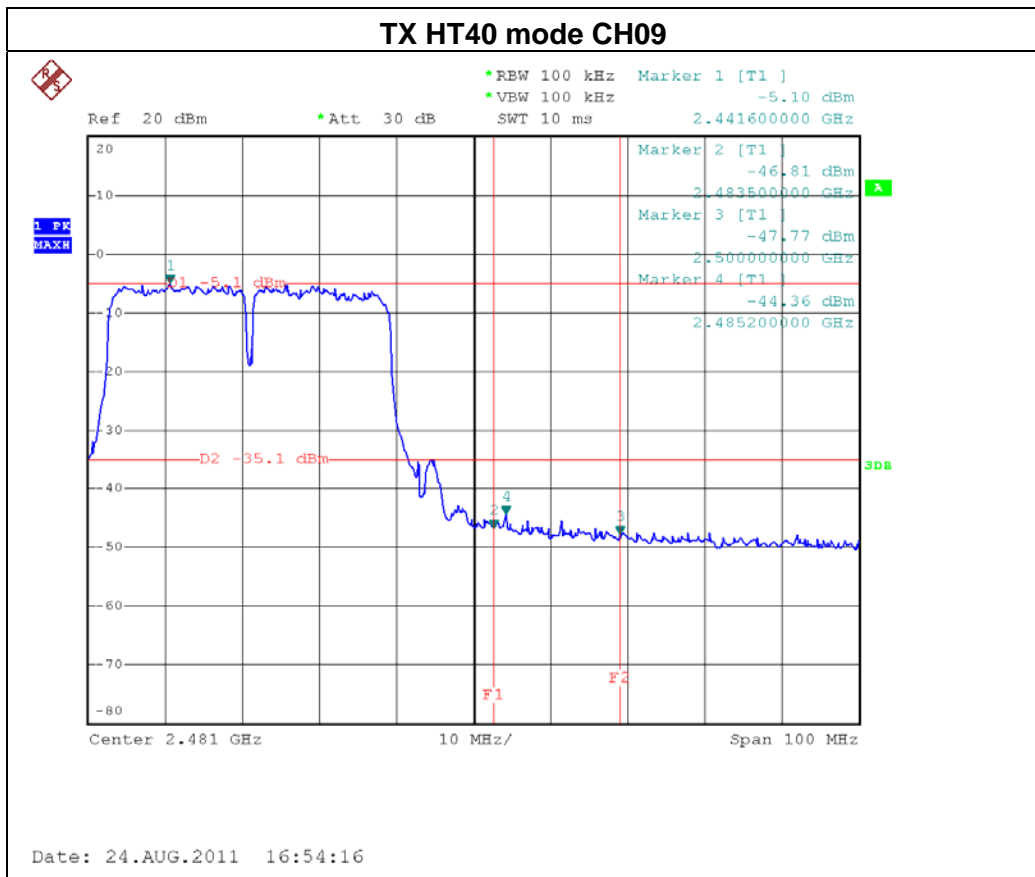
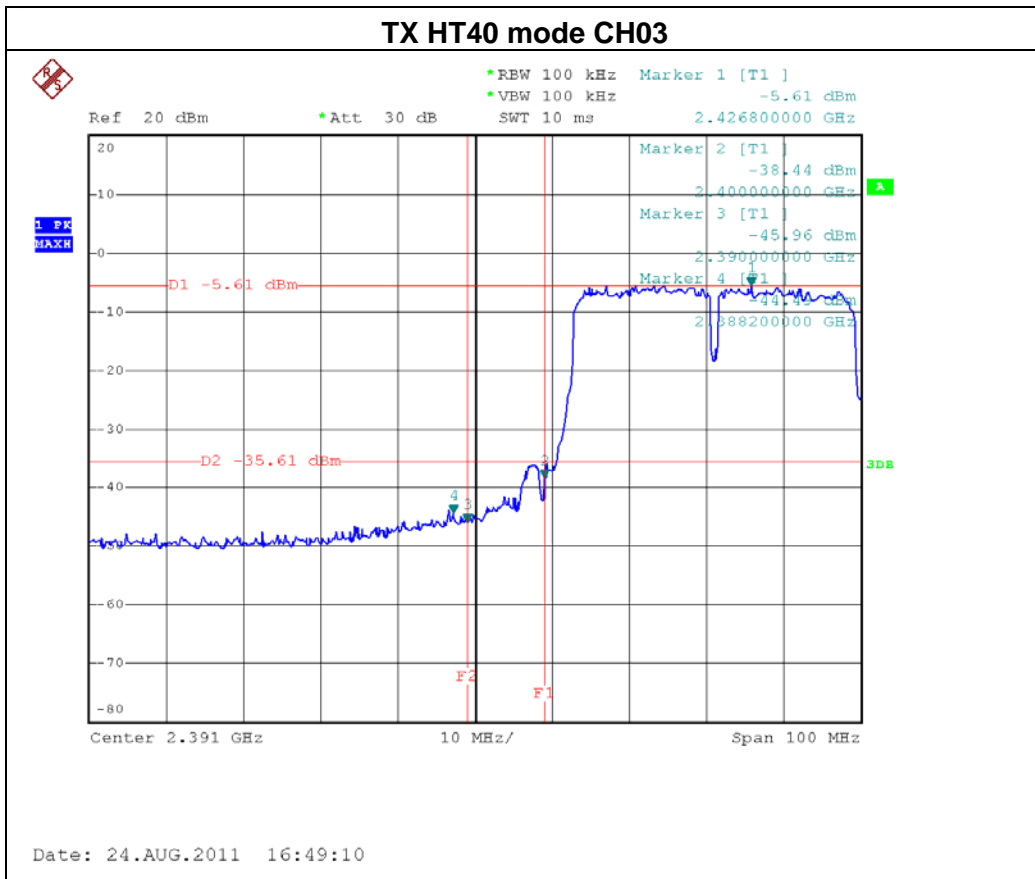

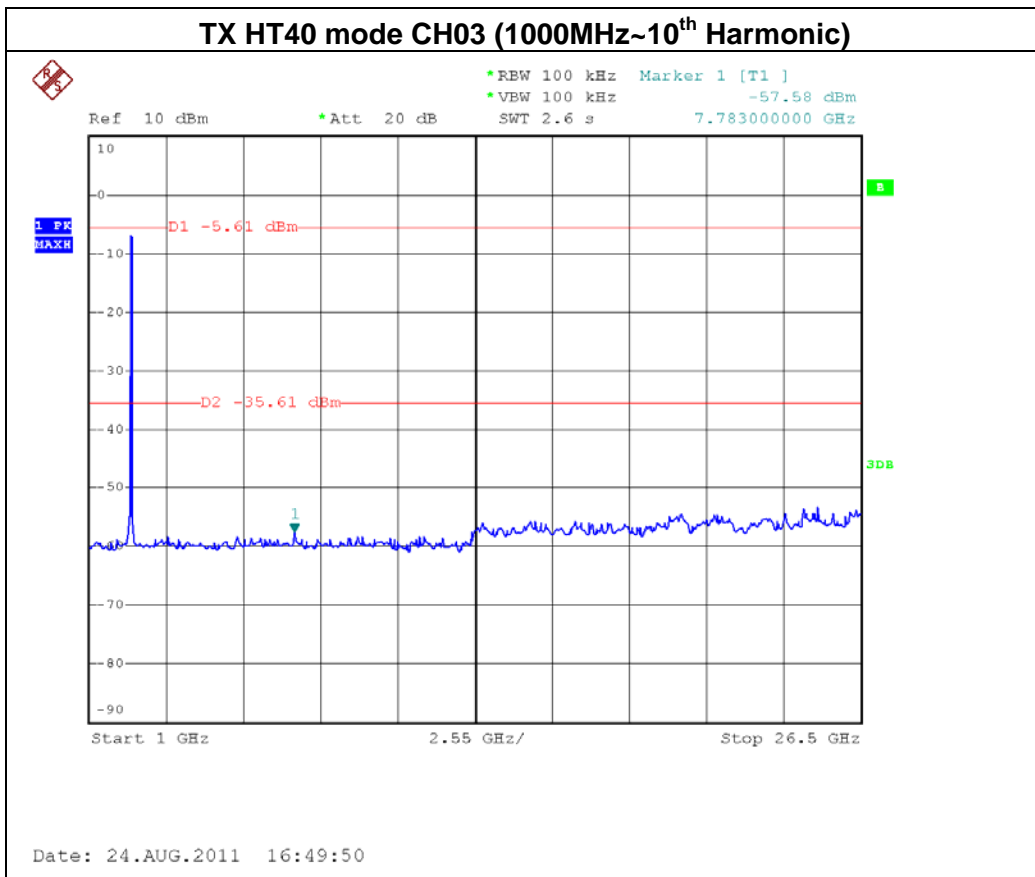
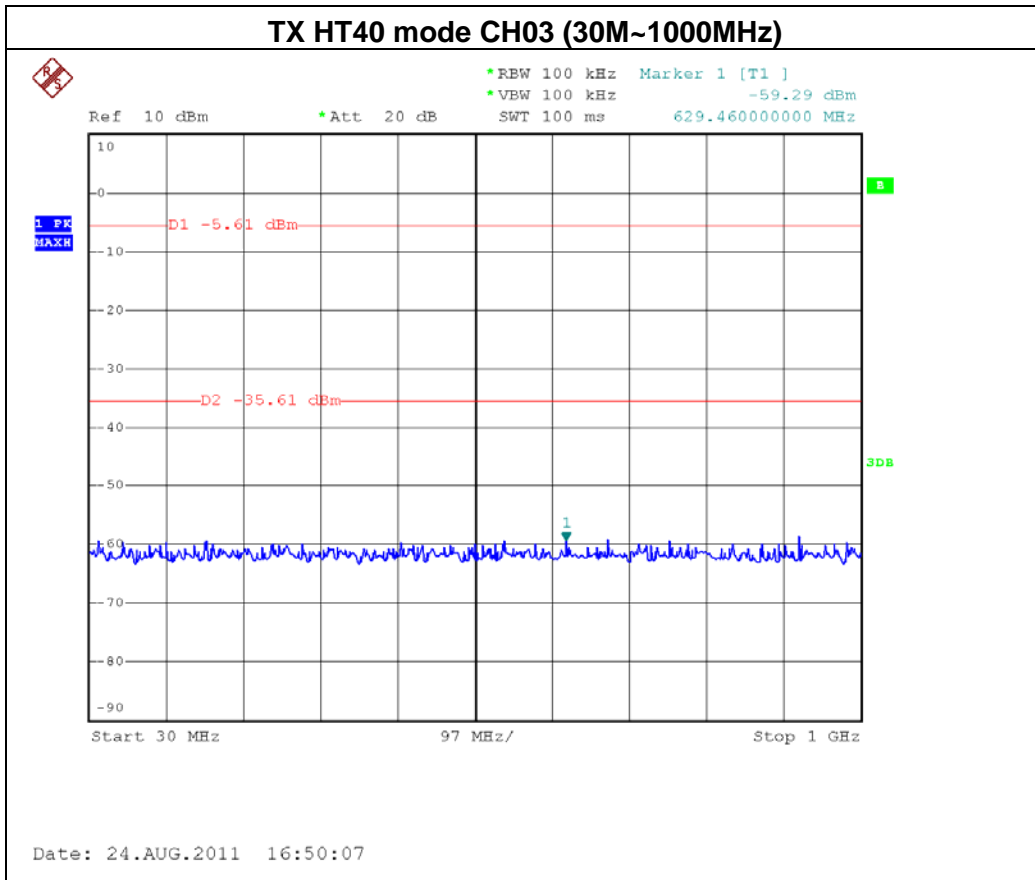

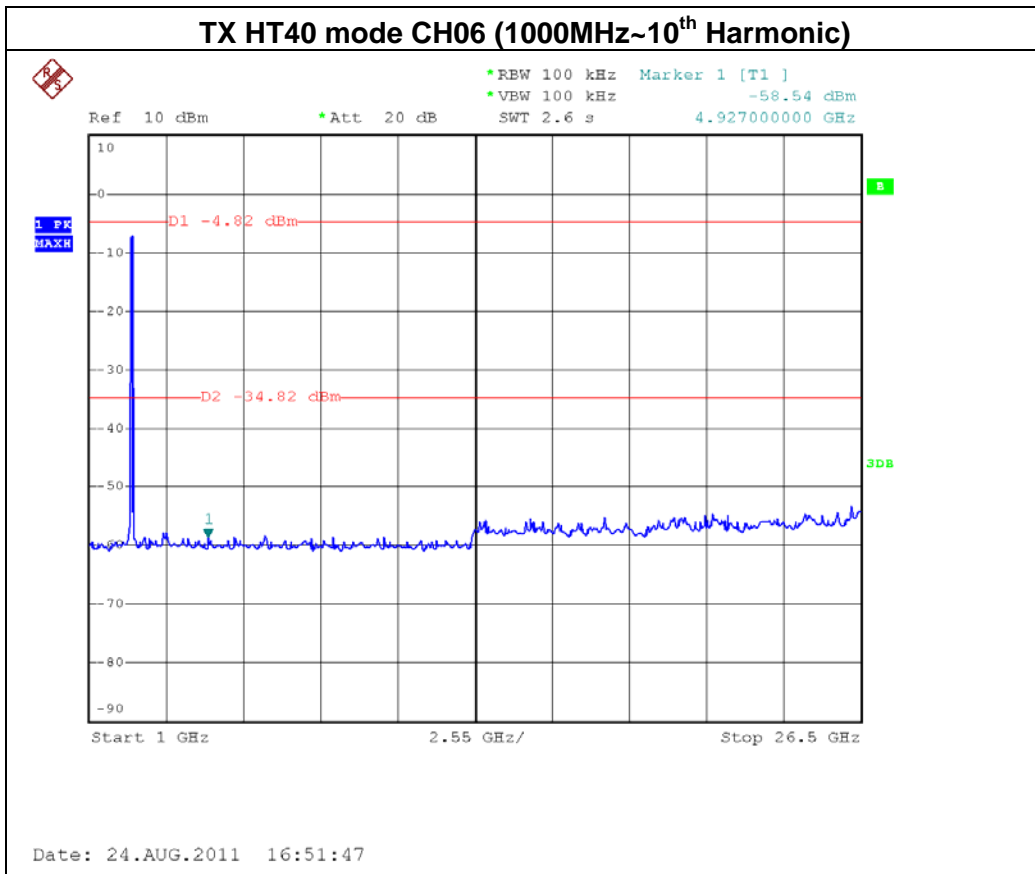
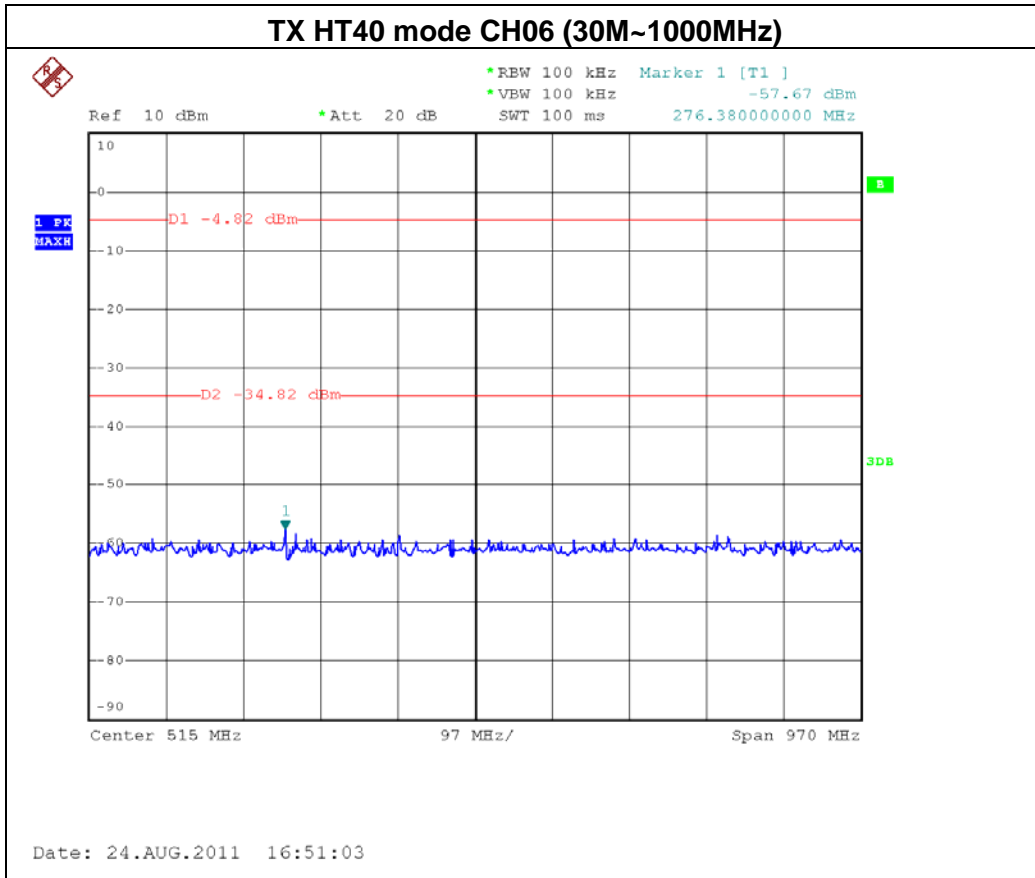

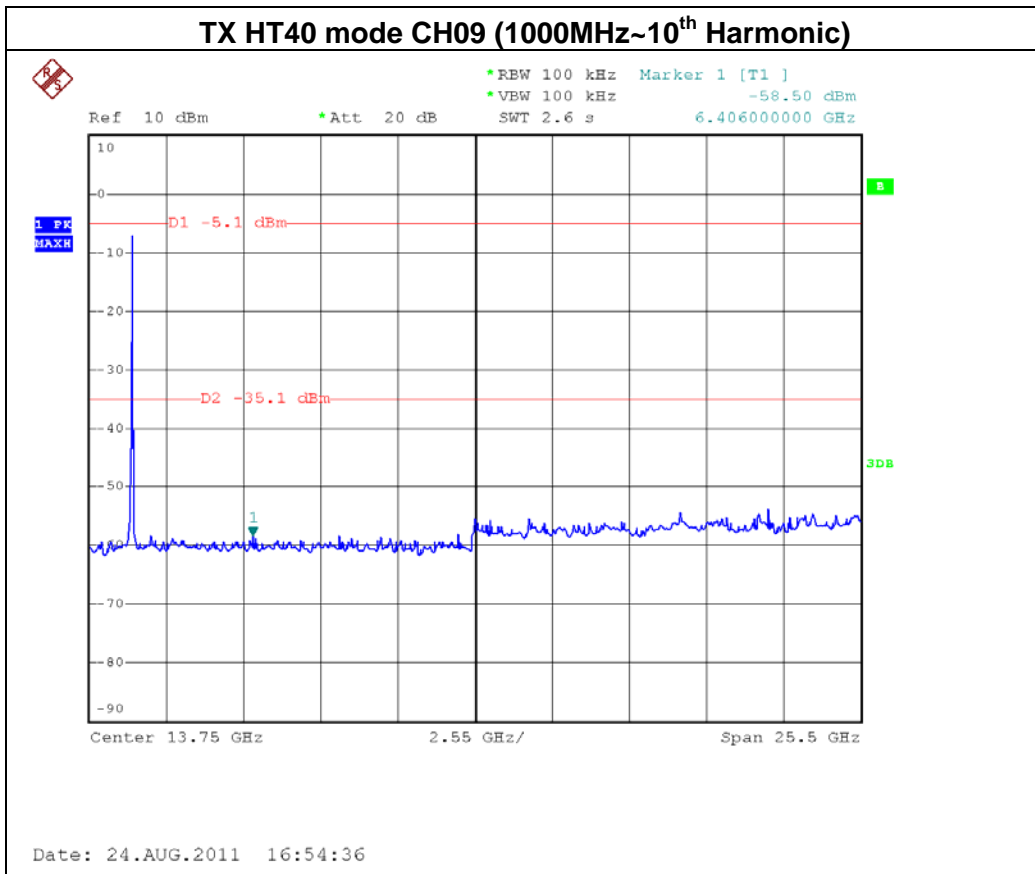
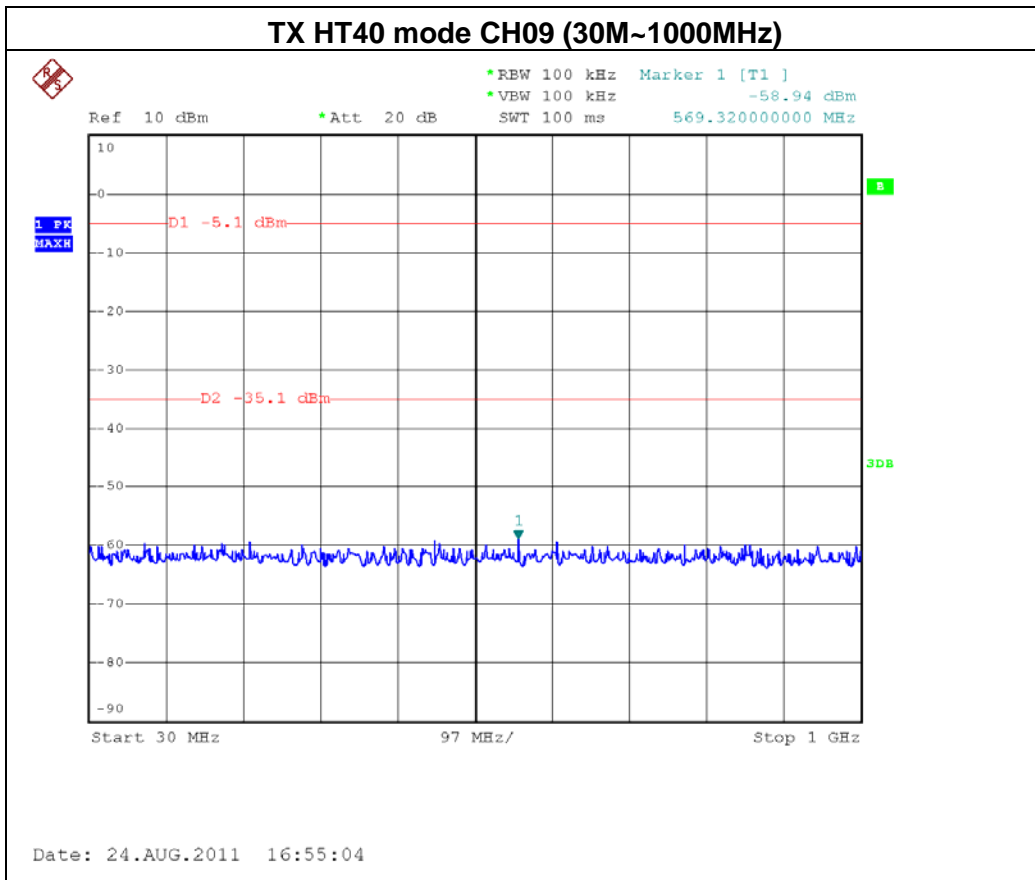



## 8. POWER SPECTRAL DENSITY TEST

### 8.1 Applied procedures / limit

| FCC Part15 (15.247) , Subpart C |                        |                     |                       |        |
|---------------------------------|------------------------|---------------------|-----------------------|--------|
| Section                         | Test Item              | Limit               | Frequency Range (MHz) | Result |
| 15.247(e)                       | Power Spectral Density | 8 dBm (in any 3KHz) | 2400-2483.5           | PASS   |

### 8.1.1 MEASUREMENT INSTRUMENTS LIST

| Item | Kind of Equipment | Manufacturer | Type No. | Serial No. | Calibrated until |
|------|-------------------|--------------|----------|------------|------------------|
| 1    | Spectrum Analyzer | R&S          | FSP 40   | 100185     | Nov.26.2011      |

Remark: " N/A" denotes No Model Name. , Serial No. or No Calibration specified.

### 8.1.2 TEST PROCEDURE

- a. The EUT was directly connected to the spectrum analyzer and antenna output port as show in the block diagram below,
- b. Spectrum Setting : RBW=3KHz, VBW=30 KHz, Sweep time = 500s.

### 8.1.3 DEVIATION FROM STANDARD

No deviation.

### 8.1.4 TEST SETUP

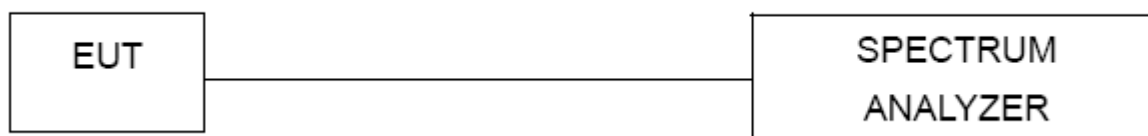

### 8.1.5 EUT OPERATION CONDITIONS

The EUT tested system was configured as the statements of 4.1.6 Unless otherwise a special operating condition is specified in the follows during the testing.



**8.1.6 TEST RESULTS**

|               |                                |                     |              |
|---------------|--------------------------------|---------------------|--------------|
| EUT :         | 300Mbps Wireless-N USB Adapter | Model Name :        | WF-2109      |
| Temperature : | 24 °C                          | Relative Humidity : | 60 %         |
| Pressure :    | 1016 hPa                       | Test Voltage :      | AC 120V/60Hz |
| Test Mode :   | TX B MODE /CH01, CH06, CH11    |                     |              |

| Test Channel | Frequency (MHz) | Power Density (dBm) | LIMIT (dBm) |
|--------------|-----------------|---------------------|-------------|
| CH01         | 2412 MHz        | -17.88              | 8           |
| CH06         | 2437 MHz        | -17.89              | 8           |
| CH11         | 2462 MHz        | -17.46              | 8           |

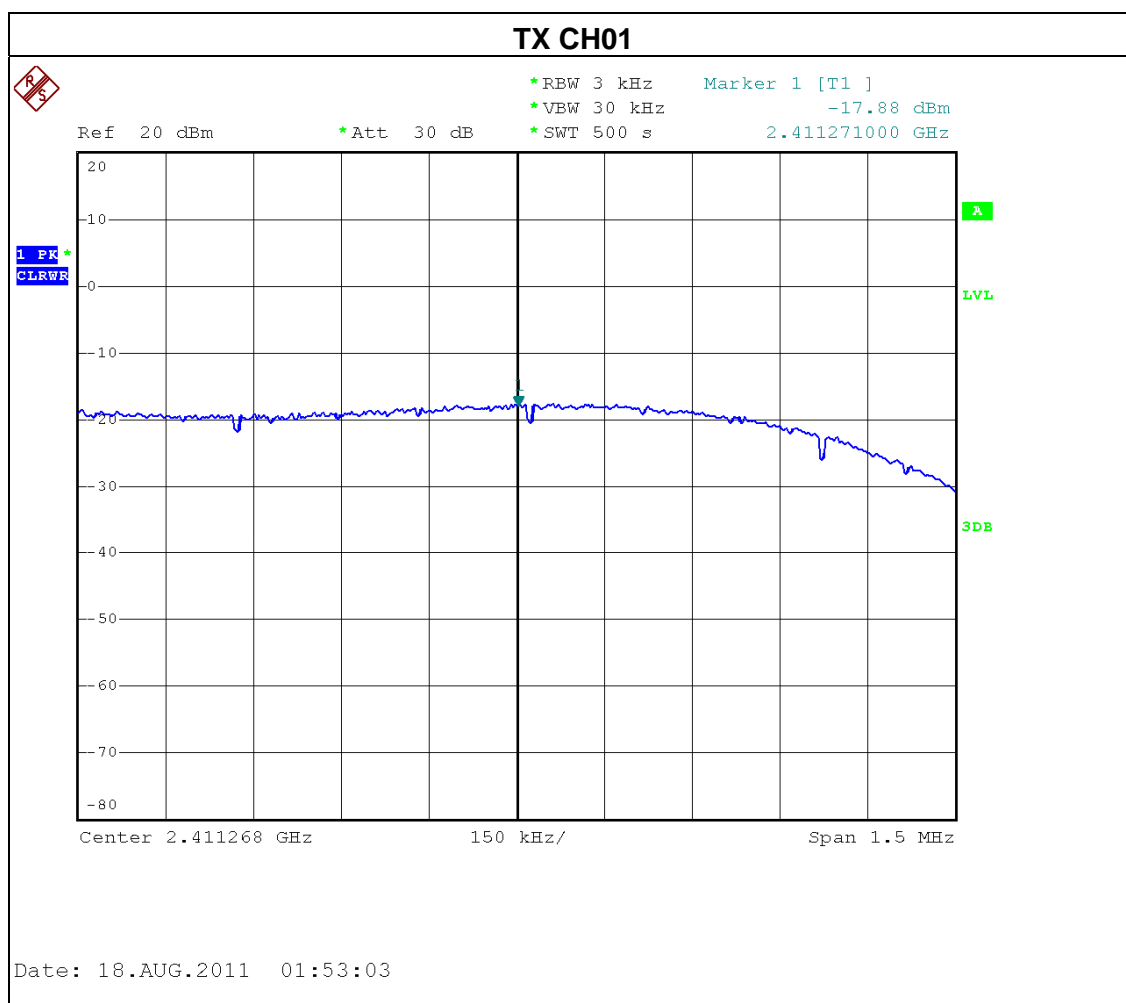



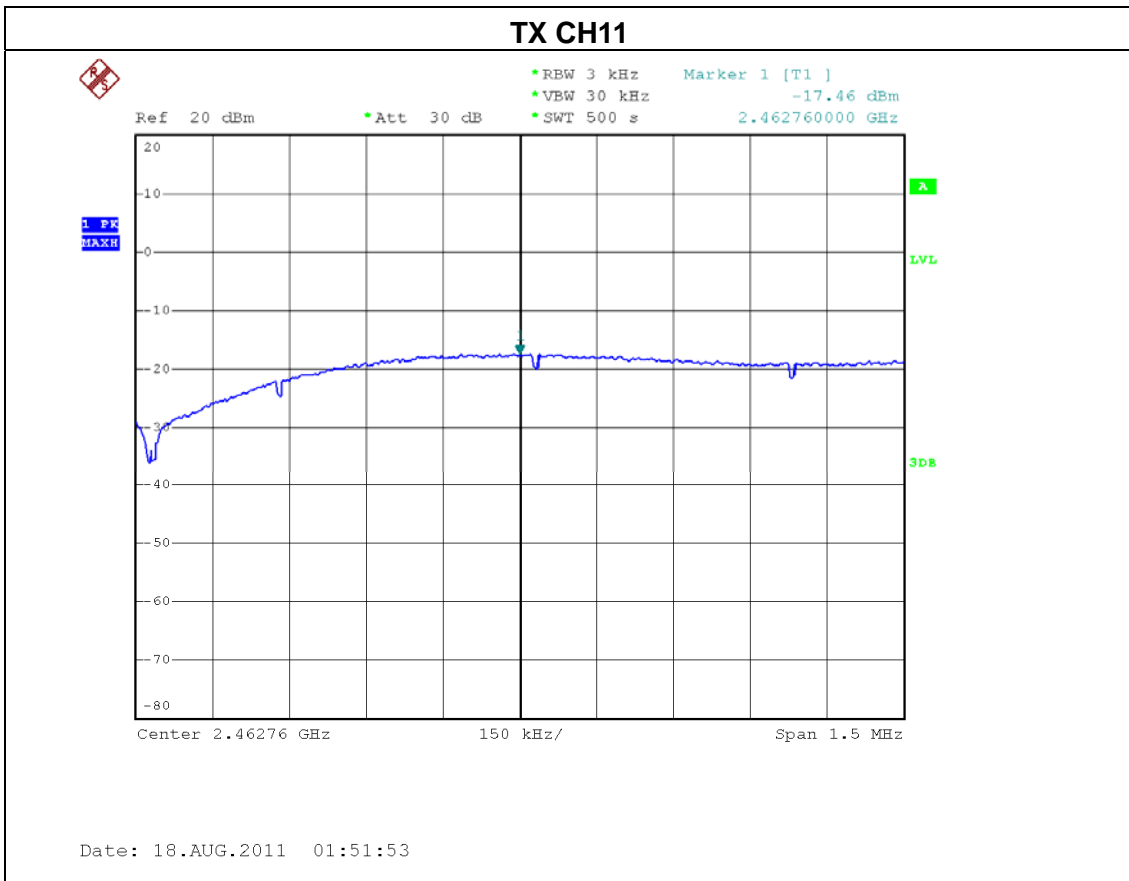
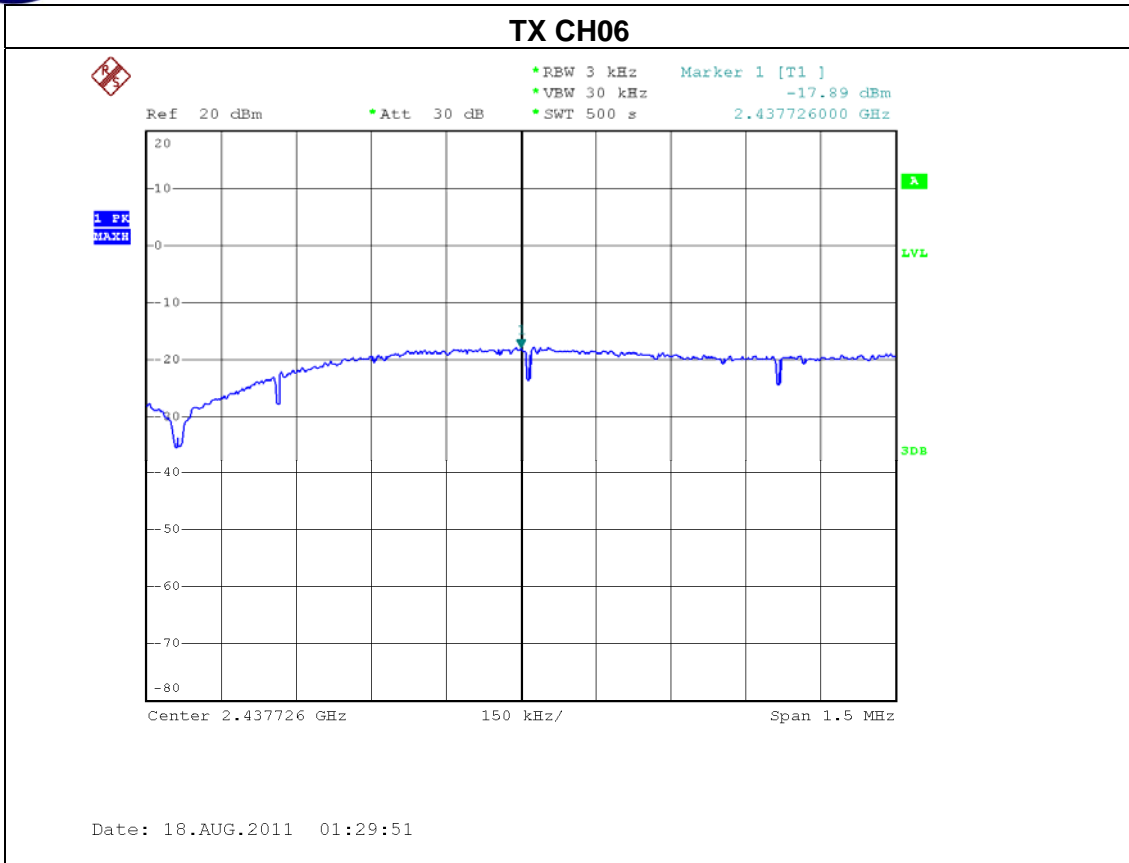



|               |                                |                     |              |
|---------------|--------------------------------|---------------------|--------------|
| EUT :         | 300Mbps Wireless-N USB Adapter | Model Name :        | WF-2109      |
| Temperature : | 24 °C                          | Relative Humidity : | 60 %         |
| Pressure :    | 1016 hPa                       | Test Voltage :      | AC 120V/60Hz |
| Test Mode :   | TX G MODE /CH01, CH06, CH11    |                     |              |

| Test Channel | Frequency (MHz) | Power Density (dBm) | LIMIT (dBm) |
|--------------|-----------------|---------------------|-------------|
| CH01         | 2412 MHz        | -17.46              | 8           |
| CH06         | 2437 MHz        | -16.95              | 8           |
| CH11         | 2462 MHz        | -16.97              | 8           |

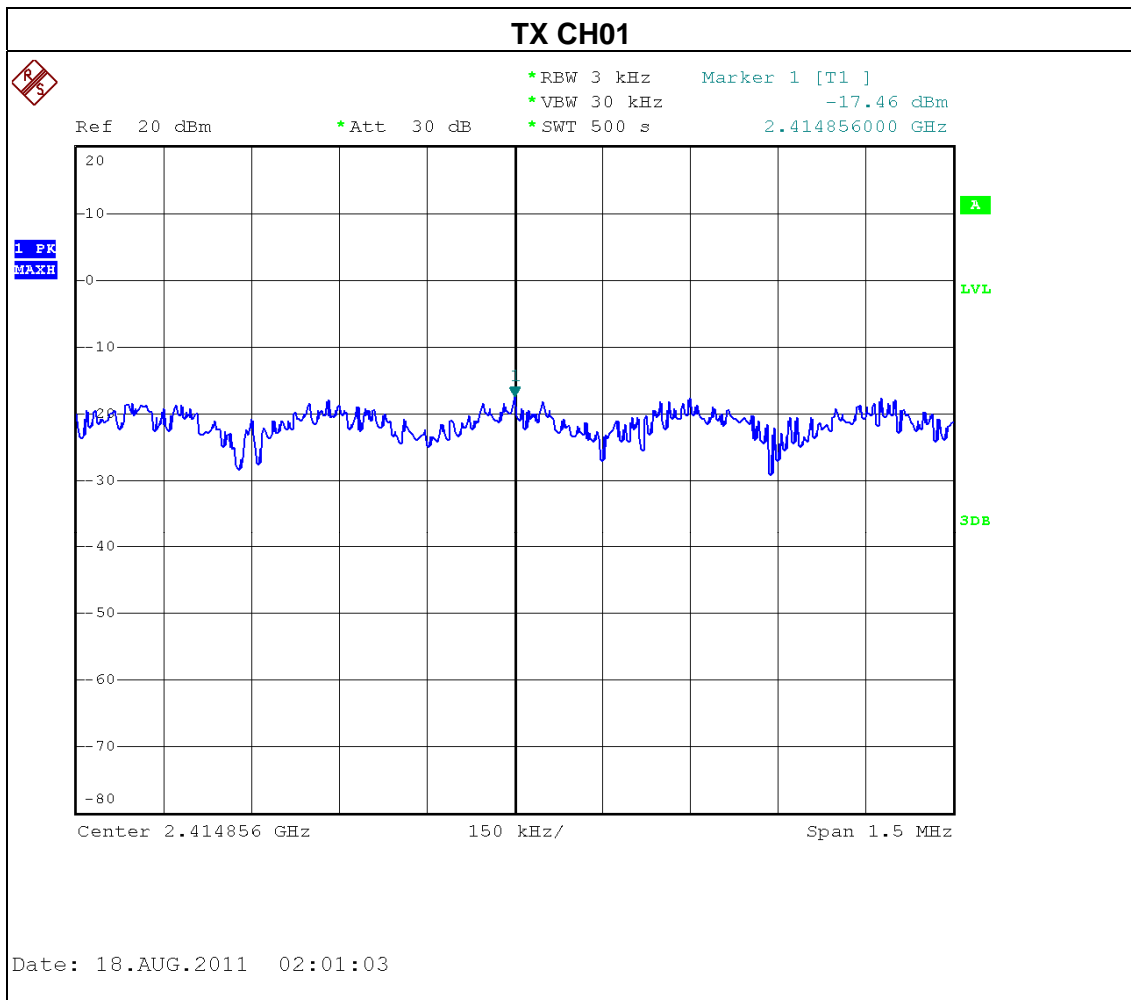

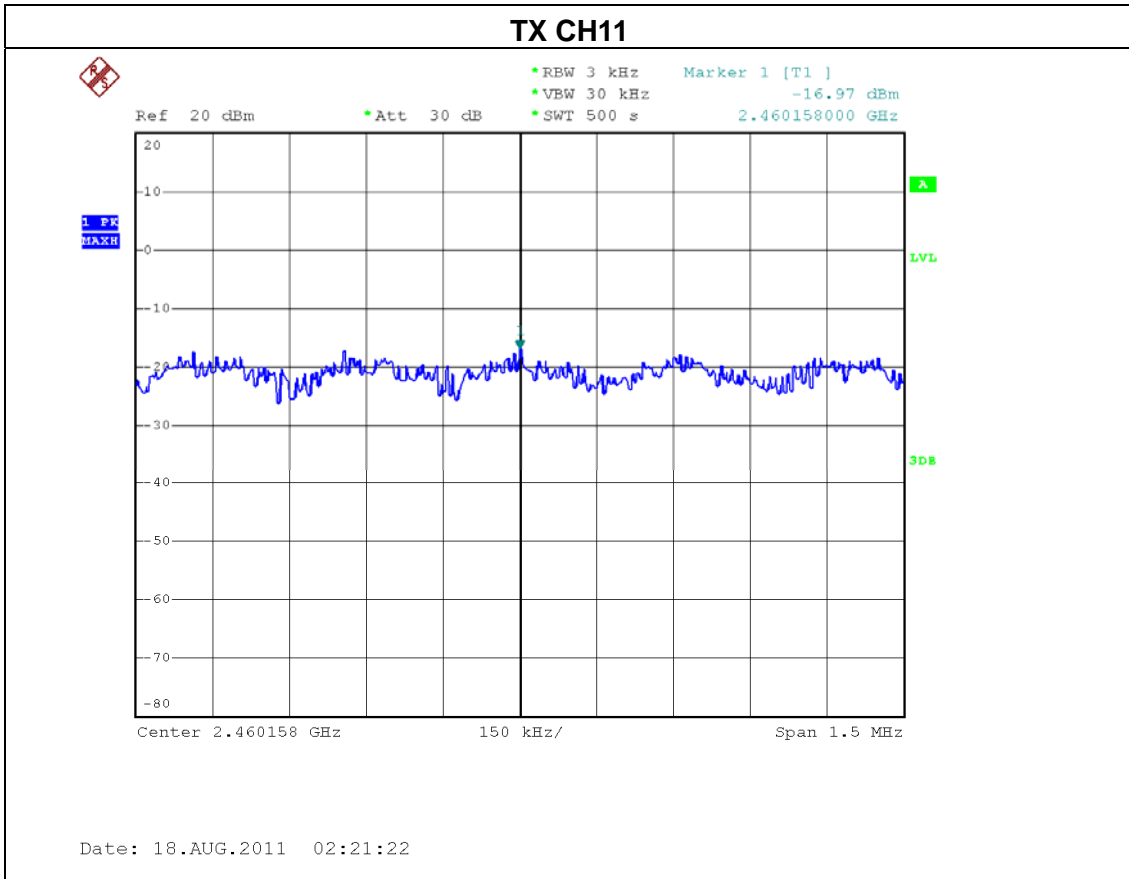
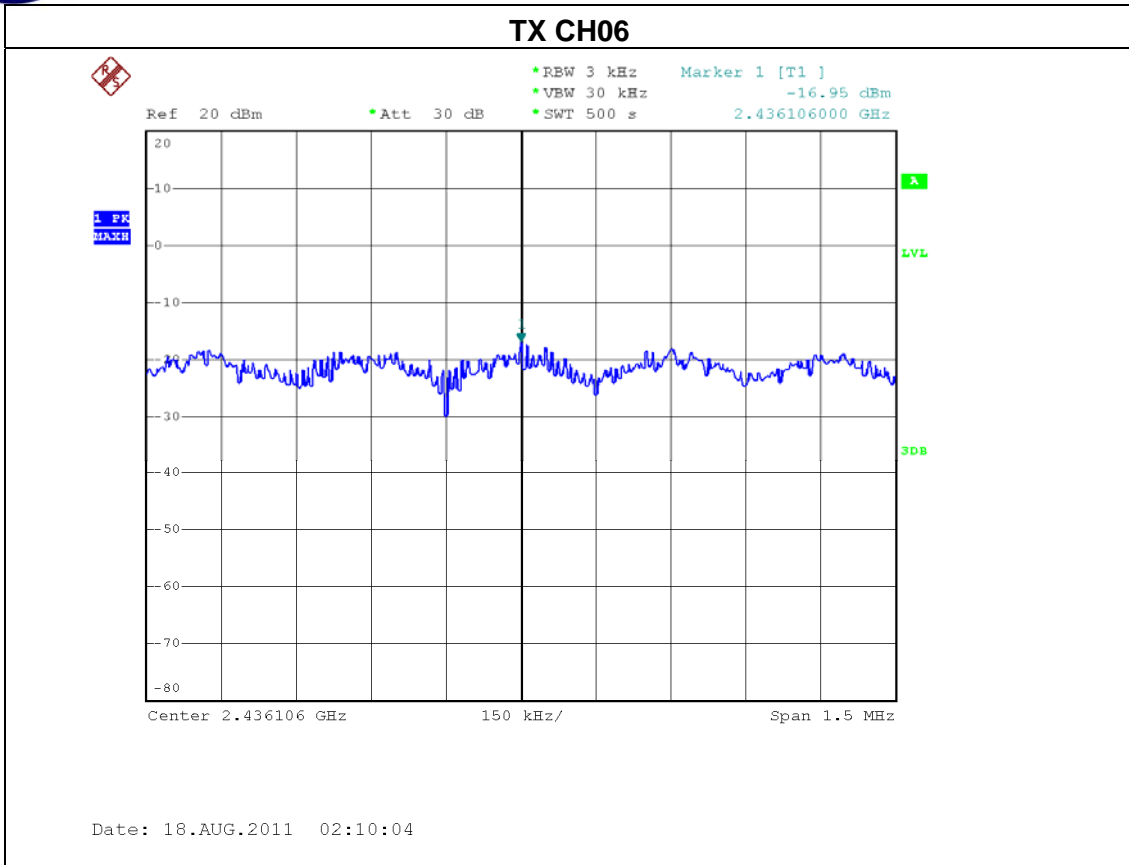



|               |                                   |                     |              |
|---------------|-----------------------------------|---------------------|--------------|
| EUT :         | 300Mbps Wireless-N USB Adapter    | Model Name :        | WF-2109      |
| Temperature : | 24 °C                             | Relative Humidity : | 60 %         |
| Pressure :    | 1016 hPa                          | Test Voltage :      | AC 120V/60Hz |
| Test Mode :   | TX N MODE-20MHz /CH01, CH06, CH11 |                     |              |

| Ant 1        |                 |               |          |             |           |
|--------------|-----------------|---------------|----------|-------------|-----------|
| Test Channel | Frequency (MHz) | Power density |          | LIMIT (dBm) | PASS/FAIL |
|              |                 | (dBm)         | (mW)     |             |           |
| CH01         | 2412            | -19.22        | 0.011967 | 8           | PASS      |
| CH06         | 2437            | -22.03        | 0.006266 | 8           | PASS      |
| CH11         | 2462            | -20.82        | 0.008279 | 8           | PASS      |

| Ant 2        |                 |               |          |             |           |
|--------------|-----------------|---------------|----------|-------------|-----------|
| Test Channel | Frequency (MHz) | Power density |          | LIMIT (dBm) | PASS/FAIL |
|              |                 | (dBm)         | (mW)     |             |           |
| CH01         | 2412            | -20.17        | 0.009616 | 8           | PASS      |
| CH06         | 2437            | -23.17        | 0.004819 | 8           | PASS      |
| CH11         | 2462            | -20.88        | 0.008166 | 8           | PASS      |

| Total (Ant 1 + Ant 2) |                 |               |          |             |           |
|-----------------------|-----------------|---------------|----------|-------------|-----------|
| Test Channel          | Frequency (MHz) | Power density |          | LIMIT (dBm) | PASS/FAIL |
|                       |                 | (dBm)         | (mW)     |             |           |
| CH01                  | 2412            | -16.66        | 0.021584 | 8           | PASS      |
| CH06                  | 2437            | -19.55        | 0.011086 | 8           | PASS      |
| CH11                  | 2462            | -17.84        | 0.016445 | 8           | PASS      |

Remark :

- (1) **The MIMO test requirement, RF power density shall measure each transmitter chain by using channel power density method.**  
**And after obtain each individual transmitter chain power density, then sum the power density by using the following formula:**  

$$((\text{dBm}/\text{Chain 1})/10^{\text{Log}}) + ((\text{dBm}/\text{Chain 2})/10^{\text{log}}) + ((\text{dBm}/\text{ChainN})/10^{\text{log}}) =$$
**Combined power density in mW.**
- (2) **Antenna Gain=0 dBi.**

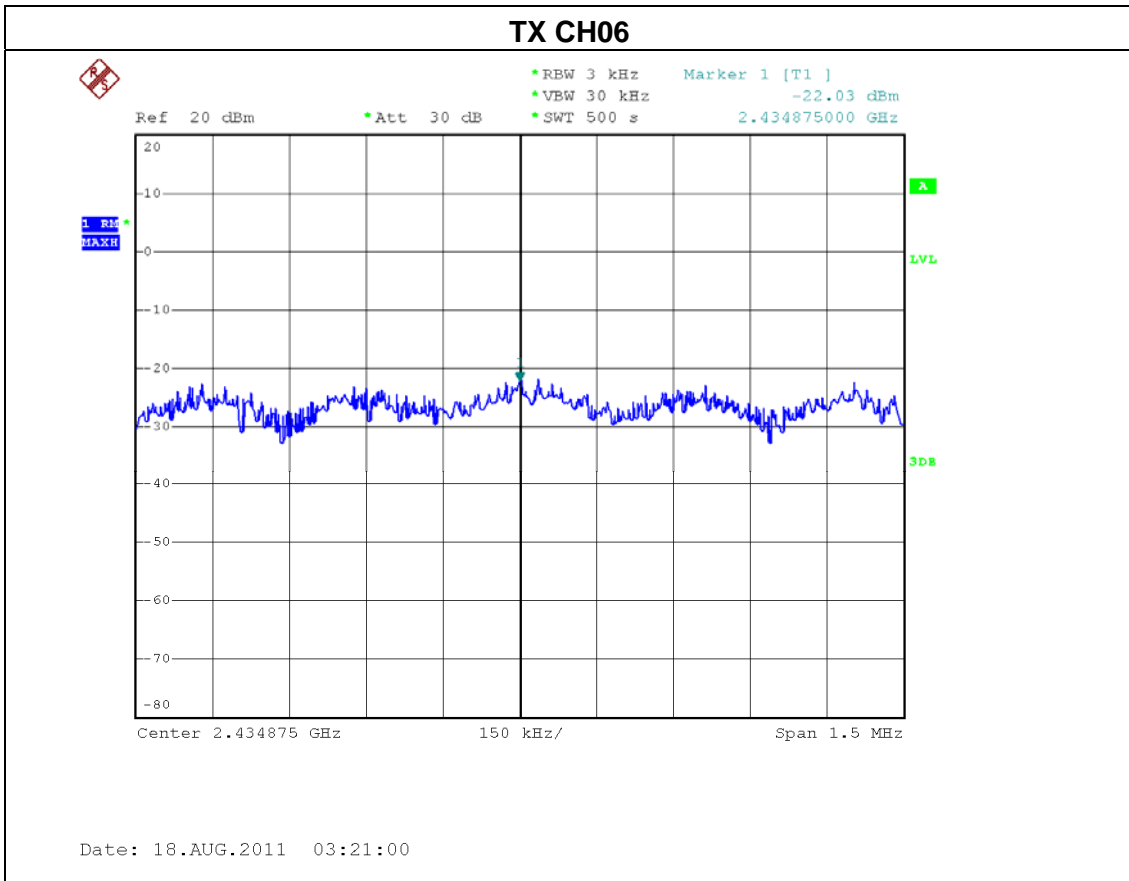
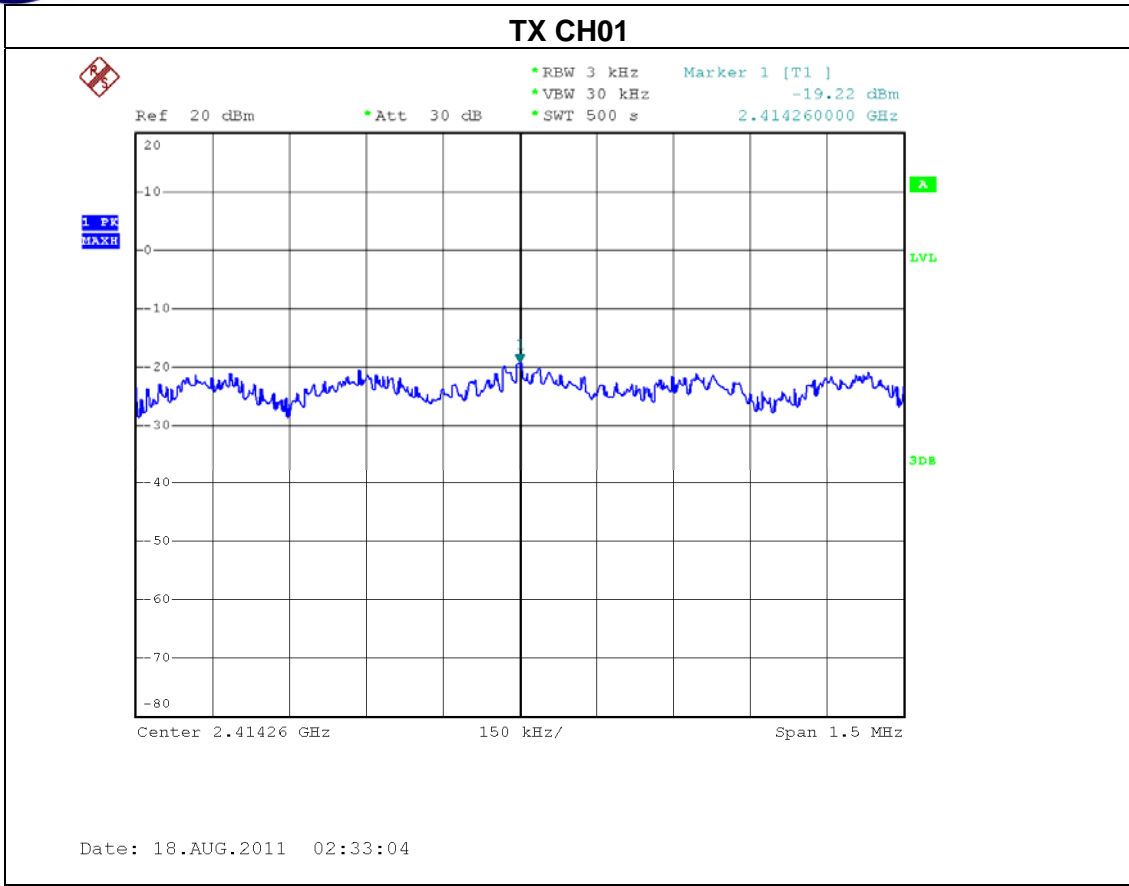

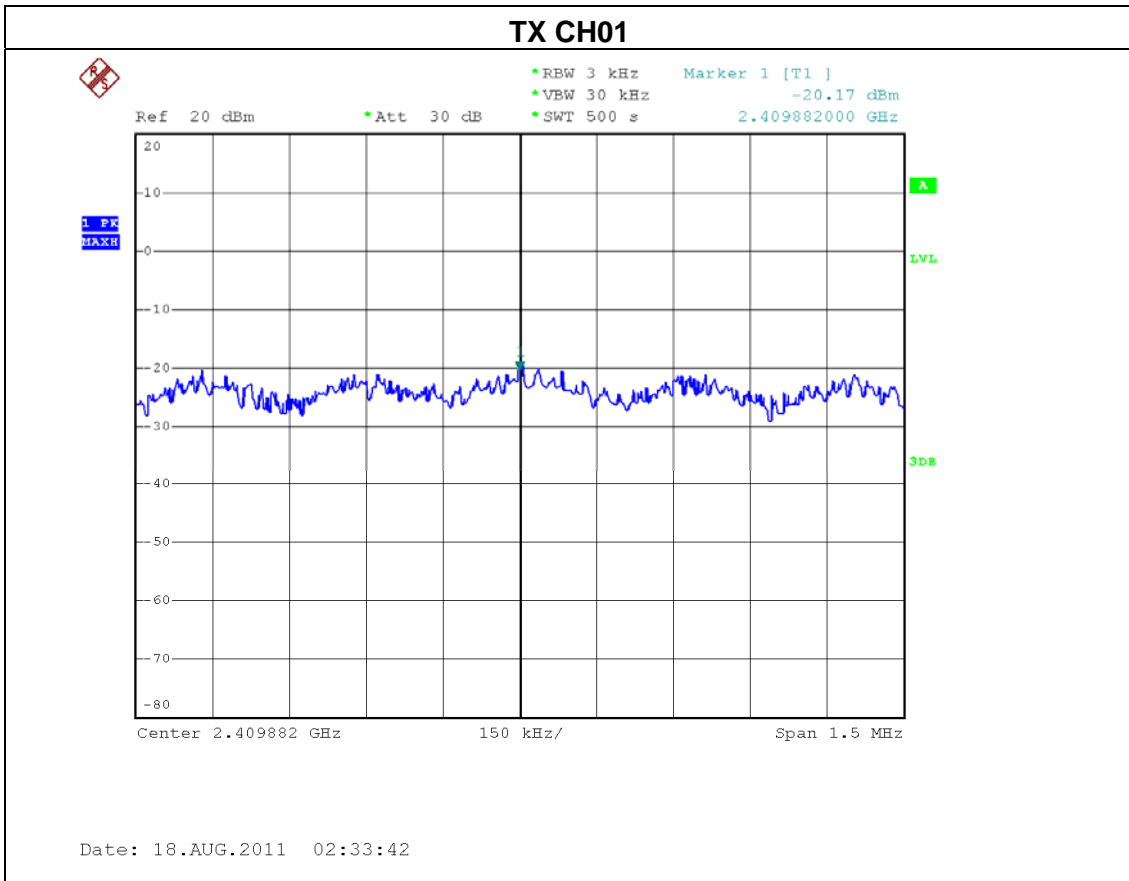
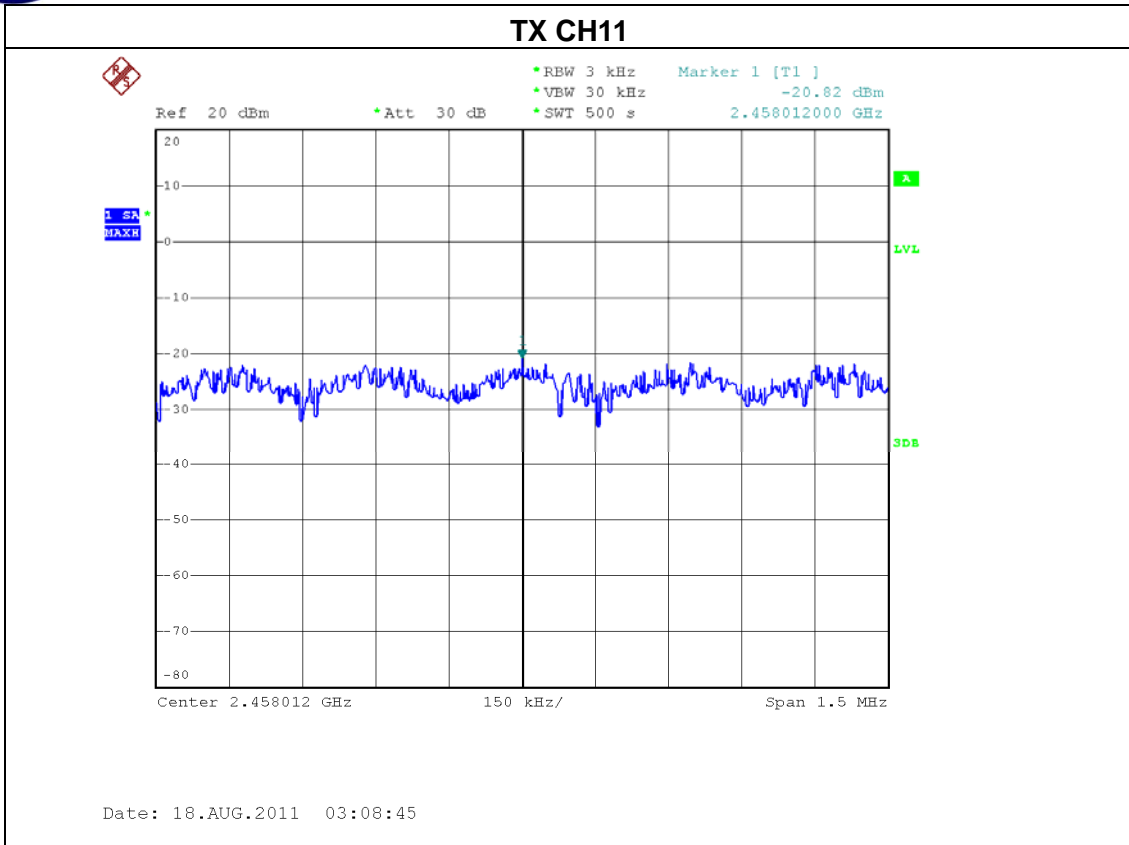

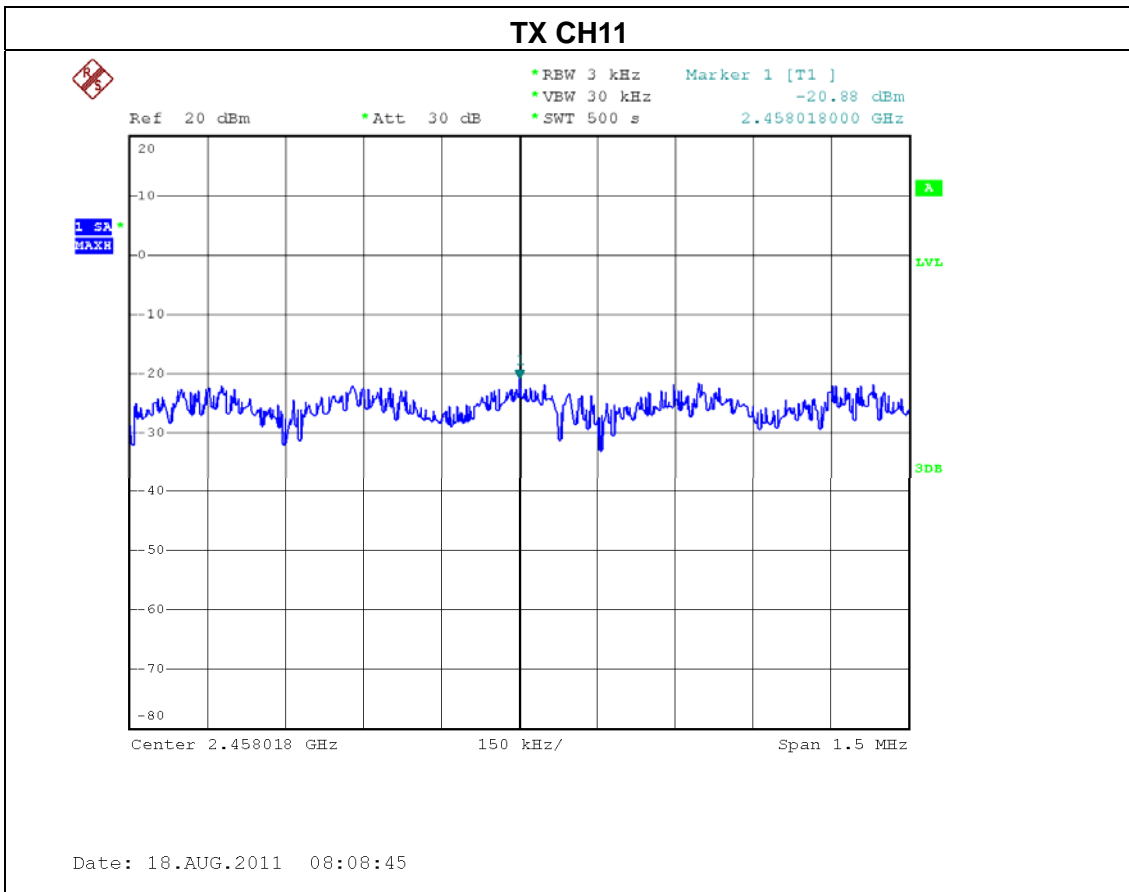
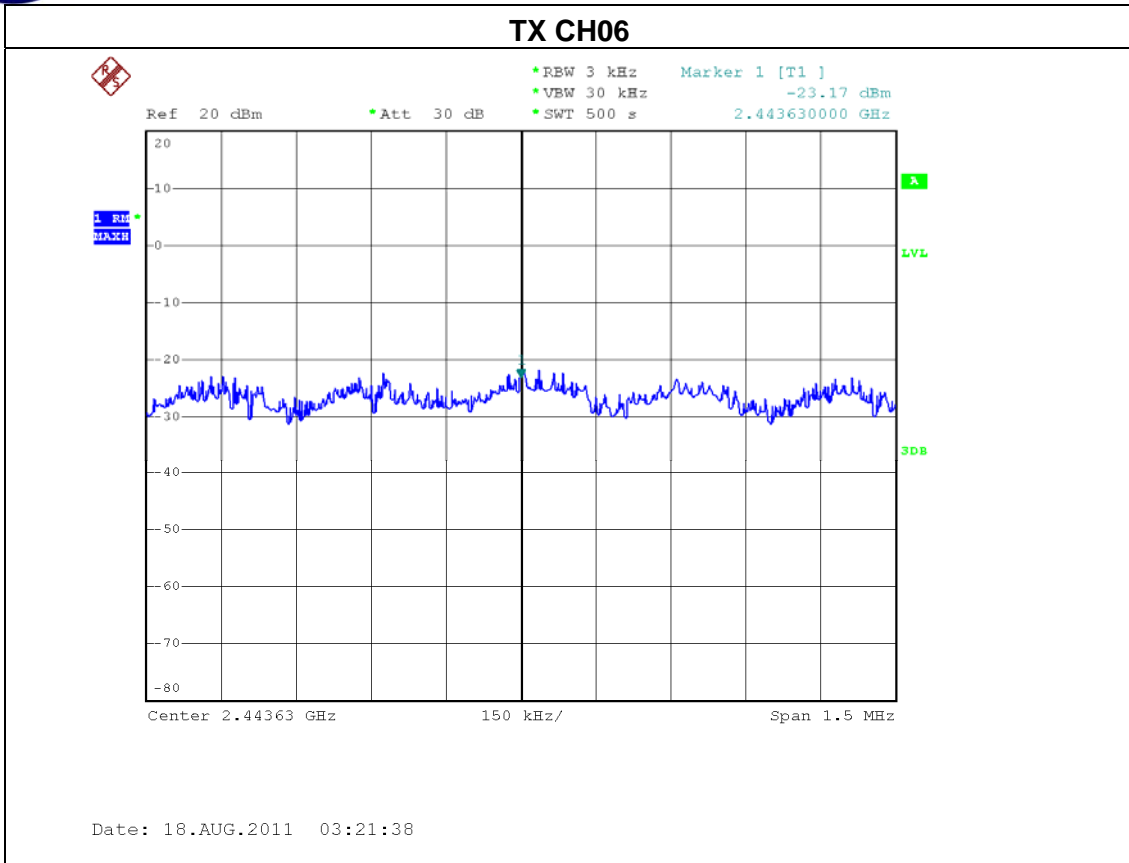



|               |                                   |                     |              |
|---------------|-----------------------------------|---------------------|--------------|
| EUT :         | 300Mbps Wireless-N USB Adapter    | Model Name :        | WF-2109      |
| Temperature : | 24 °C                             | Relative Humidity : | 60 %         |
| Pressure :    | 1016 hPa                          | Test Voltage :      | AC 120V/60Hz |
| Test Mode :   | TX N MODE-40MHz /CH03, CH06, CH09 |                     |              |

| Ant 1        |                 |               |          |             |           |
|--------------|-----------------|---------------|----------|-------------|-----------|
| Test Channel | Frequency (MHz) | Power density |          | LIMIT (dBm) | PASS/FAIL |
|              |                 | (dBm)         | (mW)     |             |           |
| CH03         | 2422            | -21.34        | 0.007345 | 8           | PASS      |
| CH06         | 2437            | -21.78        | 0.006637 | 8           | PASS      |
| CH09         | 2452            | -20.76        | 0.008395 | 8           | PASS      |

| Ant 2        |                 |               |          |             |           |
|--------------|-----------------|---------------|----------|-------------|-----------|
| Test Channel | Frequency (MHz) | Power density |          | LIMIT (dBm) | PASS/FAIL |
|              |                 | (dBm)         | (mW)     |             |           |
| CH03         | 2422            | -22.26        | 0.005943 | 8           | PASS      |
| CH06         | 2437            | -21.92        | 0.006427 | 8           | PASS      |
| CH09         | 2452            | -21.02        | 0.007907 | 8           | PASS      |

| Total (Ant 1 + Ant 2) |                 |               |          |             |           |
|-----------------------|-----------------|---------------|----------|-------------|-----------|
| Test Channel          | Frequency (MHz) | Power density |          | LIMIT (dBm) | PASS/FAIL |
|                       |                 | (dBm)         | (mW)     |             |           |
| CH03                  | 2422            | -18.77        | 0.013288 | 8           | PASS      |
| CH06                  | 2437            | -18.84        | 0.013064 | 8           | PASS      |
| CH09                  | 2452            | -17.88        | 0.016301 | 8           | PASS      |

Remark :

- (1) The MIMO test requirement, RF power density shall measure each transmitter chain by using channel power density method.  
And after obtain each individual transmitter chain power density, then sum the power density by using the following formula:  

$$((\text{dBm}/\text{Chain 1})/10^{\text{Log}}) + ((\text{dBm}/\text{Chain 2})/10^{\text{log}}) + ((\text{dBm}/\text{Chain N})/10^{\text{log}}) =$$
**Combined power density in mW.**
- (2) Antenna Gain=0 dBi.



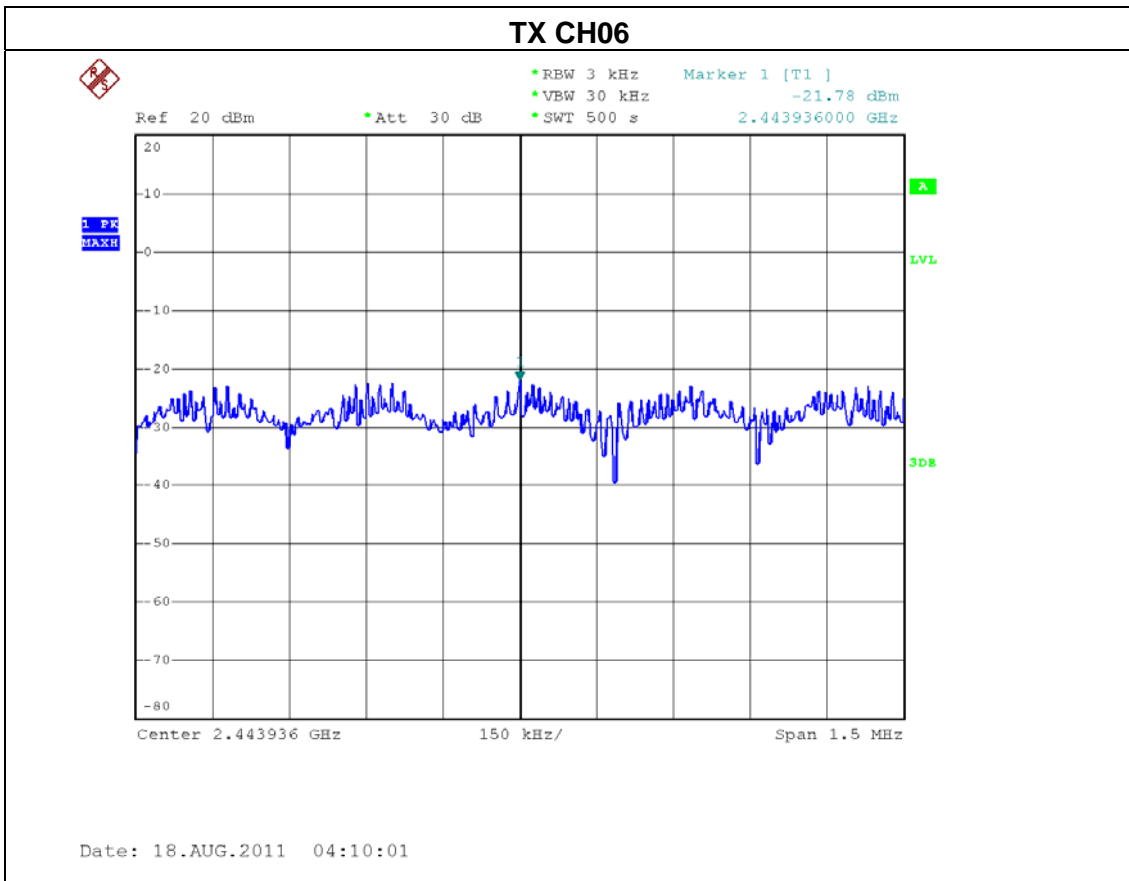
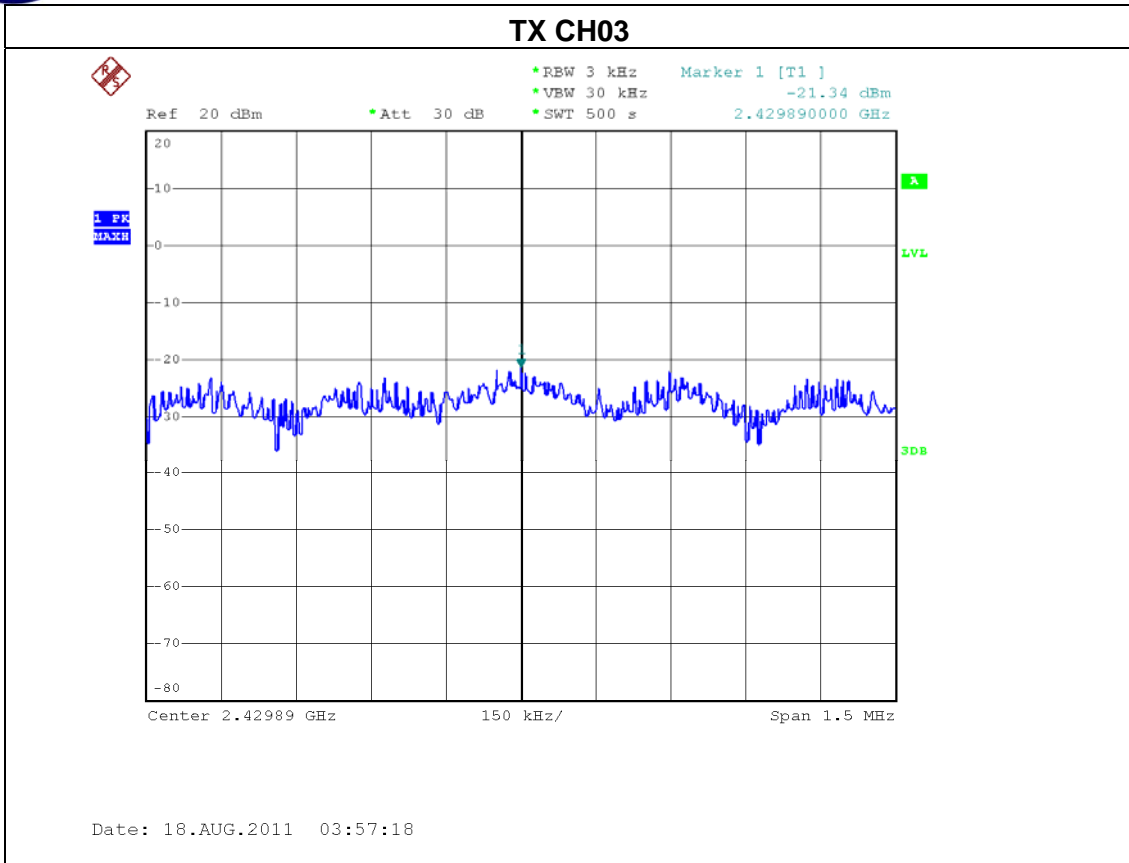

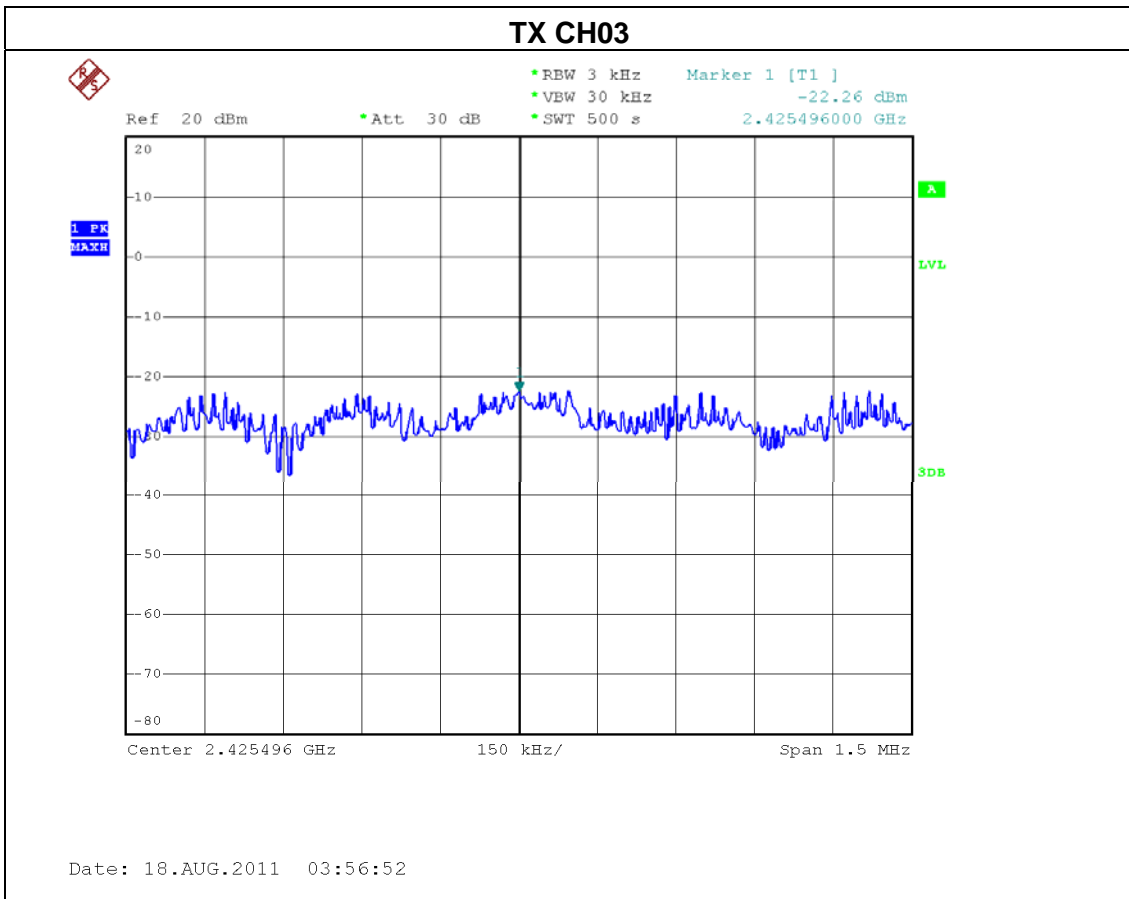
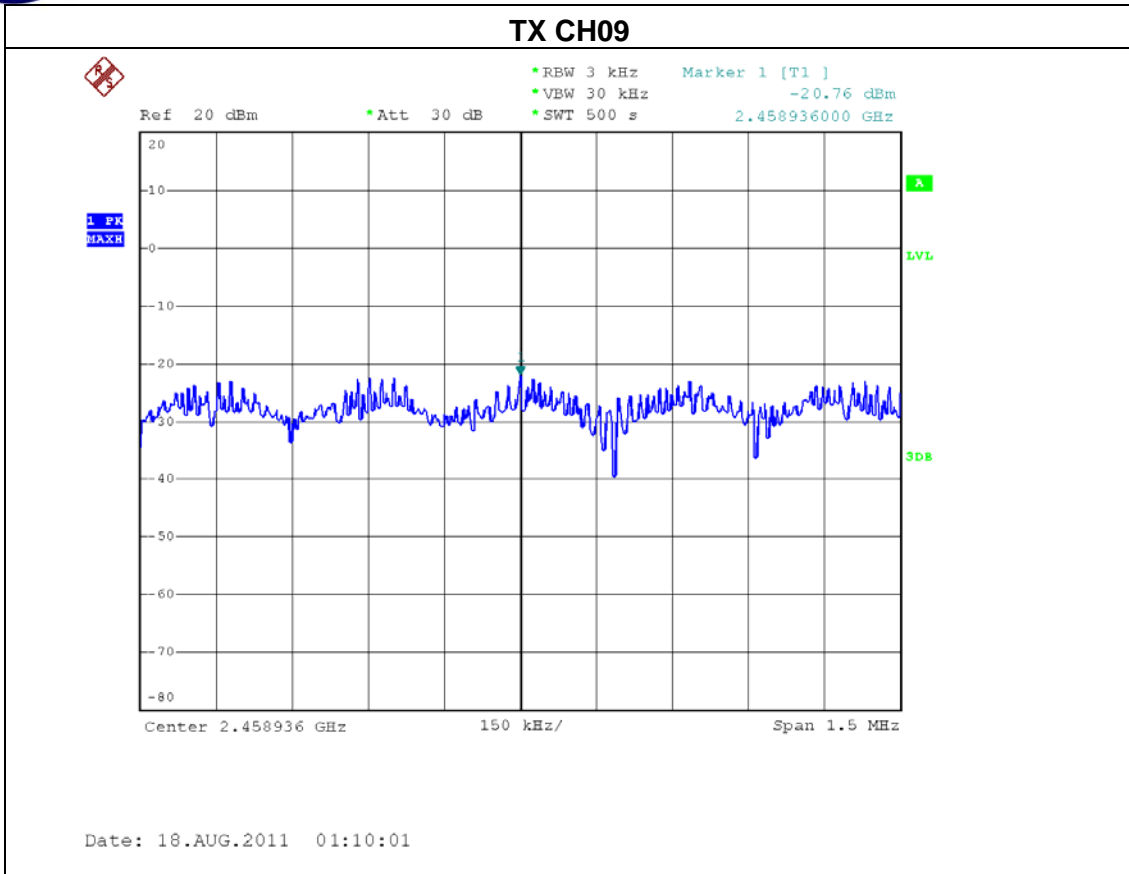

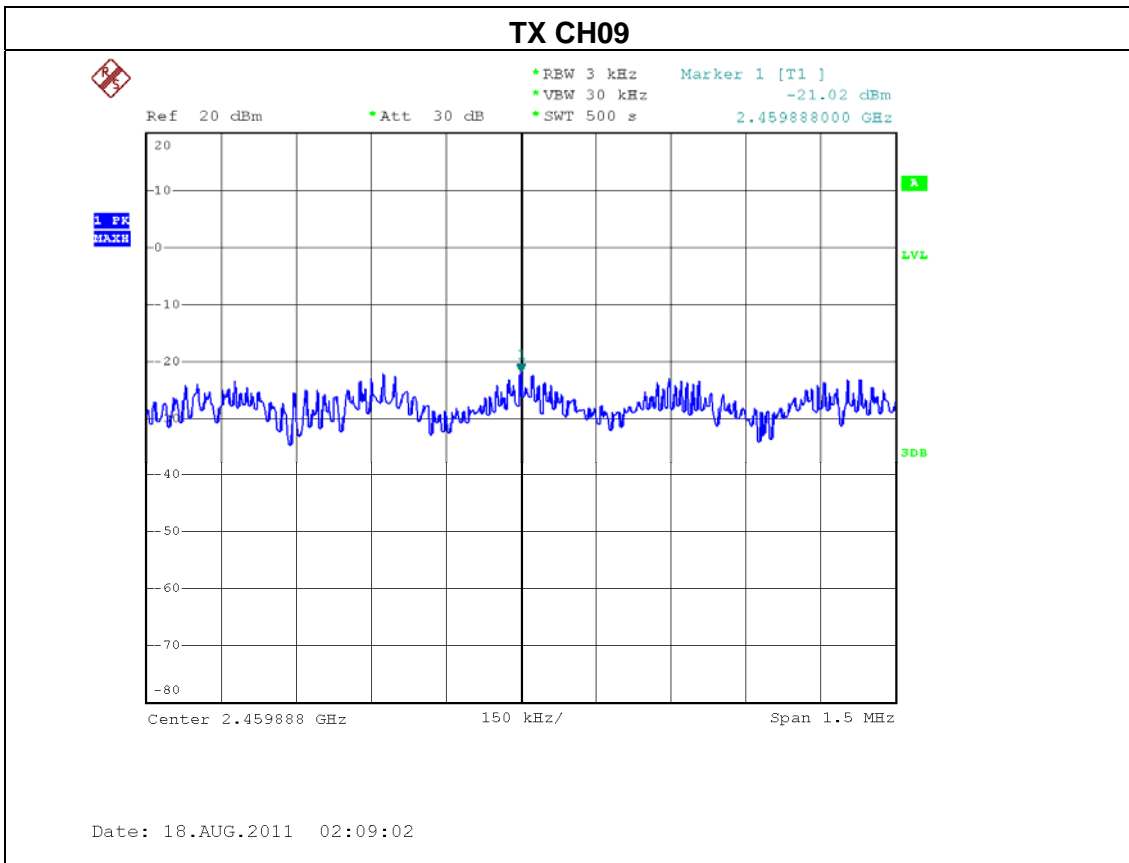
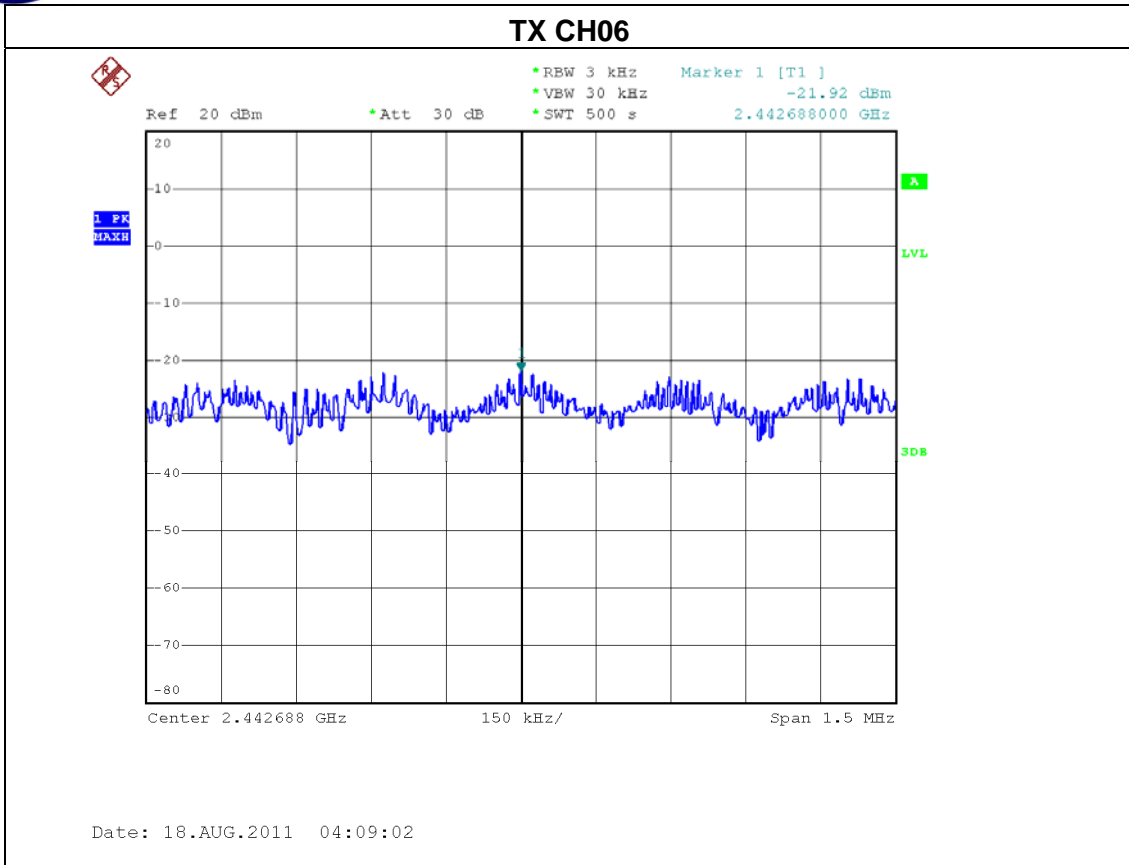



**9. EUT TEST PHOTO**

**Conducted Measurement Photos**





**Radiated Measurement Photos**

