



FCC Radio Test Report

FCC ID: T58WF2103R1

This report concerns (check one) : Original Grant Class II Change

Issued Date : Aug. 23, 2011
Project No. : 1108C124
Equipment : 150Mbps Wireless-N USB Adapter
Model Name : WF-2103
Applicant : NETIS SYSTEMS CO., LTD.
Address : 9F,B Block,Tsinghua Information Park, High-tech Industrial Park,Nanshan, Shenzhen,China
Manufacturer : Shenzhen Netcore Industrial Ltd.
Address : 9F,B Block,Tsinghua Information Park, High-tech Industrial Park,Nanshan, Shenzhen,China

Tested by:

Neutron Engineering Inc. EMC Laboratory

Date of Receipt: Aug. 12, 2011

Date of Test:

Aug. 12, 2011 ~ Aug. 23, 2011

Testing Engineer : 
(Ares Liu)

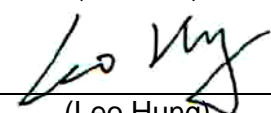
Technical Manager : 
(Leo Hung)

Authorized Signatory : 
(Steven Lu)

Neutron Engineering Inc.

**No.3,Jinshagang 1st Road, ShiXia, Dalang
Town, Dong Guan, China.
TEL : (0769) 8318-3000 FAX : (0769) 8319-6000**



Declaration

Neutron represents to the client that testing is done in accordance with standard procedures as applicable and that test instruments used has been calibrated with the standards traceable to National Measurement Laboratory (**NML**) of **R.O.C.**, or National Institute of Standards and Technology (**NIST**) of **U.S.A.**

Neutron's reports apply only to the specific samples tested under conditions. It is manufacture's responsibility to ensure that additional production units of this model are manufactured with the identical electrical and mechanical components. **Neutron** shall have no liability for any declarations, inferences or generalizations drawn by the client or others from **Neutron** issued reports.

Neutron's reports must not be used by the client to claim product endorsement by the authorities or any agency of the Government.

This report is the confidential property of the client. As a mutual protection to the clients, the public and **Neutron-self**, extracts from the test report shall not be reproduced except in full with **Neutron's** authorized written approval.

Neutron's laboratory quality assurance procedures are in compliance with the **ISO Guide 17025** requirements, and accredited by the conformity assessment authorities listed in this test report.

Limitation

For the use of the authority's logo is limited unless the Test Standard(s)/Scope(s)/Item(s) mentioned in this test report is (are) included in the conformity assessment authorities acceptance respective.



Table of Contents	Page
1 . CERTIFICATION	5
2 . SUMMARY OF TEST RESULTS	6
2.1 TEST FACILITY	7
2.2 MEASUREMENT UNCERTAINTY	7
3 . GENERAL INFORMATION	8
3.1 GENERAL DESCRIPTION OF EUT	8
3.2 DESCRIPTION OF TEST MODES	10
3.3 TABLE OF PARAMETERS OF TEXT SOFTWARE SETTING	11
3.4 BLOCK DIGRAM SHOWING THE CONFIGURATION OF SYSTEM TESTED	12
3.5 DESCRIPTION OF SUPPORT UNITS (RADIATED MODE)	13
3.6 DESCRIPTION OF SUPPORT UNITS (CONDUCTED MODE)	14
4 . EMC EMISSION TEST	15
4.1 CONDUCTED EMISSION MEASUREMENT	15
4.1.1 POWER LINE CONDUCTED EMISSION LIMITS	15
4.1.2 MEASUREMENT INSTRUMENTS LIST AND SETTING	15
4.1.3 TEST PROCEDURE	16
4.1.4 DEVIATION FROM TEST STANDARD	16
4.1.5 TEST SETUP	16
4.1.6 EUT OPERATING CONDITIONS	16
4.1.7 TEST RESULTS	17
4.2 RADIATED EMISSION MEASUREMENT	19
4.2.1 RADIATED EMISSION LIMITS	19
4.2.2 MEASUREMENT INSTRUMENTS LIST ANS SETTING	20
4.2.3 TEST PROCEDURE	21
4.2.4 DEVIATION FROM TEST STANDARD	21
4.2.5 TEST SETUP	22
4.2.6 EUT OPERATING CONDITIONS	22
4.2.7 TEST RESULTS (BETWEEN 30 – 1000 MHZ)	23
4.2.8 TEST RESULTS (ABOVE 1000 MHZ)	25
5 . BANDWIDTH TEST	73
5.1 APPLIED PROCEDURES / LIMIT	73
5.1.1 MEASUREMENT INSTRUMENTS LIST	73
5.1.2 TEST PROCEDURE	73
5.1.3 DEVIATION FROM STANDARD	73
5.1.4 TEST SETUP	74



Table of Contents	Page
5.1.5 EUT OPERATION CONDITIONS	74
5.1.6 TEST RESULTS	75
6 . MAXIMUM OUTPUT POWER TEST	83
6.1 APPLIED PROCEDURES / LIMIT	83
6.1.1 MEASUREMENT INSTRUMENTS LIST	83
6.1.2 TEST PROCEDURE	83
6.1.3 DEVIATION FROM STANDARD	83
6.1.4 TEST SETUP	83
6.1.5 EUT OPERATION CONDITIONS	83
6.1.6 TEST RESULTS	84
7 . ANTENNA CONDUCTED SPURIOUS EMISSION	92
7.1 APPLIED PROCEDURES / LIMIT	92
7.1.1 MEASUREMENT INSTRUMENTS LIST	92
7.1.2 TEST PROCEDURE	92
7.1.3 DEVIATION FROM STANDARD	92
7.1.4 TEST SETUP	92
7.1.5 EUT OPERATION CONDITIONS	92
7.1.6 TEST RESULTS	93
8 . POWER SPECTRAL DENSITY TEST	113
8.1 APPLIED PROCEDURES / LIMIT	113
8.1.1 MEASUREMENT INSTRUMENTS LIST	113
8.1.2 TEST PROCEDURE	113
8.1.3 DEVIATION FROM STANDARD	113
8.1.4 TEST SETUP	113
8.1.5 EUT OPERATION CONDITIONS	113
8.1.6 TEST RESULTS	114
9 . EUT TEST PHOTO	122



1. CERTIFICATION

Equipment : 150Mbps Wireless-N USB Adapter
Brand Name : netis
Model Name : WF-2103
Applicant : NETIS SYSTEMS CO., LTD.
Factory : Dongguan City Netcore Network Technology Co.,Ltd.
Address : No.10-1,Sankeng Road,Qinghutou,Tangxia Town,Dongguan City
Date of Test : Aug. 12, 2011 ~ Aug. 23, 2011
Test Item : ENGINEERING SAMPLE
Standards : FCC Part15, Subpart C(15.247) / ANSI C63.4 : 2003

The above equipment has been tested and found compliance with the requirement of the relative standards by Neutron Engineering Inc. EMC Laboratory.

The test data, data evaluation, and equipment configuration contained in our test report (Ref No. NEI-FCCP-1-1108C124) were obtained utilizing the test procedures, test instruments, test sites that has been accredited by the Authority of NVLAP and TAF according to the ISO-17025 quality assessment standard and technical standard(s).



2. SUMMARY OF TEST RESULTS

Test procedures according to the technical standards:

FCC Part15 (15.247) , Subpart C				
Standard	Section	Test Item	Judgment	Remark
15.207		Conducted Emission	PASS	
15.247(d)		Antenna conducted Spurious Emission	PASS	
15.247(a)(2)		6dB Bandwidth	PASS	
15.247(b)(3)		Peak Output Power	PASS	
15.209/15.205		Radiated Spurious Emission	PASS	
15.247(e)		Power Spectral Density	PASS	
15.203		Antenna Requirement	PASS	

NOTE:

(1) "N/A" denotes test is not applicable in this Test Report



2.1 TEST FACILITY

The test facilities used to collect the test data in this report is **DG-C02/DG-C03** at the location of No.3, Jinshagang 1st Road, ShiXia, Dalang Town, Dong Guan, China.523792
 Neutron's test firm number is 319330

2.2 MEASUREMENT UNCERTAINTY

Where relevant, the following measurement uncertainty levels have been estimated for tests performed on the EUT as specified in CISPR 16-4-2:

The reported uncertainty of measurement $y \pm U$, where expanded uncertainty U is based on a standard uncertainty multiplied by a coverage factor of $k=2$, providing a level of confidence of approximately 95 %.

A. Conducted Measurement :

Test Site	Method	Measurement Frequency Range	U , (dB)	NOTE
DG-C02	CISPR	150 KHz ~ 30MHz	1.94	

B. Radiated Measurement :

Test Site	Method	Measurement Frequency Range	Ant. H / V	U , (dB)	NOTE
DG-CB03	CISPR	30MHz ~ 200MHz	V	3.82	
		30MHz ~ 200MHz	H	3.60	
		200MHz ~ 1,000MHz	V	3.86	
		200MHz ~ 1,000MHz	H	3.94	



3. GENERAL INFORMATION

3.1 GENERAL DESCRIPTION OF EUT

Equipment	150Mbps Wireless-N USB Adapter	
Brand Name	netis	
Model Name	WF-2103	
OEM Brand/Model Name	N/A	
Model Difference	N/A	
Product Description	The EUT is a 150Mbps Wireless-N USB Adapter.	
	Operation Frequency:	2412~2462 MHz
	Modulation Type:	802.11b:CCK, DQPSK, DBPSK 802.11g:OFDM 802.11n:OFDM
	Bit Rate of Transmitter	802.11b:11/5.5/2/1 Mbps 802.11g:54/48/36/24/18/12/9/6 Mbps Draft 802.11n:up to 150Mbps
	Number of Channel	11 CH, Please see Note 2. (please see page 9)
	Antenna Designation:	Please see Note 3.
	Antenna Gain(Peak)	(please see page 9)
	Output Power:	802.11b: 13.18dBm 802.11g: 13.37dBm 802.11n(20MHz): 13.39 dBm 802.11n(40MHz): 13.29 dBm
	Based on the application, features, or specification exhibited in User's Manual, the EUT is considered as an ITE/Computing Device. More details of EUT technical specification, please refer to the User's Manual.	
	Power Source	DC Voltage supplied from Host System.
Power Rating	I/P AC 120V/60Hz O/P DC 5V	
Connecting I/O Port(s)	Please refer to the User's Manual	
Products Covered	N/A	
Products Covered	N/A	

Note:

1. For a more detailed features description, please refer to the manufacturer's specifications or the User's Manual.



2. CH 01 – CH 11 for 802.11b, 802.11g, 802.11n(20MHz)
 CH 03 – CH 09 for 802.11n(40MHz)

Channel List

Channel	Frequency (MHz)	Channel	Frequency (MHz)	Channel	Frequency (MHz)	Channel	Frequency (MHz)
01	2412	04	2427	07	2442	10	2457
02	2417	05	2432	08	2447	11	2462
03	2422	06	2437	09	2452		

3. Table for Filed Antenna

Ant.	Brand	Model Name	Antenna Type	Connector	Gain (dBi)
1	N/A	N/A	Printed Antenna	N/A	0



3.2 DESCRIPTION OF TEST MODES

To investigate the maximum EMI emission characteristics generates from EUT, the test system was pre-scanning tested base on the consideration of following EUT operation mode or test configuration mode which possible have effect on EMI emission level. Each of these EUT operation mode(s) or test configuration mode(s) mentioned above was evaluated respectively.

Pretest Mode	Description
Mode 1	TX B MODE CHANNEL 01//06/11
Mode 2	TX G MODE CHANNEL 01/06/11
Mode 3	TX N-20MHZ MODE CHANNEL 01/06/11
Mode 4	TX N-40MHZ MODE CHANNEL 03/06/09
Mode 5	Noraml Link

The EUT system operated these modes were found to be the worst case during the pre-scanning test as Following:

For Conducted Test	
Final Test Mode	Description
Mode 5	Noraml Link

For Radiated Test	
Final Test Mode	Description
Mode 1	TX B MODE CHANNEL 01//06/11
Mode 2	TX G MODE CHANNEL 01/06/11
Mode 3	TX N-20MHZ MODE CHANNEL 01/06/11
Mode 4	TX N-40MHZ MODE CHANNEL 03/06/09

Note:

- (1) The measurements are performed at the highest, middle, lowest available channels.
- (2) 802.11b mode: DBPSK (1Mbps)
 802.11g mode: OFDM (6Mbps)
 802.11n HT20/HT40 mode : MCS0 (6Mbps)
 For radiated emission tests, the highest output powers were set for final test.



3.3 TABLE OF PARAMETERS OF TEXT SOFTWARE SETTING

During testing channel & power controlling software provided by the customer was used to control the operating channel as well as the output power level. The RF output power selection is for the setting of RF output power expected by the customer and is going to be fixed on the firmware of the final end product power parameters of WLAN

Test software Version	RT3x7xQA		
Frequency	2412 MHz	2437 MHz	2462 MHz
IEEE 802.11b DSSS	32	32	32
IEEE 802.11g OFDM	40	40	40

Test software Version	RT3x7xQA		
Frequency (MHz)	2412 MHz	2437 MHz	2462 MHz
IEEE 802.11n (20MHz)	40	40	40
Frequency (MHz)	2422 MHz	2437 MHz	2452 MHz
IEEE 802.11n (40MHz)	41	41	40



3.4 BLOCK DIGRAM SHOWING THE CONFIGURATION OF SYSTEM TESTED

Radiated TX Mode:

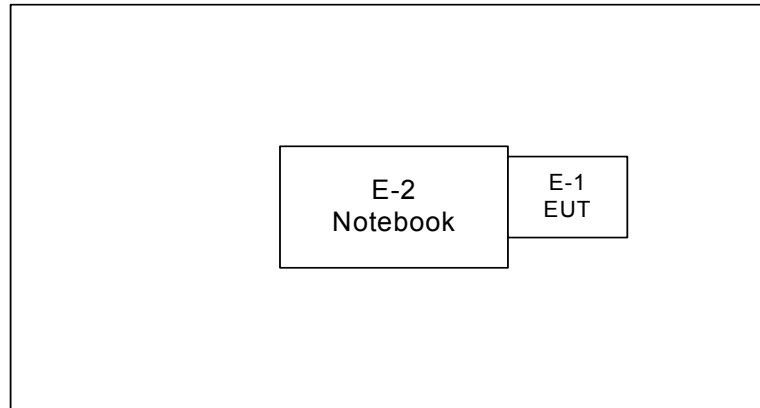

Conducted Mode:

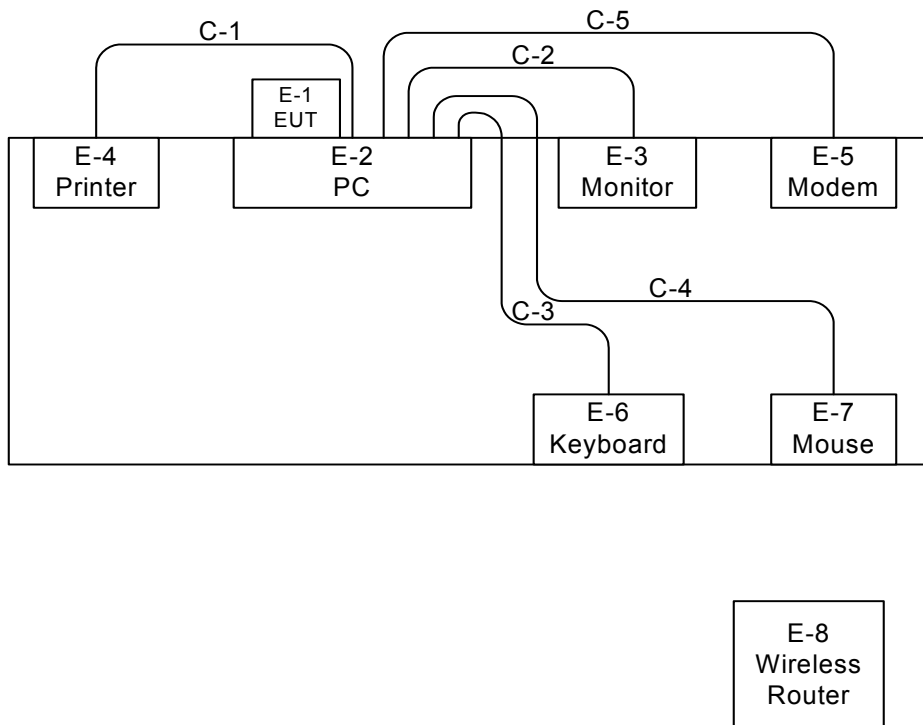

- C-1: Parallel Cable
- C-2: D-Sub Cable
- C-3: USB Cable
- C-4: USB Cable
- C-5: RS232 Cable



3.5 DESCRIPTION OF SUPPORT UNITS (RADIATED MODE)

The EUT has been tested as an independent unit together with other necessary accessories or support units. The following support units or accessories were used to form a representative test configuration during the tests.

Item	Equipment	Mfr/Brand	Model/Type No.	FCC ID	Series No.	Note
E-1	150Mbps Wireless-N USB Adapter	netis	WF-2103	T58WF2103R1	N/A	EUT
E-2	Notebook	DELL	1420	DOC	N/A	

Item	Shielded Type	Ferrite Core	Length	Note

Note:

- (1) The support equipment was authorized by Declaration of Confirmation.
- (2) For detachable type I/O cable should be specified the length in cm in 『Length』 column.



3.6 DESCRIPTION OF SUPPORT UNITS (CONDUCTED MODE)

The EUT has been tested as an independent unit together with other necessary accessories or support units. The following support units or accessories were used to form a representative test configuration during the tests.

Item	Equipment	Mfr/Brand	Model/Type No.	FCC ID	Series No.	Note
E-1	150Mbps Wireless-N USB Adapter	netis	WF-2103	T58WF2103R1	N/A	EUT
E-2	PC	Dell 745	DCSM	DOC	G7K832X	
E-3	LCD monitor	Dell	E177FPc	DOC	CNOFJ179-641 80-6AG-1WNS	
E-4	Printer	Lenovo	M630	DOC	SP00335371	
E-5	Modem	Lenovo	LEM56SP	DOC	004000137896	
E-6	USB Keyboard	Dell	L100	DOC	CNORH659658 9071T08NE	
E-7	USB Mouse	Dell	MO56UOA	DOC	FQJ000BS	
E-8	ROUTER	Tenda	W268R	DOC	N/A	

Item	Shielded Type	Ferrite Core	Length	Note
C-1	YES	NO	1.8M	
C-2	YES	YES	1.8M	
C-3	YES	YES	1.8M	
C-4	YES	NO	1.8M	
C-5	NO	NO	1.8M	

Note:

- (1) The support equipment was authorized by Declaration of Confirmation.
- (2) For detachable type I/O cable should be specified the length in cm in 『Length』 column.



4. EMC EMISSION TEST

4.1 CONDUCTED EMISSION MEASUREMENT

4.1.1 POWER LINE CONDUCTED EMISSION Limits (Frequency Range 150KHz-30MHz)

FREQUENCY (MHz)	Class A (dBuV)		Class B (dBuV)		Standard
	Quasi-peak	Average	Quasi-peak	Average	
0.15 -0.5	79.00	66.00	66 - 56 *	56 - 46 *	CISPR
0.50 -5.0	73.00	60.00	56.00	46.00	CISPR
5.0 -30.0	73.00	60.00	60.00	50.00	CISPR

0.15 -0.5	79.00	66.00	66 - 56 *	56 - 46 *	FCC
0.50 -5.0	73.00	60.00	56.00	46.00	FCC
5.0 -30.0	73.00	60.00	60.00	50.00	FCC

Note:

- (1) The tighter limit applies at the band edges.
- (2) The limit of " * " marked band means the limitation decreases linearly with the logarithm of the frequency in the range.

4.1.2 MEASUREMENT INSTRUMENTS LIST AND SETTING

Item	Kind of Equipment	Manufacturer	Type No.	Serial No.	Calibrated until
1	LISN	EMCO	3816/2	00052765	May.26.2012
2	LISN	R&S	ENV216	100087	May.26.2012
3	Test Cable	N/A	C_17	N/A	Mar.30.2012
4	EMI TEST RECEIVER	R&S	ESCS30	826547/022	May.26.2012
5	50Ω Terminator	SHX	TF2-3G-A	08122902	May.26.2012

Remark: " N/A" denotes No Model Name. , Serial No. or No Calibration specified.

The following table is the setting of the receiver

Receiver Parameters	Setting
Attenuation	10 dB
Start Frequency	0.15 MHz
Stop Frequency	30 MHz
IF Bandwidth	9 kHz

4.1.3 TEST PROCEDURE

- The EUT was placed 0.8 meters from the horizontal ground plane with EUT being connected to the power mains through a line impedance stabilization network (LISN). All other support equipments powered from additional LISN(s). The LISN provide 50 Ohm/ 50uH of coupling impedance for the measuring instrument.
- Interconnecting cables that hang closer than 40 cm to the ground plane shall be folded back and forth in the center forming a bundle 30 to 40 cm long.
- I/O cables that are not connected to a peripheral shall be bundled in the center. The end of the cable may be terminated, if required, using the correct terminating impedance. The overall length shall not exceed 1 m.
- LISN at least 80 cm from nearest part of EUT chassis.
- For the actual test configuration, please refer to the related Item –EUT Test Photos.

4.1.4 DEVIATION FROM TEST STANDARD

No deviation

4.1.5 TEST SETUP

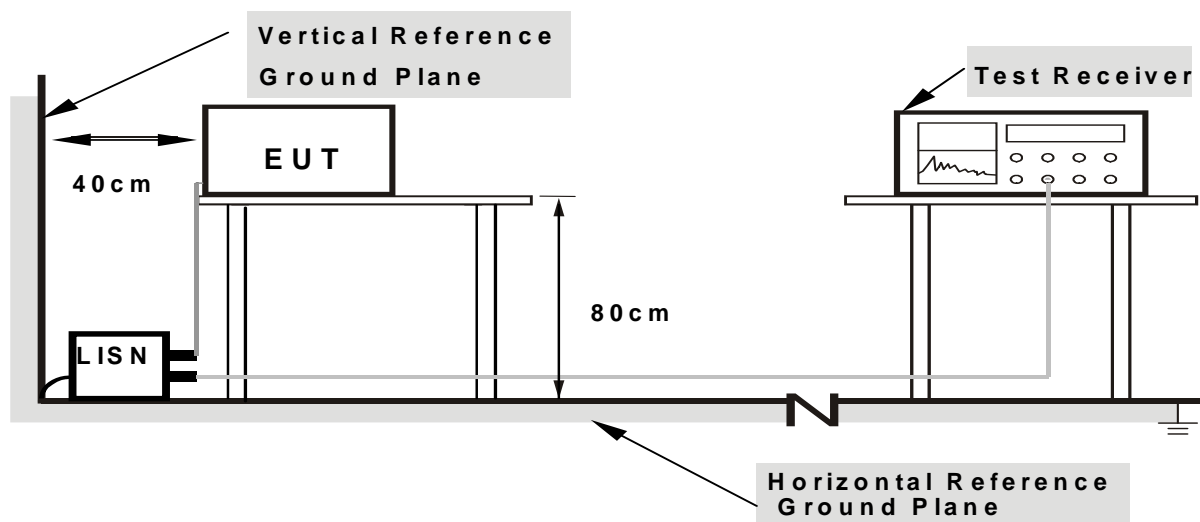

Note: 1. Support units were connected to second LISN.

2. Both of LISNs (AMN) are 80 cm from EUT and at least 80 cm from other units and other metal planes

4.1.6 EUT OPERATING CONDITIONS

The EUT was configured for testing in a typical fashion (as a customer would normally use it). The EUT has been programmed to continuously transmit during test. This operating condition was tested and used to collect the included data.

The EUT was programmed to be in continuously transmitting mode.



4.1.7 TEST RESULTS

EUT :	150Mbps Wireless-N USB Adapter	Model Name :	WF-2103
Temperature :	25 °C	Relative Humidity :	55%
Pressure :	1010hPa	Test Power :	AC 120V/60Hz
Test Mode :	Normal Link		

Freq. (MHz)	Terminal L/N	Measured(dBuV)		Limits(dBuV)		Margin (dB)	Note
		QP-Mode	AV-Mode	QP-Mode	AV-Mode		
0.16	Line	50.46	*	65.43	55.43	-14.97	(QP)
0.29	Line	44.11	*	60.40	50.40	-16.29	(QP)
0.47	Line	41.30	*	56.44	46.44	-15.14	(QP)
0.91	Line	37.03	*	56.00	46.00	-18.97	(QP)
7.70	Line	35.46	*	60.00	50.00	-24.54	(QP)
12.32	Line	42.86	*	60.00	50.00	-17.14	(QP)

Remark

- (1) All readings are QP Mode value unless otherwise stated AVG in column of 'Note'. If the QP Mode Measured value compliance with the QP Limits and lower than AVG Limits, the EUT shall be deemed to meet both QP & AVG Limits and then only QP Mode was measured, but AVG Mode didn't perform. In this case, a "*" marked in AVG Mode column of Interference Voltage Measured.
- (2) Measuring frequency range from 150KHz to 30MHz.

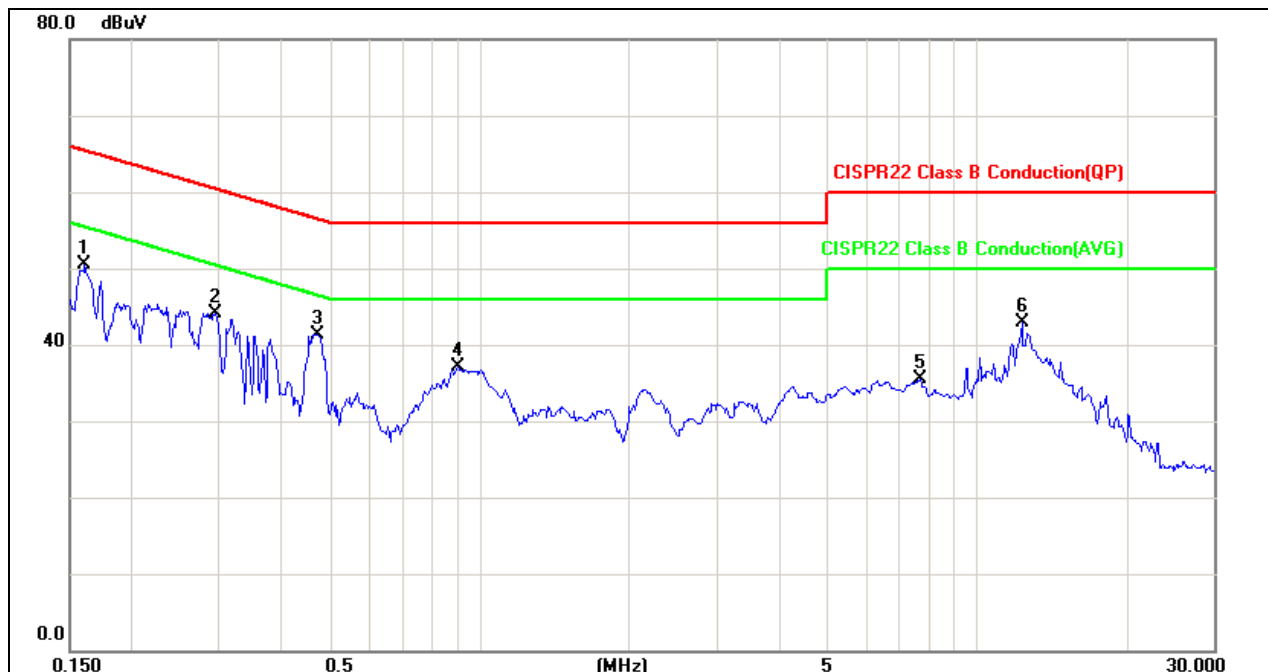



EUT :	150Mbps Wireless-N USB Adapter	Model Name :	WF-2103
Temperature :	25 °C	Relative Humidity :	55%
Pressure :	1010hPa	Test Power :	AC 120V/60Hz
Test Mode :	Normal Link		

Freq. (MHz)	Terminal L/N	Measured(dBuV)		Limits(dBuV)		Margin (dB)	Note
		QP-Mode	AV-Mode	QP-Mode	AV-Mode		
0.16	Neutral	50.49	*	65.65	55.65	-15.16	(QP)
0.23	Neutral	46.81	*	62.57	52.57	-15.76	(QP)
0.47	Neutral	40.47	*	56.58	46.58	-16.11	(QP)
0.76	Neutral	36.65	*	56.00	46.00	-19.35	(QP)
1.53	Neutral	38.46	*	56.00	46.00	-17.54	(QP)
9.95	Neutral	44.55	*	60.00	50.00	-15.45	(QP)

Remark

- (1) All readings are QP Mode value unless otherwise stated AVG in column of 'Note'. If the QP Mode Measured value compliance with the QP Limits and lower than AVG Limits, the EUT shall be deemed to meet both QP & AVG Limits and then only QP Mode was measured, but AVG Mode didn't perform. In this case, a "*" marked in AVG Mode column of Interference Voltage Measured.
- (2) Measuring frequency range from 150KHz to 30MHz.

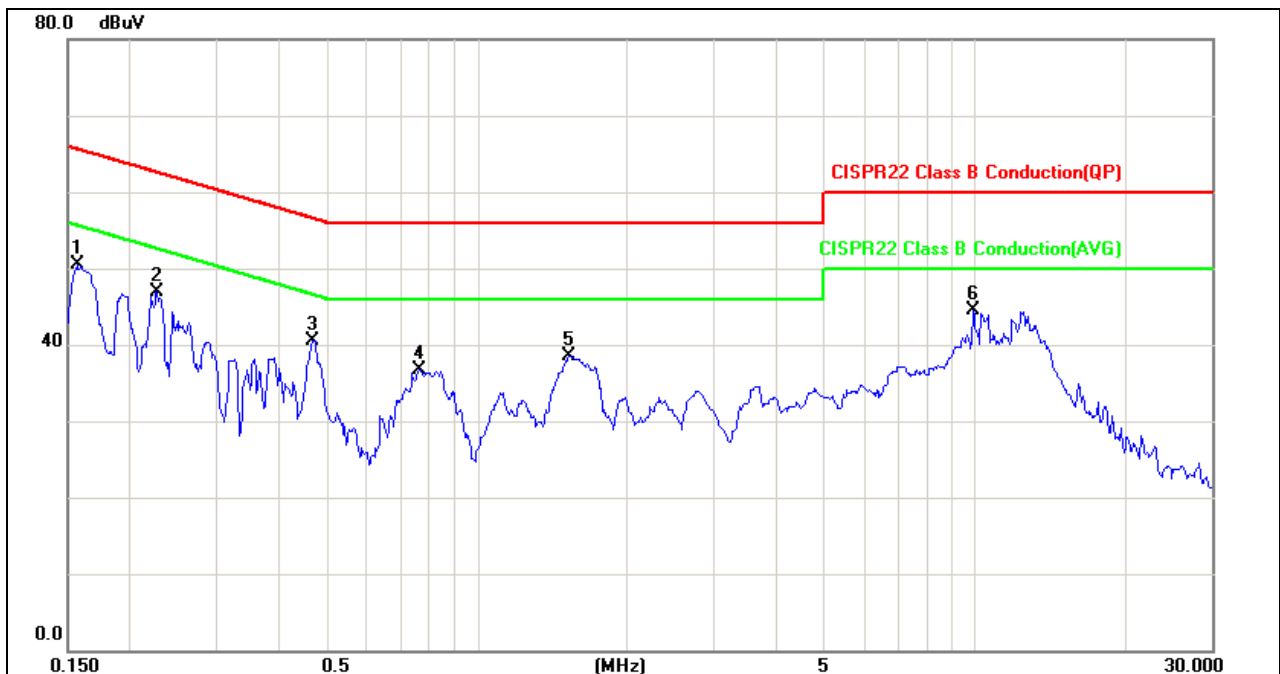



4.2 RADIATED EMISSION MEASUREMENT

4.2.1 RADIATED EMISSION LIMITS (Frequency Range 9KHz-1000MHz)

20dBc in any 100 kHz bandwidth outside the operating frequency band. In case the emission fall within the restricted band specified on 15.205(a), then the 15.209(a) limit in the table below has to be followed.

Frequencies (MHz)	Field Strength (micorvolts/meter)	Measurement Distance (meters)
0.009~0.490	2400/F(KHz)	300
0.490~1.705	24000/F(KHz)	30
1.705~30.0	30	30
30~88	100	3
88~216	150	3
216~960	200	3
Above 960	500	3

LIMITS OF RADIATED EMISSION MEASUREMENT (Above 1000MHz)

FREQUENCY (MHz)	(dBuV/m) (at 3m)	
	PEAK	AVERAGE
Above 1000	74	54

Notes:

- (1) The limit for radiated test was performed according to FCC PART 15C.
- (2) The tighter limit applies at the band edges.
- (3) Emission level (dBuV/m)=20log Emission level (uV/m).

FREQUENCY RANGE OF RADIATED MEASUREMENT (For unintentional radiators)

Highest frequency generated or Upper frequency of measurement used in the device or on which the device operates or tunes (MHz)	Range (MHz)
Below 1.705	30
1.705 – 108	1000
108 – 500	2000
500 – 1000	5000
Above 1000	5 th harmonic of the highest frequency or 40 GHz, whichever is lower



4.2.2 MEASUREMENT INSTRUMENTS LIST AND SETTING

Item	Kind of Equipment	Manufacturer	Type No.	Serial No.	Calibrated until
1	Antenna	Schwarzbeck	VULB9160	9160-3232	Jun .04.2012
2	Amplifier	HP	8447D	2944A09673	May.26.2012
3	Test Receiver	R&S	ESCI	100382	May.26.2012
4	Test Cable	N/A	C-01_CB03	N/A	Jul.01.2012
5	Controller	CT	SC100	N/A	N/A
6	Antenna	ETS	3115	00075789	May.26.2012
7	Amplifier	Agilent	8449B	3008A02274	May.26.2012
8	Spectrum	Agilent	E4408B	US39240143	Nov.26.2011
9	Test Cable	HUBER+SUHNER	C-45	N/A	May.04.2012
10	Active Loop Antenna	R&S	HFH2-Z2	830749/020	May.26.2012
11	Broad-Band Horn Antenna	Schwarzbeck	BBHA 9170	9170319	Aug.15.2012

Remark: " N/A" denotes No Model Name / Serial No. and No Calibration specified.

Spectrum Parameter	Setting
Attenuation	Auto
Start Frequency	1000 MHz
Stop Frequency	10th carrier harmonic
RB / VB (Emission in restricted band)	1MHz / 1MHz for Peak, 1 MHz / 10Hz for Average

Receiver Parameter	Setting
Attenuation	Auto
Start ~ Stop Frequency	9kHz~150kHz / RB 200Hz for QP
Start ~ Stop Frequency	150kHz~30MHz / RB 9kHz for QP
Start ~ Stop Frequency	30MHz~1000MHz / RB 120kHz for QP



4.2.3 TEST PROCEDURE

- a. The measuring distance of at 3 m shall be used for measurements at frequency up to 1GHz. For frequencies above 1GHz, any suitable measuring distance may be used.
- b. The EUT was placed on the top of a rotating table 0.8 meters above the ground at a 3 meter semi-anechoic chamber. The table was rotated 360 degrees to determine the position of the highest radiation.
- c. The height of the equipment or of the substitution antenna shall be 0.8 m; the height of the test antenna shall vary between 1 m to 4 m. Both horizontal and vertical polarizations of the antenna are set to make the measurement.
- d. The initial step in collecting conducted emission data is a spectrum analyzer peak detector mode pre-scanning the measurement frequency range. Significant peaks are then marked and then Quasi Peak detector mode re-measured.
- e. If the Peak Mode measured value compliance with and lower than Quasi Peak Mode Limit, the EUT shall be deemed to meet QP Limits and then no additional QP Mode measurement performed.
- f. For the actual test configuration, please refer to the related Item –EUT Test Photos.

4.2.4 DEVIATION FROM TEST STANDARD

No deviation

4.2.5 TEST SETUP

(A) Radiated Emission Test Set-Up Frequency Below 1 GHz

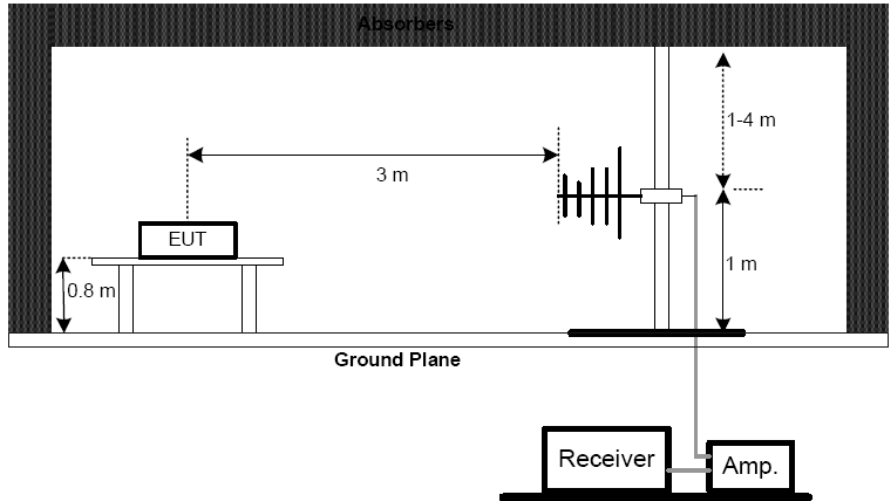

(B) Radiated Emission Test Set-Up Frequency Above 1 GHz

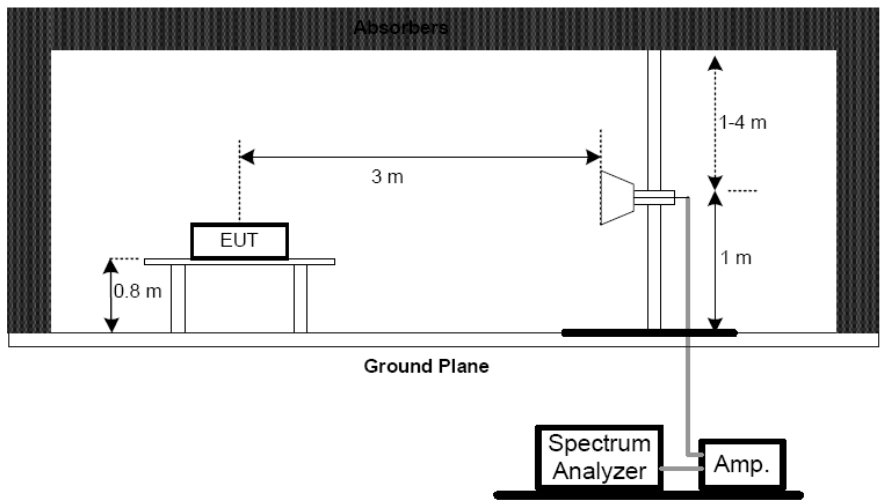

4.2.6 EUT OPERATING CONDITIONS

The EUT tested system was configured as the statements of 4.1.6 Unless otherwise a special operating condition is specified in the follows during the testing.



4.2.7 TEST RESULTS (BETWEEN 30 – 1000 MHZ)

EUT :	150Mbps Wireless-N USB Adapter	Model Name :	WF-2103
Temperature :	25 °C	Relative Humidity :	51 %
Pressure :	1010 hPa	Test Voltage :	AC 120V/60Hz
Test Mode :	TX B MODE 2412MHZ		

Freq. (MHz)	Ant. HV	Reading(RA) (dBuV)	Corr.Factor(CF) (dB)	Measured(FS) (dBuV/m)	Limits(QP) (dBuV/m)	Margin (dB)	Note
38.73	V	47.68	-15.05	32.63	40.00	- 7.37	
188.11	V	54.24	-23.84	30.40	43.50	- 13.10	
461.65	V	41.78	-13.69	28.09	46.00	- 17.91	
480.08	V	45.43	-13.10	32.33	46.00	- 13.67	
513.06	V	46.64	-12.01	34.63	46.00	- 11.37	
666.32	V	40.32	-8.83	31.49	46.00	- 14.51	

Remark :

- (1) Reading in which marked as QP or Peak means measurements by using are Quasi-Peak Mode or Peak Mode with Detector BW=120KHz ; SPA setting in RBW=120KHz, VBW =120KHz, Swp. Time = 0.3 sec./MHz ◦
- (2) All readings are Peak unless otherwise stated QP in column of 『Note』 . Peak denotes that the Peak reading compliance with the QP Limits and then QP Mode measurement didn't perform ◦
- (3) Measuring frequency range from 30MHz to 1000MHz ◦
- (4) If the peak scan value lower limit more than 20dB, then this signal data does not show in table ◦

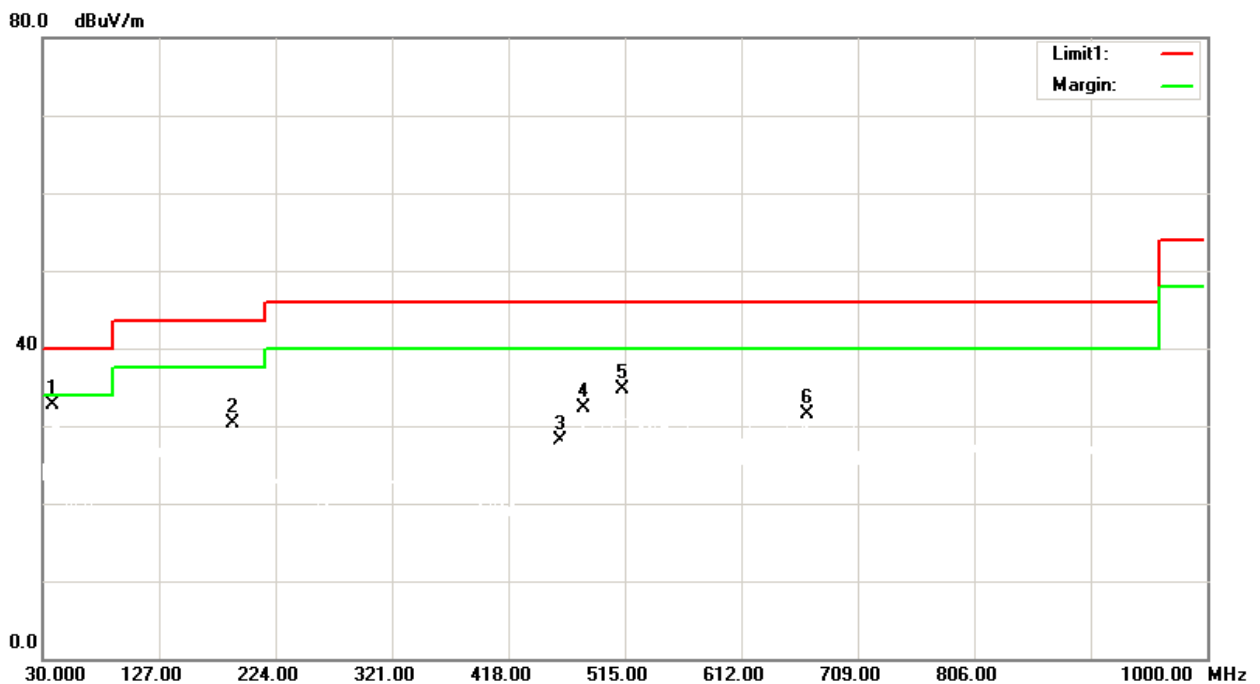



EUT :	150Mbps Wireless-N USB Adapter	Model Name :	WF-2103
Temperature :	25 °C	Relative Humidity :	51 %
Pressure :	1010 hPa	Test Voltage :	AC 120V/60Hz
Test Mode :	TX B MODE 2412MHz		

Freq. (MHz)	Ant. H/V	Reading(RA) (dBuV)	Corr.Factor(CF) (dB)	Measured(FS) (dBuV/m)	Limits(QP) (dBuV/m)	Margin (dB)	Note
40.67	H	47.37	-16.72	30.65	40.00	- 9.35	
165.80	H	54.00	-21.06	32.94	43.50	- 10.56	
296.75	H	52.50	-17.12	35.38	46.00	- 10.62	
399.57	H	45.10	-14.12	30.98	46.00	- 15.02	
481.05	H	48.26	-13.06	35.20	46.00	- 10.80	
666.32	H	42.46	-8.83	33.63	46.00	- 12.37	

Remark :

- (1) Reading in which marked as QP or Peak means measurements by using are Quasi-Peak Mode or Peak Mode with Detector BW=120KHz ; SPA setting in RBW=120KHz, VBW =120KHz, Swp. Time = 0.3 sec./MHz ◦
- (2) All readings are Peak unless otherwise stated QP in column of 『Note』 . Peak denotes that the Peak reading compliance with the QP Limits and then QP Mode measurement didn't perform ◦
- (3) Measuring frequency range from 30MHz to 1000MHz ◦
- (4) If the peak scan value lower limit more than 20dB, then this signal data does not show in table ◦

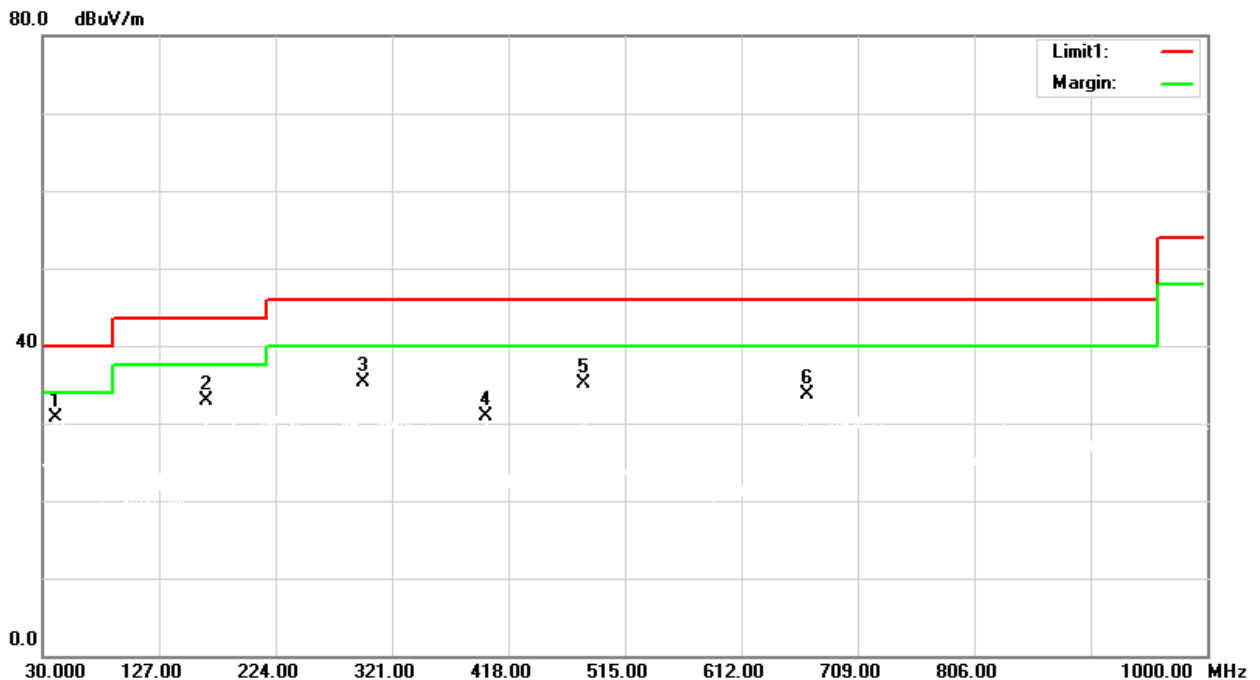



4.2.8 TEST RESULTS (ABOVE 1000 MHZ)

EUT :	150Mbps Wireless-N USB Adapter	Model Name :	WF-2103
Temperature :	25 °C	Relative Humidity :	51 %
Pressure :	1010 hPa	Test Voltage :	AC 120V/60Hz
Test Mode :	TX B MODE 2412MHz		

Freq. (MHz)	Ant.Pol. H/V	Reading		Ant./CF CF(dB)	Act.		Limit		Note
		Peak (dBuV)	AV (dBuV)		Peak (dBuV/m)	AV (dBuV/m)	Peak (dBuV/m)	AV (dBuV/m)	
2390.00	V	20.58	10.88	31.54	52.12	42.42	74.00	54.00	X/E
2412.42	V	63.76	59.54	31.57	95.33	91.11			X/F
4824.16	V	46.62	41.76	6.00	52.62	47.76	74.00	54.00	X/H

Remark :

- (1) All readings are Peak unless otherwise stated QP in column of 『Note』 . Peak denotes that the Peak reading compliance with the QP Limits and then QP Mode measurement didn't perform ◦
- (2) Measuring frequency range from 30MHz to 1000MHz or the 10th harmonic of highest fundamental frequency ◦ "F" denotes fundamental frequency; "H" denotes spurious frequency. "E" denotes band edge frequency. (This judgment method includes the Band Edge Requirement.)
- (3) Radiated emissions measured in frequency range above 1000MHz were made with an instrument using Peak detector mode and AV detector mode of the emission ◦
- (4) Data of measurement within this frequency range shown " * " in the table above means the reading of emissions are attenuated more than 20dB below the permissible limits or the field strength is too small to be measured.
- (5) A preamp and high pass filter were used for this test in order to provide sufficient measurement sensitivity.
- (6) EUT Orthogonal Axis :
"X" - denotes Laid on Table ; "Y" - denotes Vertical Stand ; "Z" - denotes Side Stand
- (7) During the measurements above 1 GHz it is taken care of that the EUT is always within the 3 dB cone of radiation BW of the used antenna



TX CH01 (Above 1000 MHz, Vertical)

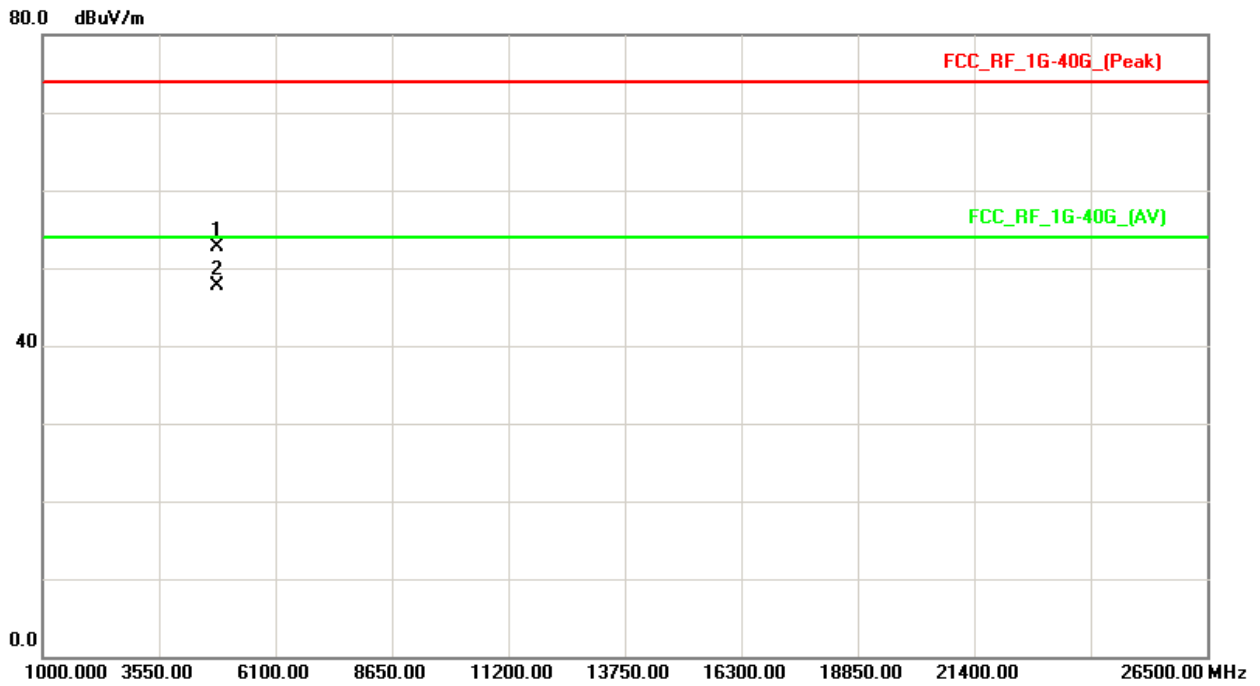
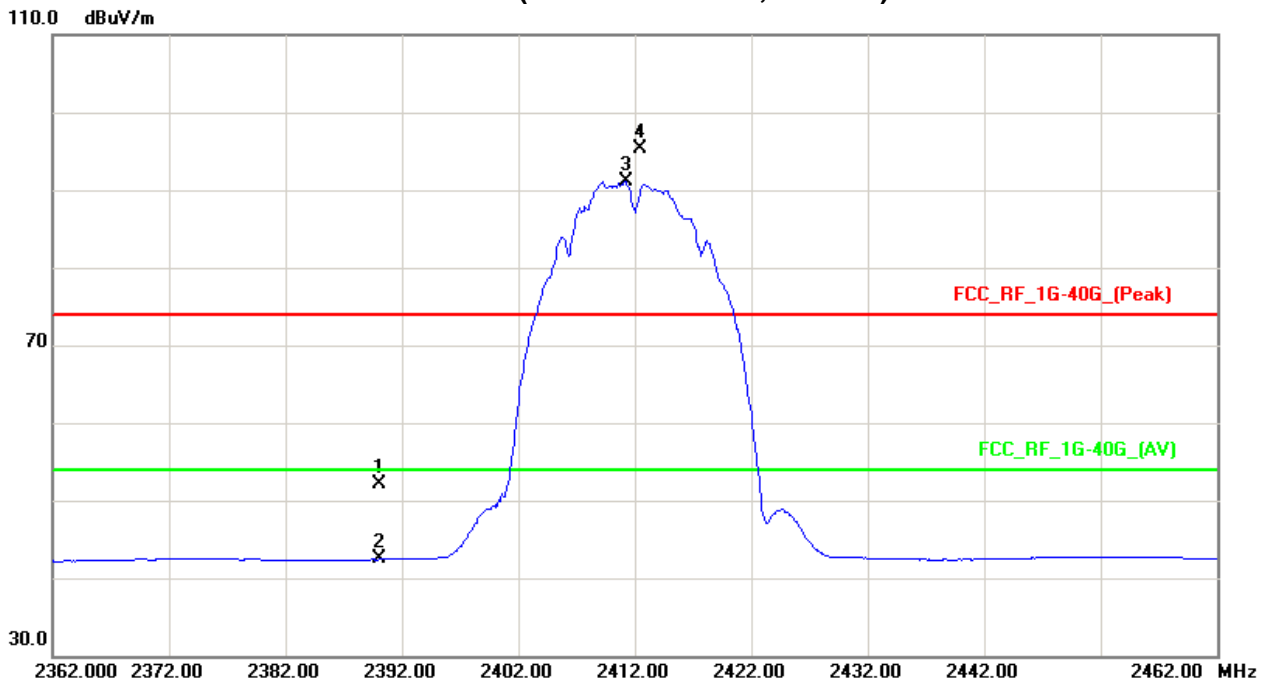



EUT :	150Mbps Wireless-N USB Adapter	Model Name :	WF-2103
Temperature :	25 °C	Relative Humidity :	51 %
Pressure :	1010 hPa	Test Voltage :	AC 120V/60Hz
Test Mode :	TX B MODE 2412MHz		

Freq. (MHz)	Ant.Pol. H/V	Reading		Ant./CF CF(dB)	Act.		Limit		Note
		Peak (dBuV)	AV (dBuV)		Peak (dBuV/m)	AV (dBuV/m)	Peak (dBuV/m)	AV (dBuV/m)	
2390.00	H	21.20	11.04	31.54	52.74	42.58	74.00	54.00	X/E
2411.30	H	66.70	63.16	31.57	98.27	94.73			X/F
4824.20	H	42.06	37.90	6.00	48.06	43.90	74.00	54.00	X/H

Remark :

- (1) All readings are Peak unless otherwise stated QP in column of 『Note』 . Peak denotes that the Peak reading compliance with the QP Limits and then QP Mode measurement didn't perform ◦
- (2) Measuring frequency range from 30MHz to 1000MHz or the 10th harmonic of highest fundamental frequency ◦ "F" denotes fundamental frequency; "H" denotes spurious frequency. "E" denotes band edge frequency. (This judgment method includes the Band Edge Requirement.)
- (3) Radiated emissions measured in frequency range above 1000MHz were made with an instrument using Peak detector mode and AV detector mode of the emission ◦
- (4) Data of measurement within this frequency range shown " * " in the table above means the reading of emissions are attenuated more than 20dB below the permissible limits or the field strength is too small to be measured.
- (5) A preamp and high pass filter were used for this test in order to provide sufficient measurement sensitivity.
- (6) EUT Orthogonal Axis :
"X" - denotes Laid on Table ; "Y" - denotes Vertical Stand ; "Z" - denotes Side Stand
- (7) During the measurements above 1 GHz it is taken care of that the EUT is always within the 3 dB cone of radiation BW of the used antenna



TX CH01 (Above 1000 MHz, Horizontal)

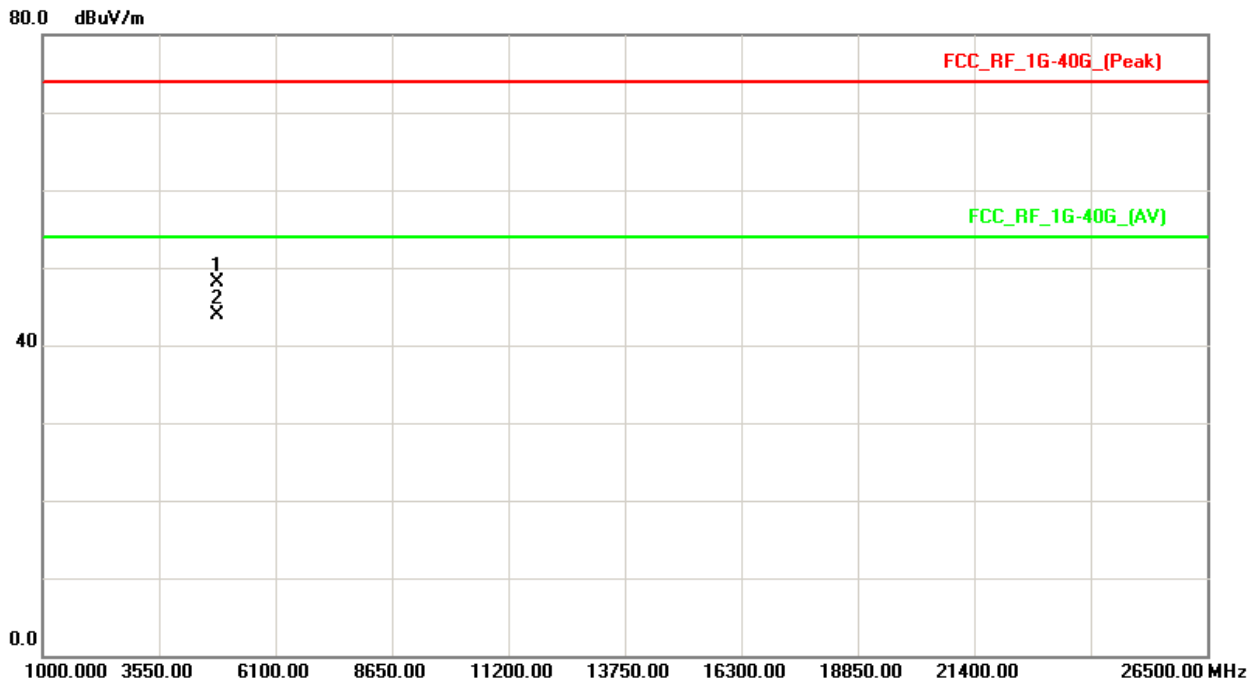
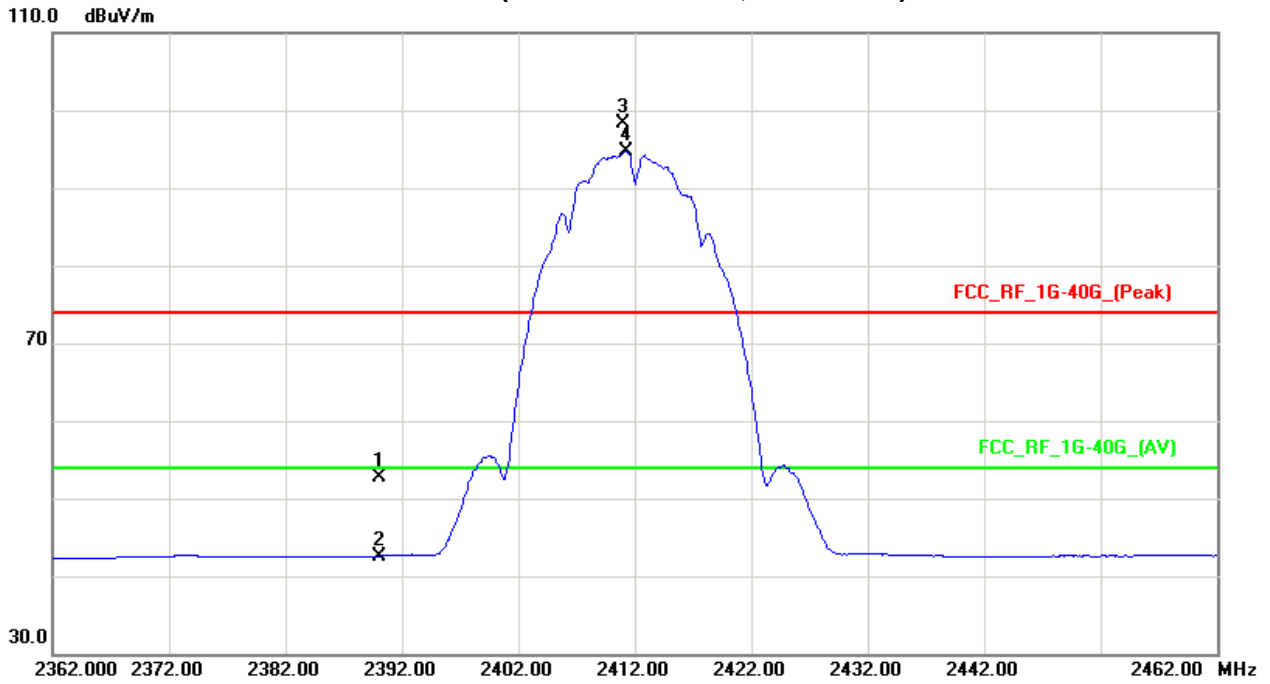



EUT :	150Mbps Wireless-N USB Adapter	Model Name :	WF-2103
Temperature :	25 °C	Relative Humidity :	51 %
Pressure :	1010 hPa	Test Voltage :	AC 120V/60Hz
Test Mode :	TX B MODE 2437MHz		

Freq.	Ant.Pol.	Reading		Ant./CF	Act.		Limit		Note
		Peak	AV		Peak	AV	Peak	AV	
(MHz)	H/V	(dBuV)	(dBuV)	CF(dB)	(dBuV/m)	(dBuV/m)	(dBuV/m)	(dBuV/m)	
2438.27	V	63.02	59.16	31.62	94.64	90.78			X/F
4874.26	V	45.11	39.56	6.15	51.26	45.71	74.00	54.00	X/H

Remark :

- (1) All readings are Peak unless otherwise stated QP in column of 『Note』 . Peak denotes that the Peak reading compliance with the QP Limits and then QP Mode measurement didn't perform ◦
- (2) Measuring frequency range from 30MHz to 1000MHz or the 10th harmonic of highest fundamental frequency ◦ “F” denotes fundamental frequency; “H” denotes spurious frequency. “E” denotes band edge frequency. (This judgment method includes the Band Edge Requirement.)
- (3) Radiated emissions measured in frequency range above 1000MHz were made with an instrument using Peak detector mode and AV detector mode of the emission ◦
- (4) Data of measurement within this frequency range shown “ * ” in the table above means the reading of emissions are attenuated more than 20dB below the permissible limits or the field strength is too small to be measured.
- (5) A preamp and high pass filter were used for this test in order to provide sufficient measurement sensitivity.
- (6) EUT Orthogonal Axis :
“X” - denotes Laid on Table ; ”Y” - denotes Vertical Stand ; ”Z” - denotes Side Stand
- (7) During the measurements above 1 GHz it is taken care of that the EUT is always within the 3 dB cone of radiation BW of the used antenna



TX CH06 (Above 1000 MHz, Vertical)

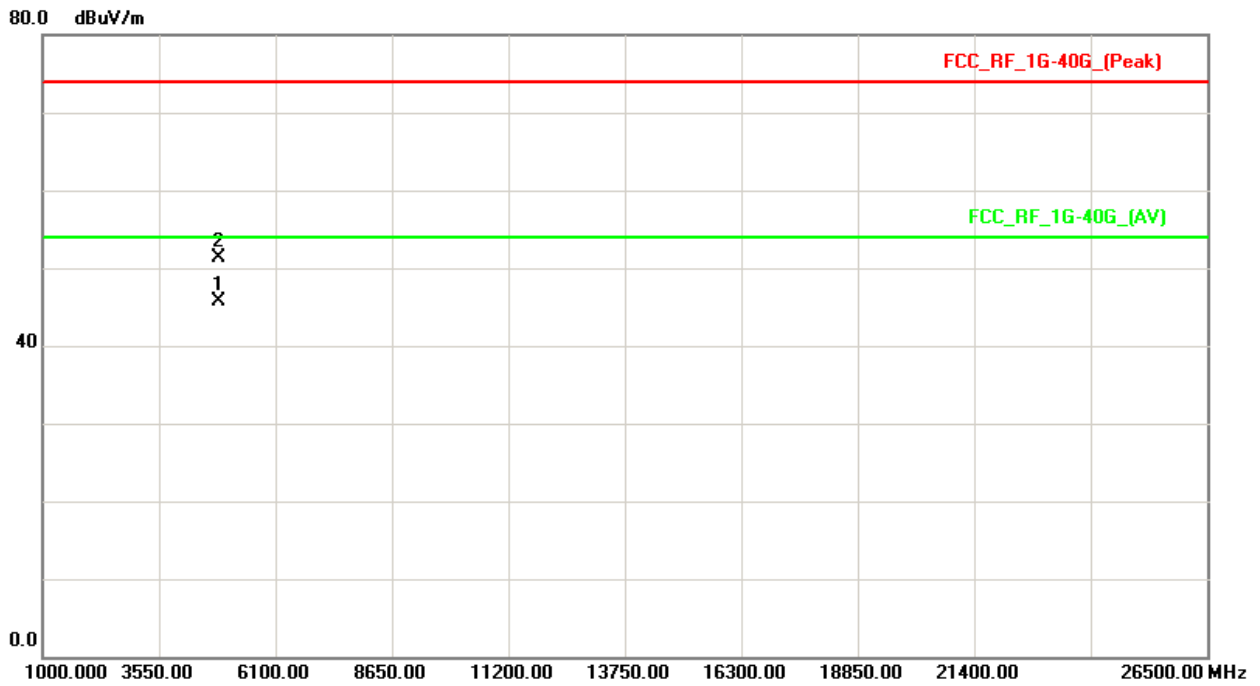
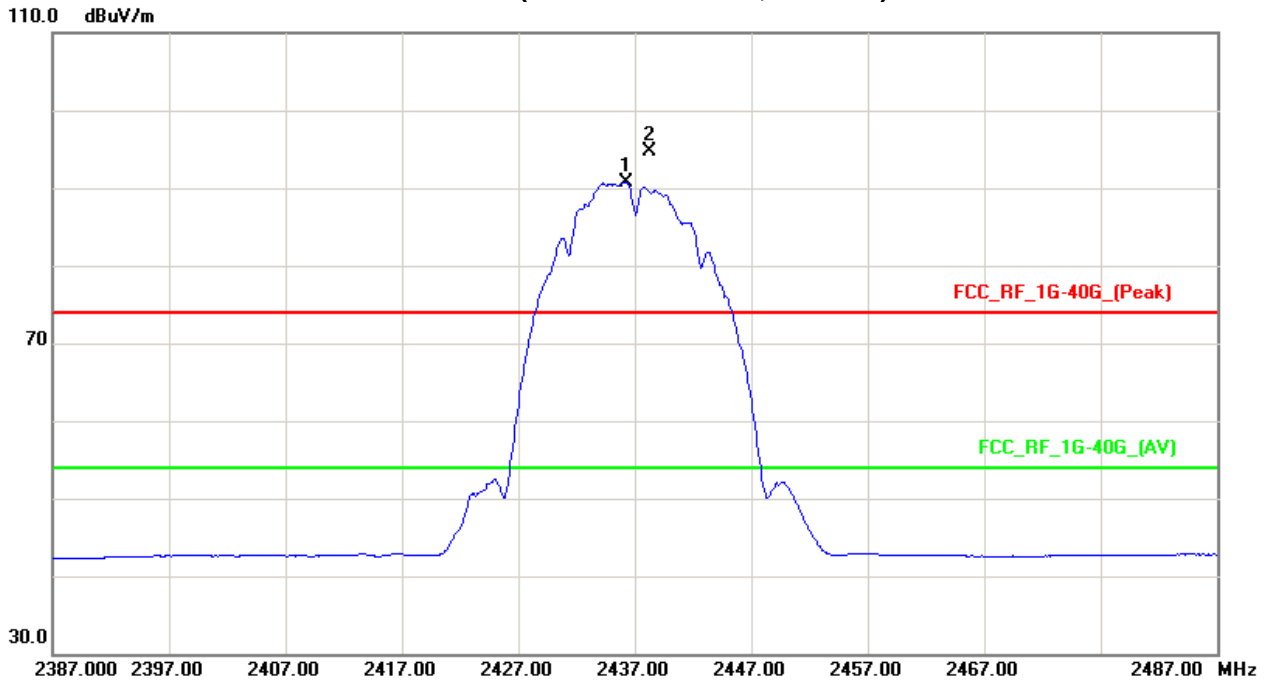



EUT :	150Mbps Wireless-N USB Adapter	Model Name :	WF-2103
Temperature :	25 °C	Relative Humidity :	51 %
Pressure :	1010 hPa	Test Voltage :	AC 120V/60Hz
Test Mode :	TX B MODE 2437MHz		

Freq.	Ant.Pol.	Reading		Ant./CF	Act.		Limit		Note
		Peak	AV		Peak	AV	Peak	AV	
(MHz)	H/V	(dBuV)	(dBuV)	CF(dB)	(dBuV/m)	(dBuV/m)	(dBuV/m)	(dBuV/m)	
2438.00	H	67.74	64.00	31.62	99.36	95.62			X/F
4874.05	H	39.87	34.04	6.15	46.02	40.19	74.00	54.00	X/H

Remark :

- (1) All readings are Peak unless otherwise stated QP in column of 『Note』 . Peak denotes that the Peak reading compliance with the QP Limits and then QP Mode measurement didn't perform ◦
- (2) Measuring frequency range from 30MHz to 1000MHz or the 10th harmonic of highest fundamental frequency ◦ "F" denotes fundamental frequency; "H" denotes spurious frequency. "E" denotes band edge frequency. (This judgment method includes the Band Edge Requirement.)
- (3) Radiated emissions measured in frequency range above 1000MHz were made with an instrument using Peak detector mode and AV detector mode of the emission ◦
- (4) Data of measurement within this frequency range shown " * " in the table above means the reading of emissions are attenuated more than 20dB below the permissible limits or the field strength is too small to be measured.
- (5) A preamp and high pass filter were used for this test in order to provide sufficient measurement sensitivity.
- (6) EUT Orthogonal Axis :
"X" - denotes Laid on Table ; "Y" - denotes Vertical Stand ; "Z" - denotes Side Stand
- (7) During the measurements above 1 GHz it is taken care of that the EUT is always within the 3 dB cone of radiation BW of the used antenna



TX CH06 (Above 1000 MHz, Horizontal)

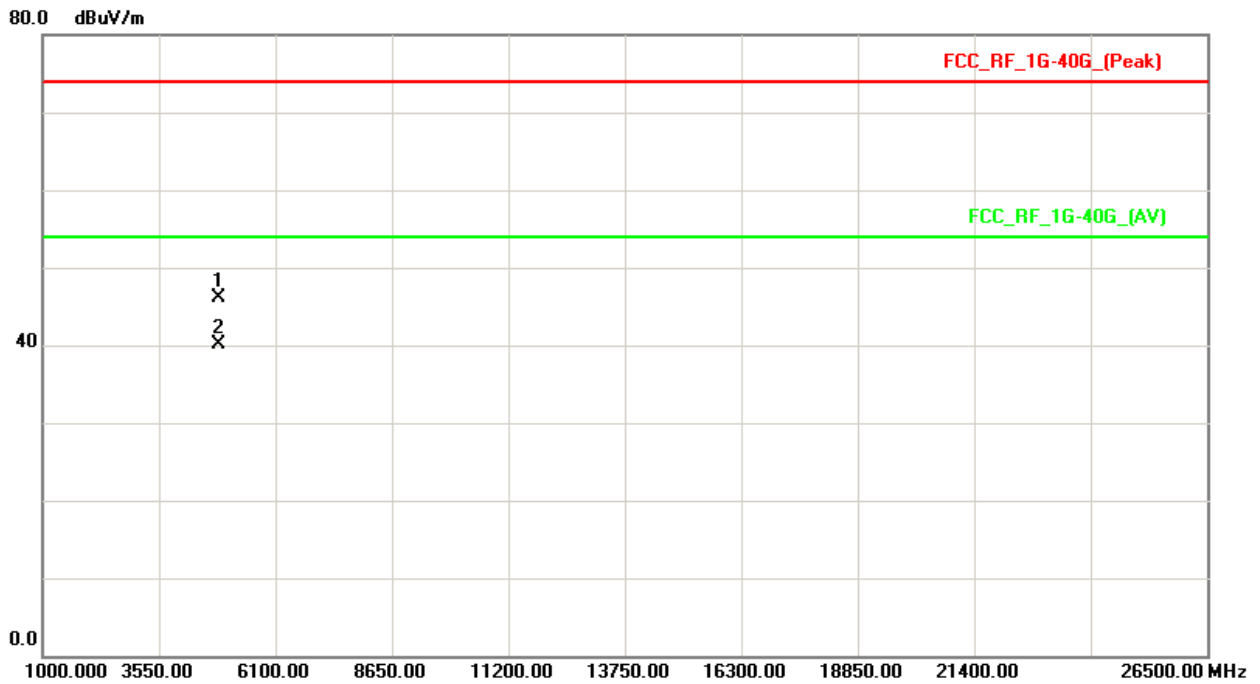
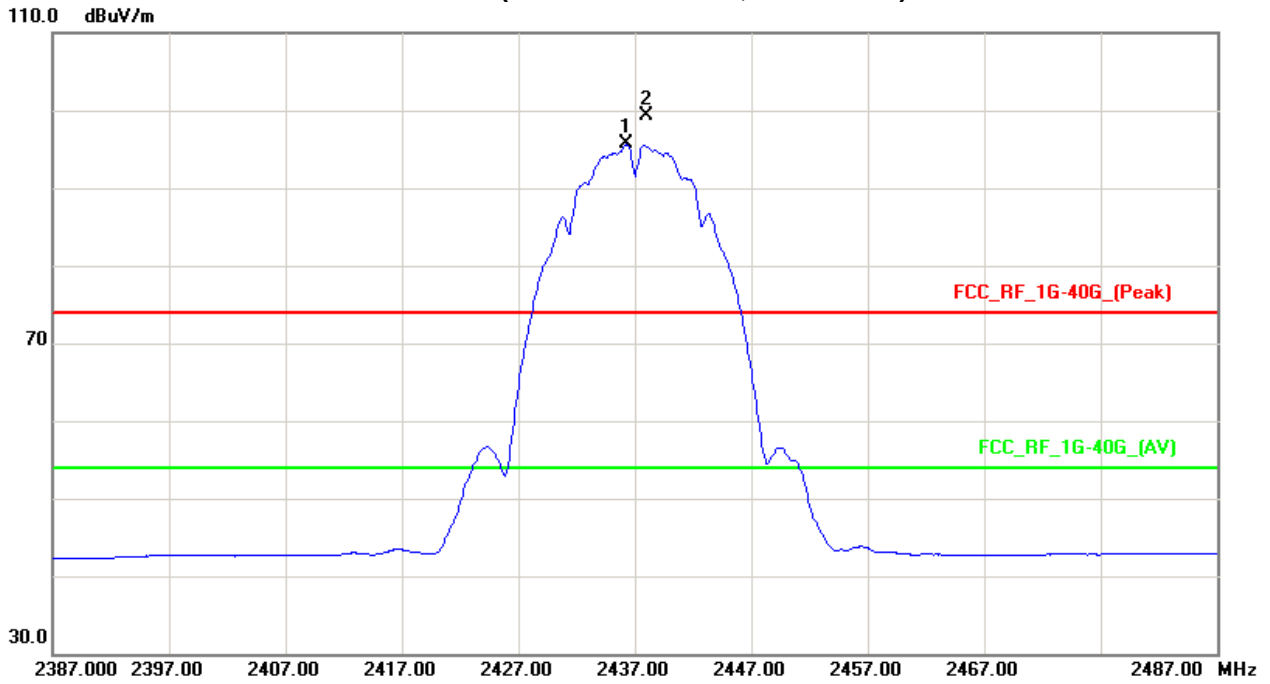



EUT :	150Mbps Wireless-N USB Adapter	Model Name :	WF-2103
Temperature :	25 °C	Relative Humidity :	51 %
Pressure :	1010 hPa	Test Voltage :	AC 120V/60Hz
Test Mode :	TX B MODE 2462MHz		

Freq.	Ant.Pol.	Reading		Ant./CF	Act.		Limit		Note
		Peak	AV		Peak	AV	Peak	AV	
(MHz)	H/V	(dBuV)	(dBuV)	CF(dB)	(dBuV/m)	(dBuV/m)	(dBuV/m)	(dBuV/m)	
2462.80	V	62.93	59.14	31.66	94.59	90.80			X/F
2483.50	V	21.70	11.18	31.70	53.40	42.88	74.00	54.00	X/E
4924.01	V	44.60	38.52	6.35	50.95	44.87	74.00	54.00	X/H

Remark :

- (1) All readings are Peak unless otherwise stated QP in column of 『Note』 . Peak denotes that the Peak reading compliance with the QP Limits and then QP Mode measurement didn't perform ◦
- (2) Measuring frequency range from 30MHz to 1000MHz or the 10th harmonic of highest fundamental frequency ◦ "F" denotes fundamental frequency; "H" denotes spurious frequency. "E" denotes band edge frequency. (This judgment method includes the Band Edge Requirement.)
- (3) Radiated emissions measured in frequency range above 1000MHz were made with an instrument using Peak detector mode and AV detector mode of the emission ◦
- (4) Data of measurement within this frequency range shown " * " in the table above means the reading of emissions are attenuated more than 20dB below the permissible limits or the field strength is too small to be measured.
- (5) A preamp and high pass filter were used for this test in order to provide sufficient measurement sensitivity.
- (6) EUT Orthogonal Axis :
 "X" - denotes Laid on Table ; "Y" - denotes Vertical Stand ; "Z" - denotes Side Stand
- (7) During the measurements above 1 GHz it is taken care of that the EUT is always within the 3 dB cone of radiation BW of the used antenna



TX CH11 (Above 1000 MHz, Vertical)

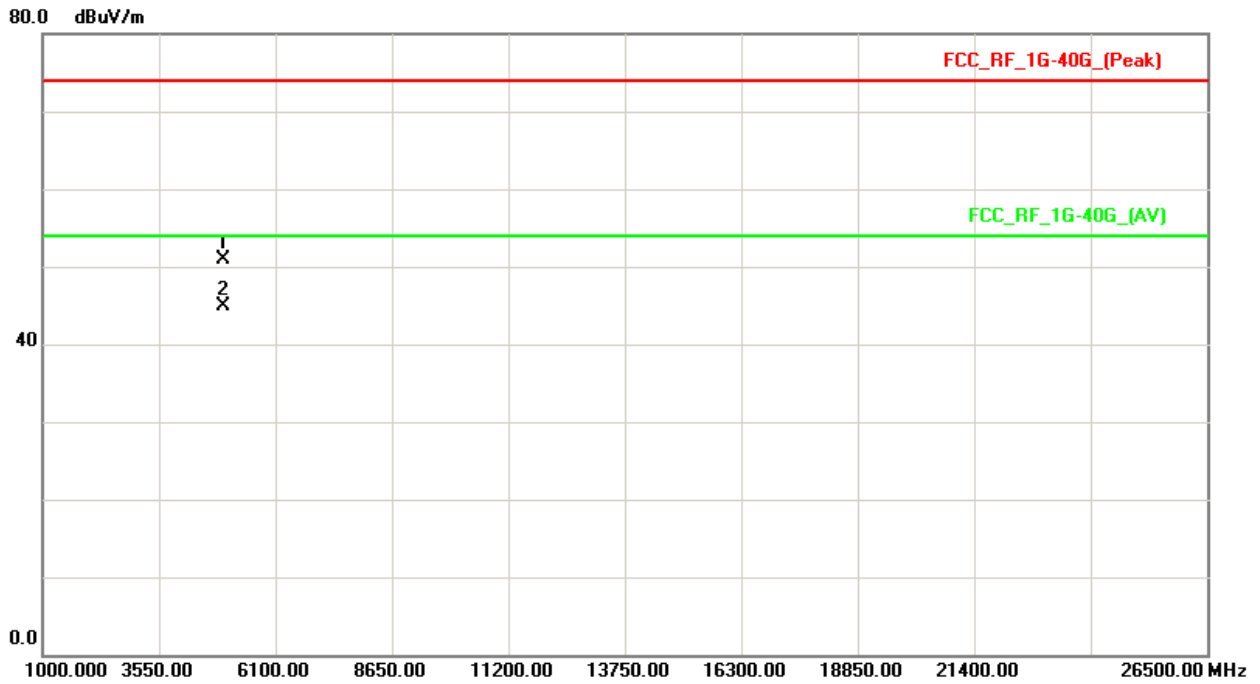
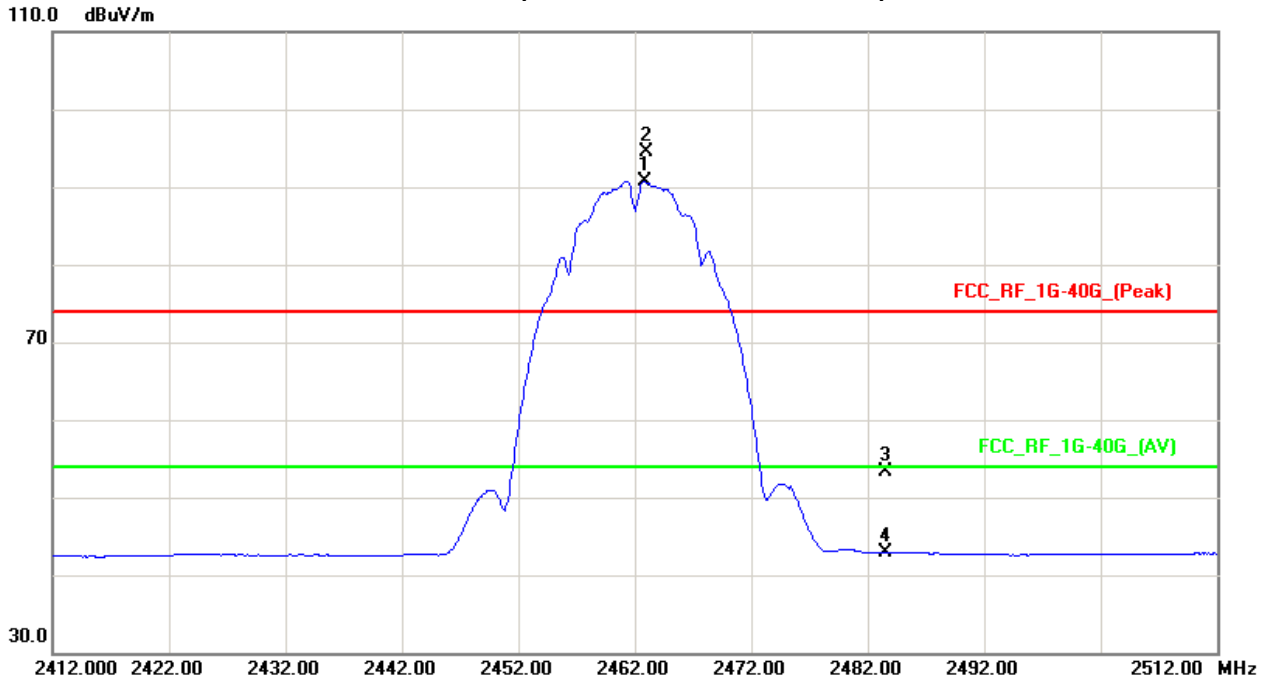



EUT :	150Mbps Wireless-N USB Adapter	Model Name :	WF-2103
Temperature :	20 °C	Relative Humidity :	51 %
Pressure :	1010 hPa	Test Voltage :	AC 120V/60Hz
Test Mode :	TX B MODE 2462MHz		

Freq.	Ant.Pol.	Reading		Ant./CF	Act.		Limit		Note
		Peak	AV		Peak	AV	Peak	AV	
(MHz)	H/V	(dBuV)	(dBuV)	CF(dB)	(dBuV/m)	(dBuV/m)	(dBuV/m)	(dBuV/m)	
2461.10	H	66.37	62.85	31.65	98.02	94.50			X/F
2483.50	H	22.91	11.43	31.70	54.61	43.13	74.00	54.00	X/E
4923.96	H	39.62	33.34	6.30	45.92	39.64	74.00	54.00	X/H

Remark :

- (1) All readings are Peak unless otherwise stated QP in column of 『Note』 . Peak denotes that the Peak reading compliance with the QP Limits and then QP Mode measurement didn't perform ◦
- (2) Measuring frequency range from 30MHz to 1000MHz or the 10th harmonic of highest fundamental frequency ◦ "F" denotes fundamental frequency; "H" denotes spurious frequency. "E" denotes band edge frequency. (This judgment method includes the Band Edge Requirement.)
- (3) Radiated emissions measured in frequency range above 1000MHz were made with an instrument using Peak detector mode and AV detector mode of the emission ◦
- (4) Data of measurement within this frequency range shown " * " in the table above means the reading of emissions are attenuated more than 20dB below the permissible limits or the field strength is too small to be measured.
- (5) A preamp and high pass filter were used for this test in order to provide sufficient measurement sensitivity.
- (6) EUT Orthogonal Axis :
"X" - denotes Laid on Table ; "Y" - denotes Vertical Stand ; "Z" - denotes Side Stand
- (7) During the measurements above 1 GHz it is taken care of that the EUT is always within the 3 dB cone of radiation BW of the used antenna



TX CH11 (Above 1000 MHz, Horizontal)

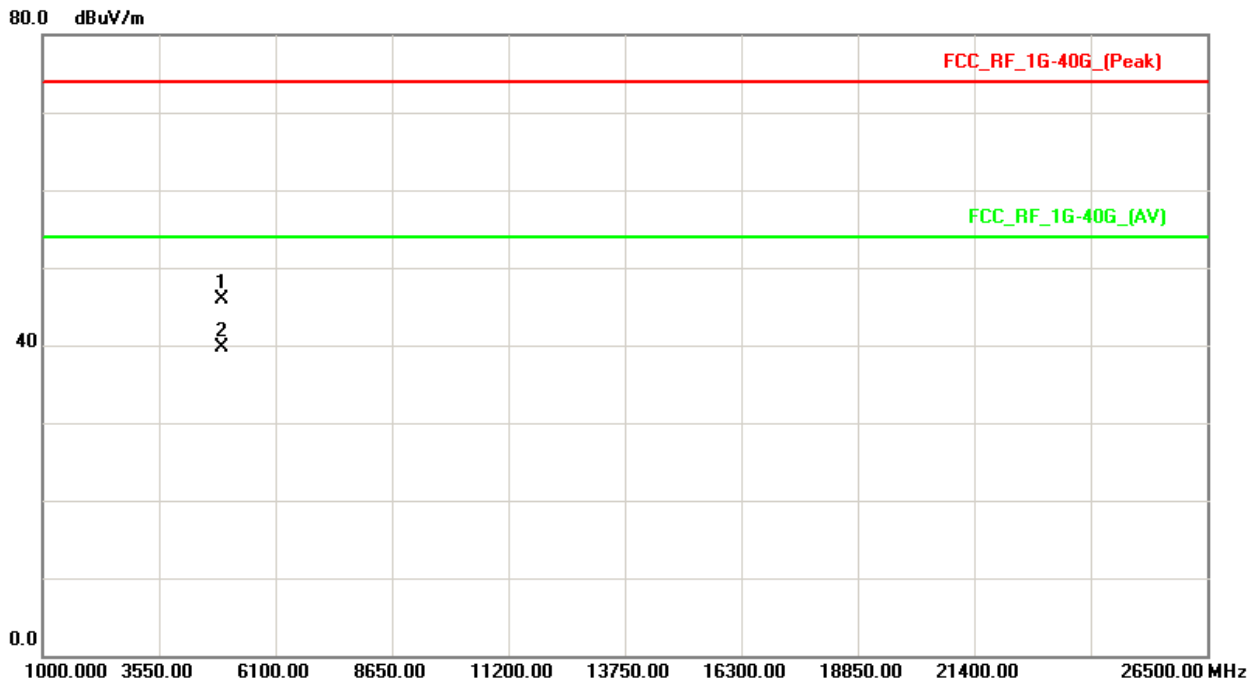
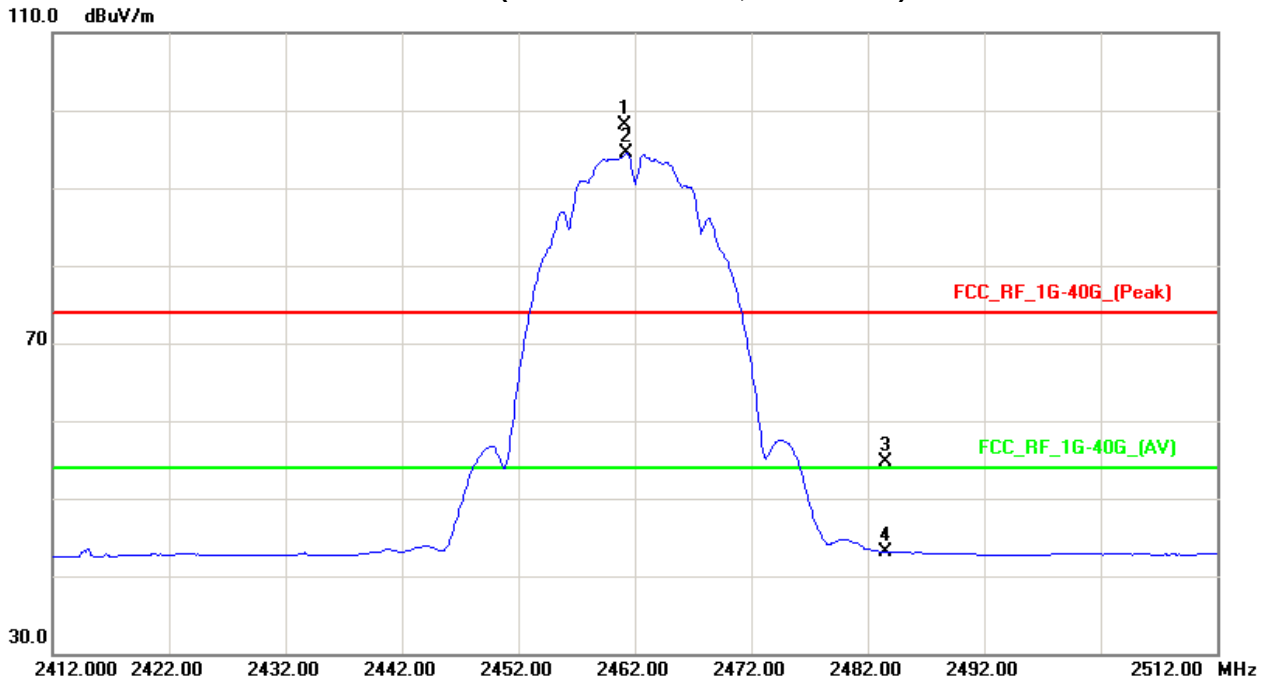



EUT :	150Mbps Wireless-N USB Adapter	Model Name :	WF-2103
Temperature :	25 °C	Relative Humidity :	51 %
Pressure :	1010 hPa	Test Voltage :	AC 120V/60Hz
Test Mode :	TX G MODE 2412MHz		

Freq. (MHz)	Ant.Pol. H/V	Reading		Ant./CF CF(dB)	Act.		Limit		Note
		Peak (dBuV)	AV (dBuV)		Peak (dBuV/m)	AV (dBuV/m)	Peak (dBuV/m)	AV (dBuV/m)	
2390.00	V	22.37	11.29	31.54	53.91	42.83	74.00	54.00	X/E
2408.90	V	66.90	57.95	1.57	98.47	89.52			X/F
4824.16	V	43.62	36.56	6.00	49.62	42.56	74.00	54.00	X/H

Remark :

- (1) All readings are Peak unless otherwise stated QP in column of 『Note』 . Peak denotes that the Peak reading compliance with the QP Limits and then QP Mode measurement didn't perform ◦
- (2) Measuring frequency range from 30MHz to 1000MHz or the 10th harmonic of highest fundamental frequency ◦ "F" denotes fundamental frequency; "H" denotes spurious frequency. "E" denotes band edge frequency. (This judgment method includes the Band Edge Requirement.)
- (3) Radiated emissions measured in frequency range above 1000MHz were made with an instrument using Peak detector mode and AV detector mode of the emission ◦
- (4) Data of measurement within this frequency range shown " * " in the table above means the reading of emissions are attenuated more than 20dB below the permissible limits or the field strength is too small to be measured.
- (5) A preamp and high pass filter were used for this test in order to provide sufficient measurement sensitivity.
- (6) EUT Orthogonal Axis :
"X" - denotes Laid on Table ; "Y" - denotes Vertical Stand ; "Z" - denotes Side Stand
- (7) During the measurements above 1 GHz it is taken care of that the EUT is always within the 3 dB cone of radiation BW of the used antenna



TX CH01 (Above 1000 MHz, Vertical)

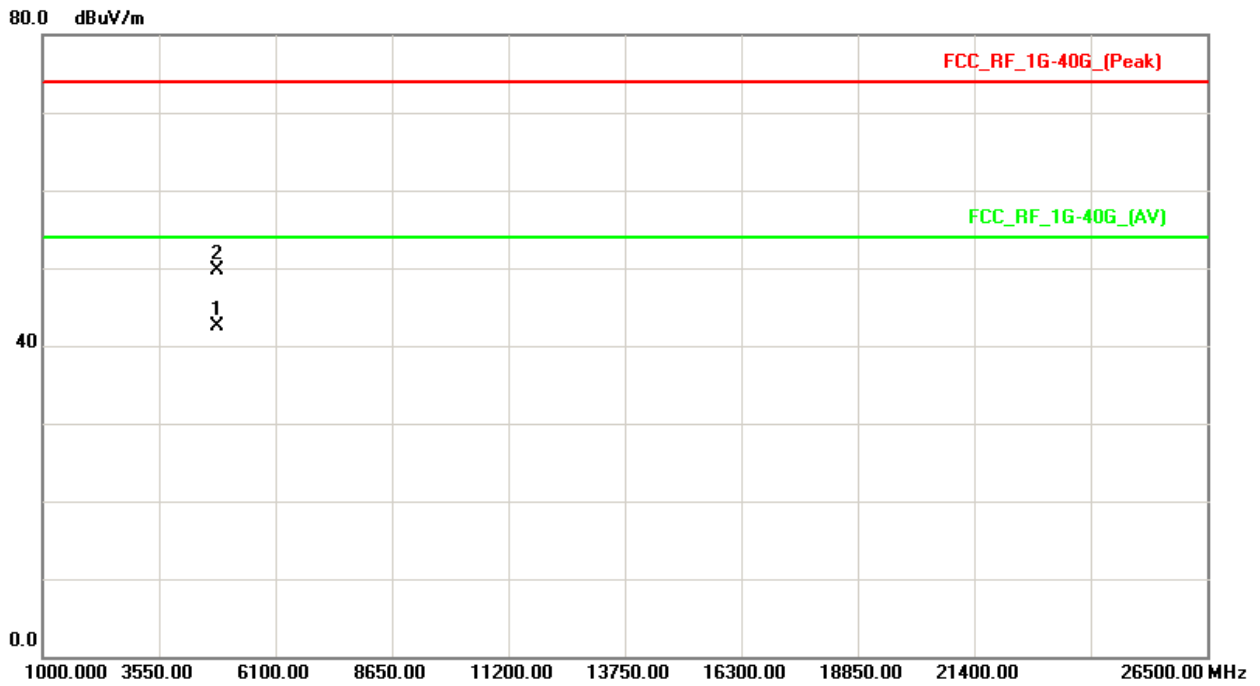
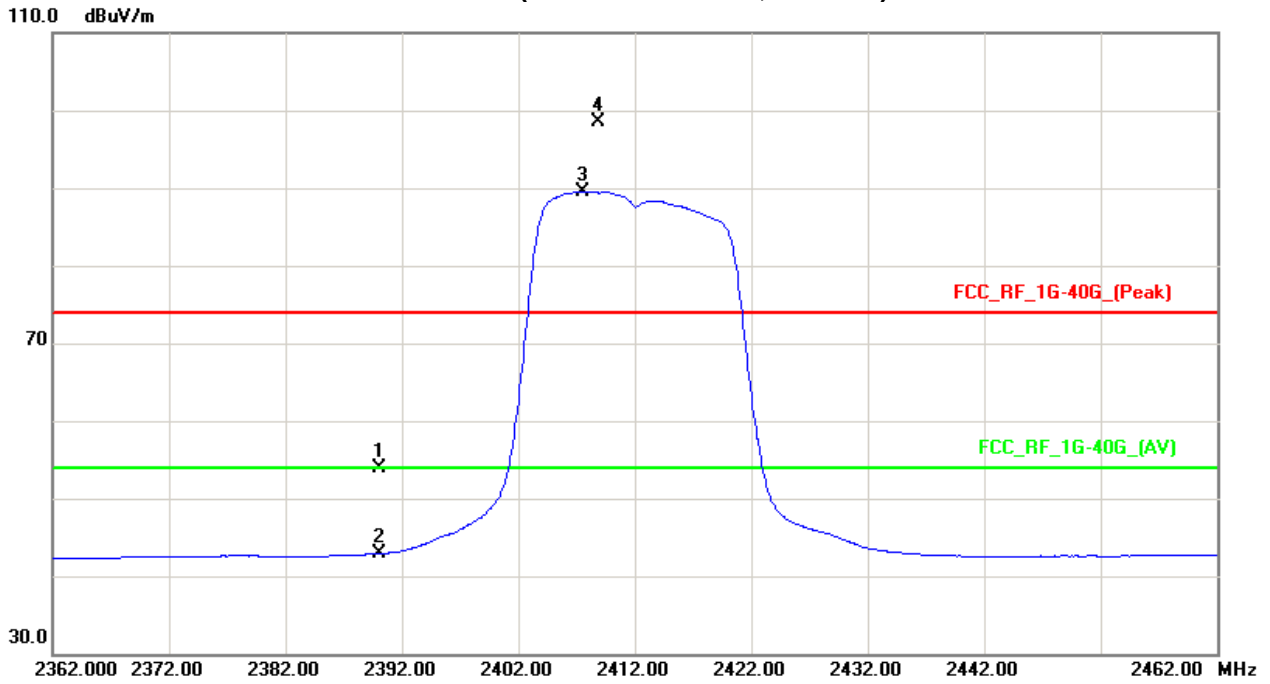



EUT :	150Mbps Wireless-N USB Adapter	Model Name :	WF-2103
Temperature :	25 °C	Relative Humidity :	51 %
Pressure :	1010 hPa	Test Voltage :	AC 120V/60Hz
Test Mode :	TX G MODE 2412MHz		

Freq. (MHz)	Ant.Pol. H/V	Reading		Ant./CF CF(dB)	Act.		Limit		Note
		Peak (dBuV)	AV (dBuV)		Peak (dBuV/m)	AV (dBuV/m)	Peak (dBuV/m)	AV (dBuV/m)	
2390.00	H	22.15	11.60	31.54	53.69	43.14	74.00	54.00	X/E
2409.70	H	68.71	59.94	31.57	100.28	91.51			X/F
4824.18	H	38.23	32.02	6.00	44.23	38.02	74.00	54.00	X/H

Remark :

- (1) All readings are Peak unless otherwise stated QP in column of 『Note』 . Peak denotes that the Peak reading compliance with the QP Limits and then QP Mode measurement didn't perform ◦
- (2) Measuring frequency range from 30MHz to 1000MHz or the 10th harmonic of highest fundamental frequency ◦ "F" denotes fundamental frequency; "H" denotes spurious frequency. "E" denotes band edge frequency. (This judgment method includes the Band Edge Requirement.)
- (3) Radiated emissions measured in frequency range above 1000MHz were made with an instrument using Peak detector mode and AV detector mode of the emission ◦
- (4) Data of measurement within this frequency range shown " * " in the table above means the reading of emissions are attenuated more than 20dB below the permissible limits or the field strength is too small to be measured.
- (5) A preamp and high pass filter were used for this test in order to provide sufficient measurement sensitivity.
- (6) EUT Orthogonal Axis :
"X" - denotes Laid on Table ; "Y" - denotes Vertical Stand ; "Z" - denotes Side Stand
- (7) During the measurements above 1 GHz it is taken care of that the EUT is always within the 3 dB cone of radiation BW of the used antenna



TX CH01 (Above 1000 MHz, Horizontal)

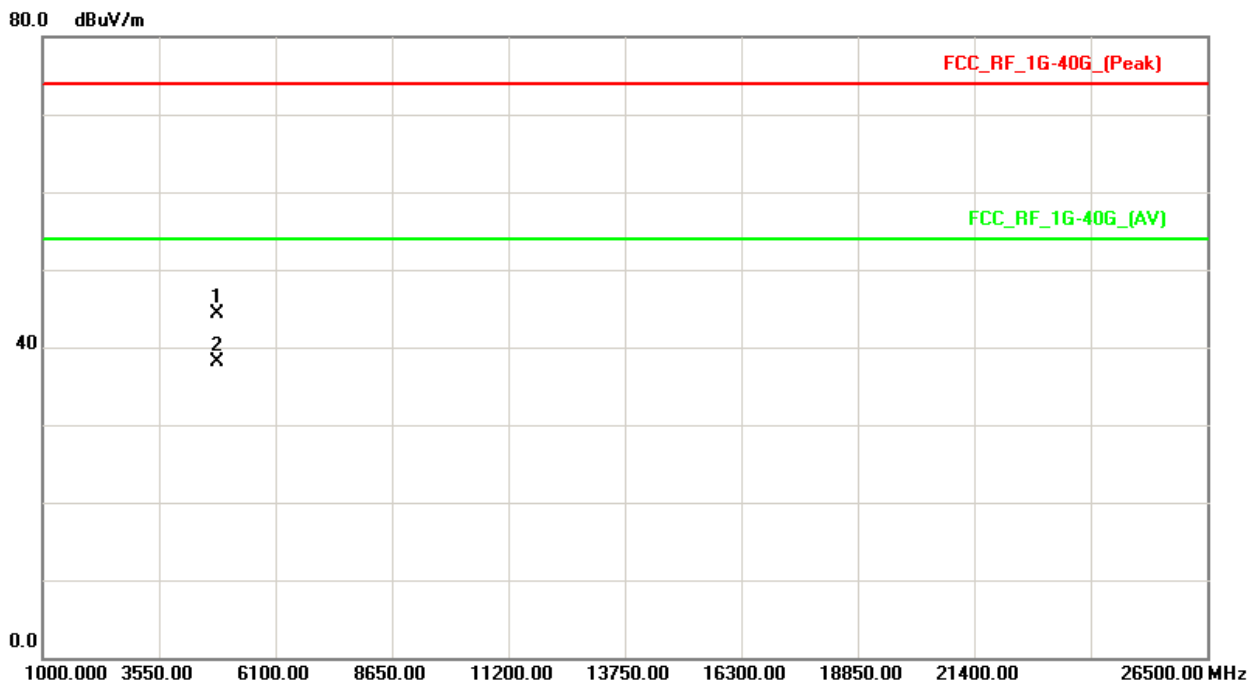
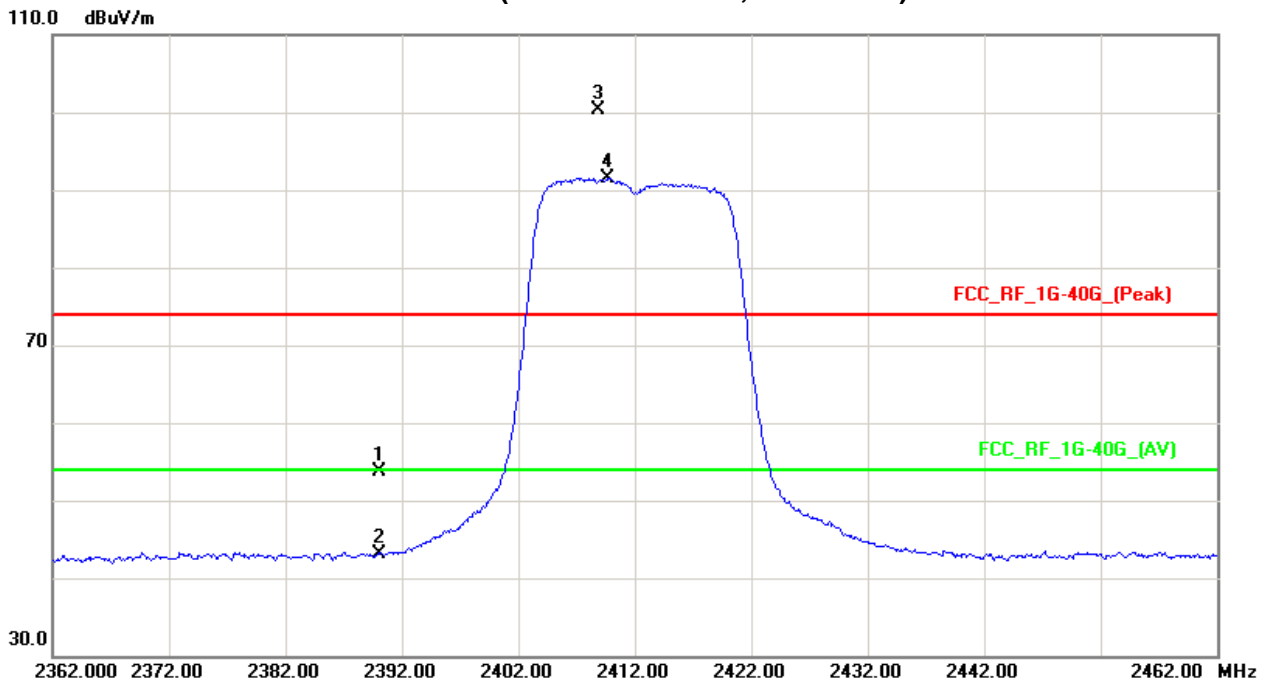



EUT :	150Mbps Wireless-N USB Adapter	Model Name :	WF-2103
Temperature :	25 °C	Relative Humidity :	51 %
Pressure :	1010 hPa	Test Voltage :	AC 120V/60Hz
Test Mode :	TX G MODE 2437MHz		

Freq. (MHz)	Ant.Pol. H/V	Reading		Ant./CF CF(dB)	Act.		Limit		Note
		Peak (dBuV)	AV (dBuV)		Peak (dBuV/m)	AV (dBuV/m)	Peak (dBuV/m)	AV (dBuV/m)	
2430.80	V	64.72	55.77	31.61	96.33	87.38			X/F
4874.15	V	40.56	33.11	6.15	46.71	39.26	74.00	54.00	X/H

Remark :

- (1) All readings are Peak unless otherwise stated QP in column of 『Note』 . Peak denotes that the Peak reading compliance with the QP Limits and then QP Mode measurement didn't perform ◦
- (2) Measuring frequency range from 30MHz to 1000MHz or the 10th harmonic of highest fundamental frequency ◦ "F" denotes fundamental frequency; "H" denotes spurious frequency. "E" denotes band edge frequency. (This judgment method includes the Band Edge Requirement.)
- (3) Radiated emissions measured in frequency range above 1000MHz were made with an instrument using Peak detector mode and AV detector mode of the emission ◦
- (4) Data of measurement within this frequency range shown " * " in the table above means the reading of emissions are attenuated more than 20dB below the permissible limits or the field strength is too small to be measured.
- (5) A preamp and high pass filter were used for this test in order to provide sufficient measurement sensitivity.
- (6) EUT Orthogonal Axis :
"X" - denotes Laid on Table ; "Y" - denotes Vertical Stand ; "Z" - denotes Side Stand
- (7) During the measurements above 1 GHz it is taken care of that the EUT is always within the 3 dB cone of radiation BW of the used antenna



TX CH06 (Above 1000 MHz, Vertical)

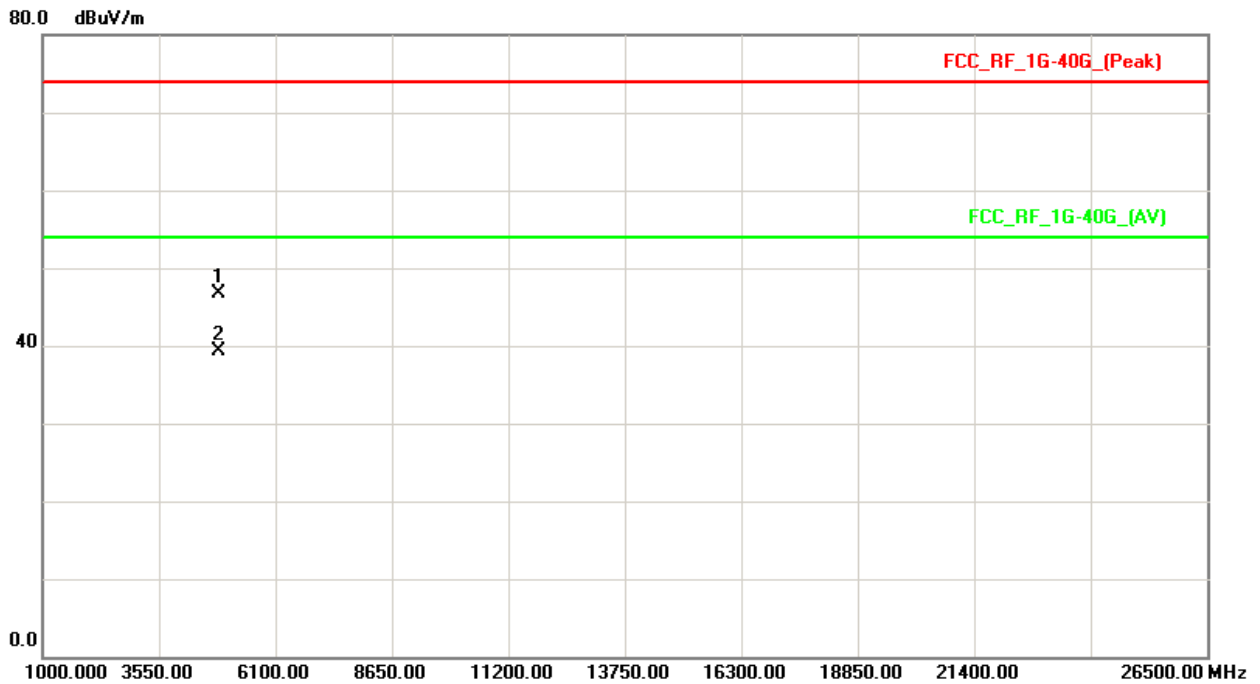
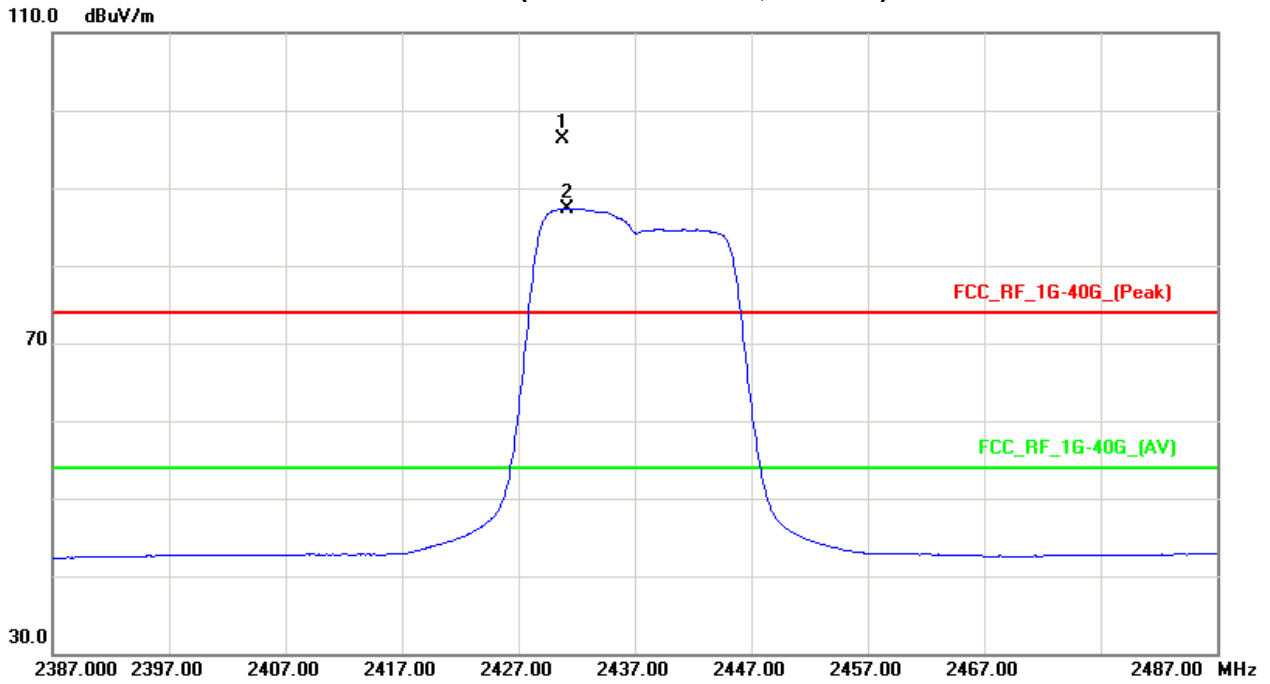



EUT :	150Mbps Wireless-N USB Adapter	Model Name :	WF-2103
Temperature :	25 °C	Relative Humidity :	51 %
Pressure :	1010 hPa	Test Voltage :	AC 120V/60Hz
Test Mode :	TX G MODE 2437MHz		

Freq.	Ant.Pol.	Reading		Ant./CF	Act.		Limit		Note
		Peak	AV		Peak	AV	Peak	AV	
(MHz)	H/V	(dBuV)	(dBuV)	CF(dB)	(dBuV/m)	(dBuV/m)	(dBuV/m)	(dBuV/m)	
2434.50	H	68.16	59.29	31.61	99.77	90.90			X/F
4874.05	H	39.87	34.04	6.15	46.02	40.19	74.00	54.00	X/H

Remark :

- (1) All readings are Peak unless otherwise stated QP in column of 『Note』 . Peak denotes that the Peak reading compliance with the QP Limits and then QP Mode measurement didn't perform ◦
- (2) Measuring frequency range from 30MHz to 1000MHz or the 10th harmonic of highest fundamental frequency ◦ "F" denotes fundamental frequency; "H" denotes spurious frequency. "E" denotes band edge frequency. (This judgment method includes the Band Edge Requirement.)
- (3) Radiated emissions measured in frequency range above 1000MHz were made with an instrument using Peak detector mode and AV detector mode of the emission ◦
- (4) Data of measurement within this frequency range shown " * " in the table above means the reading of emissions are attenuated more than 20dB below the permissible limits or the field strength is too small to be measured.
- (5) A preamp and high pass filter were used for this test in order to provide sufficient measurement sensitivity.
- (6) EUT Orthogonal Axis :
"X" - denotes Laid on Table ; "Y" - denotes Vertical Stand ; "Z" - denotes Side Stand
- (7) During the measurements above 1 GHz it is taken care of that the EUT is always within the 3 dB cone of radiation BW of the used antenna



TX CH06 (Above 1000 MHz, Horizontal)

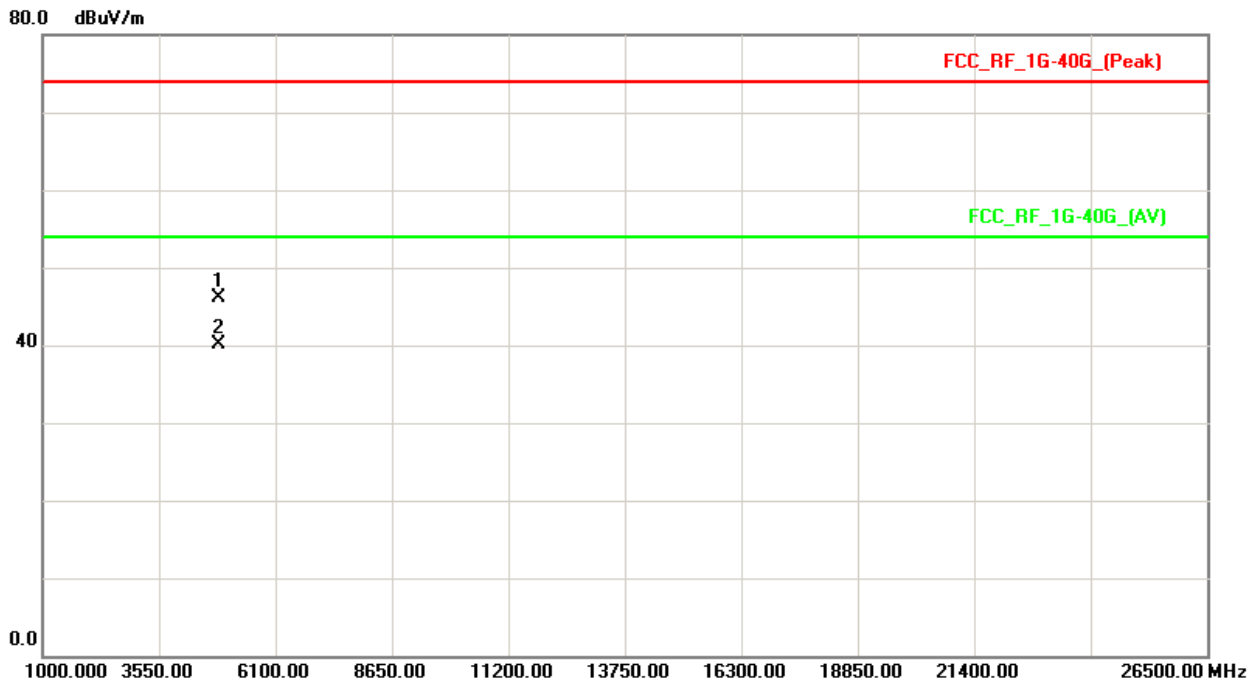
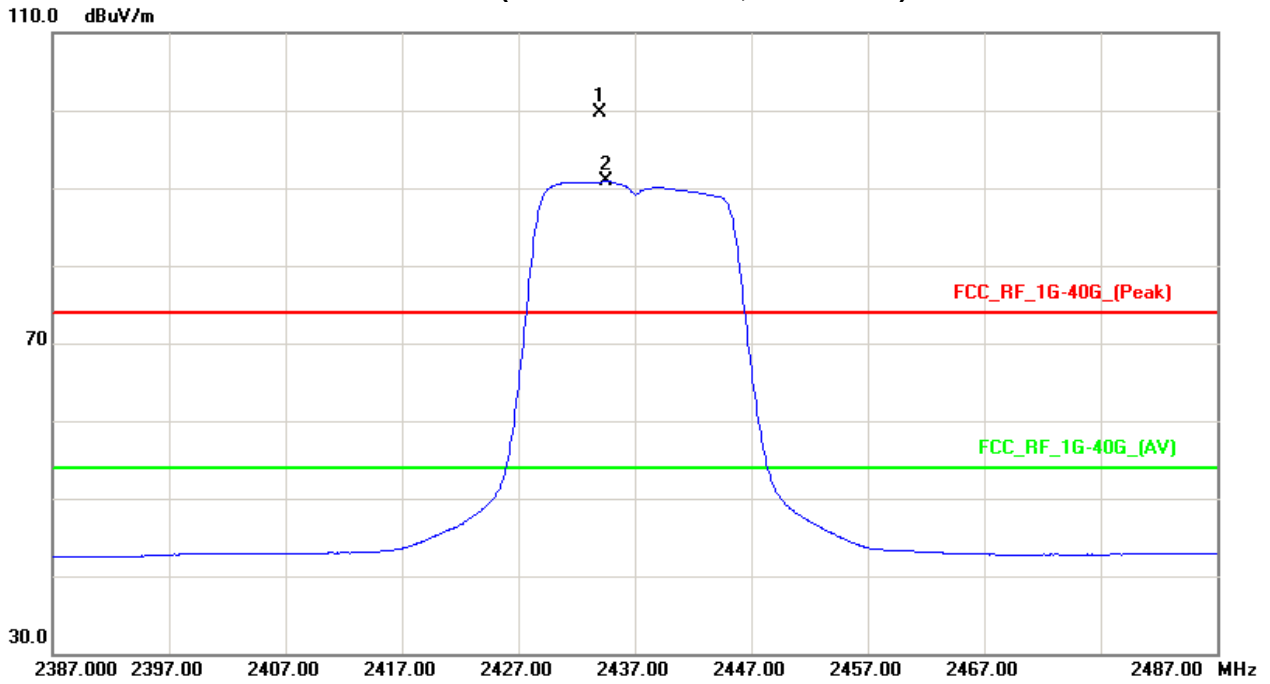



EUT :	150Mbps Wireless-N USB Adapter	Model Name :	WF-2103
Temperature :	25 °C	Relative Humidity :	51 %
Pressure :	1010 hPa	Test Voltage :	AC 120V/60Hz
Test Mode :	TX G MODE 2462MHz		

Freq.	Ant.Pol.	Reading		Ant./CF	Act.		Limit		Note
		Peak	AV		Peak	AV	Peak	AV	
(MHz)	H/V	(dBuV)	(dBuV)	CF(dB)	(dBuV/m)	(dBuV/m)	(dBuV/m)	(dBuV/m)	
2465.20	V	63.06	54.28	31.66	94.72	85.94			X/F
2483.50	V	22.53	11.38	31.70	54.23	43.08	74.00	54.00	X/E
4924.08	V	38.27	30.76	6.35	44.62	37.11	74.00	54.00	X/H

Remark :

- (1) All readings are Peak unless otherwise stated QP in column of 『Note』 . Peak denotes that the Peak reading compliance with the QP Limits and then QP Mode measurement didn't perform ◦
- (2) Measuring frequency range from 30MHz to 1000MHz or the 10th harmonic of highest fundamental frequency ◦ "F" denotes fundamental frequency; "H" denotes spurious frequency. "E" denotes band edge frequency. (This judgment method includes the Band Edge Requirement.)
- (3) Radiated emissions measured in frequency range above 1000MHz were made with an instrument using Peak detector mode and AV detector mode of the emission ◦
- (4) Data of measurement within this frequency range shown " * " in the table above means the reading of emissions are attenuated more than 20dB below the permissible limits or the field strength is too small to be measured.
- (5) A preamp and high pass filter were used for this test in order to provide sufficient measurement sensitivity.
- (6) EUT Orthogonal Axis :
 "X" - denotes Laid on Table ; "Y" - denotes Vertical Stand ; "Z" - denotes Side Stand
- (7) During the measurements above 1 GHz it is taken care of that the EUT is always within the 3 dB cone of radiation BW of the used antenna



TX CH11 (Above 1000 MHz, Vertical)

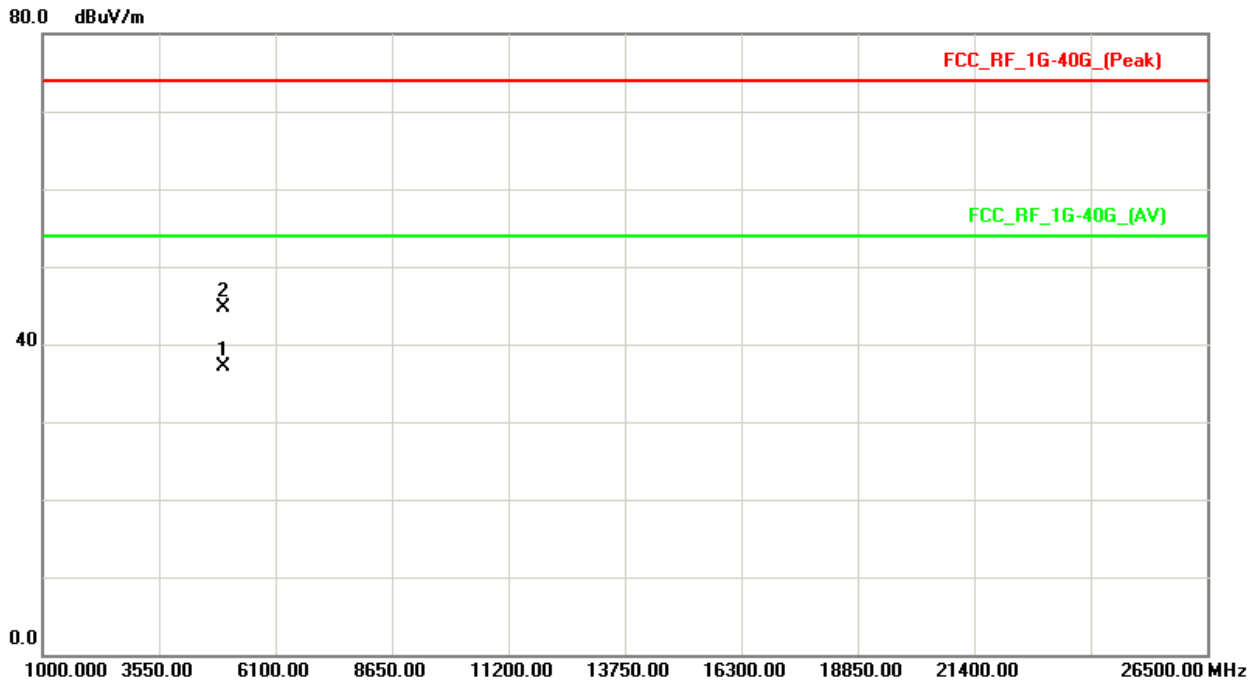
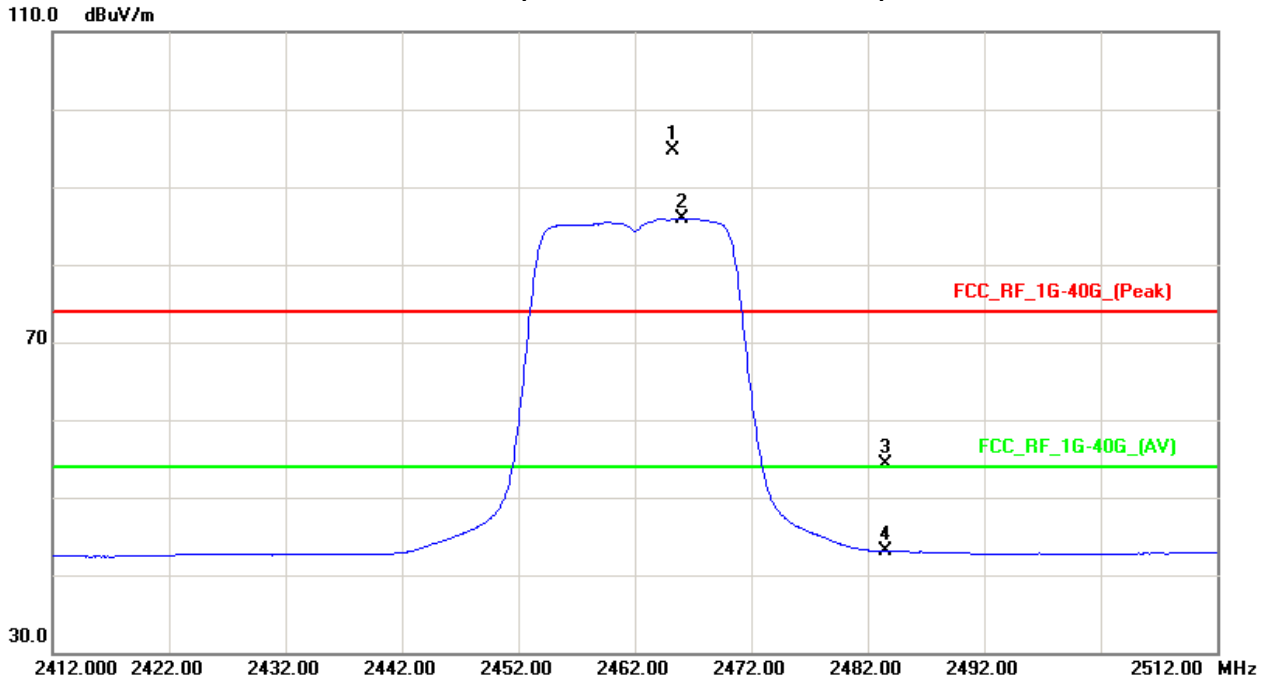



EUT :	150Mbps Wireless-N USB Adapter	Model Name :	WF-2103
Temperature :	25 °C	Relative Humidity :	51 %
Pressure :	1010 hPa	Test Voltage :	AC 120V/60Hz
Test Mode :	TX G MODE 2462MHz		

Freq.	Ant.Pol.	Reading		Ant./CF	Act.		Limit		Note
		Peak	AV		Peak	AV	Peak	AV	
(MHz)	H/V	(dBuV)	(dBuV)	CF(dB)	(dBuV/m)	(dBuV/m)	(dBuV/m)	(dBuV/m)	
2455.40	H	67.04	58.29	31.65	98.69	89.94			X/F
2483.50	H	23.52	11.44	31.70	55.22	43.14	74.00	54.00	X/E
4923.98	H	36.84	30.71	6.30	43.14	37.01	74.00	54.00	X/H

Remark :

- (1) All readings are Peak unless otherwise stated QP in column of 『Note』 . Peak denotes that the Peak reading compliance with the QP Limits and then QP Mode measurement didn't perform ◦
- (2) Measuring frequency range from 30MHz to 1000MHz or the 10th harmonic of highest fundamental frequency ◦ "F" denotes fundamental frequency; "H" denotes spurious frequency. "E" denotes band edge frequency. (This judgment method includes the Band Edge Requirement.)
- (3) Radiated emissions measured in frequency range above 1000MHz were made with an instrument using Peak detector mode and AV detector mode of the emission ◦
- (4) Data of measurement within this frequency range shown " * " in the table above means the reading of emissions are attenuated more than 20dB below the permissible limits or the field strength is too small to be measured.
- (5) A preamp and high pass filter were used for this test in order to provide sufficient measurement sensitivity.
- (6) EUT Orthogonal Axis :
 "X" - denotes Laid on Table ; "Y" - denotes Vertical Stand ; "Z" - denotes Side Stand
- (7) During the measurements above 1 GHz it is taken care of that the EUT is always within the 3 dB cone of radiation BW of the used antenna



TX CH11 (Above 1000 MHz, Horizontal)

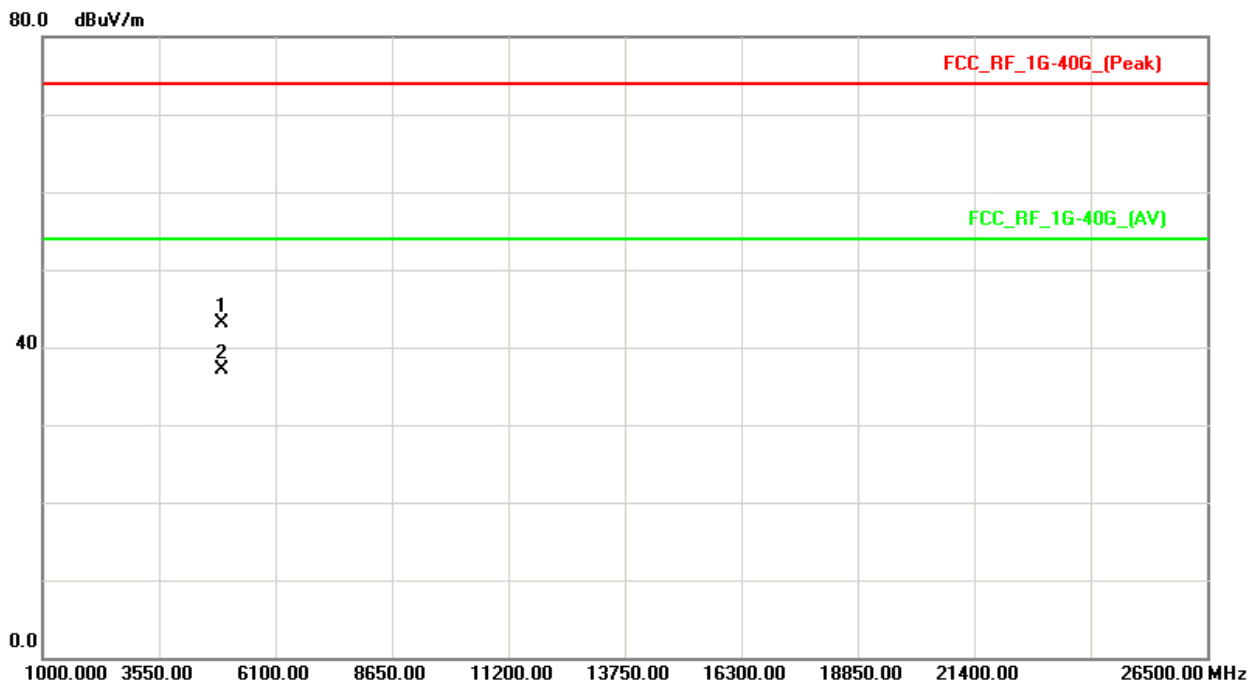
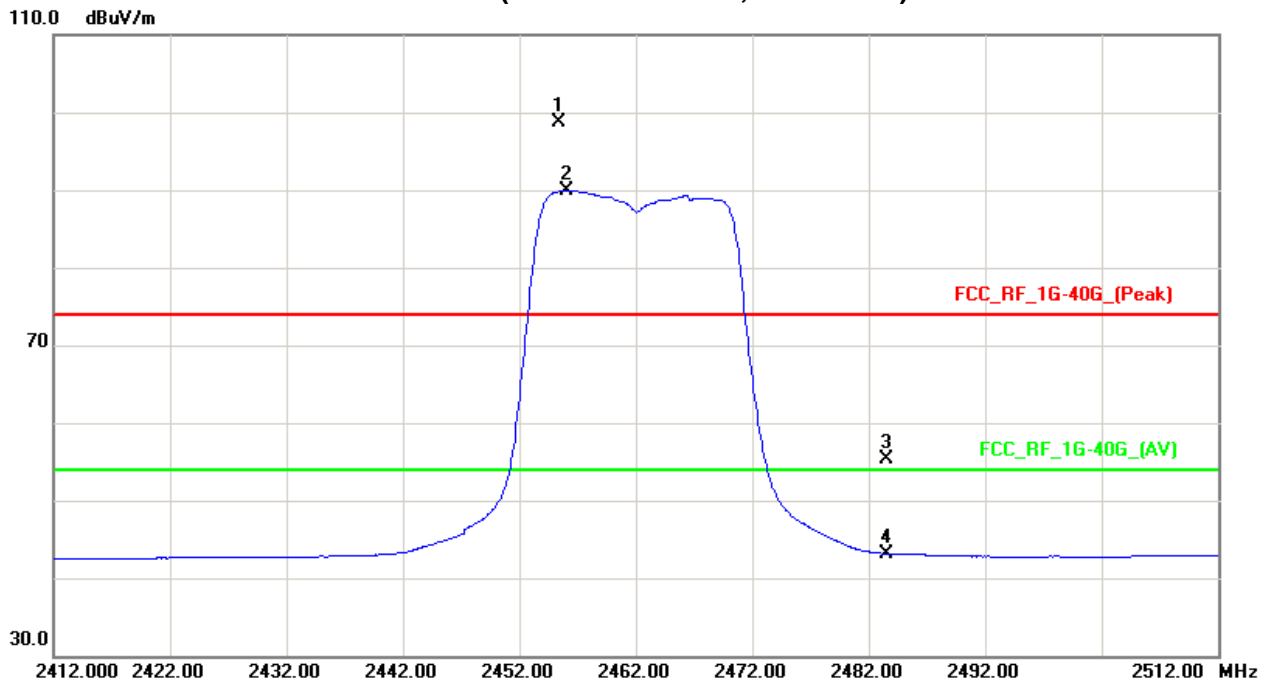



EUT :	150Mbps Wireless-N USB Adapter	Model Name :	WF-2103
Temperature :	25 °C	Relative Humidity :	51 %
Pressure :	1010 hPa	Test Voltage :	AC 120V/60Hz
Test Mode :	TX N-20M MODE 2412MHz		

Freq. (MHz)	Ant.Pol. H/V	Reading		Ant./CF CF(dB)	Act.		Limit		Note
		Peak (dBuV)	AV (dBuV)		Peak (dBuV/m)	AV (dBuV/m)	Peak (dBuV/m)	AV (dBuV/m)	
2390.00	V	21.02	11.74	31.54	52.56	43.28	74.00	54.00	X/E
2409.00	V	66.57	56.80	31.57	98.14	88.37			X/F
4824.21	V	42.32	35.50	6.00	48.32	41.50	74.00	54.00	X/H

Remark :

- (1) All readings are Peak unless otherwise stated QP in column of 『Note』 . Peak denotes that the Peak reading compliance with the QP Limits and then QP Mode measurement didn't perform ◦
- (2) Measuring frequency range from 30MHz to 1000MHz or the 10th harmonic of highest fundamental frequency ◦ "F" denotes fundamental frequency; "H" denotes spurious frequency. "E" denotes band edge frequency. (This judgment method includes the Band Edge Requirement.)
- (3) Radiated emissions measured in frequency range above 1000MHz were made with an instrument using Peak detector mode and AV detector mode of the emission ◦
- (4) Data of measurement within this frequency range shown " * " in the table above means the reading of emissions are attenuated more than 20dB below the permissible limits or the field strength is too small to be measured.
- (5) A preamp and high pass filter were used for this test in order to provide sufficient measurement sensitivity.
- (6) EUT Orthogonal Axis :
"X" - denotes Laid on Table ; "Y" - denotes Vertical Stand ; "Z" - denotes Side Stand
- (7) During the measurements above 1 GHz it is taken care of that the EUT is always within the 3 dB cone of radiation BW of the used antenna



TX CH01 (Above 1000 MHz, Vertical)

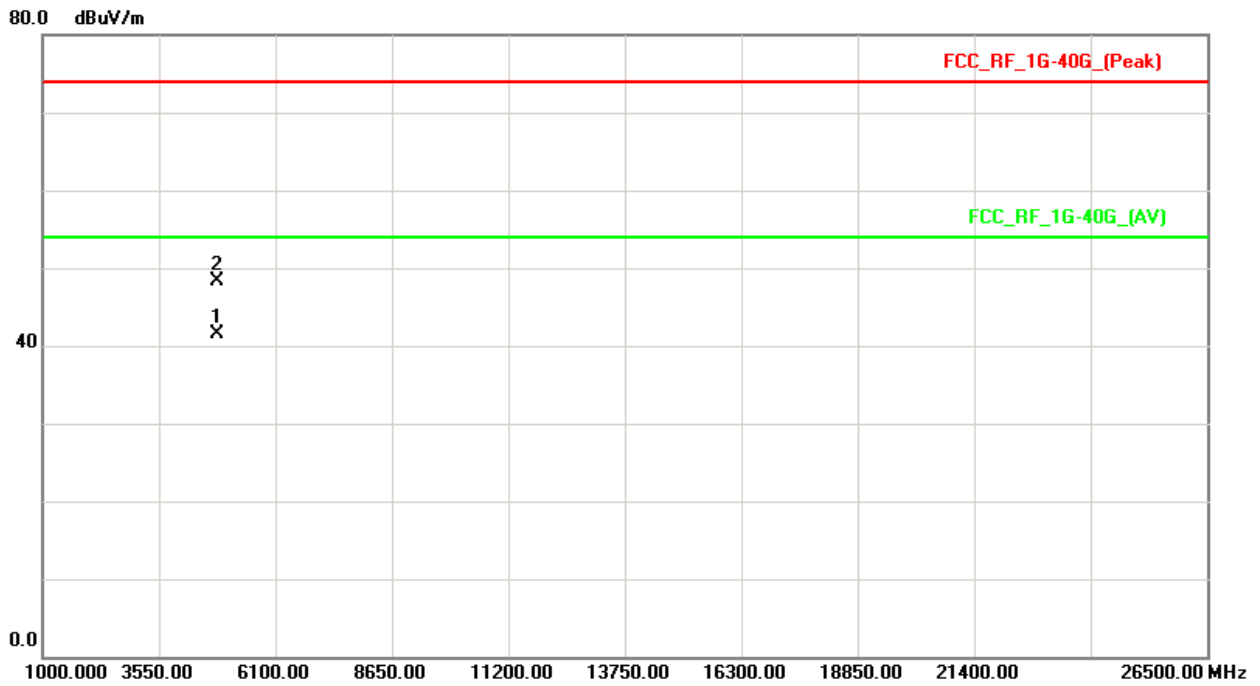
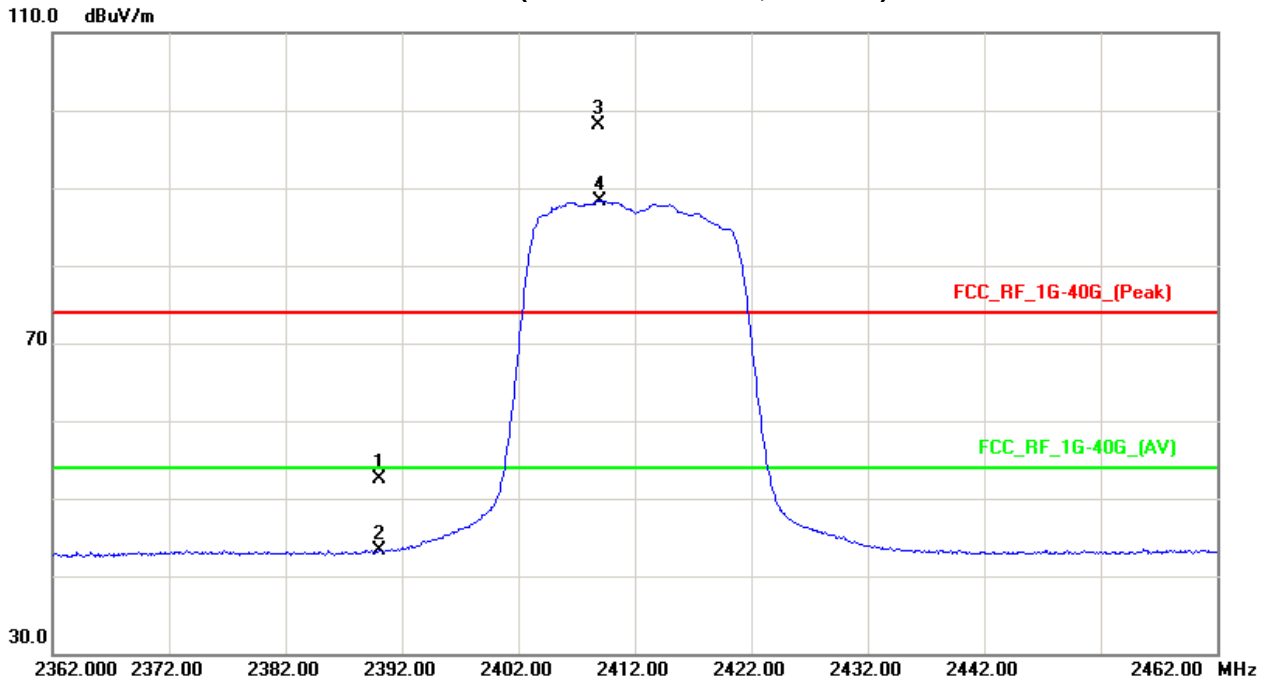



EUT :	150Mbps Wireless-N USB Adapter	Model Name :	WF-2103
Temperature :	25 °C	Relative Humidity :	51 %
Pressure :	1010 hPa	Test Voltage :	AC 120V/60Hz
Test Mode :	TX N-20M MODE 2412MHz		

Freq.	Ant.Pol.	Reading		Ant./CF	Act.		Limit		Note
		Peak	AV		Peak	AV	Peak	AV	
(MHz)	H/V	(dBuV)	(dBuV)	CF(dB)	(dBuV/m)	(dBuV/m)	(dBuV/m)	(dBuV/m)	
2390.00	H	22.05	10.91	31.54	53.59	42.45	74.00	54.00	X/E
2408.90	H	66.78	56.57	31.57	98.35	88.14			X/F
4824.09	H	38.14	31.86	6.00	44.14	37.86	74.00	54.00	X/H

Remark :

- (1) All readings are Peak unless otherwise stated QP in column of 『Note』 . Peak denotes that the Peak reading compliance with the QP Limits and then QP Mode measurement didn't perform ◦
- (2) Measuring frequency range from 30MHz to 1000MHz or the 10th harmonic of highest fundamental frequency ◦ "F" denotes fundamental frequency; "H" denotes spurious frequency. "E" denotes band edge frequency. (This judgment method includes the Band Edge Requirement.)
- (3) Radiated emissions measured in frequency range above 1000MHz were made with an instrument using Peak detector mode and AV detector mode of the emission ◦
- (4) Data of measurement within this frequency range shown " * " in the table above means the reading of emissions are attenuated more than 20dB below the permissible limits or the field strength is too small to be measured.
- (5) A preamp and high pass filter were used for this test in order to provide sufficient measurement sensitivity.
- (6) EUT Orthogonal Axis :
"X" - denotes Laid on Table ; "Y" - denotes Vertical Stand ; "Z" - denotes Side Stand
- (7) During the measurements above 1 GHz it is taken care of that the EUT is always within the 3 dB cone of radiation BW of the used antenna



TX CH01 (Above 1000 MHz, Horizontal)

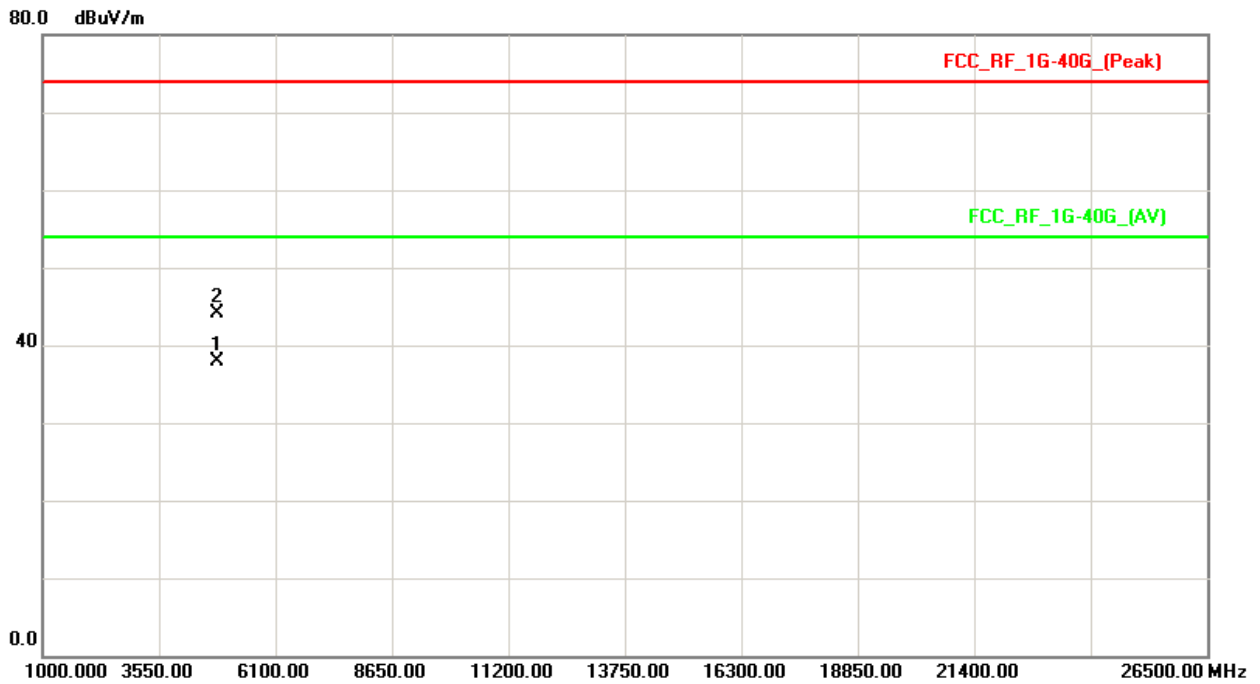
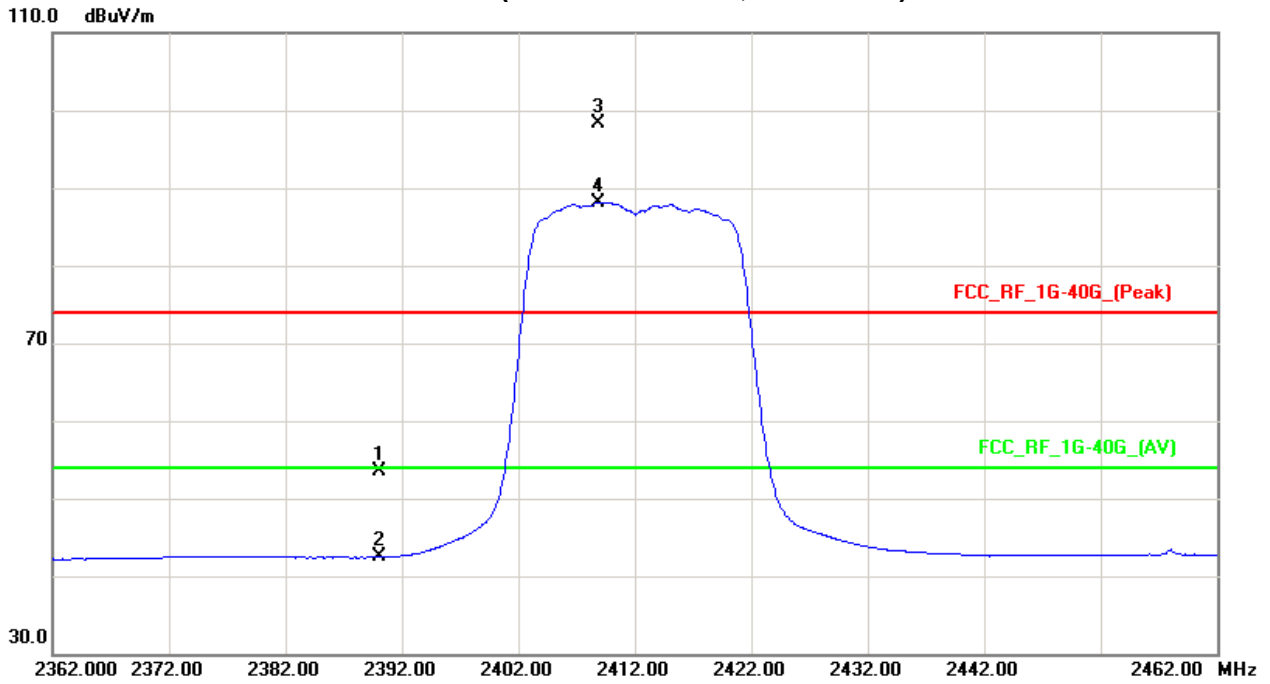



EUT :	150Mbps Wireless-N USB Adapter	Model Name :	WF-2103
Temperature :	25 °C	Relative Humidity :	51 %
Pressure :	1010 hPa	Test Voltage :	AC 120V/60Hz
Test Mode :	TX N-20M MODE 2437MHz		

Freq. (MHz)	Ant.Pol. H/V	Reading		Ant./CF CF(dB)	Act.		Limit		Note
		Peak (dBuV)	AV (dBuV)		Peak (dBuV/m)	AV (dBuV/m)	Peak (dBuV/m)	AV (dBuV/m)	
2434.00	V	63.48	54.23	31.61	95.09	85.84			X/F
4874.13	V	41.06	33.93	6.15	47.21	40.08	74.00	54.00	X/H

Remark :

- (1) All readings are Peak unless otherwise stated QP in column of 『Note』 . Peak denotes that the Peak reading compliance with the QP Limits and then QP Mode measurement didn't perform ◦
- (2) Measuring frequency range from 30MHz to 1000MHz or the 10th harmonic of highest fundamental frequency ◦ "F" denotes fundamental frequency; "H" denotes spurious frequency. "E" denotes band edge frequency. (This judgment method includes the Band Edge Requirement.)
- (3) Radiated emissions measured in frequency range above 1000MHz were made with an instrument using Peak detector mode and AV detector mode of the emission ◦
- (4) Data of measurement within this frequency range shown " * " in the table above means the reading of emissions are attenuated more than 20dB below the permissible limits or the field strength is too small to be measured.
- (5) A preamp and high pass filter were used for this test in order to provide sufficient measurement sensitivity.
- (6) EUT Orthogonal Axis :
"X" - denotes Laid on Table ; "Y" - denotes Vertical Stand ; "Z" - denotes Side Stand
- (7) During the measurements above 1 GHz it is taken care of that the EUT is always within the 3 dB cone of radiation BW of the used antenna



TX CH06 (Above 1000 MHz, Vertical)

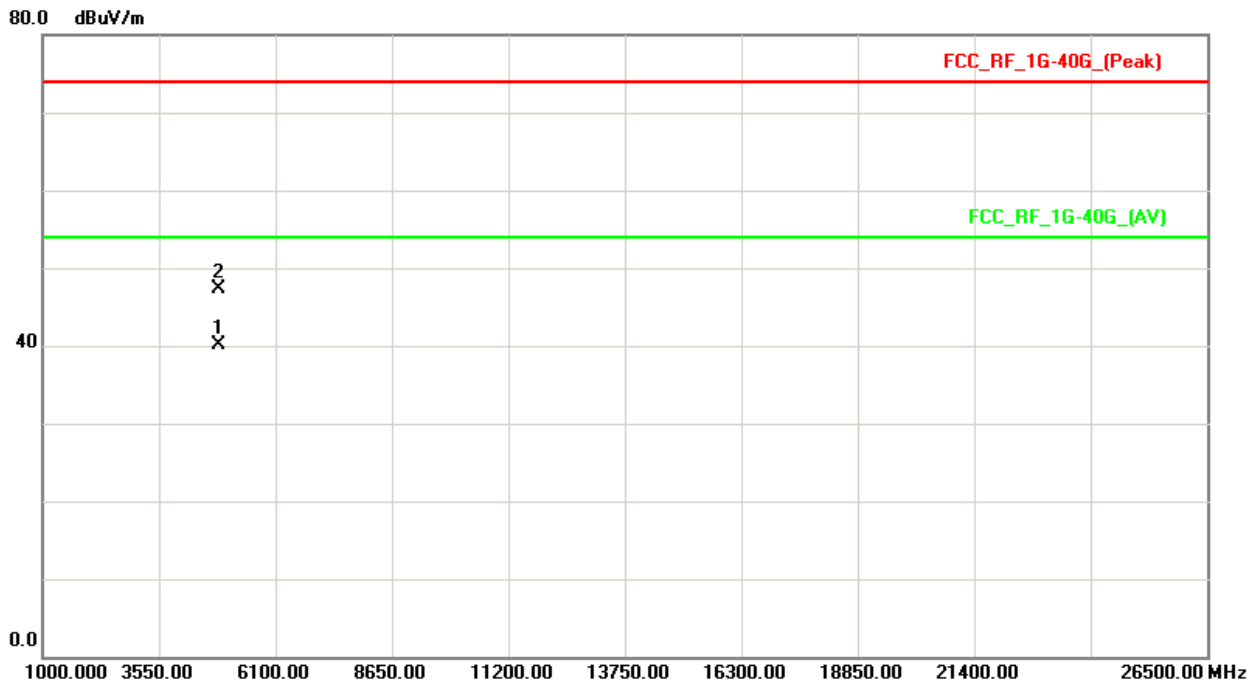
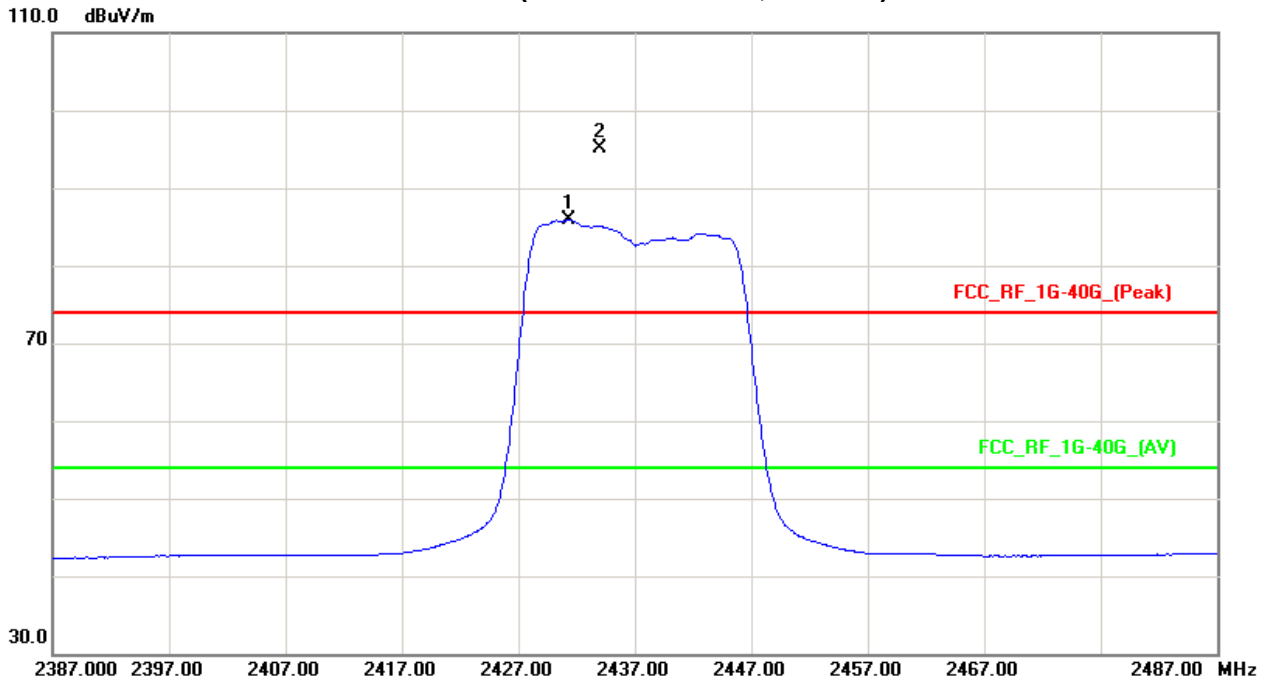



EUT :	150Mbps Wireless-N USB Adapter	Model Name :	WF-2103
Temperature :	25 °C	Relative Humidity :	51 %
Pressure :	1010 hPa	Test Voltage :	AC 120V/60Hz
Test Mode :	TX N-20M MODE 2437MHz		

Freq.	Ant.Pol.	Reading		Ant./CF	Act.		Limit		Note
		Peak	AV		Peak	AV	Peak	AV	
(MHz)	H/V	(dBuV)	(dBuV)	CF(dB)	(dBuV/m)	(dBuV/m)	(dBuV/m)	(dBuV/m)	
2440.00	H	68.56	58.66	31.61	100.17	90.27			X/F
4874.10	H	38.42	31.87	6.15	44.57	38.02	74.00	54.00	X/H

Remark :

- (1) All readings are Peak unless otherwise stated QP in column of 『Note』 . Peak denotes that the Peak reading compliance with the QP Limits and then QP Mode measurement didn't perform ◦
- (2) Measuring frequency range from 30MHz to 1000MHz or the 10th harmonic of highest fundamental frequency ◦ "F" denotes fundamental frequency; "H" denotes spurious frequency. "E" denotes band edge frequency. (This judgment method includes the Band Edge Requirement.)
- (3) Radiated emissions measured in frequency range above 1000MHz were made with an instrument using Peak detector mode and AV detector mode of the emission ◦
- (4) Data of measurement within this frequency range shown " * " in the table above means the reading of emissions are attenuated more than 20dB below the permissible limits or the field strength is too small to be measured.
- (5) A preamp and high pass filter were used for this test in order to provide sufficient measurement sensitivity.
- (6) EUT Orthogonal Axis :
"X" - denotes Laid on Table ; "Y" - denotes Vertical Stand ; "Z" - denotes Side Stand
- (7) During the measurements above 1 GHz it is taken care of that the EUT is always within the 3 dB cone of radiation BW of the used antenna



TX CH06 (Above 1000 MHz, Horizontal)

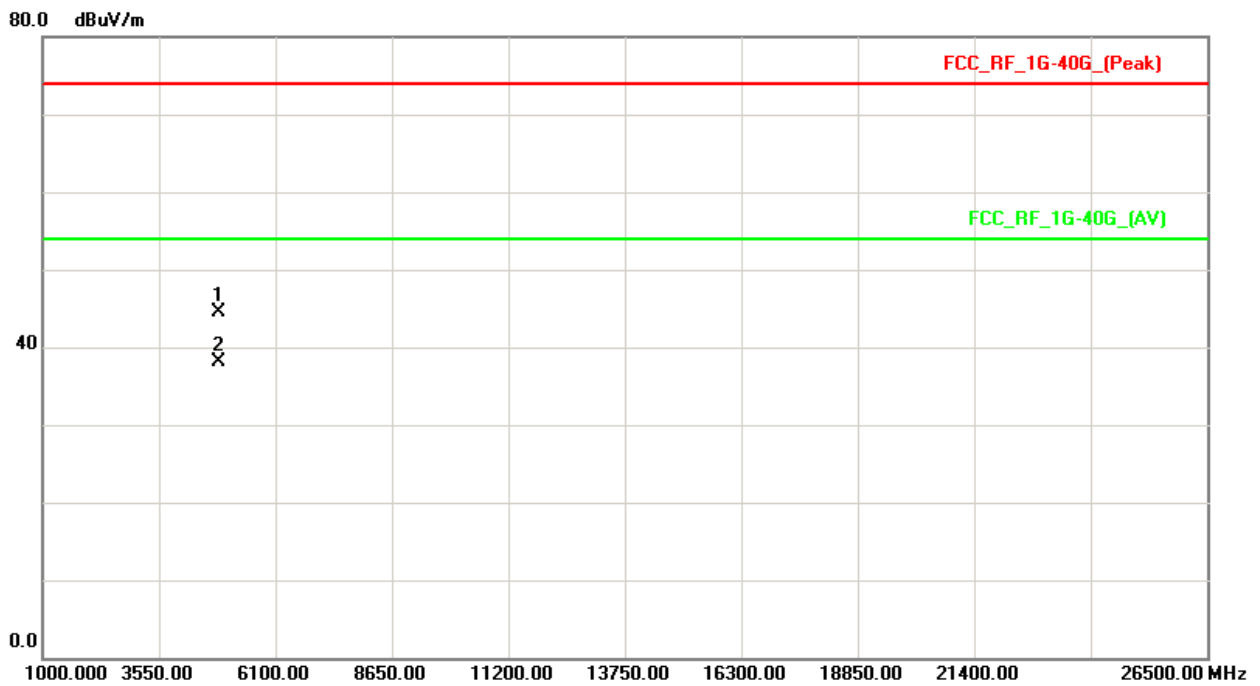
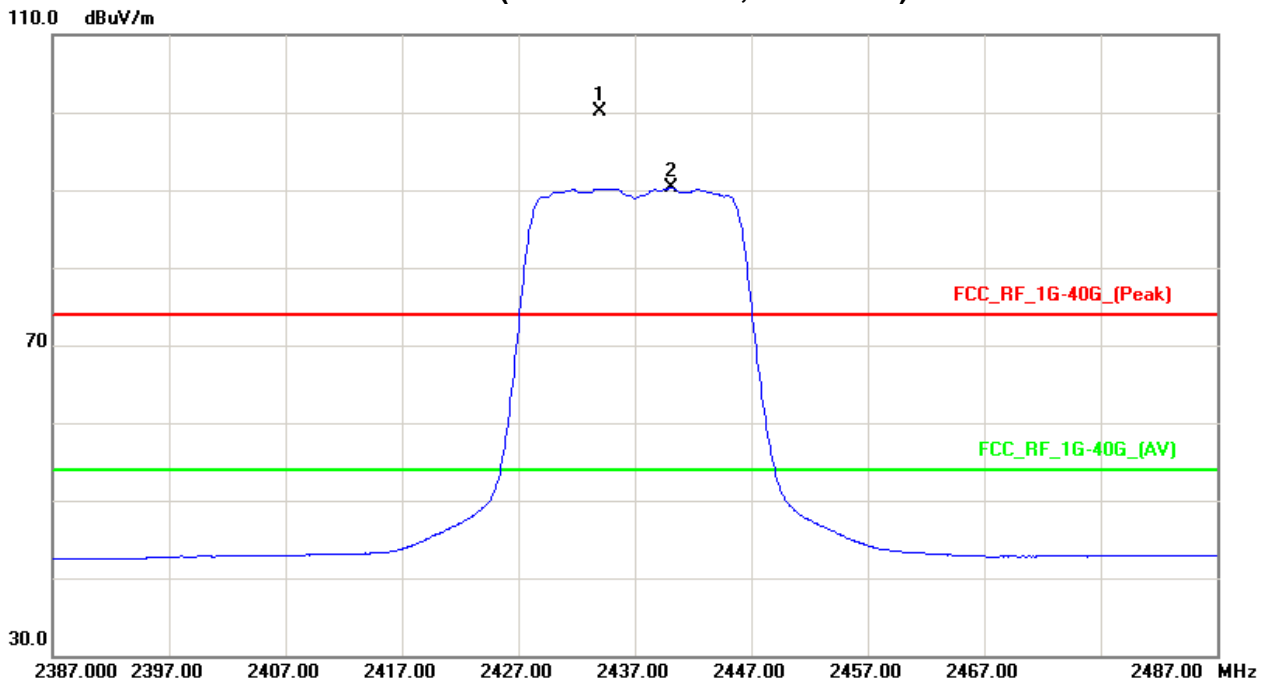



EUT :	150Mbps Wireless-N USB Adapter	Model Name :	WF-2103
Temperature :	25 °C	Relative Humidity :	51 %
Pressure :	1010 hPa	Test Voltage :	AC 120V/60Hz
Test Mode :	TX N-20M MODE 2462MHz		

Freq.	Ant.Pol.	Reading		Ant./CF	Act.		Limit		Note
		Peak	AV		Peak	AV	Peak	AV	
(MHz)	H/V	(dBuV)	(dBuV)	CF(dB)	(dBuV/m)	(dBuV/m)	(dBuV/m)	(dBuV/m)	
2465.10	V	62.40	52.94	31.65	94.05	84.59			X/F
2483.50	V	23.96	11.34	31.70	55.66	43.04	74.00	54.00	X/E
4924.11	V	41.27	32.91	6.35	47.62	39.26	74.00	54.00	X/H

Remark :

- (1) All readings are Peak unless otherwise stated QP in column of 『Note』 . Peak denotes that the Peak reading compliance with the QP Limits and then QP Mode measurement didn't perform ◦
- (2) Measuring frequency range from 30MHz to 1000MHz or the 10th harmonic of highest fundamental frequency ◦ "F" denotes fundamental frequency; "H" denotes spurious frequency. "E" denotes band edge frequency. (This judgment method includes the Band Edge Requirement.)
- (3) Radiated emissions measured in frequency range above 1000MHz were made with an instrument using Peak detector mode and AV detector mode of the emission ◦
- (4) Data of measurement within this frequency range shown " * " in the table above means the reading of emissions are attenuated more than 20dB below the permissible limits or the field strength is too small to be measured.
- (5) A preamp and high pass filter were used for this test in order to provide sufficient measurement sensitivity.
- (6) EUT Orthogonal Axis :
"X" - denotes Laid on Table ; "Y" - denotes Vertical Stand ; "Z" - denotes Side Stand
- (7) During the measurements above 1 GHz it is taken care of that the EUT is always within the 3 dB cone of radiation BW of the used antenna



TX CH11 (Above 1000 MHz, Vertical)

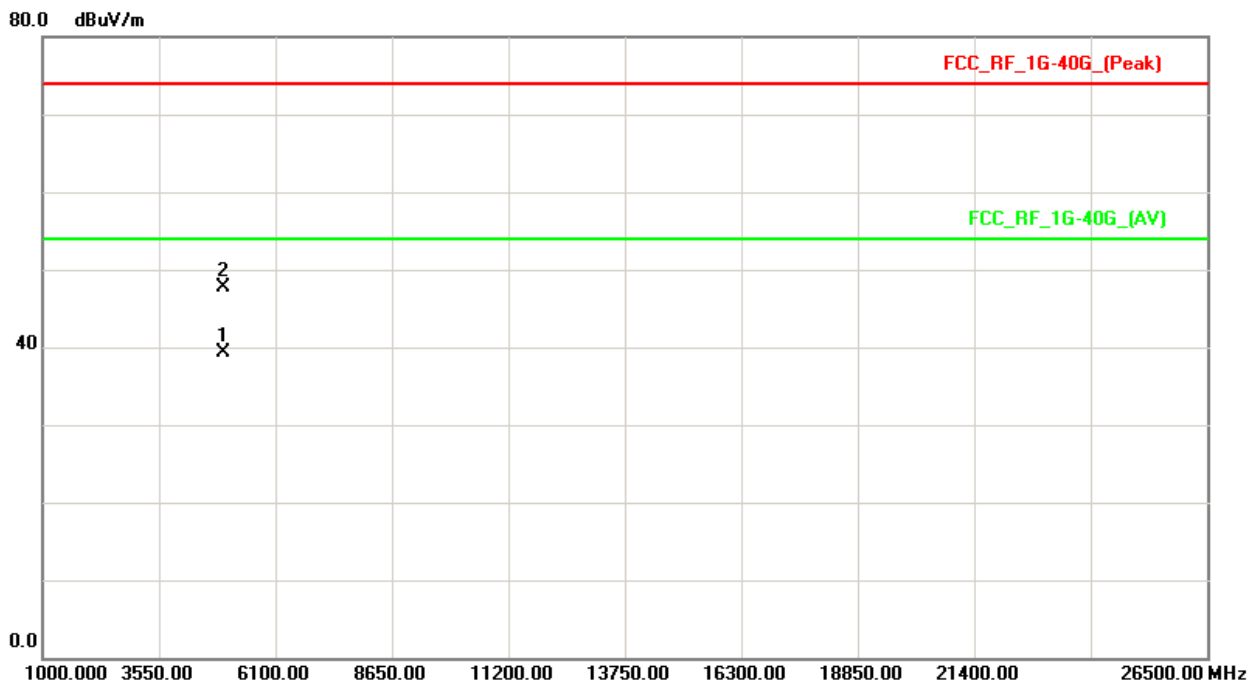
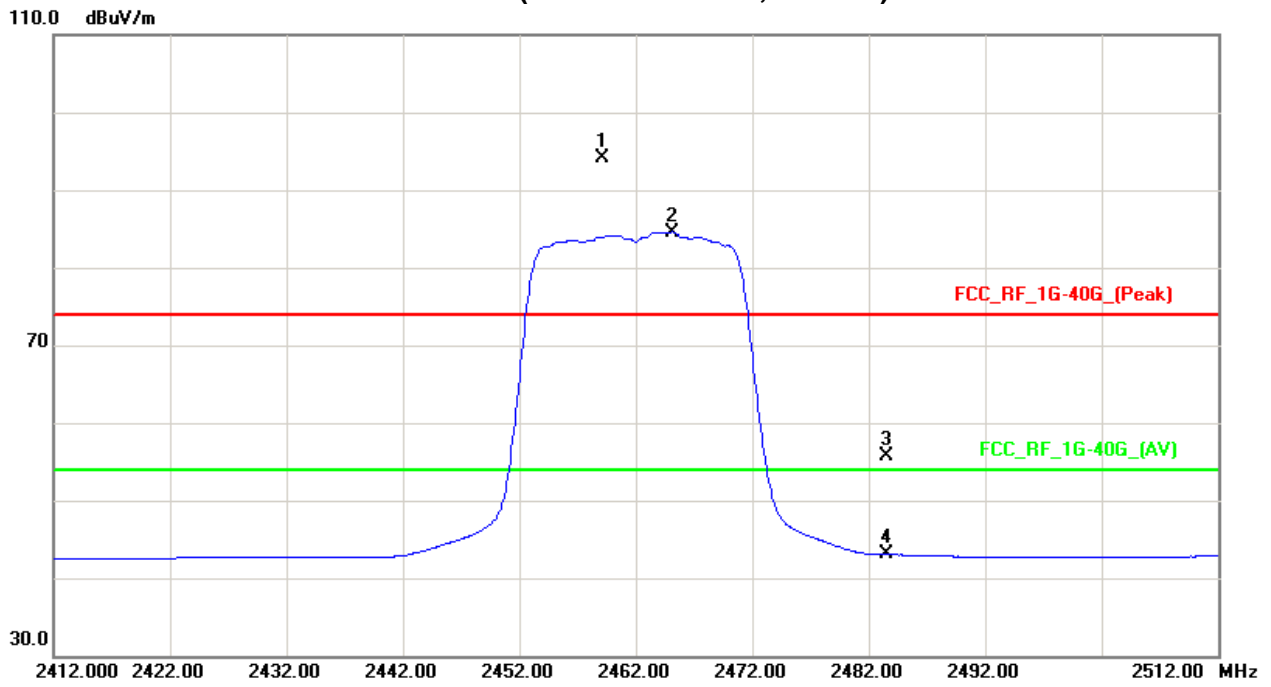



EUT :	150Mbps Wireless-N USB Adapter	Model Name :	WF-2103
Temperature :	25 °C	Relative Humidity :	51 %
Pressure :	1010 hPa	Test Voltage :	AC 120V/60Hz
Test Mode :	TX N-20M MODE 2462MHz		

Freq.	Ant.Pol.	Reading		Ant./CF	Act.		Limit		Note
		Peak	AV		Peak	AV	Peak	AV	
(MHz)	H/V	(dBuV)	(dBuV)	CF(dB)	(dBuV/m)	(dBuV/m)	(dBuV/m)	(dBuV/m)	
2456.60	H	68.09	59.41	31.65	99.74	91.06			X/F
2483.50	H	23.37	12.61	31.70	55.07	44.31	74.00	54.00	X/E
4823.98	H	38.04	31.31	6.30	44.34	37.61	74.00	54.00	X/H

Remark :

- (1) All readings are Peak unless otherwise stated QP in column of 『Note』 . Peak denotes that the Peak reading compliance with the QP Limits and then QP Mode measurement didn't perform ◦
- (2) Measuring frequency range from 30MHz to 1000MHz or the 10th harmonic of highest fundamental frequency ◦ "F" denotes fundamental frequency; "H" denotes spurious frequency. "E" denotes band edge frequency. (This judgment method includes the Band Edge Requirement.)
- (3) Radiated emissions measured in frequency range above 1000MHz were made with an instrument using Peak detector mode and AV detector mode of the emission ◦
- (4) Data of measurement within this frequency range shown " * " in the table above means the reading of emissions are attenuated more than 20dB below the permissible limits or the field strength is too small to be measured.
- (5) A preamp and high pass filter were used for this test in order to provide sufficient measurement sensitivity.
- (6) EUT Orthogonal Axis :
"X" - denotes Laid on Table ; "Y" - denotes Vertical Stand ; "Z" - denotes Side Stand
- (7) During the measurements above 1 GHz it is taken care of that the EUT is always within the 3 dB cone of radiation BW of the used antenna



TX CH11 (Above 1000 MHz, Horizontal)

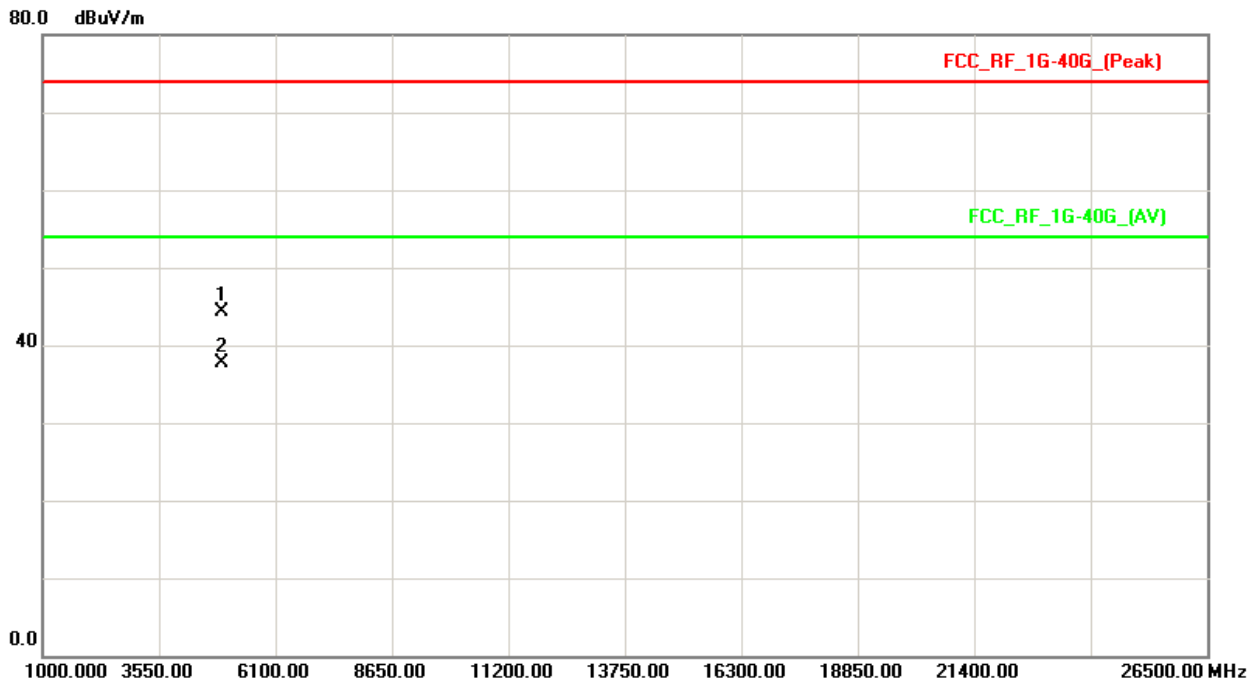
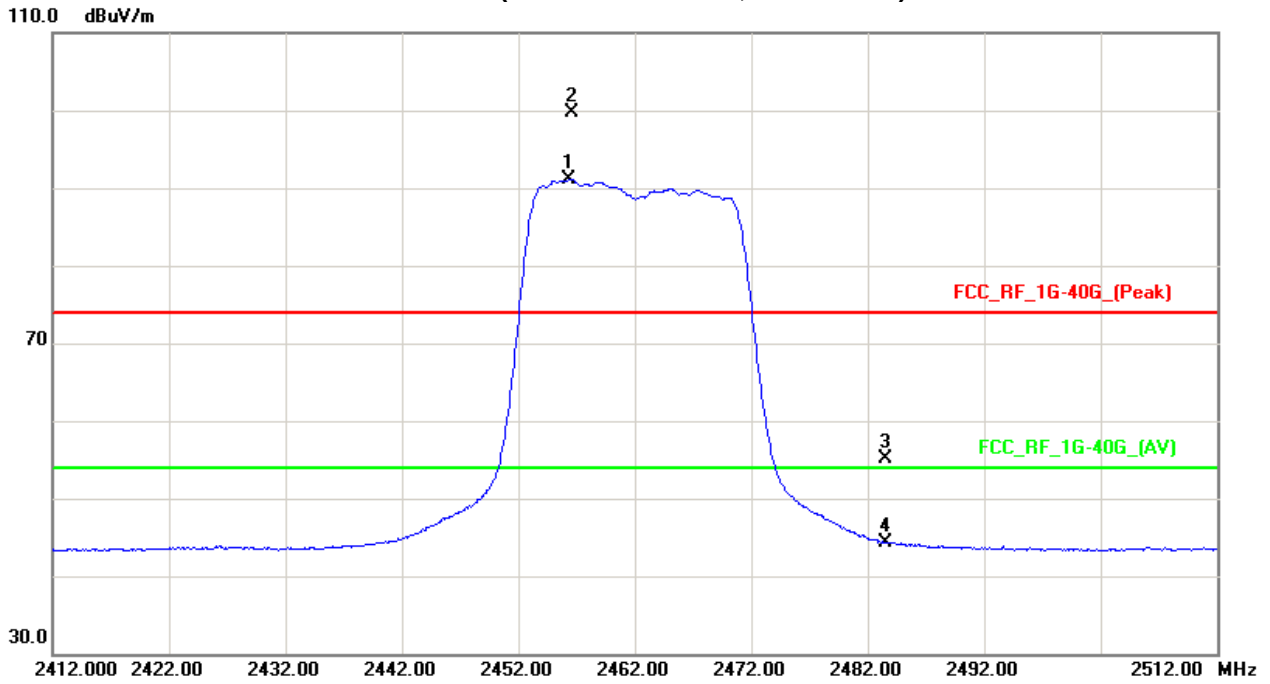



EUT :	150Mbps Wireless-N USB Adapter	Model Name :	WF-2103
Temperature :	25 °C	Relative Humidity :	51 %
Pressure :	1010 hPa	Test Voltage :	AC 120V/60Hz
Test Mode :	TX N-40M MODE 2422MHz		

Freq.	Ant.Pol.	Reading		Ant./CF	Act.		Limit		Note
		Peak	AV		Peak	AV	Peak	AV	
(MHz)	H/V	(dBuV)	(dBuV)	CF(dB)	(dBuV/m)	(dBuV/m)	(dBuV/m)	(dBuV/m)	
2390.00	V	22.66	11.49	31.54	54.20	43.03	74.00	54.00	X/E
2412.30	V	63.41	54.10	31.57	94.98	85.67			X/F
4849.98	V	41.77	35.04	6.06	47.83	41.10	74.00	54.00	X/H

Remark :

- (1) All readings are Peak unless otherwise stated QP in column of 『Note』 . Peak denotes that the Peak reading compliance with the QP Limits and then QP Mode measurement didn't perform ◦
- (2) Measuring frequency range from 30MHz to 1000MHz or the 10th harmonic of highest fundamental frequency ◦ "F" denotes fundamental frequency; "H" denotes spurious frequency. "E" denotes band edge frequency. (This judgment method includes the Band Edge Requirement.)
- (3) Radiated emissions measured in frequency range above 1000MHz were made with an instrument using Peak detector mode and AV detector mode of the emission ◦
- (4) Data of measurement within this frequency range shown " * " in the table above means the reading of emissions are attenuated more than 20dB below the permissible limits or the field strength is too small to be measured.
- (5) A preamp and high pass filter were used for this test in order to provide sufficient measurement sensitivity.
- (6) EUT Orthogonal Axis :
"X" - denotes Laid on Table ; "Y" - denotes Vertical Stand ; "Z" - denotes Side Stand
- (7) During the measurements above 1 GHz it is taken care of that the EUT is always within the 3 dB cone of radiation BW of the used antenna



TX CH03 (Above 1000 MHz, Vertical)

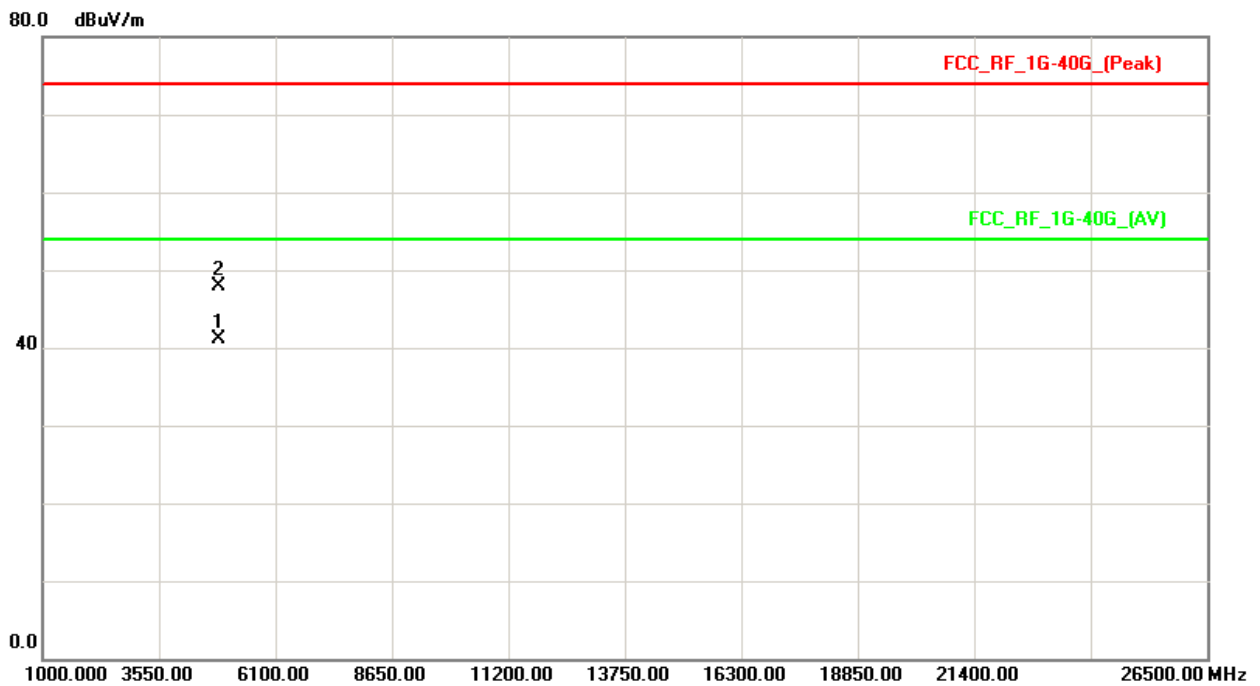
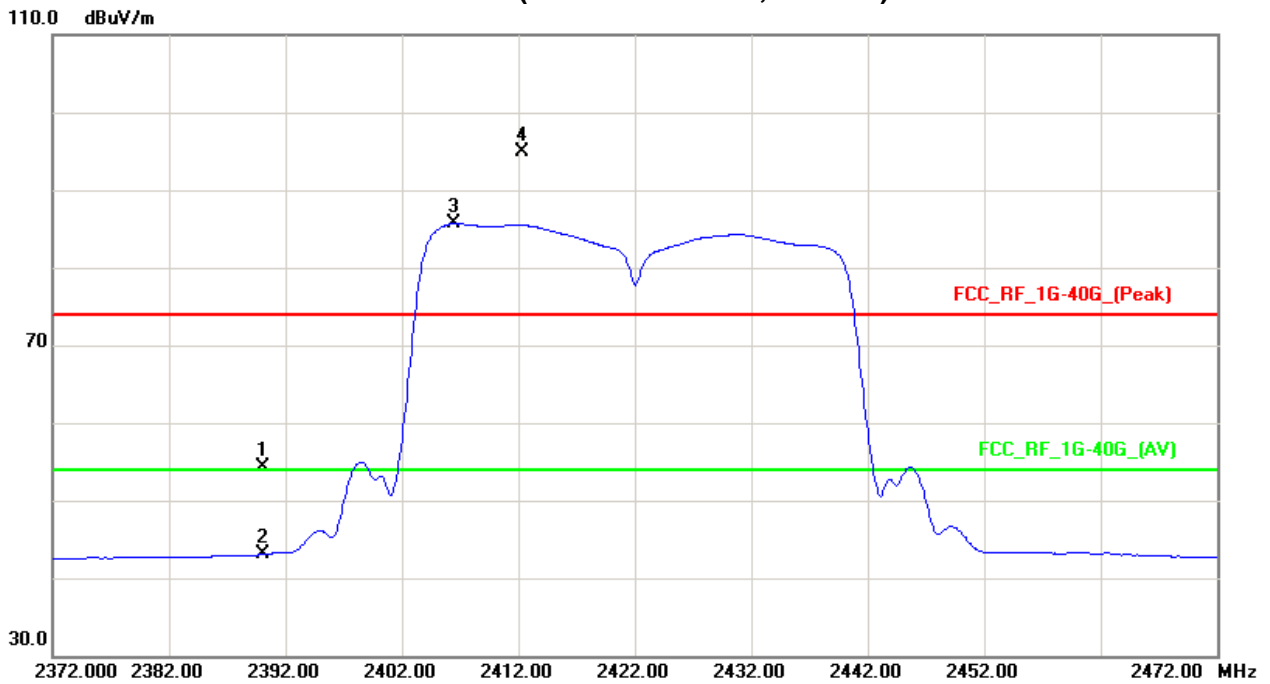



EUT :	150Mbps Wireless-N USB Adapter	Model Name :	WF-2103
Temperature :	25 °C	Relative Humidity :	51 %
Pressure :	1010 hPa	Test Voltage :	AC 120V/60Hz
Test Mode :	TX N-40M MODE 2422MHz		

Freq.	Ant.Pol.	Reading		Ant./CF	Act.		Limit		Note
		Peak	AV		Peak	AV	Peak	AV	
(MHz)	H/V	(dBuV)	(dBuV)	CF(dB)	(dBuV/m)	(dBuV/m)	(dBuV/m)	(dBuV/m)	
2390.00	H	25.20	12.26	31.54	56.74	43.80	74.00	54.00	X/E
2431.40	H	68.23	57.59	31.61	99.84	89.20			X/F
4843.97	H	6.00	31.05	6.06	44.02	37.11	74.00	54.00	X/H

Remark :

- (1) All readings are Peak unless otherwise stated QP in column of 『Note』 . Peak denotes that the Peak reading compliance with the QP Limits and then QP Mode measurement didn't perform ◦
- (2) Measuring frequency range from 30MHz to 1000MHz or the 10th harmonic of highest fundamental frequency ◦ "F" denotes fundamental frequency; "H" denotes spurious frequency. "E" denotes band edge frequency. (This judgment method includes the Band Edge Requirement.)
- (3) Radiated emissions measured in frequency range above 1000MHz were made with an instrument using Peak detector mode and AV detector mode of the emission ◦
- (4) Data of measurement within this frequency range shown " * " in the table above means the reading of emissions are attenuated more than 20dB below the permissible limits or the field strength is too small to be measured.
- (5) A preamp and high pass filter were used for this test in order to provide sufficient measurement sensitivity.
- (6) EUT Orthogonal Axis :
 "X" - denotes Laid on Table ; "Y" - denotes Vertical Stand ; "Z" - denotes Side Stand
- (7) During the measurements above 1 GHz it is taken care of that the EUT is always within the 3 dB cone of radiation BW of the used antenna



TX CH03 (Above 1000 MHz, Horizontal)

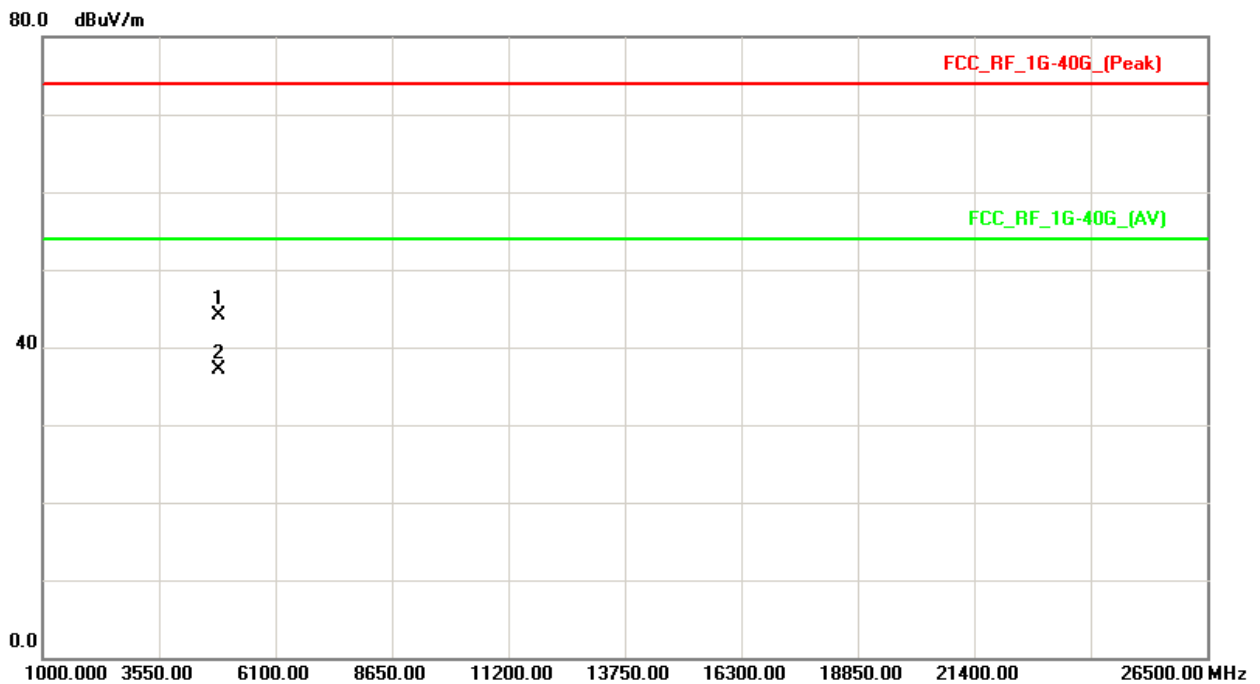
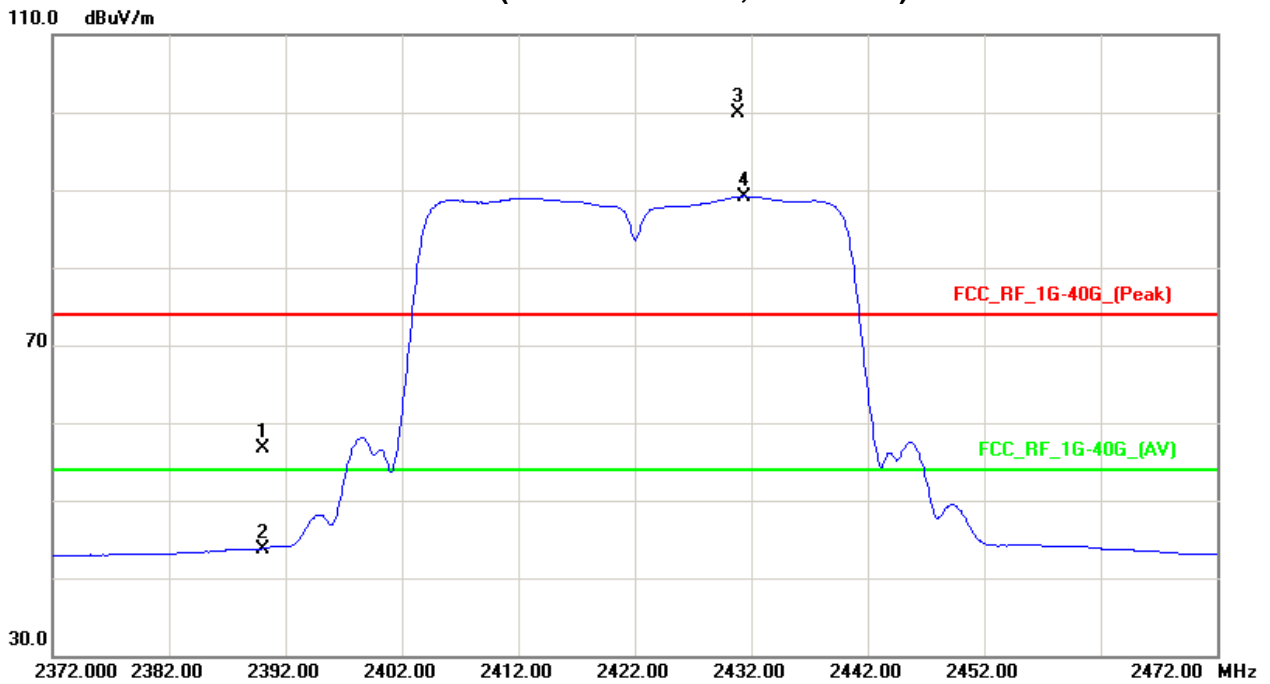



EUT :	150Mbps Wireless-N USB Adapter	Model Name :	WF-2103
Temperature :	25 °C	Relative Humidity :	51 %
Pressure :	1010 hPa	Test Voltage :	AC 120V/60Hz
Test Mode :	TX N-40M MODE 2437MHz		

Freq. (MHz)	Ant.Pol. H/V	Reading		Ant./CF CF(dB)	Act.		Limit		Note
		Peak (dBuV)	AV (dBuV)		Peak (dBuV/m)	AV (dBuV/m)	Peak (dBuV/m)	AV (dBuV/m)	
2429.40	V	61.01	51.77	31.61	92.62	83.38			X/F
4874.03	V	40.68	33.27	6.15	46.83	39.42	74.00	54.00	X/H

Remark :

- (1) All readings are Peak unless otherwise stated QP in column of 『Note』 . Peak denotes that the Peak reading compliance with the QP Limits and then QP Mode measurement didn't perform ◦
- (2) Measuring frequency range from 30MHz to 1000MHz or the 10th harmonic of highest fundamental frequency ◦ "F" denotes fundamental frequency; "H" denotes spurious frequency. "E" denotes band edge frequency. (This judgment method includes the Band Edge Requirement.)
- (3) Radiated emissions measured in frequency range above 1000MHz were made with an instrument using Peak detector mode and AV detector mode of the emission ◦
- (4) Data of measurement within this frequency range shown " * " in the table above means the reading of emissions are attenuated more than 20dB below the permissible limits or the field strength is too small to be measured.
- (5) A preamp and high pass filter were used for this test in order to provide sufficient measurement sensitivity.
- (6) EUT Orthogonal Axis :
"X" - denotes Laid on Table ; "Y" - denotes Vertical Stand ; "Z" - denotes Side Stand
- (7) During the measurements above 1 GHz it is taken care of that the EUT is always within the 3 dB cone of radiation BW of the used antenna



TX CH06 (Above 1000 MHz, Vertical)

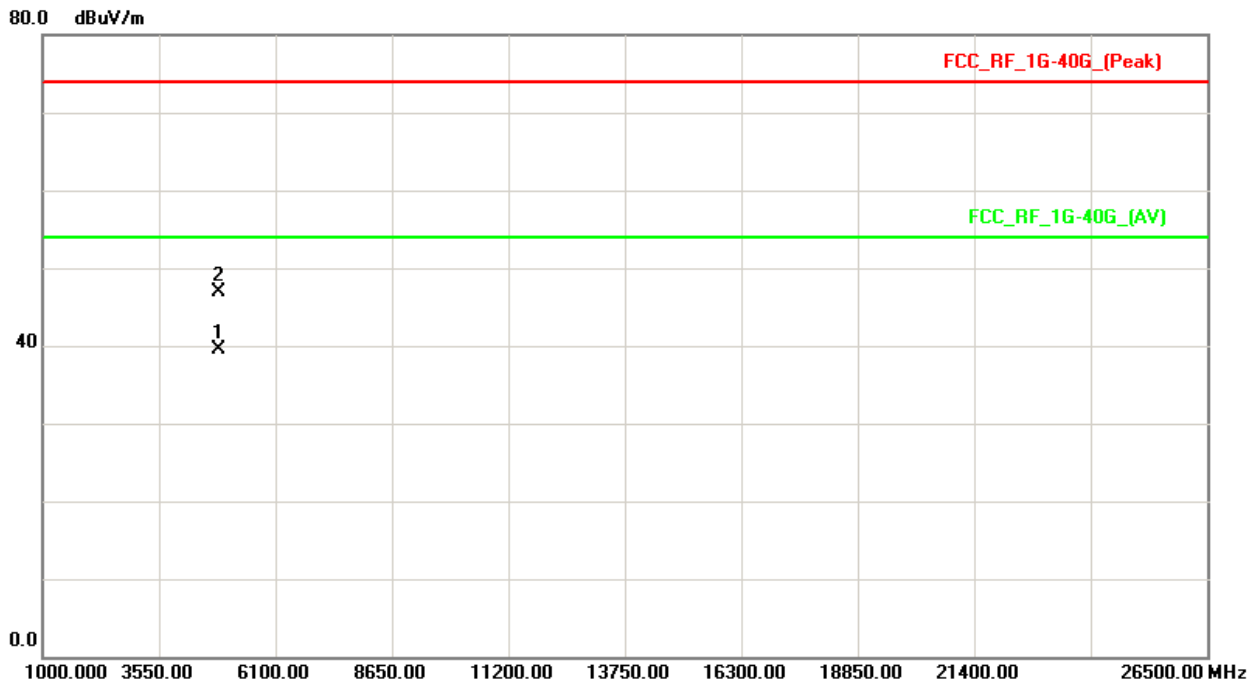
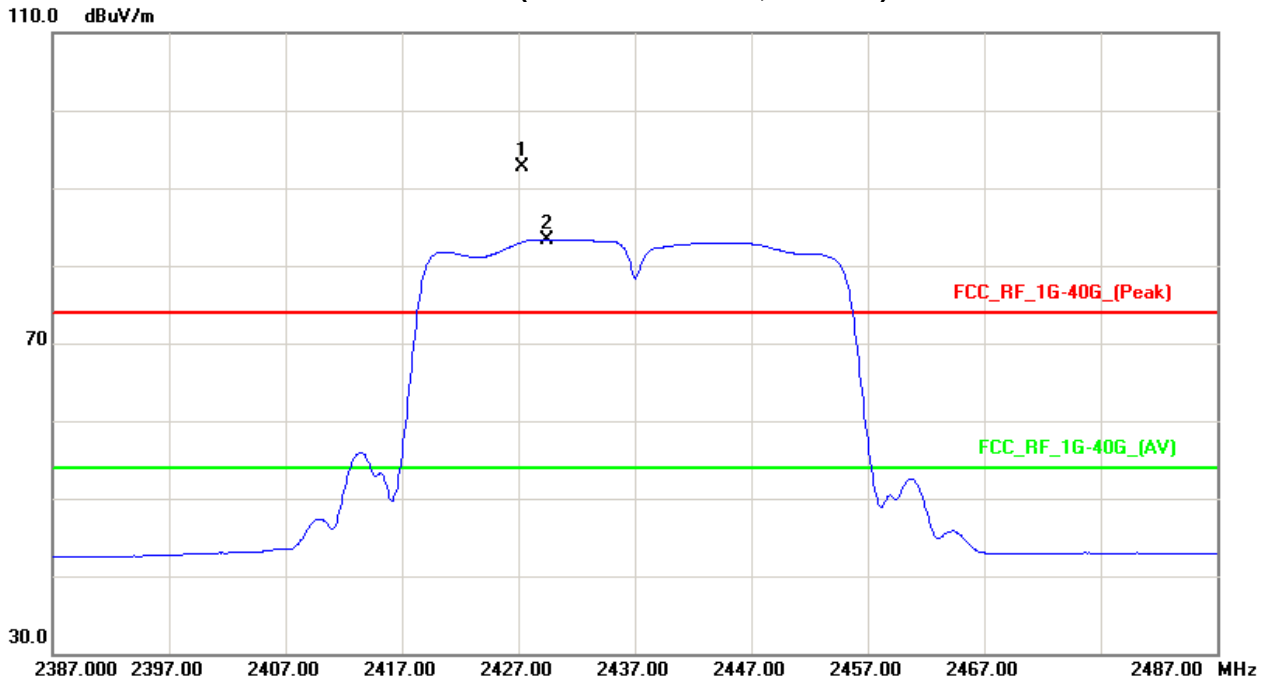



EUT :	150Mbps Wireless-N USB Adapter	Model Name :	WF-2103
Temperature :	25 °C	Relative Humidity :	51 %
Pressure :	1010 hPa	Test Voltage :	AC 120V/60Hz
Test Mode :	TX N-40M MODE 2437MHz		

Freq.	Ant.Pol.	Reading		Ant./CF	Act.		Limit		Note
		Peak	AV		Peak	AV	Peak	AV	
(MHz)	H/V	(dBuV)	(dBuV)	CF(dB)	(dBuV/m)	(dBuV/m)	(dBuV/m)	(dBuV/m)	
2433.40	H	66.33	57.29	31.61	97.94	88.90			X/F
4874.16	H	37.81	31.27	6.15	43.96	37.42	74.00	54.00	X/H

Remark :

- (1) All readings are Peak unless otherwise stated QP in column of 『Note』 . Peak denotes that the Peak reading compliance with the QP Limits and then QP Mode measurement didn't perform ◦
- (2) Measuring frequency range from 30MHz to 1000MHz or the 10th harmonic of highest fundamental frequency ◦ "F" denotes fundamental frequency; "H" denotes spurious frequency. "E" denotes band edge frequency. (This judgment method includes the Band Edge Requirement.)
- (3) Radiated emissions measured in frequency range above 1000MHz were made with an instrument using Peak detector mode and AV detector mode of the emission ◦
- (4) Data of measurement within this frequency range shown " * " in the table above means the reading of emissions are attenuated more than 20dB below the permissible limits or the field strength is too small to be measured.
- (5) A preamp and high pass filter were used for this test in order to provide sufficient measurement sensitivity.
- (6) EUT Orthogonal Axis :
"X" - denotes Laid on Table ; "Y" - denotes Vertical Stand ; "Z" - denotes Side Stand
- (7) During the measurements above 1 GHz it is taken care of that the EUT is always within the 3 dB cone of radiation BW of the used antenna



TX CH06 (Above 1000 MHz, Horizontal)

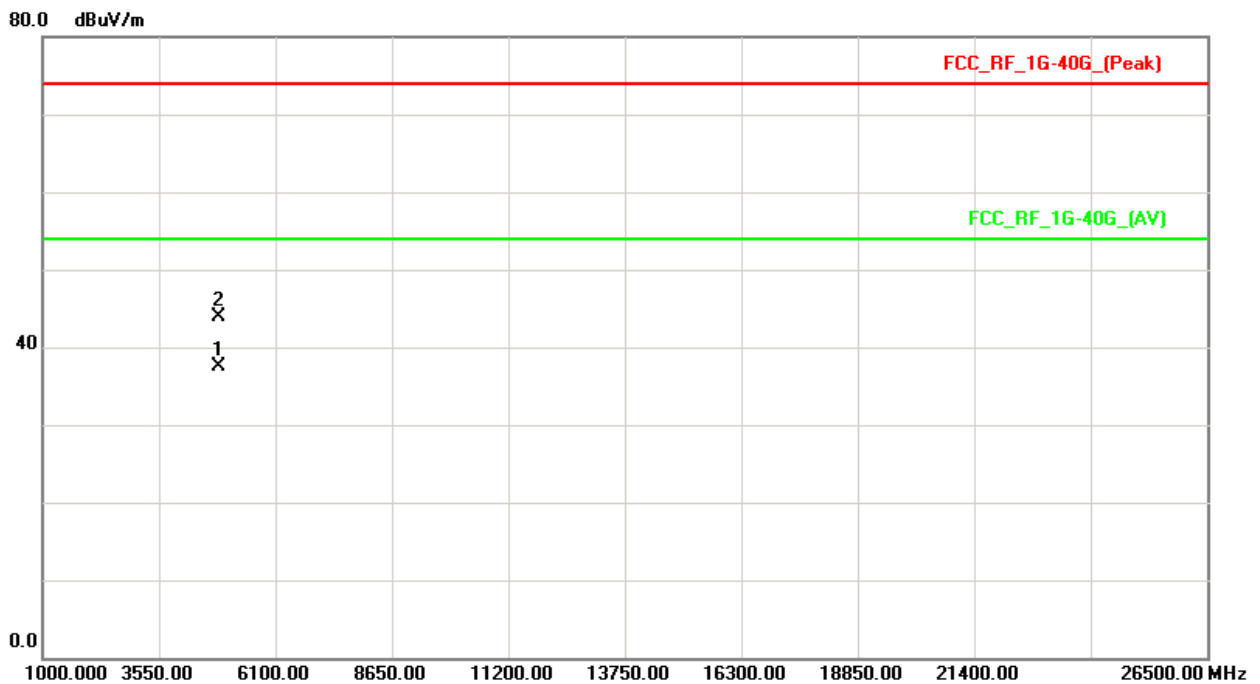
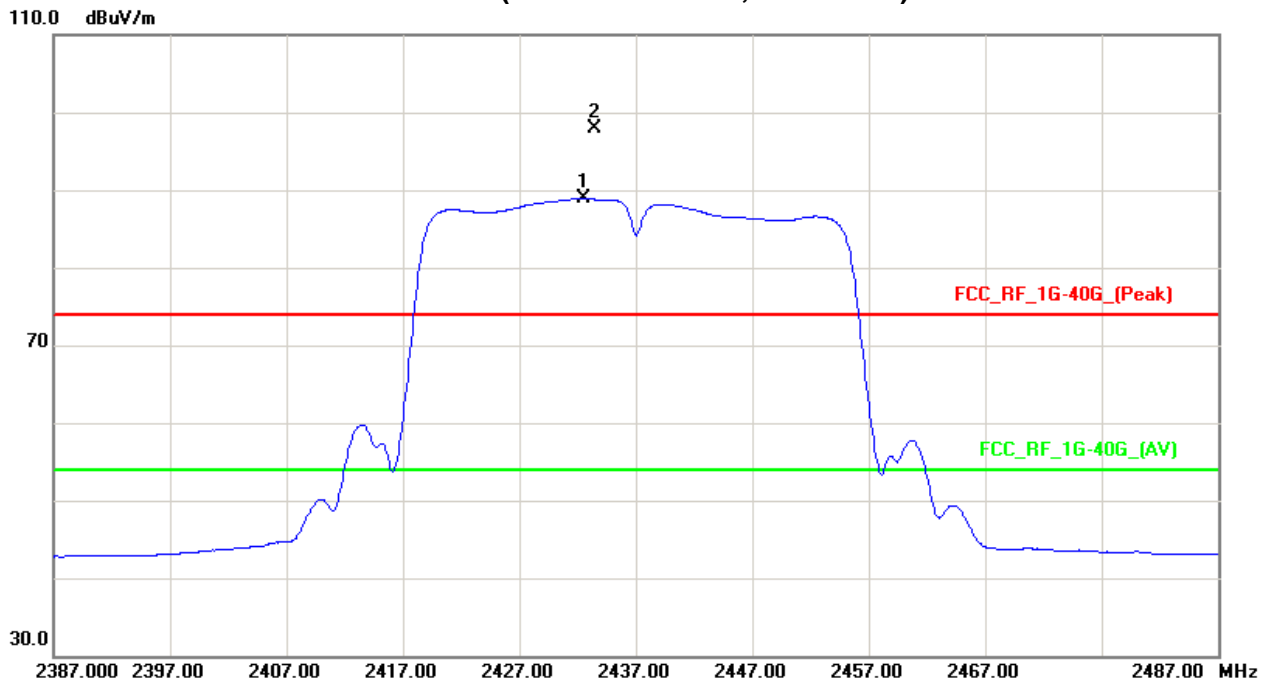



EUT :	150Mbps Wireless-N USB Adapter	Model Name :	WF-2103
Temperature :	25 °C	Relative Humidity :	51 %
Pressure :	1010 hPa	Test Voltage :	AC 120V/60Hz
Test Mode :	TX N-40M MODE 2452MHz		

Freq.	Ant.Pol.	Reading		Ant./CF	Act.		Limit		Note
		Peak	AV		Peak	AV	Peak	AV	
(MHz)	H/V	(dBuV)	(dBuV)	CF(dB)	(dBuV/m)	(dBuV/m)	(dBuV/m)	(dBuV/m)	
2443.20	V	60.41	51.22	31.63	92.04	82.85			X/F
2483.50	V	21.88	11.37	31.70	53.58	43.07	74.00	54.00	X/E
4903.99	V	39.90	31.83	6.23	46.13	38.06	74.00	54.00	X/H

Remark :

- (1) All readings are Peak unless otherwise stated QP in column of 『Note』 . Peak denotes that the Peak reading compliance with the QP Limits and then QP Mode measurement didn't perform ◦
- (2) Measuring frequency range from 30MHz to 1000MHz or the 10th harmonic of highest fundamental frequency ◦ "F" denotes fundamental frequency; "H" denotes spurious frequency. "E" denotes band edge frequency. (This judgment method includes the Band Edge Requirement.)
- (3) Radiated emissions measured in frequency range above 1000MHz were made with an instrument using Peak detector mode and AV detector mode of the emission ◦
- (4) Data of measurement within this frequency range shown " * " in the table above means the reading of emissions are attenuated more than 20dB below the permissible limits or the field strength is too small to be measured.
- (5) A preamp and high pass filter were used for this test in order to provide sufficient measurement sensitivity.
- (6) EUT Orthogonal Axis :
 "X" - denotes Laid on Table ; "Y" - denotes Vertical Stand ; "Z" - denotes Side Stand
- (7) During the measurements above 1 GHz it is taken care of that the EUT is always within the 3 dB cone of radiation BW of the used antenna



TX CH09 (Above 1000 MHz, Vertical)

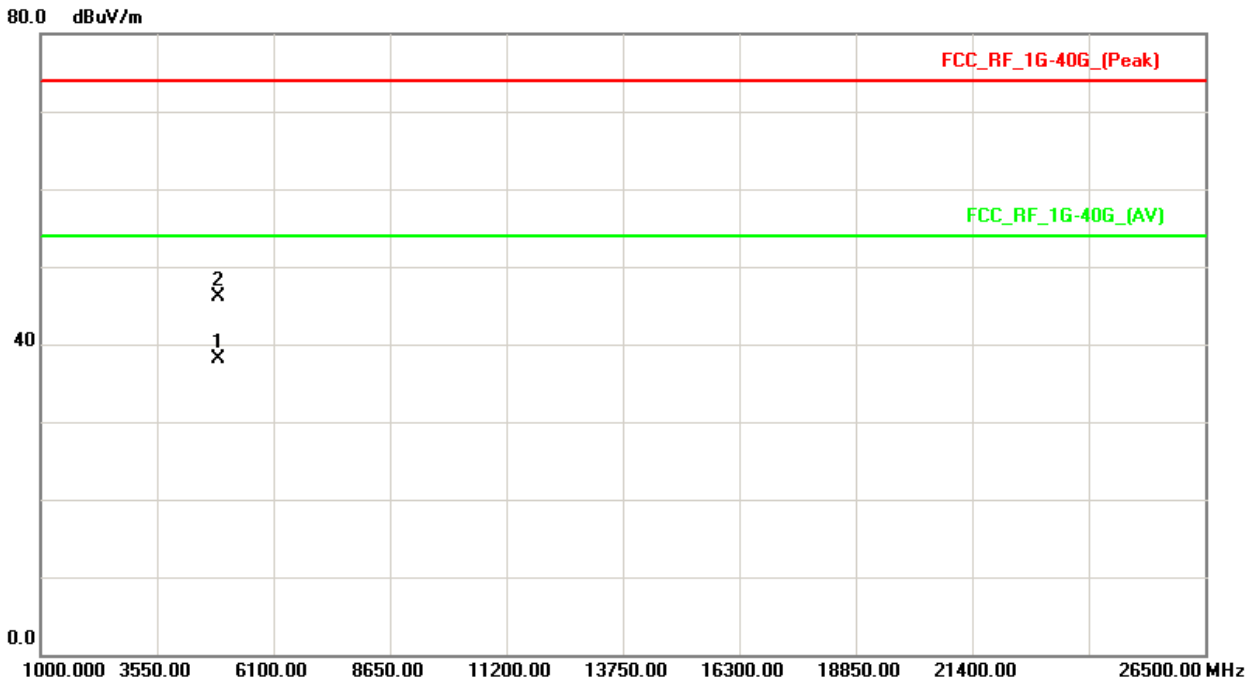
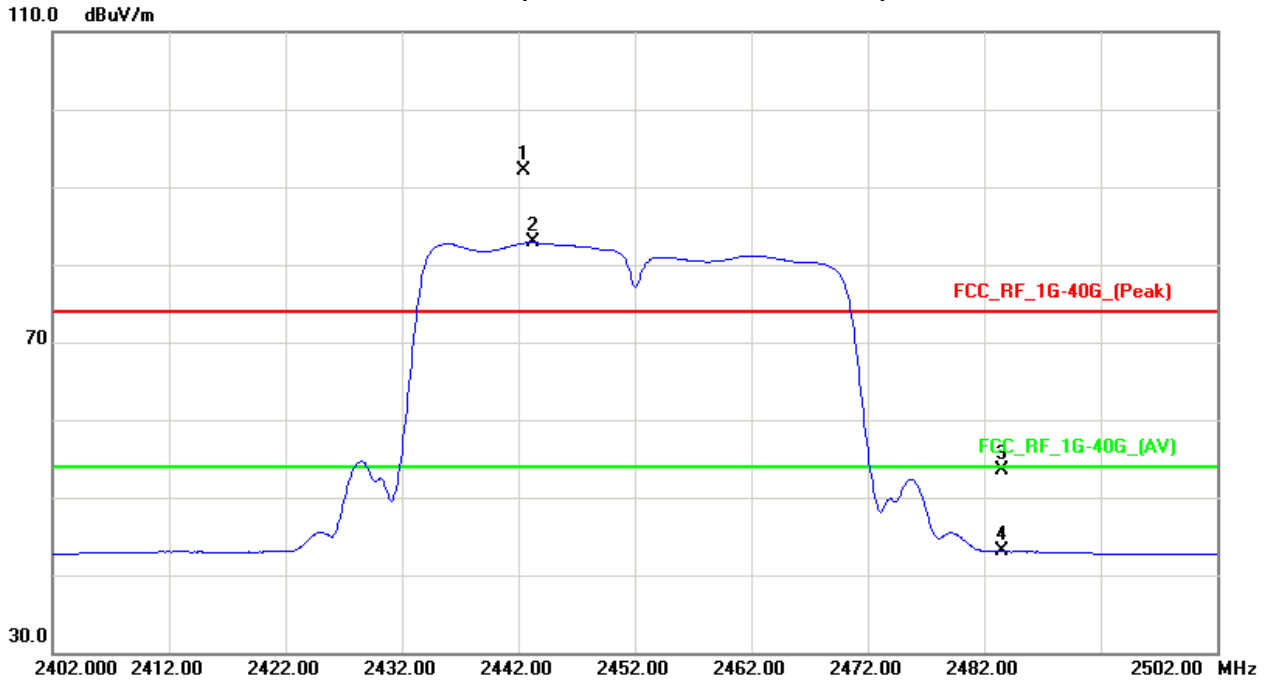



EUT :	150Mbps Wireless-N USB Adapter	Model Name :	WF-2103
Temperature :	25 °C	Relative Humidity :	51 %
Pressure :	1010 hPa	Test Voltage :	AC 120V/60Hz
Test Mode :	TX N-40M MODE 2452MHz		

Freq.	Ant.Pol.	Reading		Ant./CF	Act.		Limit		Note
		Peak	AV		Peak	AV	Peak	AV	
(MHz)	H/V	(dBuV)	(dBuV)	CF(dB)	(dBuV/m)	(dBuV/m)	(dBuV/m)	(dBuV/m)	
2436.30	H	66.28	57.47	31.62	97.90	89.09			X/F
2483.50	H	24.01	12.30	31.70	55.71	44.00	74.00	54.00	X/E
4903.98	H	37.79	30.60	6.23	44.02	36.83	74.00	54.00	X/H

Remark :

- (1) All readings are Peak unless otherwise stated QP in column of 『Note』 . Peak denotes that the Peak reading compliance with the QP Limits and then QP Mode measurement didn't perform ◦
- (2) Measuring frequency range from 30MHz to 1000MHz or the 10th harmonic of highest fundamental frequency ◦ "F" denotes fundamental frequency; "H" denotes spurious frequency. "E" denotes band edge frequency. (This judgment method includes the Band Edge Requirement.)
- (3) Radiated emissions measured in frequency range above 1000MHz were made with an instrument using Peak detector mode and AV detector mode of the emission ◦
- (4) Data of measurement within this frequency range shown " * " in the table above means the reading of emissions are attenuated more than 20dB below the permissible limits or the field strength is too small to be measured.
- (5) A preamp and high pass filter were used for this test in order to provide sufficient measurement sensitivity.
- (6) EUT Orthogonal Axis :
 "X" - denotes Laid on Table ; "Y" - denotes Vertical Stand ; "Z" - denotes Side Stand
- (7) During the measurements above 1 GHz it is taken care of that the EUT is always within the 3 dB cone of radiation BW of the used antenna



TX CH09 (Above 1000 MHz, Horizontal)

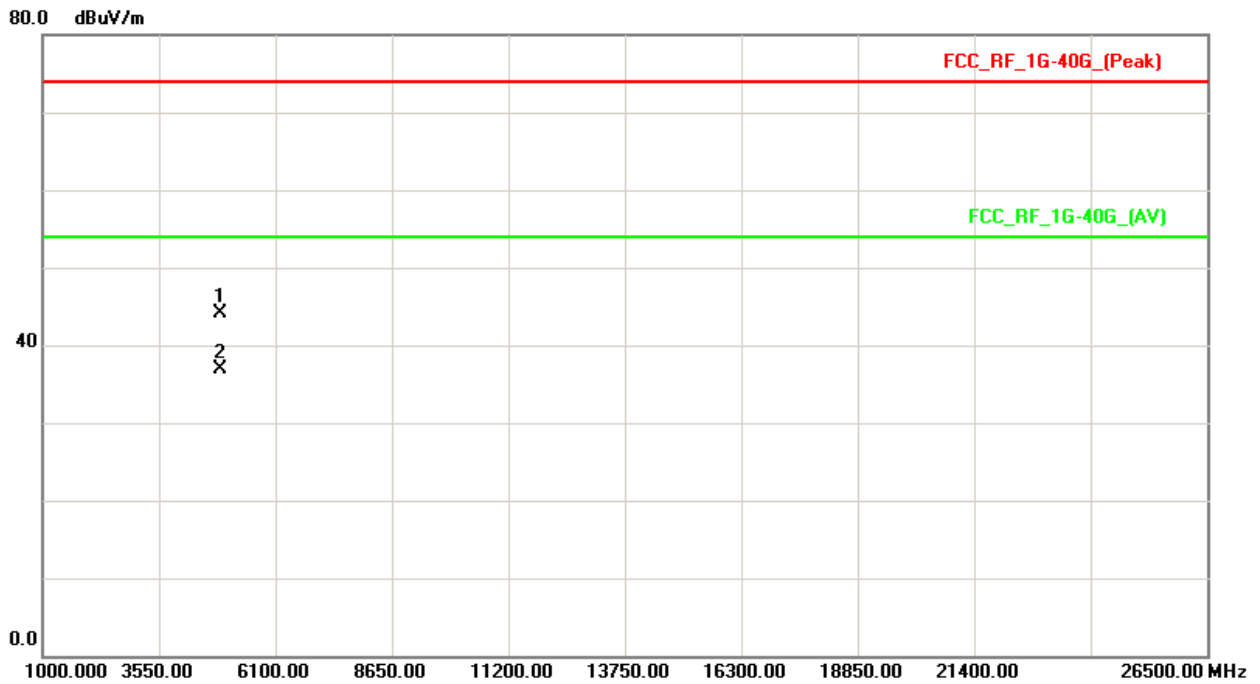
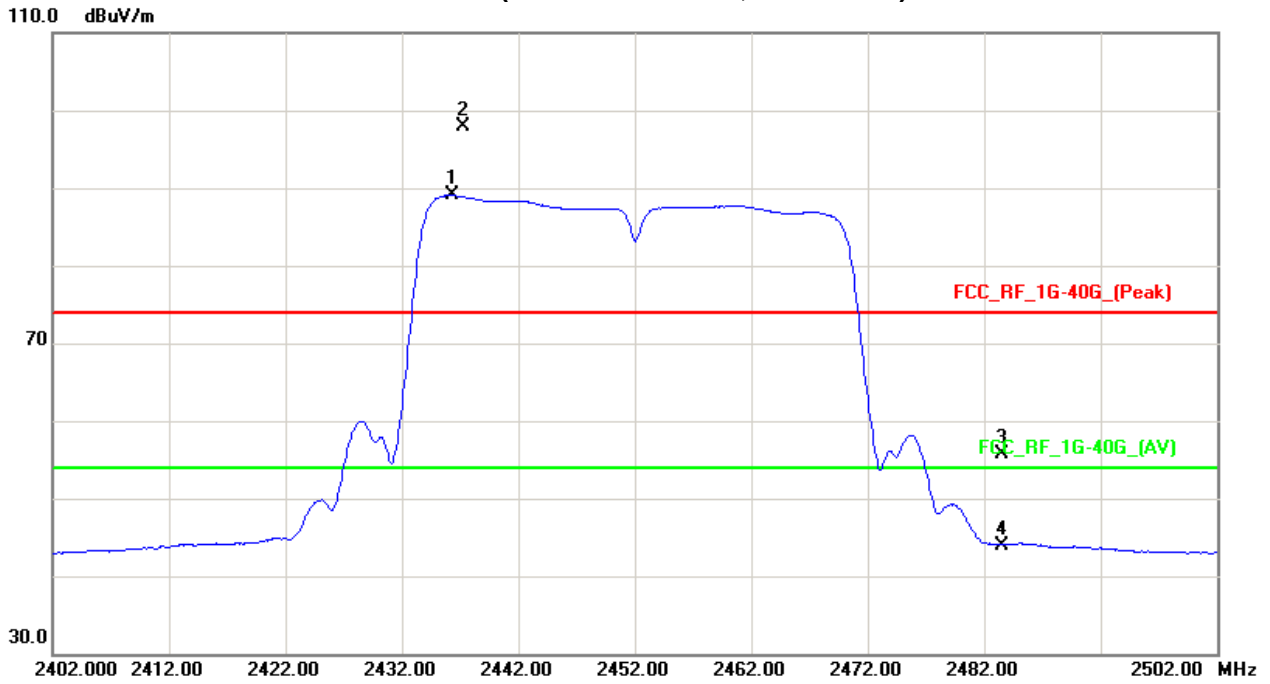



5. BANDWIDTH TEST

5.1 Applied procedures / limit

FCC Part15 (15.247) , Subpart C				
Section	Test Item	Limit	Frequency Range (MHz)	Result
15.247(a)(2)	Bandwidth	>= 500KHz (6dB bandwidth)	2400-2483.5	PASS

5.1.1 MEASUREMENT INSTRUMENTS LIST

Item	Kind of Equipment	Manufacturer	Type No.	Serial No.	Calibrated until
1	Spectrum Analyzer	R&S	FSP_40	100129	Jan. 04, 2012

Remark: " N/A" denotes No Model Name. , Serial No. or No Calibration specified.

5.1.2 TEST PROCEDURE

- a. The EUT was directly connected to the spectrum analyzer and antenna output port as show in the block diagram below,
- b. Spectrum Setting : RBW= 100KHz, VBW=100KHz, Sweep time = 5 ms.

5.1.3 DEVIATION FROM STANDARD

No deviation.



5.1.4 TEST SETUP

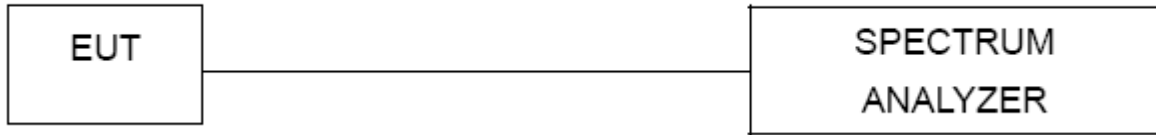

5.1.5 EUT OPERATION CONDITIONS

The EUT tested system was configured as the statements of 4.1.6 Unless otherwise a special operating condition is specified in the follows during the testing.



5.1.6 TEST RESULTS

EUT :	150Mbps Wireless-N USB Adapter	Model Name. :	WF-2103
Temperature :	24 °C	Relative Humidity :	60 %
Pressure :	1016 hPa	Test Voltage :	AC 120V/60Hz
Test Mode :	TX B MODE /CH01, CH06, CH11		

Test Channel	Frequency (MHz)	Bandwidth (MHz)	LIMIT (MHz)
CH01	2412	10.10	>=500KHz
CH06	2437	10.00	>=500KHz
CH11	2462	10.10	>=500KHz

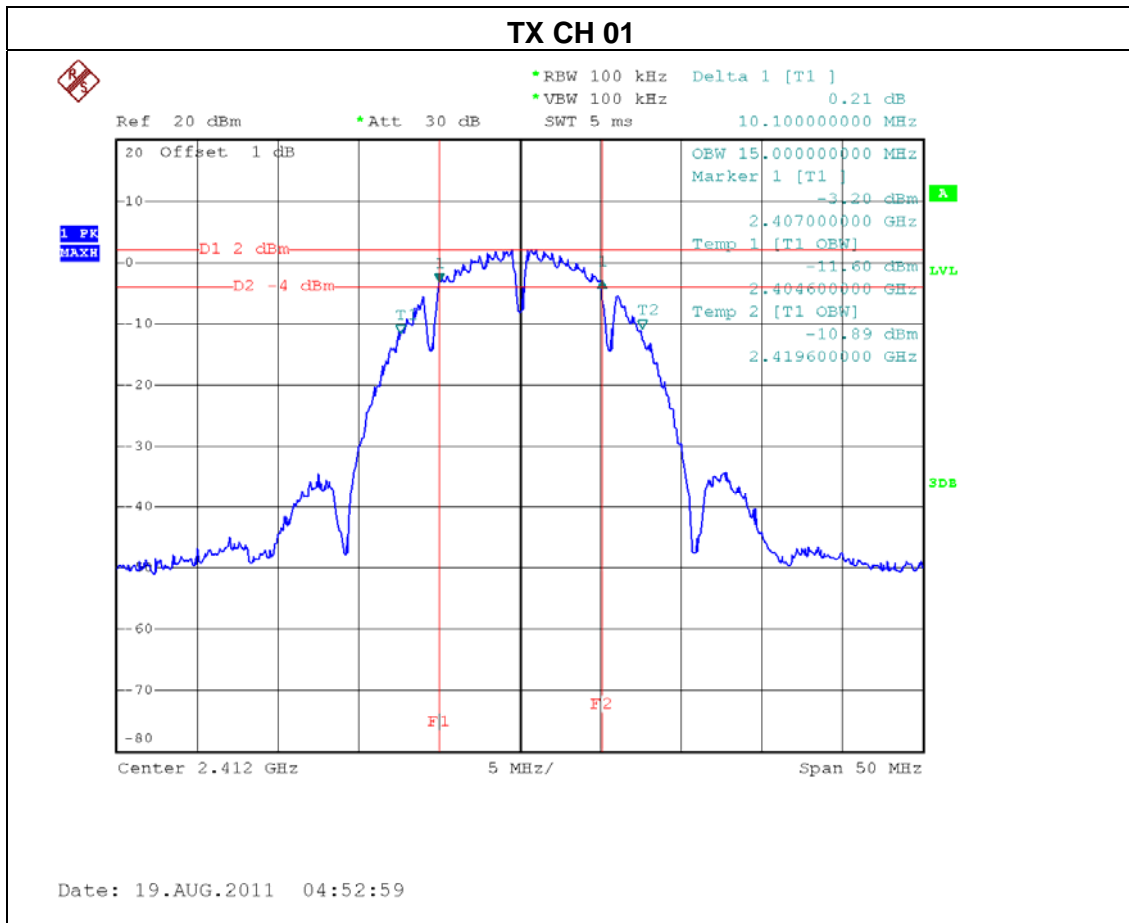

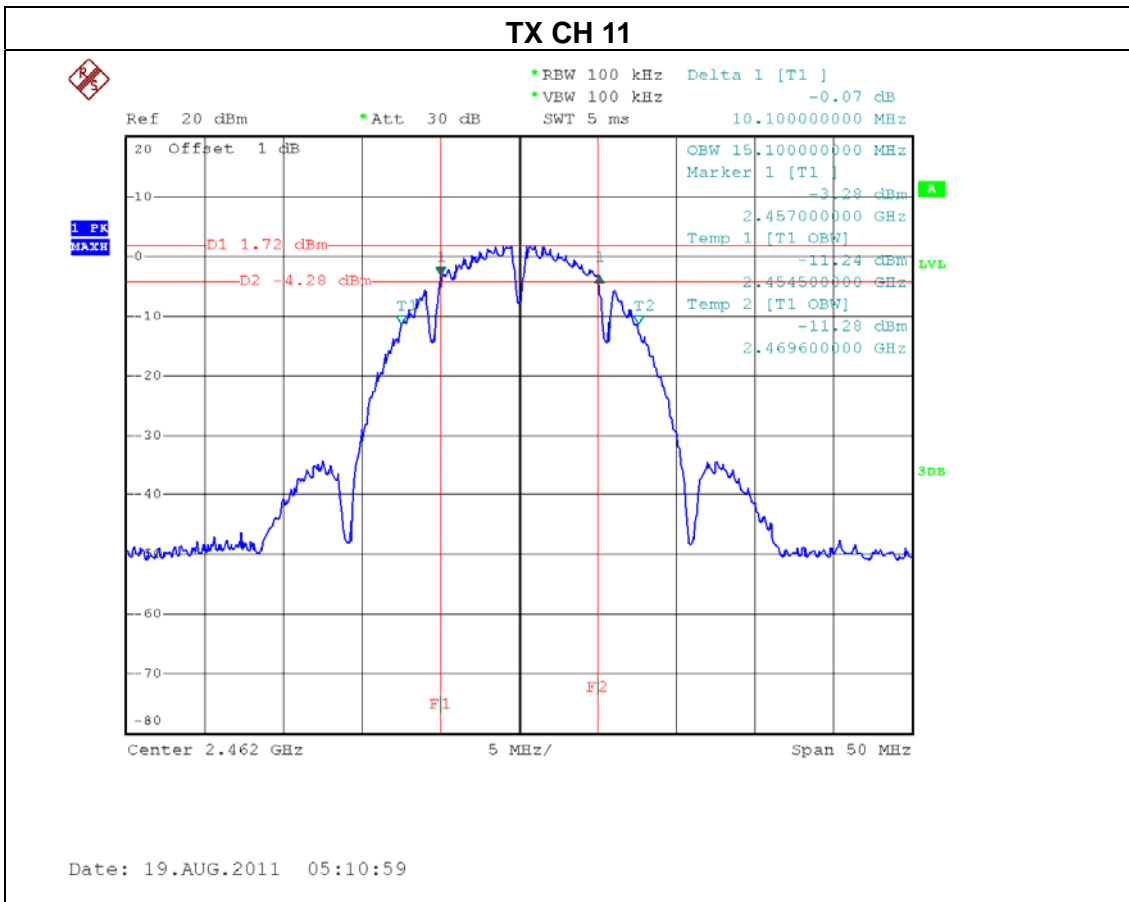
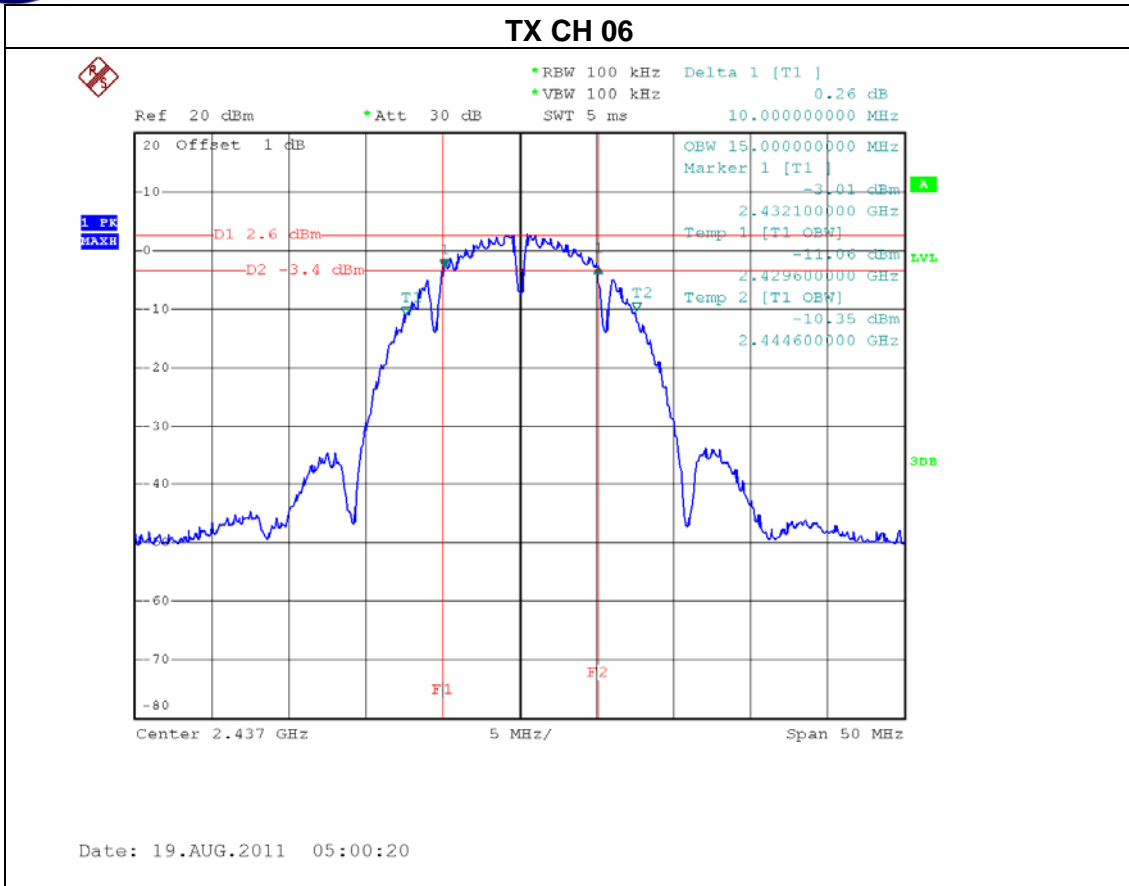



EUT :	150Mbps Wireless-N USB Adapter	Model Name. :	WF-2103
Temperature :	24 °C	Relative Humidity :	60 %
Pressure :	1016 hPa	Test Voltage :	AC 120V/60Hz
Test Mode :	TX G MODE /CH01, CH06, CH11		

Test Channel	Frequency (MHz)	Bandwidth (MHz)	LIMIT (MHz)
CH01	2412	16.60	>=500KHz
CH06	2437	16.60	>=500KHz
CH11	2462	16.60	>=500KHz

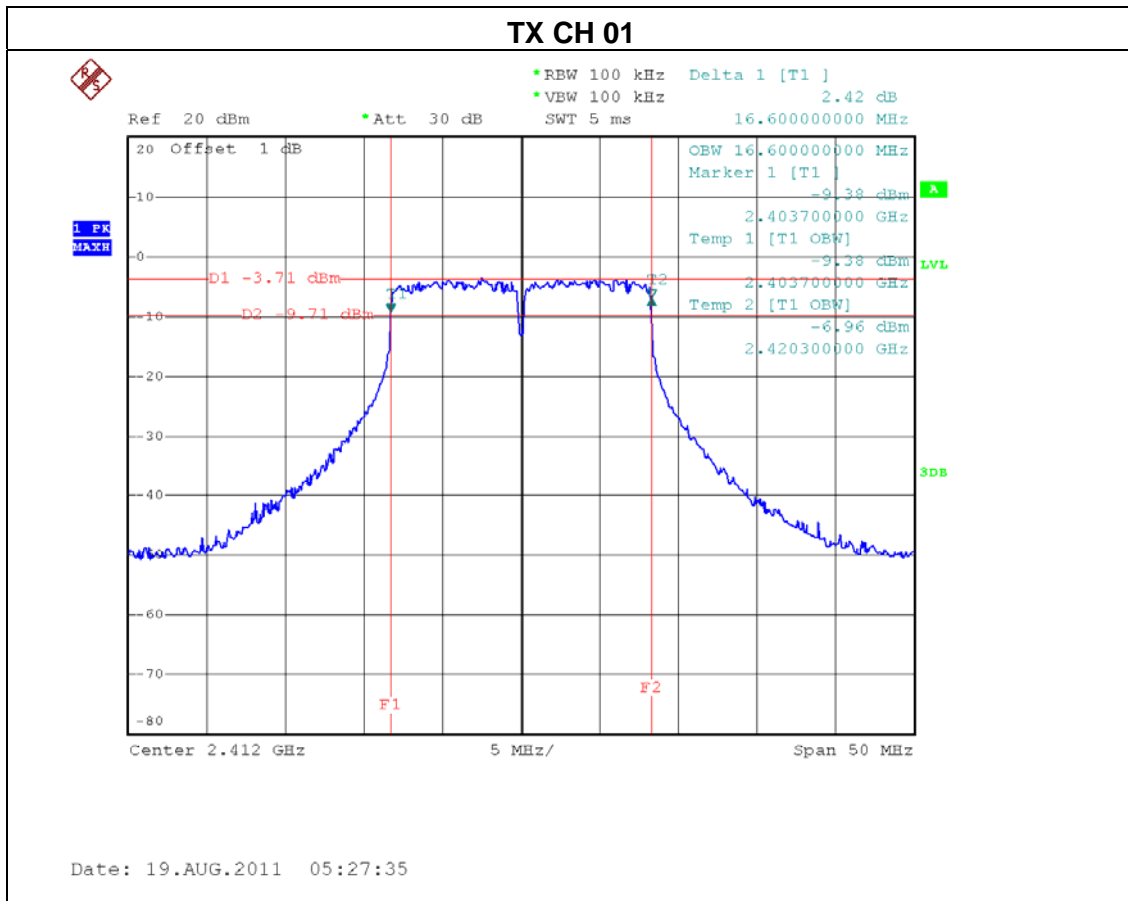

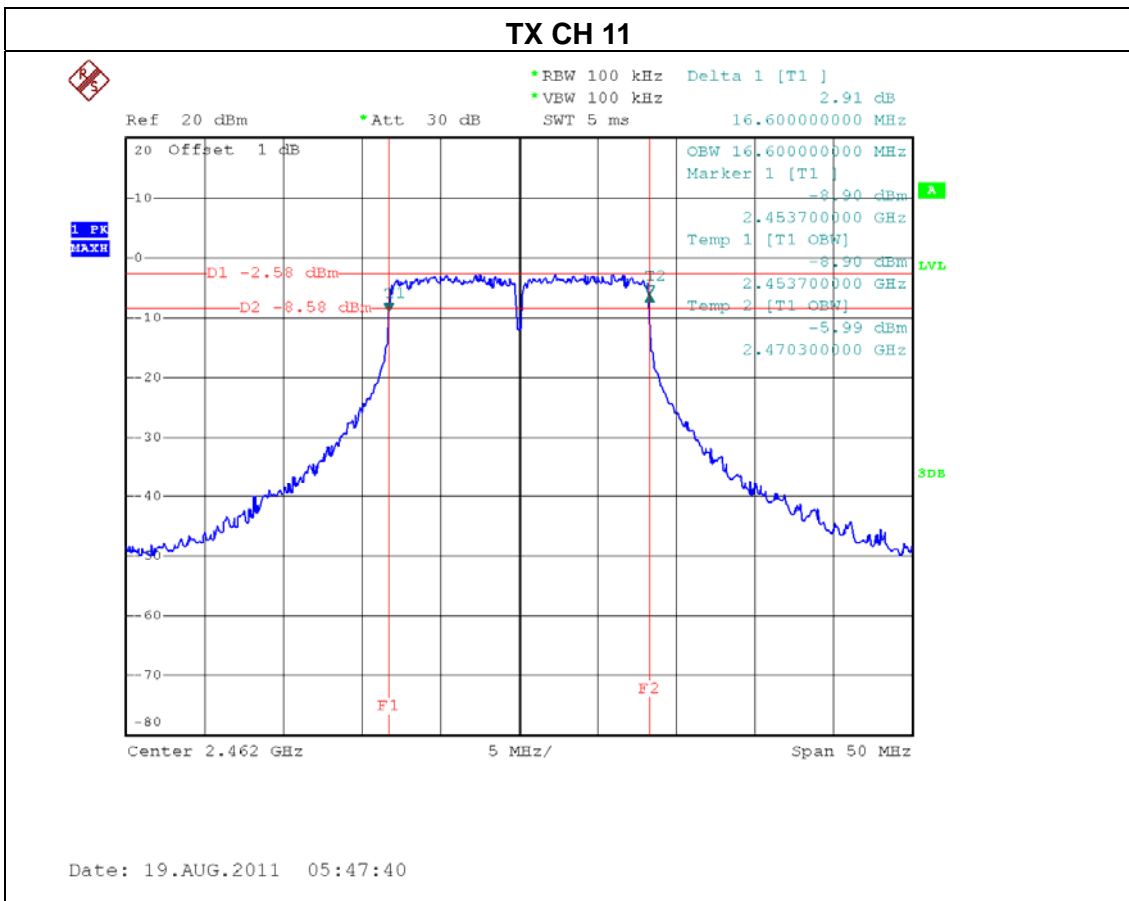
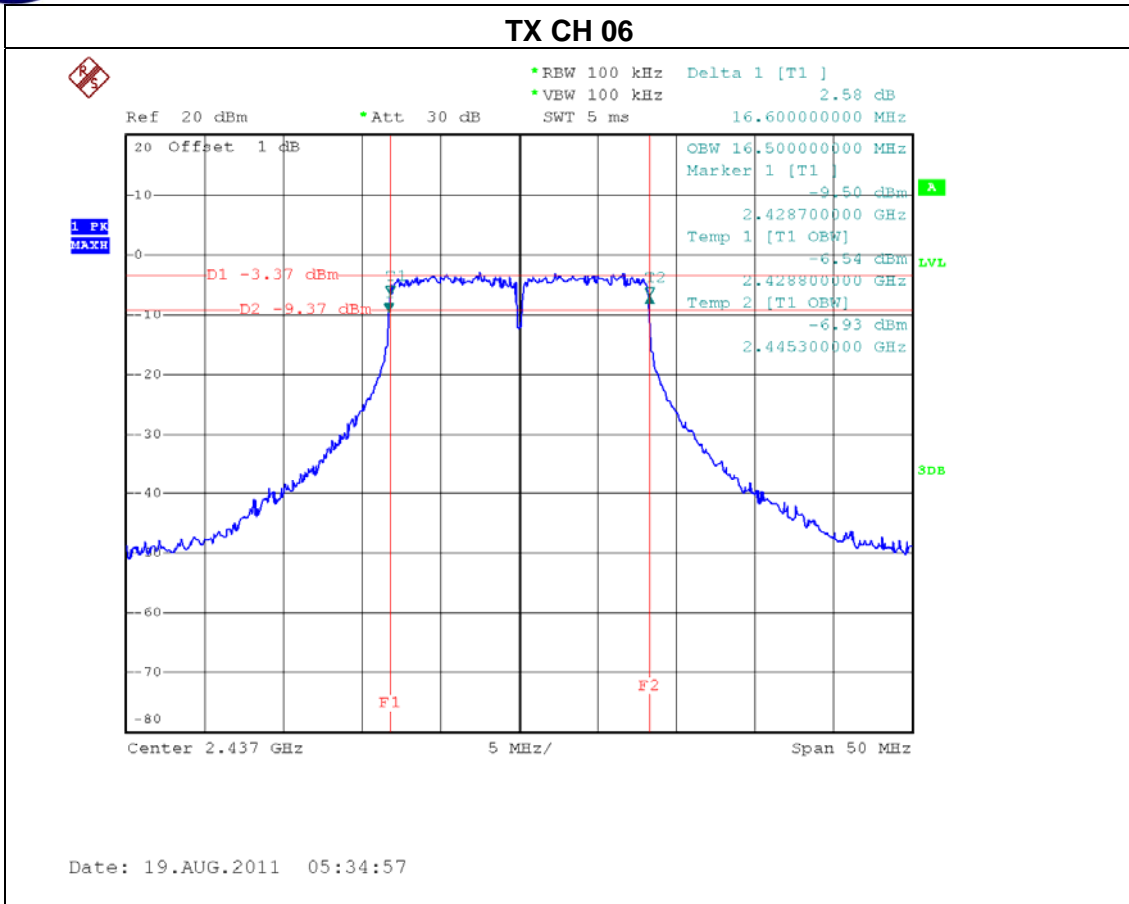



EUT :	150Mbps Wireless-N USB Adapter	Model Name. :	WF-2103
Temperature :	24 °C	Relative Humidity :	60 %
Pressure :	1016 hPa	Test Voltage :	AC 120V/60Hz
Test Mode :	TX N MODE -20MHz/ CH01, CH06, CH11		

Test Channel	Frequency (MHz)	Bandwidth (MHz)	LIMIT (MHz)
CH01	2412	17.90	>=500KHz
CH06	2437	17.90	>=500KHz
CH11	2462	17.90	>=500KHz

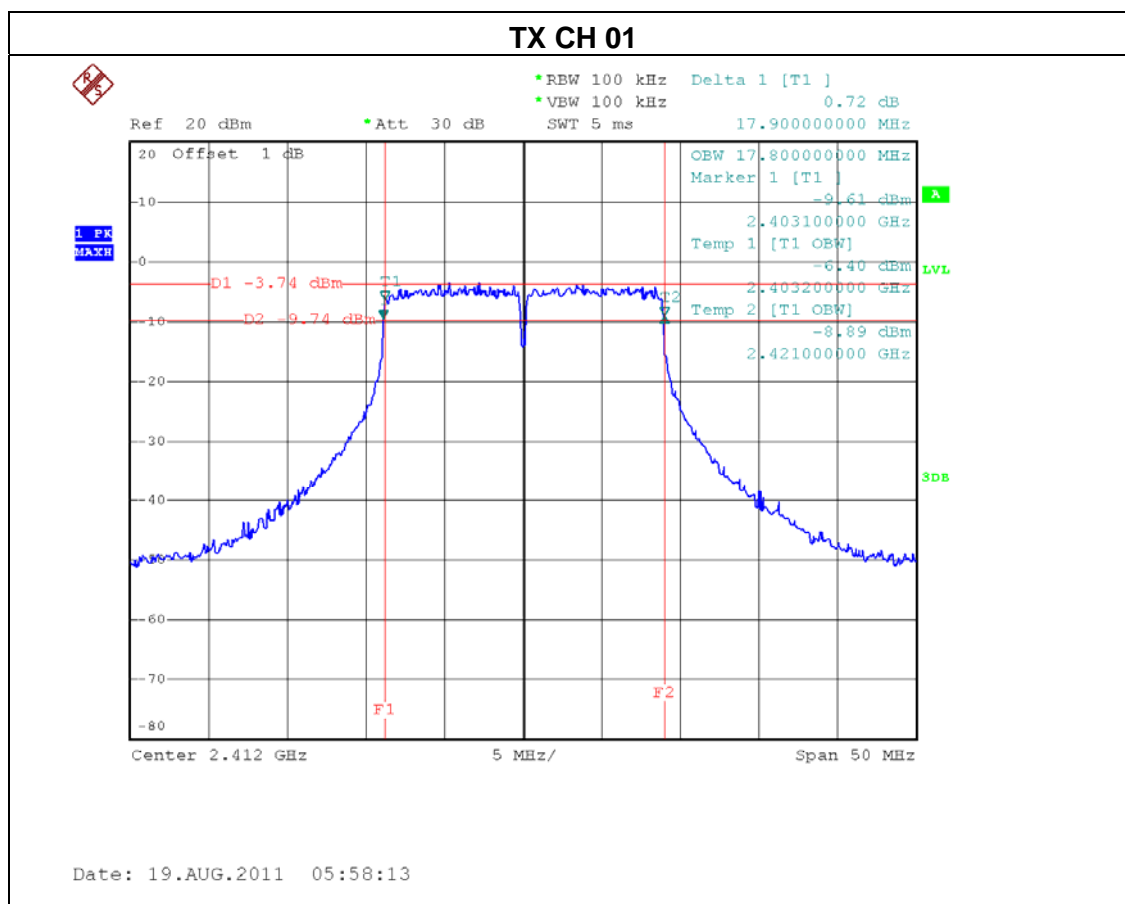

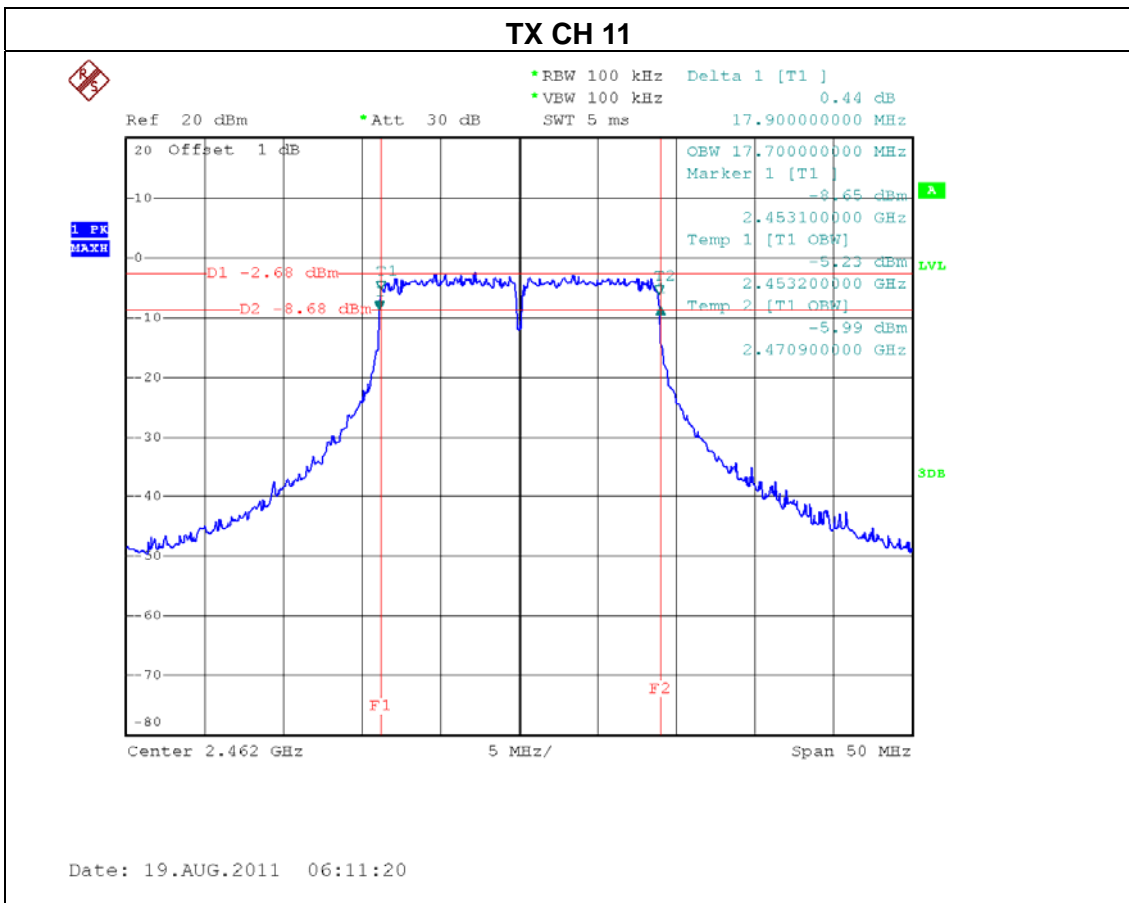
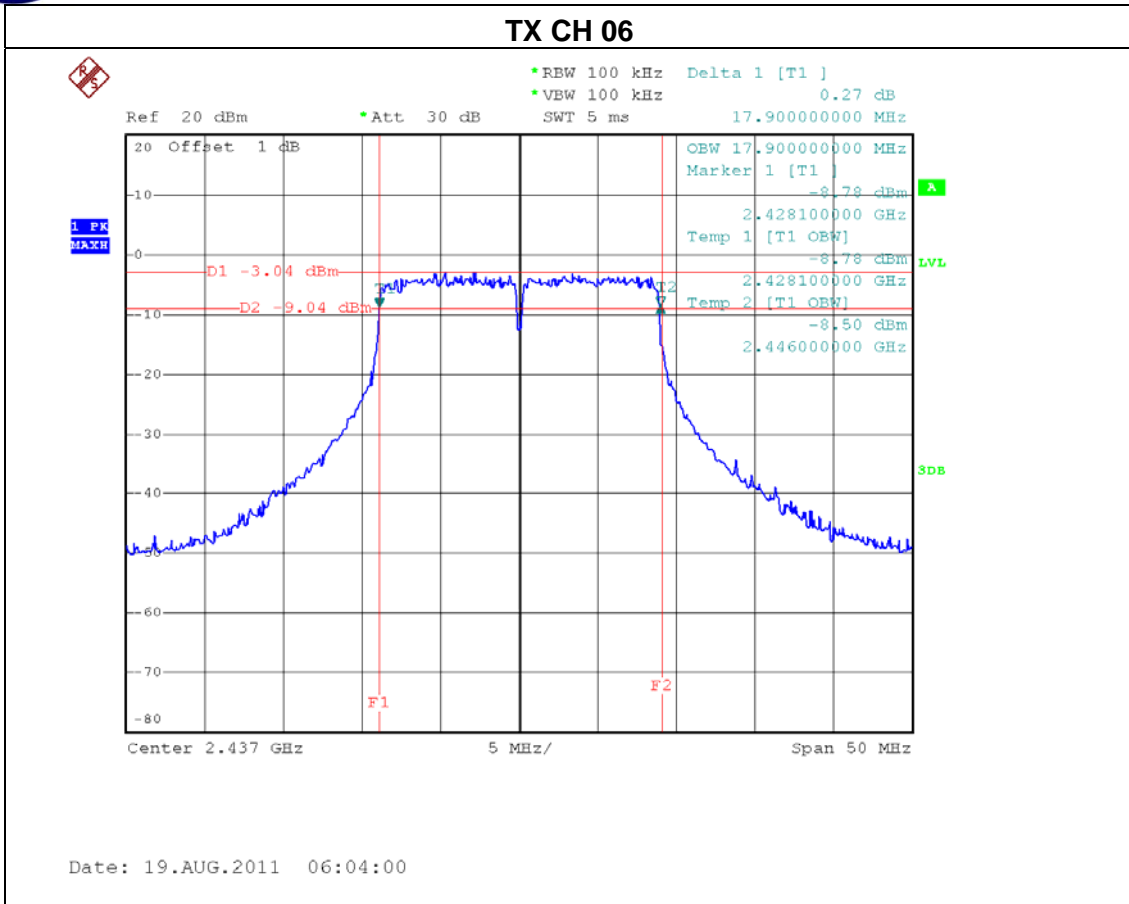



EUT :	150Mbps Wireless-N USB Adapter	Model Name. :	WF-2103
Temperature :	24 °C	Relative Humidity :	60 %
Pressure :	1016 hPa	Test Voltage :	AC 120V/60Hz
Test Mode :	TX N MODE -40MHz/ CH03, CH06, CH09		

Test Channel	Frequency (MHz)	Bandwidth (MHz)	LIMIT (MHz)
CH03	2422	36.60	>=500KHz
CH06	2437	36.60	>=500KHz
CH09	2452	36.60	>=500KHz

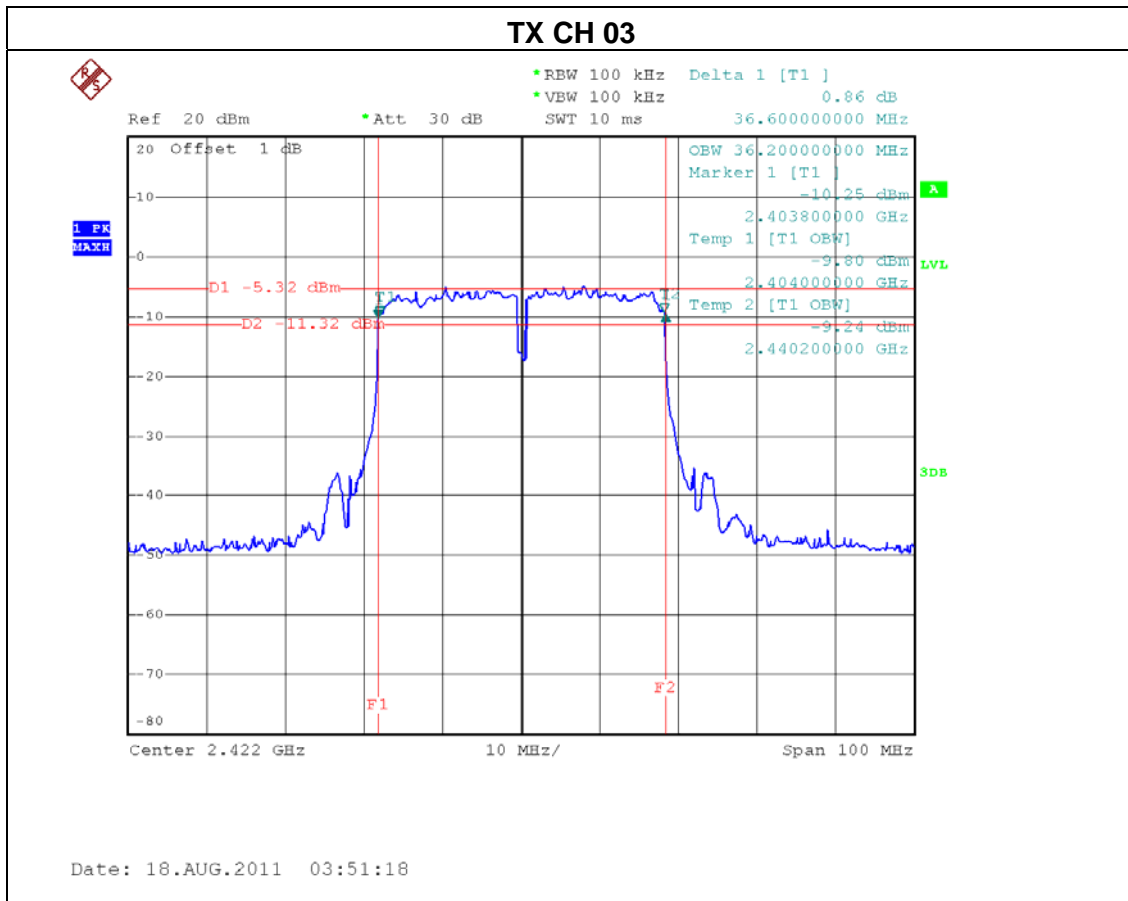

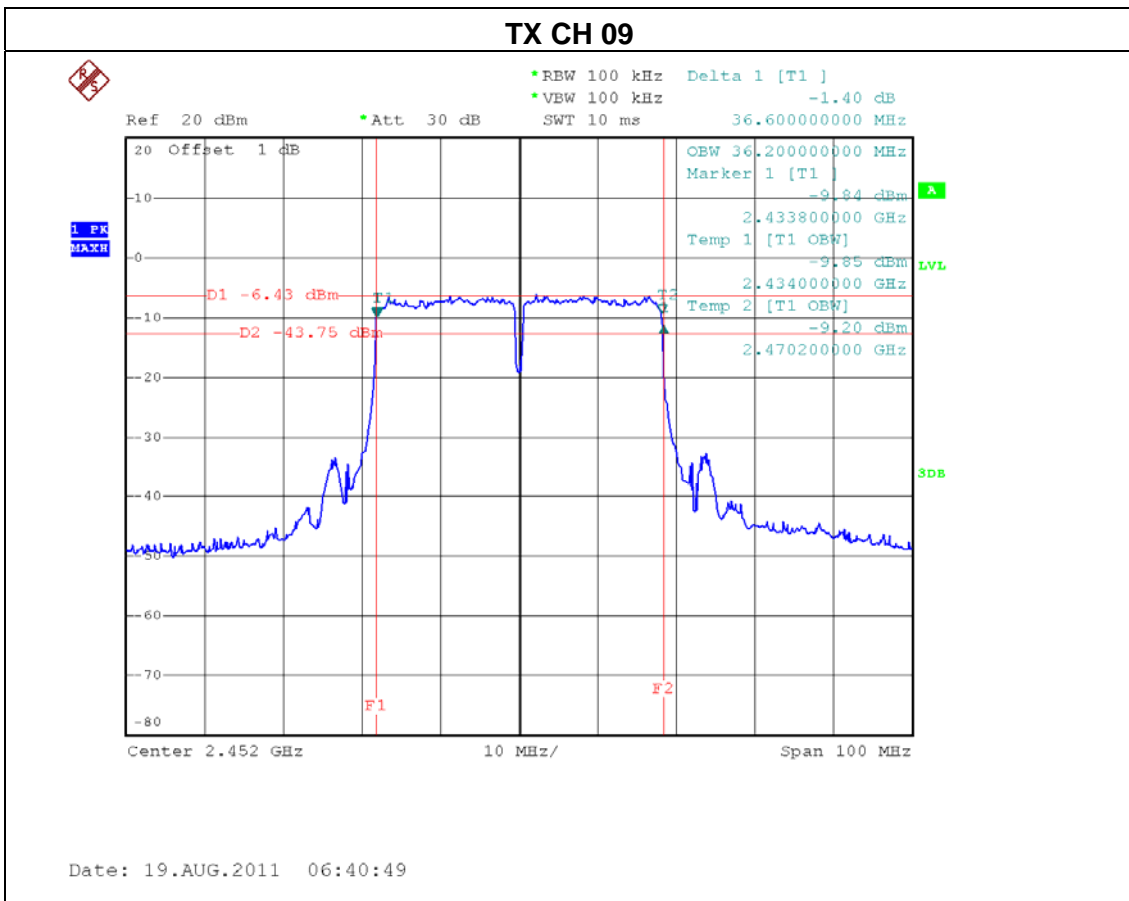
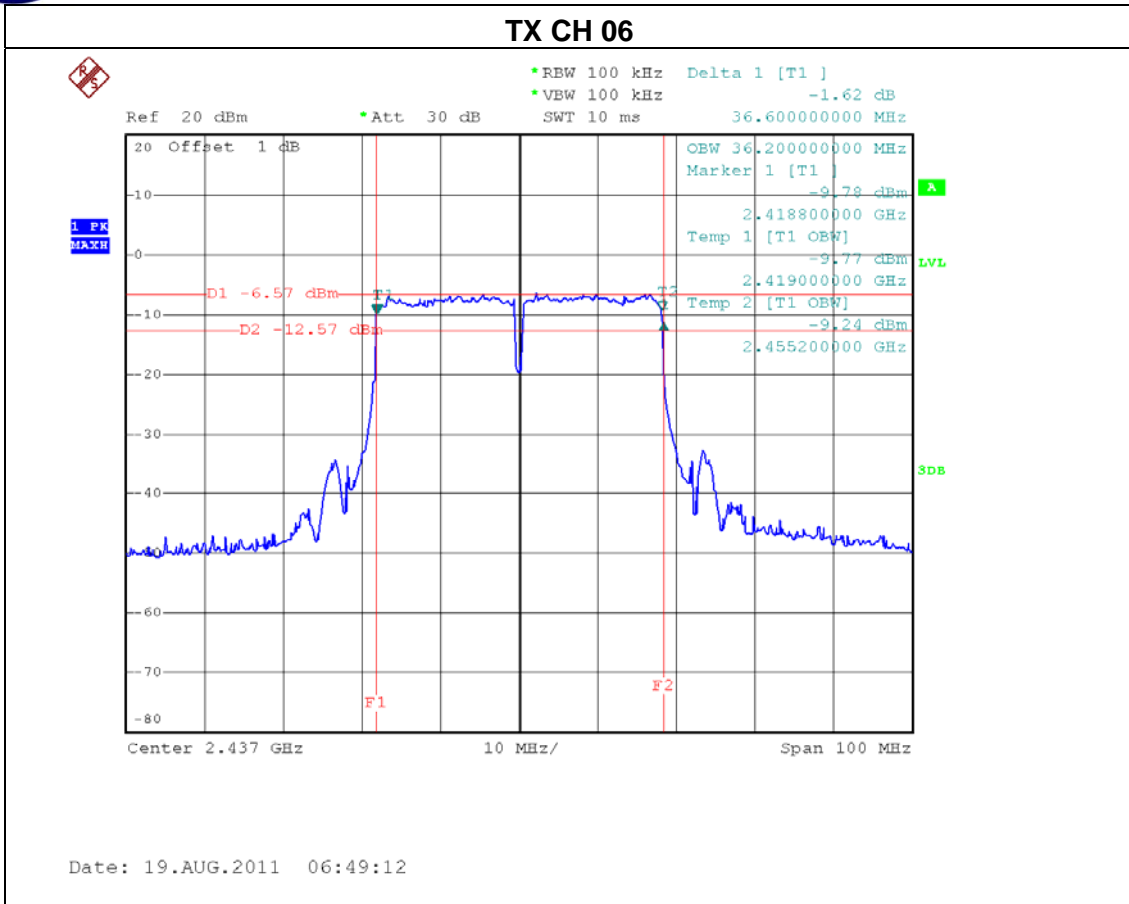



6. MAXIMUM OUTPUT POWER TEST

6.1 Applied procedures / limit

FCC Part15 (15.247) , Subpart C				
Section	Test Item	Limit	Frequency Range (MHz)	Result
15.247(b)(3)	Maximum Output Power	1 watt or 30dBm	2400-2483.5	PASS

6.1.1 MEASUREMENT INSTRUMENTS LIST

Item	Kind of Equipment	Manufacturer	Type No.	Serial No.	Calibrated until
1	Spectrum Analyzer	R&S	FSP_40	100129	Jan. 04, 2012

Remark: " N/A" denotes No Model Name. , Serial No. or No Calibration specified.

6.1.2 TEST PROCEDURE

- a. The EUT was directly connected to the spectrum analyzer and antenna output port as show in the block diagram below,
- b. Spectrum Setting : RBW= 1MHz, VBW=3MHz, Sample detector,Sweep time = Auto.

6.1.3 DEVIATION FROM STANDARD

No deviation.

6.1.4 TEST SETUP



6.1.5 EUT OPERATION CONDITIONS

The EUT tested system was configured as the statements of 4.1.6 Unless otherwise a special operating condition is specified in the follows during the testing. Transmit output power was measured while the host equipment supply voltage was varied from 85 % to 115 % of the nominal rated supply voltage. No change in transmit output power was observed.



EUT :	150Mbps Wireless-N USB Adapter	Model Name. :	WF-2103
Temperature :	24 °C	Relative Humidity :	60 %
Pressure :	1016 hPa	Test Voltage :	AC 120V/60Hz
Test Mode :	TX G MODE /CH01, CH06, CH11		

Maximum Output Power

Test Channel	Frequency (MHz)	Output Power (dBm)	LIMIT (dBm)	LIMIT (W)
CH01	2412 MHz	13.37	30	1
CH06	2437 MHz	13.14	30	1
CH11	2462 MHz	13.03	30	1

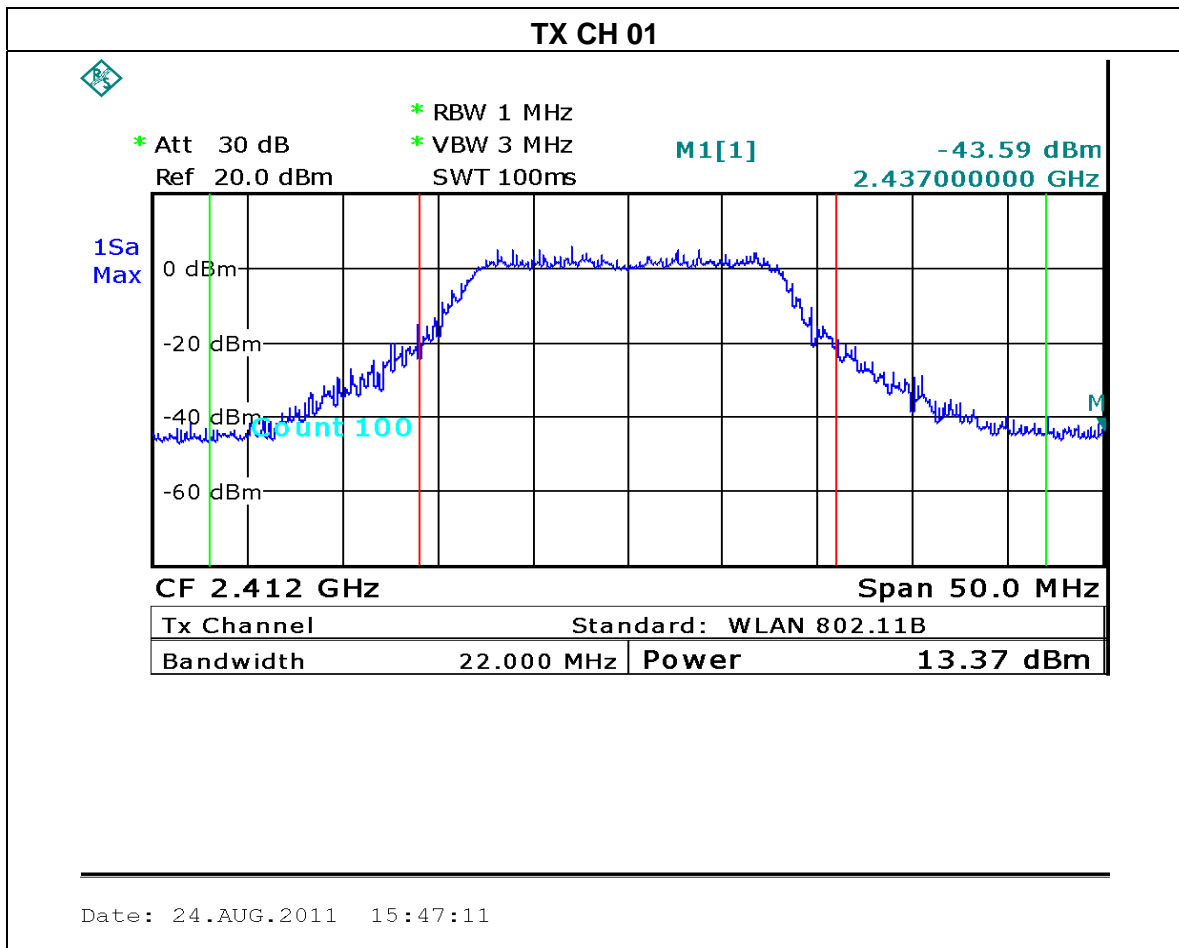



EUT :	150Mbps Wireless-N USB Adapter	Model Name. :	WF-2103
Temperature :	24 °C	Relative Humidity :	60 %
Pressure :	1016 hPa	Test Voltage :	AC 120V/60Hz
Test Mode :	TX N-40M MODE /CH03, CH06, CH09		

Maximum Output Power

Test Channel	Frequency (MHz)	Output Power (dBm)	LIMIT (dBm)	LIMIT (W)
CH03	2422 MHz	13.29	30	1
CH06	2437 MHz	13.26	30	1
CH09	2452 MHz	13.12	30	1

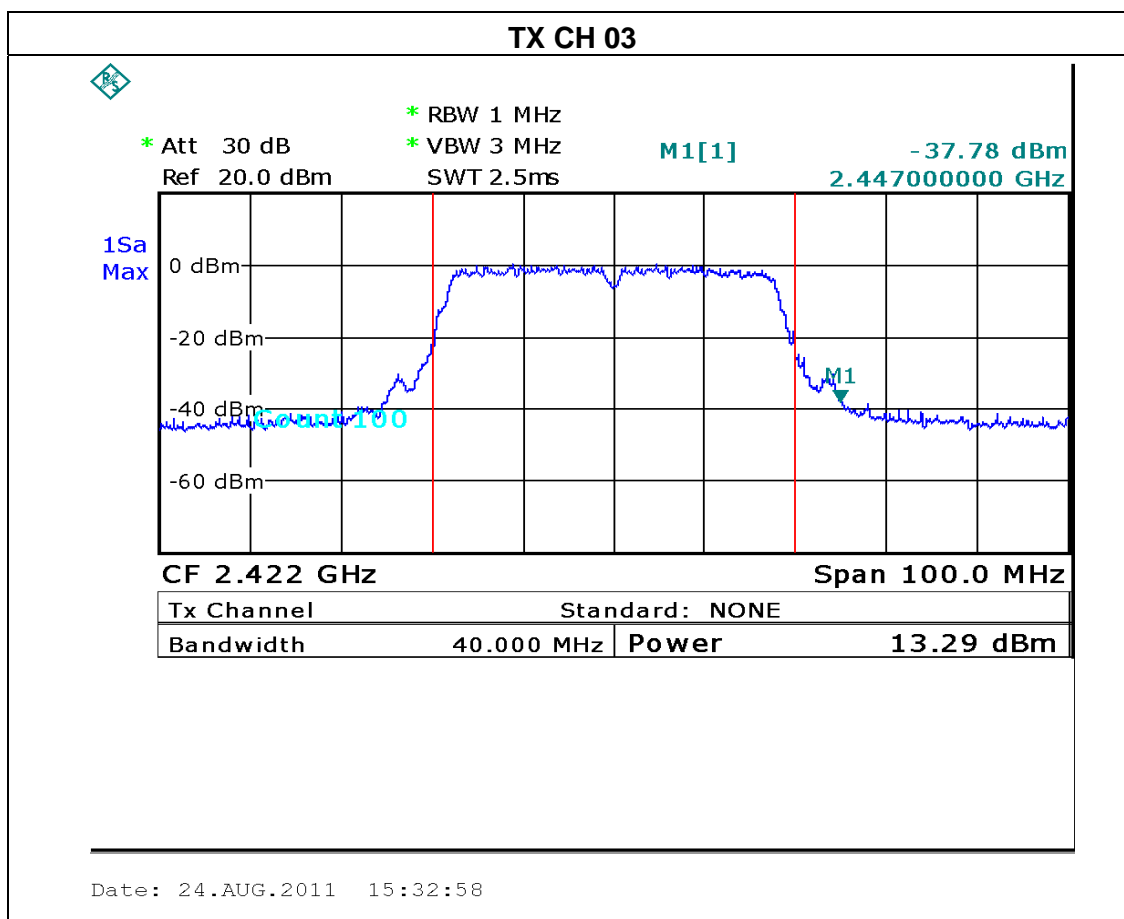



7. ANTENNA CONDUCTED SPURIOUS EMISSION

7.1 Applied procedures / limit

30dBc in any 100 kHz bandwidth outside the operating frequency band. In case the emission fall within the restricted band specified on 15.205(a), then the 15.209(a) limit in the table below has to be followed.

Frequencies (MHz)	Field Strength (micorvolts/meter)	Measurement Distance (meters)
0.009~0.490	2400/F(KHz)	300
0.490~1.705	24000/F(KHz)	30
1.705~30.0	30	30
30~88	100	3
88~216	150	3
216~960	200	3
Above 960	500	3

7.1.1 MEASUREMENT INSTRUMENTS LIST

Item	Kind of Equipment	Manufacturer	Type No.	Serial No.	Calibrated until
1	Spectrum Analyzer	R&S	FSP_40	100129	Jan. 04, 2012

Remark: " N/A" denotes No Model Name. , Serial No. or No Calibration specified.

7.1.2 TEST PROCEDURE

- a. The EUT was directly connected to the spectrum analyzer and antenna output port as show in the block diagram below,
- b. Spectrum Setting : RBW= 100KHz, VBW=100KHz, Sweep time = 10 ms.

7.1.3 DEVIATION FROM STANDARD

No deviation.

7.1.4 TEST SETUP

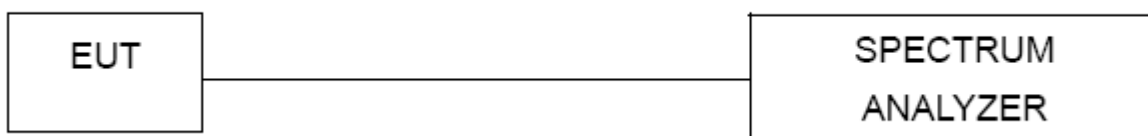

7.1.5 EUT OPERATION CONDITIONS

The EUT tested system was configured as the statements of 4.1.6 Unless otherwise a special operating condition is specified in the follows during the testing.



7.1.6 TEST RESULTS

EUT :	150Mbps Wireless-N USB Adapter	Model Name :	WF-2103
Temperature :	24 °C	Relative Humidity :	60 %
Pressure :	1016 hPa	Test Voltage :	AC 120V/60Hz
Test Mode :	TX B MODE /CH01, CH06 , CH11		

Channel of Worst Data: CH01			
The max. radio frequency power in any 100kHz bandwidth outside the frequency band		The max. radio frequency power in any 100 kHz bandwidth within the frequency band.	
FREQUENCY(MHz)	POWER(dBm)	FREQUENCY(MHz)	POWER(dBm)
2381.80	-48.40	2490.60	-49.64
Result			
In any 100kHz bandwidth outside the frequency band, the radio frequency power is at least 30dB below that in the 100kHz bandwidth within the band that contains the highest level of the desired power.			

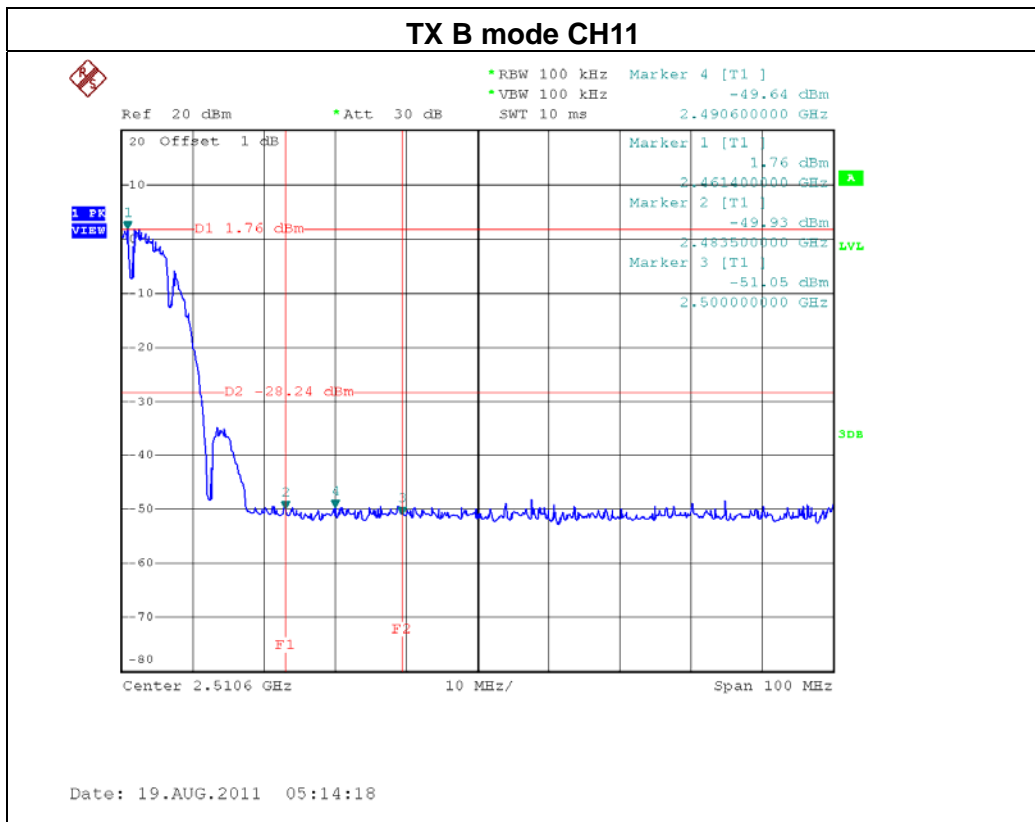
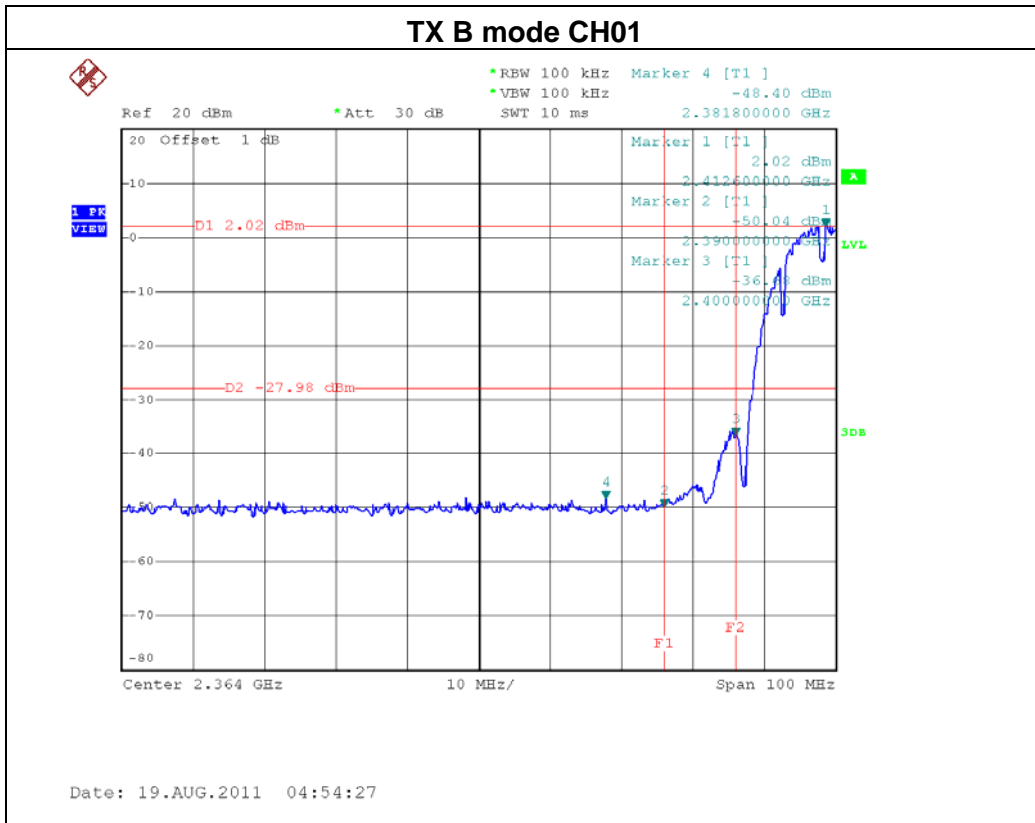

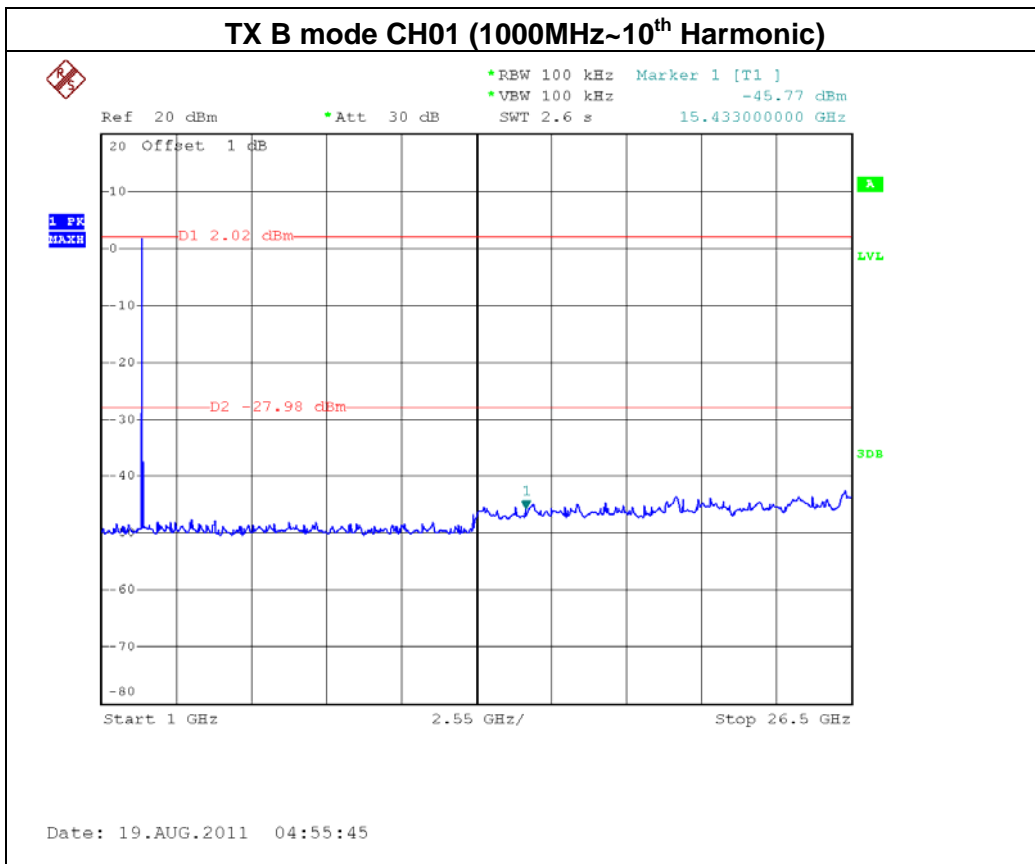
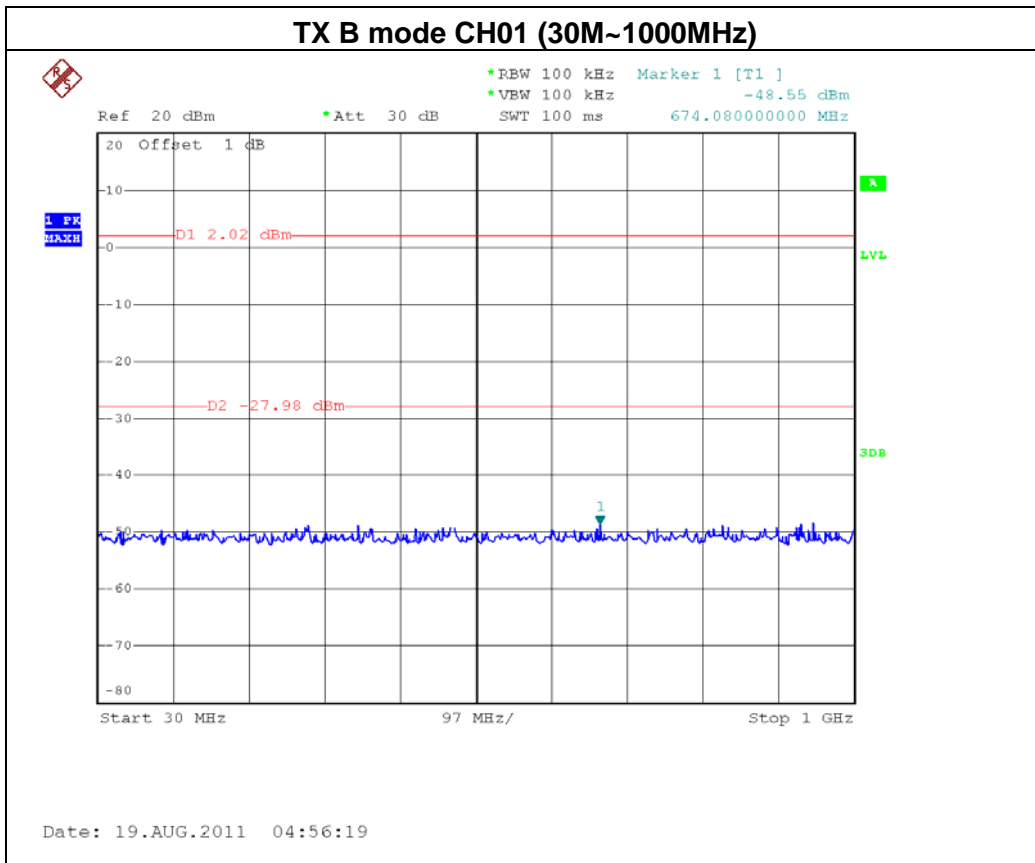

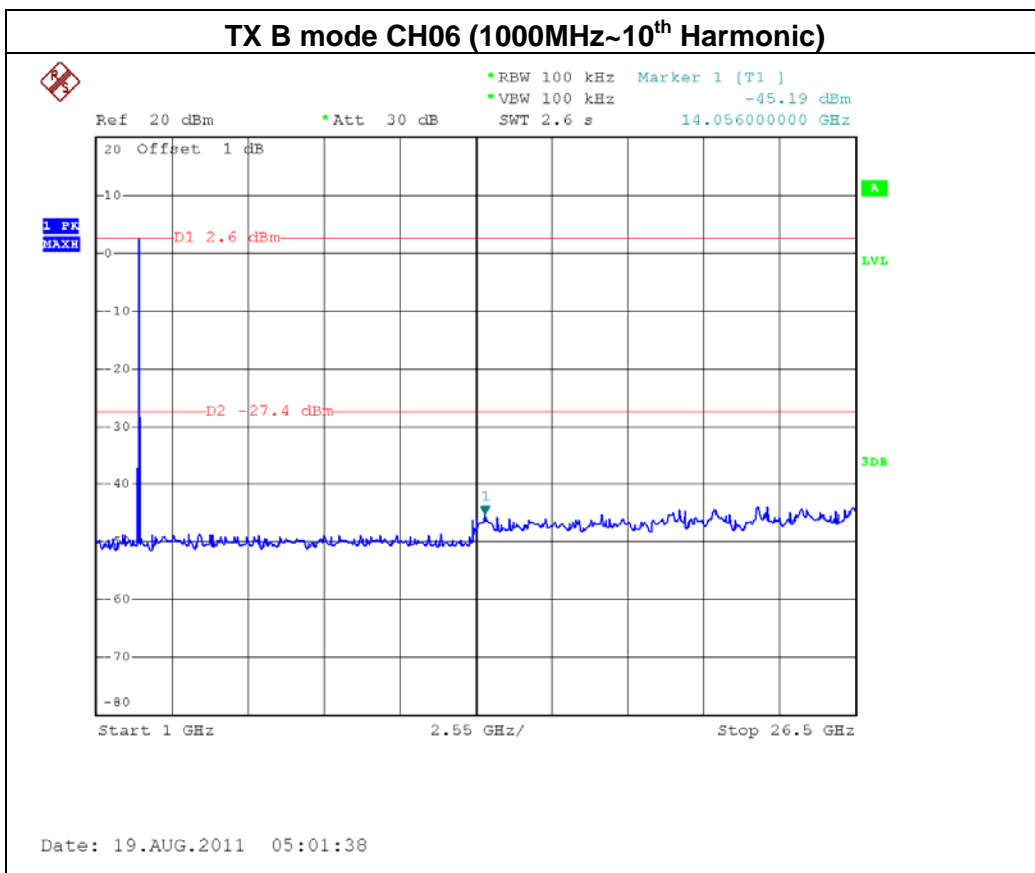
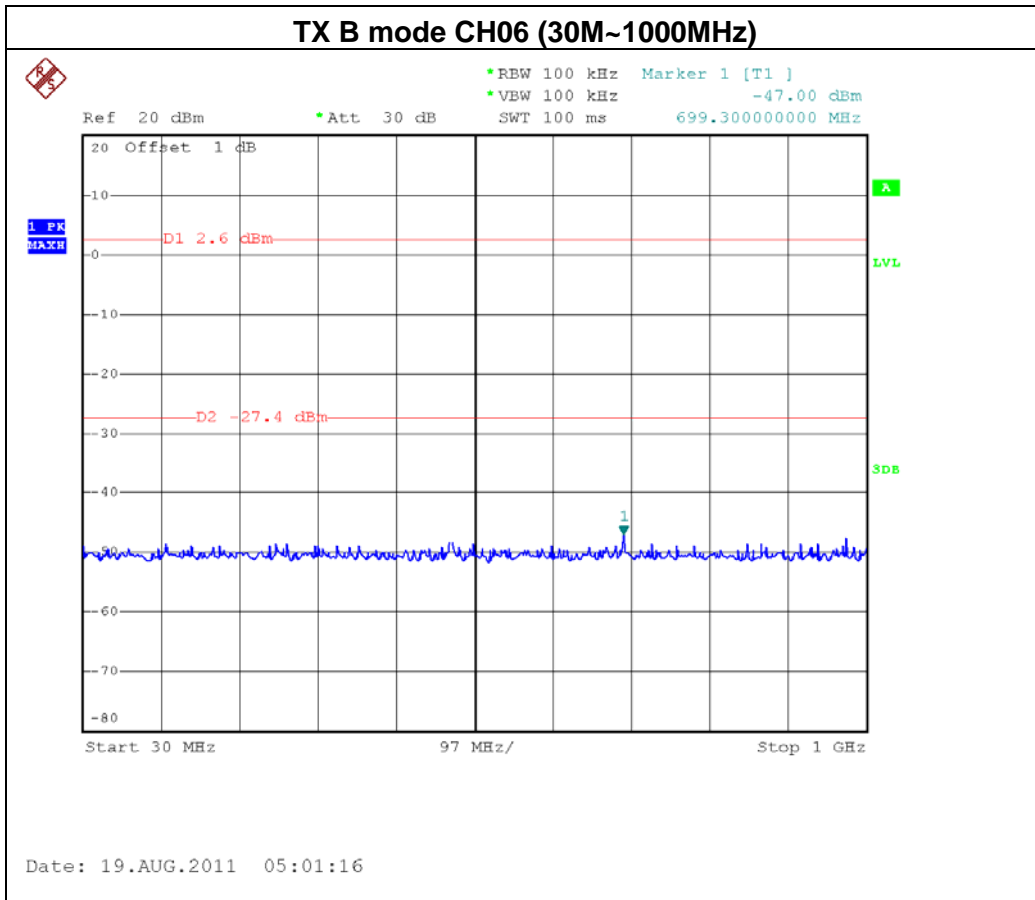

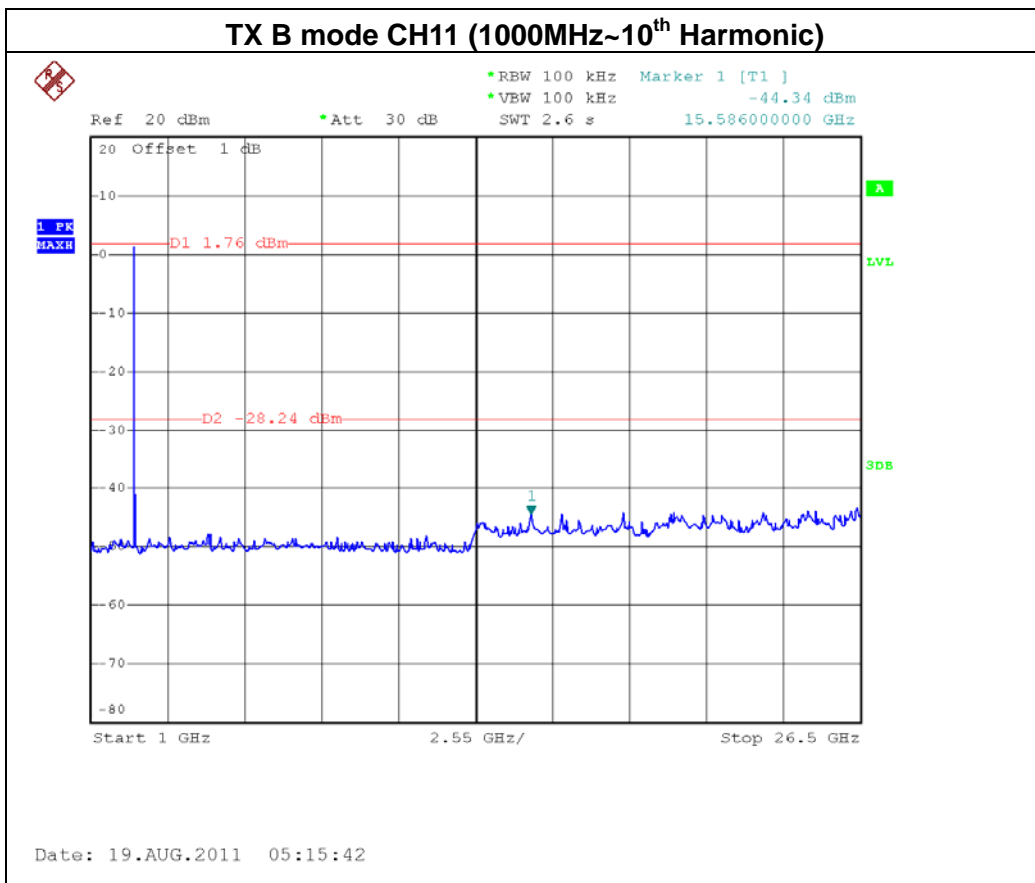
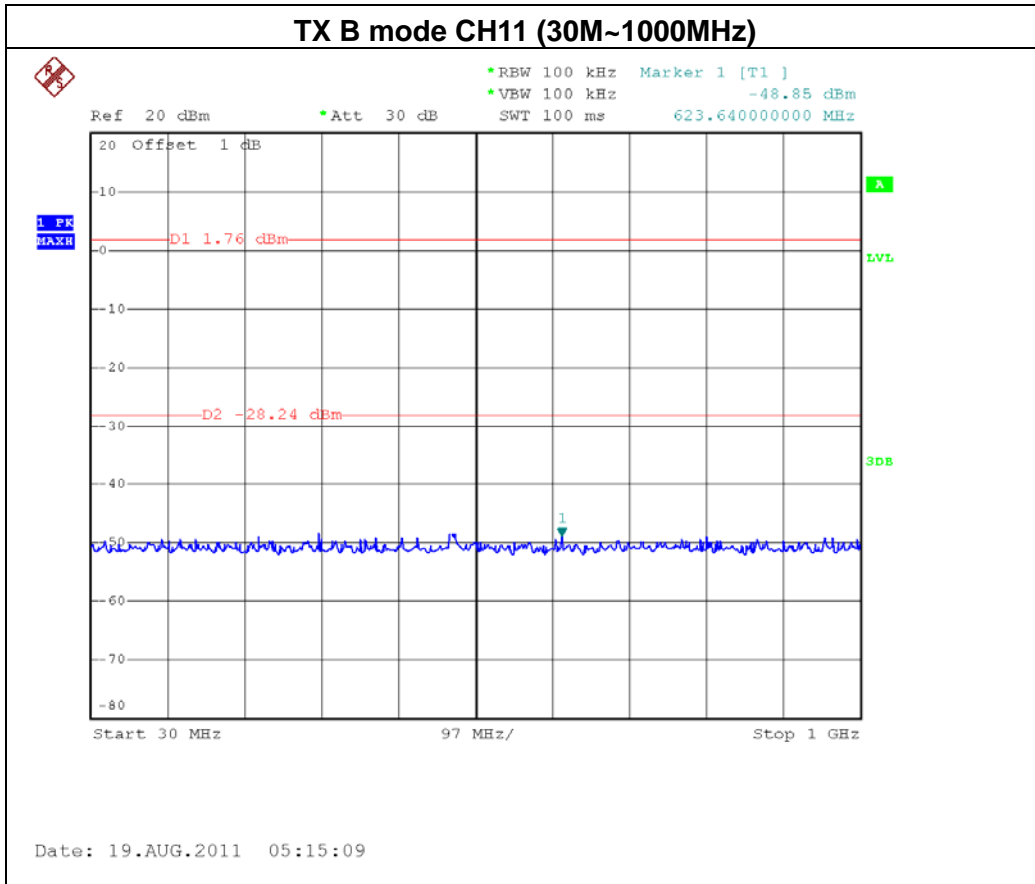



EUT :	150Mbps Wireless-N USB Adapter	Model Name :	WF-2103
Temperature :	24 °C	Relative Humidity :	60 %
Pressure :	1016 hPa	Test Voltage :	AC 120V/60Hz
Test Mode :	TX G MODE / CH01, CH06 , CH11		

Channel of Worst Data: CH01			
The max. radio frequency power in any 100kHz bandwidth outside the frequency band		The max. radio frequency power in any 100 kHz bandwidth within the frequency band.	
FREQUENCY(MHz)	POWER(dBm)	FREQUENCY(MHz)	POWER(dBm)
2367.20	-47.12	2487.02	-46.73

Result

In any 100kHz bandwidth outside the frequency band, the radio frequency power is at least 30dB below that in the 100kHz bandwidth within the band that contains the highest level of the desired power.

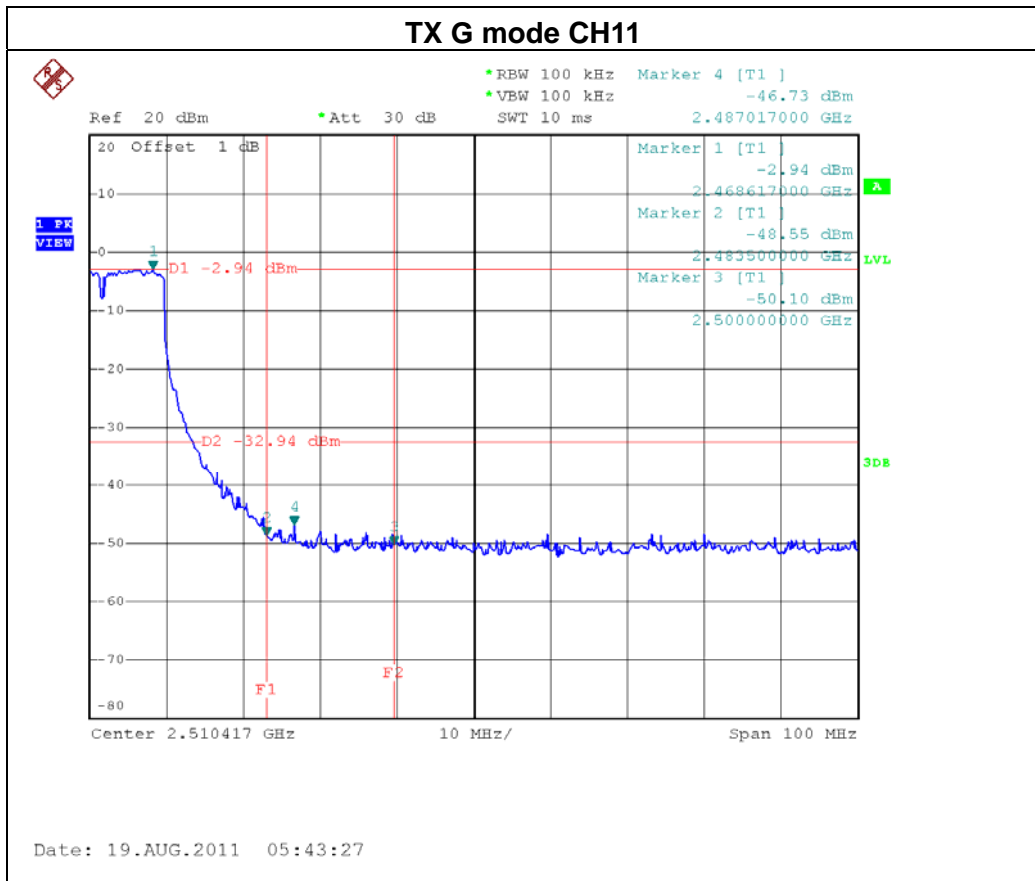
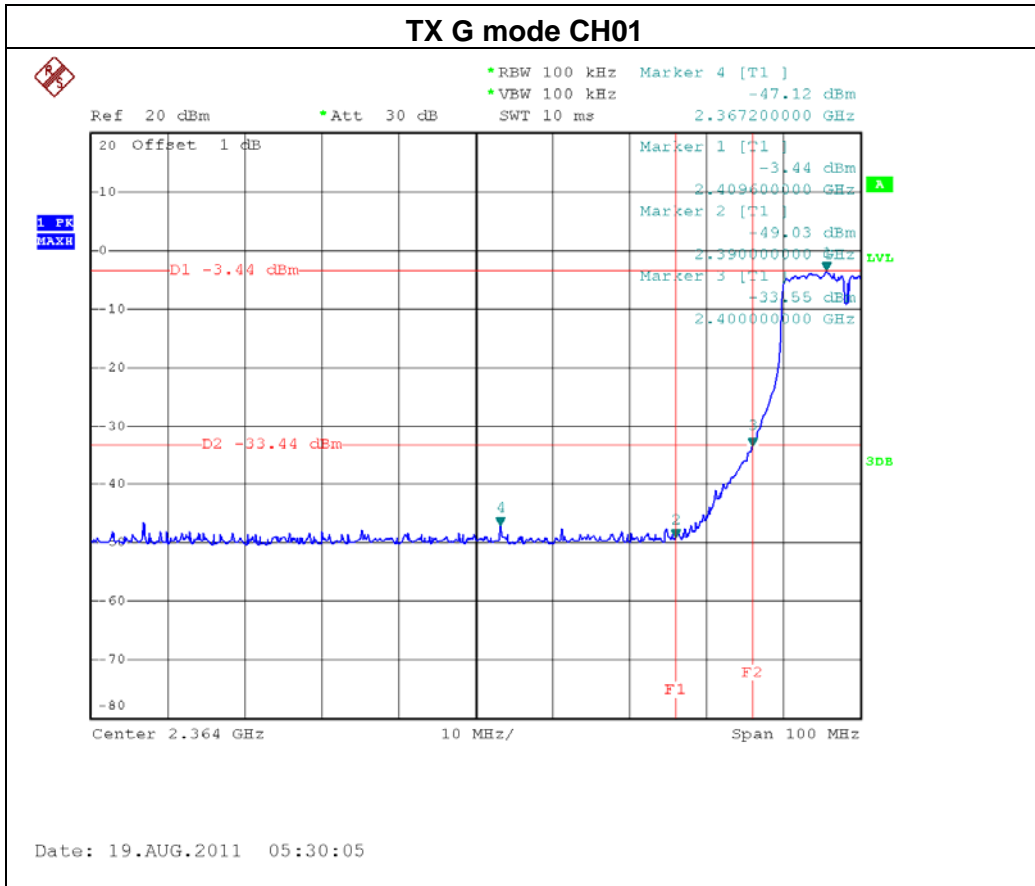

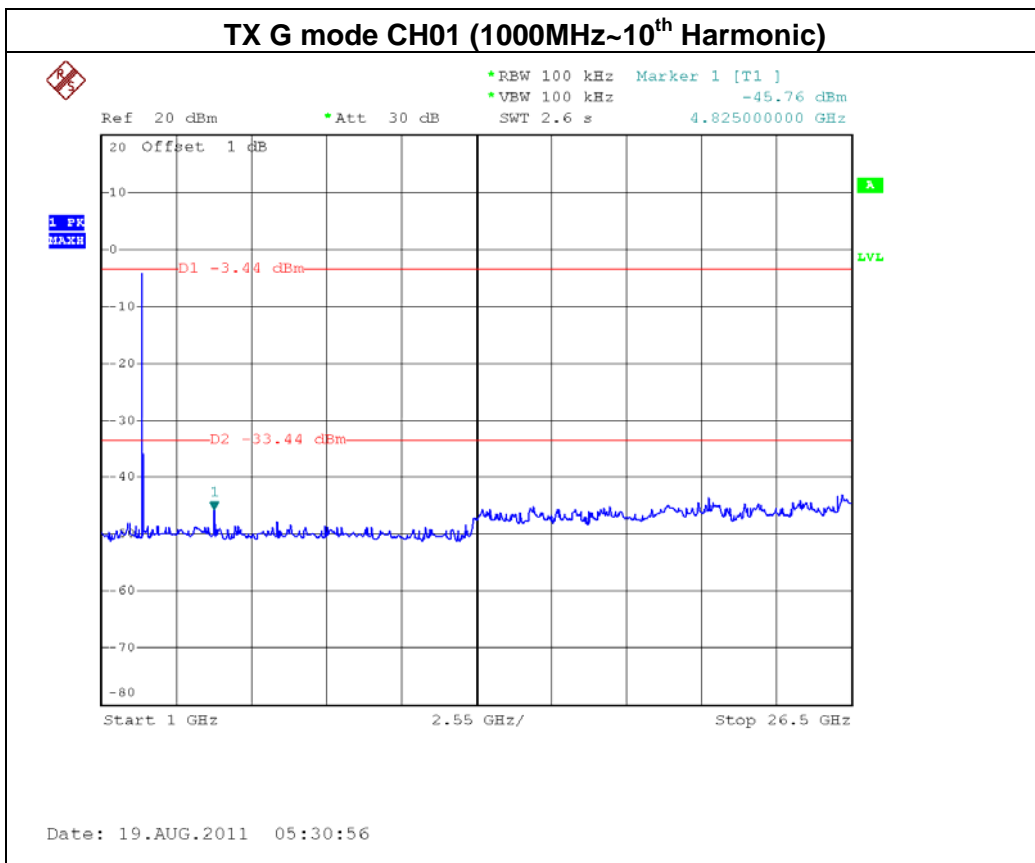
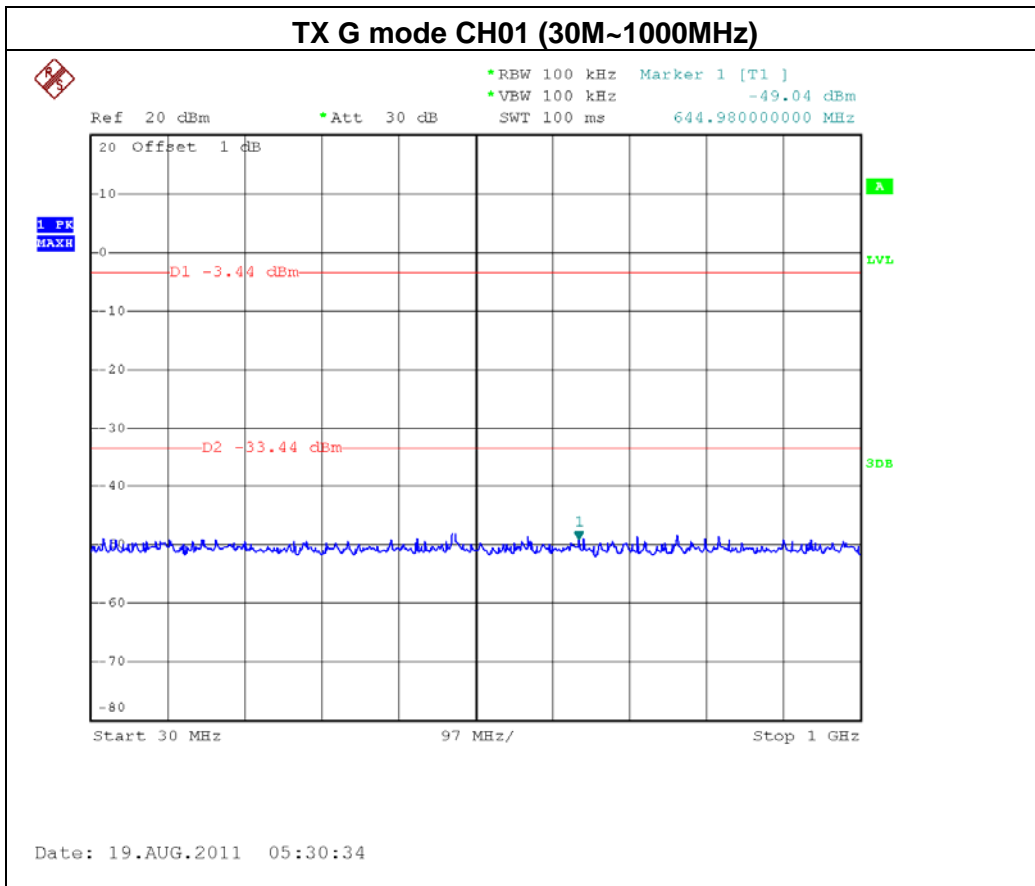

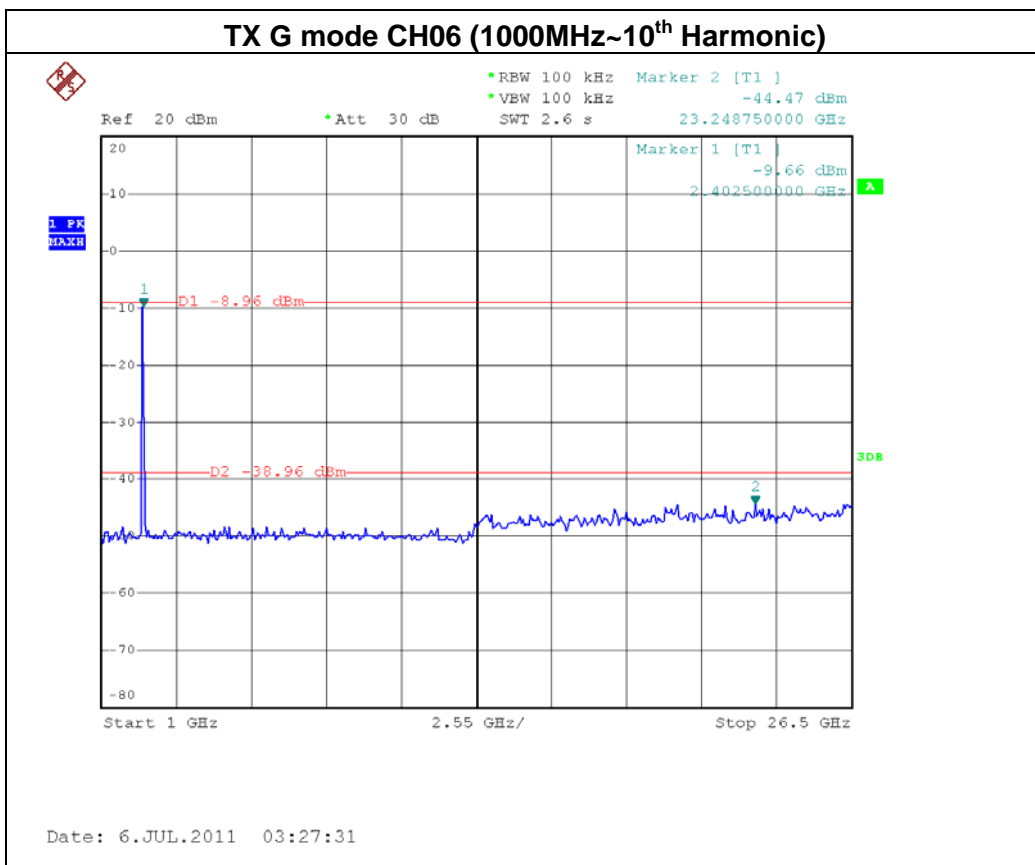
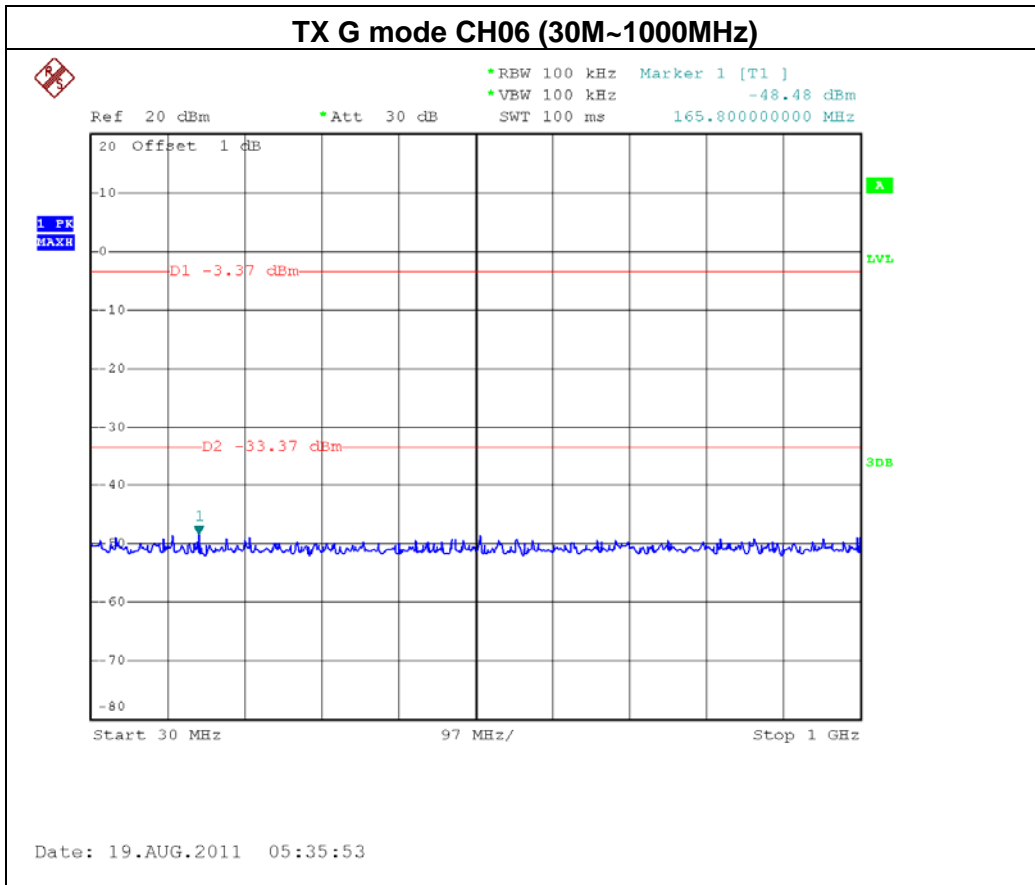

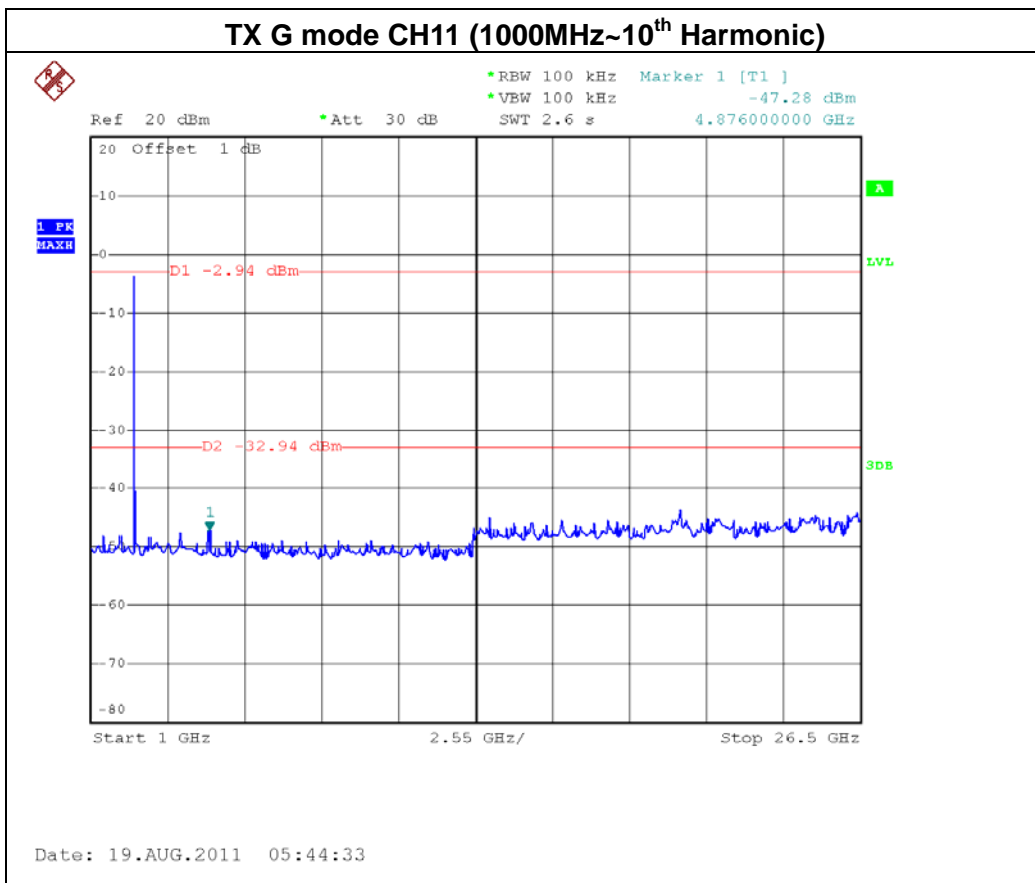
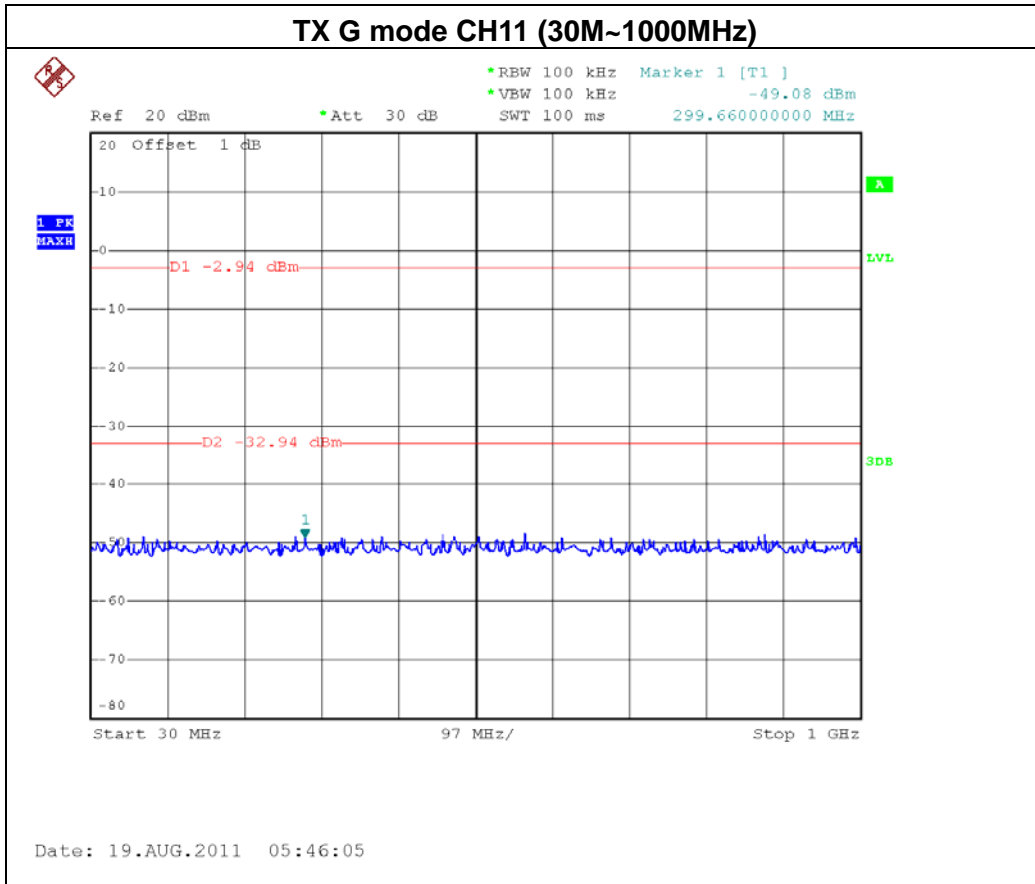



EUT :	150Mbps Wireless-N USB Adapter	Model Name :	WF-2103
Temperature :	24 °C	Relative Humidity :	60 %
Pressure :	1016 hPa	Test Voltage :	AC 120V/60Hz
Test Mode :	TX N-20M MODE / CH01, CH06 , CH11		

Channel of Worst Data: CH01			
The max. radio frequency power in any 100kHz bandwidth outside the frequency band		The max. radio frequency power in any 100 kHz bandwidth within the frequency band.	
FREQUENCY(MHz)	POWER(dBm)	FREQUENCY(MHz)	POWER(dBm)
2377.00	-48.98	2485.40	-45.93
Result			
In any 100kHz bandwidth outside the frequency band, the radio frequency power is at least 30dB below that in the 100kHz bandwidth within the band that contains the highest level of the desired power.			

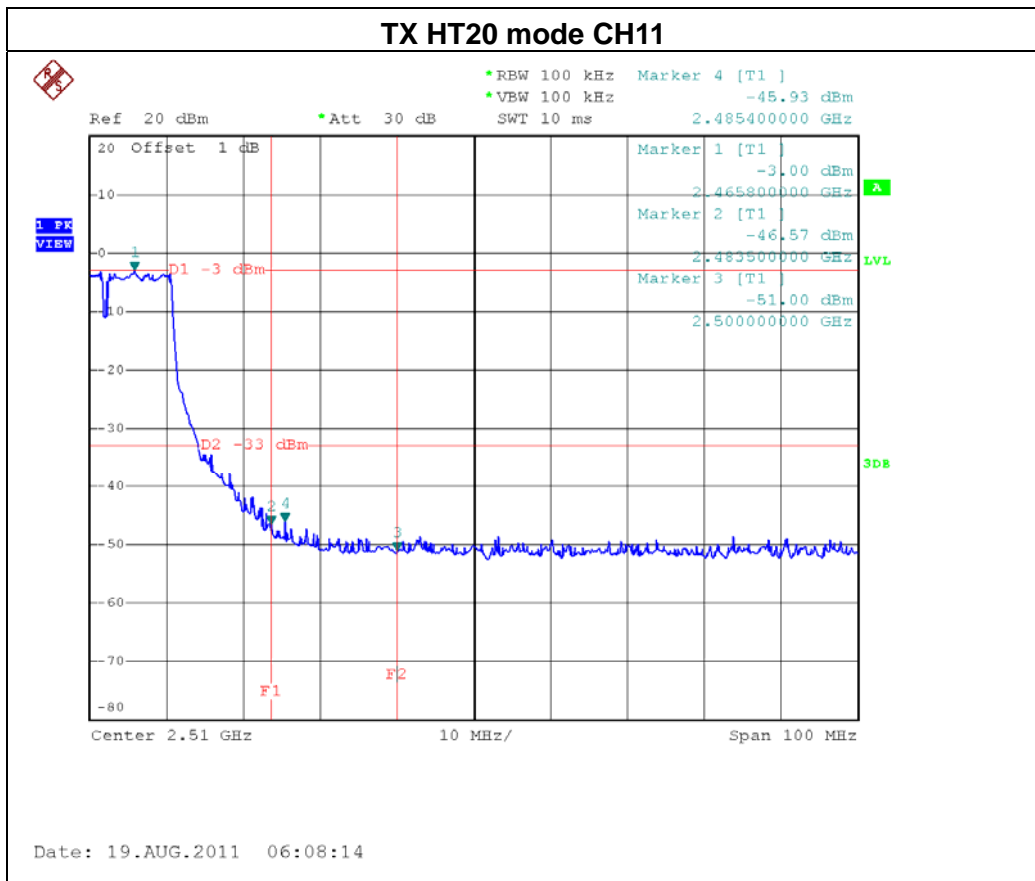
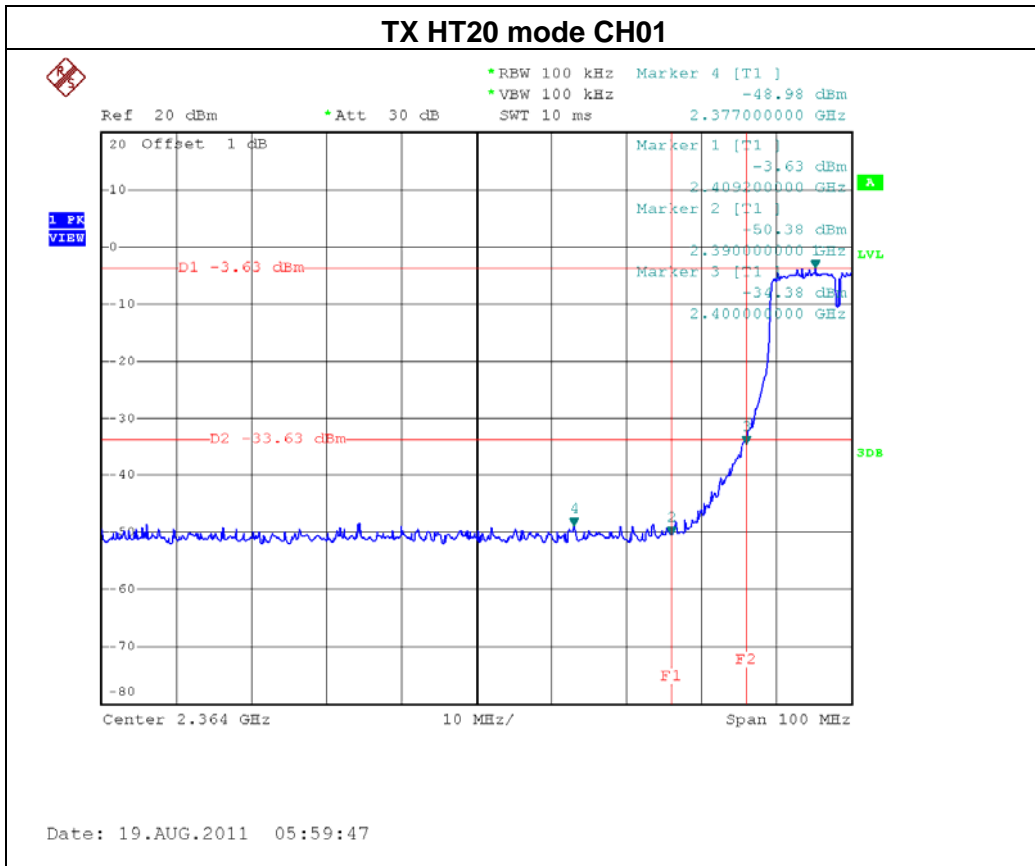

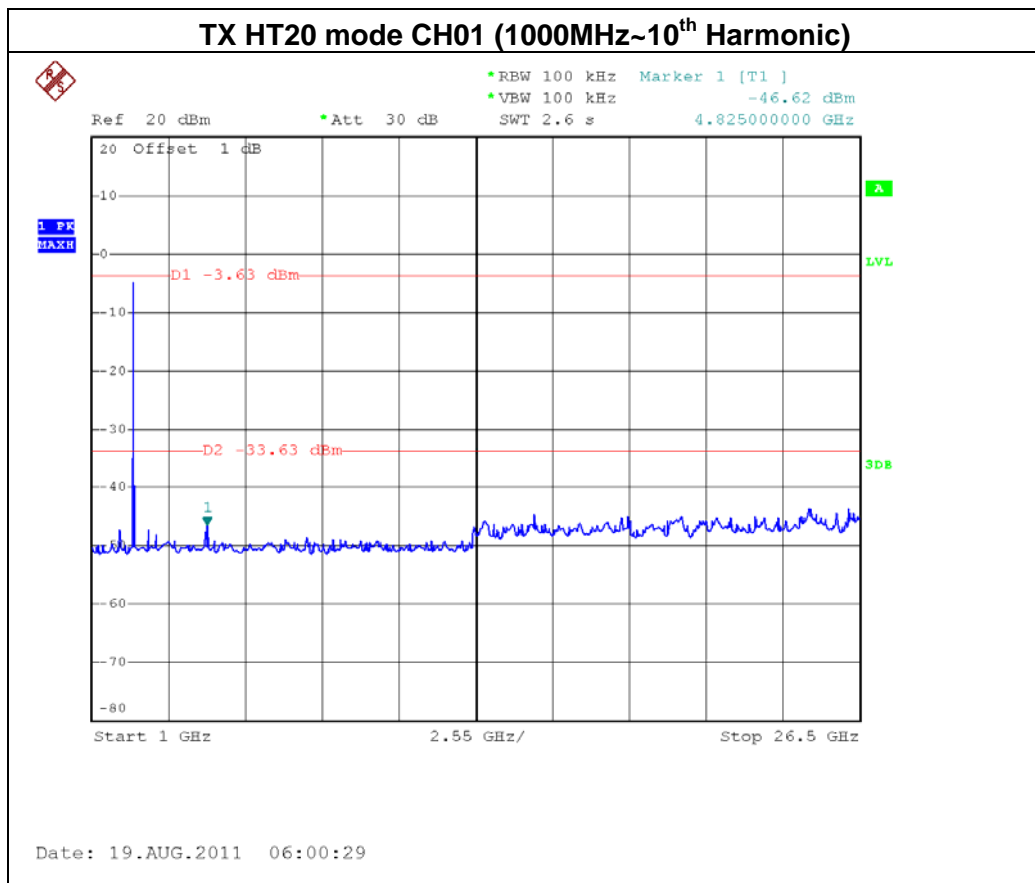
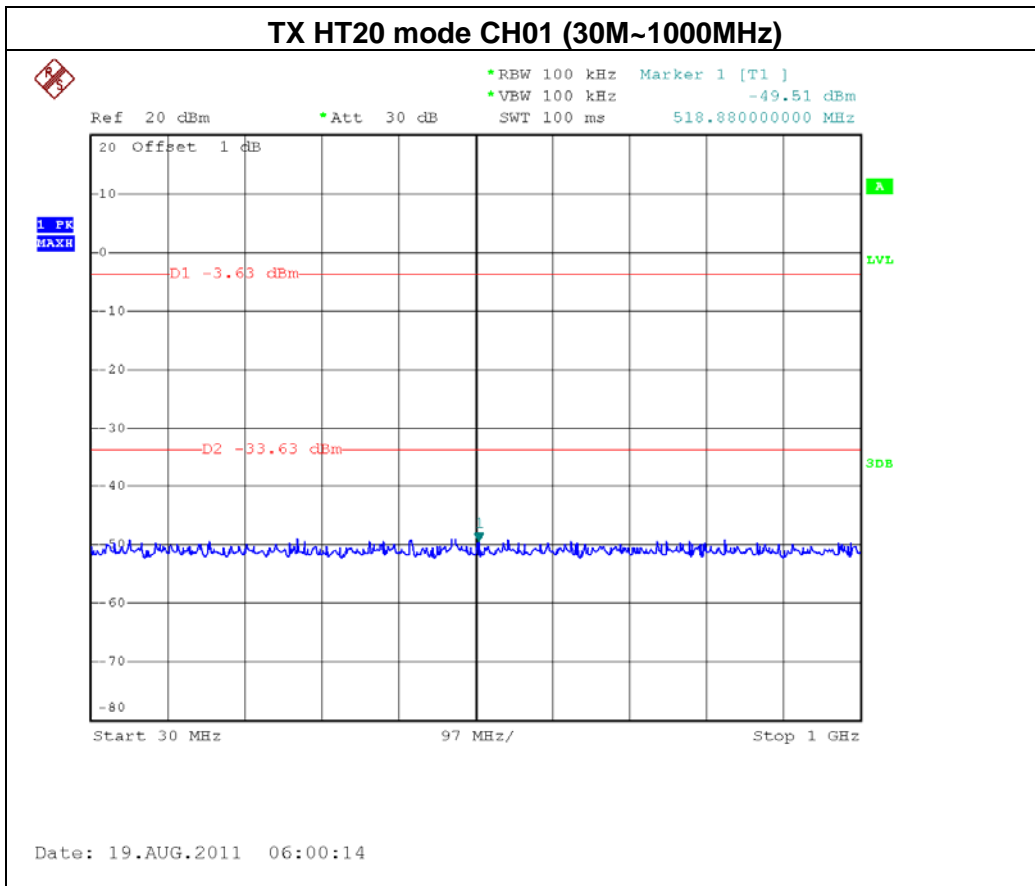

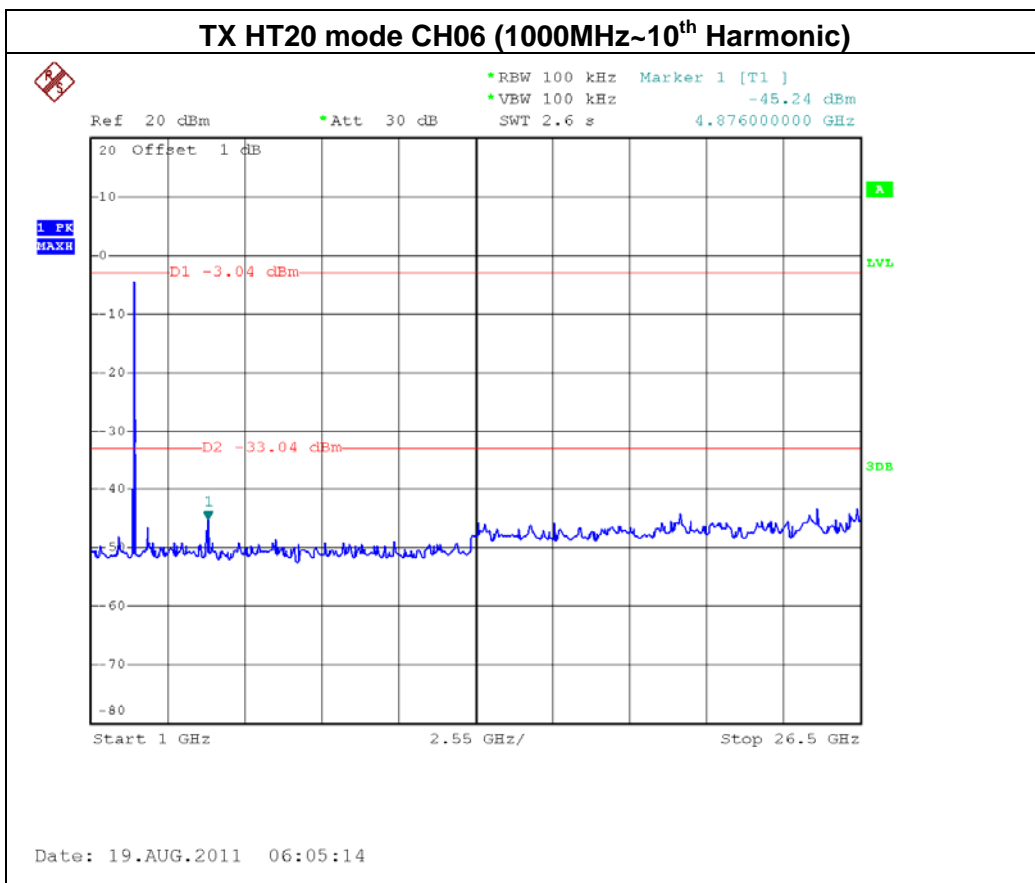
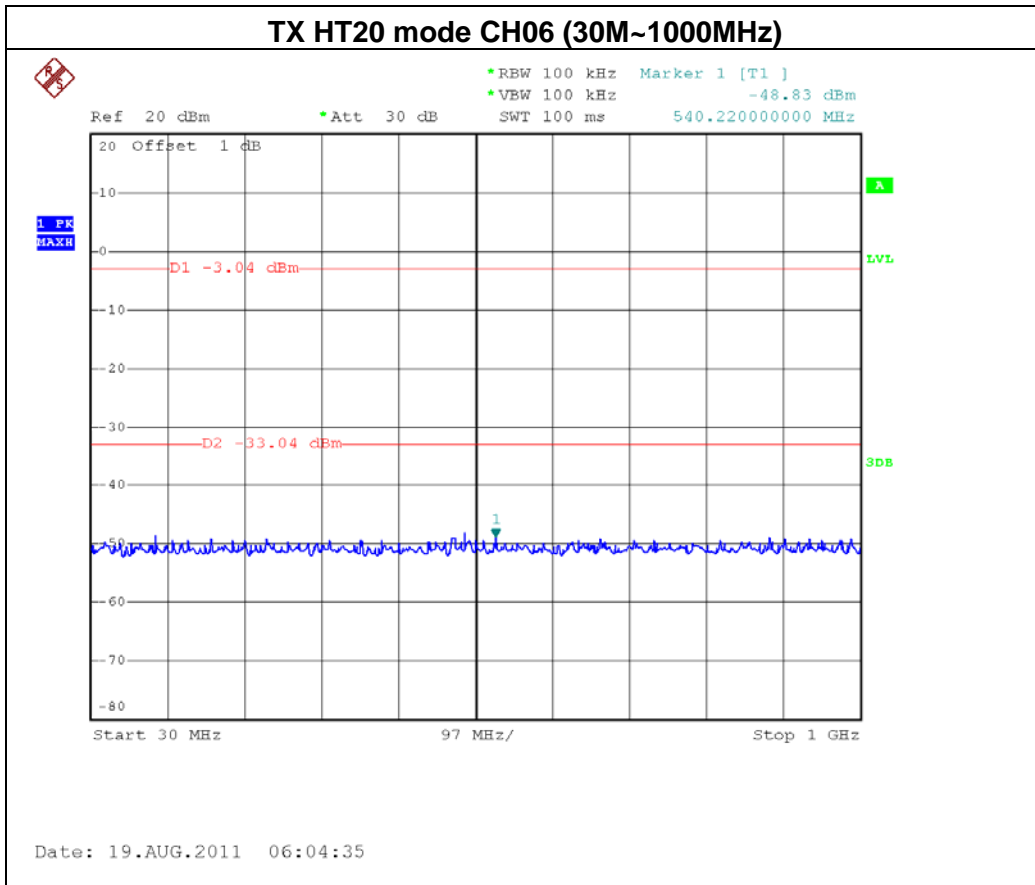

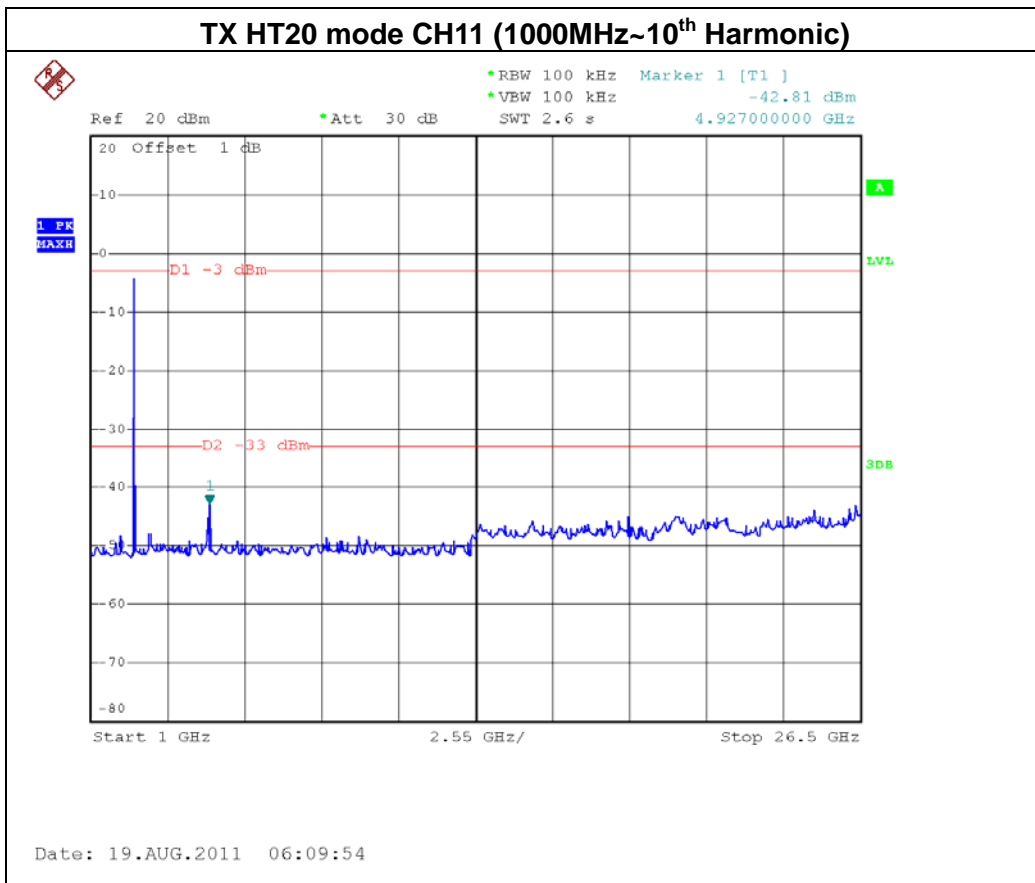
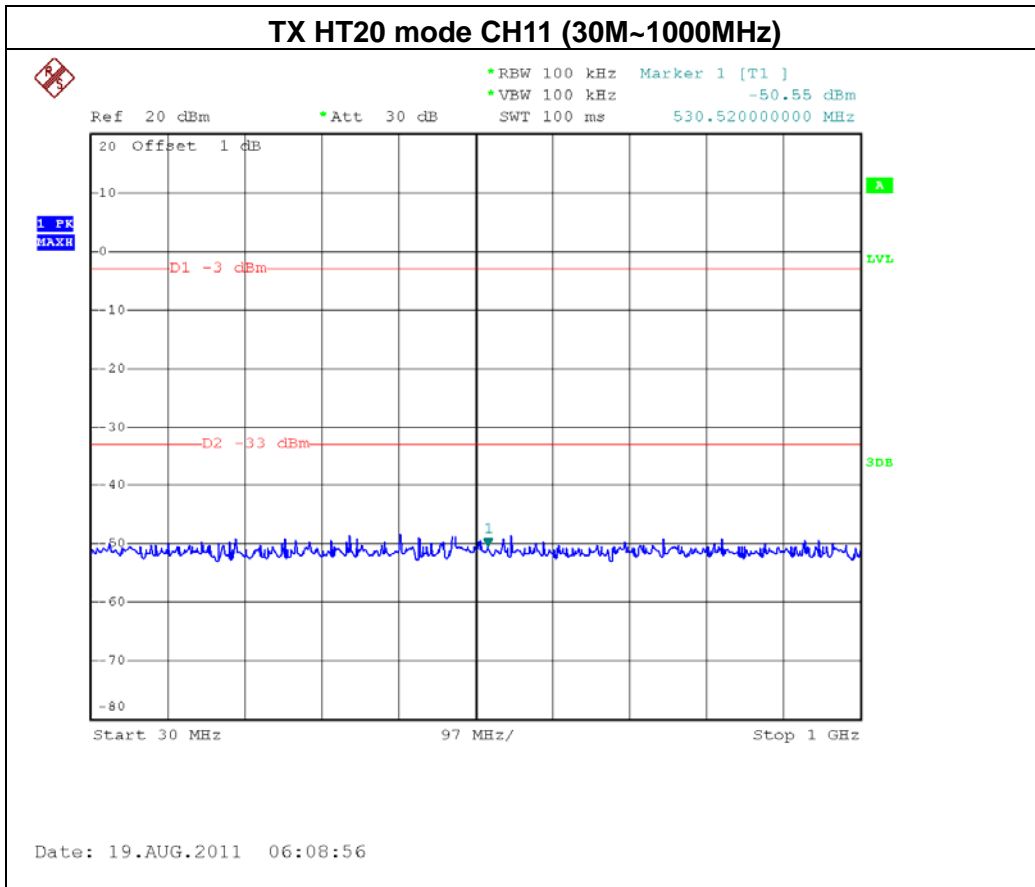



EUT :	150Mbps Wireless-N USB Adapter	Model Name :	WF-2103
Temperature :	24 °C	Relative Humidity :	60 %
Pressure :	1016 hPa	Test Voltage :	AC 120V/60Hz
Test Mode :	TX N-40M MODE /CH03, CH06, CH09		

Channel of Worst Data: CH03

The max. radio frequency power in any 100kHz bandwidth outside the frequency band	The max. radio frequency power in any 100 kHz bandwidth within the frequency band.
---	--

FREQUENCY(MHz)	POWER(dBm)	FREQUENCY(MHz)	POWER(dBm)
2345.00	-48.40	2490.00	-44.92

Result

In any 100kHz bandwidth outside the frequency band, the radio frequency power is at least 30dB below that in the 100kHz bandwidth within the band that contains the highest level of the desired power.

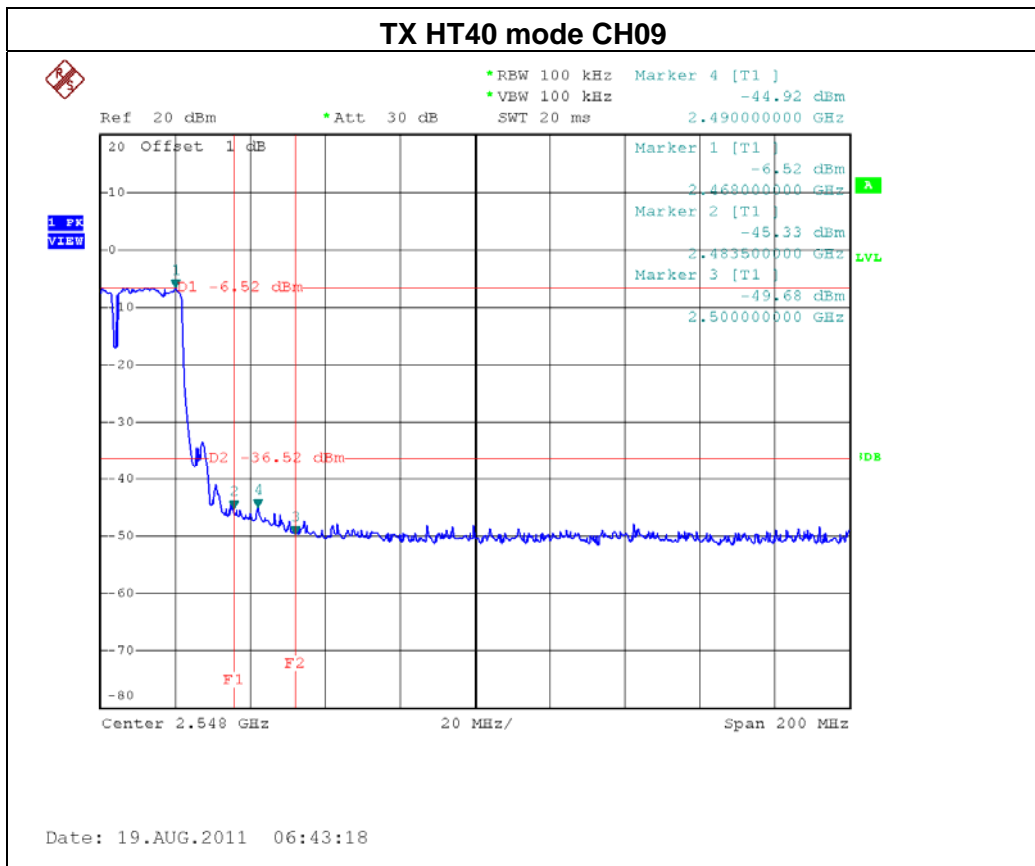
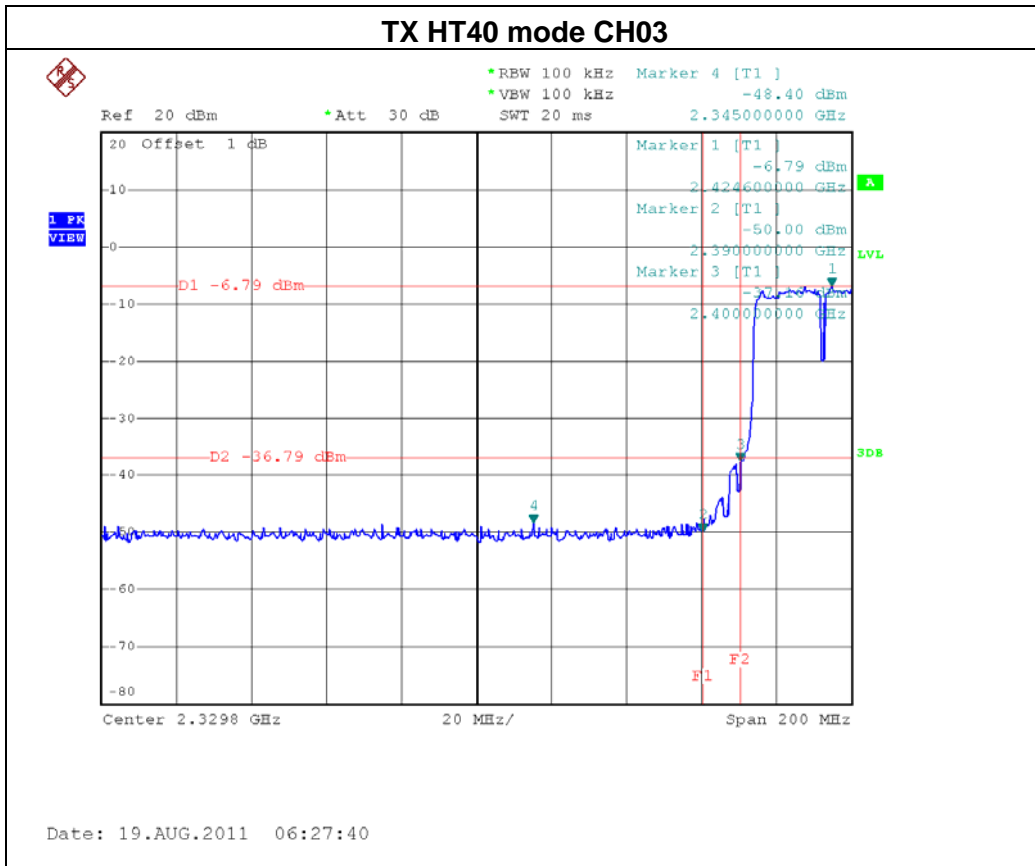

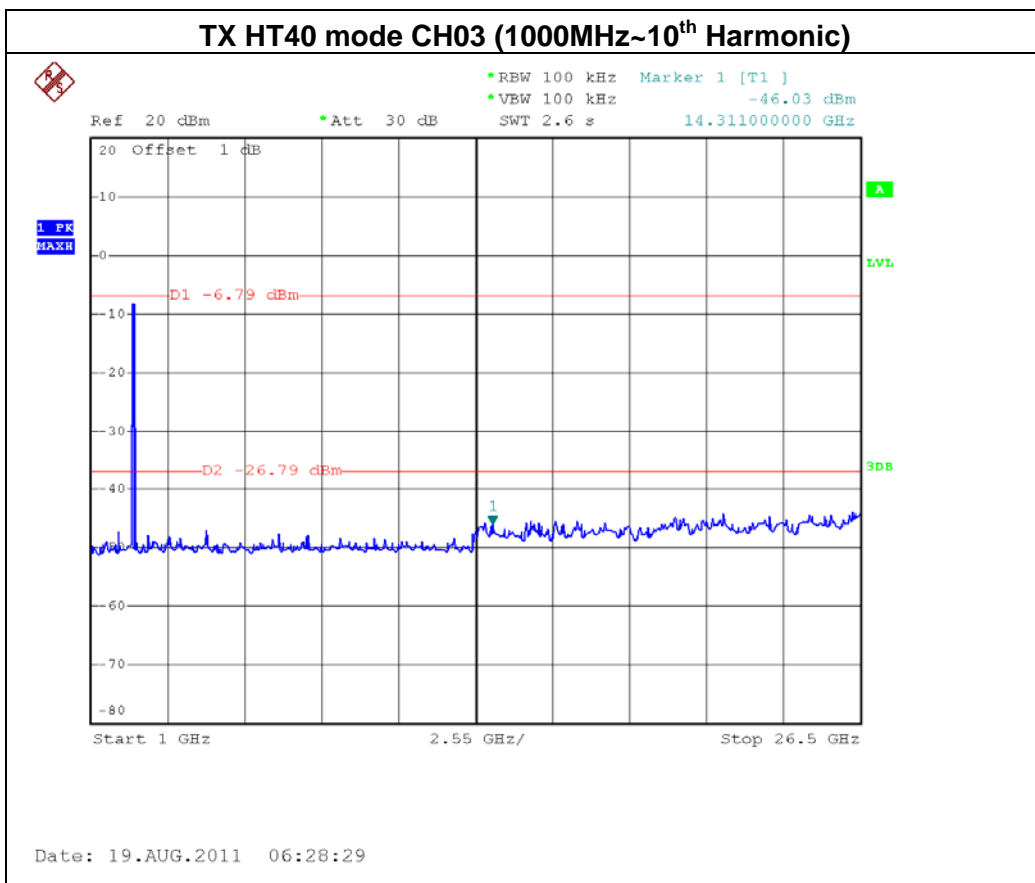
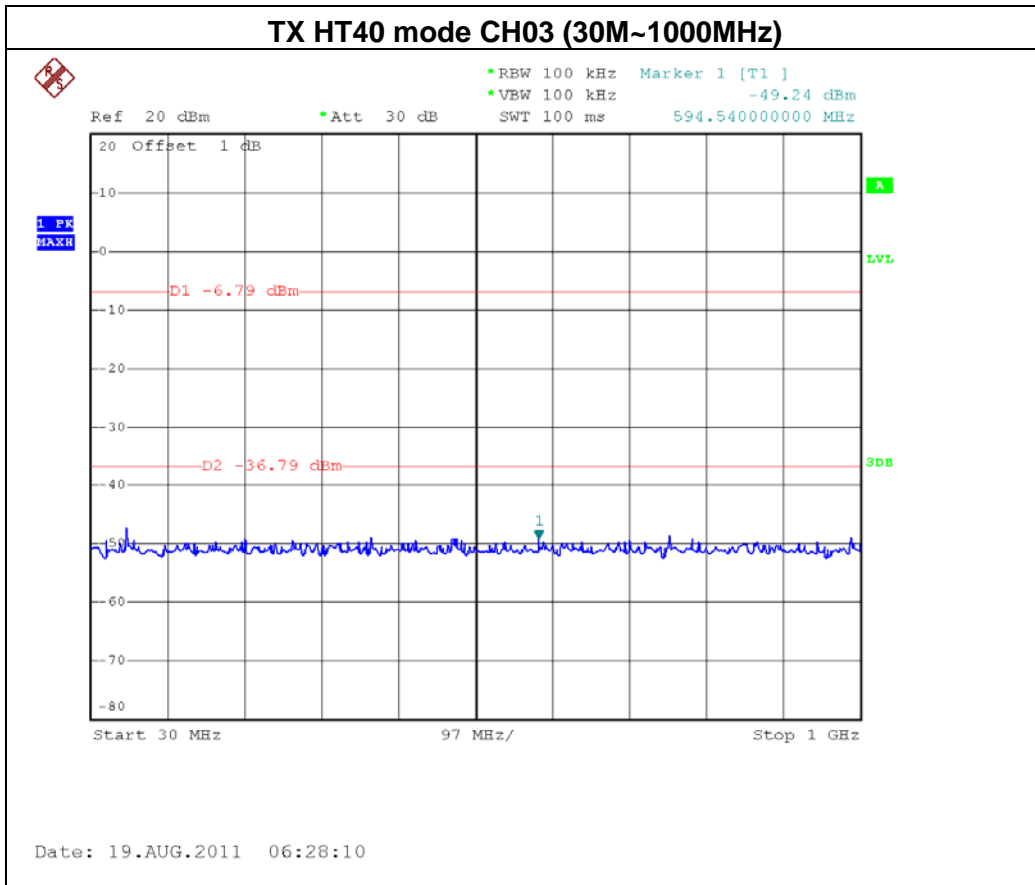

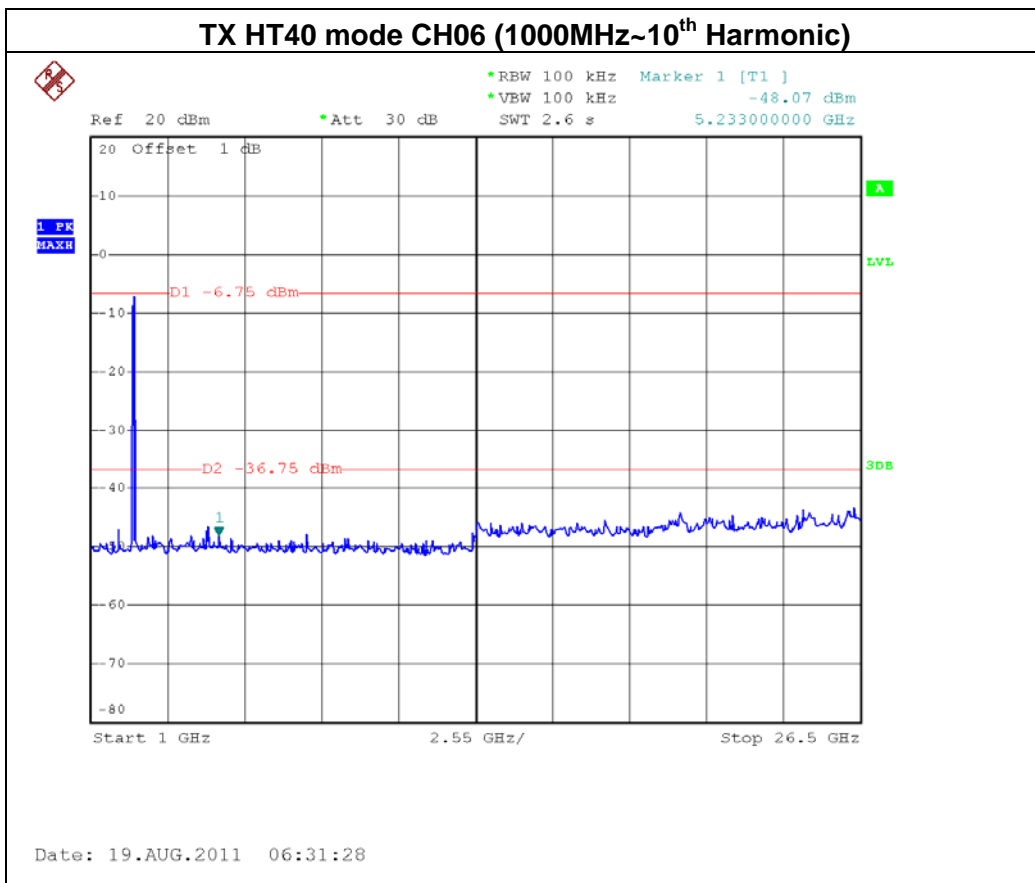
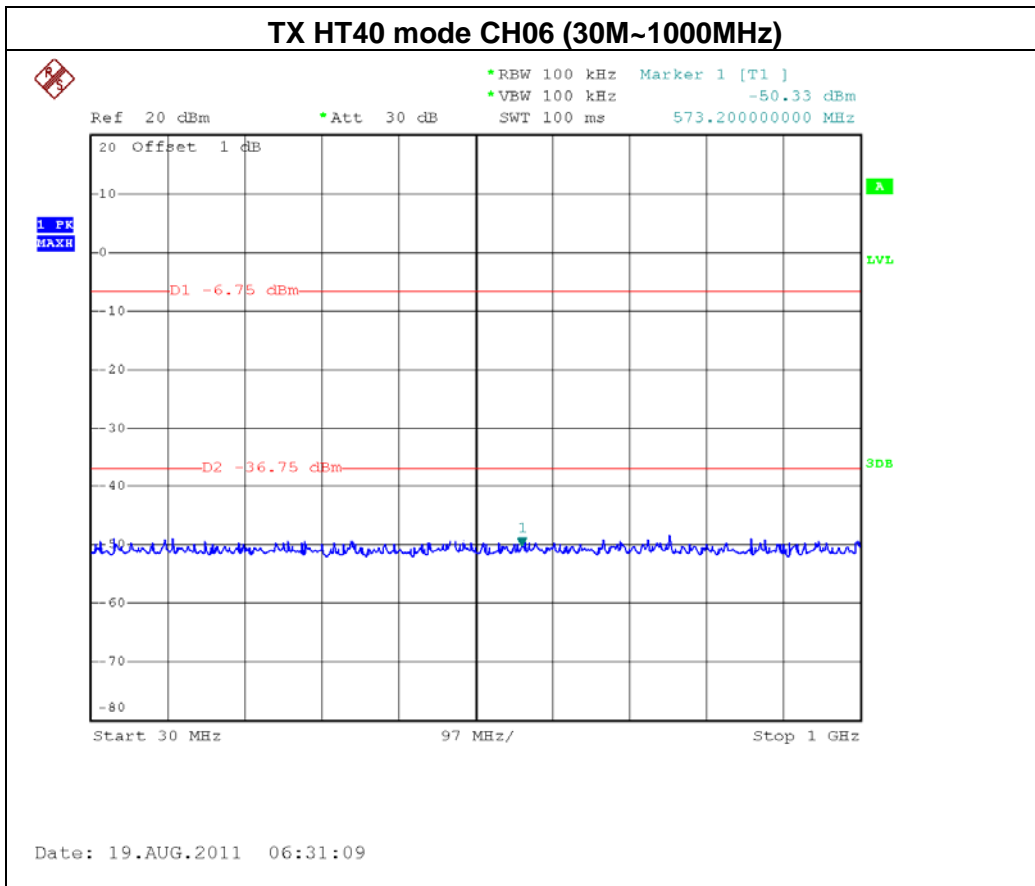

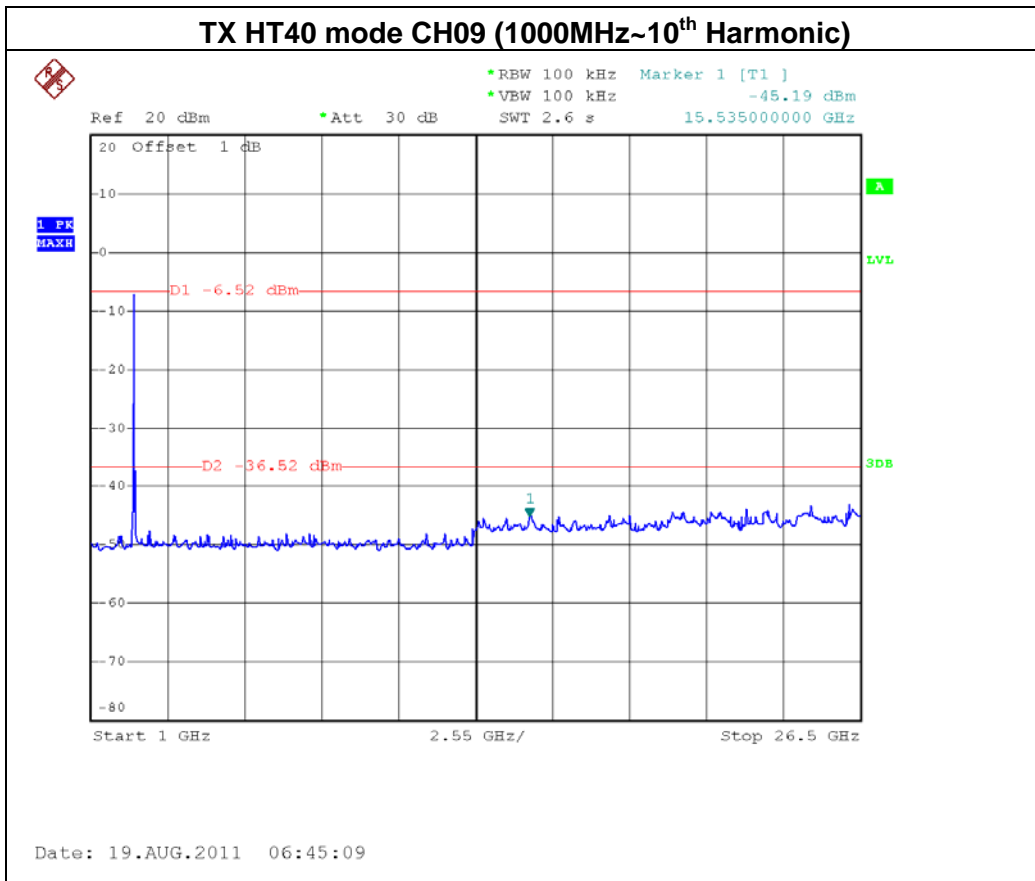
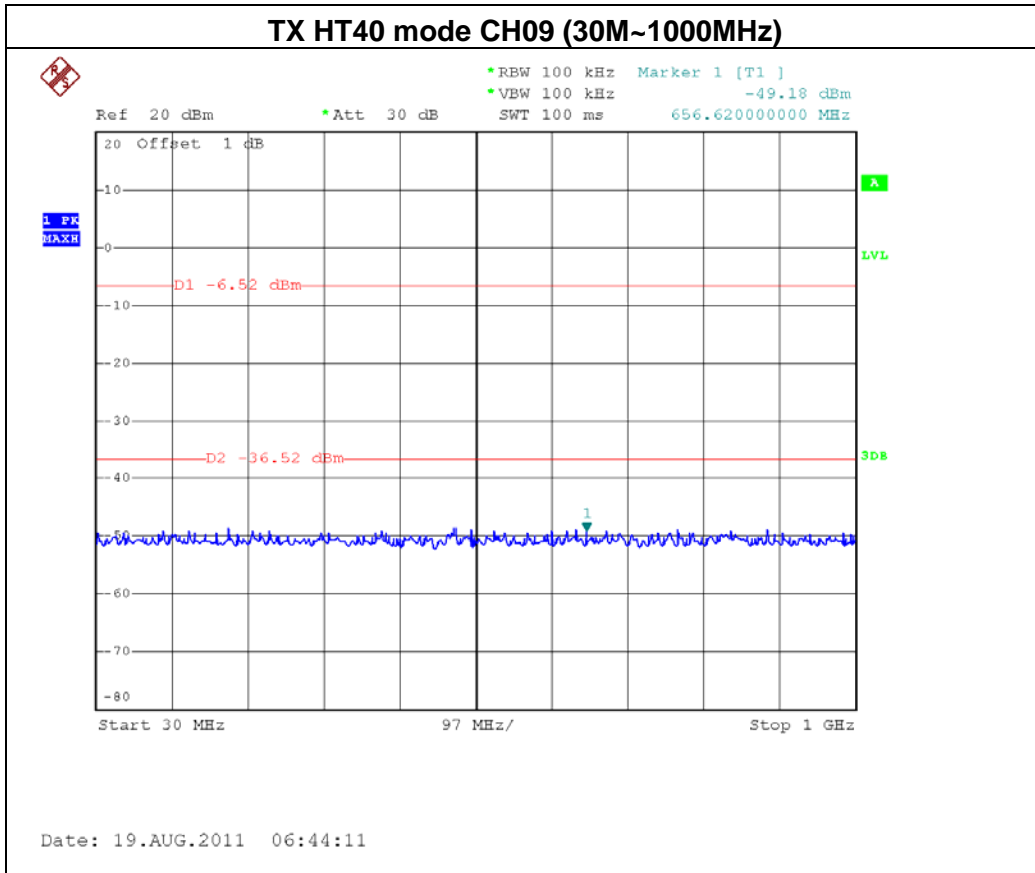



8. POWER SPECTRAL DENSITY TEST

8.1 Applied procedures / limit

FCC Part15 (15.247) , Subpart C				
Section	Test Item	Limit	Frequency Range (MHz)	Result
15.247(e)	Power Spectral Density	8 dBm (in any 3KHz)	2400-2483.5	PASS

8.1.1 MEASUREMENT INSTRUMENTS LIST

Item	Kind of Equipment	Manufacturer	Type No.	Serial No.	Calibrated until
1	Spectrum Analyzer	R&S	FSP_40	100129	Jan. 04, 2012

Remark: " N/A" denotes No Model Name. , Serial No. or No Calibration specified.

8.1.2 TEST PROCEDURE

- a. The EUT was directly connected to the spectrum analyzer and antenna output port as show in the block diagram below,
- b. Spectrum Setting : RBW=3KHz, VBW=30 KHz, Sweep time = 500s.

8.1.3 DEVIATION FROM STANDARD

No deviation.

8.1.4 TEST SETUP

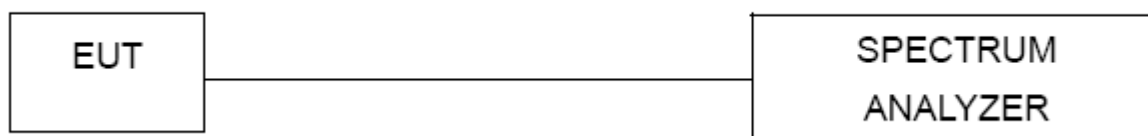

8.1.5 EUT OPERATION CONDITIONS

The EUT tested system was configured as the statements of 4.1.6 Unless otherwise a special operating condition is specified in the follows during the testing.



8.1.6 TEST RESULTS

EUT :	150Mbps Wireless-N USB Adapter	Model Name :	WF-2103
Temperature :	24 °C	Relative Humidity :	60 %
Pressure :	1016 hPa	Test Voltage :	AC 120V/60Hz
Test Mode :	TX B MODE /CH01, CH06, CH11		

Test Channel	Frequency (MHz)	Power Density (dBm)	LIMIT (dBm)
CH01	2412 MHz	-17.86	8
CH06	2437 MHz	-17.00	8
CH11	2462 MHz	-18.07	8

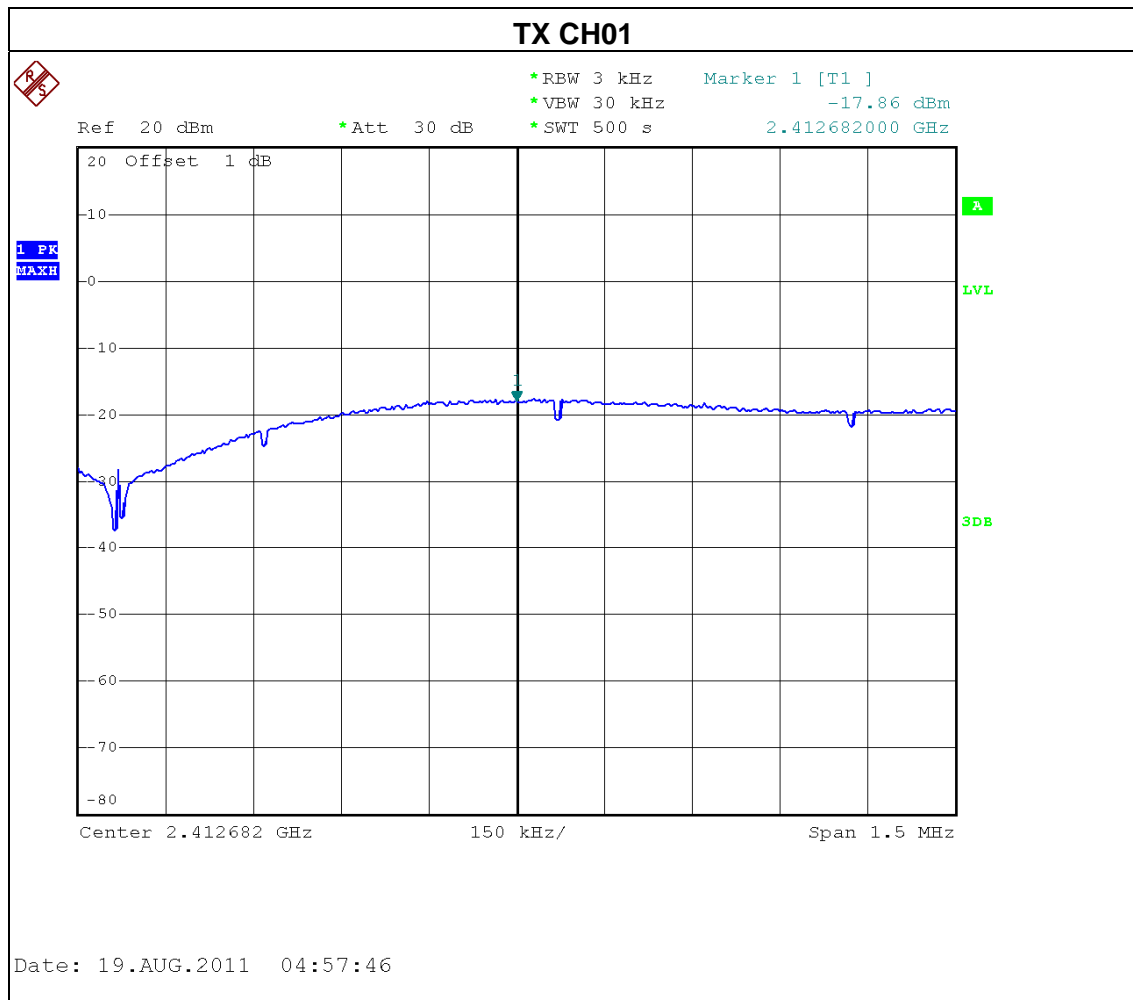

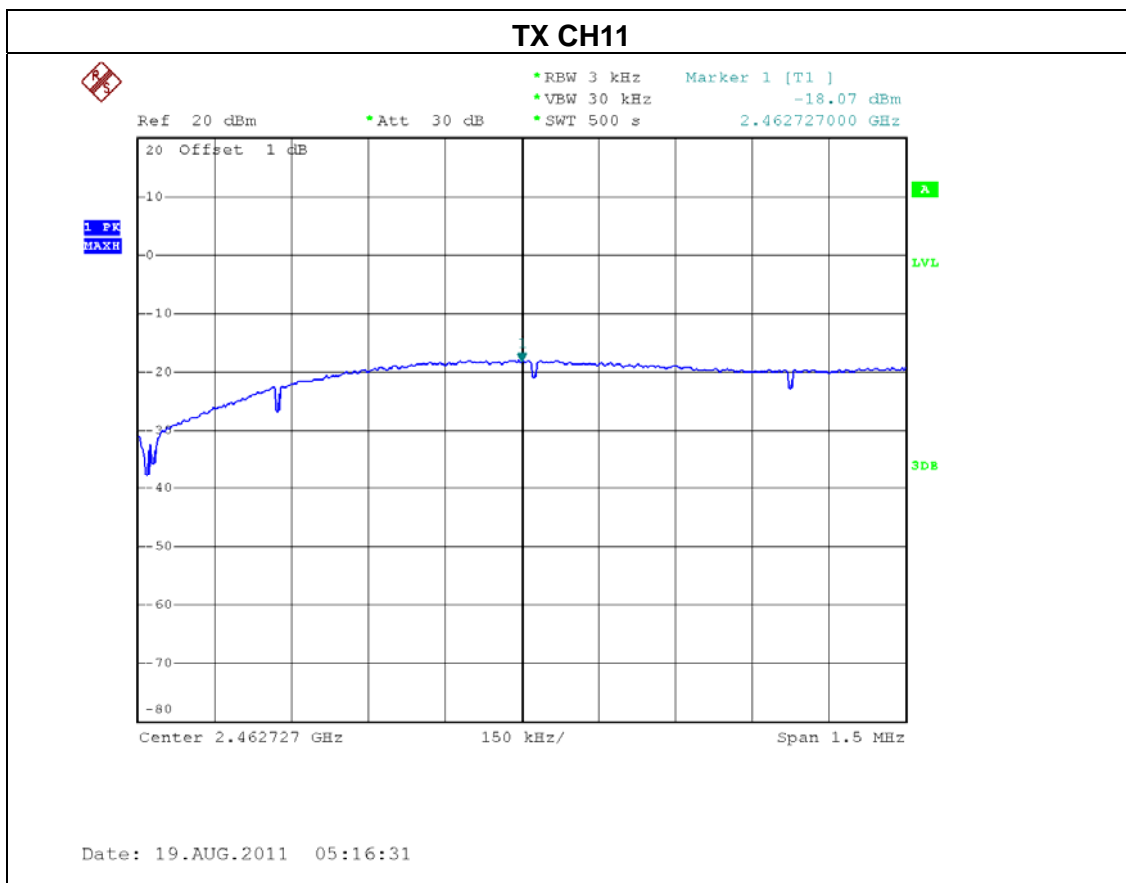
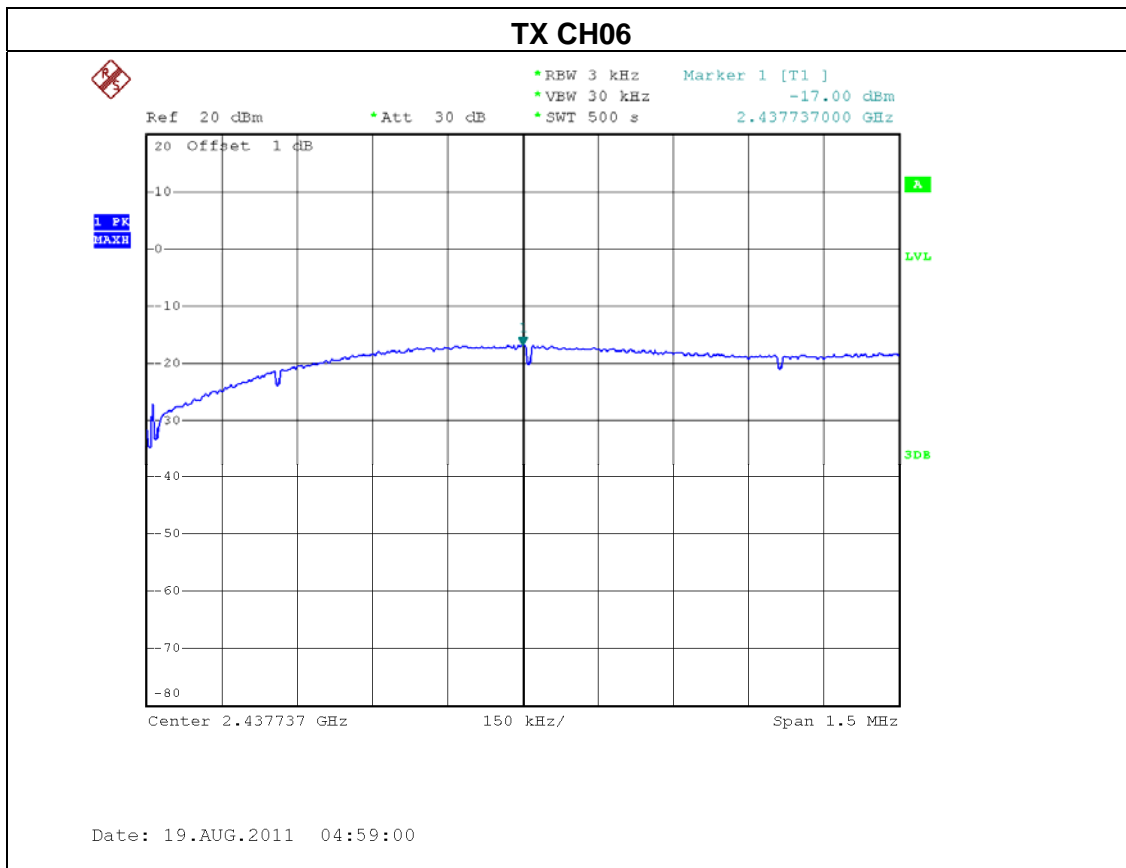



EUT :	150Mbps Wireless-N USB Adapter	Model Name :	WF-2103
Temperature :	24 °C	Relative Humidity :	60 %
Pressure :	1016 hPa	Test Voltage :	AC 120V/60Hz
Test Mode :	TX G MODE /CH01, CH06, CH11		

Test Channel	Frequency (MHz)	Power Density (dBm)	LIMIT (dBm)
CH01	2412 MHz	-18.23	8
CH06	2437 MHz	-17.45	8
CH11	2462 MHz	-17.29	8

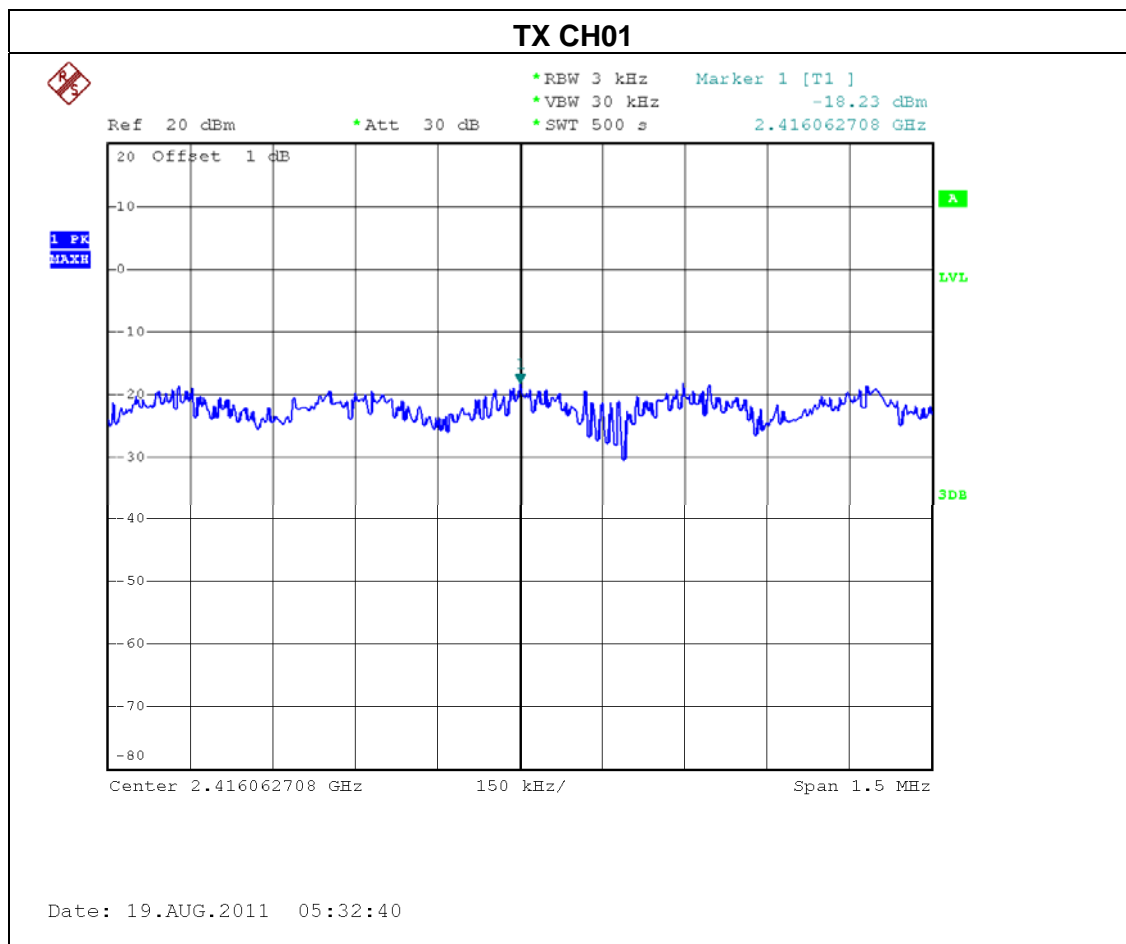

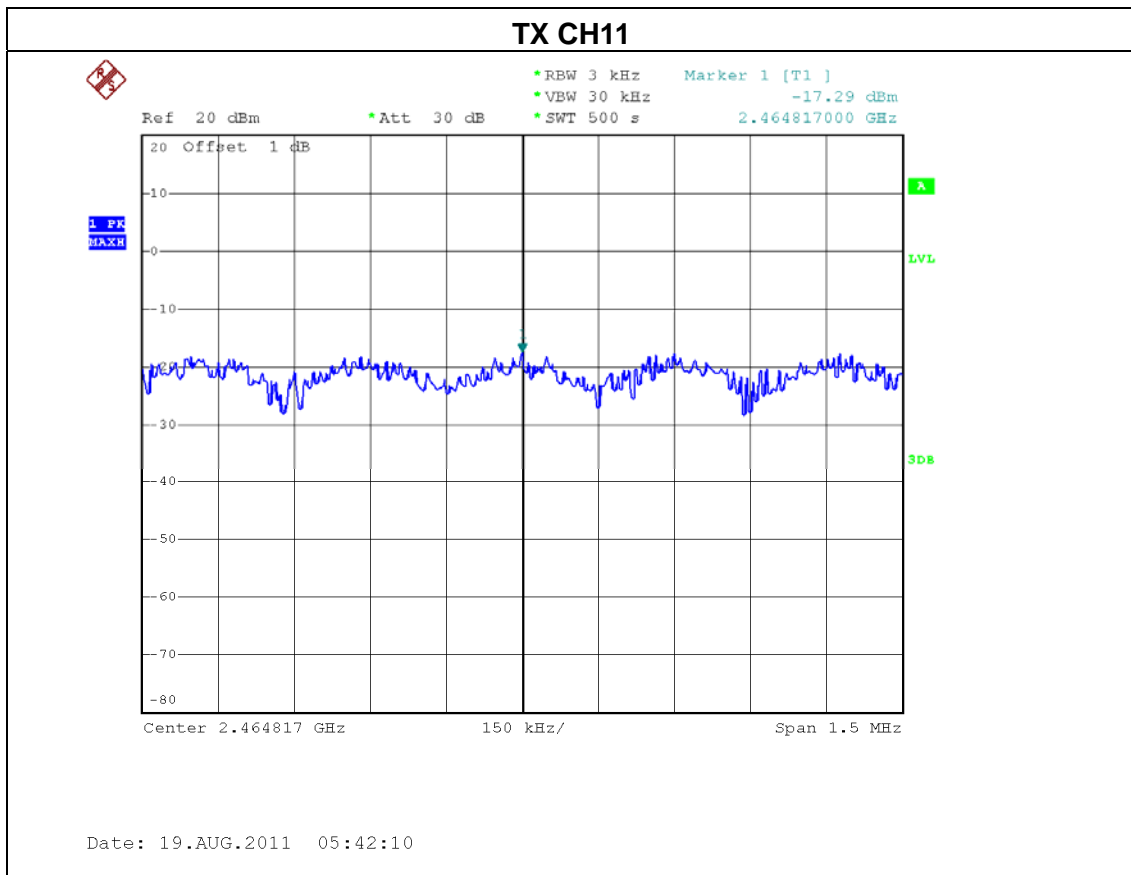
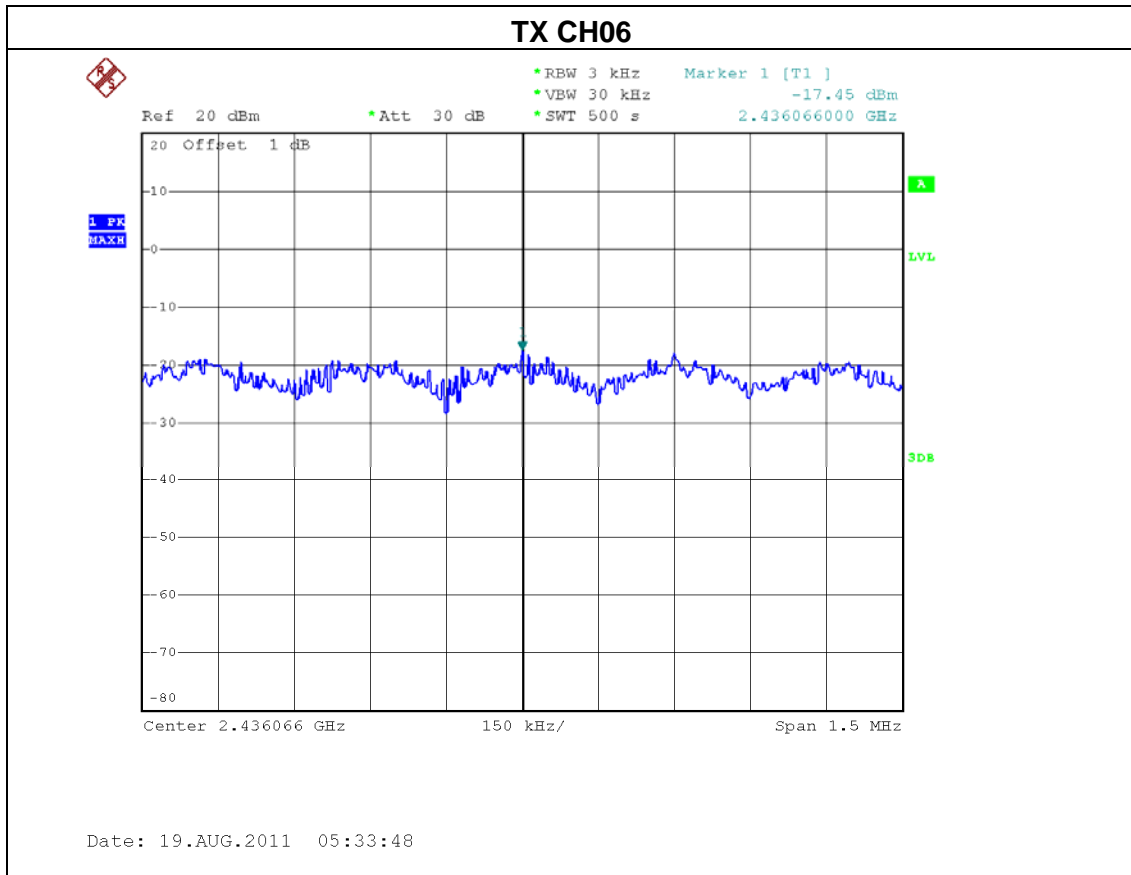



EUT :	150Mbps Wireless-N USB Adapter	Model Name :	WF-2103
Temperature :	24 °C	Relative Humidity :	60 %
Pressure :	1016 hPa	Test Voltage :	AC 120V/60Hz
Test Mode :	TX N MODE-20MHz /CH01, CH06, CH11		

Test Channel	Frequency (MHz)	Power Density (dBm)	LIMIT (dBm)
CH01	2412 MHz	-17.88	8
CH06	2437 MHz	-17.97	8
CH11	2462 MHz	-16.50	8

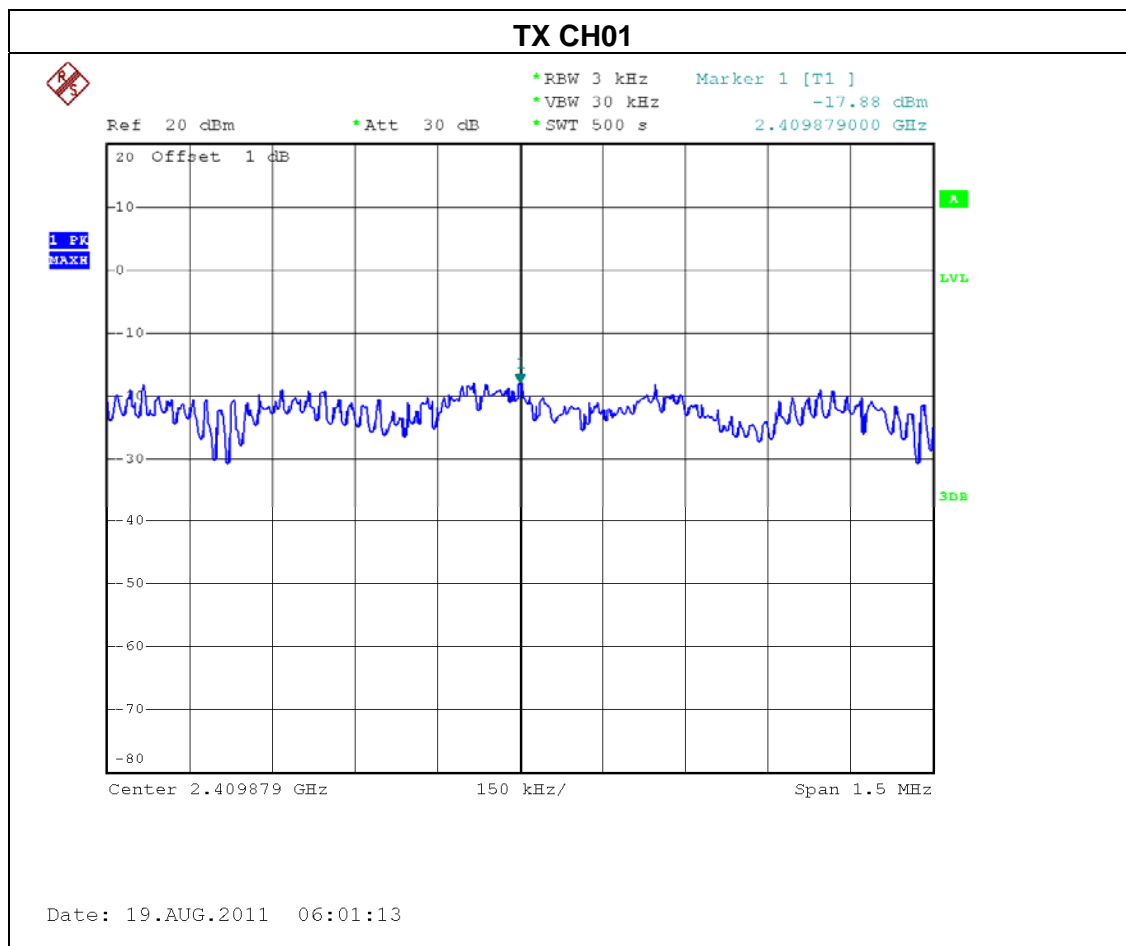

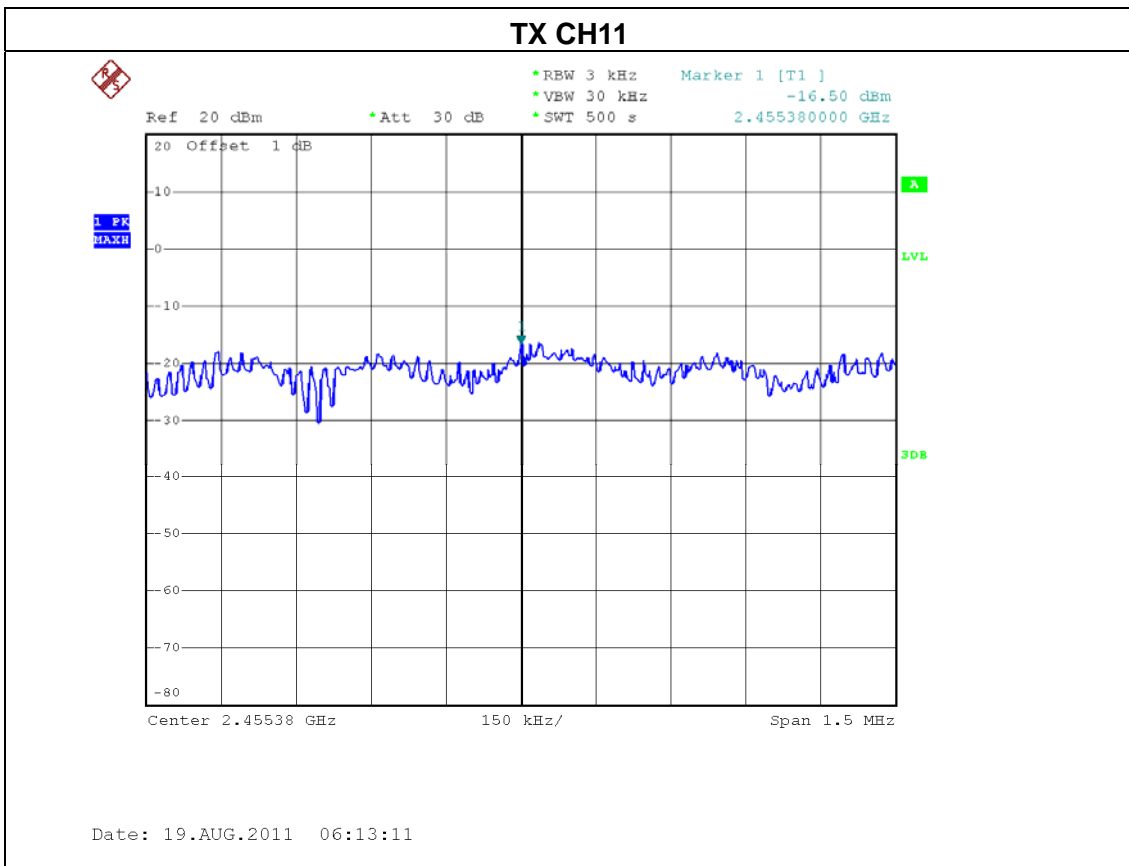
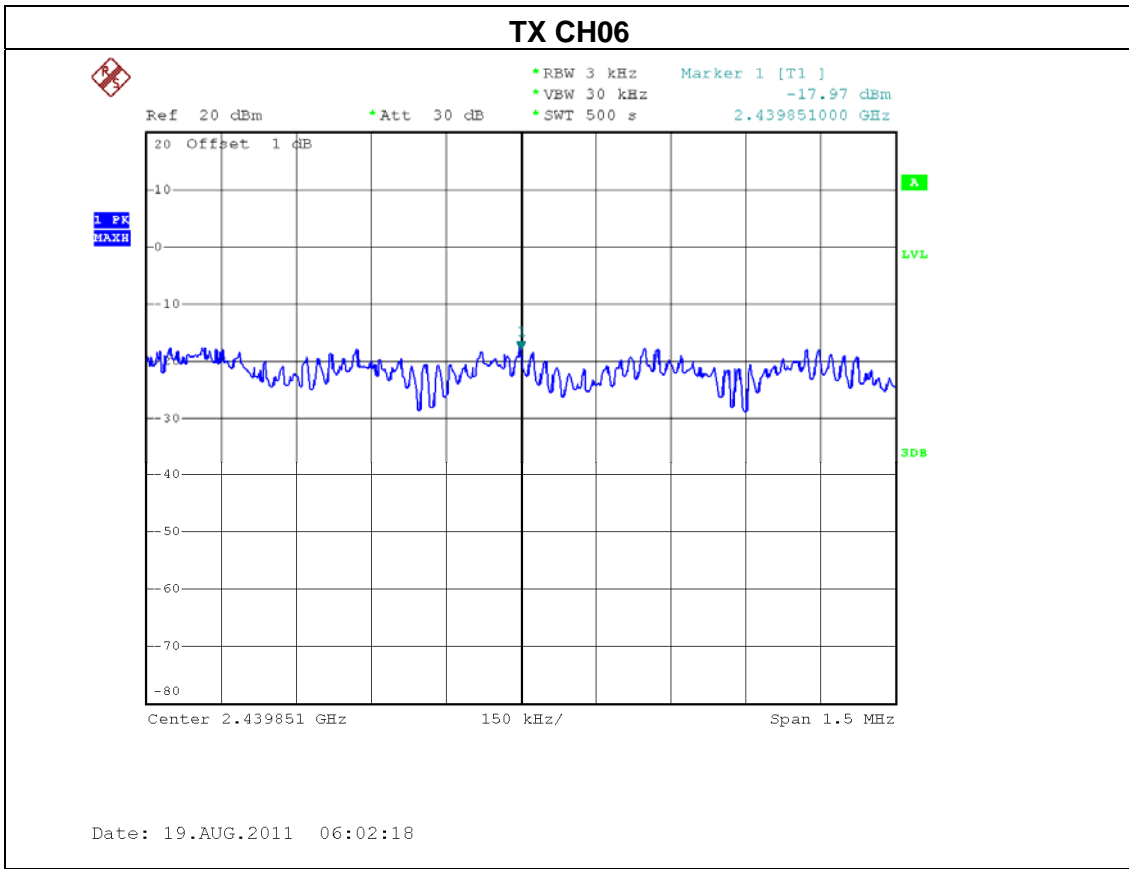



EUT :	150Mbps Wireless-N USB Adapter	Model Name :	WF-2103
Temperature :	24 °C	Relative Humidity :	60 %
Pressure :	1016 hPa	Test Voltage :	AC 120V/60Hz
Test Mode :	TX N MODE-40MHz /CH03, CH06, CH09		

Test Channel	Frequency (MHz)	Power Density (dBm)	LIMIT (dBm)
CH03	2422 MHz	-18.00	8
CH06	2437 MHz	-17.71	8
CH09	2452 MHz	-20.30	8

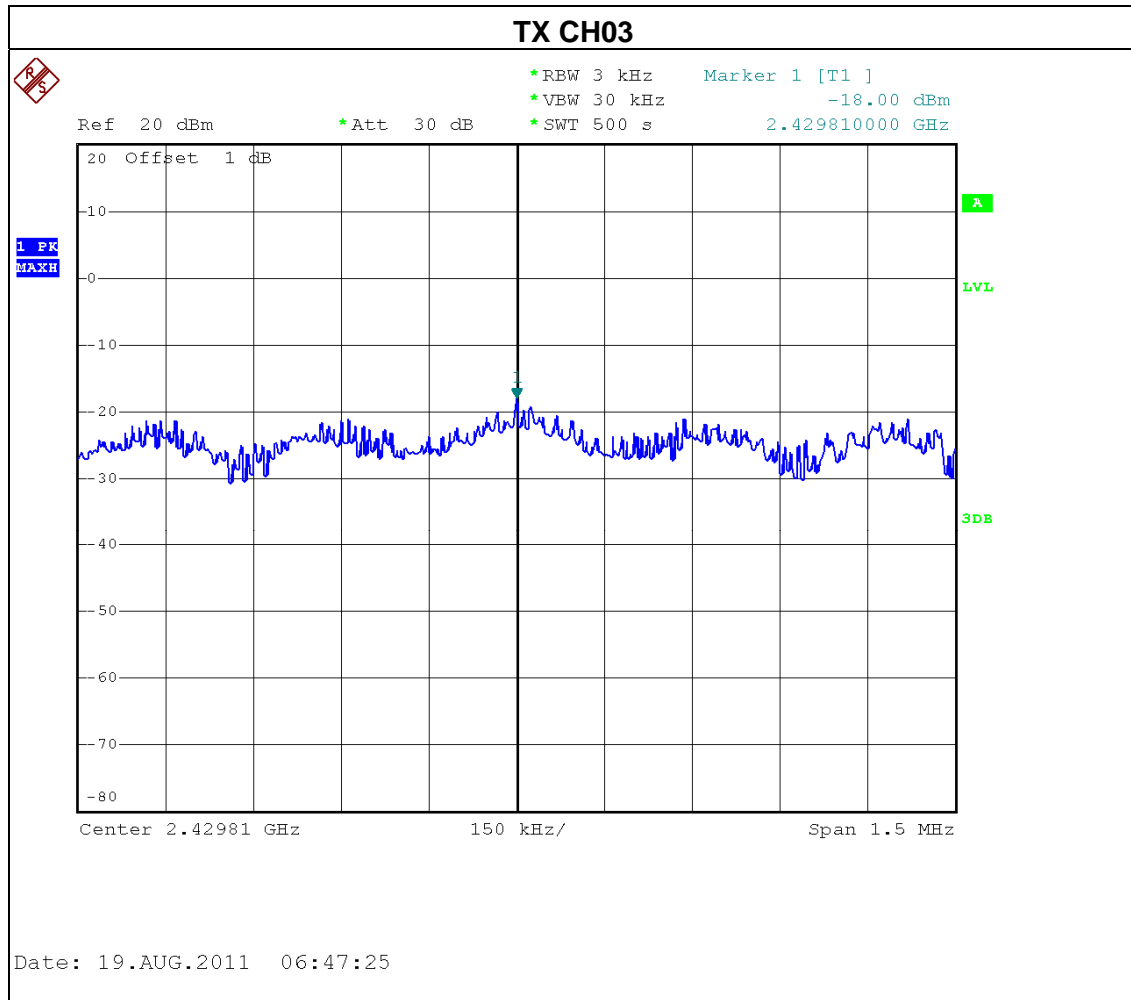

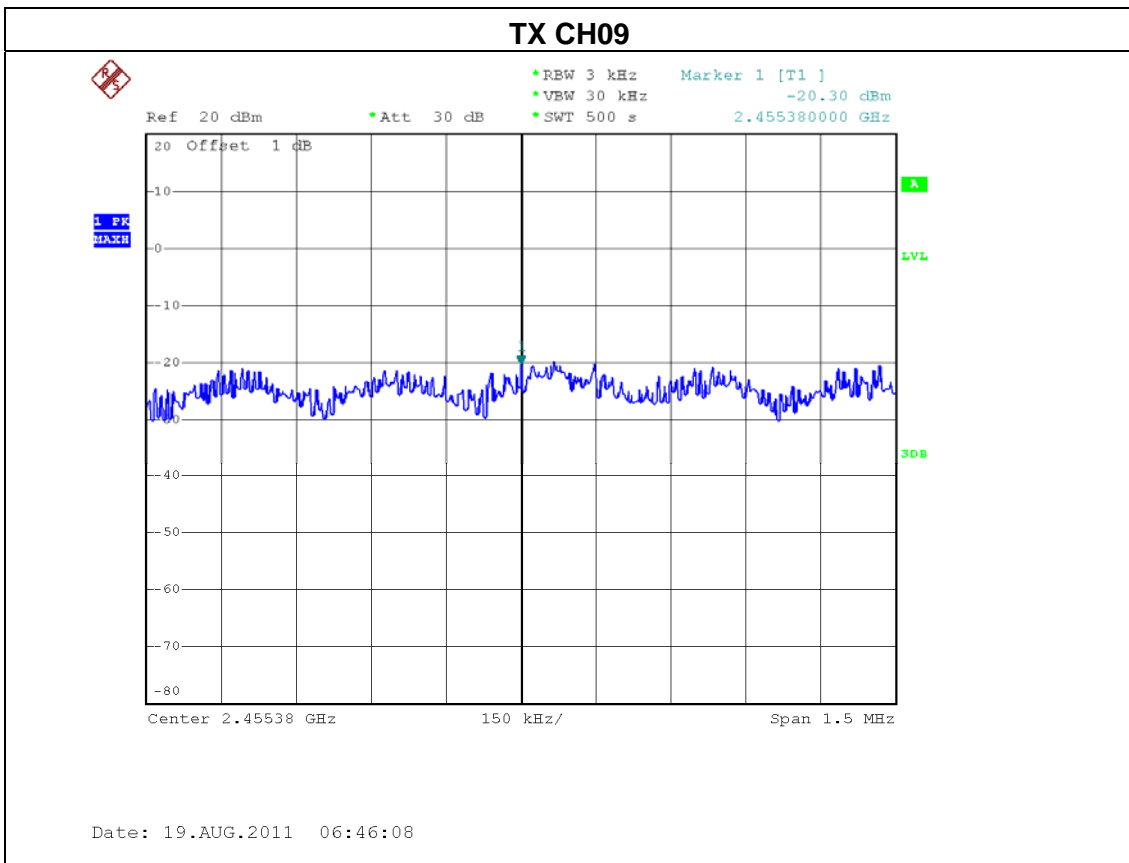
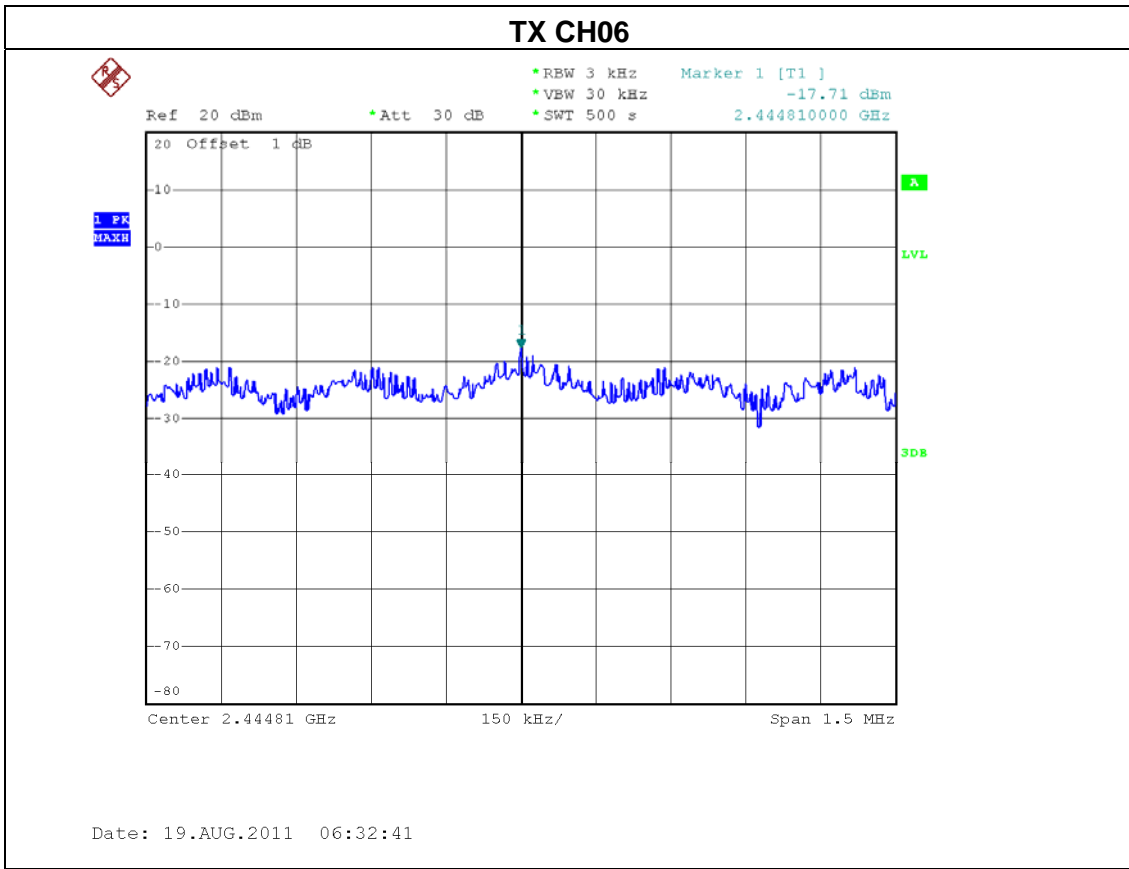



9. EUT TEST PHOTO

Conducted Measurement Photos





Radiated Measurement Photos

