

FCC Radio Test Report

FCC ID: T58SEV204H

This report concerns (check one): Original Grant Class II Change

Project No. : 1503C201A
Equipment : 4CH Wireless NVR / 4CH Wireless IP Camera & NVR Security Kit
Model Name : SEV204, SEK204
Applicant : NETIS SYSTEMS CO., LTD
Address : 4F&5F R&D Building, Oriental Cyberport, High-Tech Industrial Park, Nanshan, Shenzhen, China.

Date of Receipt : Jul. 06, 2015
Date of Test : Jul. 06, 2015~Aug. 07, 2015
Issued Date : Aug. 10, 2015
Tested by : BTL Inc.

Testing Engineer : *Niklaus Lai*
(Niklaus Lai)

Technical Manager : *David Mao*
(David Mao)

Authorized Signatory : *Steven Lu*
(Steven Lu)

B T L I N C .

No.3, Jinshagang 1st Road, Shixia, Dalang Town, Dongguan,
Guangdong, China.

TEL: +86-769-8318-3000 FAX: +86-769-8319-6000

Declaration

BTL represents to the client that testing is done in accordance with standard procedures as applicable and that test instruments used has been calibrated with the standards traceable to National Measurement Laboratory (**NML**) of **R.O.C**, or National Institute of Standards and Technology (**NIST**) of **U.S.A**.

BTL's reports apply only to the specific samples tested under conditions. It is manufacture's responsibility to ensure that additional production units of this model are manufactured with the identical electrical and mechanical components. **BTL** shall have no liability for any declarations, inferences or generalizations drawn by the client or others from **BTL** issued reports.

BTL's report must not be used by the client to claim product certification, approval, or endorsement by NVLAP, NIST, or any agency of the Federal Government.

This report is the confidential property of the client. As a mutual protection to the clients, the public and **BTL-self**, extracts from the test report shall not be reproduced except in full with **BTL's** authorized written approval.

BTL's laboratory quality assurance procedures are in compliance with the **ISO Guide 17025** requirements, and accredited by the conformity assessment authorities listed in this test report.

Limitation

For the use of the authority's logo is limited unless the Test Standard(s)/Scope(s)/Item(s) mentioned in this test report is (are) included in the conformity assessment authorities acceptance respective.

Table of Contents	Page
1 . CERTIFICATION	6
2 . SUMMARY OF TEST RESULTS	7
2.1 TEST FACILITY	8
2.2 MEASUREMENT UNCERTAINTY	8
3 . GENERAL INFORMATION	9
3.1 GENERAL DESCRIPTION OF EUT	9
3.2 DESCRIPTION OF TEST MODES	11
3.3 TABLE OF PARAMETERS OF TEXT SOFTWARE SETTING	12
3.4 BLOCK DIAGRAM SHOWING THE CONFIGURATION OF SYSTEM TESTED	13
3.5 DESCRIPTION OF SUPPORT UNITS	13
4 . EMC EMISSION TEST	14
4.1 CONDUCTED EMISSION MEASUREMENT	14
4.1.1 POWER LINE CONDUCTED EMISSION LIMITS	14
4.1.2 TEST PROCEDURE	14
4.1.3 DEVIATION FROM TEST STANDARD	14
4.1.4 TEST SETUP	15
4.1.5 EUT OPERATING CONDITIONS	15
4.1.6 EUT TEST CONDITIONS	15
4.1.7 TEST RESULTS	15
4.2 RADIATED EMISSION MEASUREMENT	16
4.2.1 RADIATED EMISSION LIMITS	16
4.2.2 TEST PROCEDURE	17
4.2.3 DEVIATION FROM TEST STANDARD	17
4.2.4 TEST SETUP	18
4.2.5 EUT OPERATING CONDITIONS	19
4.2.6 EUT TEST CONDITIONS	19
4.2.7 TEST RESULTS (9KHZ TO 30MHZ)	20
4.2.8 TEST RESULTS (30MHZ TO 1000 MHZ)	20
4.2.9 TEST RESULTS (ABOVE 1000 MHZ)	20
5 . BANDWIDTH TEST	21
5.1 APPLIED PROCEDURES	21
5.1.1 TEST PROCEDURE	21
5.1.2 DEVIATION FROM STANDARD	21
5.1.3 TEST SETUP	21
5.1.4 EUT OPERATION CONDITIONS	21
5.1.5 EUT TEST CONDITIONS	21
5.1.6 TEST RESULTS	21
6 . MAXIMUM PEAK CONDUCTED OUTPUT POWER TEST	22

Table of Contents	Page
6.1 APPLIED PROCEDURES / LIMIT	22
6.1.1 TEST PROCEDURE	22
6.1.2 DEVIATION FROM STANDARD	22
6.1.3 TEST SETUP	22
6.1.4 EUT OPERATION CONDITIONS	22
6.1.5 EUT TEST CONDITIONS	22
6.1.6 TEST RESULTS	22
7 . ANTENNA CONDUCTED SPURIOUS EMISSION	23
7.1 APPLIED PROCEDURES / LIMIT	23
7.1.1 TEST PROCEDURE	23
7.1.2 DEVIATION FROM STANDARD	23
7.1.3 TEST SETUP	23
7.1.4 EUT OPERATION CONDITIONS	23
7.1.5 EUT TEST CONDITIONS	23
7.1.6 TEST RESULTS	23
8 . POWER SPECTRAL DENSITY TEST	24
8.1 APPLIED PROCEDURES / LIMIT	24
8.1.1 TEST PROCEDURE	24
8.1.2 DEVIATION FROM STANDARD	24
8.1.3 TEST SETUP	24
8.1.4 EUT OPERATION CONDITIONS	24
8.1.5 EUT TEST CONDITIONS	24
8.1.6 TEST RESULTS	24
9 . MEASUREMENT INSTRUMENTS LIST	25
10 . EUT TEST PHOTO	27
ATTACHMENT A - CONDUCTED EMISSION	31
ATTACHMENT B - RADIATED EMISSION (9KHZ TO 30MHZ)	34
ATTACHMENT C - RADIATED EMISSION (30MHZ TO 1000MHZ)	36
ATTACHMENT D - RADIATED EMISSION (ABOVE 1000MHZ)	43
ATTACHMENT E - BANDWIDTH	92
ATTACHMENT F – MAXIMUM PEAK CONDUCTED OUTPUT POWER	101
ATTACHMENT G - ANTENNA CONDUCTED SPURIOUS EMISSION	105
ATTACHMENT H - POWER SPECTRAL DENSITY	130

REPORT ISSUED HISTORY

Issued No.	Description	Issued Date
BTL-FCCP-1-1503C201A	Original Issue.	Aug. 10, 2015

1. CERTIFICATION

Equipment : 4CH Wireless NVR / 4CH Wireless IP Camera & NVR Security Kit
Brand Name : netis
Model Name : SEV204, SEK204
Applicant : NETIS SYSTEMS CO., LTD
Manufacturer : Shenzhen Netcore Industrial Ltd.
Address : 4F&5F R&D Building, Oriental Cyberport, High-Tech Industrial Park, Nanshan, Shenzhen, China.
Factory : Dongguan City Netcore Network Technology Co.,Ltd.
Address : No.10-1,Sankeng Road,Qinghutou,Tangxia Town,Dongguan City
Date of Test : Jul. 06, 2015~Aug. 07, 2015
Test Sample : Engineering Sample
Standard(s) : FCC Part15, Subpart C: 2014 (15.247) / ANSI C63.10-2013

The above equipment has been tested and found compliance with the requirement of the relative standards by BTL Inc.

The test data, data evaluation, and equipment configuration contained in our test report (Ref No. BTL-FCCP-1-1503C201A) were obtained utilizing the test procedures, test instruments, test sites that has been accredited by the Authority of TAF according to the ISO-17025 quality assessment standard and technical standard(s).

2. SUMMARY OF TEST RESULTS

Test procedures according to the technical standard(s):

Applied Standard(s): FCC Part15 (15.247) , Subpart C: 2014				
Standard(s)	Section	Test Item	Judgment	Remark
15.207		Conducted Emission	PASS	
15.247(d)		Antenna conducted Spurious Emission	PASS	
15.247(a)(2)		6dB Bandwidth	PASS	
15.247(b)(3)		Peak Output Power	PASS	
15.247(e)		Power Spectral Density	PASS	
15.203		Antenna Requirement	PASS	
15.209/15.205		Transmitter Radiated Emissions	PASS	

NOTE:

(1) "N/A" denotes test is not applicable in this test report.

2.1 TEST FACILITY

The test facilities used to collect the test data in this report is at the location of No.3,Jinshagang 1st Road, Shixia, Dalang Town, Dongguan, Guangdong, China.
BTL's test firm number for FCC: 319330

2.2 MEASUREMENT UNCERTAINTY

Where relevant, the following measurement uncertainty levels have been estimated for tests performed on the EUT as specified in CISPR 16-4-2. The BTL measurement uncertainty is less than the CISPR 16-4-2 U_{CISPR} requirement.

The reported uncertainty of measurement $y \pm U$, where expanded uncertainty U is based on a standard uncertainty multiplied by a coverage factor of $k=2$, providing a level of confidence of approximately 95 %.

A. Conducted Measurement:

Test Site	Method	Measurement Frequency Range	U, (dB)	Note
DG-C02	CISPR	150 KHz ~ 30MHz	2.32	

B. Radiated Measurement:

Test Site	Method	Measurement Frequency Range	Ant. H / V	U, (dB)	Note
DG-CB03	CISPR	9KHz~30MHz	V	3.79	
		9KHz~30MHz	H	3.57	
		30MHz ~ 200MHz	V	3.82	
		30MHz ~ 200MHz	H	3.78	
		200MHz ~ 1,000MHz	V	4.10	
		200MHz ~ 1,000MHz	H	4.06	
		1GHz~18GHz	V	3.12	
		1GHz~18GHz	H	3.68	
		18GHz~40GHz	V	4.15	
		18GHz~40GHz	H	4.14	

Note: Unless specifically mentioned, the uncertainty of measurement has not been taken into account to declare the compliance or non-compliance to the specification.

3. GENERAL INFORMATION

3.1 GENERAL DESCRIPTION OF EUT

Equipment	4CH Wireless NVR / 4CH Wireless IP Camera & NVR Security Kit		
Brand Name	netis		
Model Name	SEV204, SEK204		
Model Difference	SEK204 is suit models,including the SEC111 and SEV204 camera. Model SEC111 Please refer to BTL-FCCP-1-1503C202A.		
Product Description	Operation Frequency	2412~2462 MHz	
	Modulation Technology	802.11b:DSSS 802.11g:OFDM 802.11n:OFDM	
	Bit Rate of Transmitter	802.11b: 11/5.5/2/1 Mbps 802.11g: 54/48/36/24/18/12/9/6 Mbps 802.11n up to 300 Mbps	
	Output Power (Max.)	802.11b: 14.12dBm 802.11g: 13.88dBm 802.11n(20MHz): 13.89dBm 802.11n(40MHz): 13.88dBm	
Power Source	DC voltage supplied from AC/DC Adapter. Brand/ Model: GOSPELL/ G0298U-120-300		
Power Rating	I/P: 100-240V~ 1A max 50/60Hz O/P: DC 12V 3A		



Note:

1. For a more detailed features description, please refer to the manufacturer's specifications or the user's manual.

2. Channel List:

CH01 – CH11 for 802.11b, 802.11g, 802.11n(20MHz) CH03 – CH09 for 802.11n(40MHz)							
Channel	Frequency (MHz)	Channel	Frequency (MHz)	Channel	Frequency (MHz)	Channel	Frequency (MHz)
01	2412	04	2427	07	2442	10	2457
02	2417	05	2432	08	2447	11	2462
03	2422	06	2437	09	2452		

3. Table for Filed Antenna

Ant.	Brand	P/N	Antenna Type	Connector	Gain (dBi)
1		RF21S00001A	Dipole	R-SMA	5.24
2		RF21S00001A	Dipole	R-SMA	5.24

Note:

- (1) The EUT incorporates a MIMO function. Physically, the EUT provides two completed transmitters and receivers (2T2R), all transmit signals are completely uncorrelated, then, **Direction gain = G_{ANT}** , that is Directional gain=5.24.
- (2) ANT 1 for 1TX is the worst case.

4.

Operating Mode TX Mode	1TX	2TX
	802.11b	V (ANT 1)
802.11g	V (ANT 1)	-
802.11n(20MHz)	-	V (ANT 1 + ANT 2)
802.11n(40MHz)	-	V (ANT 1 + ANT 2)

3.2 DESCRIPTION OF TEST MODES

To investigate the maximum EMI emission characteristics generated from EUT, the test system was pre-scanning tested based on the consideration of following EUT operation mode or test configuration mode which possibly have effect on EMI emission level. Each of these EUT operation mode(s) or test configuration mode(s) mentioned above was evaluated respectively.

Pretest Mode	Description
Mode 1	TX B MODE CHANNEL 01/06/11
Mode 2	TX G MODE CHANNEL 01/06/11
Mode 3	TX N-20MHZ MODE CHANNEL 01/06/11
Mode 4	TX N-40MHZ MODE CHANNEL 03/06/09
Mode 5	TX MODE

The EUT system operated these modes were found to be the worst case during the pre-scanning test as following:

For Conducted Test	
Final Test Mode	Description
Mode 5	TX MODE

For Radiated Test	
Final Test Mode	Description
Mode 1	TX B MODE CHANNEL 01/06/11
Mode 2	TX G MODE CHANNEL 01/06/11
Mode 3	TX N-20MHZ MODE CHANNEL 01/06/11
Mode 4	TX N-40MHZ MODE CHANNEL 03/06/09

Note:

- (1) The measurements are performed at the high, middle, low available channels.
- (2) 802.11b mode: DBPSK (1Mbps)
 802.11g mode: OFDM (6Mbps)
 802.11n HT20 mode : BPSK (13Mbps)
 802.11n HT40 mode : BPSK (27Mbps)
 For radiated emission tests, the highest output powers were set for final test.
- (3) For radiated below 1G test, the 802.11b is found to be the worst case and recorded.
- (4) The EUT was programmed to be in continuously transmitting mode and the transmit duty cycle is not less than 98%.

3.3 TABLE OF PARAMETERS OF TEXT SOFTWARE SETTING

During testing, channel & power controlling software provided by the customer was used to control the operating channel as well as the output power level. The RF output power selection is for the setting of RF output power expected by the customer and is going to be fixed on the firmware of the final end product power parameters of WLAN

Test software version	smartTools		
Frequency (MHz)	2412	2437	2462
802.11b	45	45	45
802.11g	46	47	47
802.11n (20MHz)	48	46	47
Frequency	2422	2437	2452
802.11n (40MHz)	48	48	48

3.4 BLOCK DIAGRAM SHOWING THE CONFIGURATION OF SYSTEM TESTED

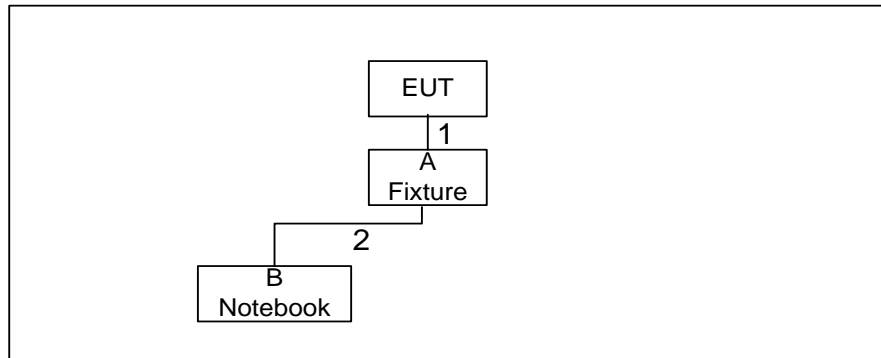

Control Room

3.5 DESCRIPTION OF SUPPORT UNITS

The EUT has been tested as an independent unit together with other necessary accessories or support units. The following support units or accessories were used to form a representative test configuration during the tests.

Item	Equipment	Mfr/Brand	Model/Type No.	FCC ID	Series No.	Note
A	Fixture	N/A	N/A	N/A	N/A	
B	Notebook	DELL	INSPIRON 1420	DOC	JX193A01SDC2	

Item	Shielded Type	Ferrite Core	Length	Note
1	NO	NO	0.1m	Data Cable
2	NO	NO	0.5m	RS232 Cable

4. EMC EMISSION TEST

4.1 CONDUCTED EMISSION MEASUREMENT

4.1.1 POWER LINE CONDUCTED EMISSION Limits (Frequency Range 150KHz-30MHz)

Frequency of Emission (MHz)	Conducted Limit (dB μ V)	
	Quasi-peak	Average \square
0.15 -0. \square	66 to 56*	56 to 46*
0.50 -5.0	56	46
5.0 -30.0	60	50

Note:

- (1) The limit of " * " decreases with the logarithm of the frequency
- (2) The test result calculated as following:
 Measurement Value = Reading Level + Correct Factor
 Correct Factor = Insertion Loss + Cable Loss + Attenuator Factor(if use)
 Margin Level = Measurement Value - Limit Value

The following table is the setting of the receiver

Receiver Parameters	Setting
Attenuation	10 dB
Start Frequency	0.15 MHz
Stop Frequency	30 MHz
IF Bandwidth	9 KHz

4.1.2 TEST PROCEDURE

- a. The EUT was placed 0.8 meters from the horizontal ground plane with EUT being connected to the power mains through a line impedance stabilization network (LISN). All other support equipments powered from additional LISN(s). The LISN provide 50 Ohm/ 50uH of coupling impedance for the measuring instrument.
- b. Interconnecting cables that hang closer than 40 cm to the ground plane shall be folded back and forth in the center forming a bundle 30 to 40 cm long.
- c. I/O cables that are not connected to a peripheral shall be bundled in the center. The end of the cable may be terminated, if required, using the correct terminating impedance. The overall length shall not exceed 1 m.
- d. LISN at least 80 cm from nearest part of EUT chassis.
- e. For the actual test configuration, please refer to the related Item –EUT Test Photos.

4.1.3 DEVIATION FROM TEST STANDARD

No deviation

4.1.4 TEST SETUP

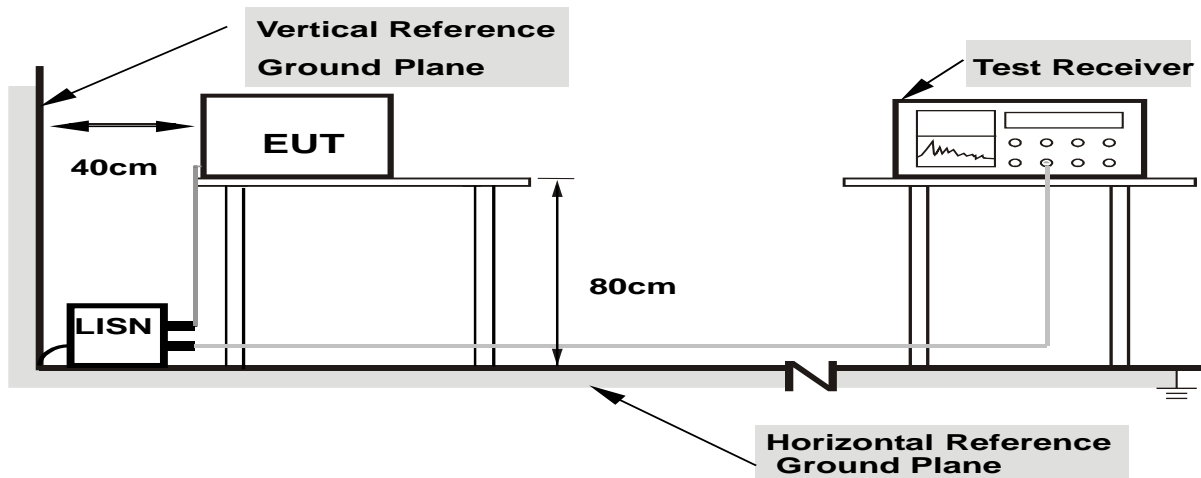

- Note:**
1. Support units were connected to second LISN.
 2. Both of LISNs (AMN) are 80 cm from EUT and at least 80 from other units and other metal planes

4.1.5 EUT OPERATING CONDITIONS

The EUT was placed on the test table and programmed in normal function.

4.1.6 EUT TEST CONDITIONS

Temperature: 27°C Relative Humidity: 55% Test Voltage: AC 120V/60Hz

4.1.7 TEST RESULTS

Please refer to the Attachment A.

4.2 RADIATED EMISSION MEASUREMENT

4.2.1 RADIATED EMISSION LIMITS

20dB in any 100 KHz bandwidth outside the operating frequency band. In case the emission fall within the restricted band specified on 15.205(a), then the 15.209(a) limit in the table below has to be followed.

LIMITS OF RADIATED EMISSION MEASUREMENT (9KHz-1000MHz)

Frequency (MHz)	Field Strength (microvolts/meter)	Measurement Distance (meters)
0.009~0.490	2400/F(KHz)	300
0.490~1.705	24000/F(KHz)	30
1.705~30.0	30	30
30~88	100	3
88~216	150	3
216~960	200	3
960~1000	500	3

LIMITS OF RADIATED EMISSION MEASUREMENT (Above 1000MHz)

Frequency (MHz)	(dBuV/m) (at 3 meters)	
	PEAK	AVERAGE
Above 1000	74	54

Notes:

- (1) The limit for radiated test was performed according to FCC PART 15C.
- (2) The tighter limit applies at the band edges.
- (3) Emission level (dBuV/m)=20log Emission level (uV/m).
- (4) The test result calculated as following:
 Measurement Value = Reading Level + Correct Factor
 Correct Factor = Antenna Factor + Cable Loss - Amplifier Gain(if use)
 Margin Level = Measurement Value - Limit Value

Spectrum Parameter	Setting
Attenuation	Auto
Start Frequency	1000 MHz
Stop Frequency	10th carrier harmonic
RBW / VBW (Emission in restricted band)	1MHz / 3MHz for Peak, 1MHz / 1/T for Average

Receiver Parameter	Setting
Attenuation	Auto
Start ~ Stop Frequency	9KHz~90KHz for PK/AVG detector
Start ~ Stop Frequency	90KHz~110KHz for QP detector
Start ~ Stop Frequency	110KHz~490KHz for PK/AVG detector
Start ~ Stop Frequency	490KHz~30MHz for QP detector
Start ~ Stop Frequency	30MHz~1000MHz for QP detector

4.2.2 TEST PROCEDURE

- a. The measuring distance of at 3 m shall be used for measurements. The EUT was placed on the top of a rotating table 0.8 meter above the ground at a 3 meter semi-anechoic chamber. The table was rotated 360 degrees to determine the position of the highest radiation.(below 1GHz)
- b. The measuring distance of at 3 m shall be used for measurements. The EUT was placed on the top of a rotating table 1.5 meter above the ground at a 3 meter semi-anechoic chamber. The table was rotated 360 degrees to determine the position of the highest radiation.(above 1GHz)
- c. The height of the equipment or of the substitution antenna shall be 0.8 m or 1.5m, the height of the test antenna shall vary between 1 m to 4 m. Both horizontal and vertical polarizations of the antenna are set to make the measurement.
- d. The initial step in collecting conducted emission data is a receiver peak detector mode pre-scanning the measurement frequency range. Significant peaks are then marked and then Quasi Peak detector mode re-measured.
- e. All readings are Peak unless otherwise stated QP in column of Note. Peak denotes that the Peak reading compliance with the QP Limits and then QP Mode measurement didn't perform. (below 1GHz)
- f. All readings are Peak Mode value unless otherwise stated AVG in column of Note. If the Peak Mode Measured value compliance with the Peak Limits and lower than AVG Limits, the EUT shall be deemed to meet both Peak & AVG Limits and then only Peak Mode was measured, but AVG Mode didn't perform. (above 1GHz)
- g. For the actual test configuration, please refer to the related Item –EUT Test Photos.

4.2.3 DEVIATION FROM TEST STANDARD

No deviation

4.2.4 TEST SETUP

(A) Radiated Emission Test Set-Up Frequency Below 1 GHz

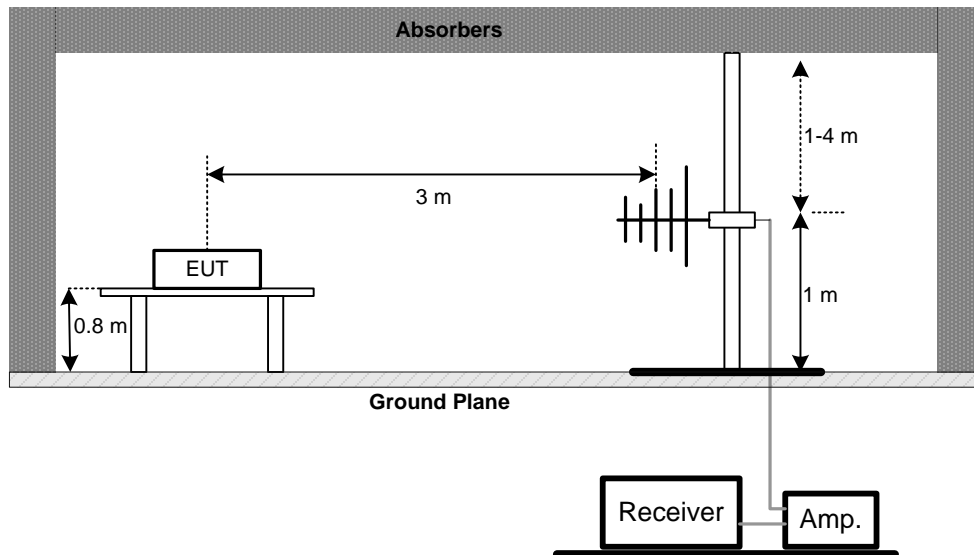

(B) Radiated Emission Test Set-Up Frequency Above 1 GHz

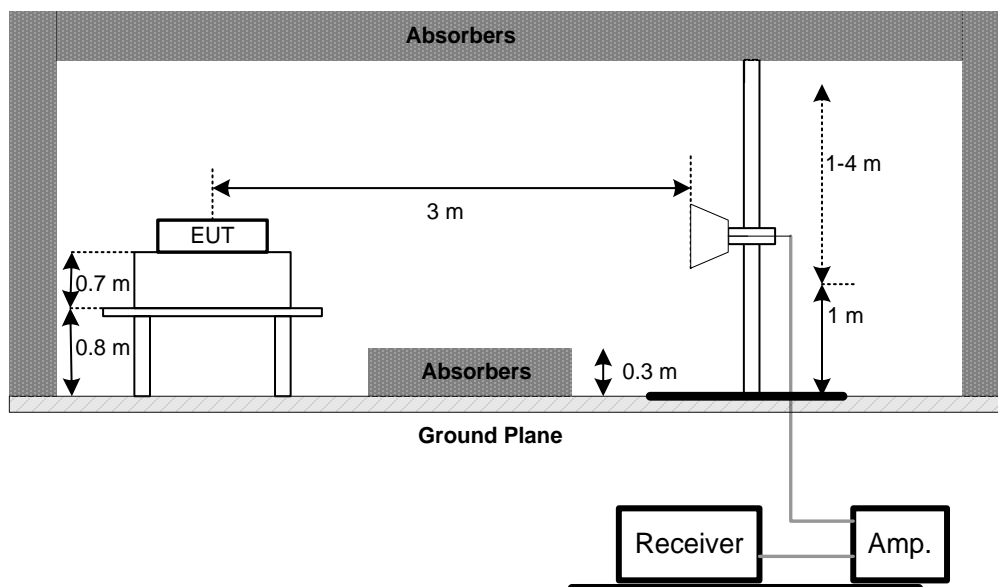

(C) For Radiated Emissions Below 30MHz

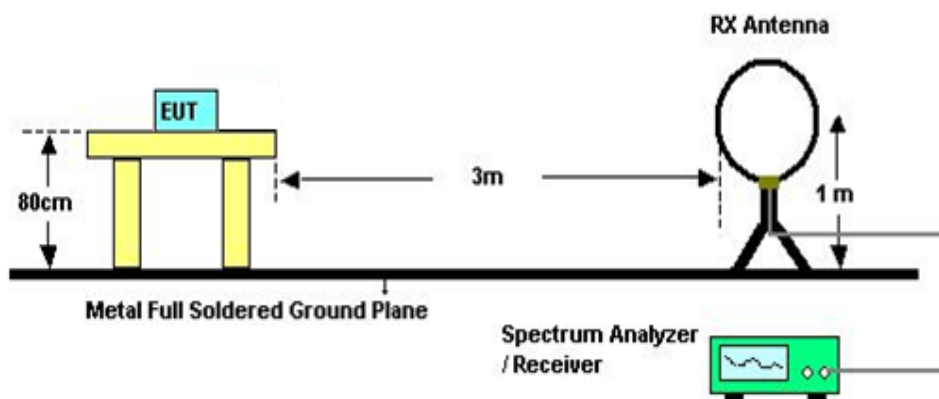

4.2.5 EUT OPERATING CONDITIONS

The EUT was programmed to be in continuously transmitting mode.

4.2.6 EUT TEST CONDITIONS

Temperature: 28°C Relative Humidity: 55% Test Voltage: AC 120V/60Hz

4.2.7 TEST RESULTS (9KHZ TO 30MHZ)

Please refer to the Attachment B

Remark:

- (1) The amplitude of spurious emissions which are attenuated by more than 20 dB below the permissible value has no need to be reported.
- (2) Distance extrapolation factor = $40 \log(\text{specific distance} / \text{test distance})$ (dB).
- (3) Limit line = specific limits (dBuV) + distance extrapolation factor.

4.2.8 TEST RESULTS (30MHZ TO 1000 MHZ)

Please refer to the Attachment C.

4.2.9 TEST RESULTS (ABOVE 1000 MHZ)

Please refer to the Attachment D.

Remark:

- (1) No limit: This is fundamental signal, the judgment is not applicable.
For fundamental signal judgment was referred to Peak output test.

5. BANDWIDTH TEST

5.1 APPLIED PROCEDURES

FCC Part15 (15.247) , Subpart C			
Section	Test Item	Frequency Range (MHz)	Result
15.247(a)(2)	Bandwidth	2400-2483.5	PASS

5.1.1 TEST PROCEDURE

- a. The EUT was directly connected to the spectrum analyzer and antenna output port as show in the block diagram below,
- b. Spectrum Setting: RBW= 100KHz, VBW=300KHz, Sweep time = 2.5 ms.

5.1.2 DEVIATION FROM STANDARD

No deviation.

5.1.3 TEST SETUP



5.1.4 EUT OPERATION CONDITIONS

The EUT was programmed to be in continuously transmitting mode.

5.1.5 EUT TEST CONDITIONS

Temperature: 28°C Relative Humidity: 55% Test Voltage: AC 120V/60Hz

5.1.6 TEST RESULTS

Please refer to the Attachment E.

6. MAXIMUM PEAK CONDUCTED OUTPUT POWER TEST

6.1 APPLIED PROCEDURES / LIMIT

FCC Part15 (15.247) , Subpart C				
Section	Test Item	Limit	Frequency Range (MHz)	Result
15.247(b)(3)	Maximum Output Power	1 Watt or 30dBm	2400-2483.5	PASS

6.1.1 TEST PROCEDURE

- a. The EUT was directly connected to the power meter and antenna output port as show in the block diagram below,
- b. The maximum peak conducted output power was performed in accordance with method 9.1.2 of FCC KDB 558074 D01 DTS Meas Guidance v03r03.

6.1.2 DEVIATION FROM STANDARD

No deviation.

6.1.3 TEST SETUP



6.1.4 EUT OPERATION CONDITIONS

The EUT was programmed to be in continuously transmitting mode.

6.1.5 EUT TEST CONDITIONS

Temperature: 28°C Relative Humidity: 55% Test Voltage: AC 120V/60Hz

6.1.6 TEST RESULTS

Please refer to the Attachment F.

7. ANTENNA CONDUCTED SPURIOUS EMISSION

7.1 APPLIED PROCEDURES / LIMIT

In any 100 kHz bandwidth outside the frequency band in which the spread spectrum or digitally modulated device is operating, the RF power that is produced shall be at least 20 dB below that in the 100 kHz bandwidth within the band that contains the highest level of the desired power, based on either an RF conducted or a radiated measurement, provided that the transmitter demonstrates compliance with the peak conducted power limits.

7.1.1 TEST PROCEDURE

- a. The EUT was directly connected to the spectrum analyzer and antenna output port as show in the block diagram below,
- b. Spectrum Setting: RBW= 100KHz, VBW=300KHz, Sweep time = Auto.

7.1.2 DEVIATION FROM STANDARD

No deviation.

7.1.3 TEST SETUP



7.1.4 EUT OPERATION CONDITIONS

The EUT was programmed to be in continuously transmitting mode.

7.1.5 EUT TEST CONDITIONS

Temperature: 28°C Relative Humidity: 55% Test Voltage: AC 120V/60Hz

7.1.6 TEST RESULTS

Please refer to the Attachment G.

8. POWER SPECTRAL DENSITY TEST

8.1 APPLIED PROCEDURES / LIMIT

FCC Part15 (15.247) , Subpart C				
Section	Test Item	Limit	Frequency Range (MHz)	Result
15.247(e)	Power Spectral Density	8 dBm (in any 3KHz)	2400-2483.5	PASS

8.1.1 TEST PROCEDURE

- a. The EUT was directly connected to the spectrum analyzer and antenna output port as show in the block diagram below,
- b. Spectrum Setting: RBW=3KHz, VBW=10KHz, Sweep time = Auto.

8.1.2 DEVIATION FROM STANDARD

No deviation.

8.1.3 TEST SETUP



8.1.4 EUT OPERATION CONDITIONS

The EUT was programmed to be in continuously transmitting mode.

8.1.5 EUT TEST CONDITIONS

Temperature: 28°C Relative Humidity: 55% Test Voltage: AC 120V/60Hz

8.1.6 TEST RESULTS

Please refer to the Attachment H.

9. MEASUREMENT INSTRUMENTS LIST

Conducted Emission Measurement					
Item	Kind of Equipment	Manufacturer	Type No.	Serial No.	Calibrated until
1	LISN	EMCO	3816/2	00052765	Mar. 28, 2016
2	LISN	R&S	ENV216	101447	Mar. 28, 2016
3	Test Cable	emci	RG223(9KHz-30MHz)	C_17	Mar. 13, 2016
4	EMI Test Receiver	R&S	ESCS30	826547/022	Mar. 28, 2016
5	50Ω Terminator	SHX	TF2-3G-A	08122902	Mar. 28, 2016
6	Measurement Software	Farad	EZ-EMC Ver.NB-03A1-01	N/A	N/A

Radiated Emission Measurement					
Item	Kind of Equipment	Manufacturer	Type No.	Serial No.	Calibrated until
1	Antenna	Schwarzbeck	VULB9160	9160-3232	Mar. 28, 2016
2	Amplifier	HP	8447D	2944A09673	Nov. 17, 2015
3	Test Cable	emci	LMR-400(30MHz-1GHz)	C-01	Jun. 28, 2016
4	Antenna	ETS	3115	00075789	Mar. 28, 2016
5	Amplifier	Agilent	8449B	3008A02274	Nov. 02, 2015
6	Test Cable	emci	EMC104-SM-SM-10000(1GHz-26.5GHz)	C-68	Jun. 28, 2016
7	Broad-Band Horn Antenna	Schwarzbeck	BBHA 9170	9170319	Mar. 28, 2016
8	Microwave Pre-amplifier With Adaptor	EMC INSTRUMENT	EMC2654045	980039 & HA01	Mar. 28, 2016
9	Active Loop Antenna	R&S	HFH2-Z2	830749/020	Aug. 16, 2015
10	Measurement Software	Farad	EZ-EMC Ver.NB-03A1-01	N/A	N/A

6dB Bandwidth Measurement					
Item	Kind of Equipment	Manufacturer	Type No.	Serial No.	Calibrated until
1	Spectrum Analyzer	R&S	FSP 40	100185	Nov. 02, 2015

Peak Output Power Measurement					
Item	Kind of Equipment	Manufacturer	Type No.	Serial No.	Calibrated until
1	P-series Power meter	Agilent	N1911A	MY45100473	Mar. 28, 2016
2	Wireband Power sensor	Agilent	N1921A	MY51100041	Mar. 28, 2016

Antenna Conducted Spurious Emission Measurement					
Item	Kind of Equipment	Manufacturer	Type No.	Serial No.	Calibrated until
1	Spectrum Analyzer	R&S	FSP 40	100185	Nov. 02, 2015

Power Spectral Density Measurement					
Item	Kind of Equipment	Manufacturer	Type No.	Serial No.	Calibrated until
1	Spectrum Analyzer	R&S	FSP 40	100185	Nov. 02, 2015

Remark: "N/A" denotes no model name, serial no. or calibration specified.
 All calibration period of equipment list is one year.

10. EUT TEST PHOTO

Conducted Measurement Photos



Radiated Measurement Photos

9KHz to 30MHz



Radiated Measurement Photos

30MHz to 1000MHz

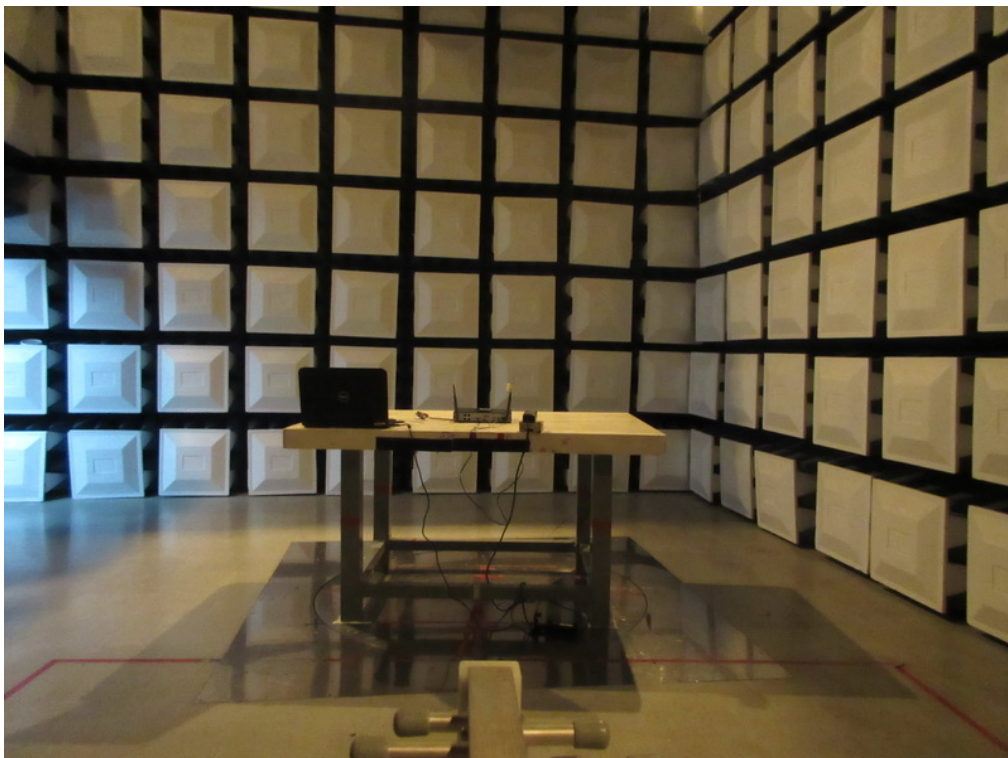

Radiated Measurement Photos

Above 1000MHz

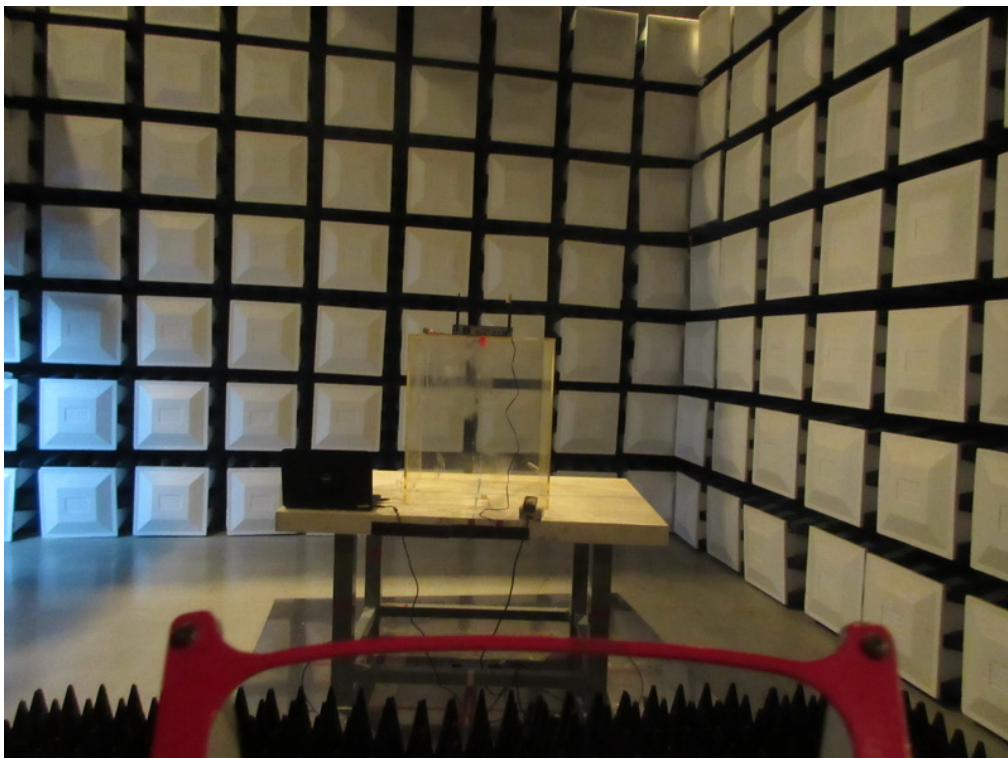

ATTACHMENT A - CONDUCTED EMISSION

Test Mode : TX MODE

Line

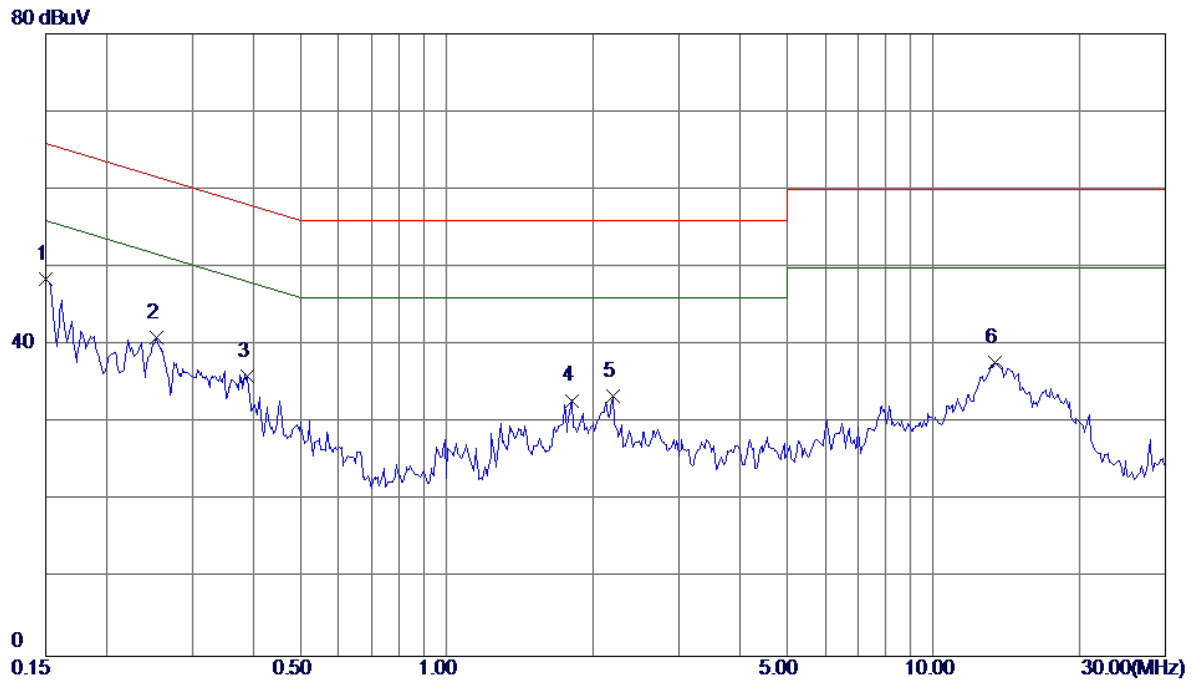

No.	Freq. MHz	Reading Level dBuV	Correct Factor dB	Measure ment dBuV	Limit dBuV	Over dB	Detector	Comment
1	0.1500	38.93	9.51	48.44	66.00	-17.56	Peak	
2	0.2534	31.39	9.57	40.96	61.64	-20.68	Peak	
3	0.3891	26.39	9.64	36.03	58.08	-22.05	Peak	
4	1.8062	23.17	9.71	32.88	56.00	-23.12	Peak	
5	2.2006	23.72	9.72	33.44	56.00	-22.56	Peak	
6	13.3750	27.55	10.18	37.73	60.00	-22.27	Peak	

Test Mode : TX MODE

Neutral

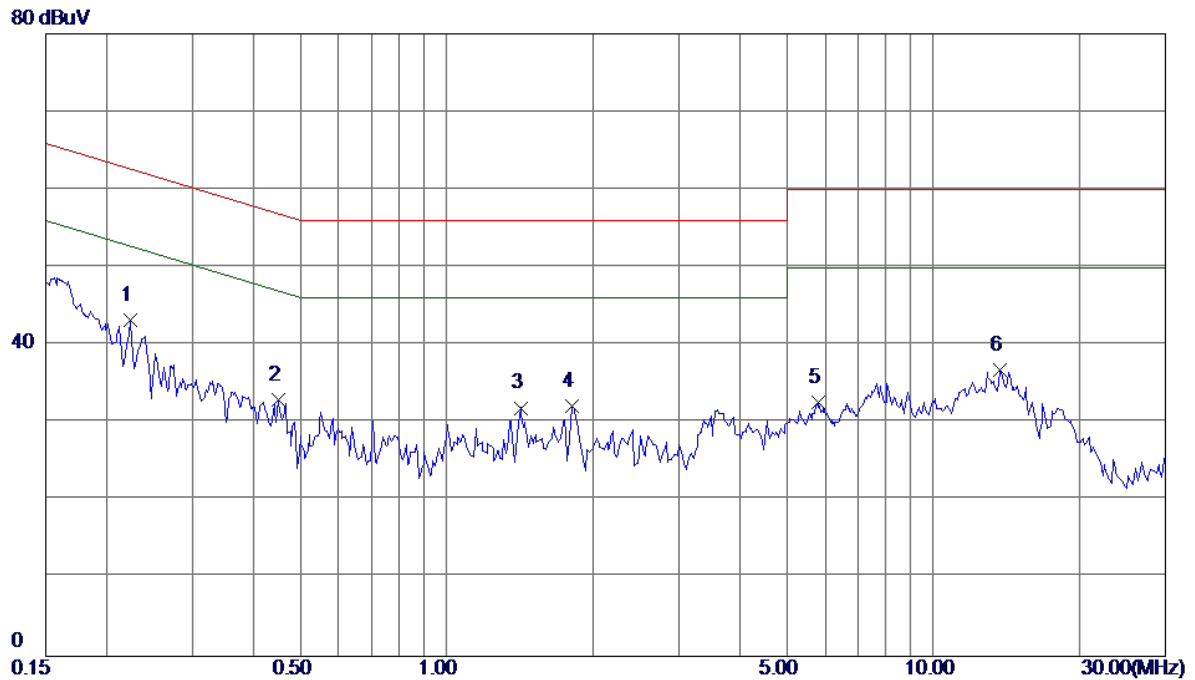

No.	Freq. MHz	Reading Level dBuV	Correct Factor dB	Measure ment dBuV	Limit dBuV	Over dB	Detector	Comment
1	0.2242	33.62	9.61	43.23	62.66	-19.43	Peak	
2	0.4506	23.33	9.63	32.96	56.86	-23.90	Peak	
3	1.4193	22.22	9.70	31.92	56.00	-24.08	Peak	
4	1.8101	22.48	9.73	32.21	56.00	-23.79	Peak	
5	5.7890	22.73	9.91	32.64	60.00	-27.36	Peak	
6	13.7382	26.50	10.24	36.74	60.00	-23.26	Peak	

ATTACHMENT B - RADIATED EMISSION (9KHZ TO 30MHZ)

Test Mode:	TX MODE
------------	---------

Frequency (MHz)	Ant 0°/90°	Read level dBuV/m	Factor (dB)	Measured(FS) (dBuV/m)	Limit (dBuV/m)	Margin (dB)	Note
0.0204	0°	9.13	24.2747	33.4047	121.4116	-88.0070	AVG
0.0204	0°	10.1	24.2747	34.3747	141.4116	-107.0370	PEAK
0.0281	0°	7.27	23.7870	31.0570	118.6301	-87.5731	AVG
0.0281	0°	8.52	23.7870	32.3070	138.6301	-106.3231	PEAK
0.0411	0°	4.13	22.9637	27.0937	115.3274	-88.2337	AVG
0.0411	0°	5.1	22.9637	28.0637	135.3274	-107.2637	PEAK
0.0478	0°	1.24	22.5393	23.7793	114.0157	-90.2363	AVG
0.0478	0°	1.76	22.5393	24.2993	134.0157	-109.7163	PEAK
1.2183	0°	17.51	19.5782	37.0882	65.8891	-28.8010	QP
2.574	0°	24.66	19.1556	43.8156	69.5400	-25.7244	QP

Frequency (MHz)	Ant 0°/90°	Read level dBuV/m	Factor (dB)	Measured(FS) (dBuV/m)	Limit (dBuV/m)	Margin (dB)	Note
0.0161	90°	7.76	24.3000	32.0600	123.4677	-91.4077	AVG
0.0161	90°	8.3	24.3000	32.6000	143.4677	-110.8677	PEAK
0.0253	90°	3.75	23.9643	27.7143	119.5418	-91.8275	AVG
0.0253	90°	4.38	23.9643	28.3443	139.5418	-111.1975	PEAK
0.0317	90°	1.31	23.5590	24.8690	117.5830	-92.7140	AVG
0.0317	90°	1.71	23.5590	25.2690	137.5830	-112.3140	PEAK
0.0472	90°	0.57	22.5773	23.1473	114.1254	-90.9781	AVG
0.0472	90°	0.86	22.5773	23.4373	134.1254	-110.6881	PEAK
0.713	90°	16.31	20.4816	36.7916	70.5424	-33.7508	QP
2.4724	90°	22.1	19.2166	41.3166	69.5400	-28.2234	QP

ATTACHMENT C - RADIATED EMISSION (30MHZ TO 1000MHZ)

Test Mode: TX B MODE CHANNEL 01

Vertical

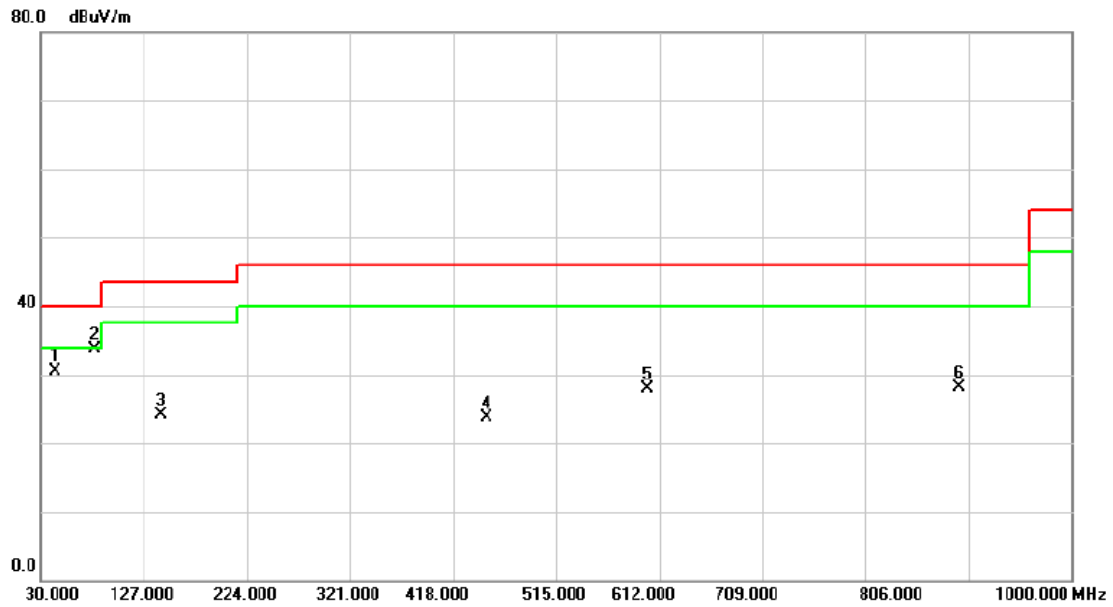

No.	Mk.	Freq. MHz	Reading Level dBuV	Correct Factor dB	Measure- ment dBuV/m	Limit dBuV/m	Over dB	Detector	Comment
1		43.5800	45.82	-15.23	30.59	40.00	-9.41	peak	
2	*	81.4100	49.84	-16.13	33.71	40.00	-6.29	peak	
3		143.4900	38.01	-13.89	24.12	43.50	-19.38	peak	
4		450.0100	33.15	-9.35	23.80	46.00	-22.20	peak	
5		600.3600	34.71	-6.75	27.96	46.00	-18.04	peak	
6		894.2700	30.58	-2.53	28.05	46.00	-17.95	peak	

Test Mode: TX B MODE CHANNEL 01

Horizontal

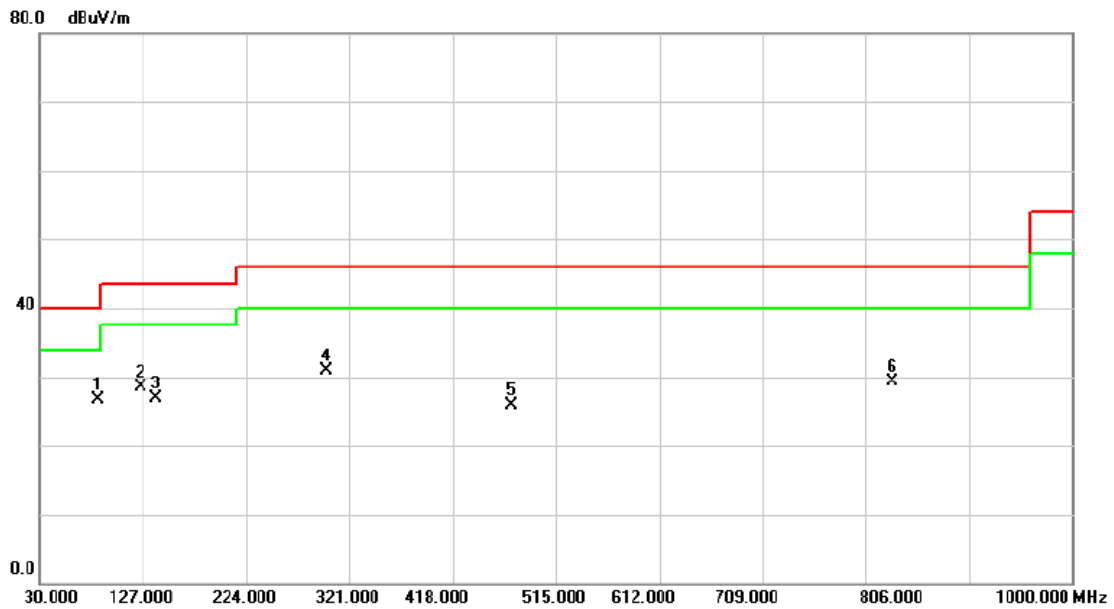

No.	Mk.	Freq. MHz	Reading Level dBuV	Correct Factor dB	Measure- ment dBuV/m	Limit dBuV/m	Over dB	Detector	Comment
1	*	85.2900	43.28	-16.50	26.78	40.00	-13.22	peak	
2		125.0600	42.49	-13.94	28.55	43.50	-14.95	peak	
3		139.6100	40.87	-13.96	26.91	43.50	-16.59	peak	
4		299.6600	41.80	-10.85	30.95	46.00	-15.05	peak	
5		473.2900	35.38	-9.55	25.83	46.00	-20.17	peak	
6		831.2200	32.73	-3.45	29.28	46.00	-16.72	peak	

Test Mode: TX B MODE CHANNEL 06

Vertical

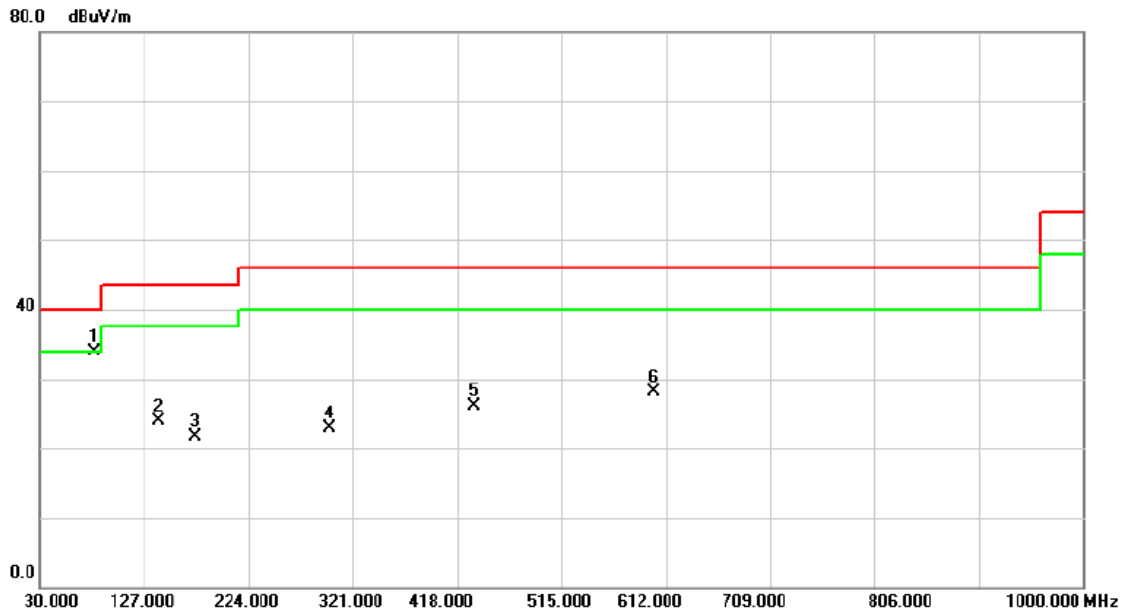

No.	Mk.	Freq. MHz	Reading Level dBuV	Correct Factor dB	Measure- ment dBuV/m	Limit dBuV/m	Over dB	Detector	Comment
1	*	81.4100	50.08	-16.13	33.95	40.00	-6.05	peak	
2		140.5800	37.95	-13.97	23.98	43.50	-19.52	peak	
3		174.5300	34.54	-12.82	21.72	43.50	-21.78	peak	
4		299.6600	33.72	-10.85	22.87	46.00	-23.13	peak	
5		433.5200	35.92	-9.83	26.09	46.00	-19.91	peak	
6		600.3600	34.77	-6.75	28.02	46.00	-17.98	peak	

Test Mode: TX B MODE CHANNEL 06

Horizontal

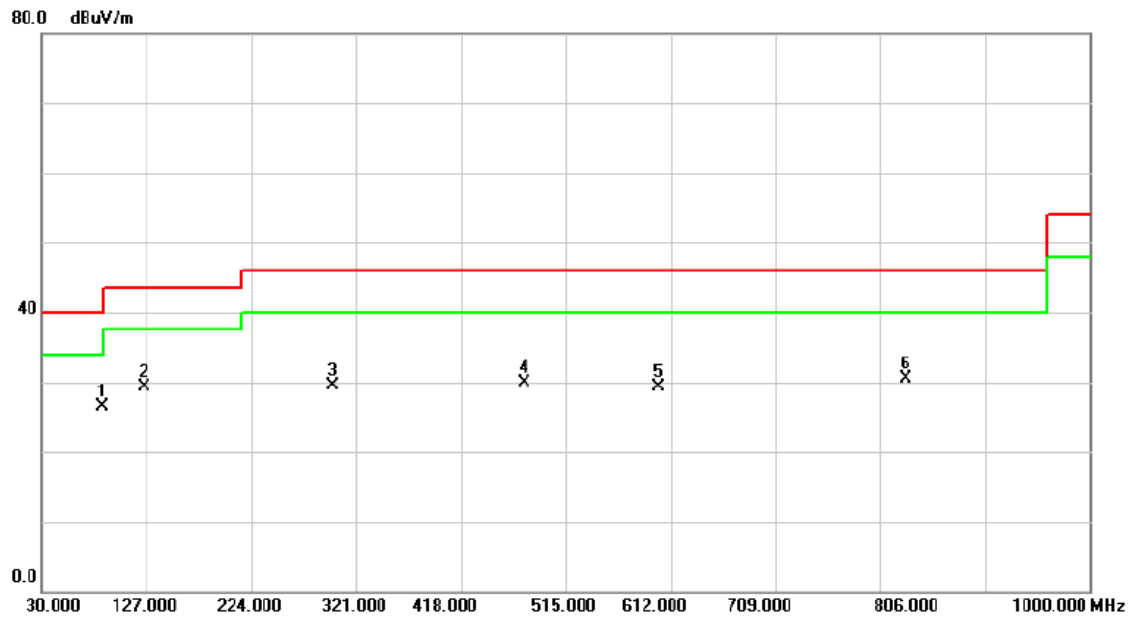

No.	Mk.	Freq. MHz	Reading Level dBuV	Correct Factor dB	Measure- ment dBuV/m	Limit dBuV/m	Over dB	Detector	Comment
1	*	86.2600	43.14	-16.62	26.52	40.00	-13.48	peak	
2		125.0600	43.32	-13.94	29.38	43.50	-14.12	peak	
3		299.6600	40.33	-10.85	29.48	46.00	-16.52	peak	
4		477.1700	39.51	-9.59	29.92	46.00	-16.08	peak	
5		600.3600	36.08	-6.75	29.33	46.00	-16.67	peak	
6		830.2500	33.97	-3.48	30.49	46.00	-15.51	peak	

Test Mode: TX B MODE CHANNEL 11

Vertical

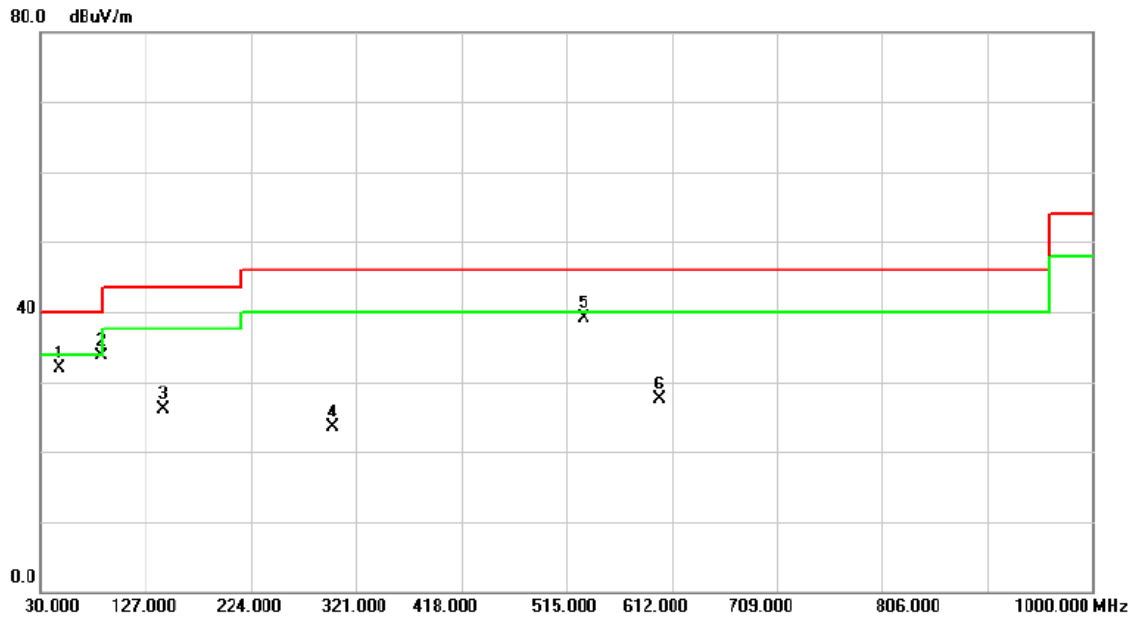

No.	Mk.	Freq. MHz	Reading Level dBuV	Correct Factor dB	Measure- ment dBuV/m	Limit dBuV/m	Over dB	Detector	Comment
1		47.4600	47.38	-15.45	31.93	40.00	-8.07	peak	
2	*	86.2600	50.41	-16.62	33.79	40.00	-6.21	peak	
3		142.5200	39.93	-13.91	26.02	43.50	-17.48	peak	
4		299.6600	34.31	-10.85	23.46	46.00	-22.54	peak	
5		531.4900	47.38	-8.25	39.13	46.00	-6.87	peak	
6		600.3600	34.31	-6.75	27.56	46.00	-18.44	peak	

Test Mode: TX B MODE CHANNEL 11

Horizontal

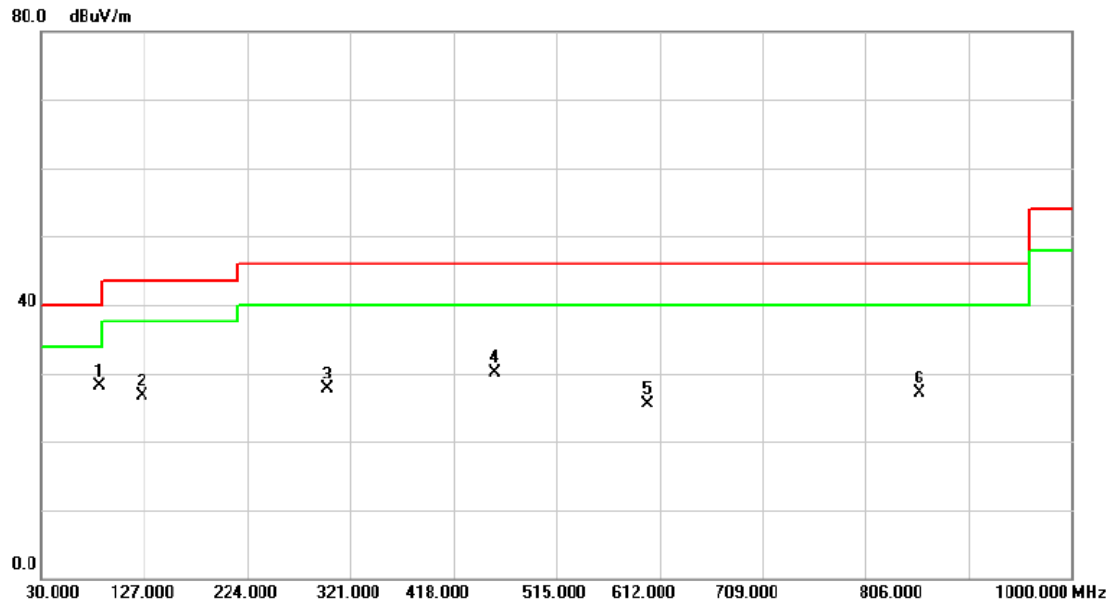

No.	Mk.	Freq. MHz	Reading Level dBuV	Correct Factor dB	Measure- ment dBuV/m	Limit dBuV/m	Over dB	Detector	Comment
1	*	85.2900	44.51	-16.50	28.01	40.00	-11.99	peak	
2		125.0600	40.72	-13.94	26.78	43.50	-16.72	peak	
3		299.6600	38.61	-10.85	27.76	46.00	-18.24	peak	
4		456.8000	39.51	-9.41	30.10	46.00	-15.90	peak	
5		600.3600	32.28	-6.75	25.53	46.00	-20.47	peak	
6		857.4100	30.08	-3.04	27.04	46.00	-18.96	peak	

ATTACHMENT D - RADIATED EMISSION (ABOVE 1000MHZ)

Orthogonal Axis :	X
Test Mode :	TX B MODE 2412MHz

Vertical

120 dBuV/m

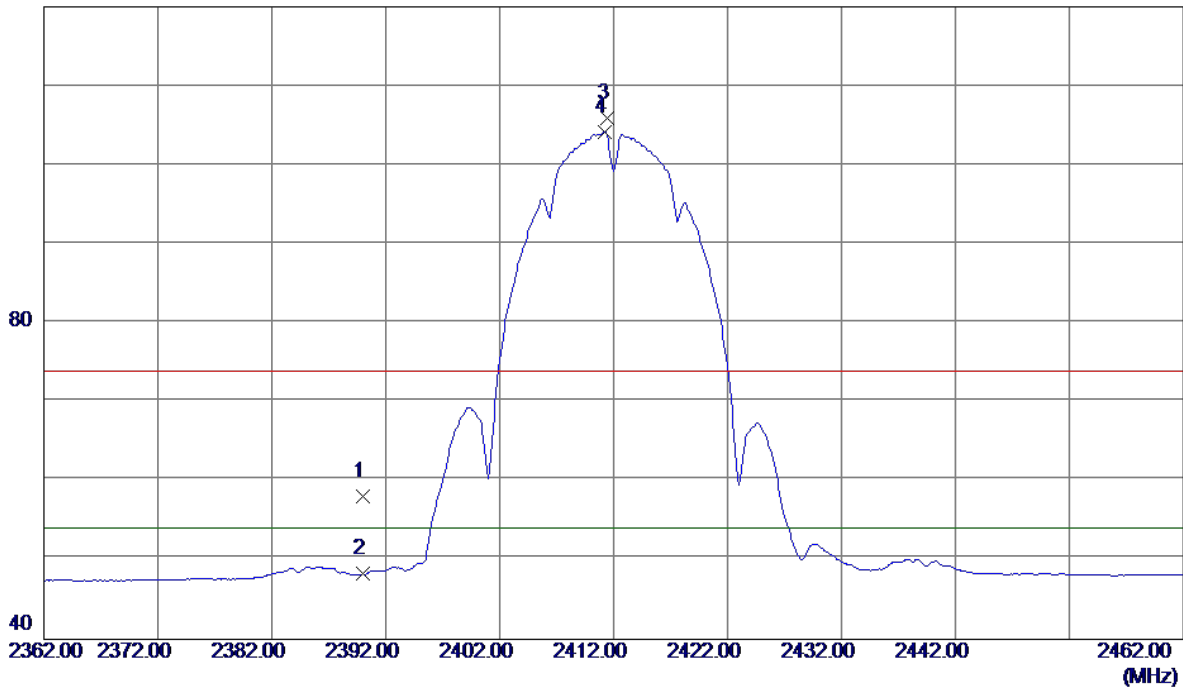

No.	Freq. MHz	Reading Level dBuV/m	Correct Factor dB	Measure ment dBuV/m	Limit dBuV/m	Over dB	Detector	Comment
1	2390.0000	24.70	33.38	58.08	74.00	-15.92	Peak	
2	2390.0000	14.88	33.38	48.26	54.00	-5.74	AVG	
3	2411.4650	72.53	33.44	105.97	74.00	31.97	Peak	NO LIMIT
4	2411.2000	70.69	33.44	104.13	54.00	50.13	AVG	NO LIMIT

Orthogonal Axis :	X
Test Mode :	TX B MODE 2412MHz

Vertical

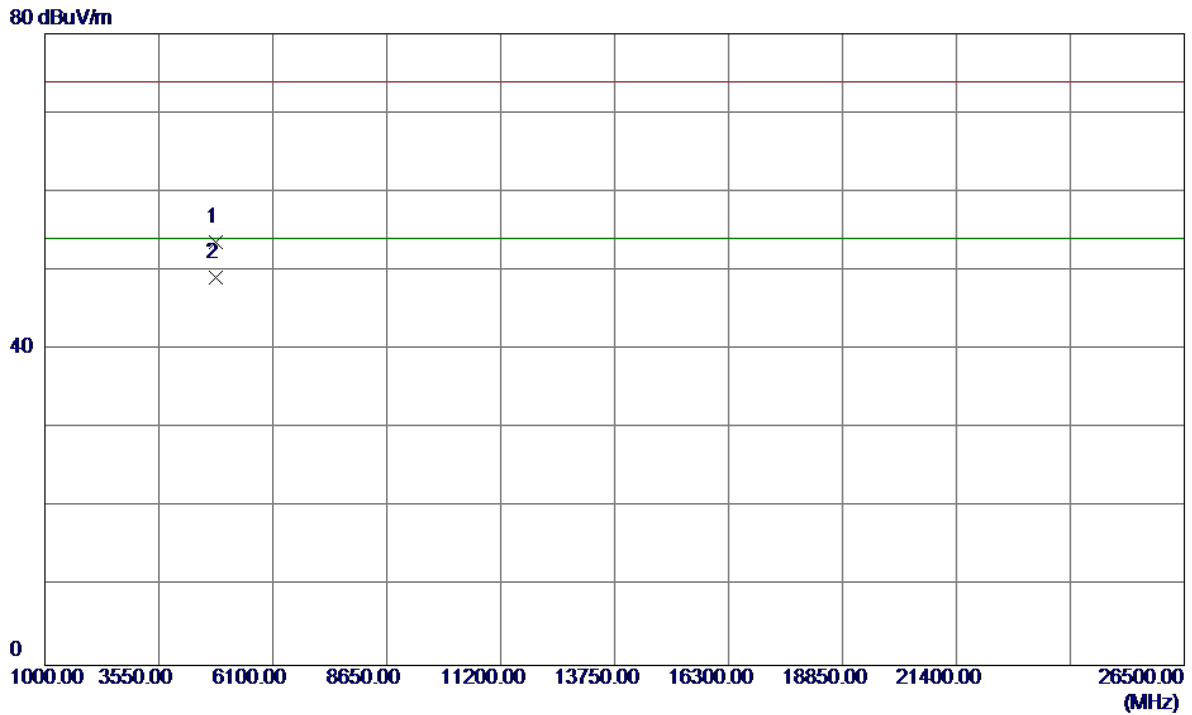

No.	Freq. MHz	Reading Level dBuV/m	Correct Factor dB	Measure ment dBuV/m	Limit dBuV/m	Over dB	Detector	Comment
1	4824.0299	47.12	6.43	53.55	74.00	-20.45	Peak	
2	4823.9320	42.66	6.43	49.09	54.00	-4.91	AVG	

Orthogonal Axis :	X
Test Mode :	TX B MODE 2412MHz

Horizontal

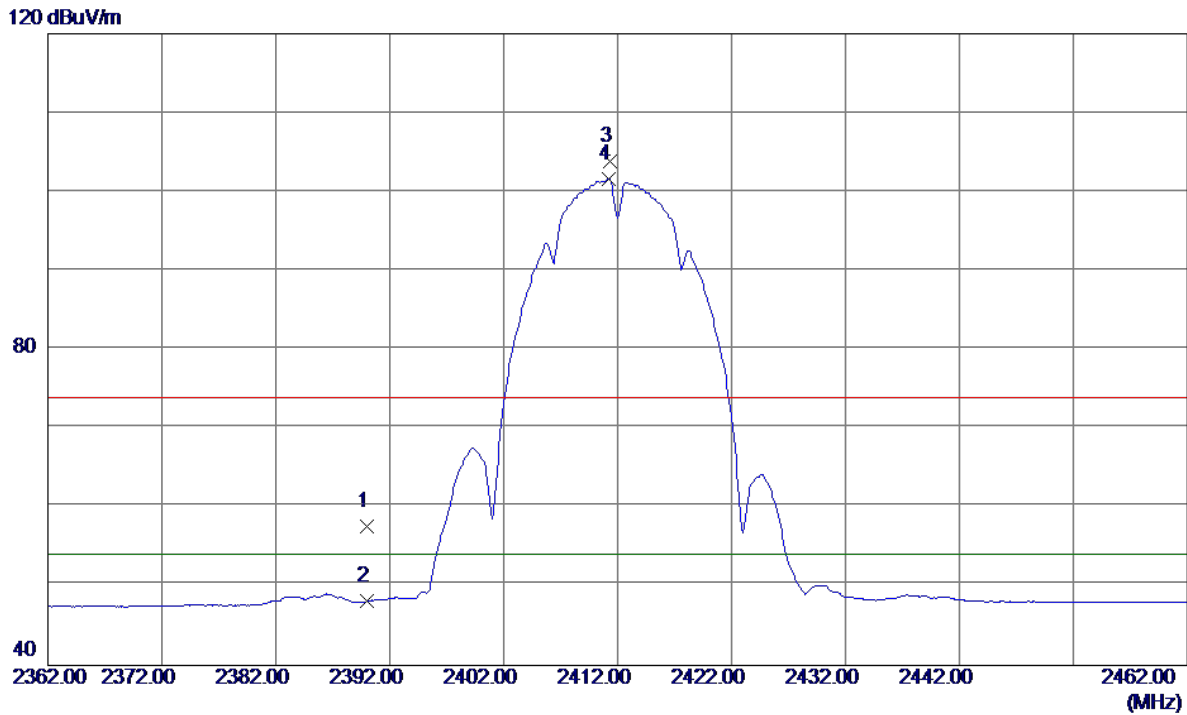

No.	Freq. MHz	Reading Level dBuV/m	Correct Factor dB	Measure ment dBuV/m	Limit dBuV/m	Over dB	Detector	Comment
1	2390.0000	24.25	33.38	57.63	74.00	-16.37	Peak	
2	2390.0000	14.75	33.38	48.13	54.00	-5.87	AVG	
3	2411.3410	70.42	33.44	103.86	74.00	29.86	Peak	NO LIMIT
4	2411.2000	68.17	33.44	101.61	54.00	47.61	AVG	NO LIMIT

Orthogonal Axis :	X
Test Mode :	TX B MODE 2412MHz

Horizontal

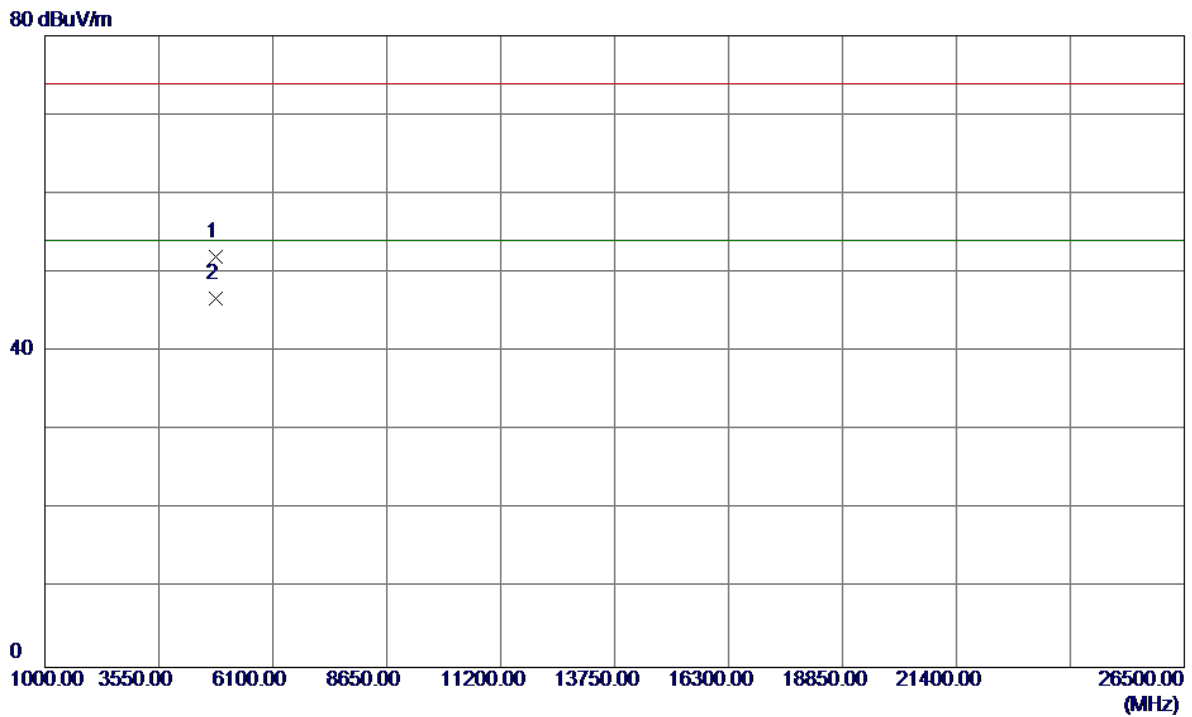

No.	Freq. MHz	Reading Level dBuV/m	Correct Factor dB	Measure ment dBuV/m	Limit dBuV/m	Over dB	Detector	Comment
1	4823.9400	45.50	6.43	51.93	74.00	-22.07	Peak	
2	4823.9750	40.25	6.43	46.68	54.00	-7.32	AVG	

Orthogonal Axis :	X
Test Mode :	TX B MODE 2437MHz

Vertical

120 dBuV/m

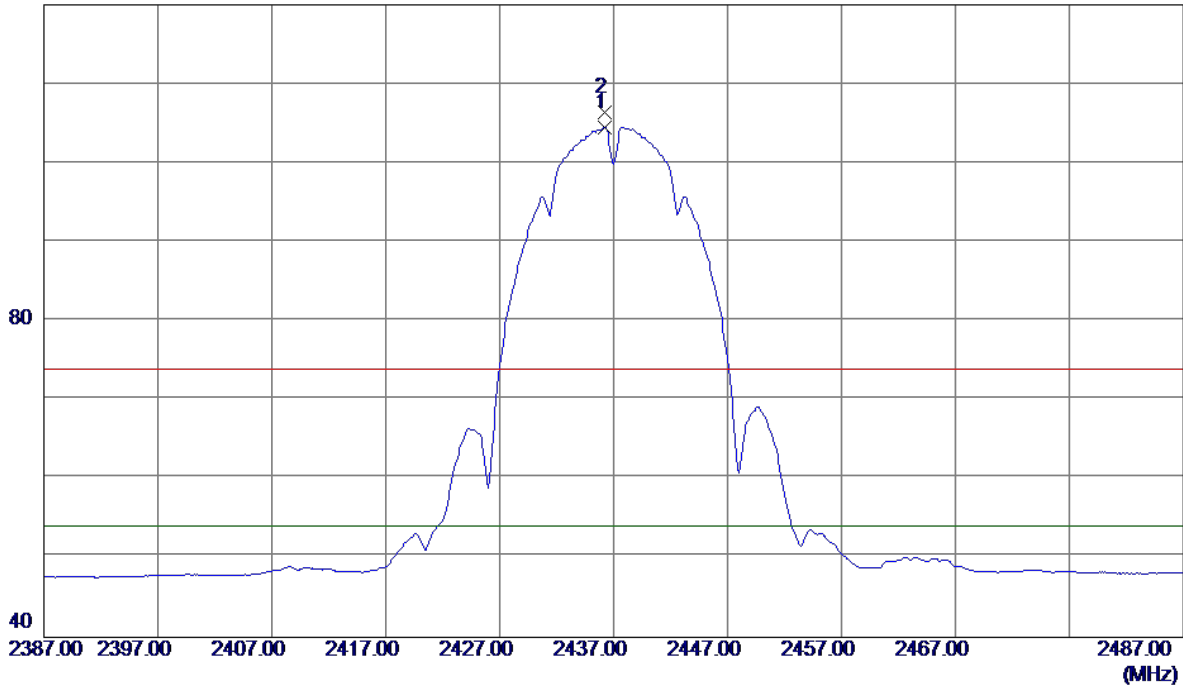

No.	Freq. MHz	Reading Level dBuV/m	Correct Factor dB	Measure ment dBuV/m	Limit dBuV/m	Over dB	Detector	Comment
1	2436.2000	71.00	33.50	104.50	54.00	50.50	AVG	NO LIMIT
2	2436.2310	72.90	33.50	106.40	74.00	32.40	Peak	NO LIMIT

Orthogonal Axis :	X
Test Mode :	TX B MODE 2437MHz

Vertical

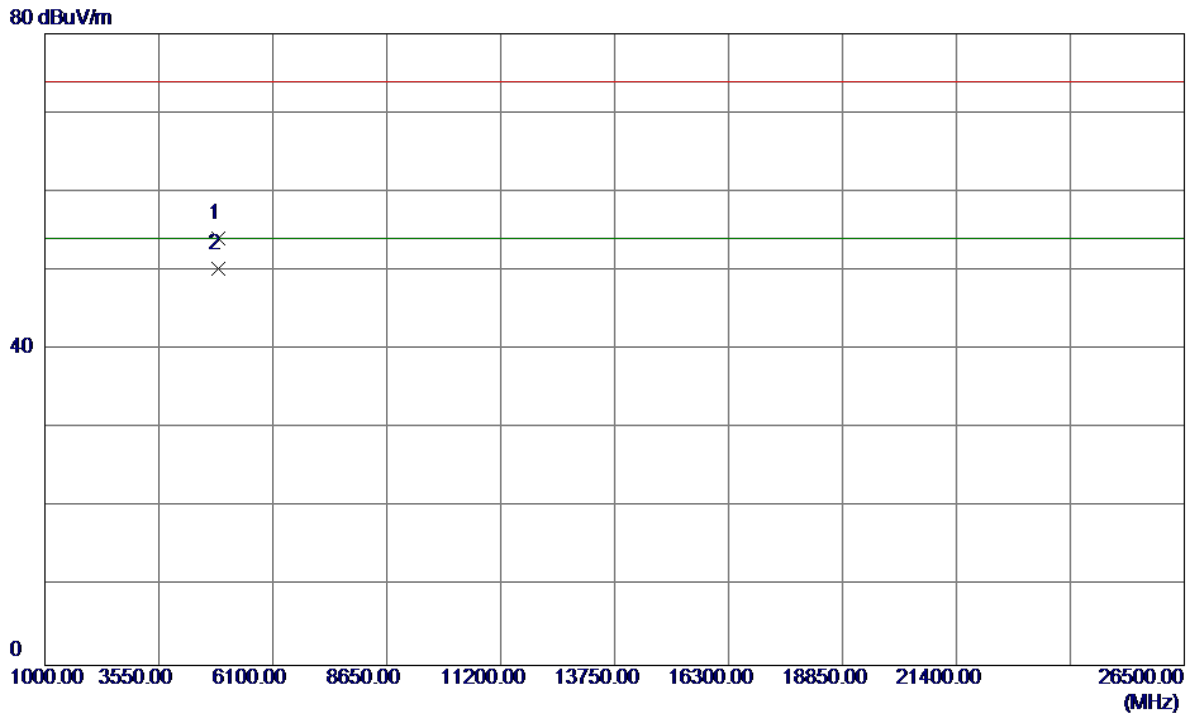

No.	Freq. MHz	Reading Level dBuV/m	Correct Factor dB	Measure ment dBuV/m	Limit dBuV/m	Over dB	Detector	Comment
1	4873.9900	47.49	6.55	54.04	74.00	-19.96	Peak	
2	4873.9800	43.68	6.55	50.23	54.00	-3.77	AVG	

Orthogonal Axis :	X
Test Mode :	TX B MODE 2437MHz

Horizontal

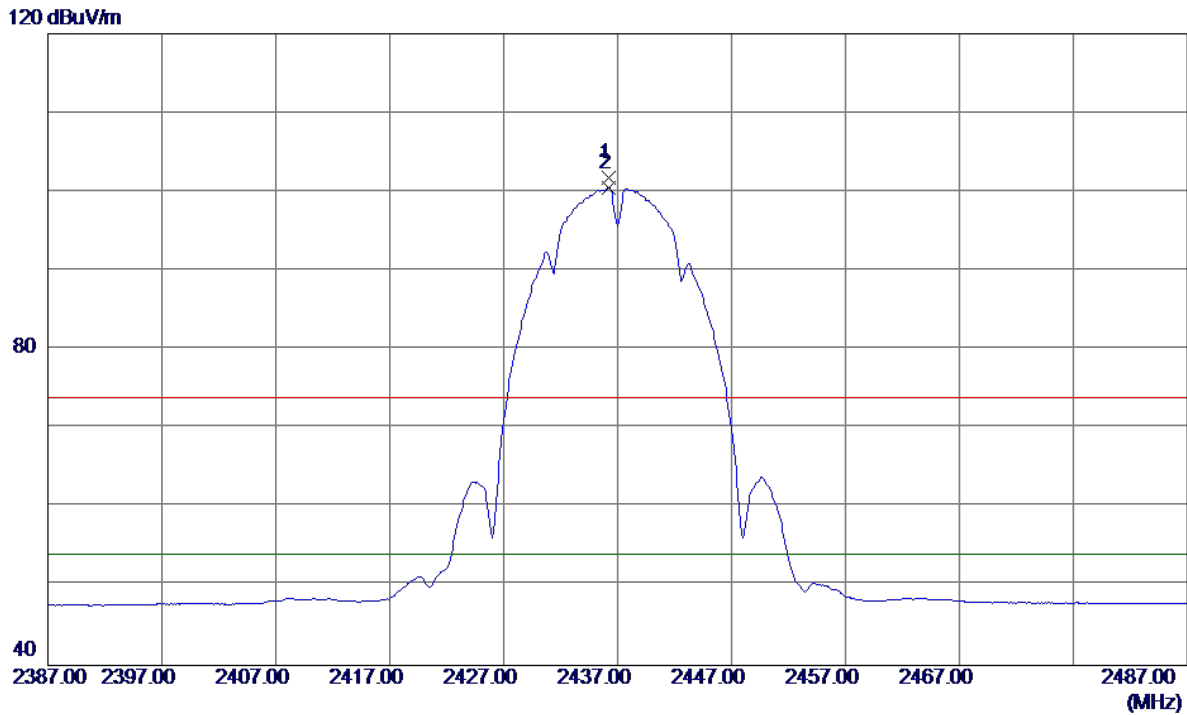

No.	Freq. MHz	Reading Level dBuV/m	Correct Factor dB	Measure ment dBuV/m	Limit dBuV/m	Over dB	Detector	Comment
1	2436.2560	68.27	33.50	101.77	74.00	27.77	Peak	NO LIMIT
2	2436.2000	66.98	33.50	100.48	54.00	46.48	AVG	NO LIMIT

Orthogonal Axis :	X
Test Mode :	TX B MODE 2437MHz

Horizontal

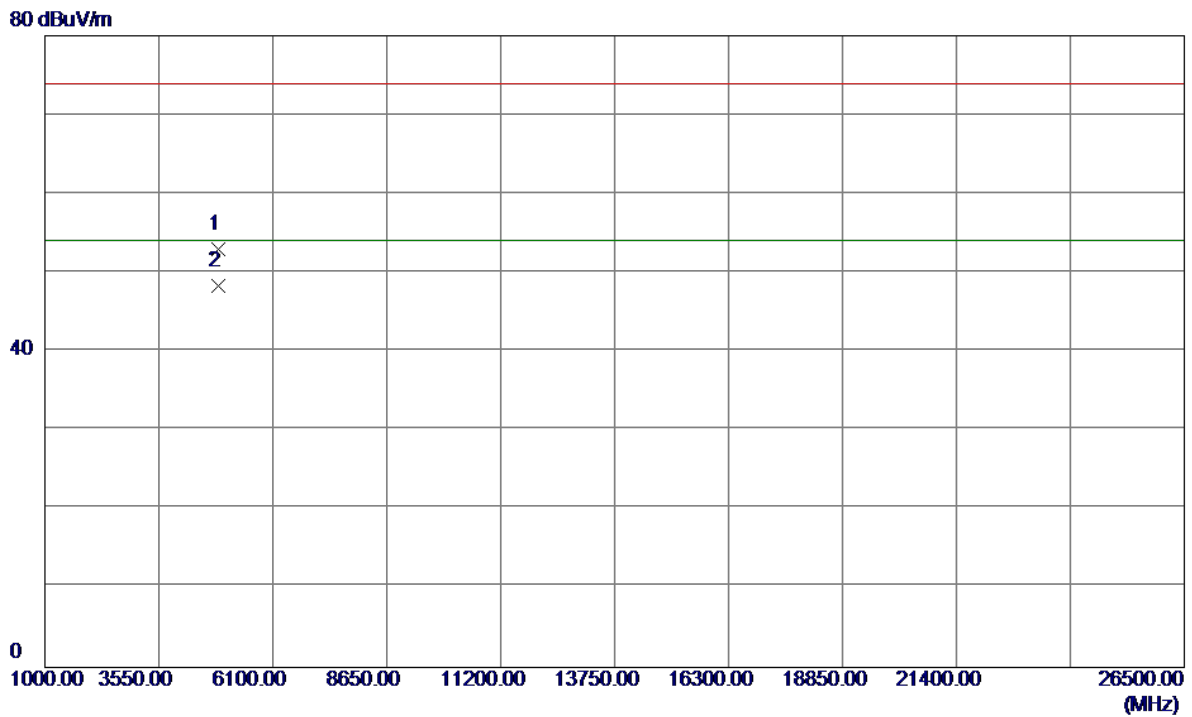

No.	Freq. MHz	Reading Level dBuV/m	Correct Factor dB	Measure ment dBuV/m	Limit dBuV/m	Over dB	Detector	Comment
1	4873.9900	46.38	6.55	52.93	74.00	-21.07	Peak	
2	4873.9600	41.84	6.55	48.39	54.00	-5.61	AVG	

Orthogonal Axis :	X
Test Mode :	TX B MODE 2462MHz

Vertical

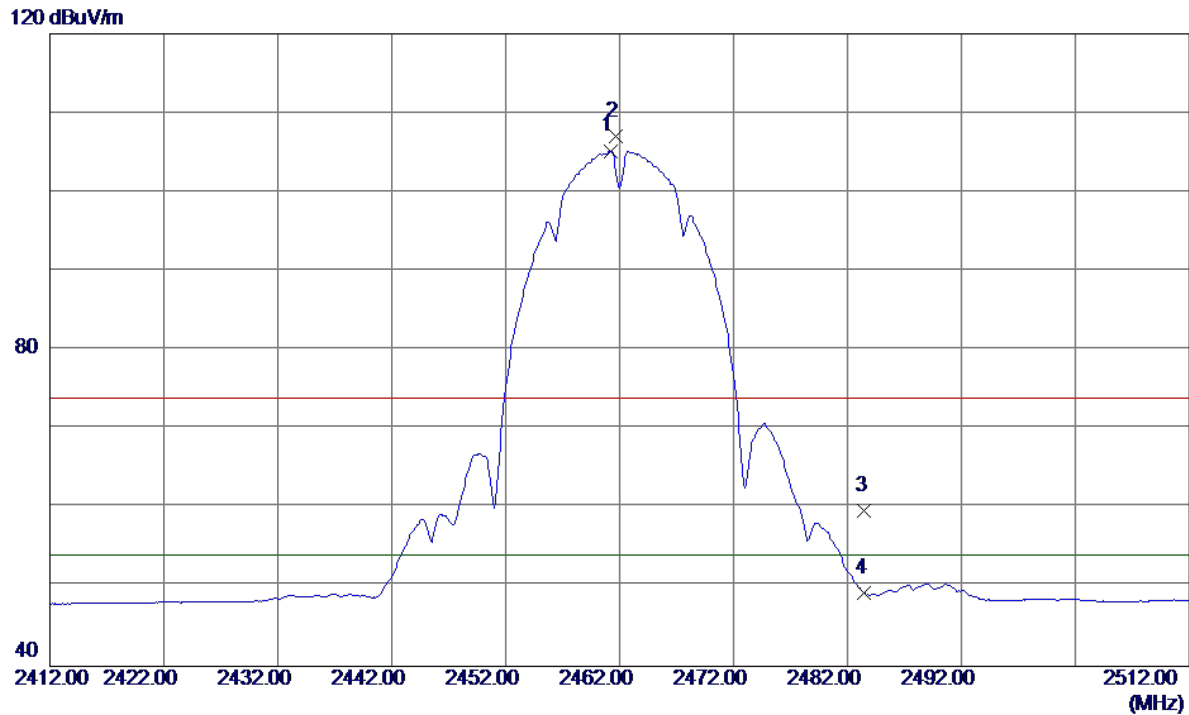

No.	Freq. MHz	Reading Level dBuV/m	Correct Factor dB	Measure ment dBuV/m	Limit dBuV/m	Over dB	Detector	Comment
1	2461.2000	71.64	33.56	105.20	54.00	51.20	AVG	NO LIMIT
2	2461.7000	73.52	33.56	107.08	74.00	33.08	Peak	NO LIMIT
3	2483.5000	26.12	33.62	59.74	74.00	-14.26	Peak	
4	2483.5000	15.62	33.62	49.24	54.00	-4.76	AVG	

Orthogonal Axis :	X
Test Mode :	TX B MODE 2462MHz

Vertical

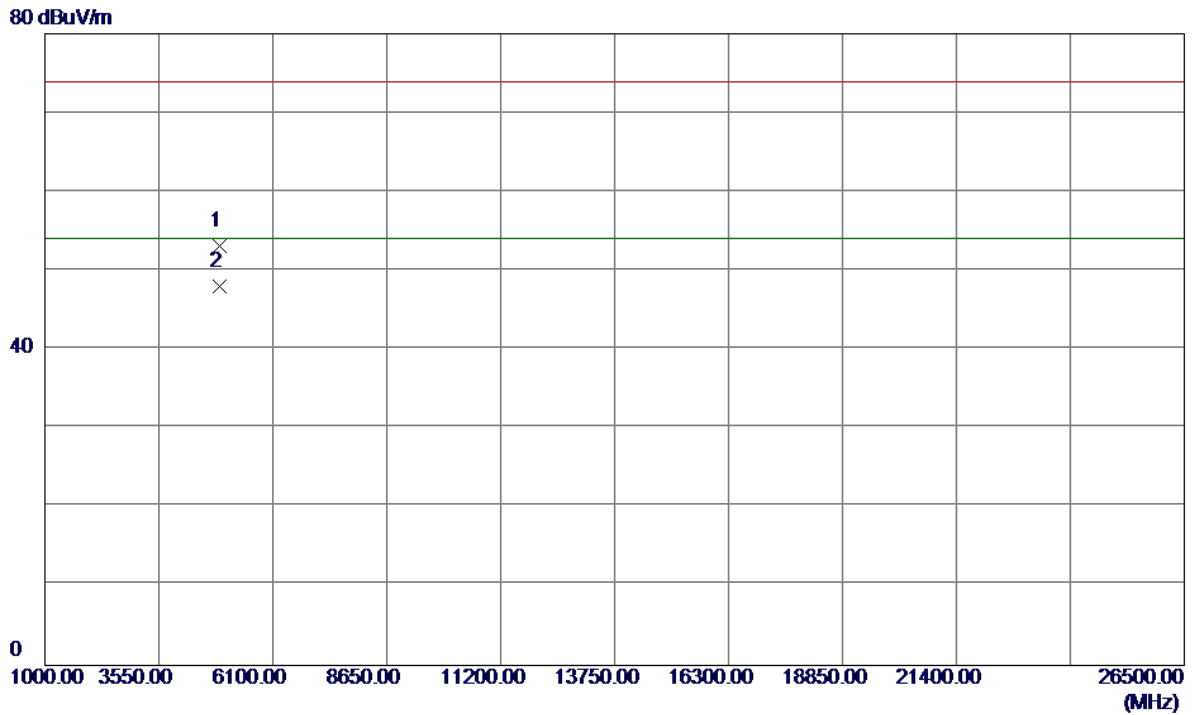

No.	Freq. MHz	Reading Level dBuV/m	Correct Factor dB	Measure ment dBuV/m	Limit dBuV/m	Over dB	Detector	Comment
1	4923.6210	46.47	6.66	53.13	74.00	-20.87	Peak	
2	4923.9700	41.39	6.66	48.05	54.00	-5.95	AVG	

Orthogonal Axis :	X
Test Mode :	TX B MODE 2462MHz

Horizontal

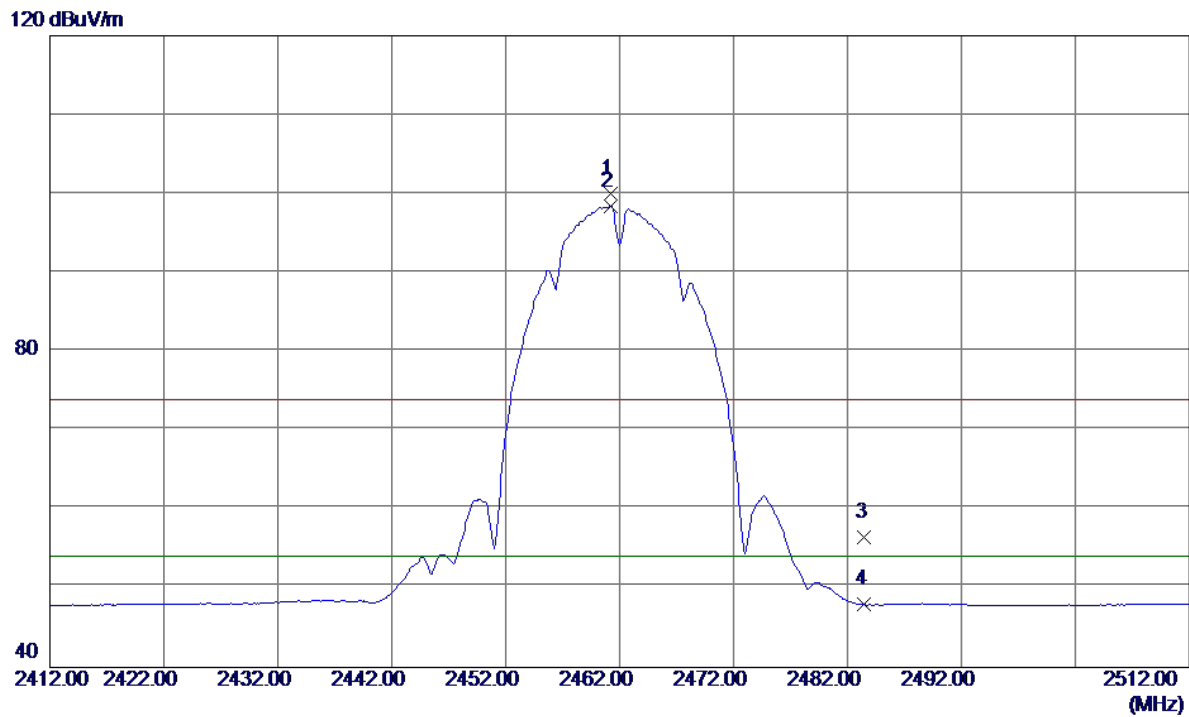

No.	Freq. MHz	Reading Level dBuV/m	Correct Factor dB	Measure ment dBuV/m	Limit dBuV/m	Over dB	Detector	Comment
1	2461.2709	66.48	33.56	100.04	74.00	26.04	Peak	NO LIMIT
2	2461.2000	64.86	33.56	98.42	54.00	44.42	AVG	NO LIMIT
3	2483.5000	22.81	33.62	56.43	74.00	-17.57	Peak	
4	2483.5000	14.31	33.62	47.93	54.00	-6.07	AVG	

Orthogonal Axis :	X
Test Mode :	TX B MODE 2462MHz

Horizontal

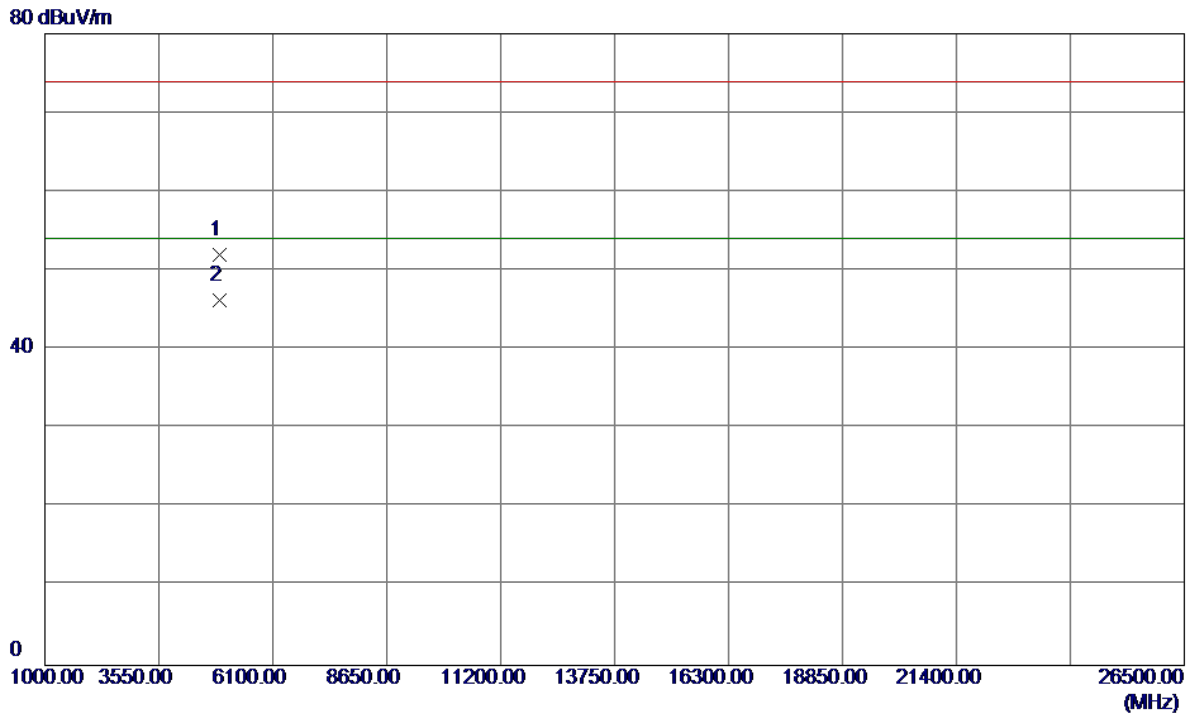

No.	Freq. MHz	Reading Level dBuV/m	Correct Factor dB	Measure ment dBuV/m	Limit dBuV/m	Over dB	Detector	Comment
1	4923.9800	45.27	6.66	51.93	74.00	-22.07	Peak	
2	4923.8700	39.59	6.66	46.25	54.00	-7.75	AVG	

Orthogonal Axis :	X
Test Mode :	TX G MODE 2412MHz

Vertical

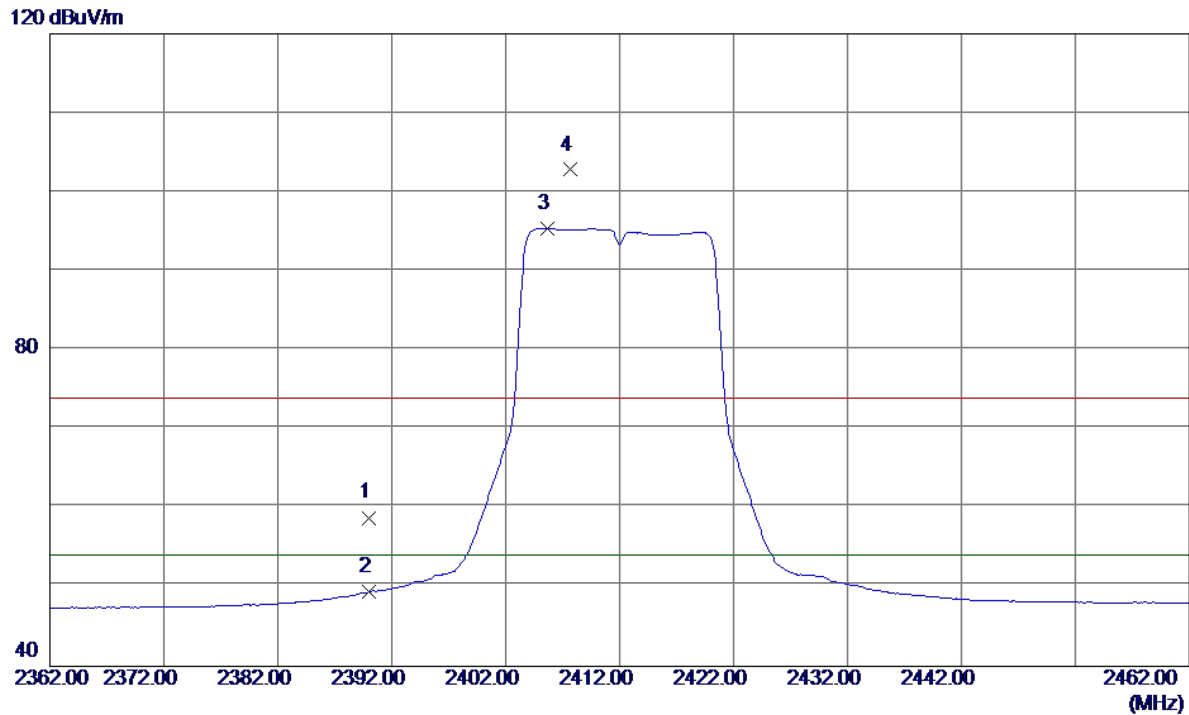

No.	Freq. MHz	Reading Level dBuV/m	Correct Factor dB	Measure ment dBuV/m	Limit dBuV/m	Over dB	Detector	Comment
1	2390.0000	25.42	33.38	58.80	74.00	-15.20	Peak	
2	2390.0000	16.02	33.38	49.40	54.00	-4.60	AVG	
3	2405.7000	61.94	33.42	95.36	54.00	41.36	AVG	NO LIMIT
4	2407.6830	69.37	33.43	102.80	74.00	28.80	Peak	NO LIMIT

Orthogonal Axis :	X
Test Mode :	TX G MODE 2412MHz

Vertical

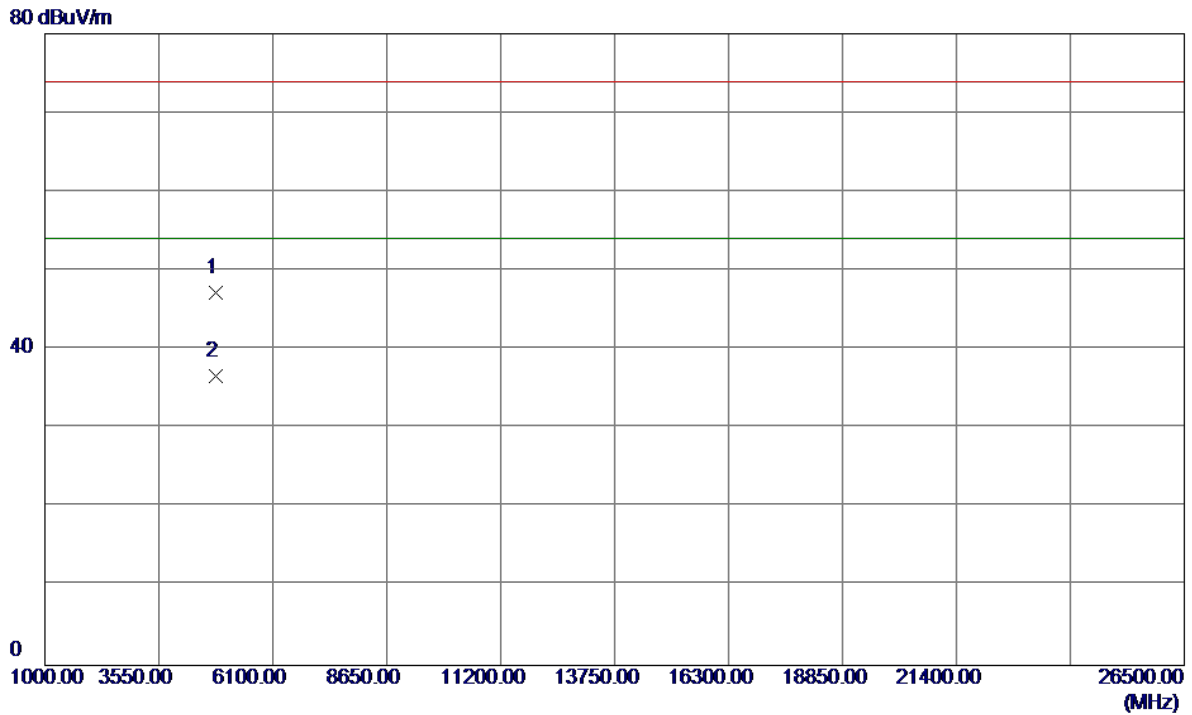

No.	Freq. MHz	Reading Level dBuV/m	Correct Factor dB	Measure ment dBuV/m	Limit dBuV/m	Over dB	Detector	Comment
1	4824.0000	40.75	6.43	47.18	74.00	-26.82	Peak	
2	4823.9900	30.27	6.43	36.70	54.00	-17.30	AVG	

Orthogonal Axis :	X
Test Mode :	TX G MODE 2412MHz

Horizontal

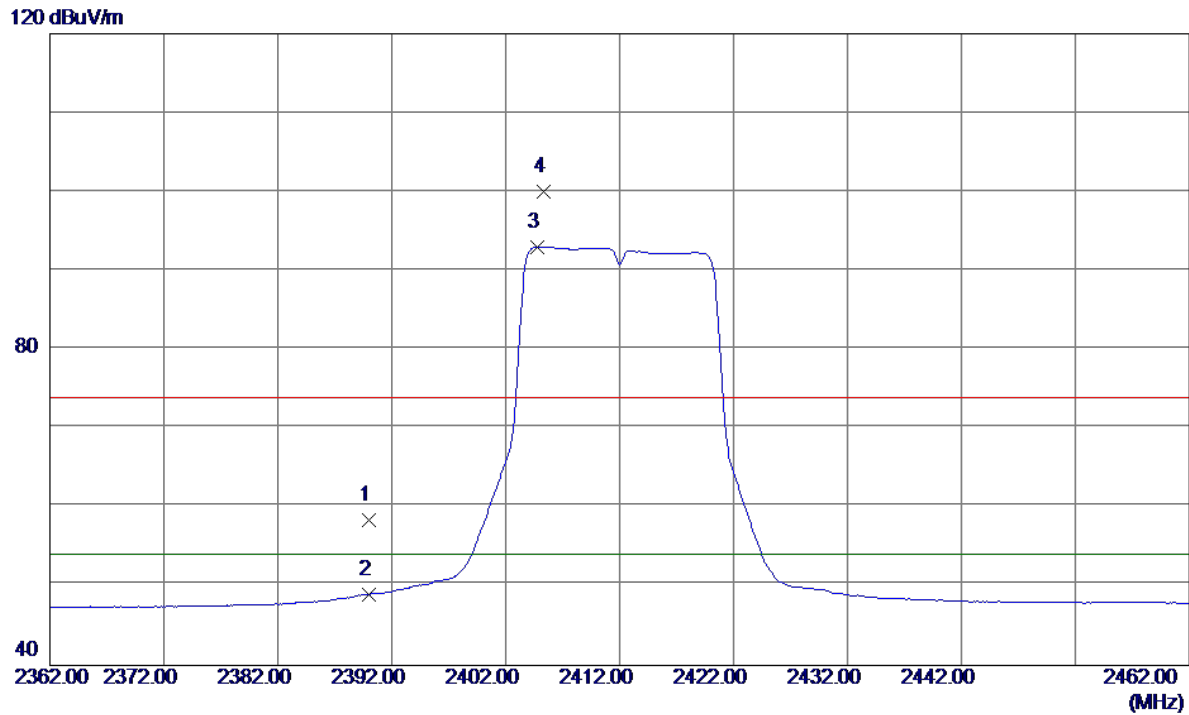

No.	Freq. MHz	Reading Level dBuV/m	Correct Factor dB	Measure ment dBuV/m	Limit dBuV/m	Over dB	Detector	Comment
1	2390.0000	25.09	33.38	58.47	74.00	-15.53	Peak	
2	2390.0000	15.61	33.38	48.99	54.00	-5.01	AVG	
3	2404.8000	59.55	33.42	92.97	54.00	38.97	AVG	NO LIMIT
4	2405.3300	66.60	33.42	100.02	74.00	26.02	Peak	NO LIMIT

Orthogonal Axis :	X
Test Mode :	TX G MODE 2412MHz

Horizontal

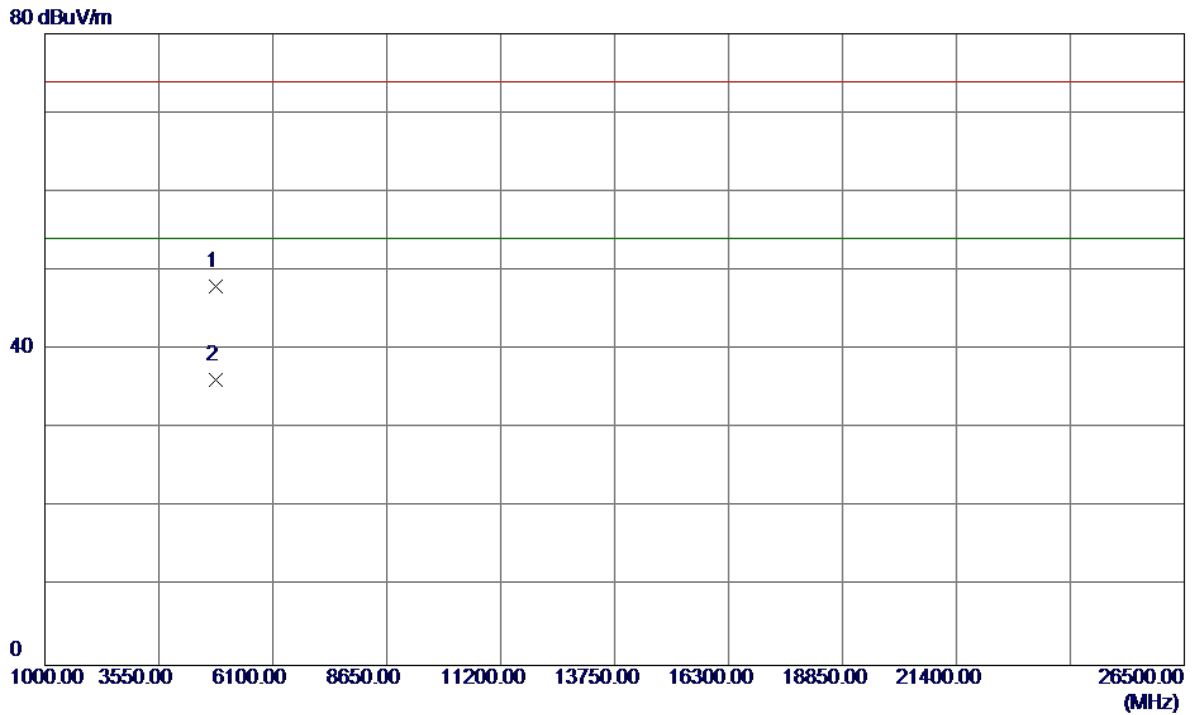

No.	Freq. MHz	Reading Level dBuV/m	Correct Factor dB	Measure ment dBuV/m	Limit dBuV/m	Over dB	Detector	Comment
1	4824.0150	41.62	6.43	48.05	74.00	-25.95	Peak	
2	4824.0000	29.80	6.43	36.23	54.00	-17.77	AVG	

Orthogonal Axis :	X
Test Mode :	TX G MODE 2437MHz

Vertical

120 dBuV/m

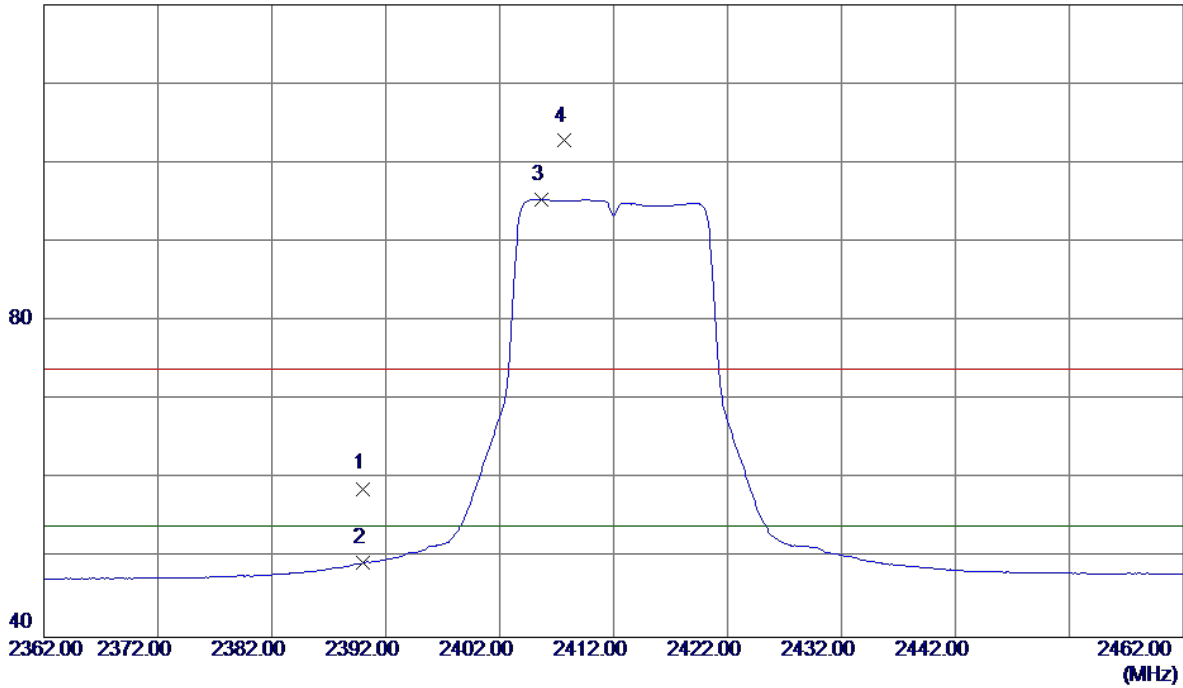

No.	Freq. MHz	Reading Level dBuV/m	Correct Factor dB	Measure ment dBuV/m	Limit dBuV/m	Over dB	Detector	Comment
1	2390.0000	25.42	33.38	58.80	74.00	-15.20	Peak	
2	2390.0000	16.02	33.38	49.40	54.00	-4.60	AVG	
3	2405.7000	61.94	33.42	95.36	54.00	41.36	AVG	NO LIMIT
4	2407.6830	69.37	33.43	102.80	74.00	28.80	Peak	NO LIMIT

Orthogonal Axis :	X
Test Mode :	TX G MODE 2437MHz

Vertical

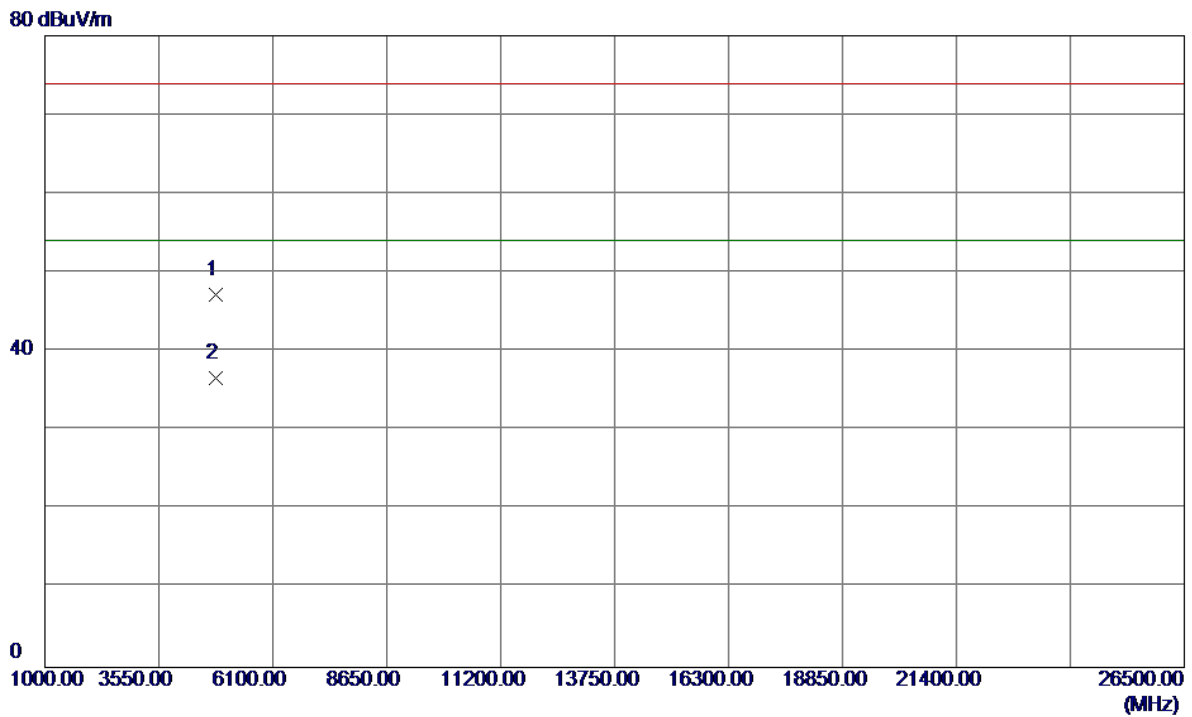

No.	Freq. MHz	Reading Level dBuV/m	Correct Factor dB	Measure ment dBuV/m	Limit dBuV/m	Over dB	Detector	Comment
1	4824.0000	40.75	6.43	47.18	74.00	-26.82	Peak	
2	4823.9900	30.27	6.43	36.70	54.00	-17.30	AVG	

Orthogonal Axis :	X
Test Mode :	TX G MODE 2437MHz

Horizontal

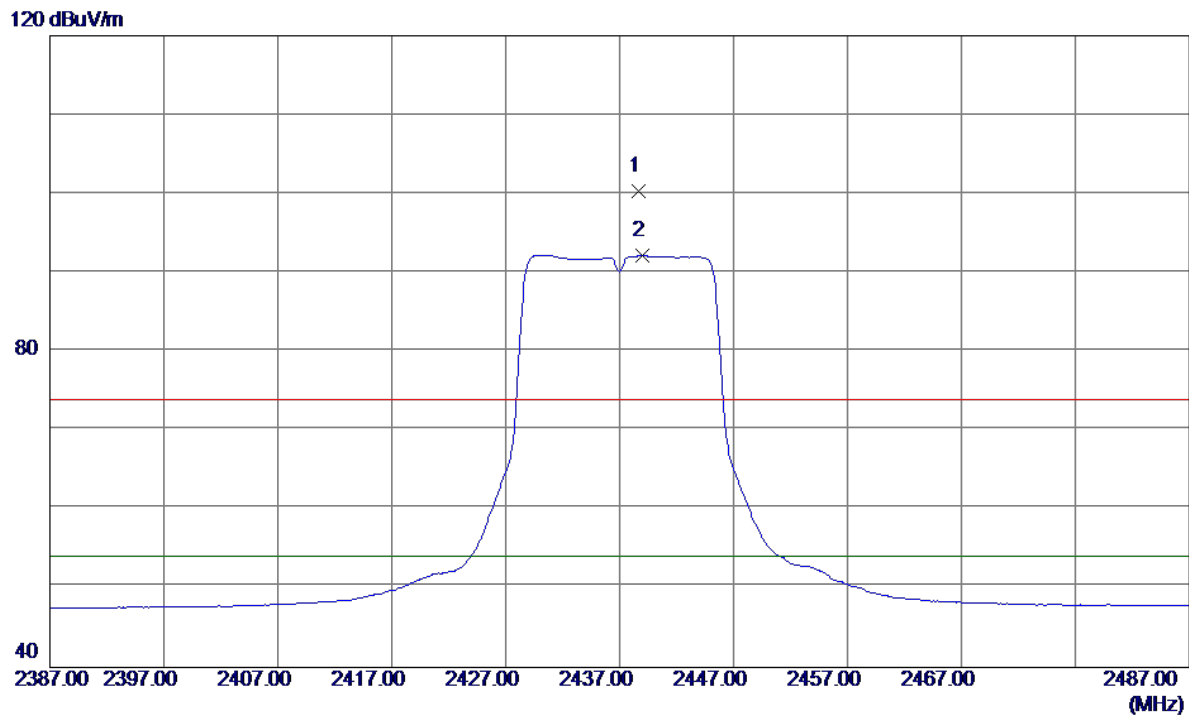

No.	Freq. MHz	Reading Level dBuV/m	Correct Factor dB	Measure ment dBuV/m	Limit dBuV/m	Over dB	Detector	Comment
1	2438.6510	66.77	33.51	100.28	74.00	26.28	Peak	NO LIMIT
2	2439.0000	58.66	33.51	92.17	54.00	38.17	AVG	NO LIMIT

Orthogonal Axis :	X
Test Mode :	TX G MODE 2437MHz

Horizontal

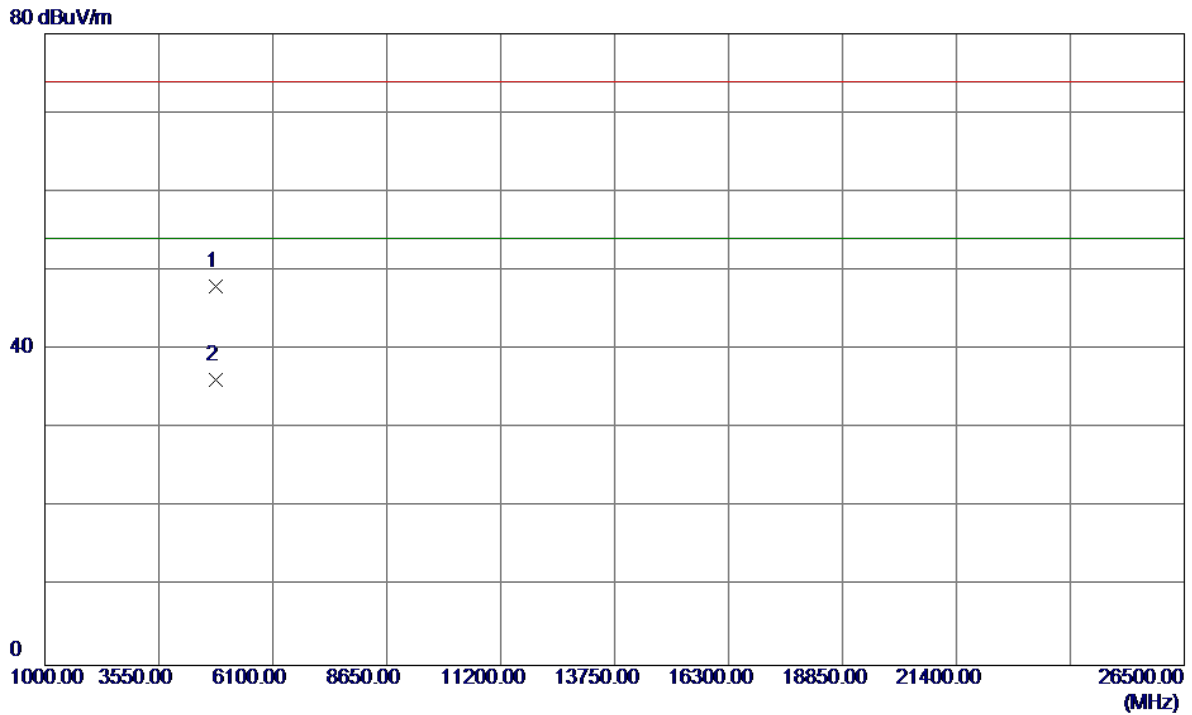

No.	Freq. MHz	Reading Level dBuV/m	Correct Factor dB	Measure ment dBuV/m	Limit dBuV/m	Over dB	Detector	Comment
1	4824.0150	41.62	6.43	48.05	74.00	-25.95	Peak	
2	4824.0000	29.80	6.43	36.23	54.00	-17.77	AVG	

Orthogonal Axis :	X
Test Mode :	TX G MODE 2462MHz

Vertical

120 dBuV/m

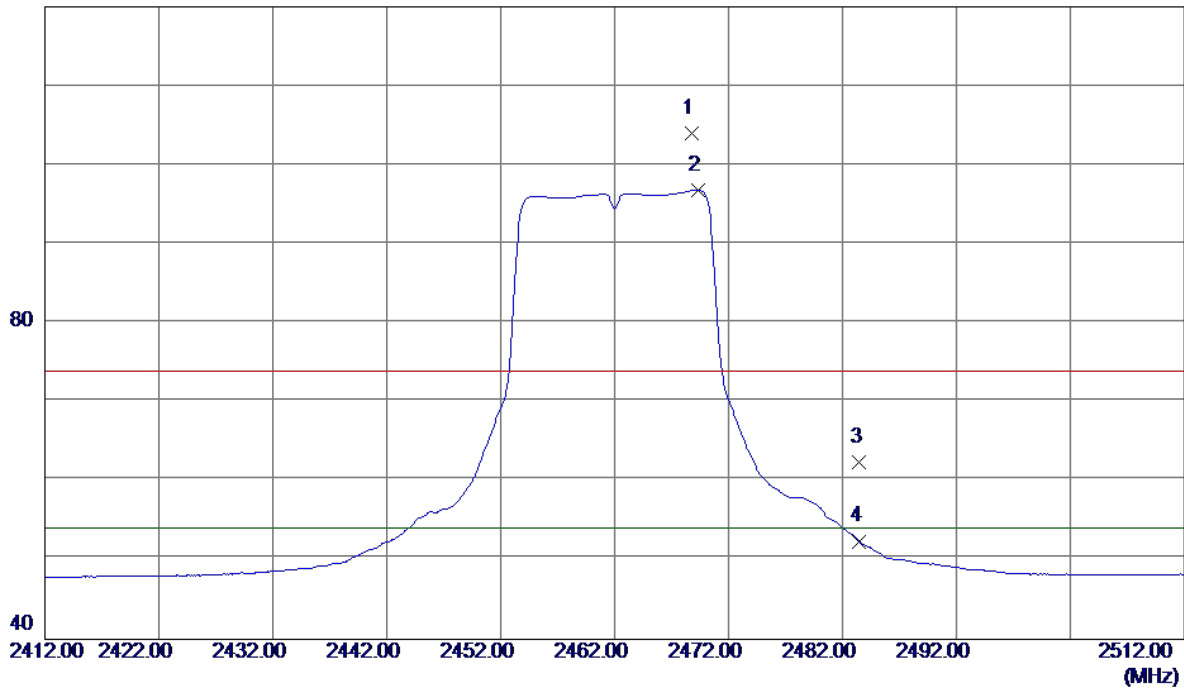

No.	Freq. MHz	Reading Level dBuV/m	Correct Factor dB	Measure ment dBuV/m	Limit dBuV/m	Over dB	Detector	Comment
1	2468.7240	70.38	33.58	103.96	74.00	29.96	Peak	NO LIMIT
2	2469.3000	63.21	33.58	96.79	54.00	42.79	AVG	NO LIMIT
3	2483.5000	28.78	33.62	62.40	74.00	-11.60	Peak	
4	2483.5000	18.78	33.62	52.40	54.00	-1.60	AVG	

Orthogonal Axis :	X
Test Mode :	TX G MODE 2462MHz

Vertical

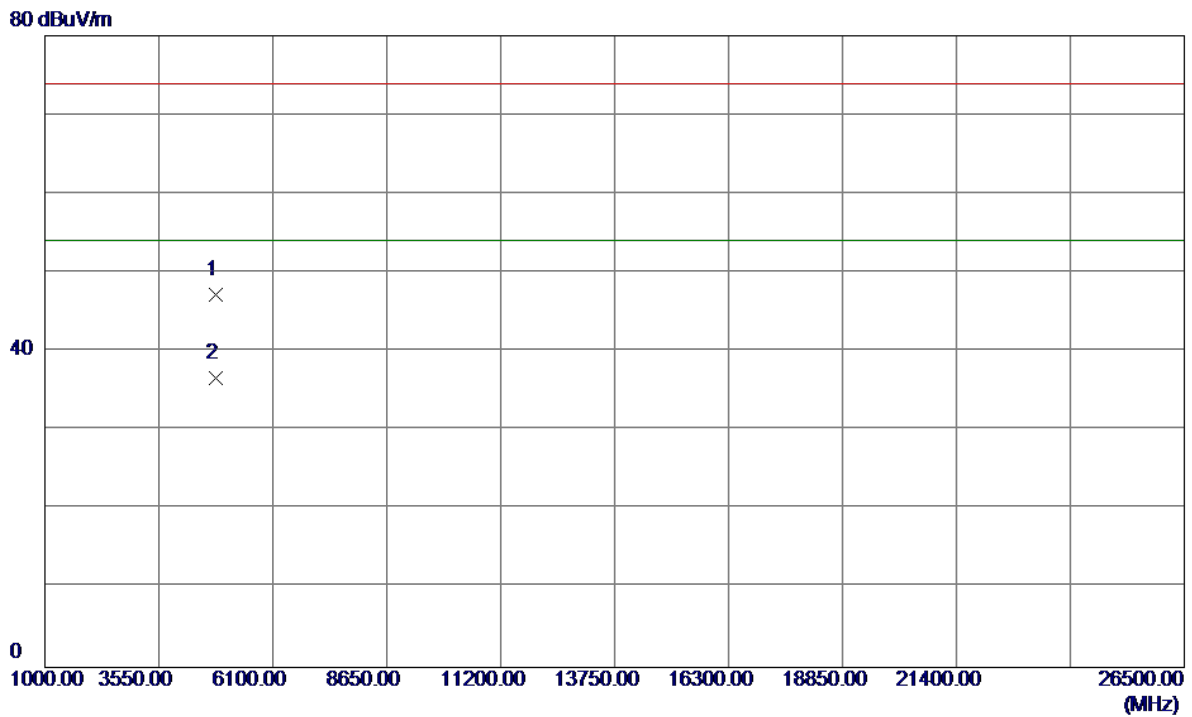

No.	Freq. MHz	Reading Level dBuV/m	Correct Factor dB	Measure ment dBuV/m	Limit dBuV/m	Over dB	Detector	Comment
1	4824.0000	40.75	6.43	47.18	74.00	-26.82	Peak	
2	4823.9900	30.27	6.43	36.70	54.00	-17.30	AVG	

Orthogonal Axis :	X
Test Mode :	TX G MODE 2462MHz

Horizontal

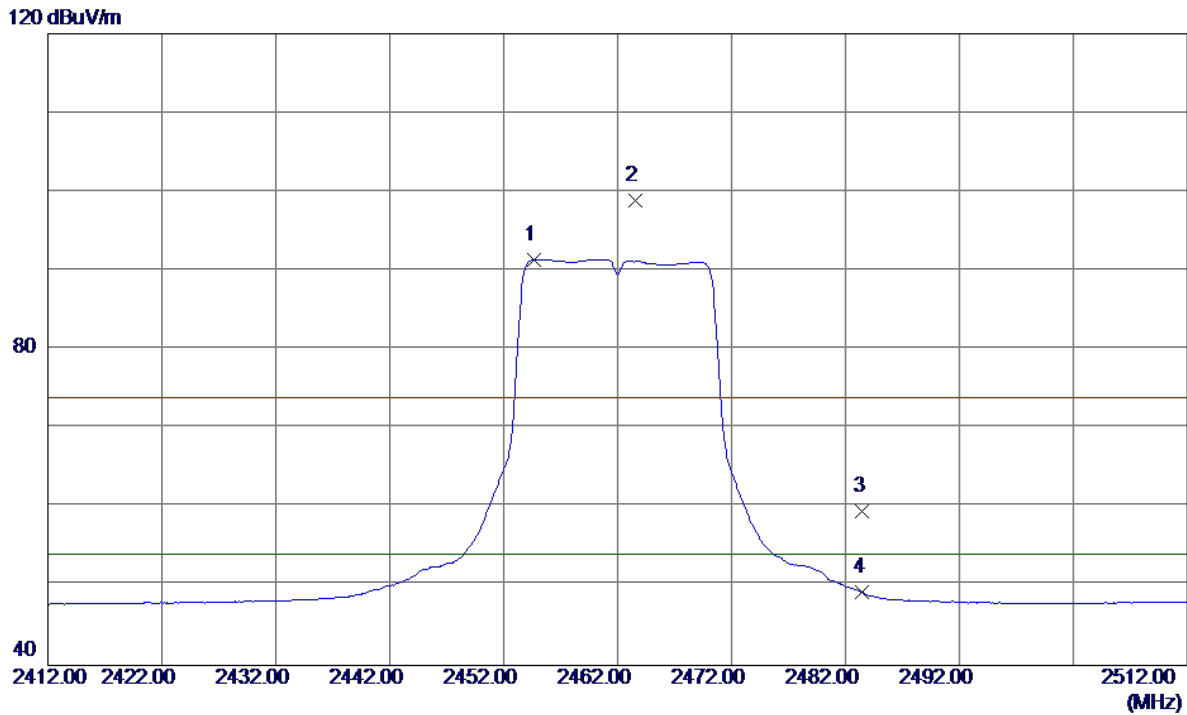

No.	Freq. MHz	Reading Level dBuV/m	Correct Factor dB	Measure ment dBuV/m	Limit dBuV/m	Over dB	Detector	Comment
1	2454.7000	57.86	33.55	91.41	54.00	37.41	AVG	NO LIMIT
2	2463.6000	65.32	33.57	98.89	74.00	24.89	Peak	NO LIMIT
3	2483.5000	25.91	33.62	59.53	74.00	-14.47	Peak	
4	2483.5000	15.59	33.62	49.21	54.00	-4.79	AVG	

Orthogonal Axis :	X
Test Mode :	TX G MODE 2462MHz

Horizontal

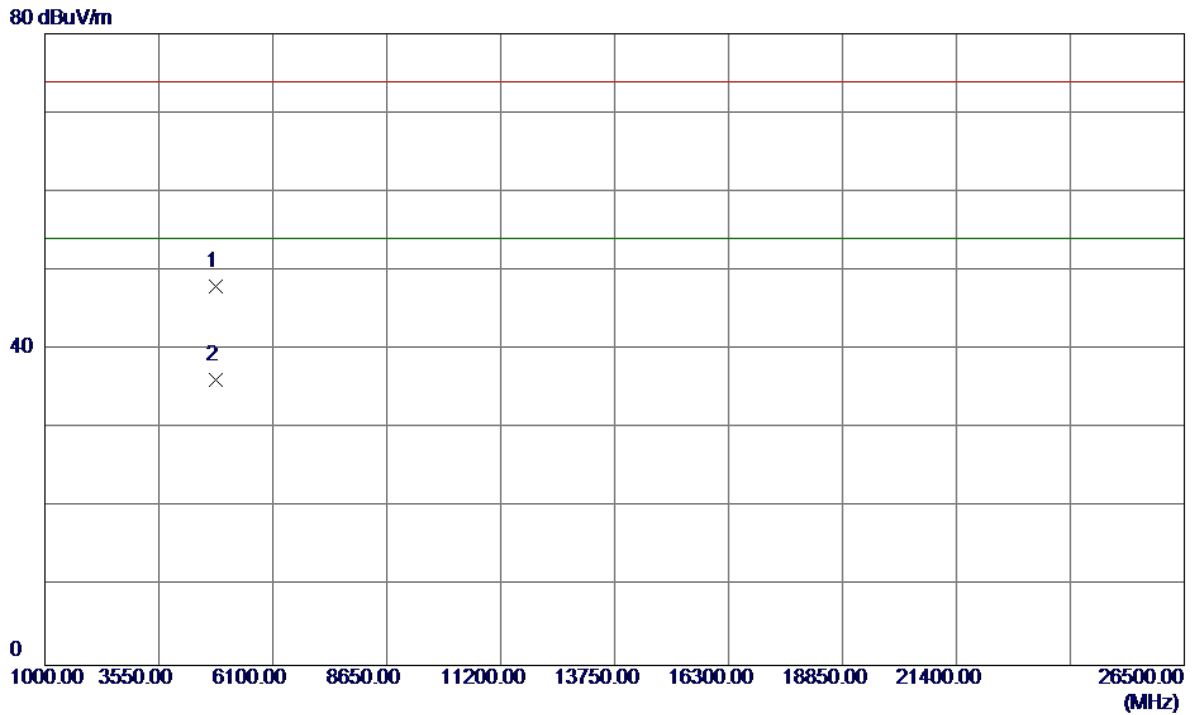

No.	Freq. MHz	Reading Level dBuV/m	Correct Factor dB	Measure ment dBuV/m	Limit dBuV/m	Over dB	Detector	Comment
1	4824.0150	41.62	6.43	48.05	74.00	-25.95	Peak	
2	4824.0000	29.80	6.43	36.23	54.00	-17.77	AVG	

Orthogonal Axis :	X
Test Mode :	TX N-20M MODE 2412MHz

Vertical

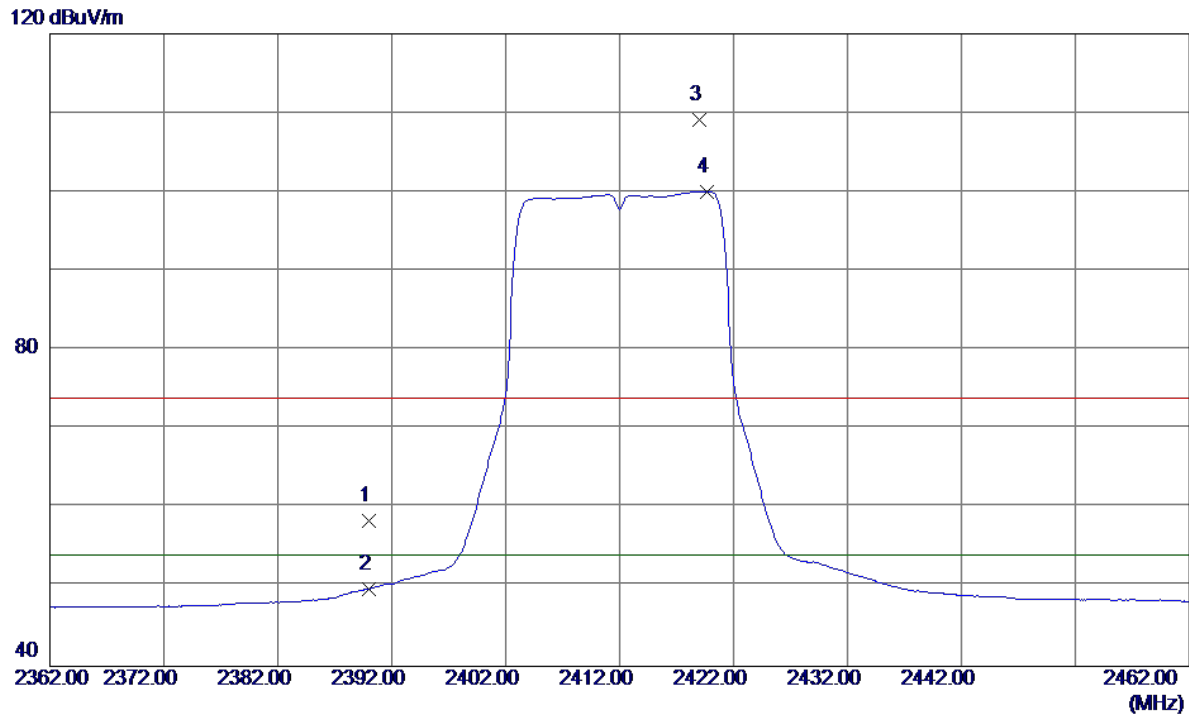

No.	Freq. MHz	Reading Level dBuV/m	Correct Factor dB	Measure ment dBuV/m	Limit dBuV/m	Over dB	Detector	Comment
1	2390.0000	25.09	33.38	58.47	74.00	-15.53	Peak	
2	2390.0000	16.41	33.38	49.79	54.00	-4.21	AVG	
3	2419.0000	75.69	33.46	109.15	74.00	35.15	Peak	NO LIMIT
4	2419.7000	66.61	33.46	100.07	54.00	46.07	AVG	NO LIMIT

Orthogonal Axis :	X
Test Mode :	TX N-20M MODE 2412MHz

Vertical

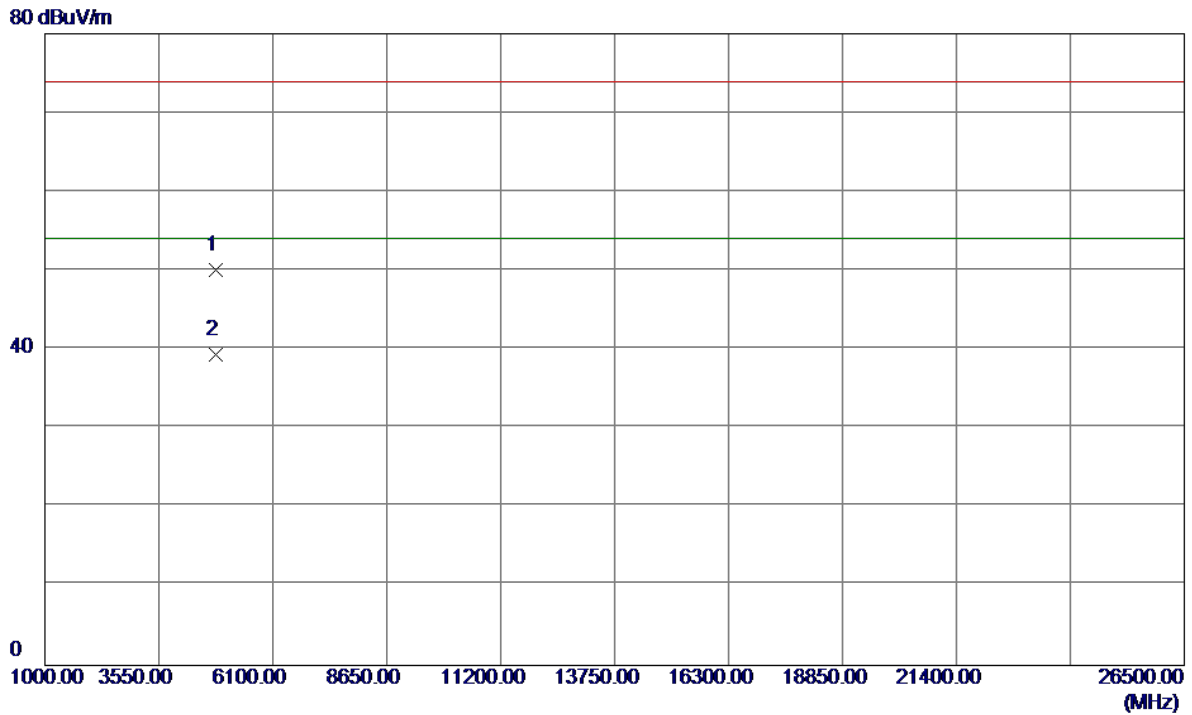

No.	Freq. MHz	Reading Level dBuV/m	Correct Factor dB	Measure ment dBuV/m	Limit dBuV/m	Over dB	Detector	Comment
1	4823.9900	43.58	6.43	50.01	74.00	-23.99	Peak	
2	4824.0050	32.95	6.43	39.38	54.00	-14.62	AVG	

Orthogonal Axis :	X
Test Mode :	TX N-20M MODE 2412MHz

Horizontal

120 dBuV/m

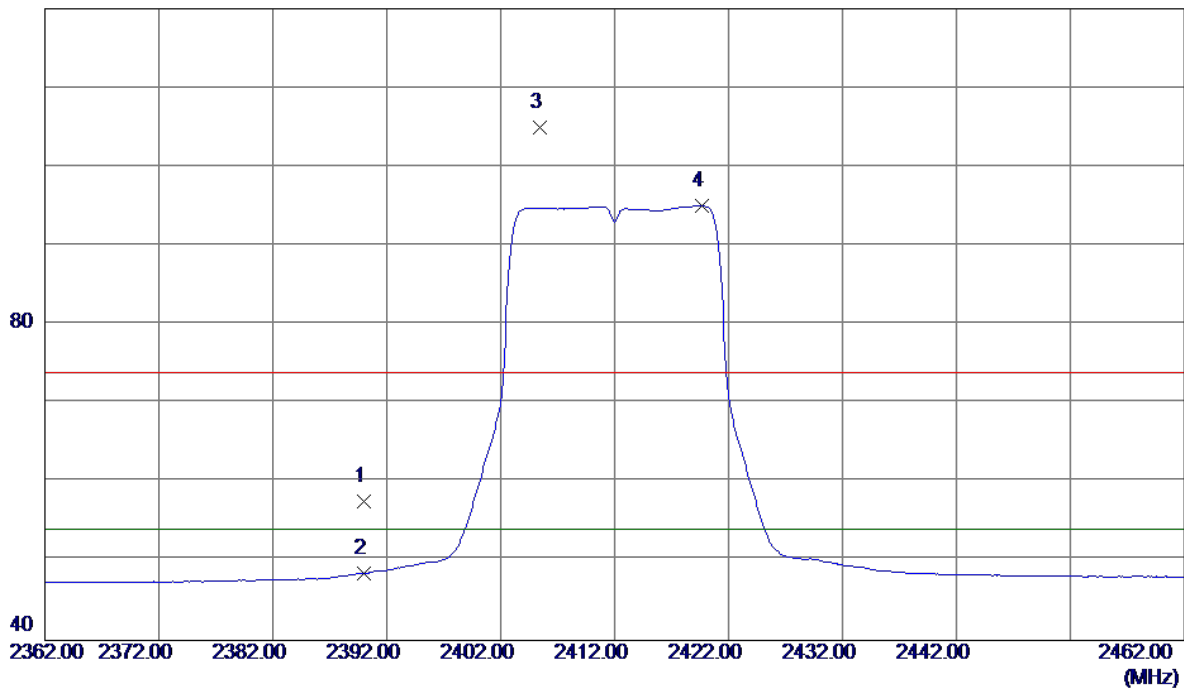

No.	Freq. MHz	Reading Level dBuV/m	Correct Factor dB	Measure ment dBuV/m	Limit dBuV/m	Over dB	Detector	Comment
1	2390.0000	24.20	33.38	57.58	74.00	-16.42	Peak	
2	2390.0000	15.09	33.38	48.47	54.00	-5.53	AVG	
3	2405.4890	71.48	33.42	104.90	74.00	30.90	Peak	NO LIMIT
4	2419.7000	61.54	33.46	95.00	54.00	41.00	AVG	NO LIMIT

Orthogonal Axis :	X
Test Mode :	TX N-20M MODE 2412MHz

Horizontal

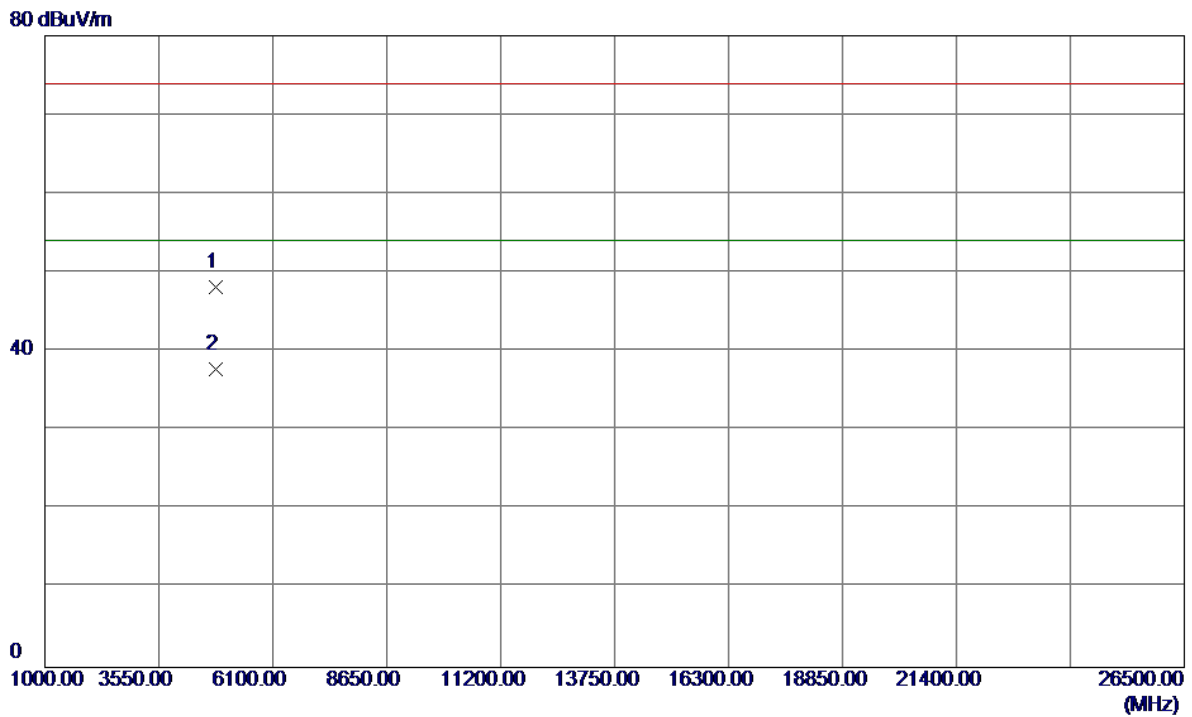

No.	Freq. MHz	Reading Level dBuV/m	Correct Factor dB	Measure ment dBuV/m	Limit dBuV/m	Over dB	Detector	Comment
1	4824.0650	41.74	6.43	48.17	74.00	-25.83	Peak	
2	4824.0000	31.27	6.43	37.70	54.00	-16.30	AVG	

Orthogonal Axis :	X
Test Mode :	TX N-20M MODE 2437MHz

Vertical

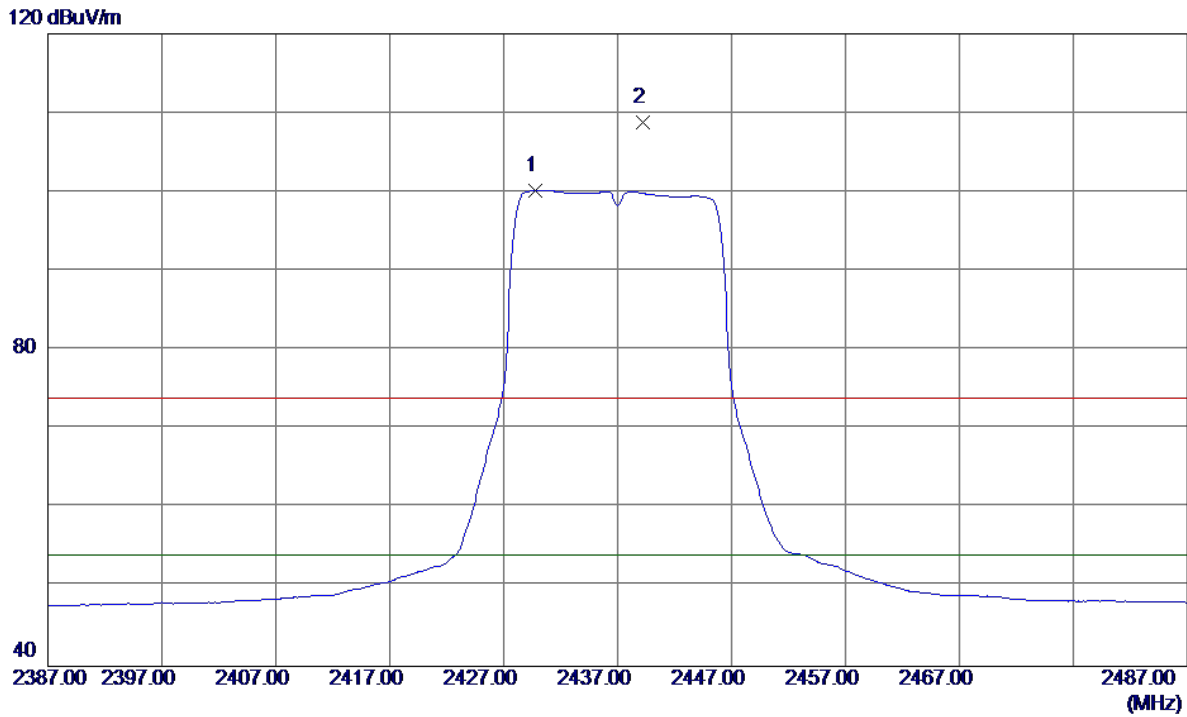

No.	Freq. MHz	Reading Level dBuV/m	Correct Factor dB	Measure ment dBuV/m	Limit dBuV/m	Over dB	Detector	Comment
1	2429.8000	66.71	33.48	100.19	54.00	46.19	AVG	NO LIMIT
2	2439.2609	75.27	33.51	108.78	74.00	34.78	Peak	NO LIMIT

Orthogonal Axis :	X
Test Mode :	TX N-20M MODE 2437MHz

Vertical

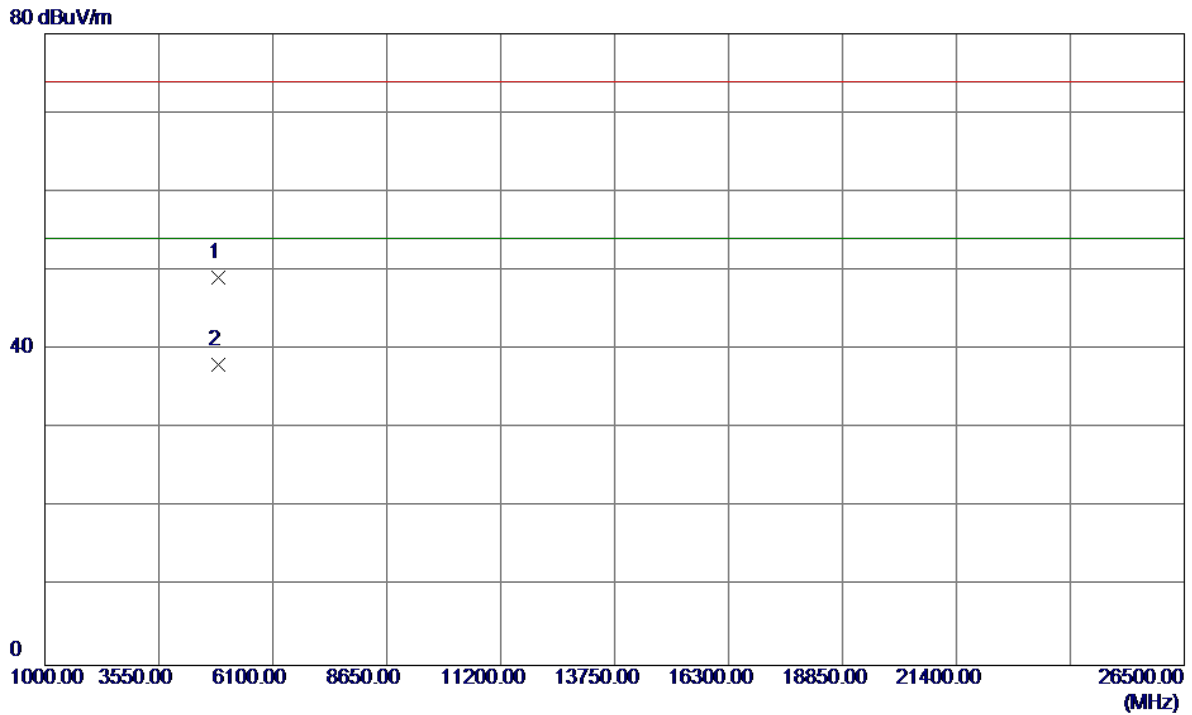

No.	Freq. MHz	Reading Level dBuV/m	Correct Factor dB	Measure ment dBuV/m	Limit dBuV/m	Over dB	Detector	Comment
1	4873.9000	42.62	6.55	49.17	74.00	-24.83	Peak	
2	4873.9850	31.50	6.55	38.05	54.00	-15.95	AVG	

Orthogonal Axis :	X
Test Mode :	TX N-20M MODE 2437MHz

Horizontal

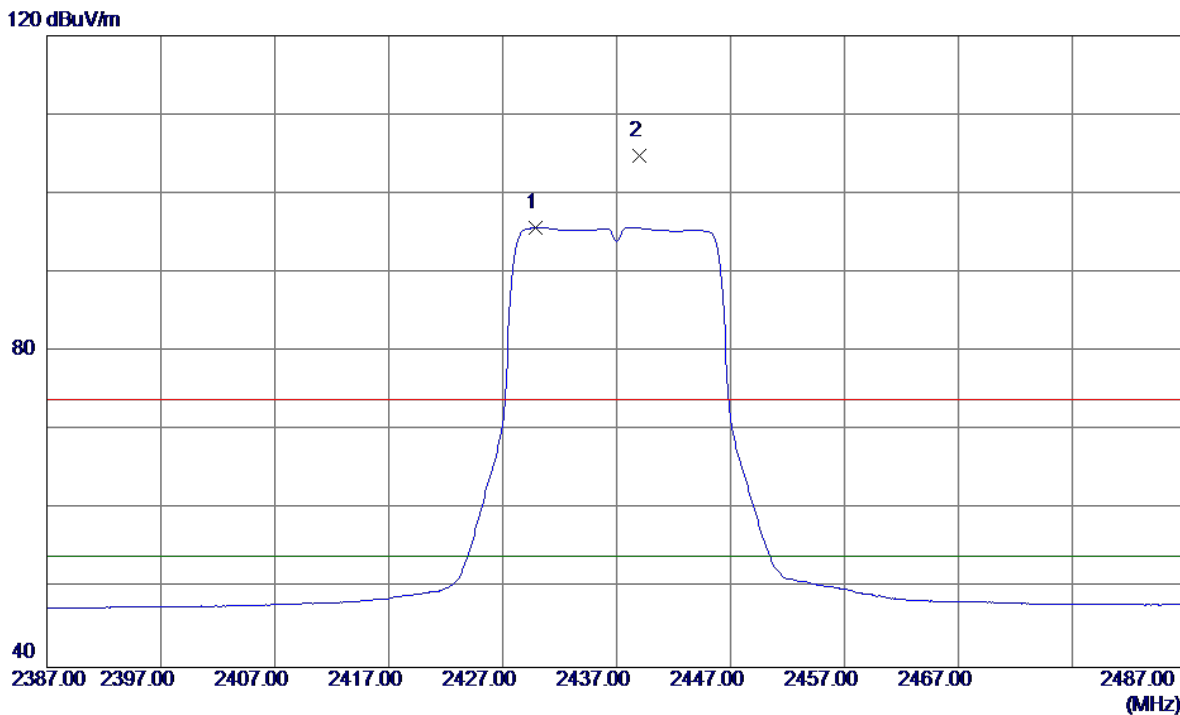

No.	Freq. MHz	Reading Level dBuV/m	Correct Factor dB	Measure ment dBuV/m	Limit dBuV/m	Over dB	Detector	Comment
1	2429.9000	62.21	33.48	95.69	54.00	41.69	AVG	NO LIMIT
2	2439.0000	71.29	33.51	104.80	74.00	30.80	Peak	NO LIMIT

Orthogonal Axis :	X
Test Mode :	TX N-20M MODE 2437MHz

Horizontal

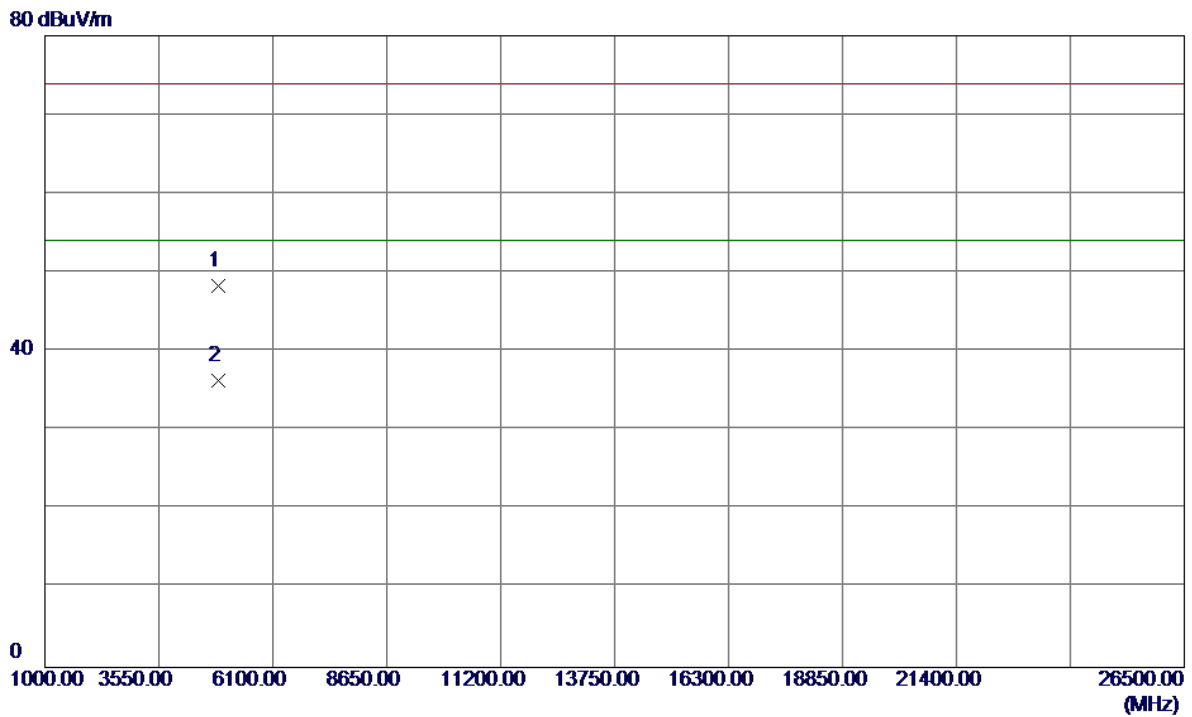

No.	Freq. MHz	Reading Level dBuV/m	Correct Factor dB	Measure ment dBuV/m	Limit dBuV/m	Over dB	Detector	Comment
1	4873.8750	41.77	6.55	48.32	74.00	-25.68	Peak	
2	4873.9550	29.76	6.55	36.31	54.00	-17.69	AVG	

Orthogonal Axis :	X
Test Mode :	TX N-20M MODE 2462MHz

Vertical

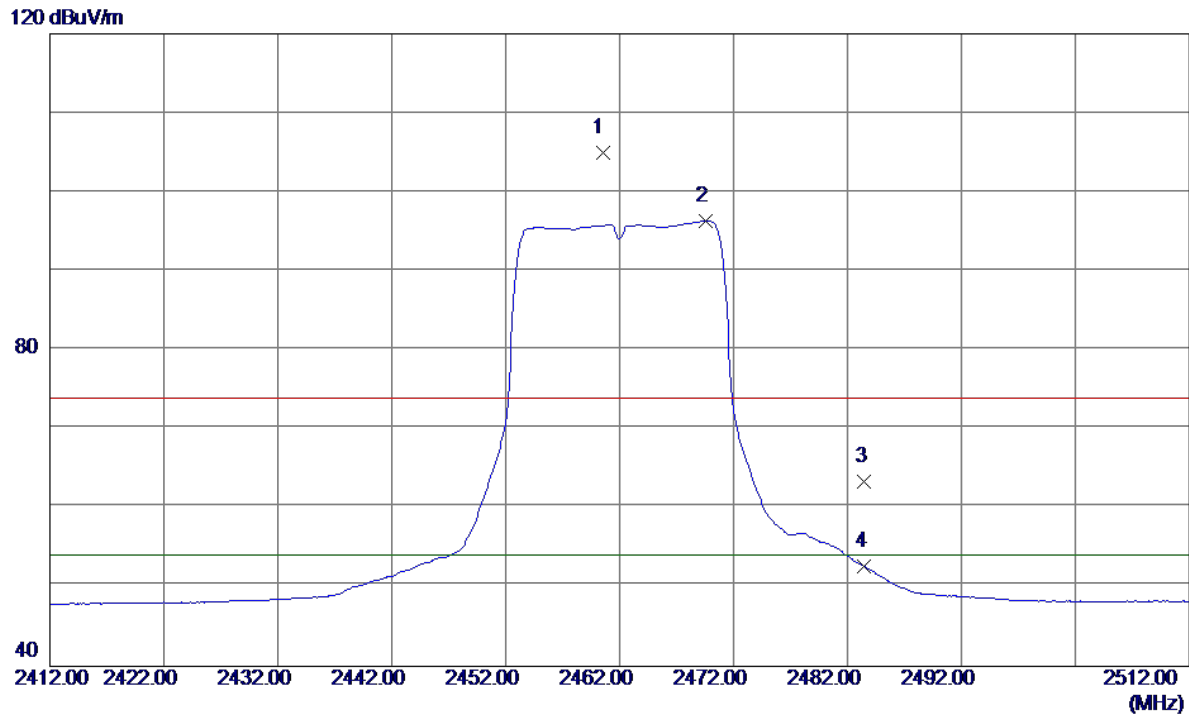

No.	Freq. MHz	Reading Level dBuV/m	Correct Factor dB	Measure ment dBuV/m	Limit dBuV/m	Over dB	Detector	Comment
1	2460.5000	71.46	33.56	105.02	74.00	31.02	Peak	NO LIMIT
2	2469.6000	62.72	33.58	96.30	54.00	42.30	AVG	NO LIMIT
3	2483.5000	29.76	33.62	63.38	74.00	-10.62	Peak	
4	2483.5000	18.99	33.62	52.61	54.00	-1.39	AVG	

Orthogonal Axis :	X
Test Mode :	TX N-20M MODE 2462MHz

Vertical

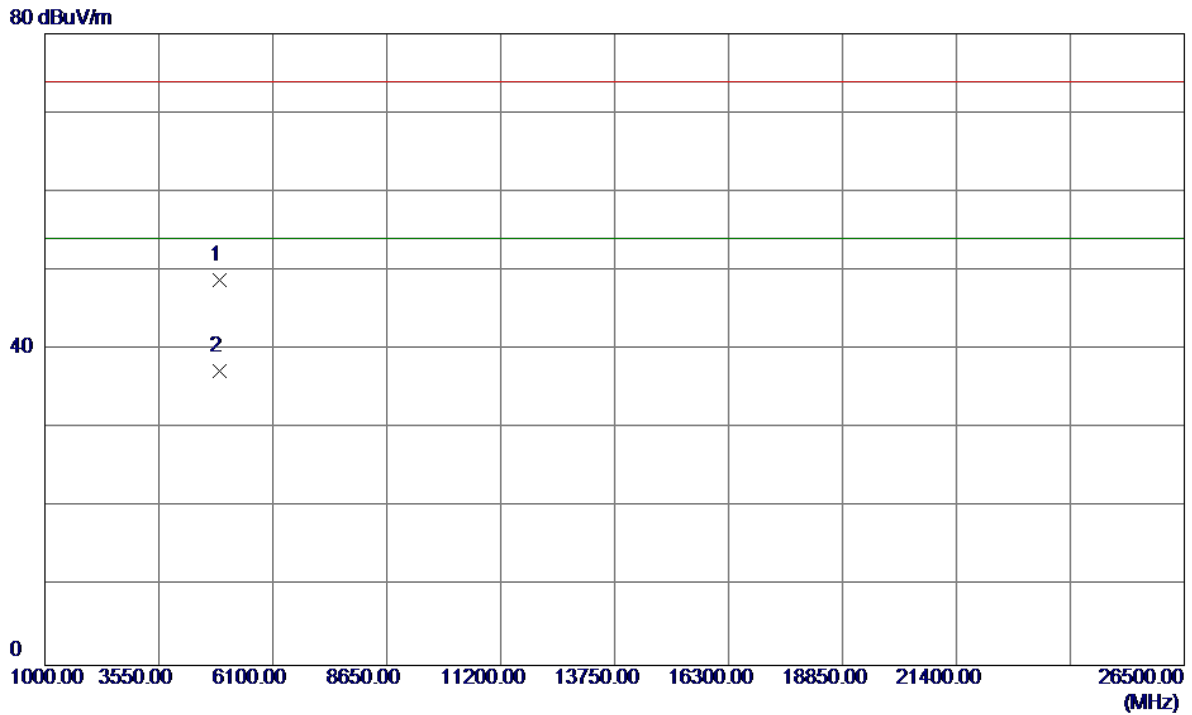

No.	Freq. MHz	Reading Level dBuV/m	Correct Factor dB	Measure ment dBuV/m	Limit dBuV/m	Over dB	Detector	Comment
1	4923.9600	42.13	6.66	48.79	74.00	-25.21	Peak	
2	4923.9850	30.66	6.66	37.32	54.00	-16.68	AVG	

Orthogonal Axis :	X
Test Mode :	TX N-20M MODE 2462MHz

Horizontal

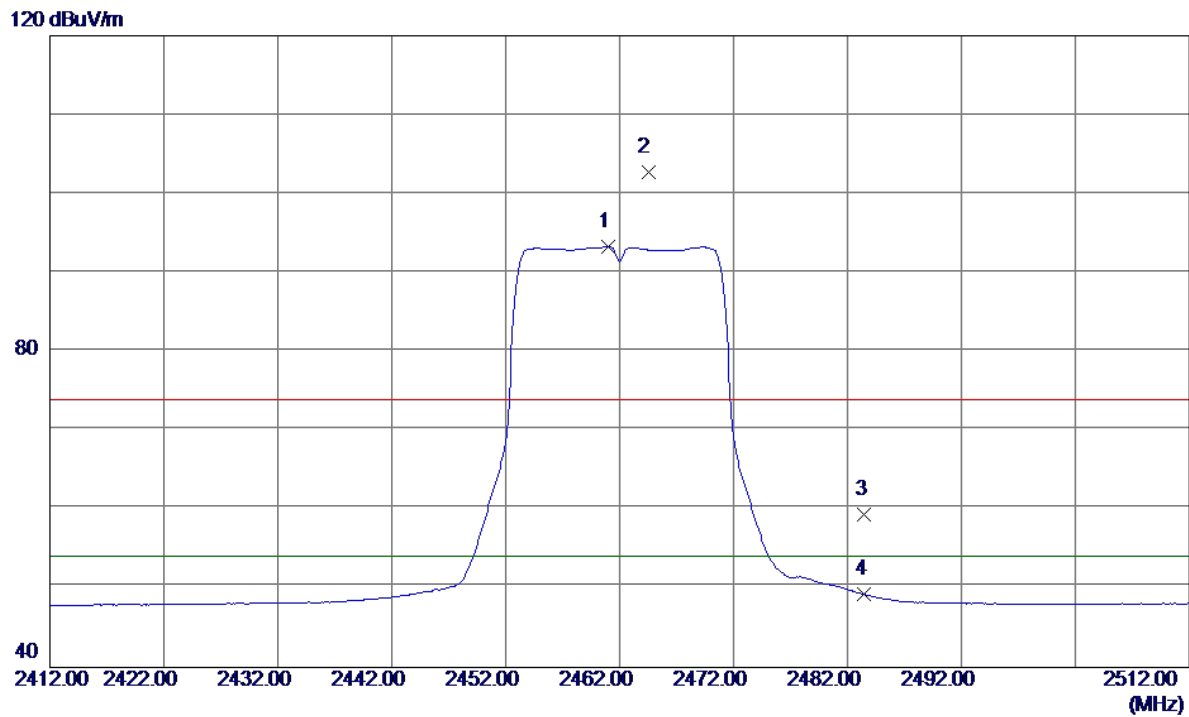

No.	Freq. MHz	Reading Level dBuV/m	Correct Factor dB	Measure ment dBuV/m	Limit dBuV/m	Over dB	Detector	Comment
1	2461.0000	59.71	33.56	93.27	54.00	39.27	AVG	NO LIMIT
2	2464.5000	69.14	33.57	102.71	74.00	28.71	Peak	NO LIMIT
3	2483.5000	25.71	33.62	59.33	74.00	-14.67	Peak	
4	2483.5000	15.63	33.62	49.25	54.00	-4.75	AVG	

Orthogonal Axis :	X
Test Mode :	TX N-20M MODE 2462MHz

Horizontal

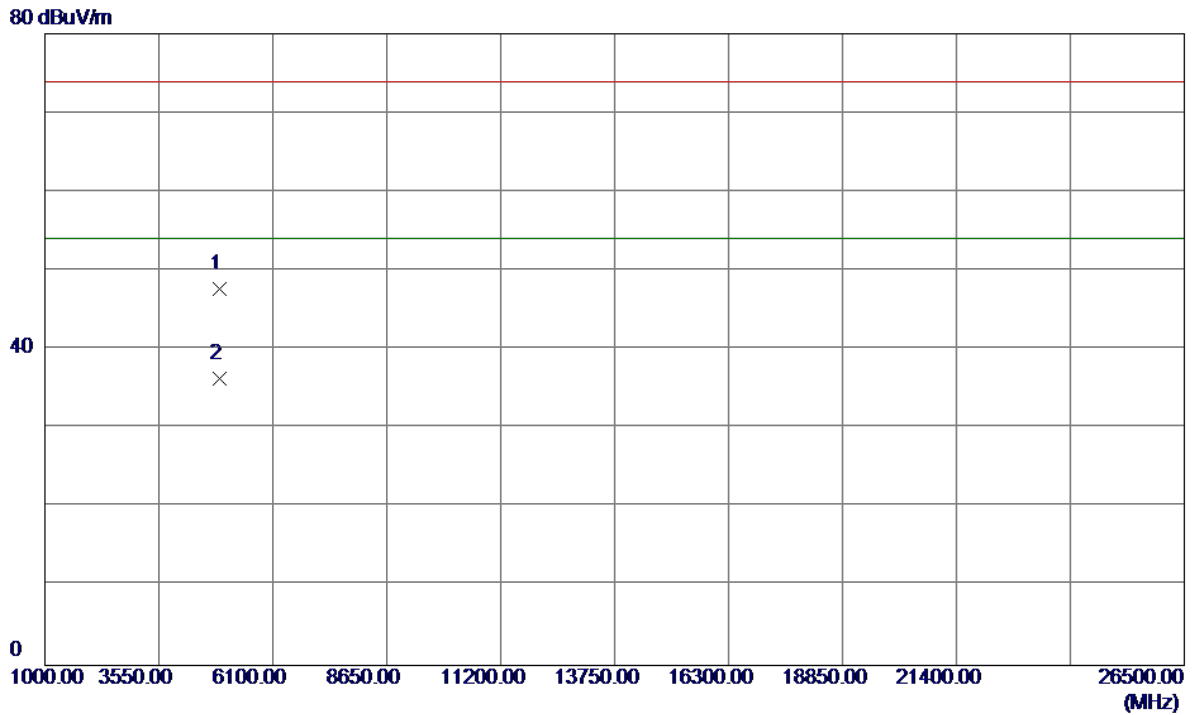

No.	Freq. MHz	Reading Level dBuV/m	Correct Factor dB	Measure ment dBuV/m	Limit dBuV/m	Over dB	Detector	Comment
1	4923.9900	41.10	6.66	47.76	74.00	-26.24	Peak	
2	4924.0000	29.71	6.66	36.37	54.00	-17.63	AVG	

Orthogonal Axis :	X
Test Mode :	TX N-40M MODE 2422MHz

Vertical

120 dBuV/m

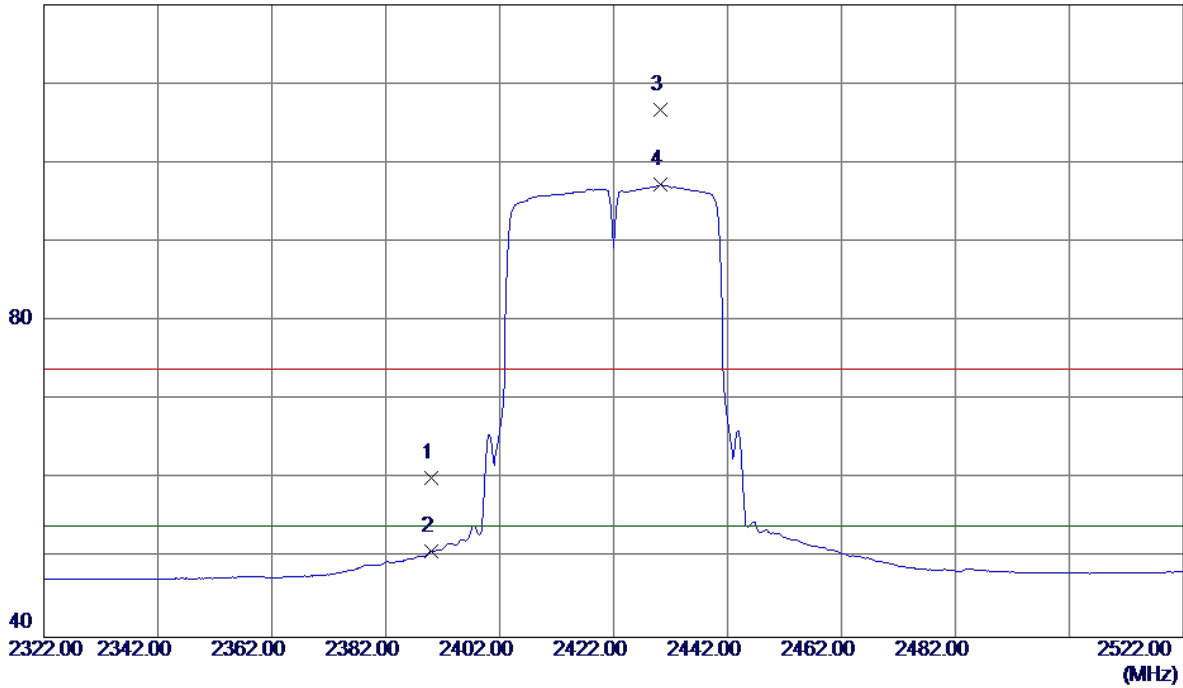

No.	Freq. MHz	Reading Level dBuV/m	Correct Factor dB	Measure ment dBuV/m	Limit dBuV/m	Over dB	Detector	Comment
1	2390.0000	26.77	33.38	60.15	74.00	-13.85	Peak	
2	2390.0000	17.47	33.38	50.85	54.00	-3.15	AVG	
3	2430.2260	73.27	33.48	106.75	74.00	32.75	Peak	NO LIMIT
4	2430.2000	63.73	33.48	97.21	54.00	43.21	AVG	NO LIMIT

Orthogonal Axis :	X
Test Mode :	TX N-40M MODE 2422MHz

Vertical

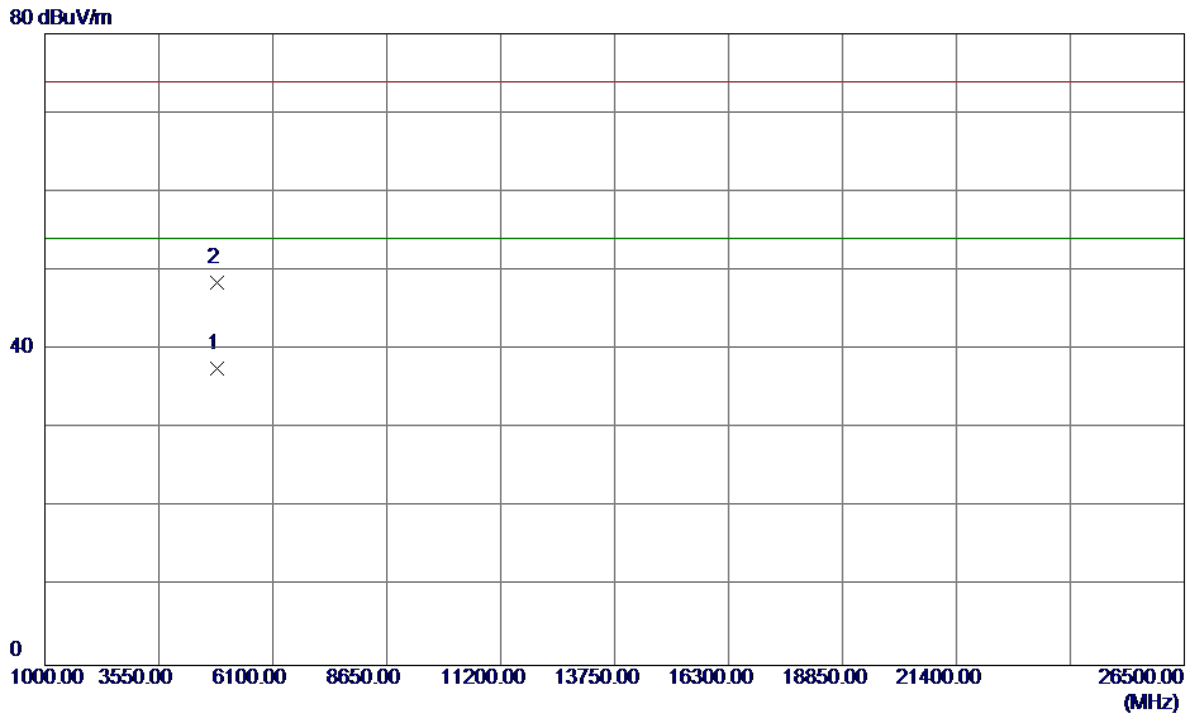

No.	Freq. MHz	Reading Level dBuV/m	Correct Factor dB	Measure ment dBuV/m	Limit dBuV/m	Over dB	Detector	Comment
1	4843.9950	31.13	6.48	37.61	74.00	-36.39	Peak	
2	4844.0550	42.01	6.48	48.49	54.00	-5.51	AVG	

Orthogonal Axis :	X
Test Mode :	TX N-40M MODE 2422MHz

Horizontal

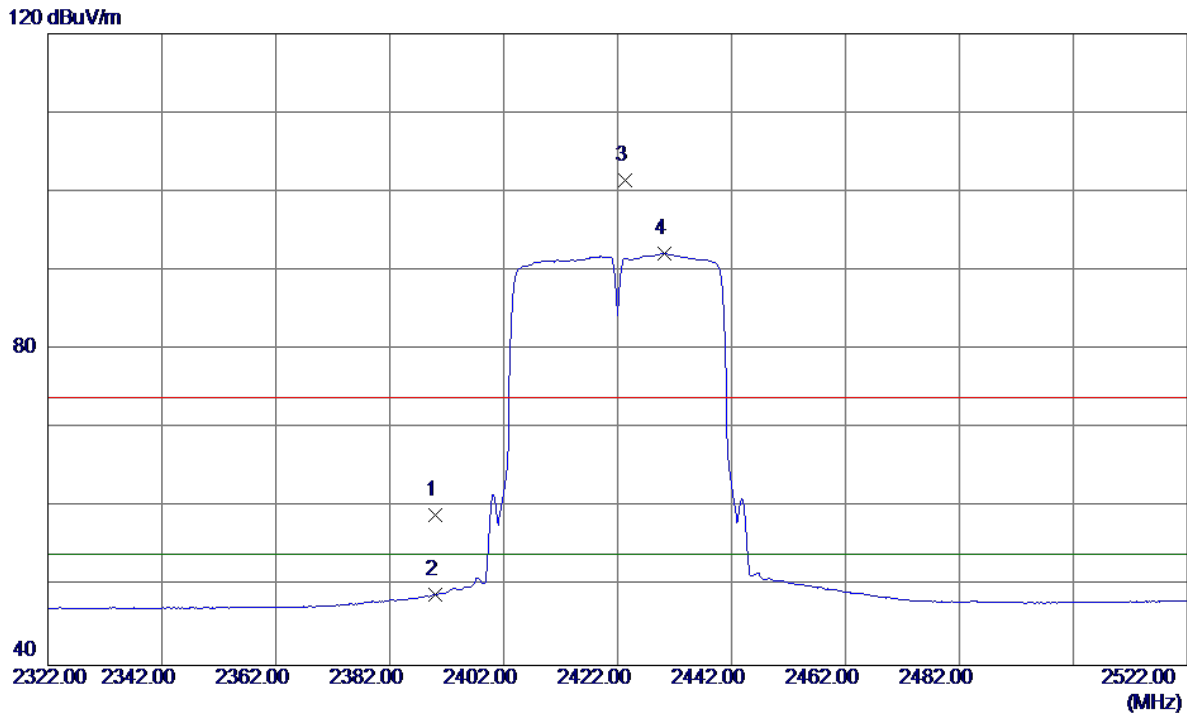

No.	Freq. MHz	Reading Level dBuV/m	Correct Factor dB	Measure ment dBuV/m	Limit dBuV/m	Over dB	Detector	Comment
1	2390.0000	25.59	33.38	58.97	74.00	-15.03	Peak	
2	2390.0000	15.63	33.38	49.01	54.00	-4.99	AVG	
3	2423.3360	67.94	33.47	101.41	74.00	27.41	Peak	NO LIMIT
4	2430.2000	58.71	33.48	92.19	54.00	38.19	AVG	NO LIMIT

Orthogonal Axis :	X
Test Mode :	TX N-40M MODE 2422MHz

Horizontal

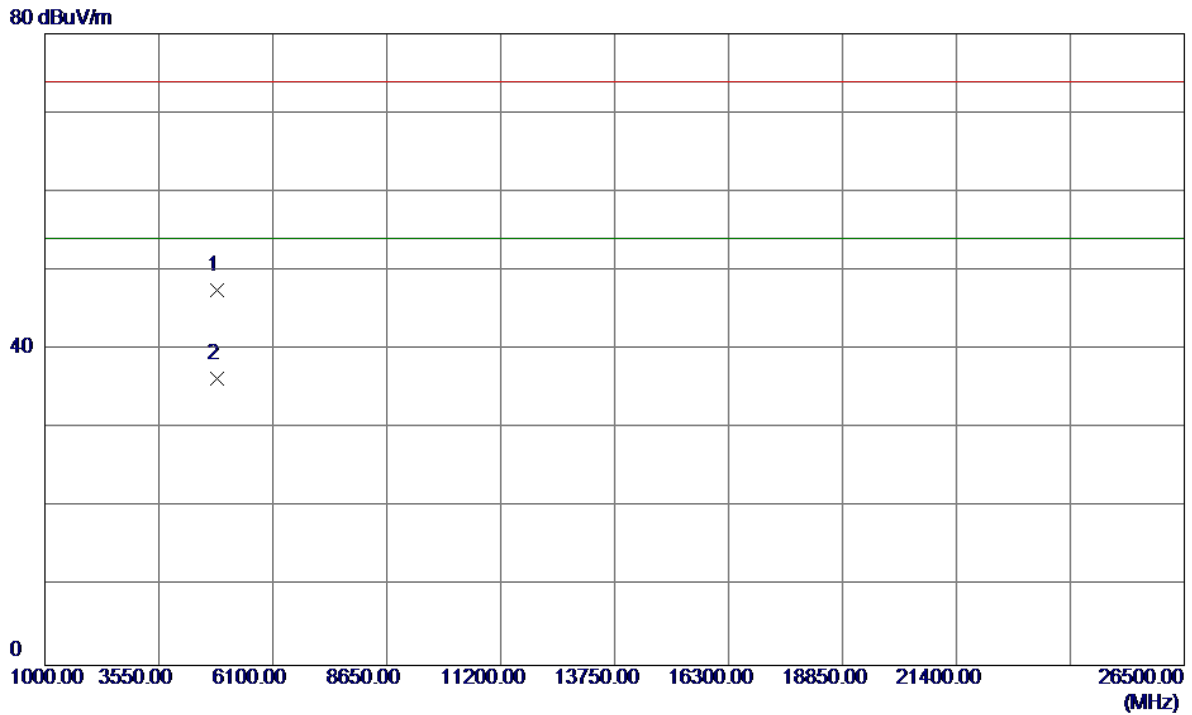

No.	Freq. MHz	Reading Level dBuV/m	Correct Factor dB	Measure ment dBuV/m	Limit dBuV/m	Over dB	Detector	Comment
1	4843.9250	41.11	6.48	47.59	74.00	-26.41	Peak	
2	4843.9550	29.77	6.48	36.25	54.00	-17.75	AVG	

Orthogonal Axis :	X
Test Mode :	TX N-40M MODE 2437MHz

Vertical

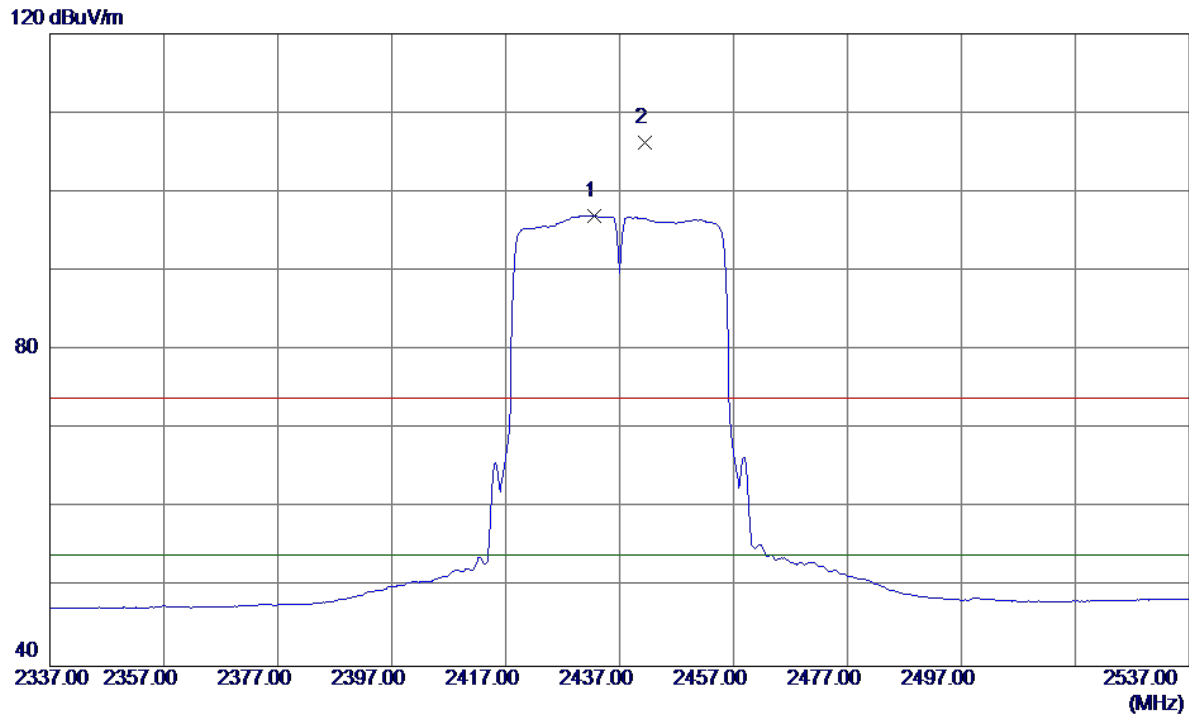

No.	Freq. MHz	Reading Level dBuV/m	Correct Factor dB	Measure ment dBuV/m	Limit dBuV/m	Over dB	Detector	Comment
1	2432.6000	63.51	33.49	97.00	54.00	43.00	AVG	NO LIMIT
2	2441.4000	72.67	33.51	106.18	74.00	32.18	Peak	NO LIMIT

Orthogonal Axis :	X
Test Mode :	TX N-40M MODE 2437MHz

Vertical

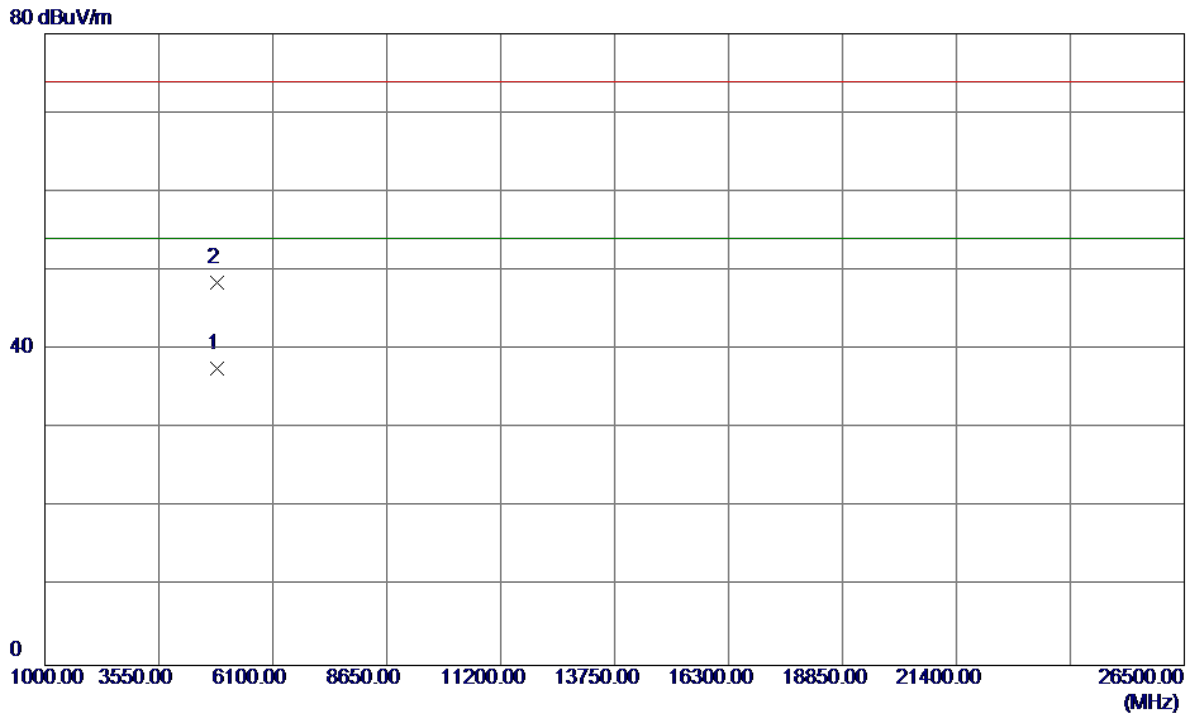

No.	Freq. MHz	Reading Level dBuV/m	Correct Factor dB	Measure ment dBuV/m	Limit dBuV/m	Over dB	Detector	Comment
1	4843.9950	31.13	6.48	37.61	74.00	-36.39	Peak	
2	4844.0550	42.01	6.48	48.49	54.00	-5.51	AVG	

Orthogonal Axis :	X
Test Mode :	TX N-40M MODE 2437MHz

Horizontal

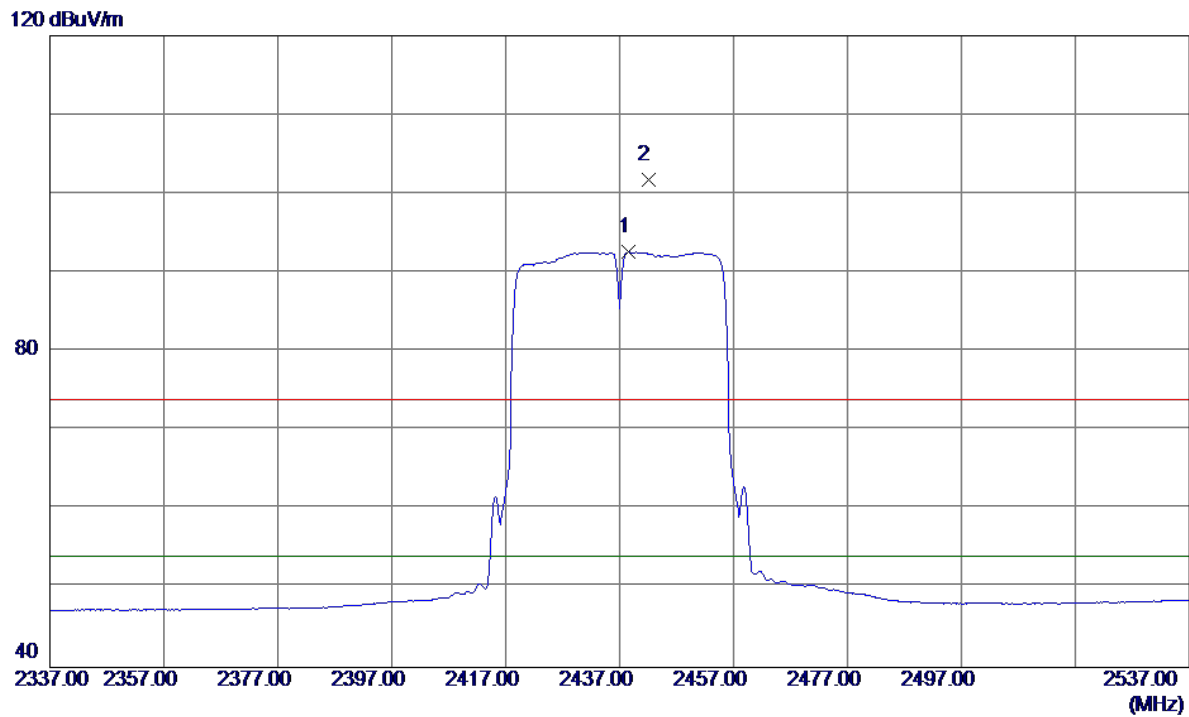

No.	Freq. MHz	Reading Level dBuV/m	Correct Factor dB	Measure ment dBuV/m	Limit dBuV/m	Over dB	Detector	Comment
1	2438.6000	59.06	33.51	92.57	54.00	38.57	AVG	NO LIMIT
2	2442.0000	68.17	33.51	101.68	74.00	27.68	Peak	NO LIMIT

Orthogonal Axis :	X
Test Mode :	TX N-40M MODE 2437MHz

Horizontal

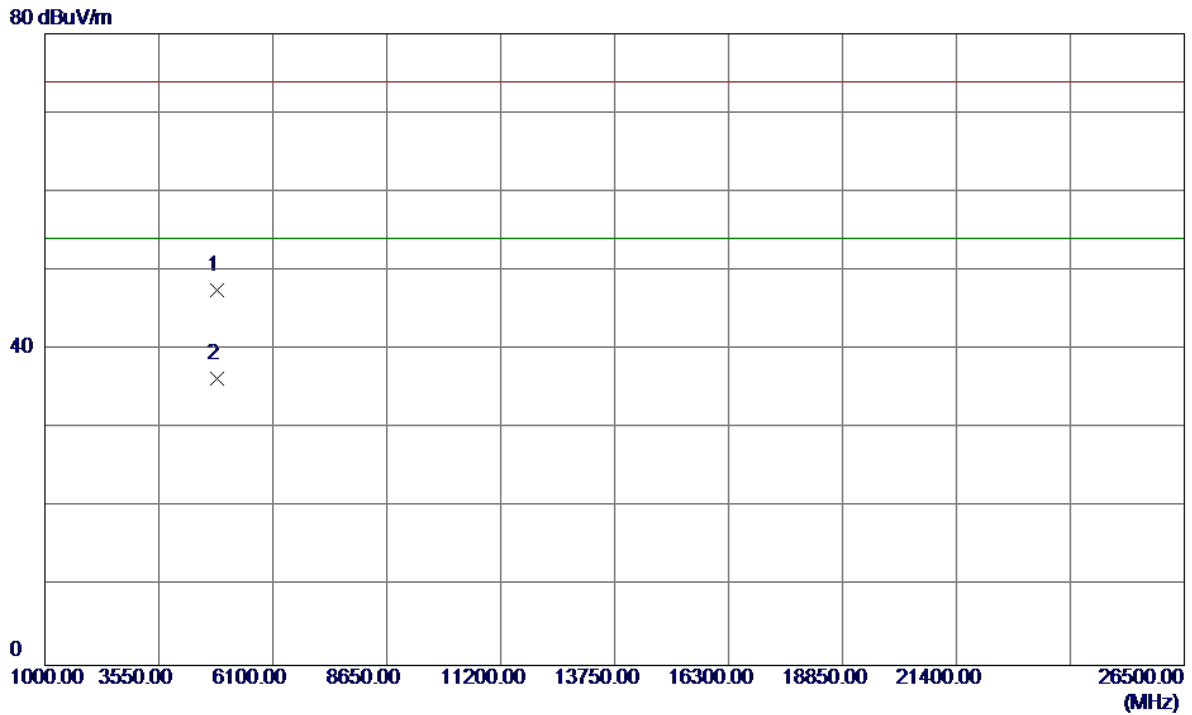

No.	Freq. MHz	Reading Level dBuV/m	Correct Factor dB	Measure ment dBuV/m	Limit dBuV/m	Over dB	Detector	Comment
1	4843.9250	41.11	6.48	47.59	74.00	-26.41	Peak	
2	4843.9550	29.77	6.48	36.25	54.00	-17.75	AVG	

Orthogonal Axis :	X
Test Mode :	TX N-40M MODE 2452MHz

Vertical

120 dBuV/m

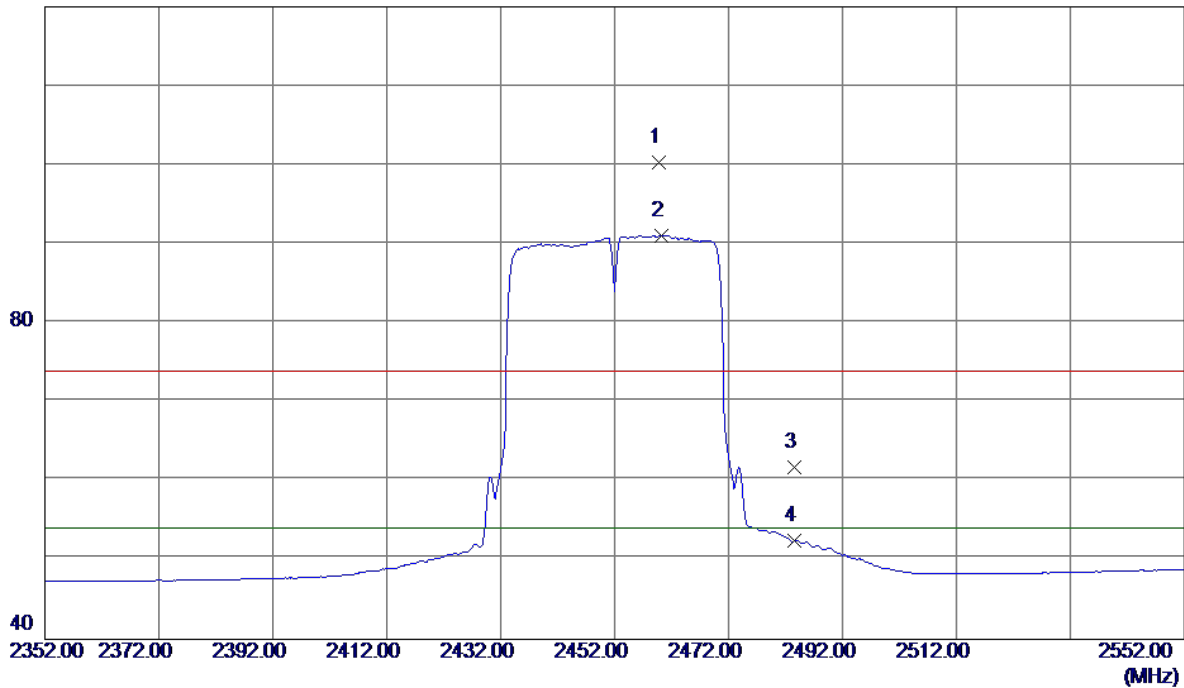

No.	Freq. MHz	Reading Level dBuV/m	Correct Factor dB	Measure ment dBuV/m	Limit dBuV/m	Over dB	Detector	Comment
1	2459.8000	66.76	33.56	100.32	74.00	26.32	Peak	NO LIMIT
2	2460.2000	57.54	33.56	91.10	54.00	37.10	AVG	NO LIMIT
3	2483.5000	28.08	33.62	61.70	74.00	-12.30	Peak	
4	2483.5000	18.83	33.62	52.45	54.00	-1.55	AVG	

Orthogonal Axis :	X
Test Mode :	TX N-40M MODE 2452MHz

Vertical

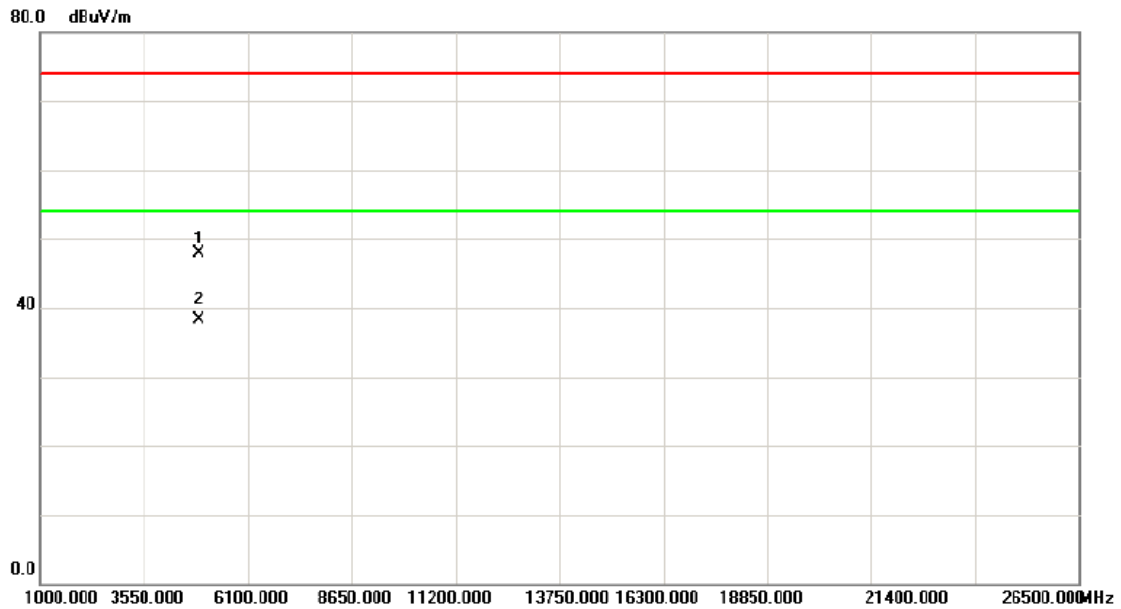

No.	Mk.	Freq. MHz	Reading Level dBuV	Correct Factor dB	Measure- ment dBuV/m	Limit dBuV/m	Margin dB	Detector	Comment
1		4904.267	41.26	6.61	47.87	74.00	-26.13	peak	
2	*	4903.990	31.65	6.61	38.26	54.00	-15.74	AVG	

Orthogonal Axis :	X
Test Mode :	TX N-40M MODE 2452MHz

Horizontal

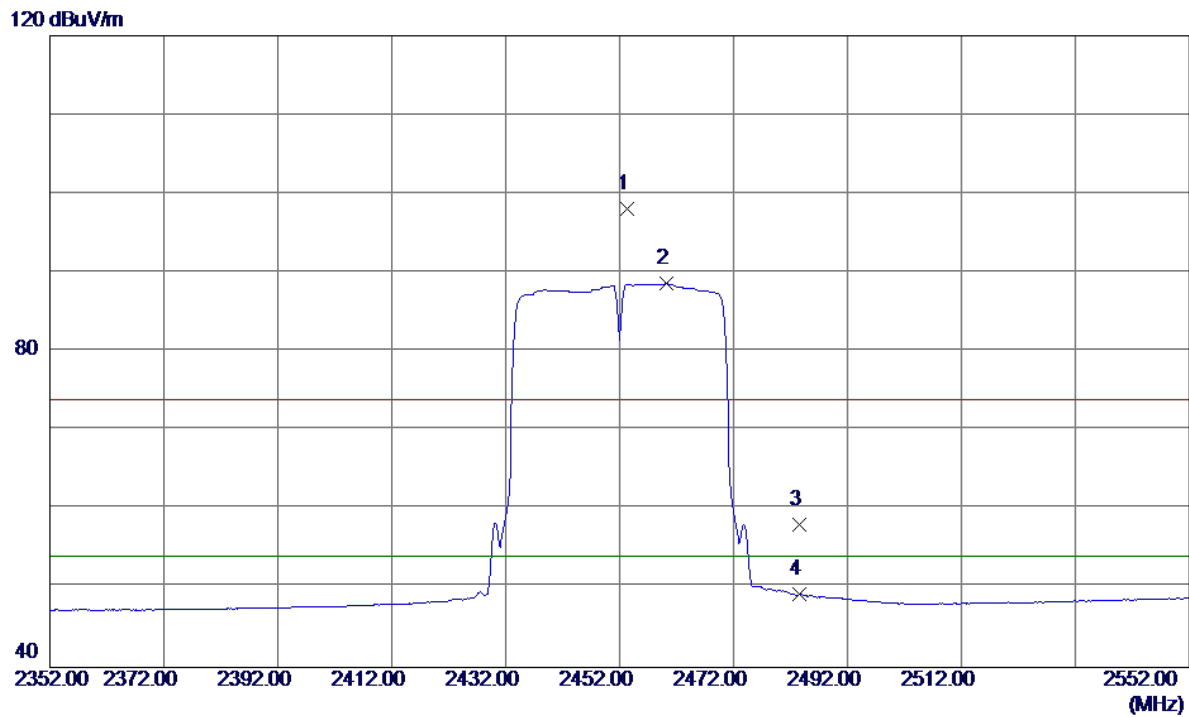

No.	Freq. MHz	Reading Level dBuV/m	Correct Factor dB	Measure ment dBuV/m	Limit dBuV/m	Over dB	Detector	Comment
1	2453.4000	64.59	33.54	98.13	74.00	24.13	Peak	NO LIMIT
2	2460.2000	55.02	33.56	88.58	54.00	34.58	AVG	NO LIMIT
3	2483.5000	24.50	33.62	58.12	74.00	-15.88	Peak	
4	2483.5000	15.59	33.62	49.21	54.00	-4.79	AVG	

Orthogonal Axis :	X
Test Mode :	TX N-40M MODE 2452MHz

Horizontal

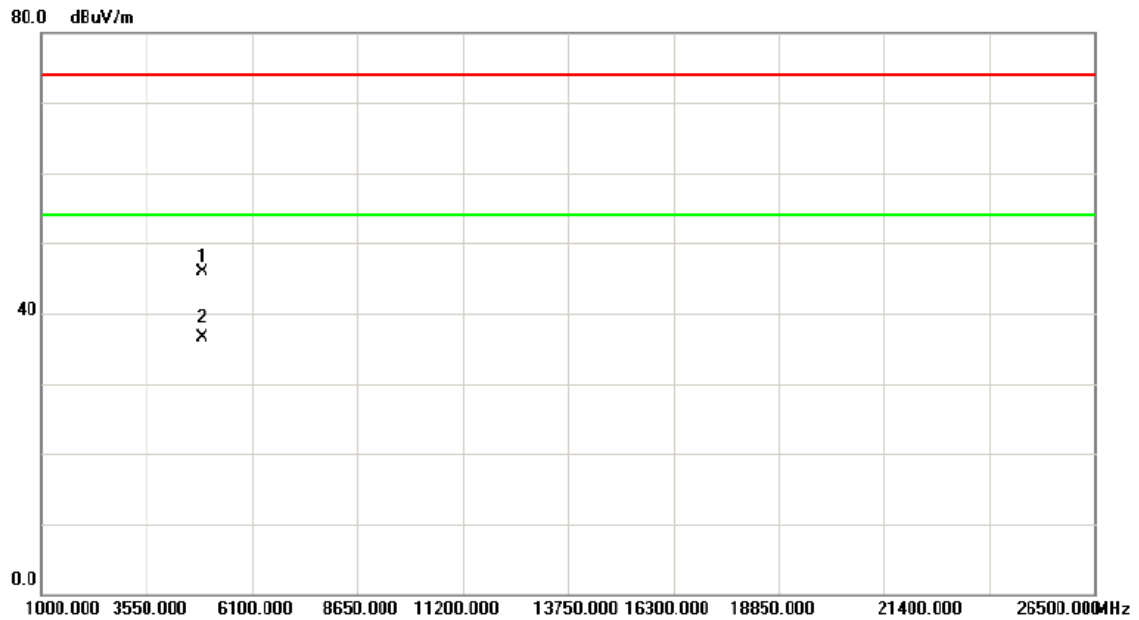

No.	Mk.	Freq. MHz	Reading Level dBuV	Correct Factor dB	Measure- ment dBuV/m	Limit dBuV/m	Margin dB	Detector	Comment
1		4903.983	39.27	6.61	45.88	74.00	-28.12	peak	
2	*	4903.278	29.84	6.61	36.45	54.00	-17.55	AVG	

ATTACHMENT E - BANDWIDTH

Test Mode : TX B Mode_CH01/06/11

Frequency (MHz)	6dB Bandwidth (MHz)	99% Occupied BW (MHz)	Min. Limit (kHz)	Test Result
2412	9.59	15.12	500	Complies
2437	10.06	15.12	500	Complies
2462	10.06	15.12	500	Complies

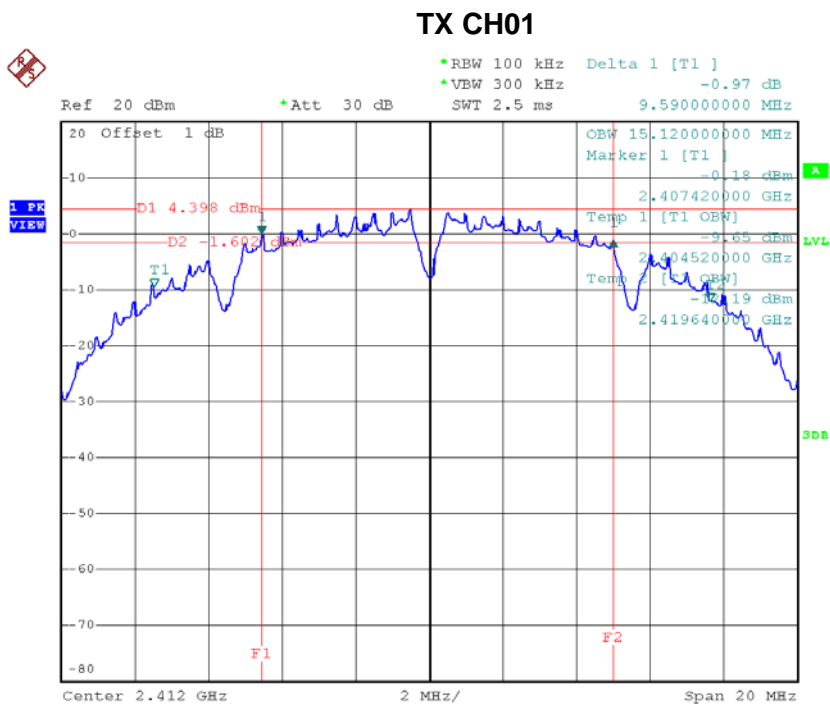

Date: 20.JUL.2015 15:51:37

TX CH06

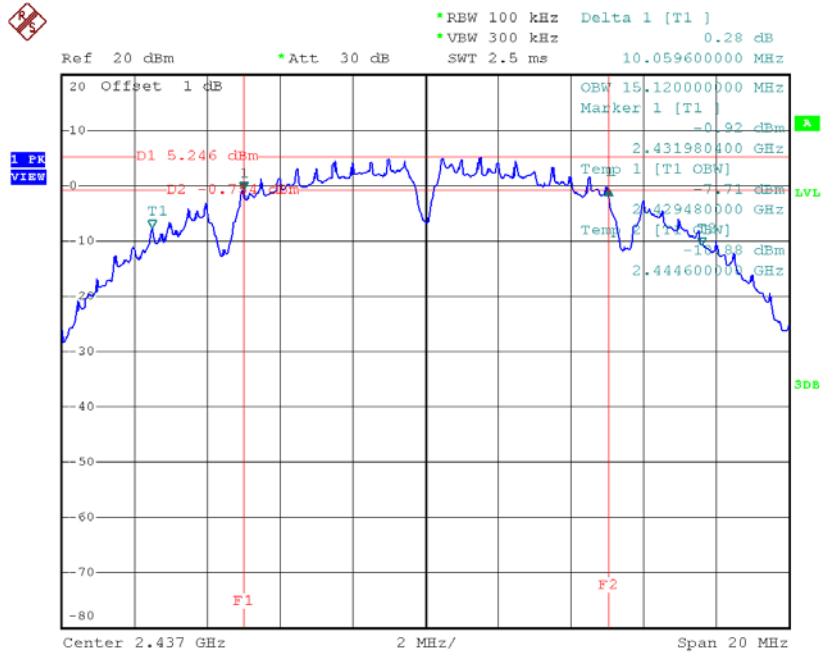

Date: 20.JUL.2015 15:53:41

TX CH11

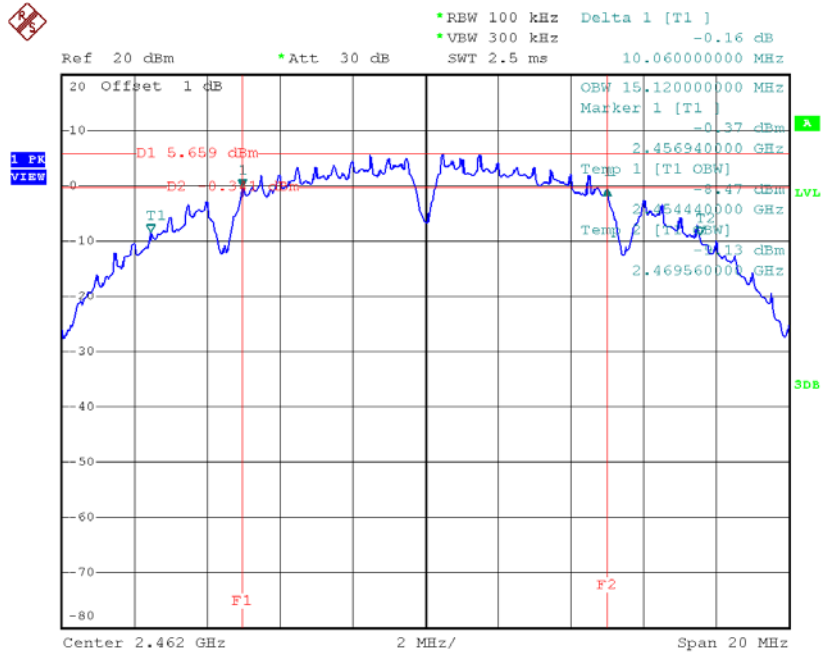

Date: 20.JUL.2015 15:55:05

Test Mode: TX G Mode_CH01/06/11

Frequency (MHz)	6dB Bandwidth (MHz)	99% Occupied BW (MHz)	Min. Limit (kHz)	Test Result
2412	16.43	16.48	500	Complies
2437	16.44	16.48	500	Complies
2462	16.42	16.52	500	Complies

TX CH01

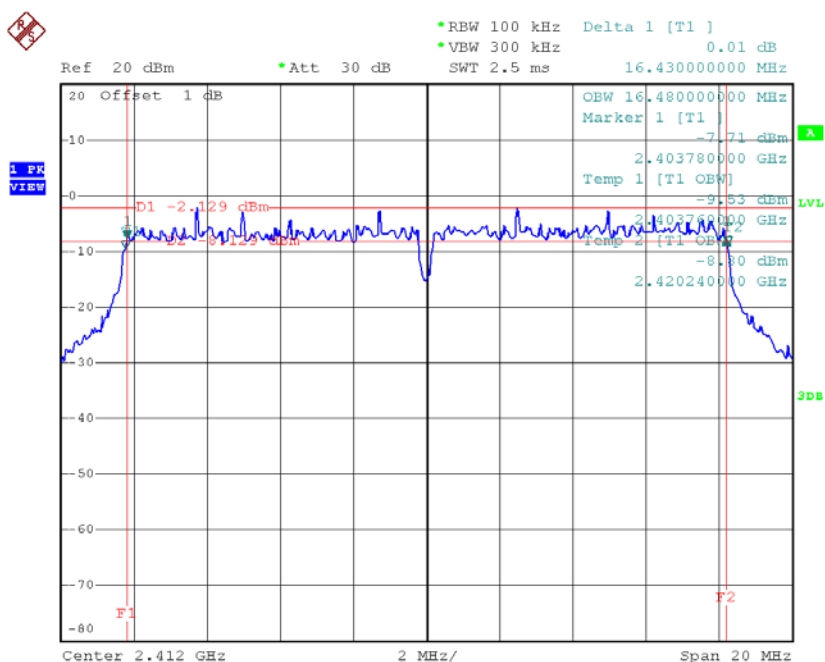

Date: 20.JUL.2015 15:56:56

TX CH06

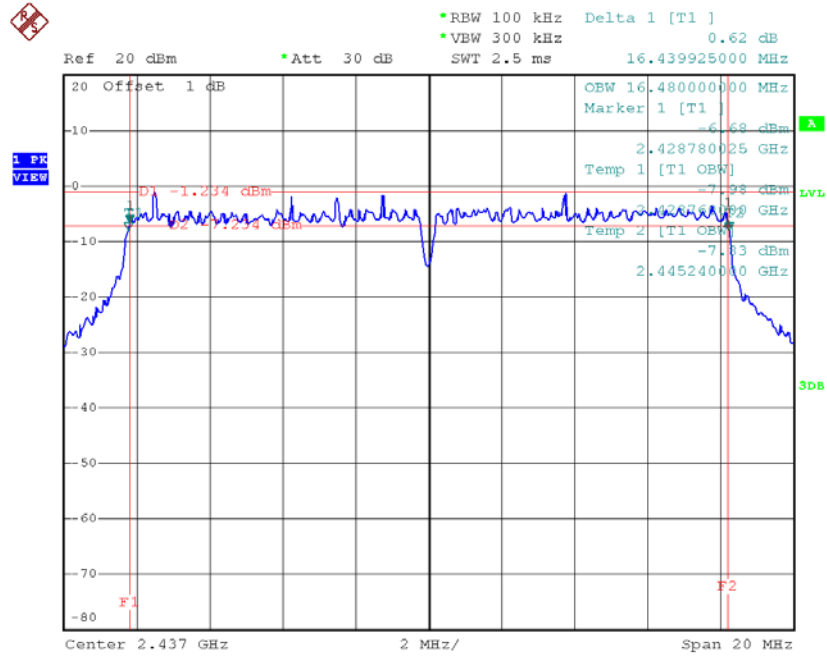

Date: 20.JUL.2015 16:02:11

TX CH11

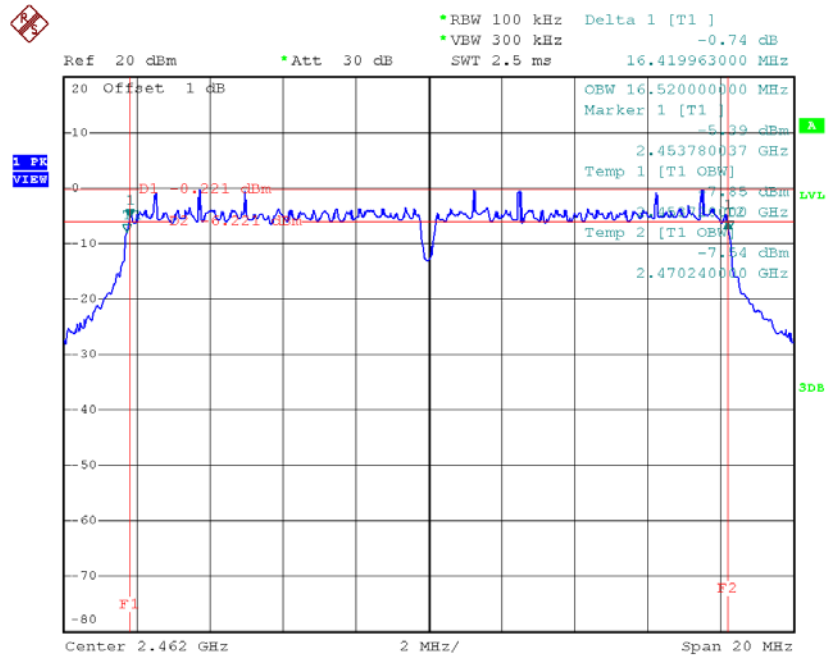

Date: 20.JUL.2015 16:03:09

Test Mode : TX N-20MHz Mode_CH01/06/11

Frequency (MHz)	6dB Bandwidth (MHz)	99% Occupied BW (MHz)	Min. Limit (kHz)	Test Result
2412	17.64	17.64	500	Complies
2437	17.62	17.64	500	Complies
2462	17.68	17.68	500	Complies

TX CH01

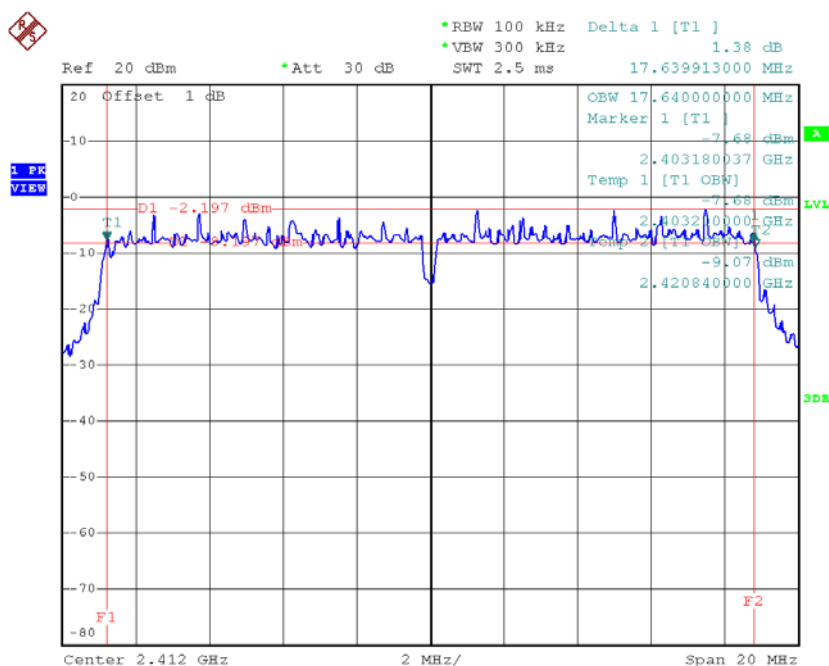

Date: 20.JUL.2015 16:16:22

TX CH06

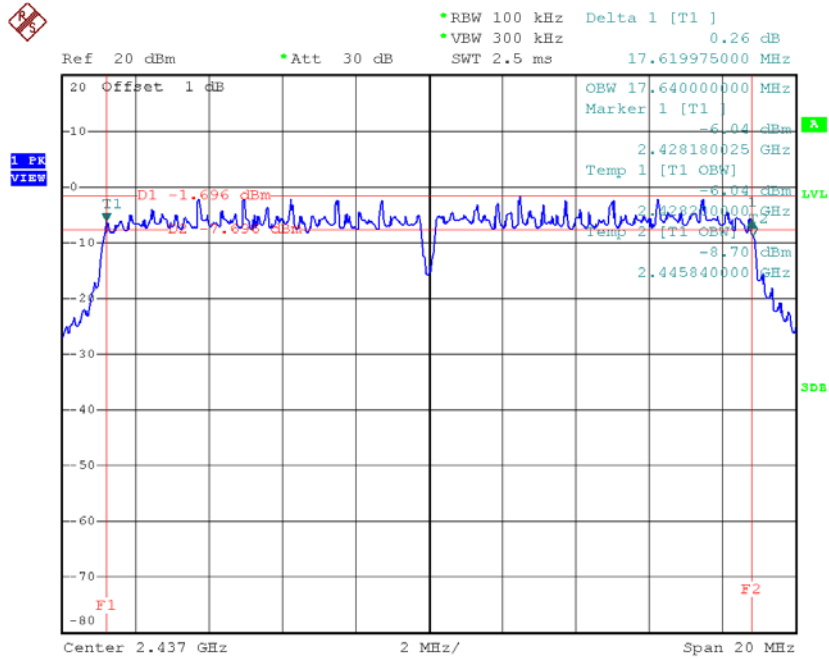

Date: 20.JUL.2015 16:17:49

TX CH11

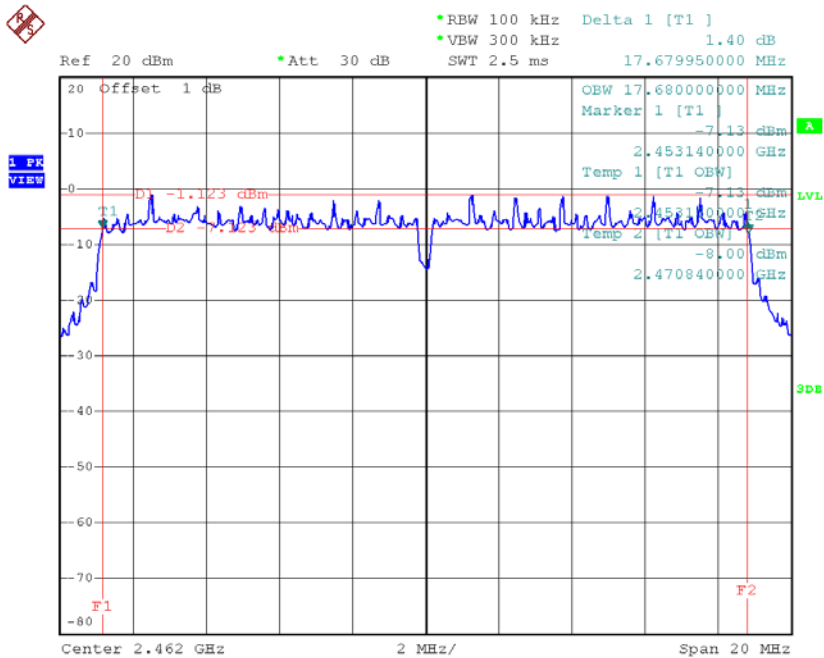

Date: 20.JUL.2015 16:20:00

Test Mode : TX N-40MHz Mode_CH03/06/09

Frequency (MHz)	6dB Bandwidth (MHz)	99% Occupied BW (MHz)	Min. Limit (kHz)	Test Result
2422	35.84	36.00	500	Complies
2437	35.85	36.08	500	Complies
2452	36.36	36.08	500	Complies

TX CH03

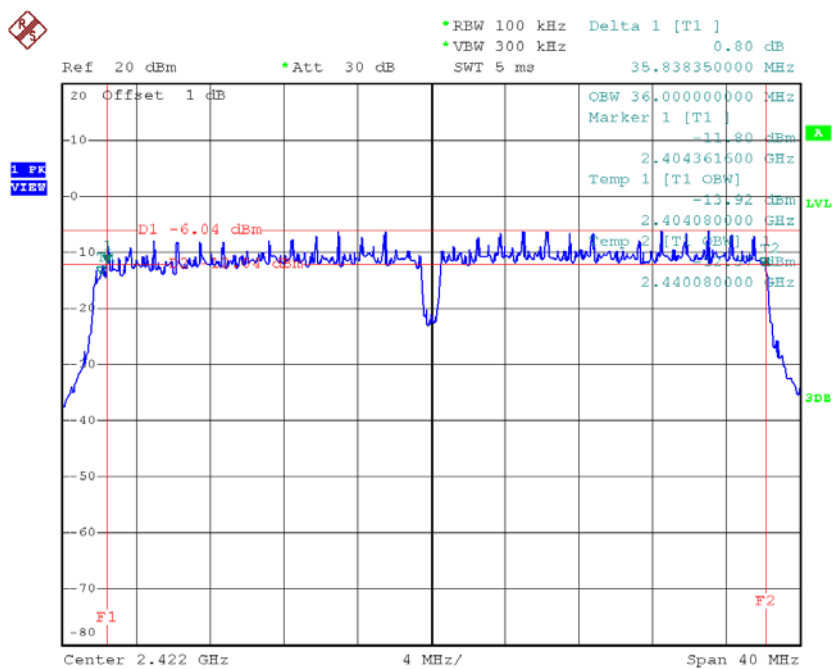

Date: 20.JUL.2015 16:24:53

TX CH06

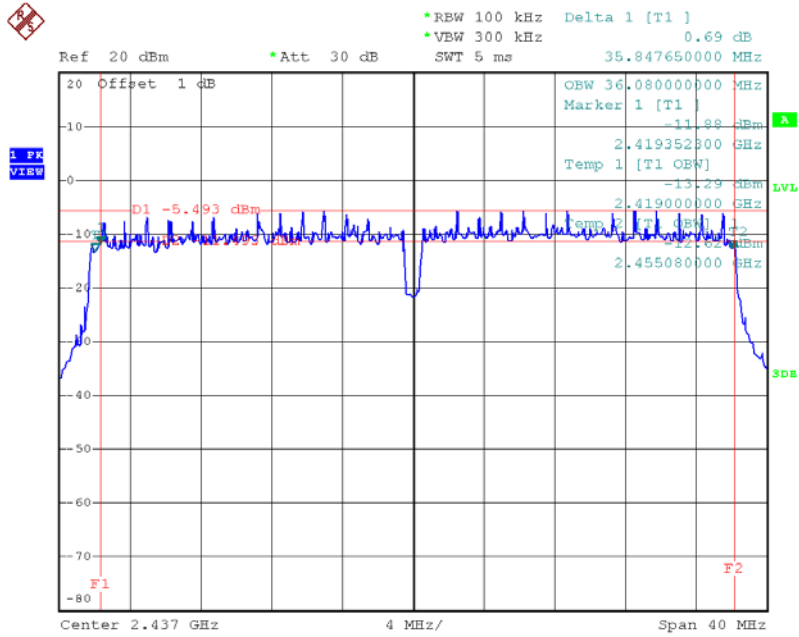

Date: 20.JUL.2015 16:26:05

TX CH09

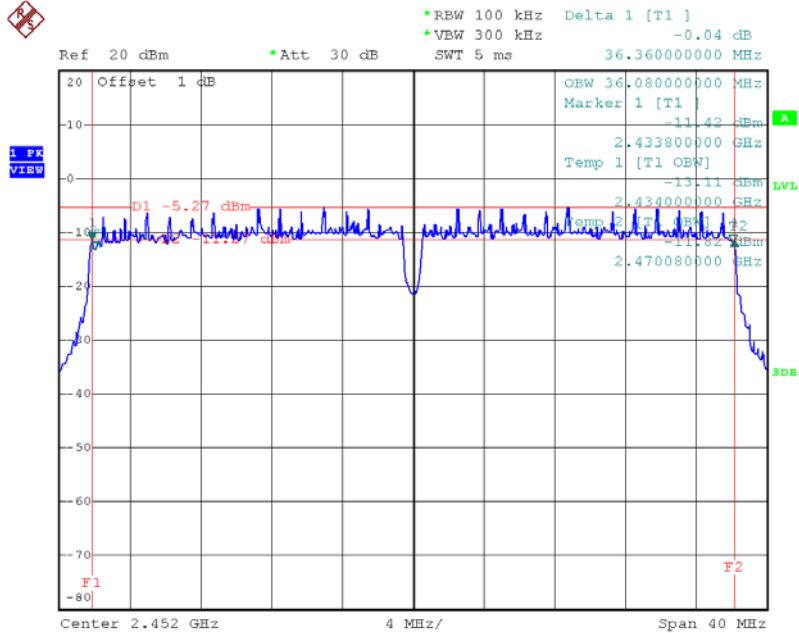

Date: 20.JUL.2015 16:26:55

ATTACHMENT F – MAXIMUM PEAK CONDUCTED OUTPUT POWER

Test Mode :TX B Mode_CH01/06/11_ANT 1					
Frequency (MHz)	Conducted Power (dBm)	Conducted Power (W)	Max. Limit (dBm)	Max. Limit (W)	Result
2412	13.92	0.02	30.00	1.00	Complies
2437	14.01	0.03	30.00	1.00	Complies
2462	14.12	0.03	30.00	1.00	Complies

Test Mode :TX G Mode_CH01/06/11_ANT 1					
Frequency (MHz)	Conducted Power (dBm)	Conducted Power (W)	Max. Limit (dBm)	Max. Limit (W)	Result
2412	13.88	0.02	30.00	1.00	Complies
2437	13.79	0.02	30.00	1.00	Complies
2462	13.67	0.02	30.00	1.00	Complies

Test Mode :TX N20 Mode_CH01/06/11_ANT 1					
Frequency (MHz)	Conducted Power (dBm)	Conducted Power (W)	Max. Limit (dBm)	Max. Limit (W)	Result
2412	10.85	0.01	30.00	1.00	Complies
2437	10.69	0.01	30.00	1.00	Complies
2462	11.08	0.01	30.00	1.00	Complies

Test Mode :TX N20 Mode_CH01/06/11_ANT 2					
Frequency (MHz)	Conducted Power (dBm)	Conducted Power (W)	Max. Limit (dBm)	Max. Limit (W)	Result
2412	10.55	0.01	30.00	1.00	Complies
2437	10.74	0.01	30.00	1.00	Complies
2462	10.68	0.01	30.00	1.00	Complies

Test Mode :TX N20 Mode_CH01/06/11_Total					
Frequency (MHz)	Conducted Power (dBm)	Conducted Power (W)	Max. Limit (dBm)	Max. Limit (W)	Result
2412	13.71	0.02	30.00	1.00	Complies
2437	13.73	0.02	30.00	1.00	Complies
2462	13.89	0.02	30.00	1.00	Complies

Test Mode :TX N40 Mode_CH03/06/09_ANT 1					
Frequency (MHz)	Conducted Power (dBm)	Conducted Power (W)	Max. Limit (dBm)	Max. Limit (W)	Result
2422	10.64	0.01	30.00	1.00	Complies
2437	10.83	0.01	30.00	1.00	Complies
2452	10.93	0.01	30.00	1.00	Complies

Test Mode :TX N40 Mode_CH03/06/09_ANT 2					
Frequency (MHz)	Conducted Power (dBm)	Conducted Power (W)	Max. Limit (dBm)	Max. Limit (W)	Result
2422	10.72	0.01	30.00	1.00	Complies
2437	10.64	0.01	30.00	1.00	Complies
2452	10.81	0.01	30.00	1.00	Complies

Test Mode :TX N40 Mode_CH03/06/09_Total					
Frequency (MHz)	Conducted Power (dBm)	Conducted Power (W)	Max. Limit (dBm)	Max. Limit (W)	Result
2422	13.69	0.02	30.00	1.00	Complies
2437	13.75	0.02	30.00	1.00	Complies
2452	13.88	0.02	30.00	1.00	Complies

**ATTACHMENT G - ANTENNA CONDUCTED SPURIOUS
EMISSION**

Test Mode :	TX B Mode
--------------------	------------------

TX B mode CH01

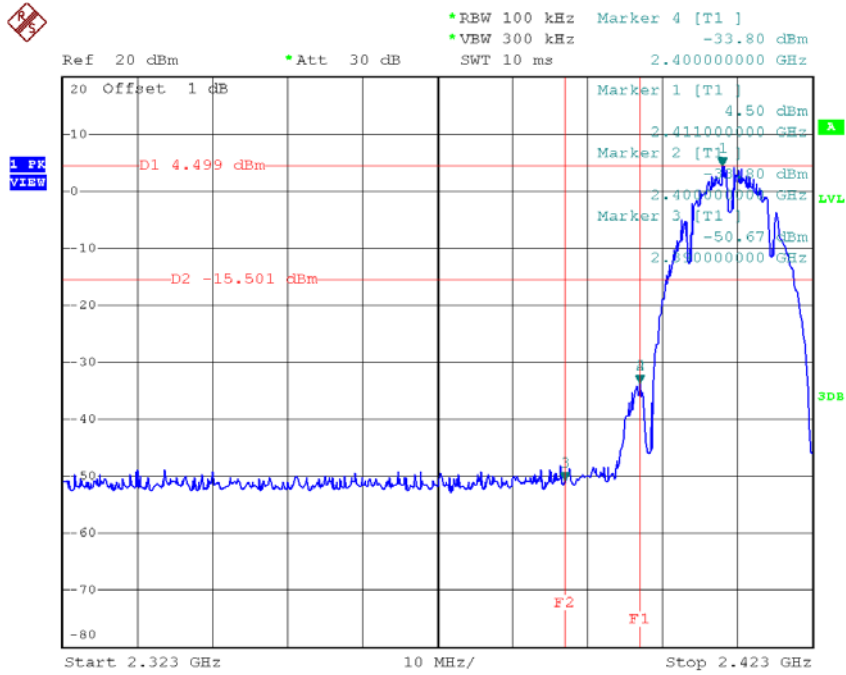

Date: 20.JUL.2015 15:51:59

TX B mode CH11

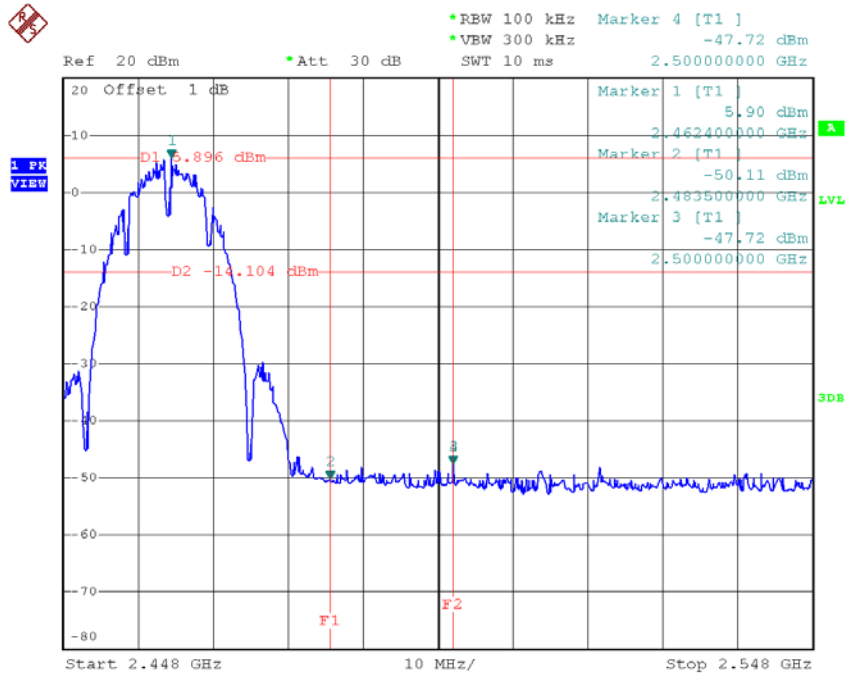

Date: 20.JUL.2015 15:55:26

TX B mode CH01 (10 Harmonic of the frequency)

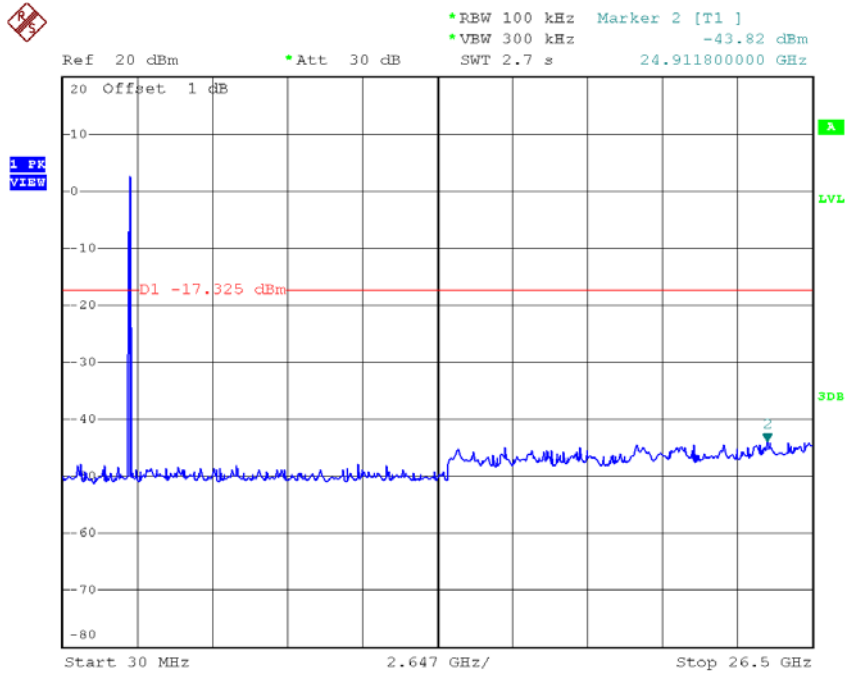

Date: 20.JUL.2015 15:51:51

TX B mode CH06 (10 Harmonic of the frequency)

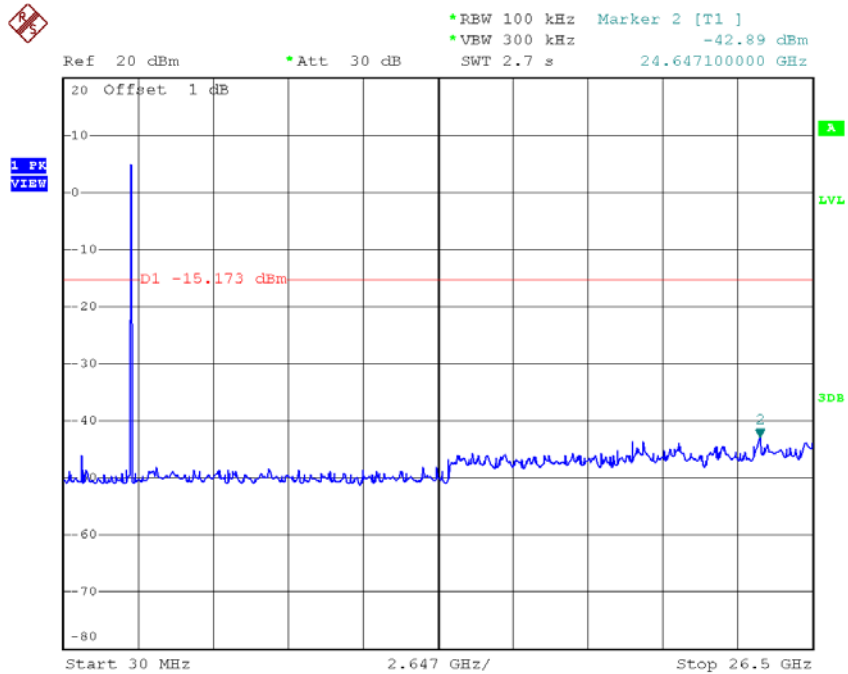

Date: 20.JUL.2015 15:53:56

TX B mode CH11 (10 Harmonic of the frequency)



Ref 20 dBm *Att 30 dB *REW 100 kHz Marker 2 [T1]
*VBW 300 kHz -43.27 dBm
SWT 2.7 s 22.105980000 GHz

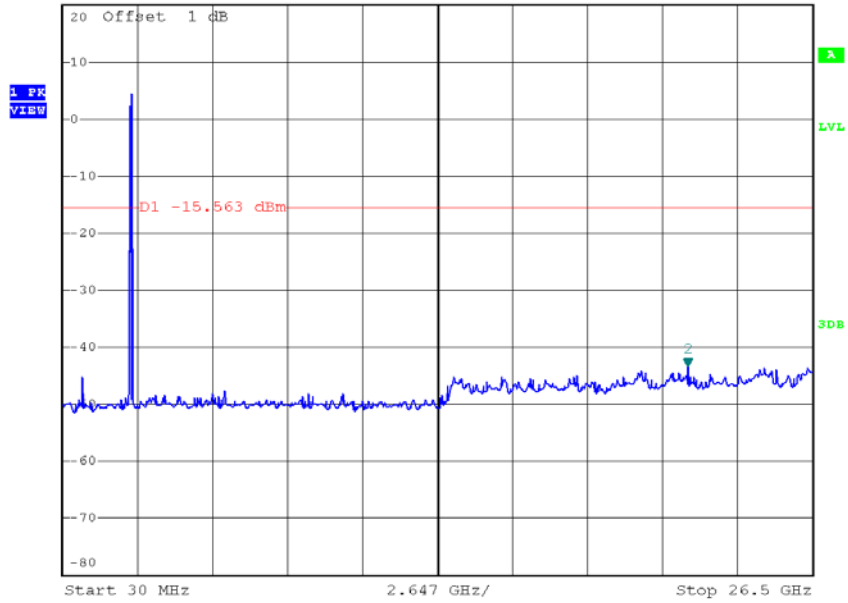

Date: 20.JUL.2015 15:55:19

Test Mode :	TX G Mode
--------------------	------------------

TX G mode CH01

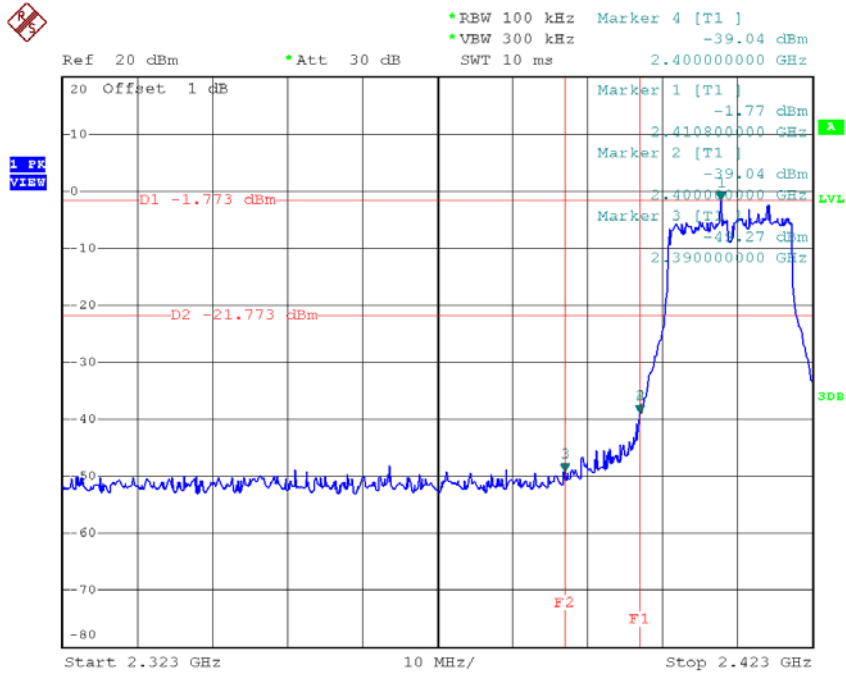

Date: 20.JUL.2015 15:57:18

TX G mode CH11

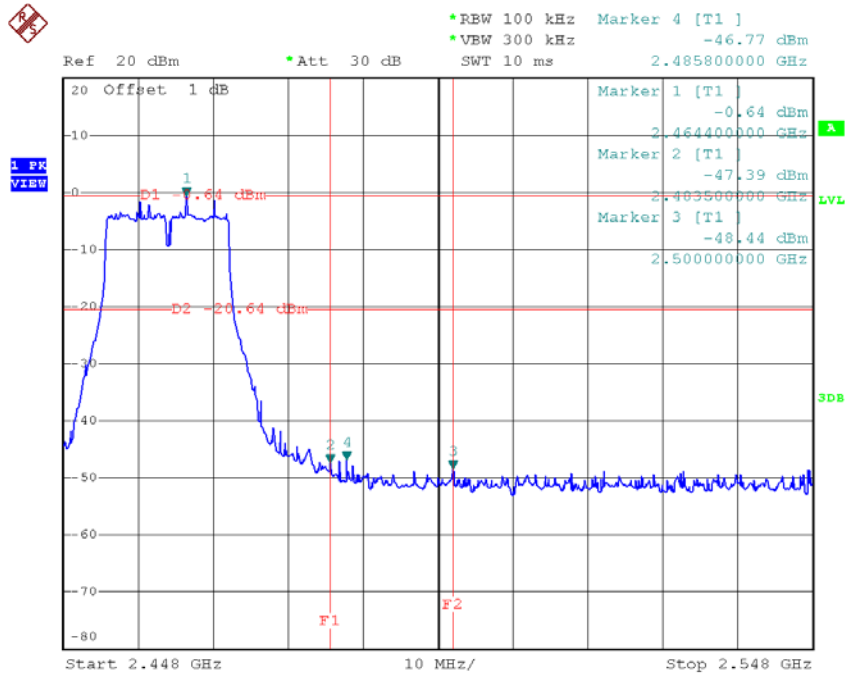

Date: 20.JUL.2015 16:03:30

TX G mode CH01 (10 Harmonic of the frequency)

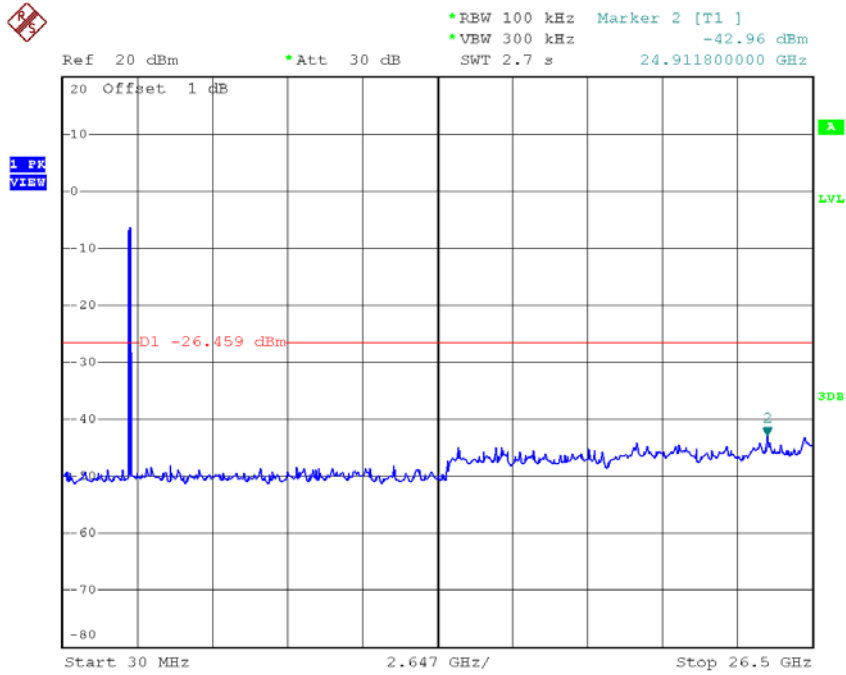

Date: 20.JUL.2015 15:57:10

TX G mode CH06 (10 Harmonic of the frequency)

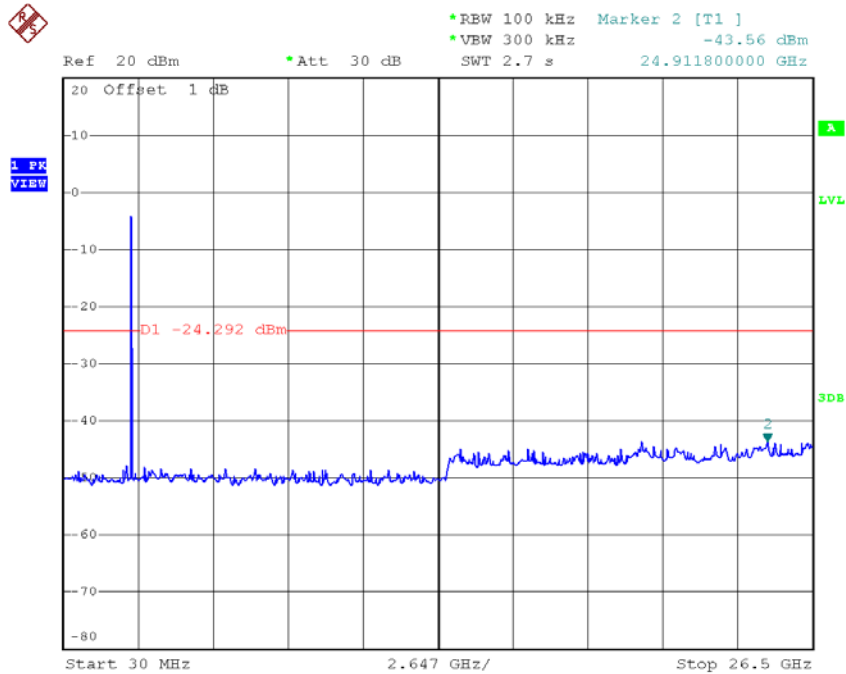

Date: 20.JUL.2015 16:02:25

TX G mode CH11 (10 Harmonic of the frequency)

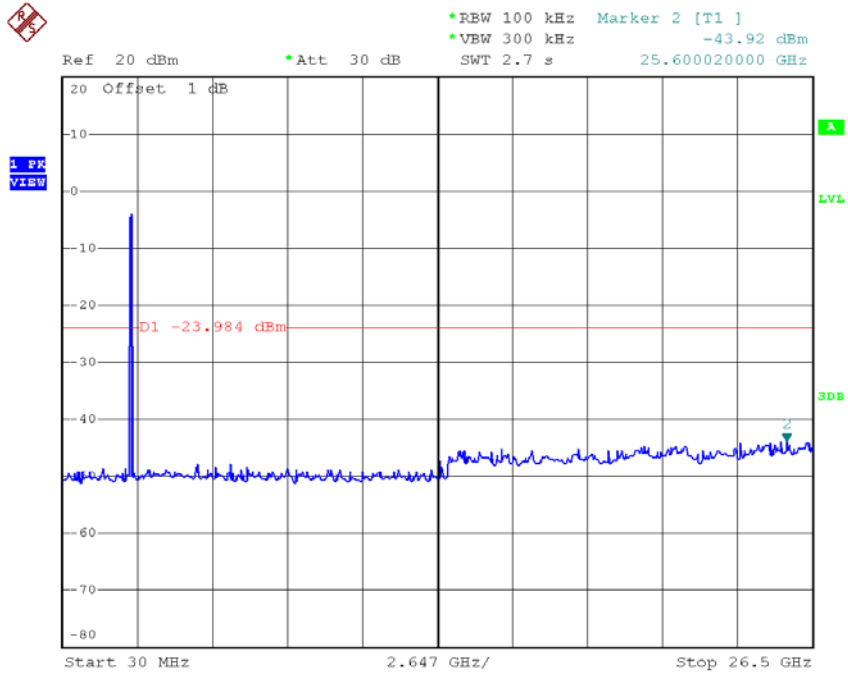

Date: 20.JUL.2015 16:03:23

Test Mode :	TX N-20M Mode_ANT 1
--------------------	----------------------------

TX HT20 mode CH01

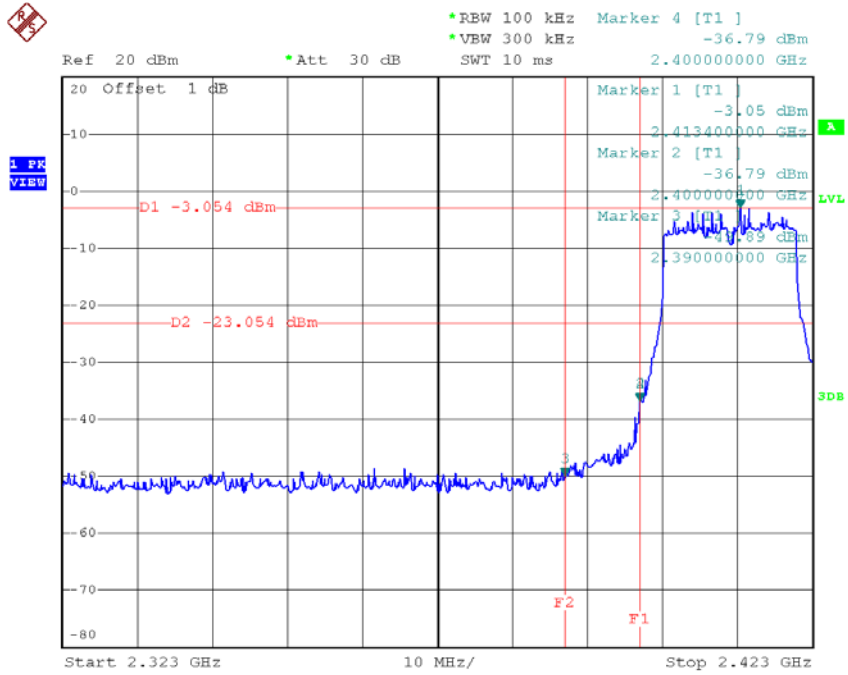

Date: 20.JUL.2015 16:16:44

TX HT20 mode CH11

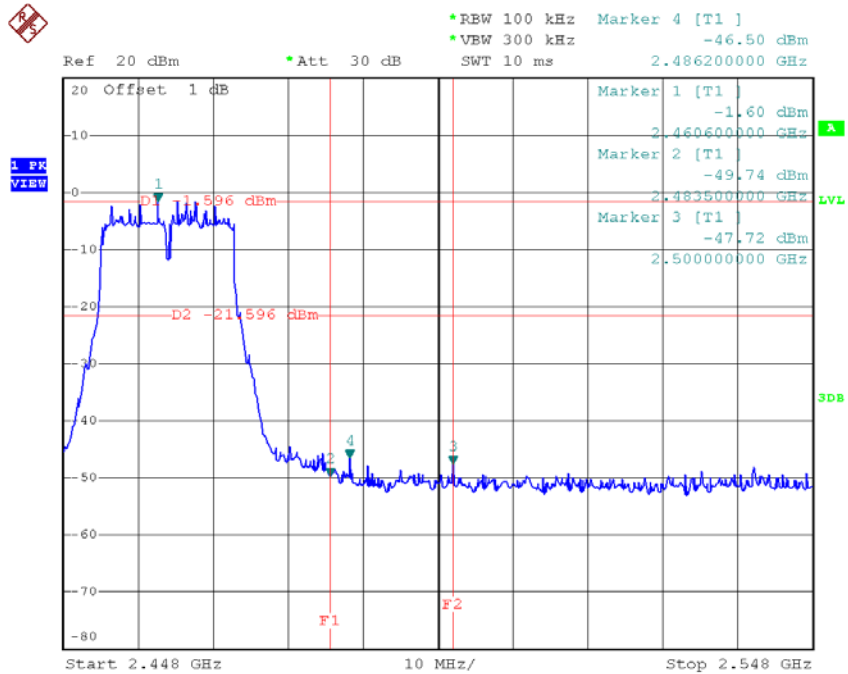

Date: 20.JUL.2015 16:20:22

TX HT20 mode CH01 (10 Harmonic of the frequency)

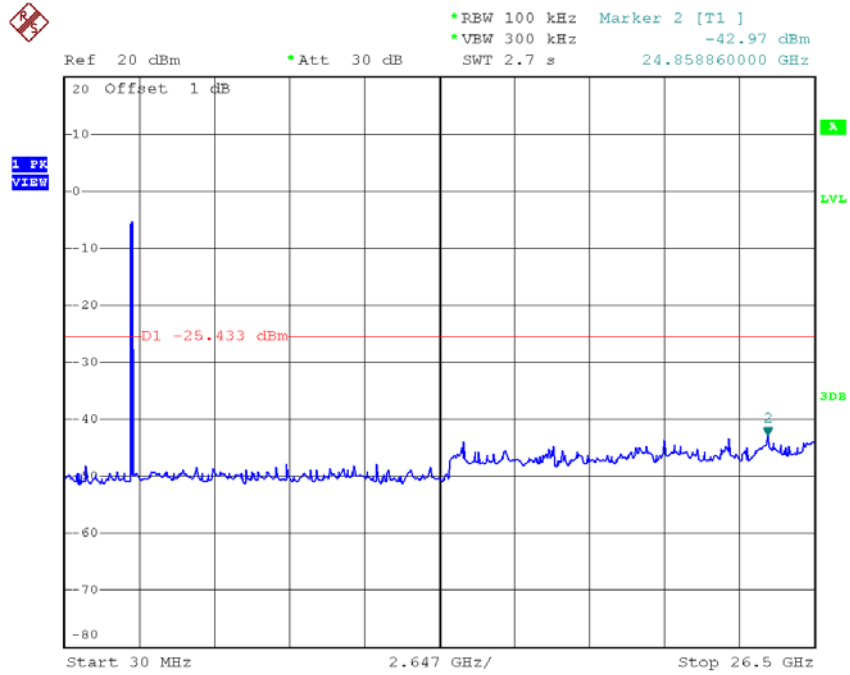

Date: 20.JUL.2015 16:16:36

TX HT20 mode CH06 (10 Harmonic of the frequency)

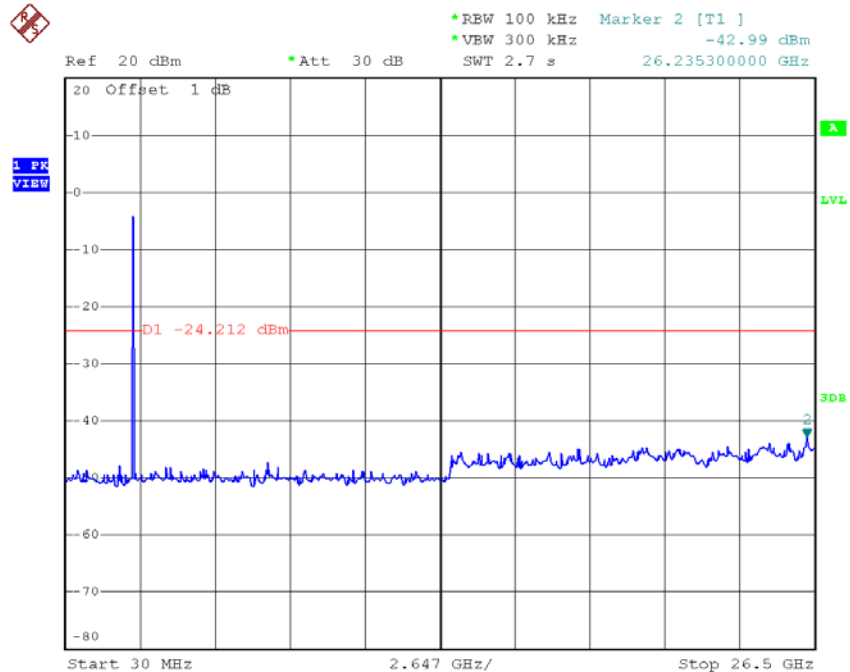

Date: 20.JUL.2015 16:18:03

TX HT20 mode CH11 (10 Harmonic of the frequency)

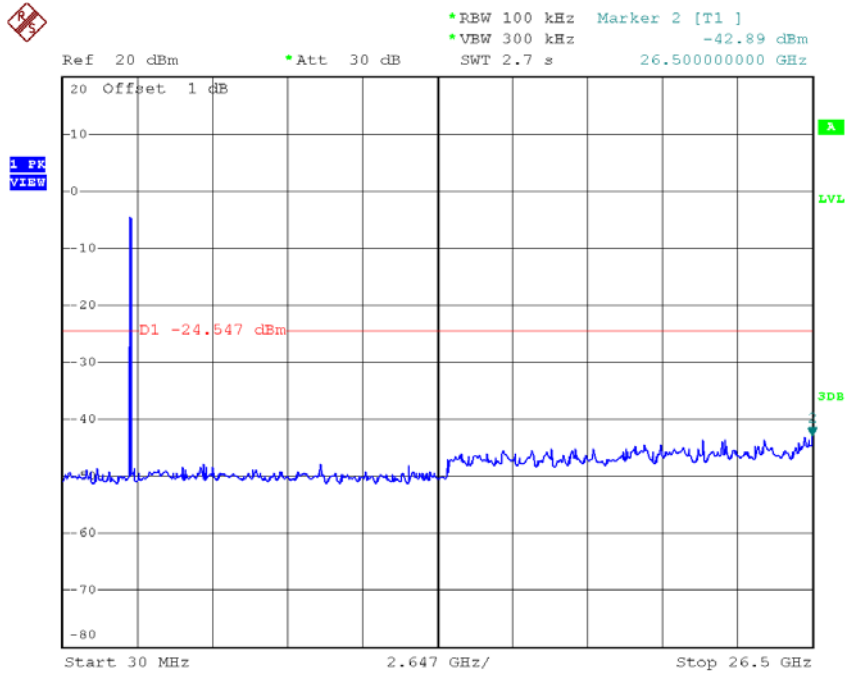

Date: 20.JUL.2015 16:20:14

Test Mode :	TX N-20M Mode_ANT 2
--------------------	----------------------------

TX HT20 mode CH01

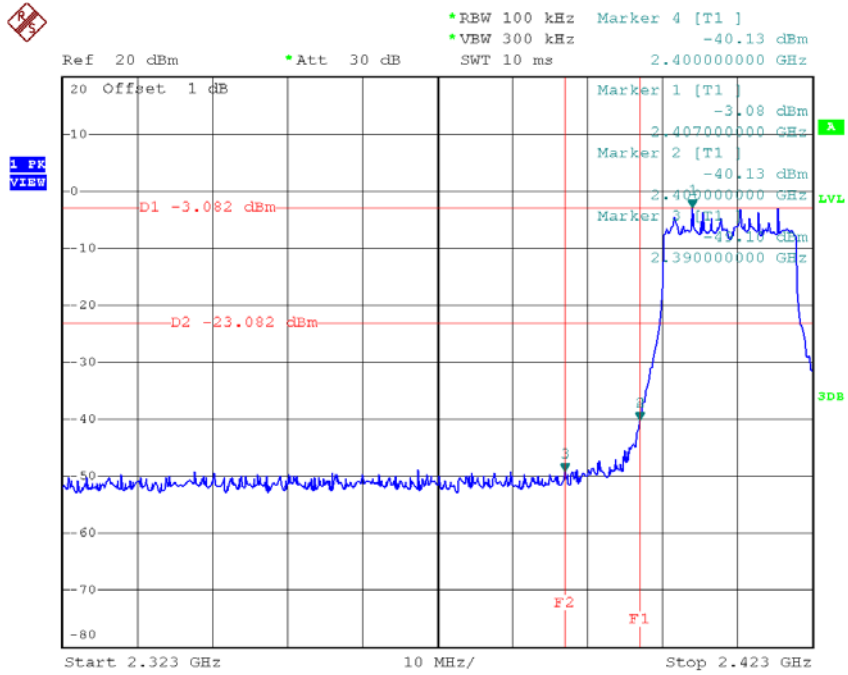

Date: 20.JUL.2015 16:21:56

TX HT20 mode CH11

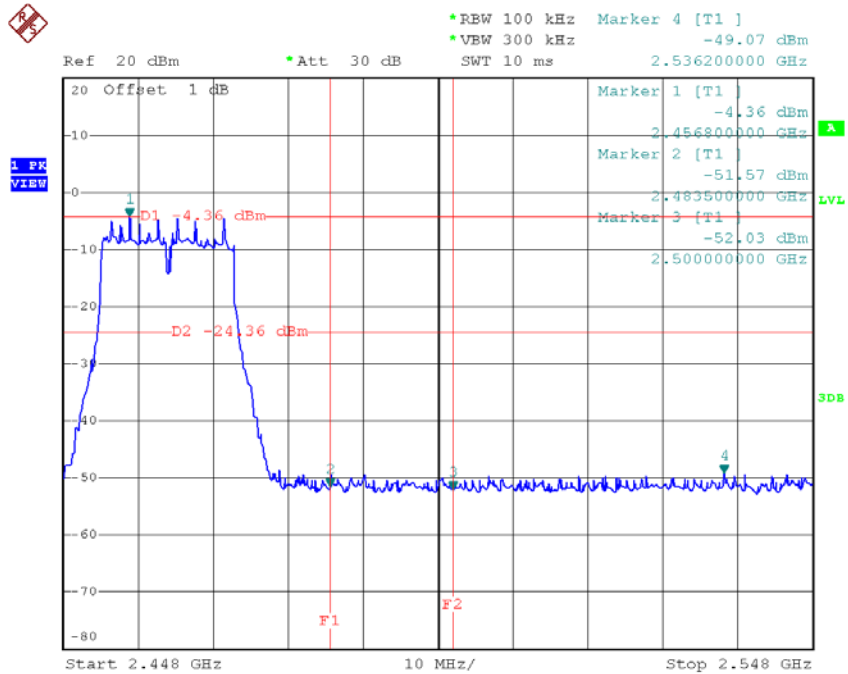

Date: 20.JUL.2015 16:23:40

TX HT20 mode CH01 (10 Harmonic of the frequency)

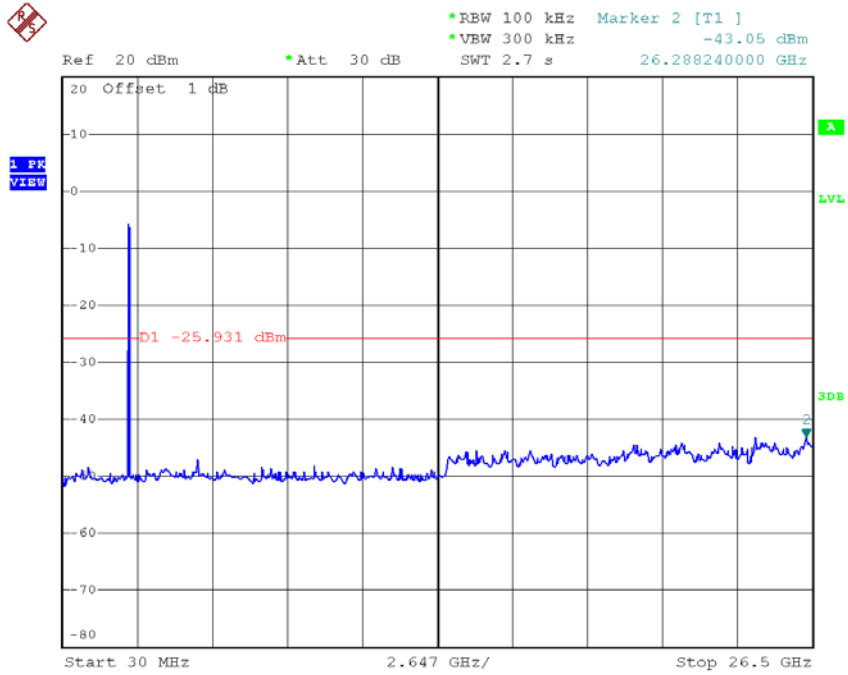

Date: 20.JUL.2015 16:21:49

TX HT20 mode CH06 (10 Harmonic of the frequency)

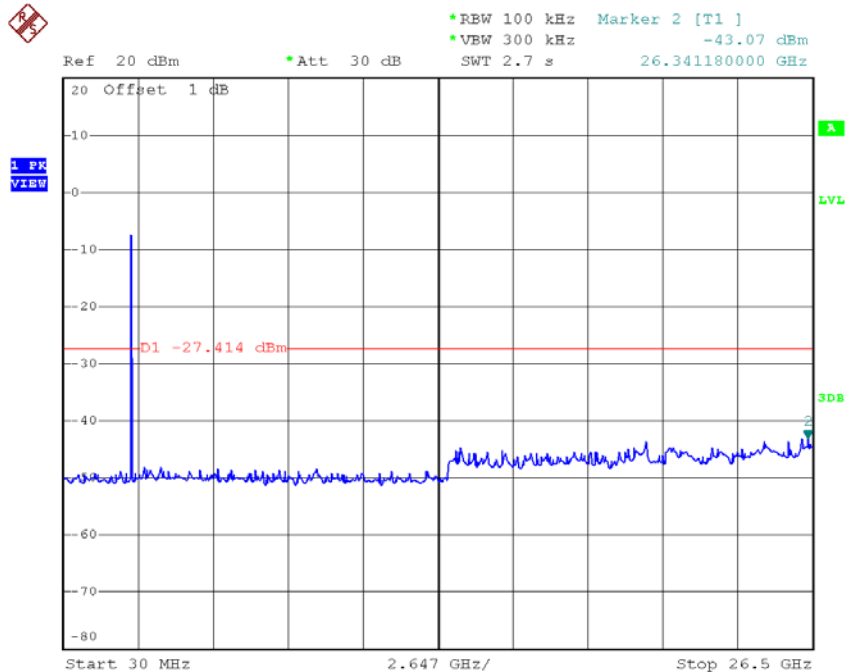

Date: 20.JUL.2015 16:22:44

TX HT20 mode CH11 (10 Harmonic of the frequency)

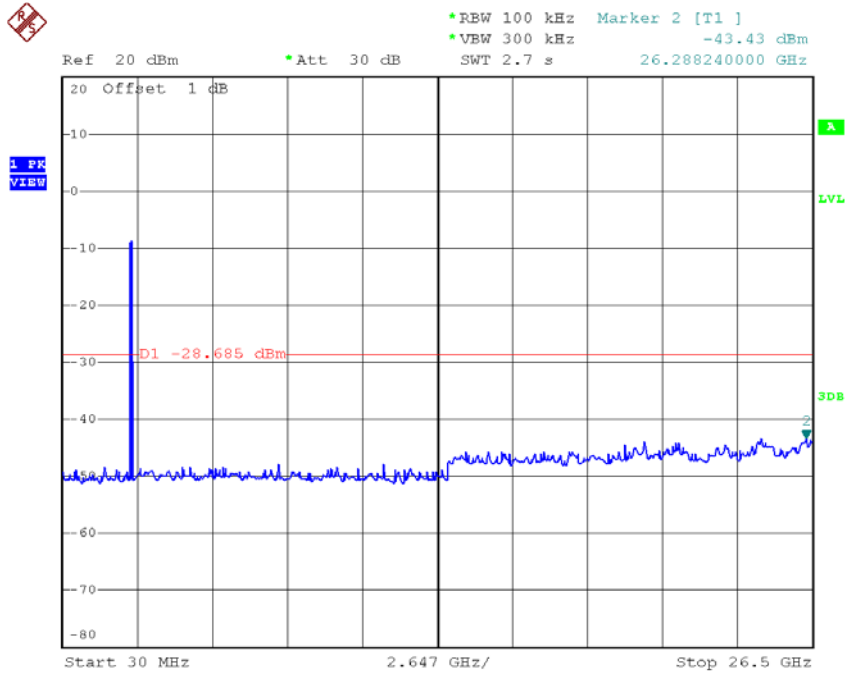

Date: 20.JUL.2015 16:23:32

Test Mode :	TX N-40M Mode_ANT 1
--------------------	----------------------------

TX HT40 mode CH03 (10 Harmonic of the frequency)

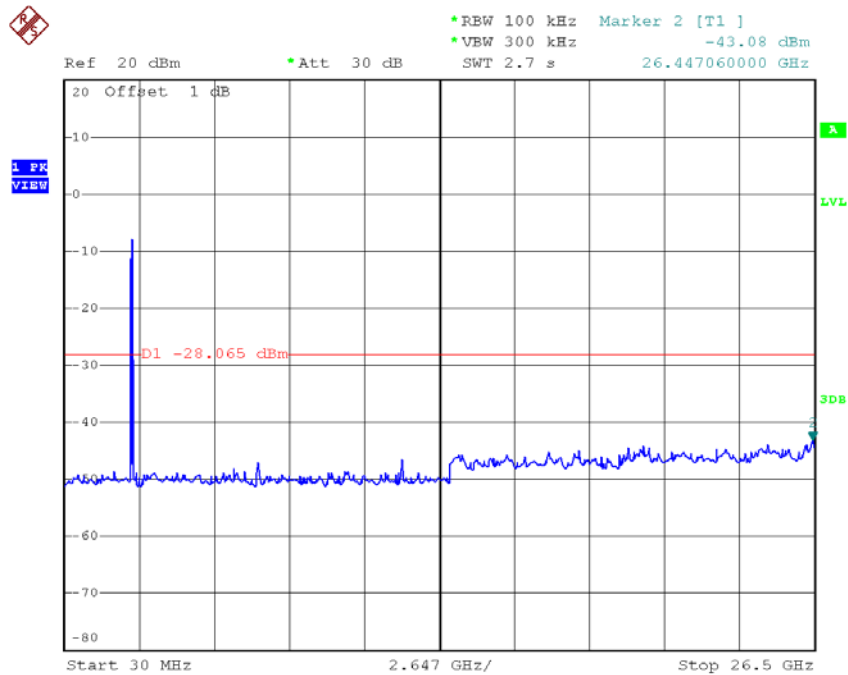

Date: 20.JUL.2015 16:25:07

TX HT40 mode CH06 (10 Harmonic of the frequency)

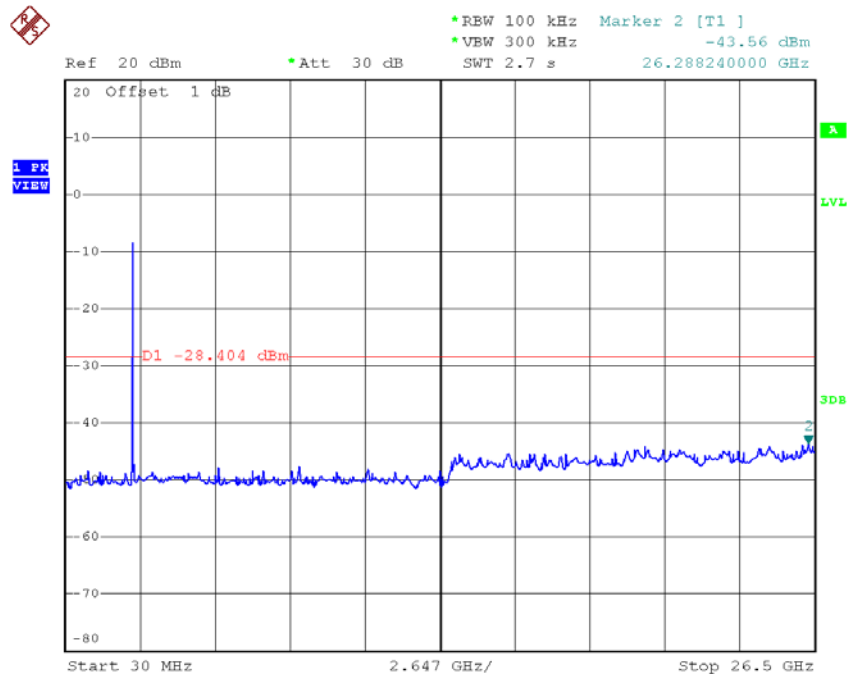

Date: 20.JUL.2015 16:26:19

TX HT40 mode CH09 (10 Harmonic of the frequency)



Ref 20 dBm *Att 30 dB *REW 100 kHz Marker 2 [T1]
*VBW 300 kHz -43.46 dBm
SWT 2.7 s 24.858860000 GHz

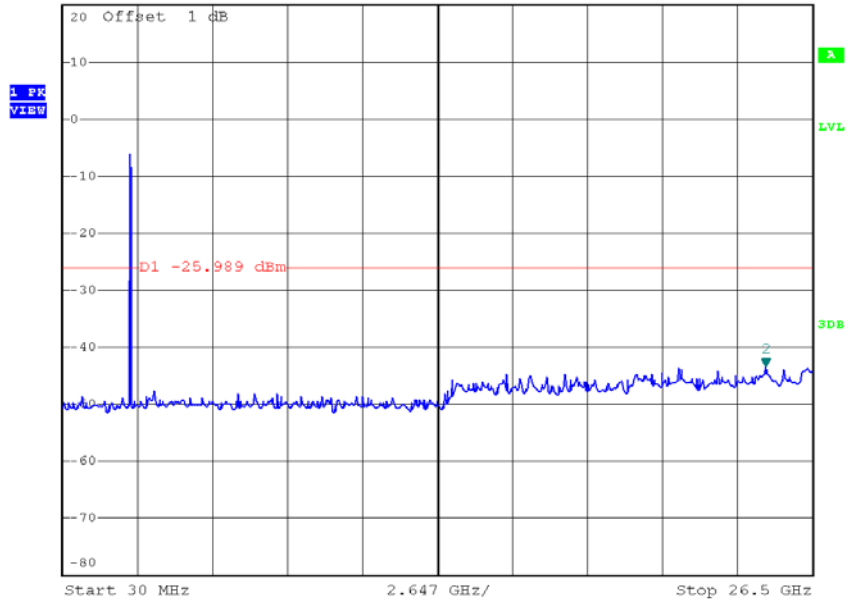

Date: 20.JUL.2015 16:27:09

Test Mode :	TX N-40M Mode_ANT 2
--------------------	----------------------------

TX HT40 mode CH03

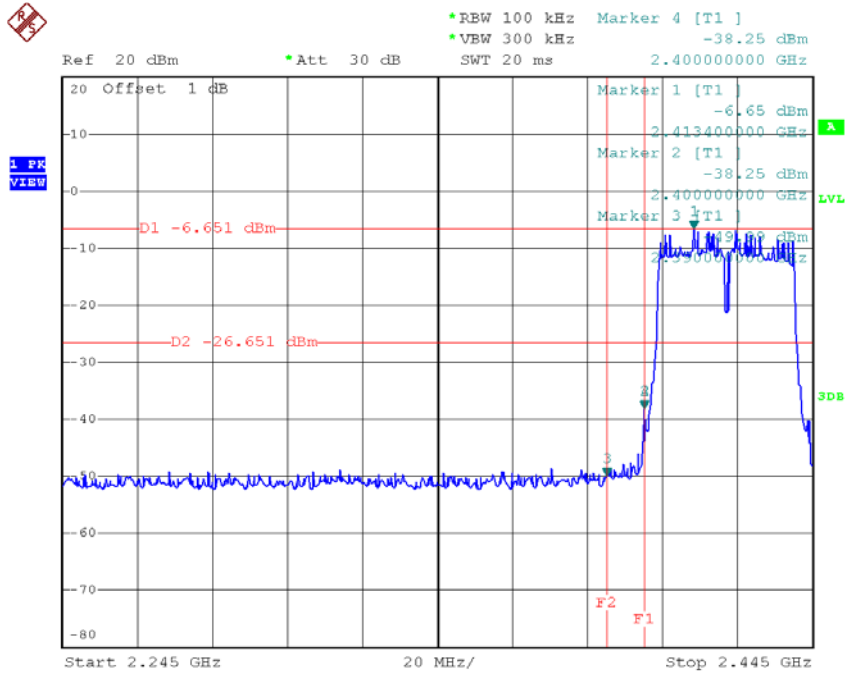

Date: 20.JUL.2015 16:28:39

TX HT40 mode CH09

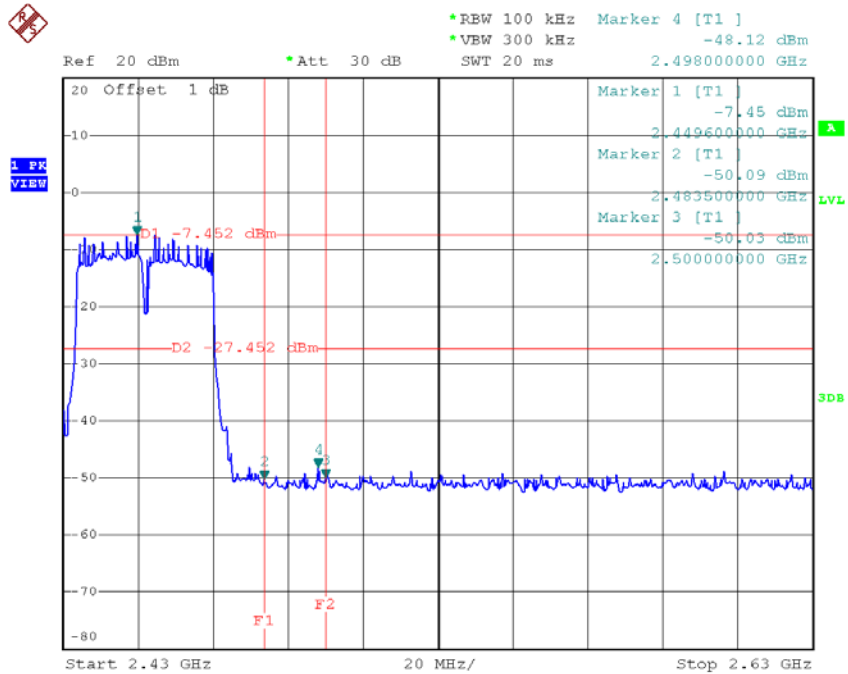

Date: 20.JUL.2015 16:31:56

TX HT40 mode CH03 (10 Harmonic of the frequency)

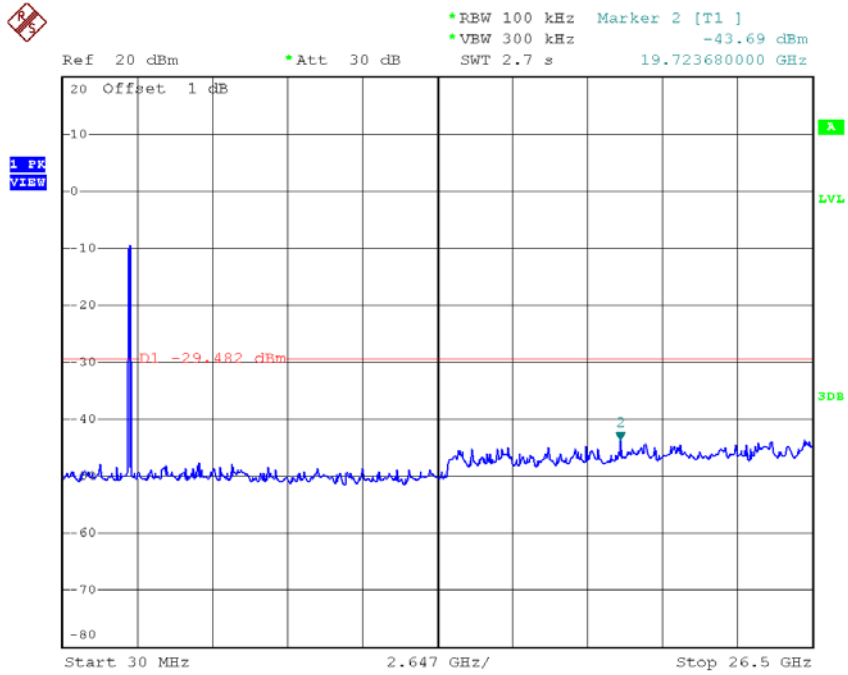

Date: 20.JUL.2015 16:28:32

TX HT40 mode CH06 (10 Harmonic of the frequency)

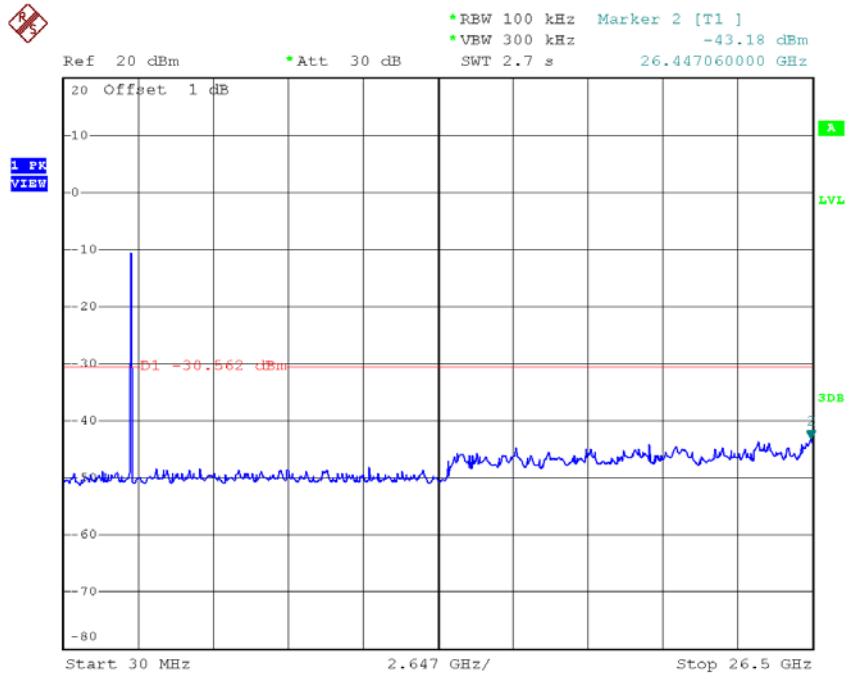

Date: 20.JUL.2015 16:29:59

TX HT40 mode CH09 (10 Harmonic of the frequency)

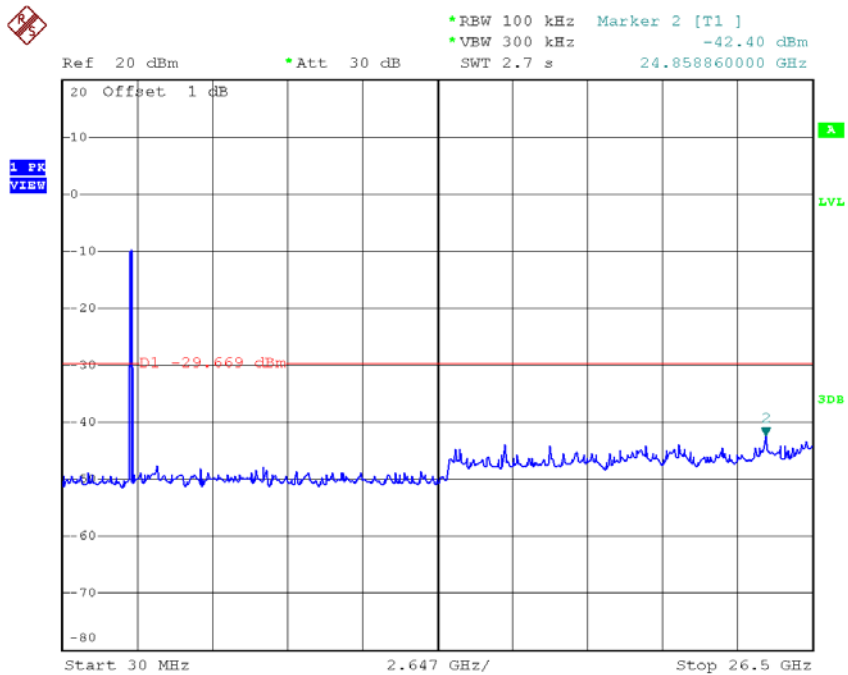

Date: 20.JUL.2015 16:31:49

ATTACHMENT H - POWER SPECTRAL DENSITY

Test Mode :TX B Mode_CH01/06/11_ANT 1

Frequency (MHz)	Power Density (dBm/3kHz)	Power Density (mW/3kHz)	Max. Limit (dBm/3kHz)	Result
2412	-6.00	0.25	8.00	Complies
2437	-8.23	0.15	8.00	Complies
2462	-5.07	0.31	8.00	Complies

TX CH01

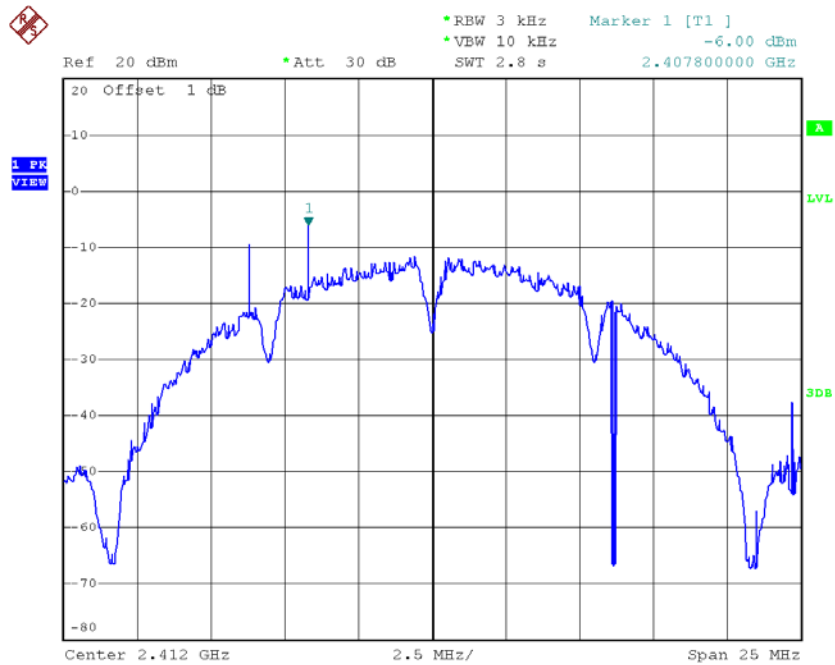

Date: 20.JUL.2015 15:52:08

Test Mode :TX G Mode_CH01/06/11_ANT 1

Frequency (MHz)	Power Density (dBm/3kHz)	Power Density (mW/3kHz)	Max. Limit (dBm/3kHz)	Result
2412	-18.09	0.02	8.00	Complies
2437	-17.23	0.02	8.00	Complies
2462	-17.36	0.02	8.00	Complies

TX CH01

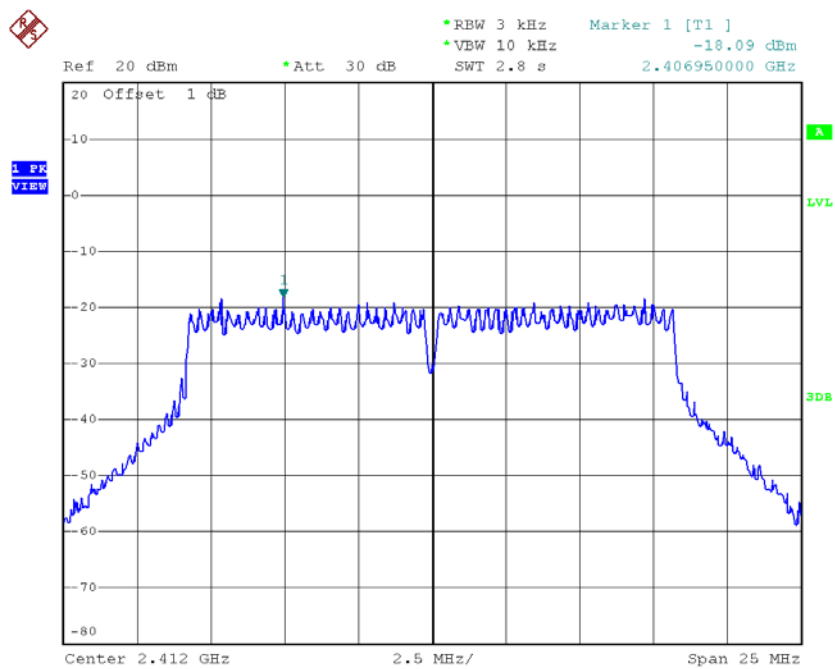

Date: 20.JUL.2015 16:01:38

TX CH06

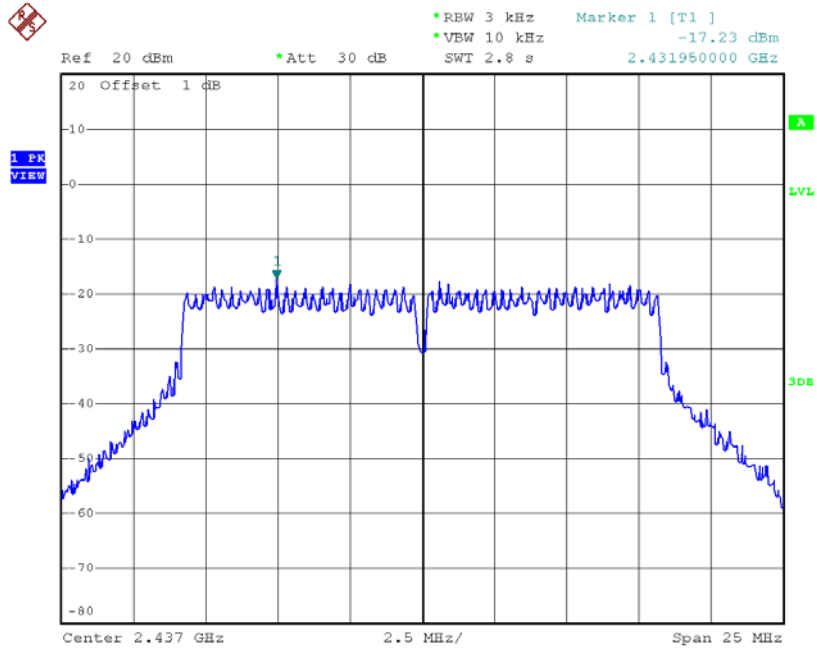

Date: 20.JUL.2015 16:02:34

TX CH11

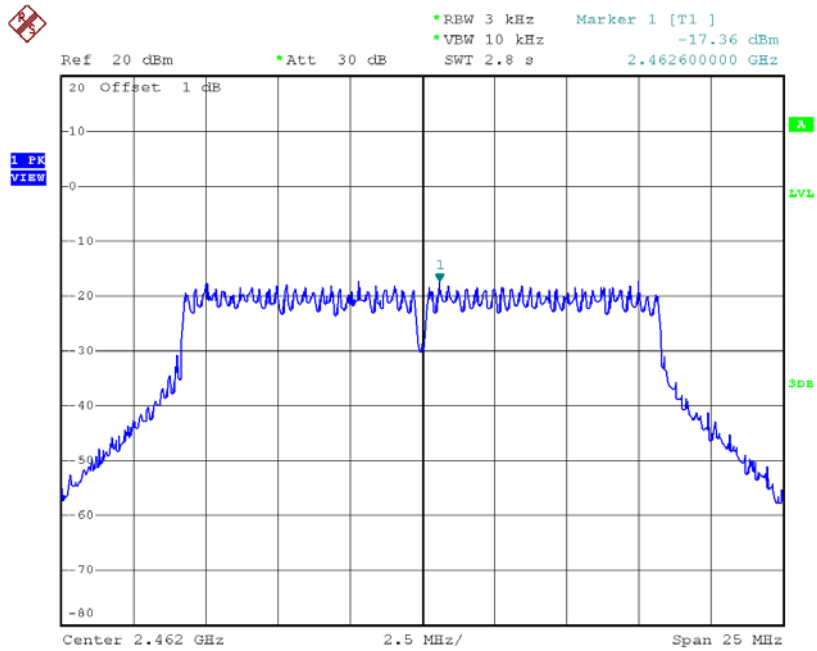

Date: 20.JUL.2015 16:03:40

Test Mode : TX N-20M Mode_CH01/06/11_ANT 1

Frequency (MHz)	Power Density (dBm/3kHz)	Power Density (mW/3kHz)	Max. Limit (dBm/3kHz)	Result
2412	-18.91	0.01	8.00	Complies
2437	-18.04	0.02	8.00	Complies
2462	-18.22	0.02	8.00	Complies

TX CH01

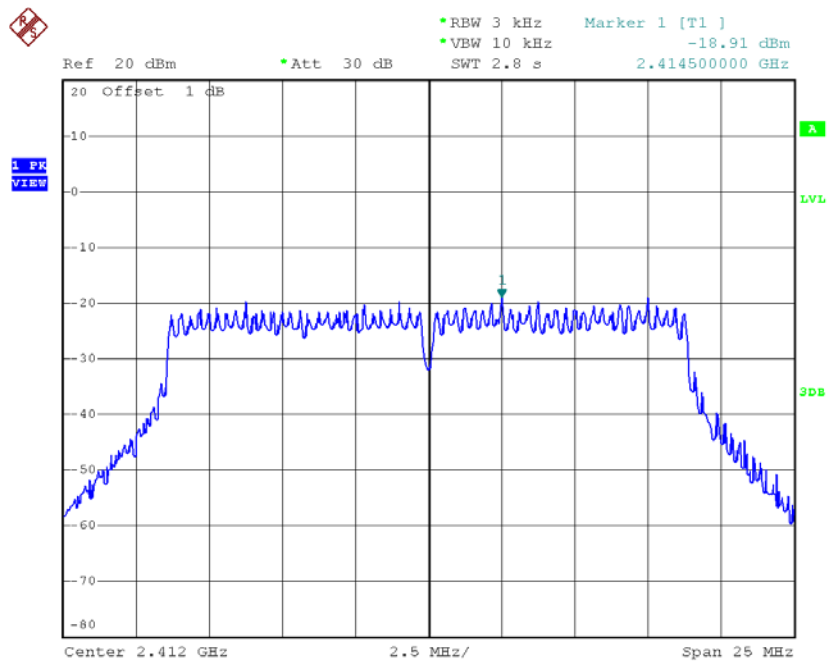

Date: 20.JUL.2015 16:16:53

TX CH06

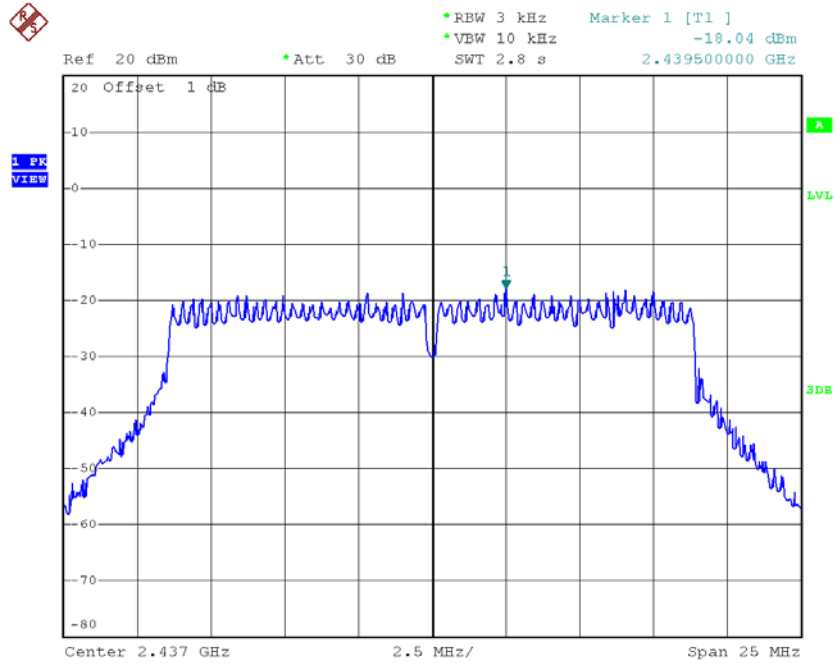

Date: 20.JUL.2015 16:19:05

TX CH11

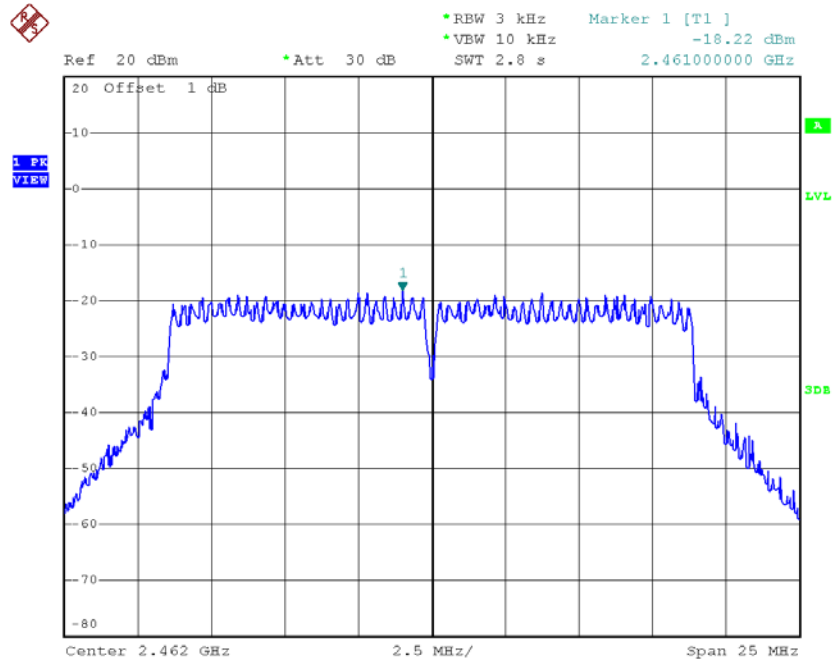

Date: 20.JUL.2015 16:20:31

Test Mode : TX N-20M Mode_CH01/06/11_ANT 2

Frequency (MHz)	Power Density (dBm/3kHz)	Power Density (mW/3kHz)	Max. Limit (dBm/3kHz)	Result
2412	-19.28	0.01	8.00	Complies
2437	-20.14	0.01	8.00	Complies
2462	-20.56	0.01	8.00	Complies

TX CH01

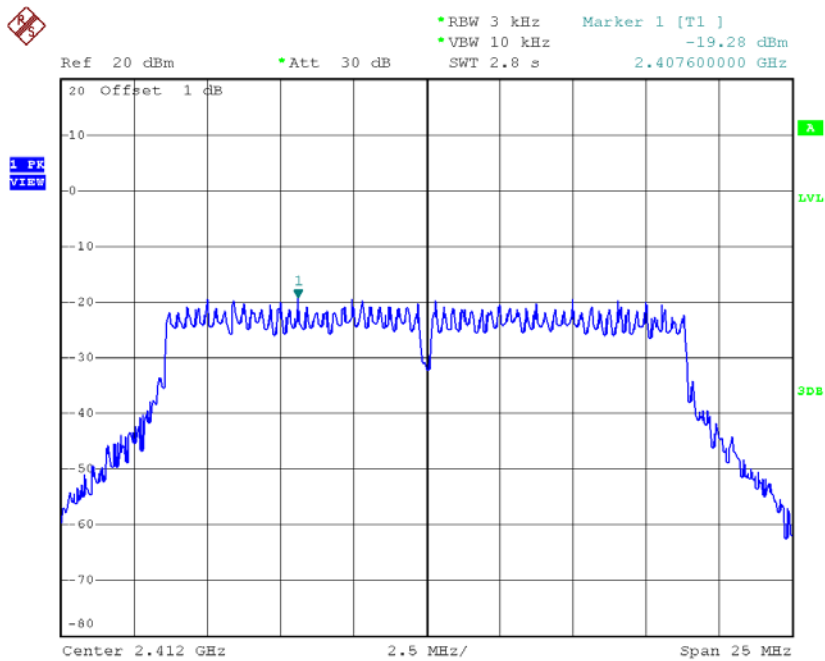

Date: 20.JUL.2015 16:22:05

TX CH06

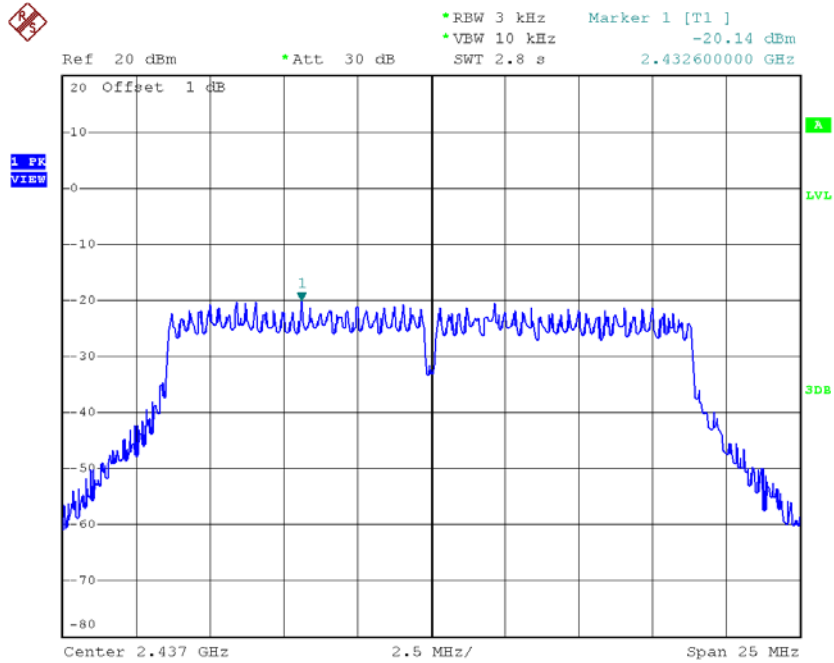

Date: 20.JUL.2015 16:22:53

TX CH11

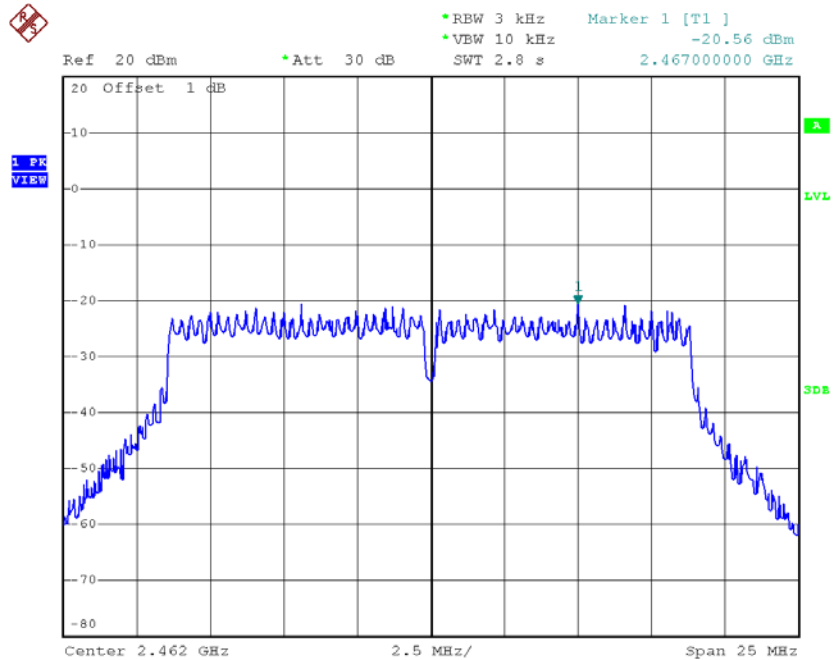

Date: 20.JUL.2015 16:23:49

Test Mode : TX N-20M Mode_CH01/06/11_Total

Frequency (MHz)	Power Density (dBm/3kHz)	Power Density (mW/3kHz)	Max. Limit (dBm/3kHz)	Result
2412	-16.99	0.02	8.00	Complies
2437	-15.23	0.03	8.00	Complies
2462	-15.23	0.03	8.00	Complies

Test Mode : TX N-40M Mode_CH03/06/09_ANT 1

Frequency (MHz)	Power Density (dBm/3kHz)	Power Density (mW/3kHz)	Max. Limit (dBm/3kHz)	Result
2422	-22.69	0.01	8.00	Complies
2437	-22.03	0.01	8.00	Complies
2452	-21.29	0.01	8.00	Complies

TX CH03

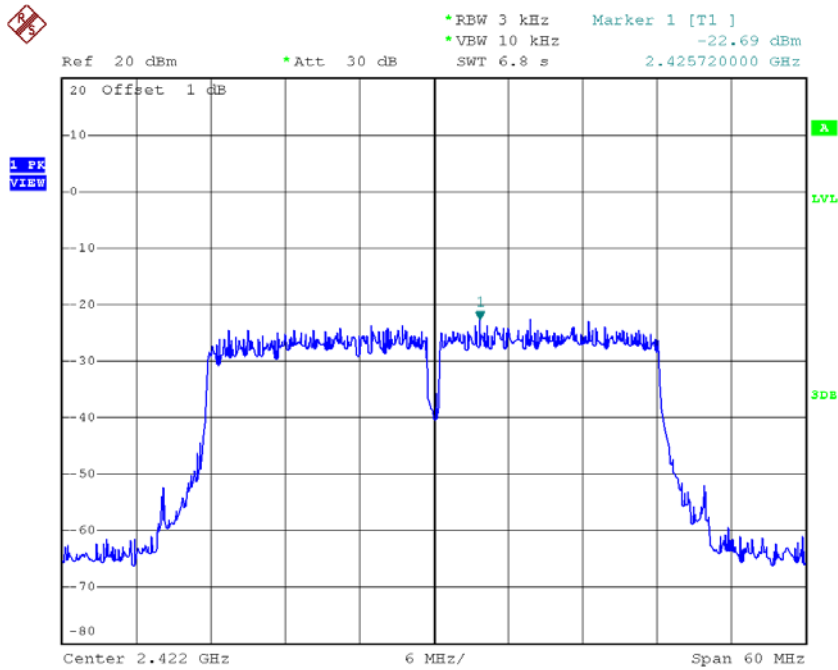

Date: 20.JUL.2015 16:25:27

TX CH06

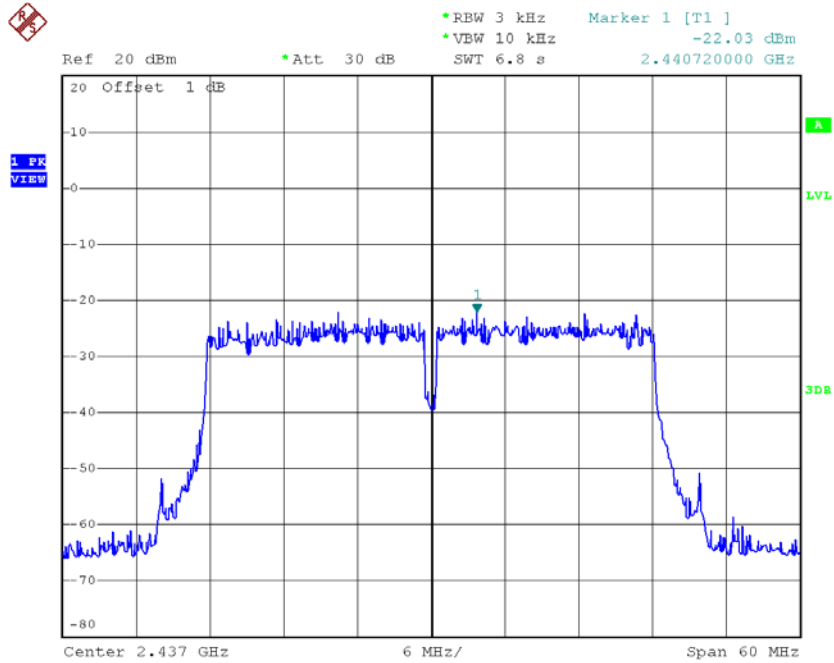

Date: 20.JUL.2015 16:26:31

TX CH09

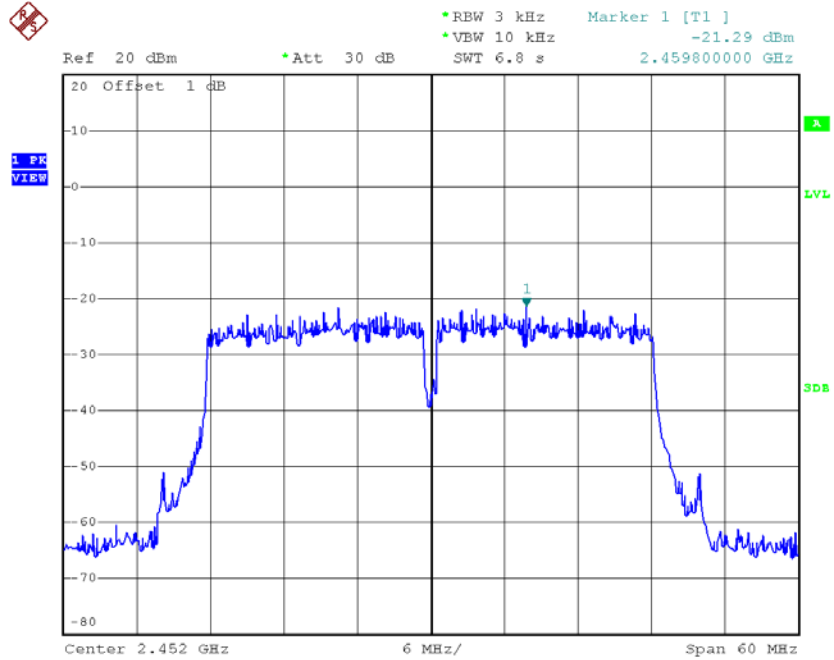

Date: 20.JUL.2015 16:27:29

Test Mode : TX N-40M Mode_CH03/06/09_ANT 2

Frequency (MHz)	Power Density (dBm/3kHz)	Power Density (mW/3kHz)	Max. Limit (dBm/3kHz)	Result
2422	-23.80	0.00	8.00	Complies
2437	-23.91	0.00	8.00	Complies
2452	-24.45	0.00	8.00	Complies

TX CH03

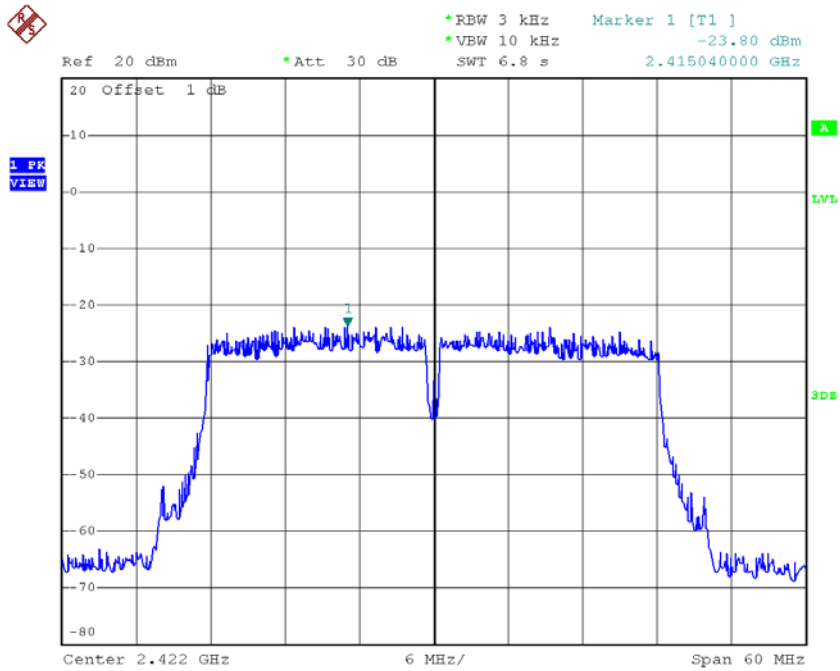

Date: 20.JUL.2015 16:28:51

TX CH06

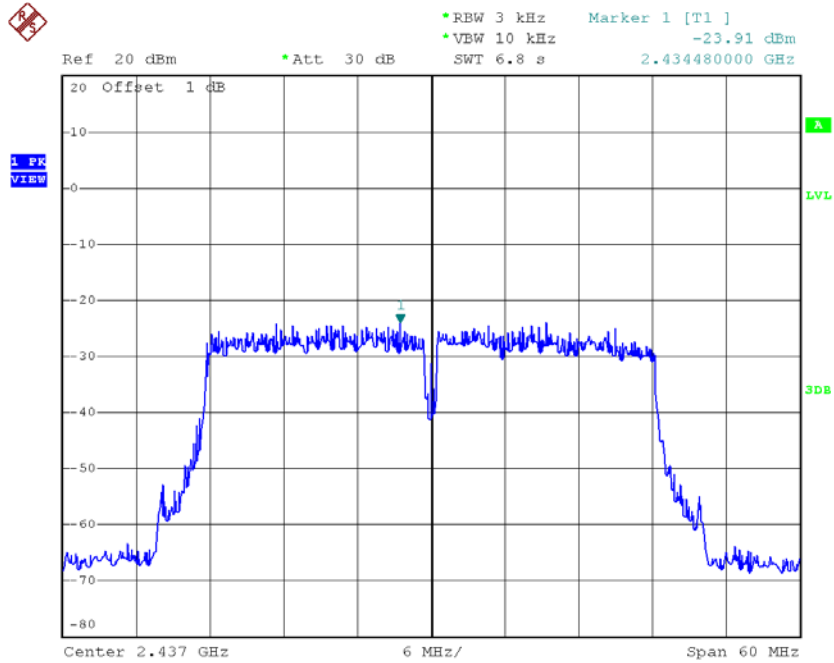

Date: 20.JUL.2015 16:30:10

TX CH09

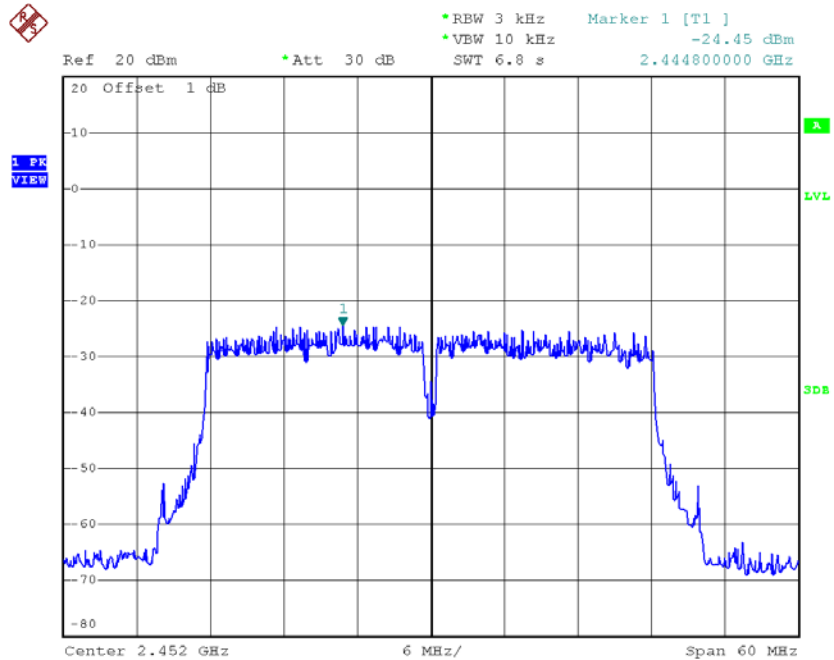

Date: 20.JUL.2015 16:32:07

Test Mode : TX N-40M Mode_CH03/06/09_Total

Frequency (MHz)	Power Density (dBm/3kHz)	Power Density (mW/3kHz)	Max. Limit (dBm/3kHz)	Result
2422	-20.20	0.01	8.00	Complies
2437	-19.86	0.01	8.00	Complies
2452	-19.58	0.01	8.00	Complies