

# FCC 47 CFR PART 15 SUBPART C AND ANSI C63.10:2013 TEST REPORT

For

**300Mbps AV600 Wireless Powerline Adapter**

**Model: PL7622**

**Trade Name: netis**

Issued for

**NETIS SYSTEMS CO., LTD**

**4F & 5F, R&D Building, Oriental Cyberport, High-Tech Industrial Park,  
Nanshan, Shenzhen, China**

Issued by

**Compliance Certification Services Inc.  
Hsinchu Lab.  
No.989-1, Wenshan Rd., Shangshan Village,  
Qionglin Township, Hsinchu County 30741, Taiwan (R.O.C.)  
TEL: +886-3-5921698  
FAX: +886-3-5921108**

**<http://www.ccsrf.com>  
E-Mail: [service@ccsrf.com](mailto:service@ccsrf.com)**

**Issued Date: January 12, 2016**



**Note:** This report shall not be reproduced except in full, without the written approval of Compliance Certification Services Inc. This document may be altered or revised by Compliance Certification Services Inc. personnel only, and shall be noted in the revision section of the document. The client should not use it to claim product endorsement by TAF or any government agencies. The test results of this report relate only to the tested sample identified in this report.

## Revision History

Rev.	Issue Date	Revisions	Effect Page	Revised By
00	01/12/2016	Initial Issue	All Page 106	Gloria Chang

## TABLE OF CONTENTS

TITLE	PAGE NO.
<b>1. TEST REPORT CERTIFICATION</b> .....	<b>4</b>
<b>2. EUT DESCRIPTION</b> .....	<b>5</b>
<b>3. DESCRIPTION OF TEST MODES</b> .....	<b>6</b>
<b>4. TEST METHODOLOGY</b> .....	<b>7</b>
<b>5. FACILITIES AND ACCREDITATION</b> .....	<b>7</b>
5.1 FACILITIES .....	7
5.2 ACCREDITATIONS .....	7
5.3 MEASUREMENT UNCERTAINTY .....	8
<b>6. SETUP OF EQUIPMENT UNDER TEST</b> .....	<b>9</b>
<b>7. FCC PART 15.247 REQUIREMENTS</b> .....	<b>10</b>
7.1 6dB BANDWIDTH .....	10
7.2 MAXIMUM PEAK OUTPUT POWER .....	24
7.3 AVERAGE POWER.....	27
7.4 POWER SPECTRAL DENSITY.....	30
7.5 CONDUCTED SPURIOUS EMISSION .....	45
7.6 RADIATED EMISSION.....	64
7.7 CONDUCTED EMISSION .....	98
<b>8. APPENDIX SETUP PHOTOS</b> .....	<b>103</b>

# 1. TEST REPORT CERTIFICATION

**Applicant** : NETIS SYSTEMS CO., LTD  
**Address** : 4F & 5F, R&D Building, Oriental Cyberport, High-Tech Industrial Park, Nanshan, Shenzhen, China  
**Equipment Under Test** : 300Mbps AV600 Wireless Powerline Adapter  
**Model** : PL7622  
**Trade Name** : netis  
**Tested Date** : October 06 ~ December 14, 2015

APPLICABLE STANDARD	
Standard	Test Result
FCC Part 15 Subpart C AND ANSI C63.10:2013	PASS

WE HEREBY CERTIFY THAT: The above equipment has been tested by Compliance Certification Services Inc., and found compliance with the requirements set forth in the technical standards mentioned above. The results of testing in this report apply only to the product/system, which was tested. Other similar equipment will not necessarily produce the same results due to production tolerance and measurement uncertainties.

**Approved by:**

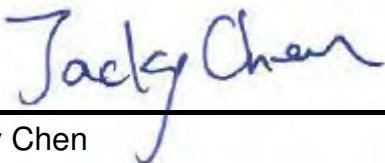

Jacky Chen  
Section Manager

**Reviewed by:**



Sb. Lu  
Sr. Engineer

## 2. EUT DESCRIPTION

<b>Product Name</b>	300Mbps AV600 Wireless Powerline Adapter
<b>Model Number</b>	PL7622
<b>Identify Number</b>	T151006D04
<b>Received Date</b>	October 06, 2015
<b>Frequency Range</b>	IEEE 802.11b/g, 802.11gn HT20 Mode: 2412MHz ~ 2462MHz IEEE 802.11gn HT40 Mode: 2422MHz ~ 2452MHz
<b>Transmit Power</b>	IEEE 802.11b Mode: 12.67 dBm (0.0185 W) IEEE 802.11g Mode: 25.12 dBm (0.3251 W) IEEE 802.11gn HT20 Mode: 27.58 dBm (0.5728 W) IEEE 802.11gn HT40 Mode: 27.14 dBm (0.5176 W)
<b>Channel Spacing</b>	5MHz
<b>Channel Number</b>	IEEE 802.11b/g, 802.11gn HT20 Mode: 11 Channels IEEE 802.11gn HT40 Mode: 7 Channels
<b>Transmit Data Rate</b>	IEEE 802.11b Mode: up to 11 Mbps IEEE 802.11g Mode: up to 54 Mbps IEEE 802.11gn HT20 Mode (800ns GI): up to 130.00 Mbps IEEE 802.11gn HT20 Mode (400ns GI): up to 144.40 Mbps IEEE 802.11gn HT40 Mode (800ns GI): up to 270.00 Mbps IEEE 802.11gn HT40 Mode (400ns GI): up to 300.00 Mbps
<b>Type of Modulation</b>	IEEE 802.11b Mode: DSSS (CCK, DQPSK, DBPSK) IEEE 802.11g Mode: OFDM (64QAM, 16QAM, QPSK, BPSK) IEEE 802.11gn HT20/40 Mode: OFDM (64QAM, 16QAM, QPSK, BPSK)
<b>Antenna Type</b>	PCB Antenna × 2, Antenna 0 / Chain 0, Antenna Gain : 3.28dBi Antenna 1 / Chain 1, Antenna Gain : 3.28dBi
<b>Power Rating</b>	100-240Vac, 50-60Hz, 0.03A
<b>Test Voltage</b>	120Vac, 60Hz
<b>I/O Port</b>	RJ-45 Port × 2

**Remark:**

1. The sample selected for test was engineering sample that approximated to production product and was provided by manufacturer.
2. For more details, please refer to the User's manual of the EUT.
3. This submittal(s) (test report) is intended for FCC ID: T58PL7622R filing to comply with Section 15.207, 15.209 and 15.247 of the FCC Part 15, Subpart C Rules.

### 3. DESCRIPTION OF TEST MODES

The EUT is a 802.11b/g/n transceiver in 300Mbps AV600 Wireless Powerline Adapter.

For IEEE 802.11b/g Mode (1TX / 1RX) : Ant. 0 / Chain 0 transmit/receive.

For IEEE 802.11gn HT20/HT40 Mode (2TX / 2RX) :

Ant. 0 / Chain 0 & Ant. 1 / Chain 1 transmit/receive.

#### Conducted Emission / Radiated Emission Test (Below 1 GHz)

1. The following test modes were scanned during the preliminary test:

No.	Pre-Test Mode
1	TX Mode

2. After the preliminary scan, the following test mode was found to produce the highest emission level.

Final Test Mode		
Emission	Radiated Emission	Mode 1
	Conducted Emission	Mode 1

*Remark: Then, the above highest emission mode of the configuration of the EUT and cable was chosen for all final test items.*

#### Conducted / Radiated Emission Test (Above 1 GHz)

##### IEEE 802.11b/g, 802.11gn HT20 Mode:

The EUT had been tested under operating condition.

There are three channels have been tested as following:

Channel	Frequency (MHz)
Low	2412
Middle	2437
High	2462

IEEE 802.11b Mode: 1Mbps data rate (worst case) was chosen for full testing.

IEEE 802.11g Mode: 6Mbps data rate (worst case) was chosen for full testing.

IEEE 802.11gn HT20 Mode: 6.5Mbps data rate (worst case) was chosen for full testing.

##### IEEE 802.11gn HT40 Mode:

The EUT had been tested under operating condition.

There are three channels have been tested as following:

Channel	Frequency (MHz)
Low	2422
Middle	2437
High	2452

IEEE 802.11gn HT40 Mode: 13.5Mbps data rate (worst case) was chosen for full testing.

*Remark : The field strength of spurious emission was measured in the following position: EUT stand-up position (Z axis), lie-down position (X, Y axis). The worst emission was found in stand-up position (Z axis) and the worst case was recorded.*

## 4. TEST METHODOLOGY

The tests documented in this report were performed in accordance with ANSI C63.10:2013 and FCC CFR 47, 15.207, 15.209 and 15.247.

## 5. FACILITIES AND ACCREDITATION

### 5.1 FACILITIES

All measurement facilities used to collect the measurement data are located at No.989-1, Wenshan Rd., Shangshan Village, Qionglin Township, Hsinchu County 30741, Taiwan (R.O.C.)

The sites are constructed in conformance with the requirements of ANSI C63.10:2013 and CISPR 22. All receiving equipment conforms to CISPR 16-1-1, CISPR 16-1-2, CISPR 16-1-3, CISPR 16-1-4 and CISPR 16-1-5.

### 5.2 ACCREDITATIONS

Our laboratories are accredited and approved by the following approval agencies according to ISO/IEC 17025.

<b>Taiwan</b>	TAF
---------------	-----

The measuring facility of laboratories has been authorized or registered by the following approval agencies.

<b>Canada</b>	INDUSTRY CANADA
<b>Japan</b>	VCCI
<b>Taiwan</b>	BSMI
<b>USA</b>	FCC MRA

Copies of granted accreditation certificates are available for downloading from our web site, <http://www.ccsrf.com>

**Remark:** FCC Designation Number TW1027.

### 5.3 MEASUREMENT UNCERTAINTY

The following table is for the measurement uncertainty, which is calculated as per the document CISPR 16-4-2.

PARAMETER	UNCERTAINTY
Semi Anechoic Chamber (966 Chamber_B) / Radiated Emission, 30 to 1000 MHz	+/- 3.97
Semi Anechoic Chamber (966 Chamber_B) / Radiated Emission, 1 to 18GHz	+/- 3.58
Semi Anechoic Chamber (966 Chamber_B) / Radiated Emission, 18 to 26 GHz	+/- 3.59
Semi Anechoic Chamber (966 Chamber_B) / Radiated Emission, 26 to 40 GHz	+/- 3.81
Conducted Emission (Mains Terminals), 9kHz to 30MHz	+/- 2.48

This uncertainty represents an expanded uncertainty expressed at approximately the 95% confidence level using a coverage factor of  $k=2$ .

Consistent with industry standard (e.g. CISPR 22, clause 11, Measurement Uncertainty) determining compliance with the limits shall be base on the results of the compliance measurement. Consequently the measure emissions being less than the maximum allowed emission result in this be a compliant test or passing test.

The acceptable measurement uncertainty value without requiring revision of the compliance statement is base on conducted and radiated emissions being less than  $U_{CISPR}$  which is 3.6dB and 5.2dB respectively. CCS values (called  $U_{Lab}$  in CISPR 16-4-2) is less than  $U_{CISPR}$  as shown in the table above. Therefore, MU need not be considered for compliance.



## 6. SETUP OF EQUIPMENT UNDER TEST

### SUPPORT EQUIPMENT

No.	Product	Manufacturer	Model No.	Serial No.
1	Notebook PC	HP	ProBook 4421s	CNF03242PJ

No.	Signal Cable Description
1	Non-shielded RJ-45 cable, 12m × 1

### SETUP DIAGRAM FOR TESTS

EUT & peripherals setup diagram is shown in appendix setup photos.

### EUT OPERATING CONDITION

1. EUT & peripherals setup diagram is shown in appendix setup photos.

2. TX Mode:

- ⇒ **TX Data Rate:** 1Mbps Bandwidth 20 (IEEE 802.11b Mode)  
 6Mbps Bandwidth 20 (IEEE 802.11g Mode)  
 6.5Mbps Bandwidth 20 (IEEE 802.11gn HT20 Mode)  
 13.5Mbps Bandwidth 40 (IEEE 802.11gn HT40 Mode)

⇒ **Power control**

- IEEE 802.11b Channel Low (2412MHz) Chain 0 Power set 26
- IEEE 802.11b Channel Mid (2437MHz) Chain 0 Power set 26
- IEEE 802.11b Channel High (2462MHz) Chain 0 Power set 26
- IEEE 802.11g Channel Low (2412MHz) Chain 0 Power set 42
- IEEE 802.11g Channel Mid (2437MHz) Chain 0 Power set 51
- IEEE 802.11g Channel High (2462MHz) Chain 0 Power set 44
- IEEE 802.11gn HT20 Channel Low (2412MHz) Chain 0/1 Power set 42
- IEEE 802.11gn HT20 Channel Mid (2437MHz) Chain 0/1 Power set 51
- IEEE 802.11gn HT20 Channel High (2462MHz) Chain 0/1 Power set 44
- IEEE 802.11gn HT40 Channel Low (2422MHz) Chain 0/1 Power set 41
- IEEE 802.11gn HT40 Channel Mid (2437MHz) Chain 0/1 Power set 50
- IEEE 802.11gn HT40 Channel High (2452MHz) Chain 0/1 Power set 41

3. All of the functions are under run.

4. Start test.

## 7. FCC PART 15.247 REQUIREMENTS

### 7.1 6dB BANDWIDTH

#### LIMITS

§ 15.247(a) (2) For direct sequence systems, the minimum 6dB bandwidth shall be at least 500kHz.

#### TEST EQUIPMENT

Name of Equipment	Manufacturer	Model	Serial Number	Calibration Due
EXA Signal Analyzer	Agilent	N9010A	MY52220817	03/19/2016

*Remark: Each piece of equipment is scheduled for calibration once a year.*

#### TEST SETUP

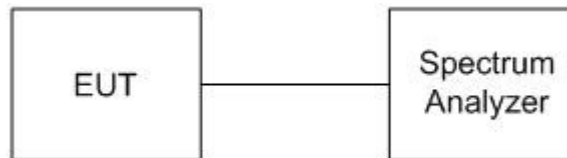

#### TEST PROCEDURE

1. The transmitter output was connected to a spectrum analyzer.
2. Set RBW = 100 kHz.
3. Set the video bandwidth (VBW)  $\geq 3 \times$  RBW.
4. Detector = Peak.
5. Trace mode = max hold.
6. Sweep = auto couple.
7. Allow the trace to stabilize.
8. Measure the maximum width of the emission that is constrained by the frequencies associated with the two outermost amplitude points (upper and lower frequencies) that are attenuated by 6 dB relative to the maximum level measured in the fundamental emission.

**TEST RESULTS**

**IEEE 802.11b Mode**

Channel	Channel Frequency (MHz)	6dB Bandwidth (MHz)	Minimum Limit (kHz)	Pass / Fail
		Chain 0		
Low	2412	10.0400	500	PASS
Middle	2437	9.9710	500	PASS
High	2462	10.0500	500	PASS

**IEEE 802.11g Mode**

Channel	Channel Frequency (MHz)	6dB Bandwidth (MHz)	Minimum Limit (kHz)	Pass / Fail
		Chain 0		
Low	2412	16.5600	500	PASS
Middle	2437	16.5600	500	PASS
High	2462	16.5600	500	PASS

**IEEE 802.11gn HT20 Mode (2TX)**

Channel	Channel Frequency (MHz)	6dB Bandwidth (MHz)		Minimum Limit (kHz)	Pass / Fail
		Chain 0	Chain 1		
Low	2412	17.8100	17.8300	500	PASS
Middle	2437	17.8000	17.7800	500	PASS
High	2462	17.8100	17.8200	500	PASS

**IEEE 802.11gn HT40 Mode (2TX)**

Channel	Channel Frequency (MHz)	6dB Bandwidth (MHz)		Minimum Limit (kHz)	Pass / Fail
		Chain 0	Chain 1		
Low	2422	36.4400	36.4600	500	PASS
Middle	2437	36.4300	36.4500	500	PASS
High	2452	36.4000	36.4500	500	PASS

**6dB BANDWIDTH**

**CH Low (IEEE 802.11b Mode / Chain 0)**

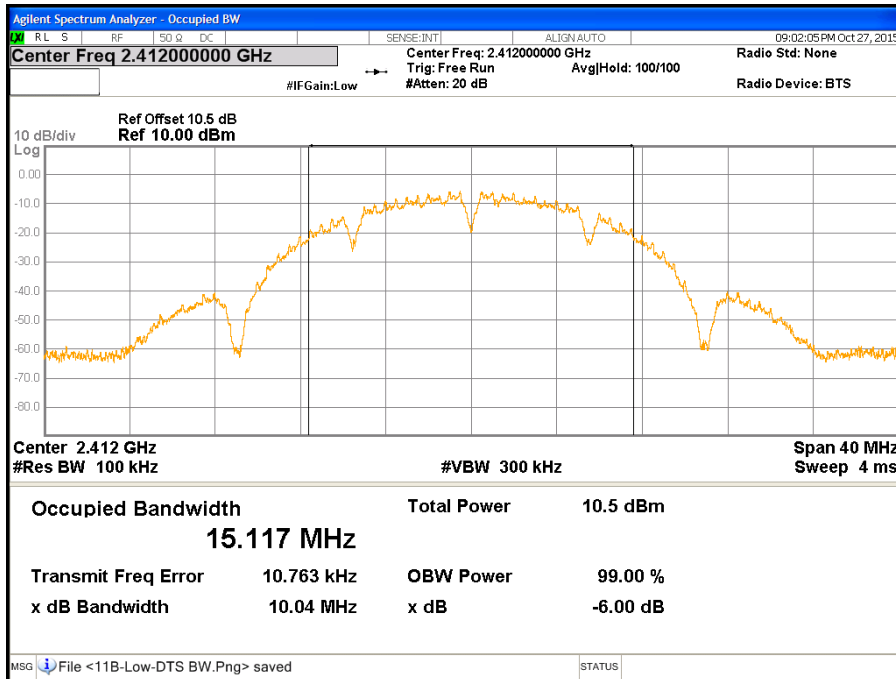

**CH Middle (IEEE 802.11b Mode / Chain 0)**

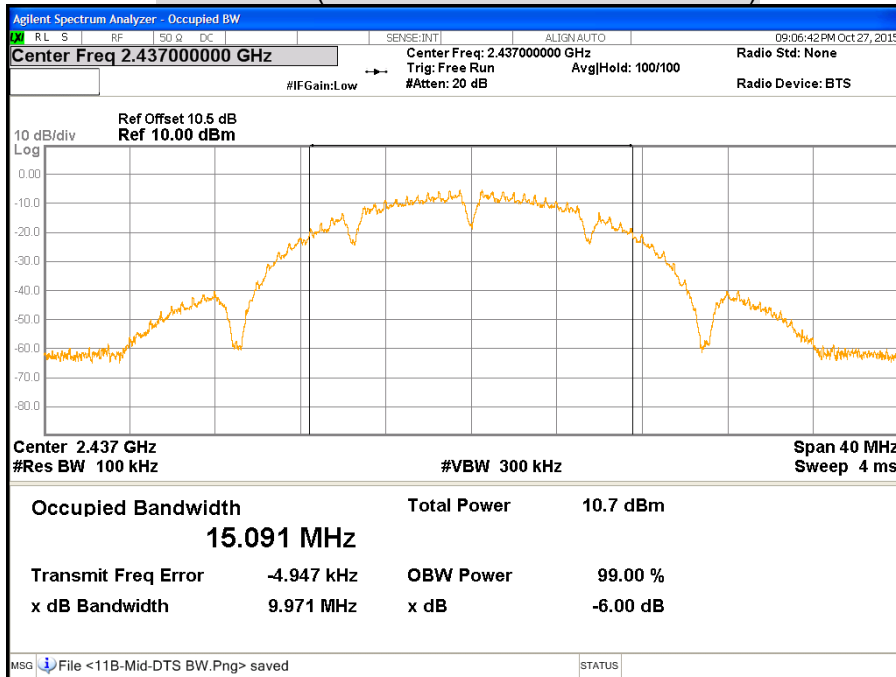

**CH High (IEEE 802.11b Mode / Chain 0)**

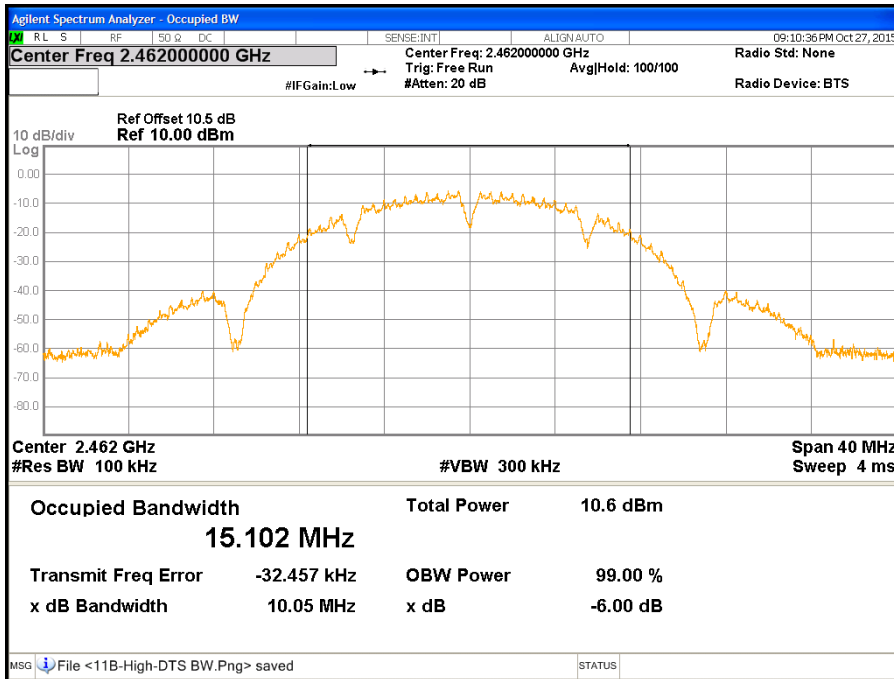

**CH Low (IEEE 802.11g Mode / Chain 0)**

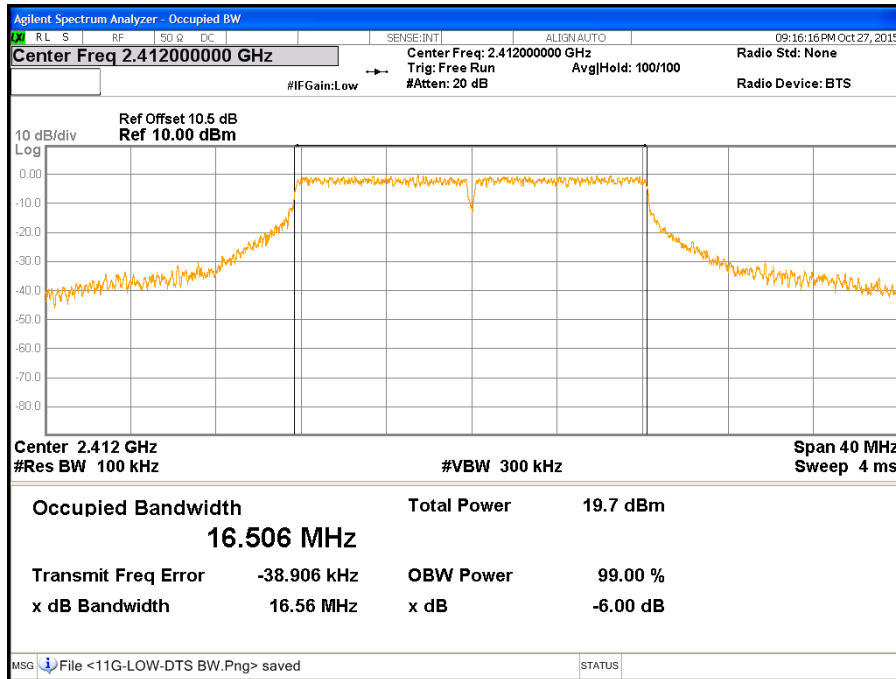

**CH Middle (IEEE 802.11g Mode / Chain 0)**

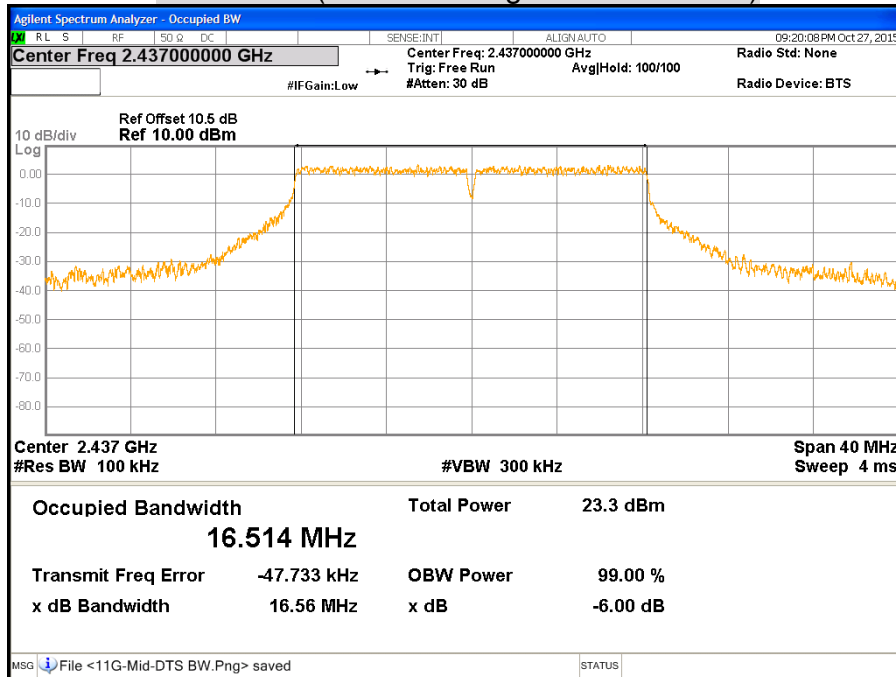

**CH High (IEEE 802.11g Mode / Chain 0)**

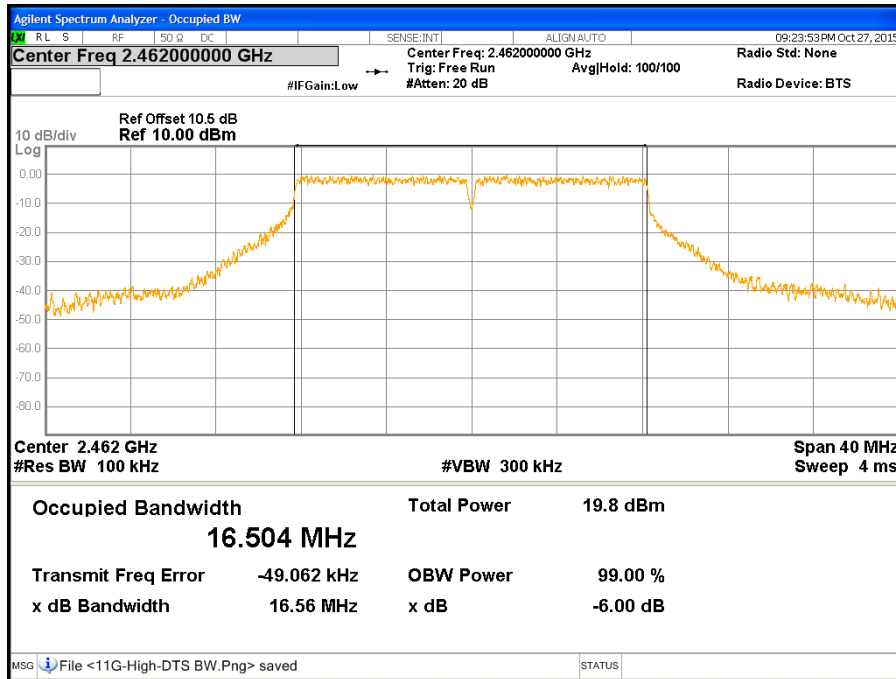

**CH Low (IEEE 802.11gn HT20 Mode / Chain 0)**

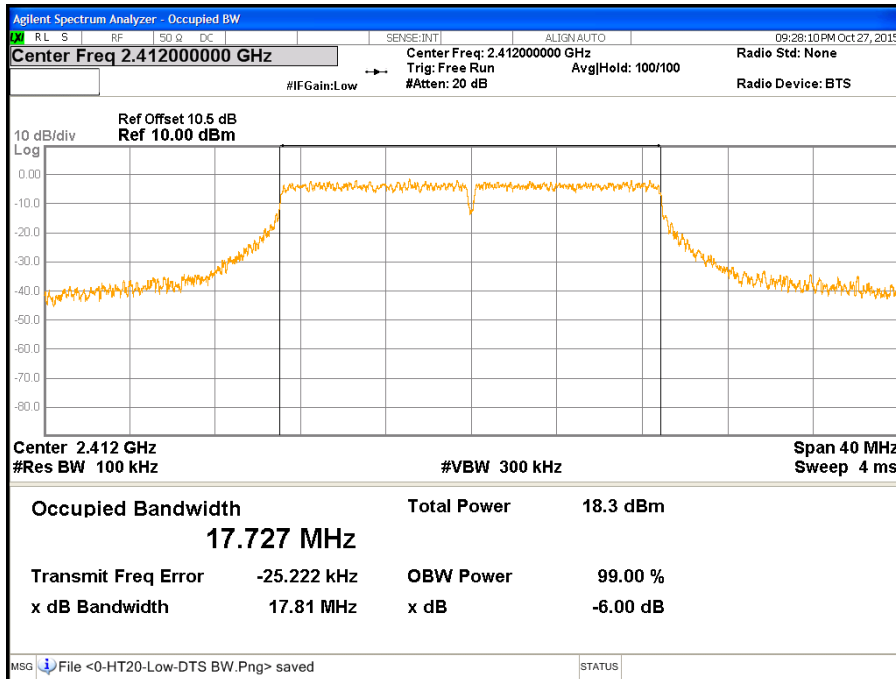

**CH Middle (IEEE 802.11gn HT20 Mode / Chain 0)**

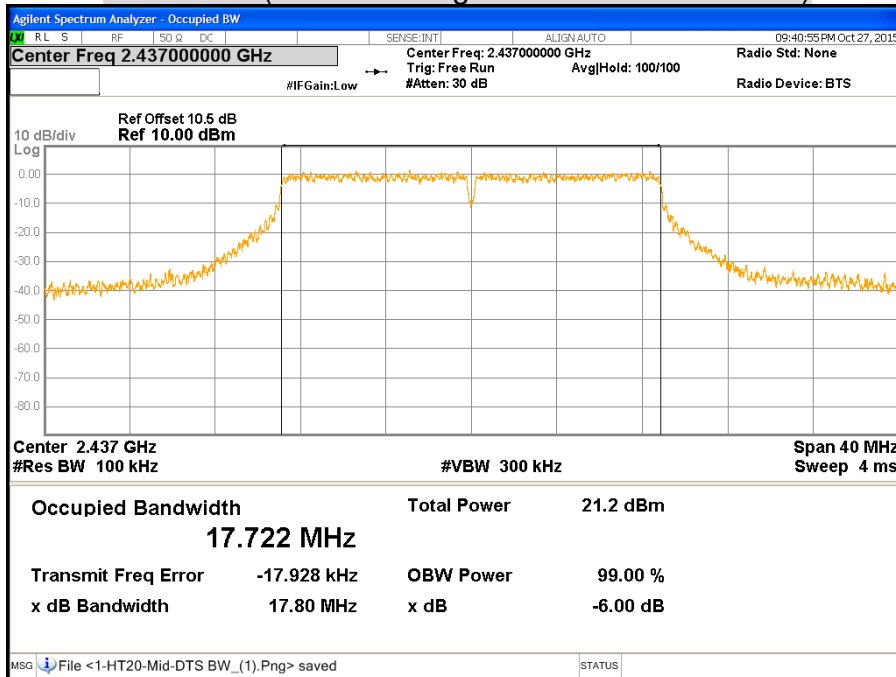



**CH High (IEEE 802.11gn HT20 Mode / Chain 0)**

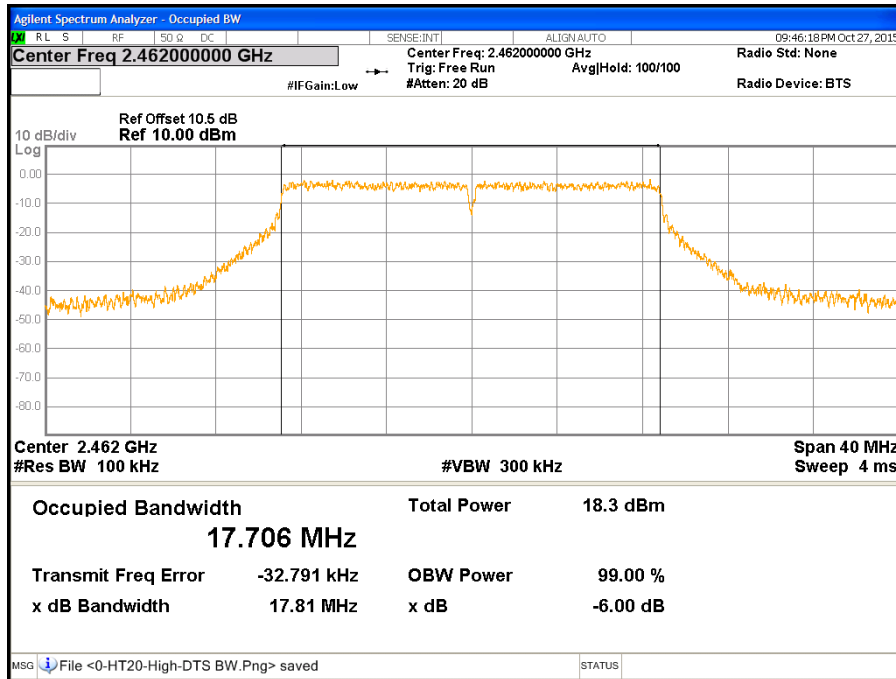

**CH Low (IEEE 802.11gn HT20 Mode / Chain 1)**

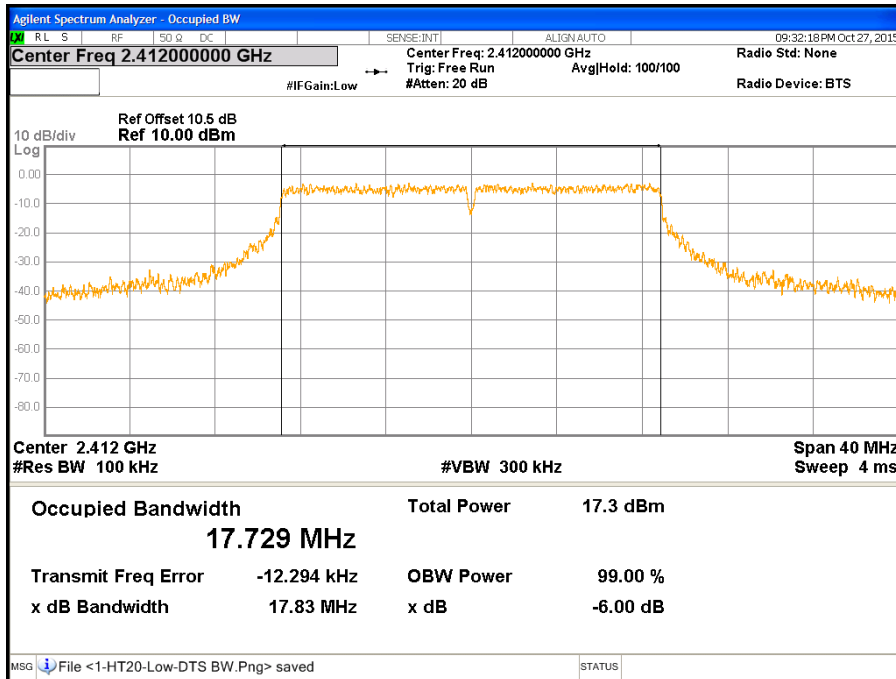

**CH Middle (IEEE 802.11gn HT20 Mode / Chain 1)**

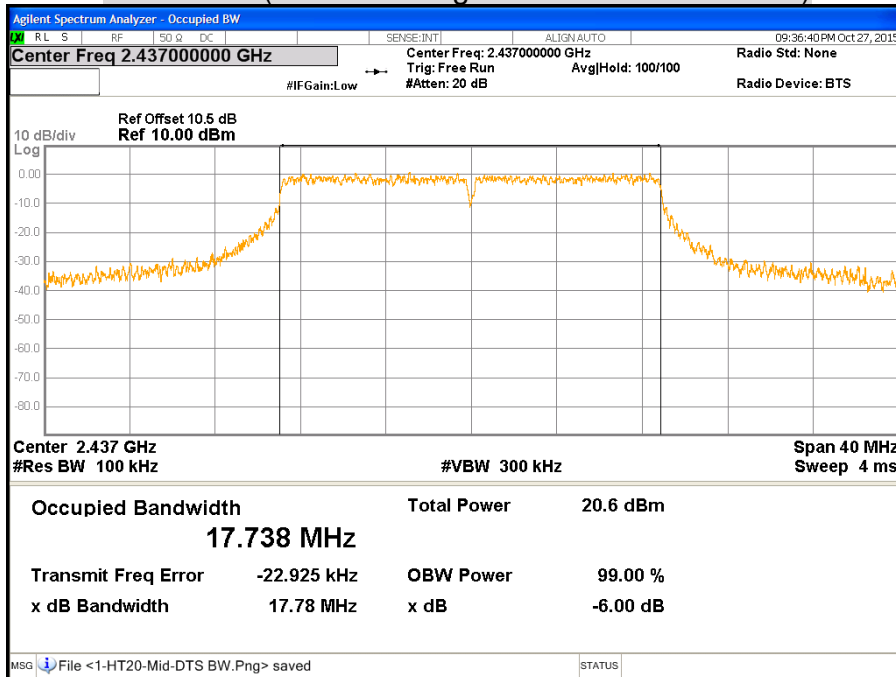

**CH High (IEEE 802.11gn HT20 Mode / Chain 1)**

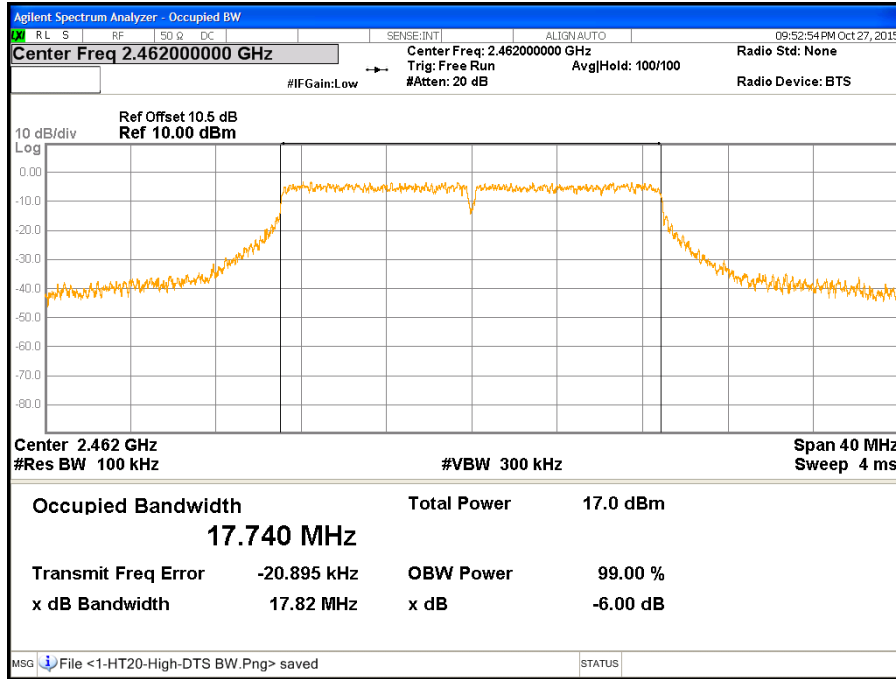

**CH Low (IEEE 802.11gn HT40 Mode / Chain 0)**

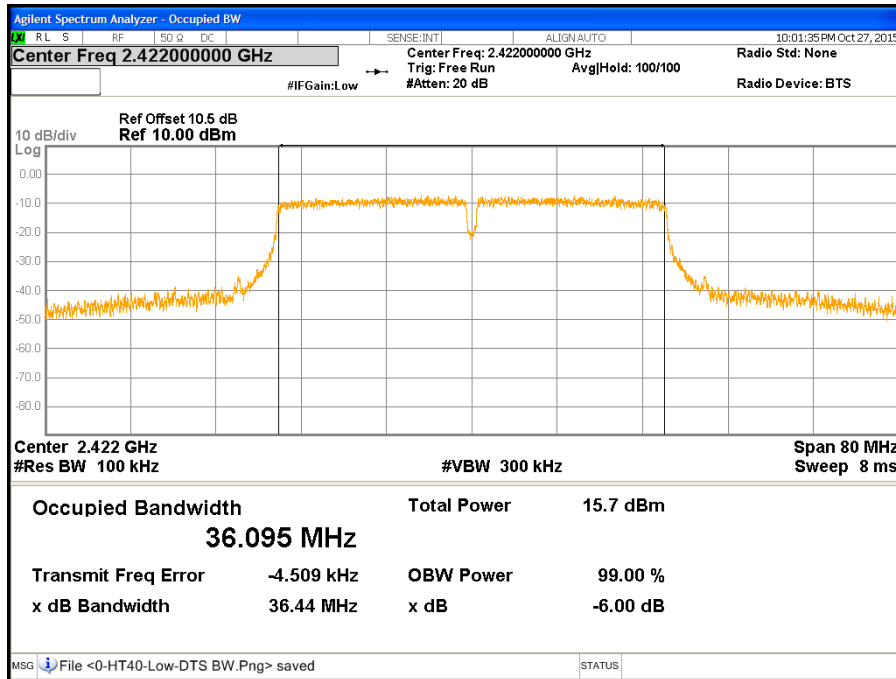

**CH Middle (IEEE 802.11gn HT40 Mode / Chain 0)**

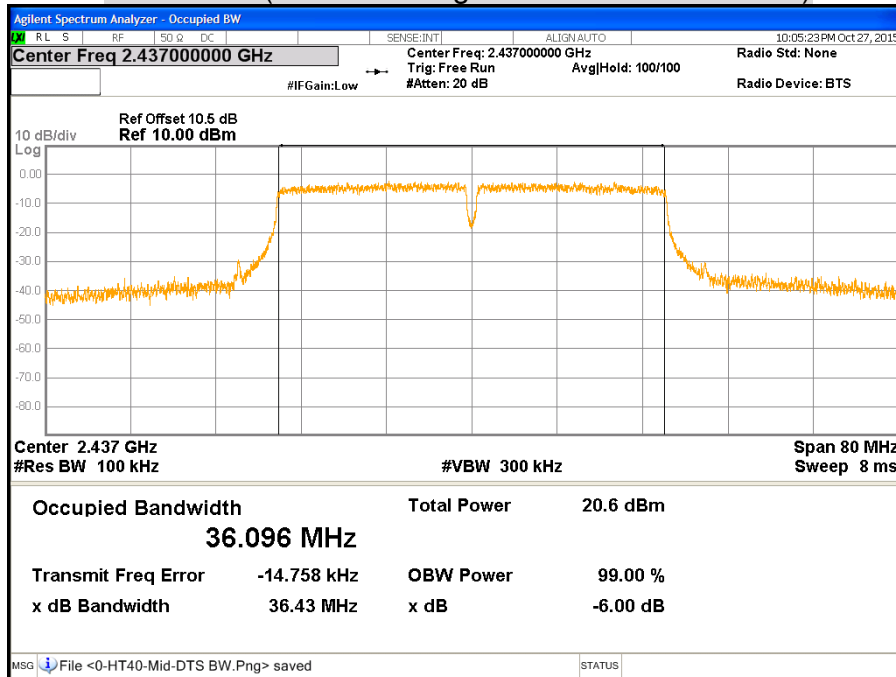

**CH High (IEEE 802.11gn HT40 Mode / Chain 0)**

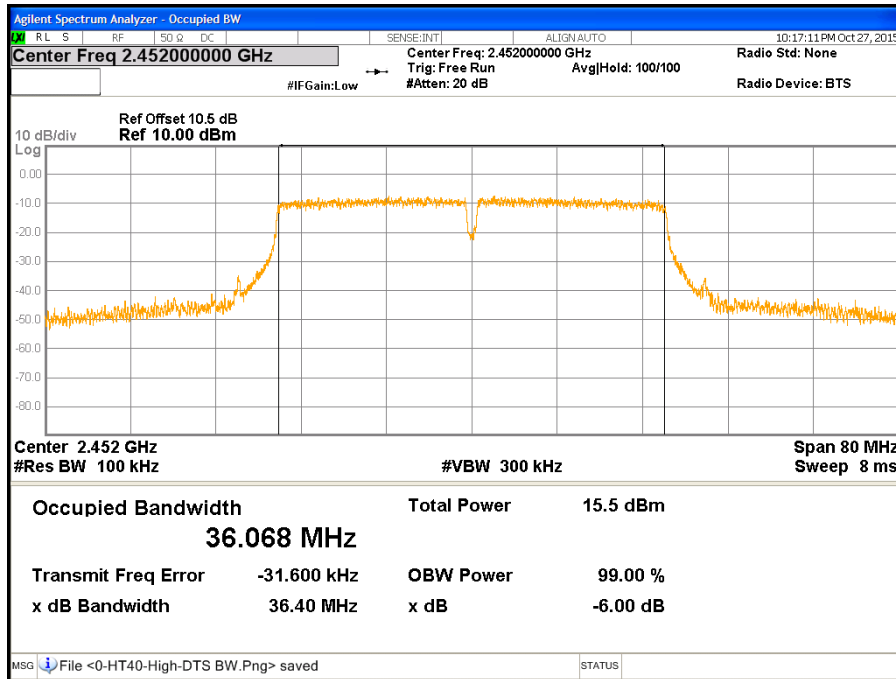

**CH Low (IEEE 802.11gn HT40 Mode / Chain 1)**

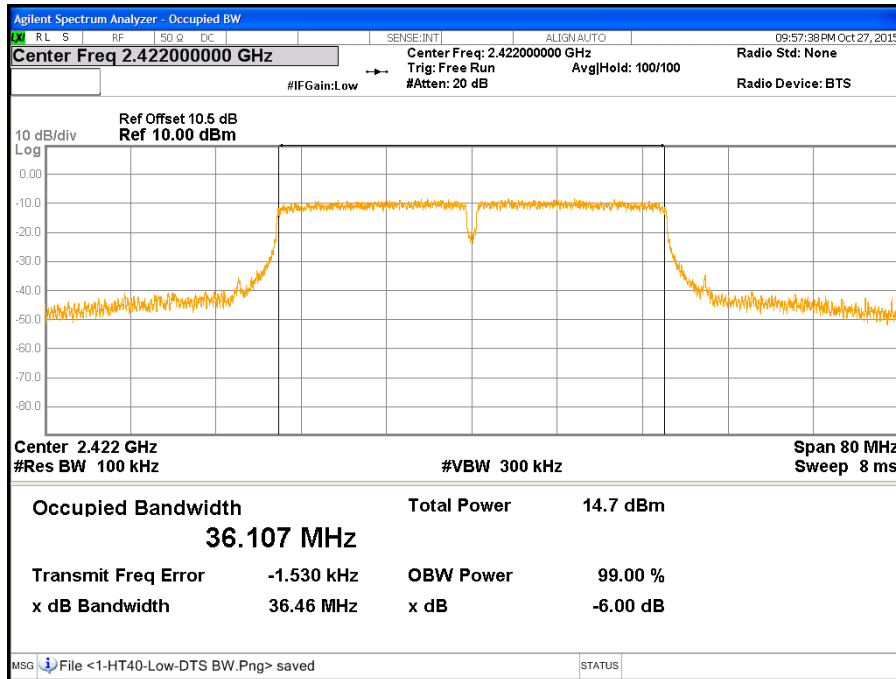

**CH Middle (IEEE 802.11gn HT40 Mode / Chain 1)**

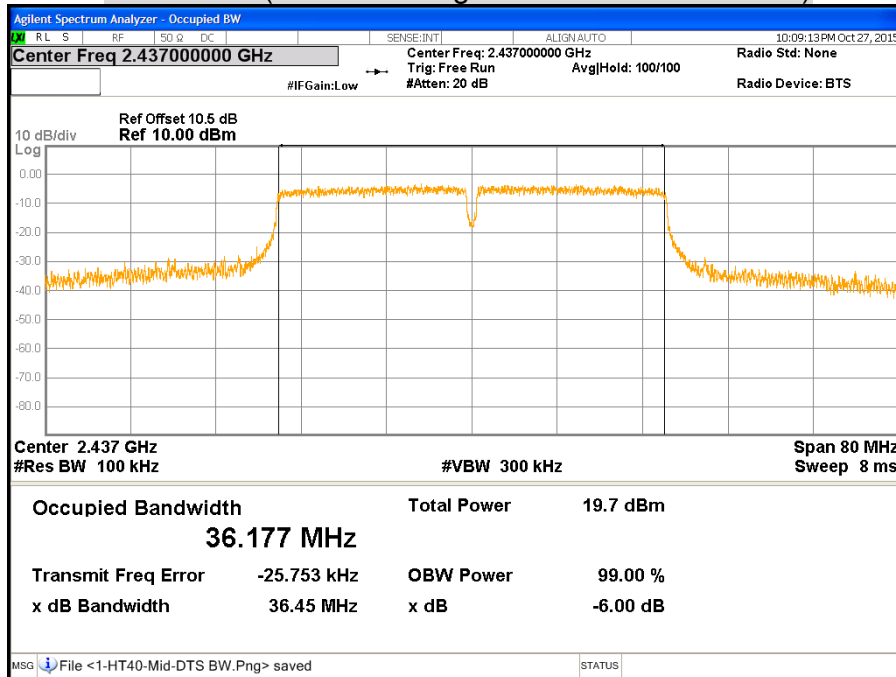

**CH High (IEEE 802.11gn HT40 Mode / Chain 1)**

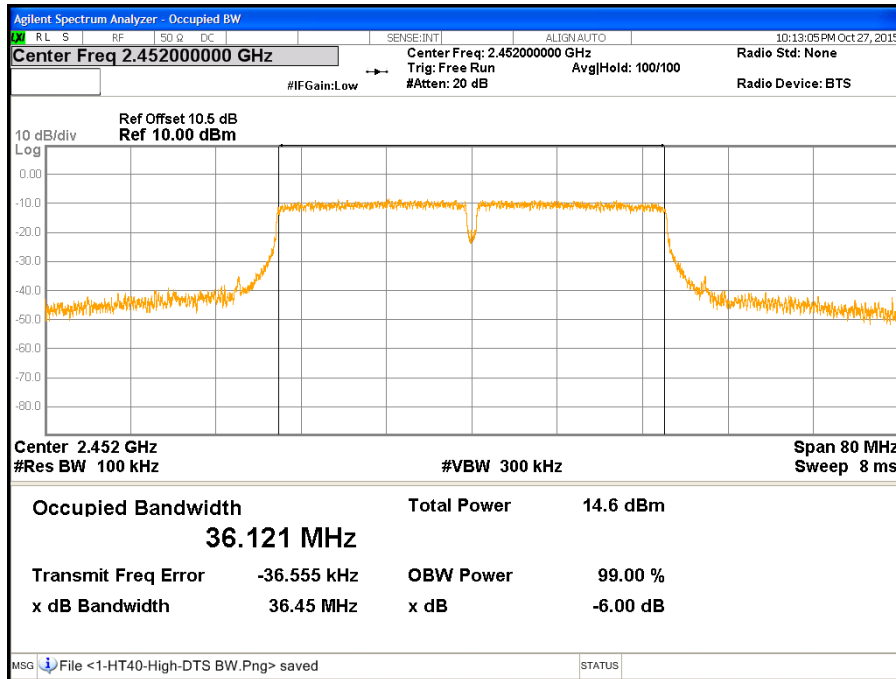

## 7.2 MAXIMUM PEAK OUTPUT POWER

### LIMITS

§ 15.247(b) The maximum peak output power of the intentional radiator shall not exceed the following:

§ 15.247(b) (3) For systems using digital modulation in the 902-928 MHz, 2400-2483.5 MHz, and 5725-5850 MHz bands: 1 watt.

§ 15.247(b) (4) Except as shown in paragraphs (c) of this section, if transmitting antennas of directional gain greater than 6 dBi are used the peak output power from the intentional radiator shall be reduced below the stated values in paragraphs (b)(1) or (b)(2), and (b)(3) of this section, as appropriate, by the amount in dB that the directional gain of the antenna exceeds 6 dBi.

§ KDB 662911: For power measurements on IEEE 802.11 devices

Array Gain = 0 dB (i.e., no array gain) for  $N_{ANT} \leq 4$  ;

Array Gain = 0 dB (i.e., no array gain) for channel widths  $\geq 40$  MHz for any  $N_{ANT}$  ;

Array Gain =  $5 \log(N_{ANT}/N_{SS})$  dB or 3 dB, whichever is less for 20-MHz channel widths with  $N_{ANT} \geq 5$ .

### TEST EQUIPMENT

Name of Equipment	Manufacturer	Model	Serial Number	Calibration Due
Power Meter	Anritsu	ML2495A	1149001	12/08/2016
Power Sensor	Anritsu	MA2411B	1126148	12/08/2016

*Remark: Each piece of equipment is scheduled for calibration once a year.*

### TEST SETUP

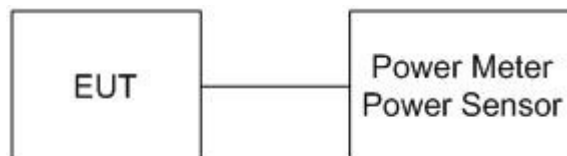

### TEST PROCEDURE

The transmitter output is connected to the power meter. The power meter is set to the peak power detection.



**TEST RESULTS**

**IEEE 802.11b Mode**

Channel	Channel Frequency (MHz)	Peak Power		Peak Power Limit		Pass / Fail
		Chain 0		(dBm)	(W)	
		(dBm)	(W)			
Low	2412	12.56	0.0180	30	1	PASS
Middle	2437	12.67	0.0185	30	1	PASS
High	2462	12.51	0.0178	30	1	PASS

**Remark:**

1. At final test to get the worst-case emission at 1Mbps.
2. The cable assembly insertion loss of 10.5 dB (including 10 dB pad and 0.5 dB cable) was entered as an offset in the power meter to allow for direct reading of power.

**IEEE 802.11g Mode**

Channel	Channel Frequency (MHz)	Peak Power		Peak Power Limit		Pass / Fail
		Chain 0		(dBm)	(W)	
		(dBm)	(W)			
Low	2412	24.39	0.2748	30	1	PASS
Middle	2437	25.12	0.3251	30	1	PASS
High	2462	24.69	0.2944	30	1	PASS

**Remark:**

1. At final test to get the worst-case emission at 6Mbps.
2. The cable assembly insertion loss of 10.5 dB (including 10 dB pad and 0.5 dB cable) was entered as an offset in the power meter to allow for direct reading of power.

**IEEE 802.11gn HT20 Mode (2TX)**

Channel	Channel Frequency (MHz)	Peak Power		Peak Power Total		Peak Power Limit		Pass / Fail
		Chain 0	Chain 1	(dBm)	(W)	(dBm)	(W)	
Low	2412	23.15	21.42	25.38	0.3451	30	1	PASS
Middle	2437	24.86	24.26	27.58	0.5728	30	1	PASS
High	2462	23.05	22.82	25.95	0.3936	30	1	PASS

**Remark:**

1. At final test to get the worst-case emission at 6.5Mbps.
2. The cable assembly insertion loss of 10.5 dB (including 10 dB pad and 0.5 dB cable) was entered as an offset in the power meter to allow for direct reading of power.
3. Array gain = 0 dB for  $N_{ANT} \leq 4$ , power limit do not reduce.
4. Total power = Chain 0 + Chain 1.

**IEEE 802.11gn HT40 Mode (2TX)**

Channel	Channel Frequency (MHz)	Peak Power		Peak Power Total		Peak Power Limit		Pass / Fail
		Chain 0	Chain 1	(dBm)	(W)	(dBm)	(W)	
Low	2422	20.39	20.52	23.47	0.2223	30	1	PASS
Middle	2437	24.63	23.56	27.14	0.5176	30	1	PASS
High	2452	20.28	21.22	23.79	0.2393	30	1	PASS

**Remark:**

1. At final test to get the worst-case emission at 13.5Mbps.
2. The cable assembly insertion loss of 10.5 dB (including 10 dB pad and 0.5 dB cable) was entered as an offset in the power meter to allow for direct reading of power.
3. Array gain = 0 dB for  $N_{ANT} \leq 4$ , power limit do not reduce.
4. Total power = Chain 0 + Chain 1.

### 7.3 AVERAGE POWER

#### LIMITS

None: For reporting purposes only.

#### TEST EQUIPMENT

Name of Equipment	Manufacturer	Model	Serial Number	Calibration Due
Power Meter	Anritsu	ML2495A	1149001	12/08/2016
Power Sensor	Anritsu	MA2411B	1126148	12/08/2016

*Remark: Each piece of equipment is scheduled for calibration once a year.*

#### TEST SETUP

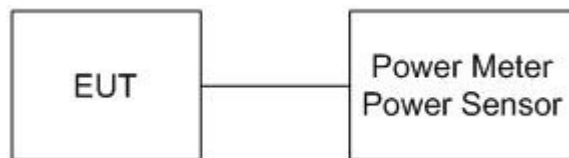

#### TEST PROCEDURE

The transmitter output is connected to the power meter. The power meter is set to the average power detection.

**TEST RESULTS**

**IEEE 802.11b Mode**

Channel	Channel Frequency (MHz)	Average Power (dBm)
		Chain 0
Low	2412	10.33
Middle	2437	10.53
High	2462	10.31

**Remark:**

1. At final test to get the worst-case emission at 1Mbps.
2. The cable assembly insertion loss of 10.5 dB (including 10 dB pad and 0.5 dB cable) was entered as an offset in the spectrum analyzer to allow for direct reading of power.

**IEEE 802.11g Mode**

Channel	Channel Frequency (MHz)	Average Power (dBm)
		Chain 0
Low	2412	15.12
Middle	2437	18.84
High	2462	15.29

**Remark:**

1. At final test to get the worst-case emission at 6Mbps.
2. The cable assembly insertion loss of 10.5 dB (including 10 dB pad and 0.5 dB cable) was entered as an offset in the spectrum analyzer to allow for direct reading of power.

**IEEE 802.11gn HT20 Mode**

Channel	Channel Frequency (MHz)	Average Power (dBm)	
		Chain 0	Chain 1
Low	2412	13.84	12.33
Middle	2437	16.86	16.05
High	2462	13.78	13.81

**Remark:**

1. At final test to get the worst-case emission at 6.5Mbps.
2. The cable assembly insertion loss of 10.5 dB (including 10 dB pad and 0.5 dB cable) was entered as an offset in the spectrum analyzer to allow for direct reading of power.

**IEEE 802.11gn HT40 Mode**

Channel	Channel Frequency (MHz)	Average Power (dBm)	
		Chain 0	Chain 1
Low	2422	11.22	10.86
Middle	2437	15.92	14.05
High	2452	11.24	11.23

**Remark:**

1. At final test to get the worst-case emission at 13.5Mbps.
2. The cable assembly insertion loss of 10.5 dB (including 10 dB pad and 0.5 dB cable) was entered as an offset in the spectrum analyzer to allow for direct reading of power.

## 7.4 POWER SPECTRAL DENSITY

### LIMITS

§ 15.247(e) For digitally modulated systems, the power spectral density conducted from the intentional radiator to the antenna shall not greater than 8 dBm in any 3 kHz band during any time interval of continuous transmission.

### TEST EQUIPMENT

Name of Equipment	Manufacturer	Model	Serial Number	Calibration Due
EXA Signal Analyzer	Agilent	N9010A	MY52220817	03/19/2016

*Remark: Each piece of equipment is scheduled for calibration once a year.*

### TEST SETUP

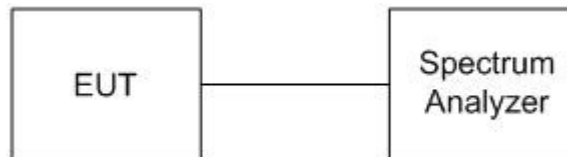

### TEST PROCEDURE

1. The transmitter output was connected to the spectrum analyzer.
2. Set analyzer center frequency to DTS channel center frequency.
3. Set the span to 1.5 times the DTS channel bandwidth.
4. Set the RBW to:  $3 \text{ kHz} \leq \text{RBW} \leq 100 \text{ kHz}$ .
5. Set the VBW  $\geq 3 \times \text{RBW}$ .
6. Detector = peak.
7. Sweep time = auto couple.
8. Trace mode = max hold.
9. Allow trace to fully stabilize.
10. Use the peak marker function to determine the maximum amplitude level within the RBW.
11. If measured value exceeds limit, reduce RBW (no less than 3 kHz) and repeat.

**TEST RESULTS**

**IEEE 802.11b Mode**

Channel	Channel Frequency (MHz)	Final RF Power Level in 3KHz BW (dBm)		Limit (dBm)	Pass / Fail
		Chain 0	Chain 1		
Low	2412	-15.87		8	PASS
Middle	2437	-15.85		8	PASS
High	2462	-15.93		8	PASS

**Remark:**

1. At final test to get the worst-case emission at 1Mbps.
2. The cable assembly insertion loss of 10.5 dB (including 10 dB pad and 0.5 dB cable) was entered as an offset in the spectrum analyzer to allow for direct reading of power.

**IEEE 802.11g Mode**

Channel	Channel Frequency (MHz)	Final RF Power Level in 3KHz BW (dBm)		Limit (dBm)	Pass / Fail
		Chain 0	Chain 1		
Low	2412	-8.09		8	PASS
Middle	2437	-4.54		8	PASS
High	2462	-7.99		8	PASS

**Remark:**

1. At final test to get the worst-case emission at 6Mbps.
2. The cable assembly insertion loss of 10.5 dB (including 10 dB pad and 0.5 dB cable) was entered as an offset in the spectrum analyzer to allow for direct reading of power.

**IEEE 802.11gn HT20 Mode (2TX)**

Channel	Channel Frequency (MHz)	Final RF Power Level in 3KHz BW (dBm)		PSD Total (dBm)	Limit (dBm)	Pass / Fail
		Chain 0	Chain 1			
Low	2412	-8.66	-9.56	-6.08	7.71	PASS
Middle	2437	-5.46	-6.33	-2.86	7.71	PASS
High	2462	-8.55	-10.06	-6.23	7.71	PASS

**Remark:**

1. At final test to get the worst-case emission at 6.5Mbps.
2. The cable assembly insertion loss of 10.5 dB (including 10 dB pad and 0.5 dB cable) was entered as an offset in the spectrum analyzer to allow for direct reading of power.
3. The maximum antenna gain is 6.29 dBi which is more than 6dBi, the limit should be 7.71 dBm.
4. Total power spectral density = Chain 0 + Chain 1.

**IEEE 802.11gn HT40 Mode (2TX)**

Channel	Channel Frequency (MHz)	Final RF Power Level in 3KHz BW (dBm)		PSD Total (dBm)	Limit (dBm)	Pass / Fail
		Chain 0	Chain 1			
Low	2422	-13.87	-16.19	-11.87	7.71	PASS
Middle	2437	-8.47	-8.87	-5.65	7.71	PASS
High	2452	-13.59	-15.59	-11.47	7.71	PASS

**Remark:**

1. At final test to get the worst-case emission at 13.5Mbps.
2. The cable assembly insertion loss of 10.5 dB (including 10 dB pad and 0.5 dB cable) was entered as an offset in the spectrum analyzer to allow for direct reading of power.
3. The maximum antenna gain is 6.29 dBi which is more than 6dBi, the limit should be 7.71 dBm.
4. Total power spectral density = Chain 0 + Chain 1.



### POWER SPECTRAL DENSITY

#### CH Low (IEEE 802.11b Mode / Chain 0)

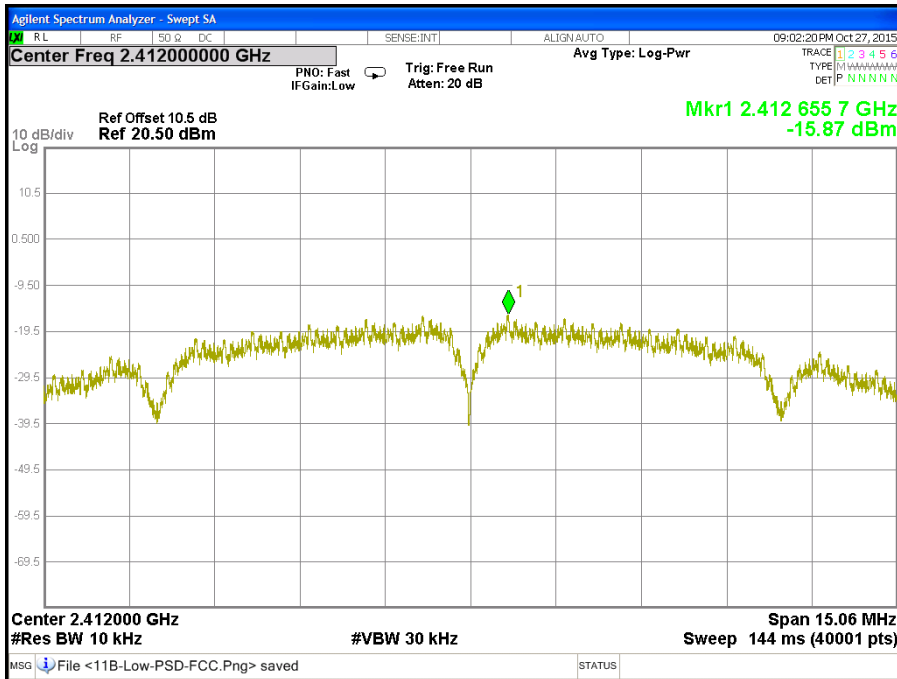

#### CH Middle (IEEE 802.11b Mode / Chain 0)

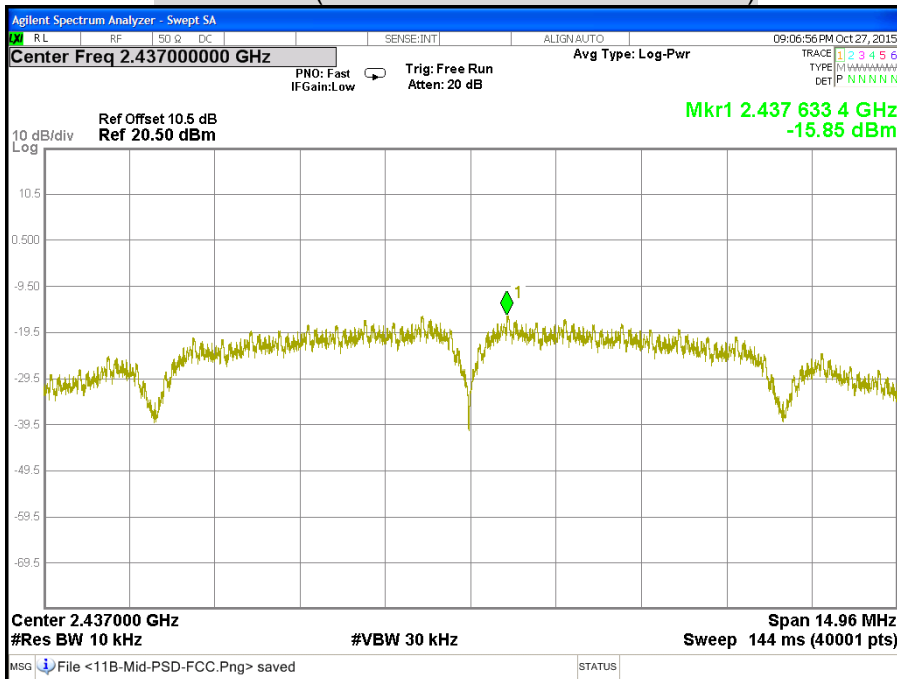

**CH High (IEEE 802.11b Mode / Chain 0)**

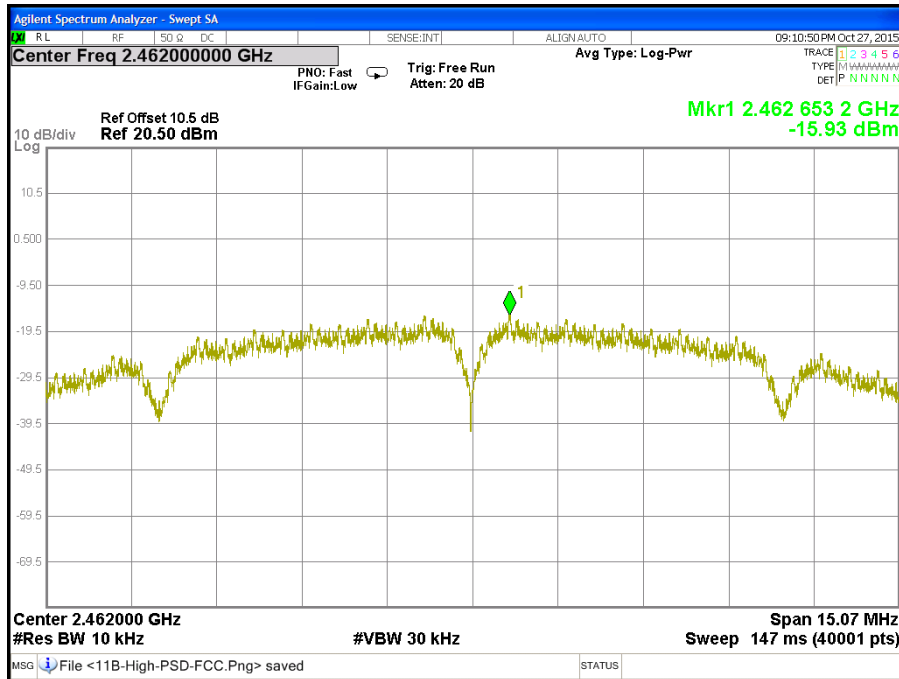

CH Low (IEEE 802.11g Mode / Chain 0)

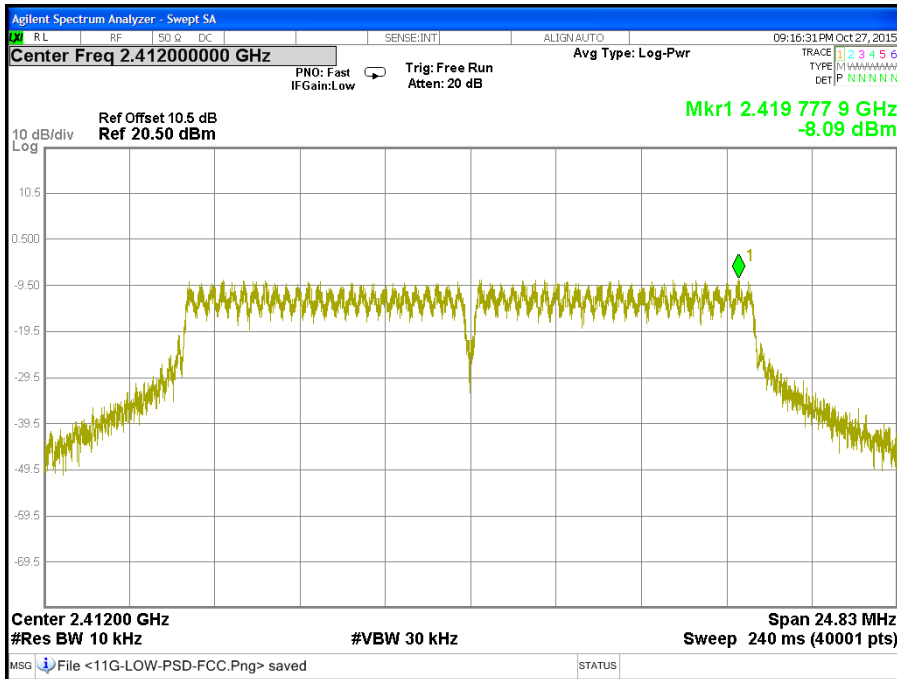

CH Middle (IEEE 802.11g Mode / Chain 0)

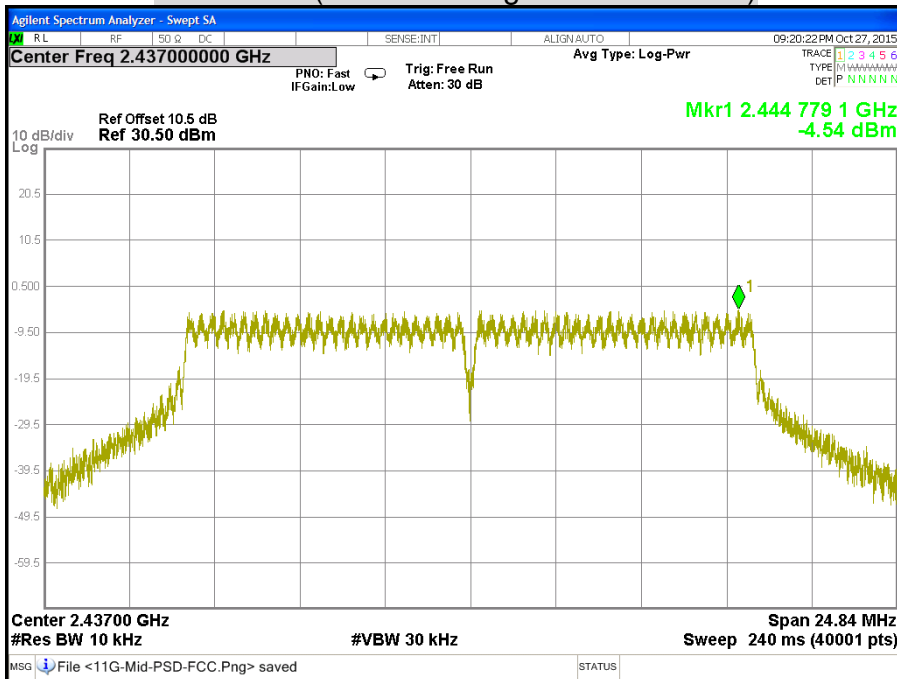

**CH High (IEEE 802.11g Mode / Chain 0)**

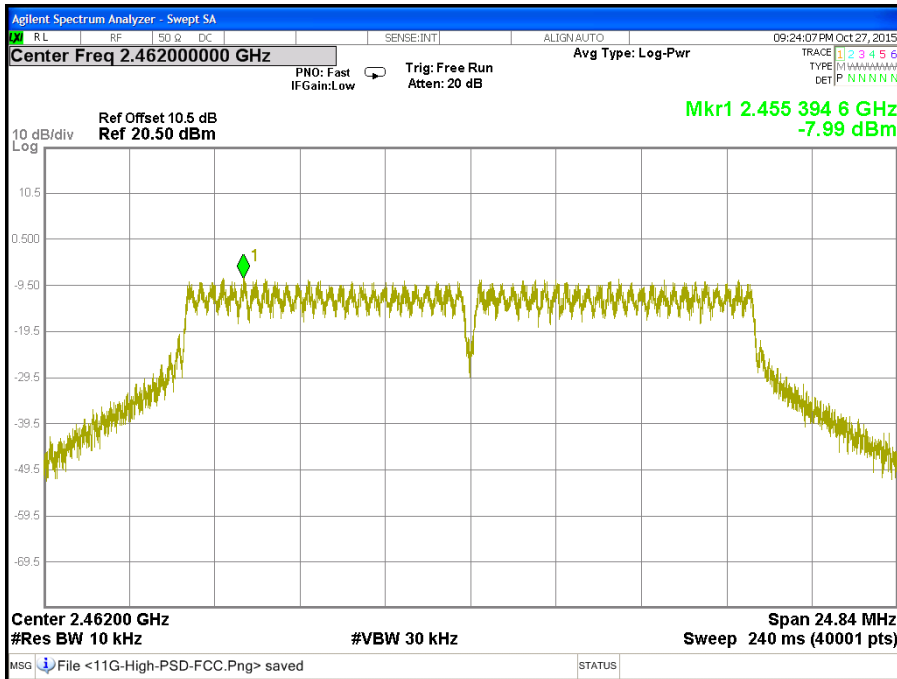

CH Low (IEEE 802.11gn HT20 Mode / Chain 0)

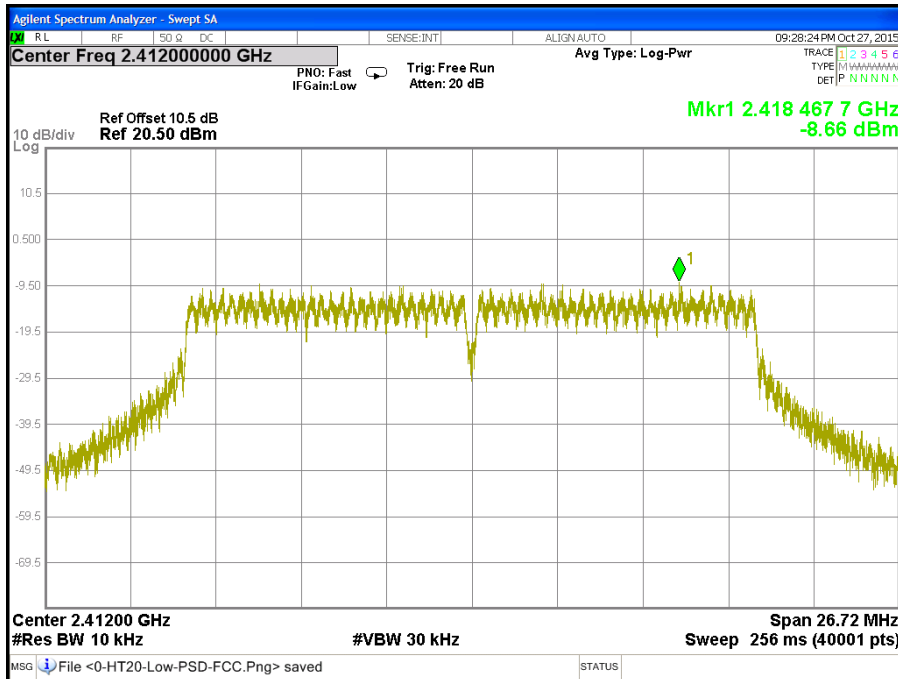

CH Middle (IEEE 802.11gn HT20 Mode / Chain 0)

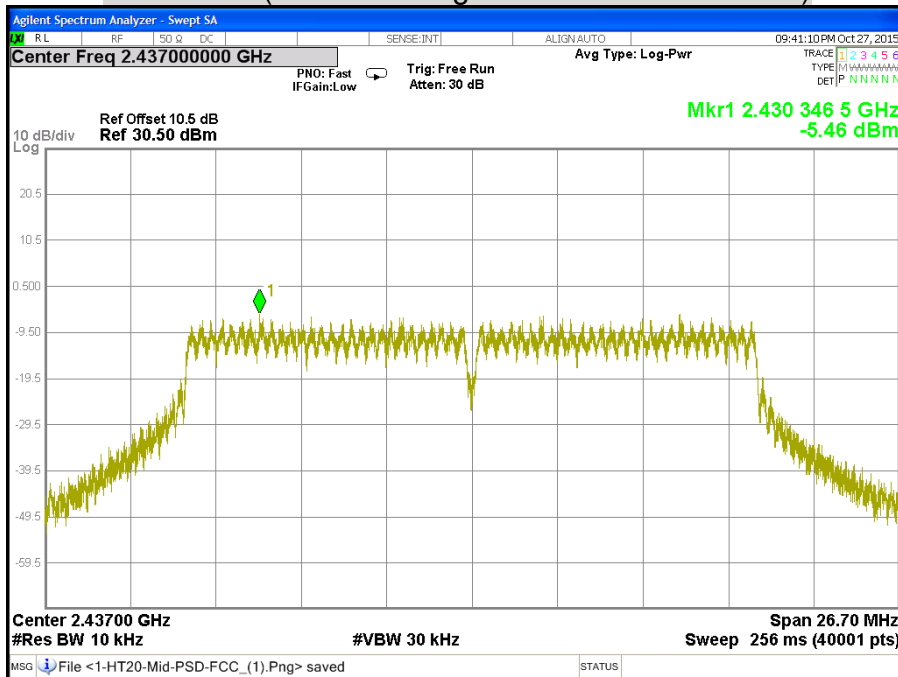

**CH High (IEEE 802.11gn HT20 Mode / Chain 0)**

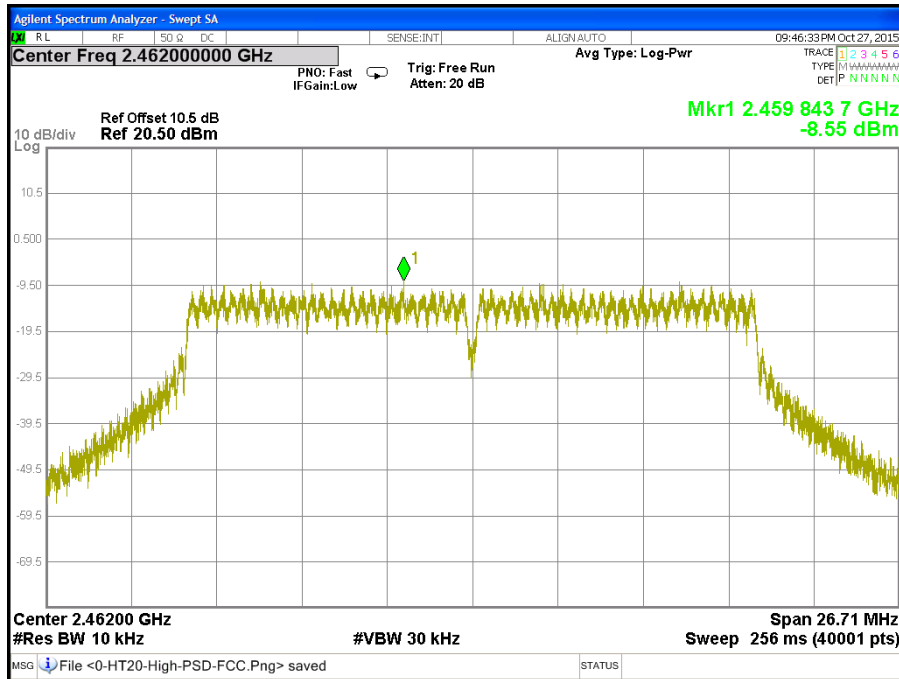

CH Low (IEEE 802.11gn HT20 Mode / Chain 1)

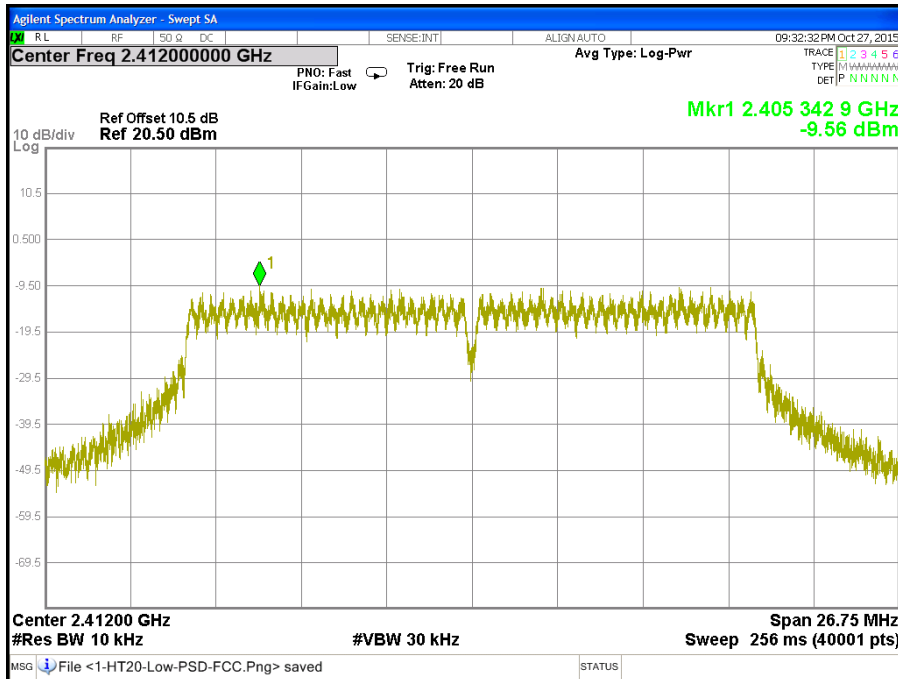

CH Middle (IEEE 802.11gn HT20 Mode / Chain 1)



CH High (IEEE 802.11gn HT20 Mode / Chain 1)

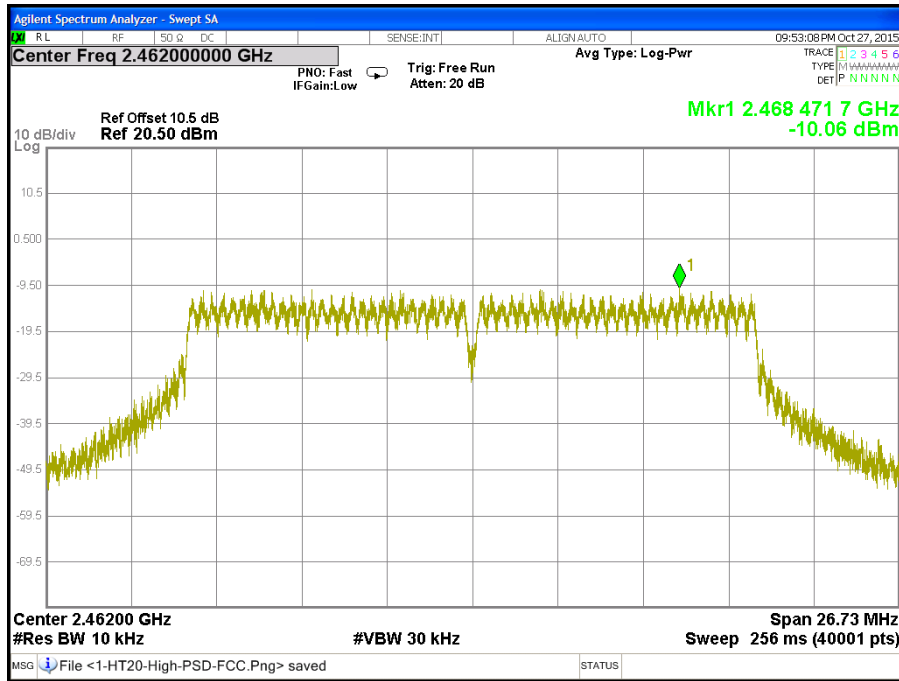



CH Low (IEEE 802.11gn HT40 Mode / Chain 0)

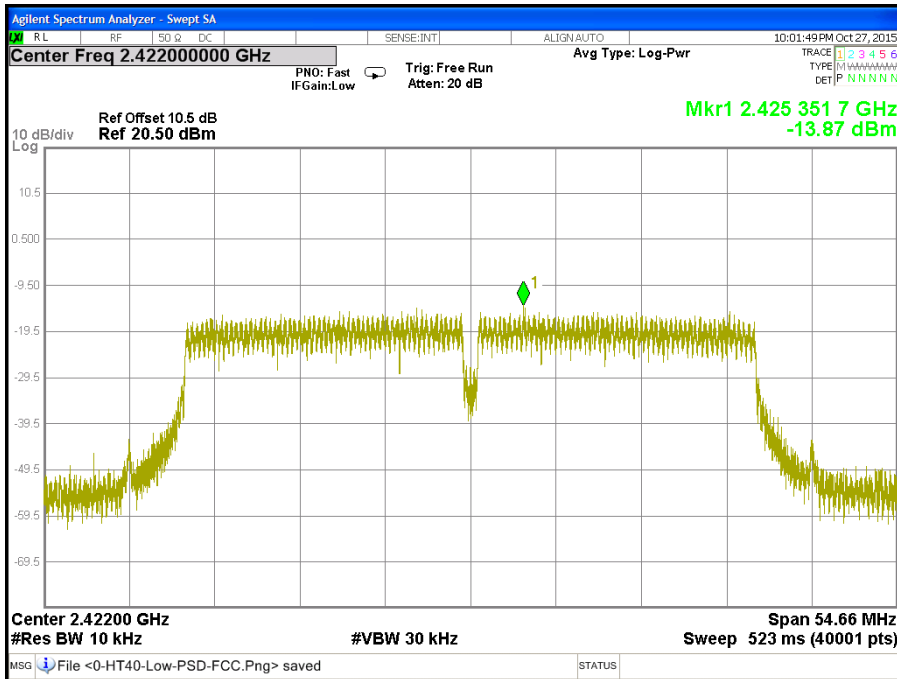

CH Middle (IEEE 802.11gn HT40 Mode / Chain 0)

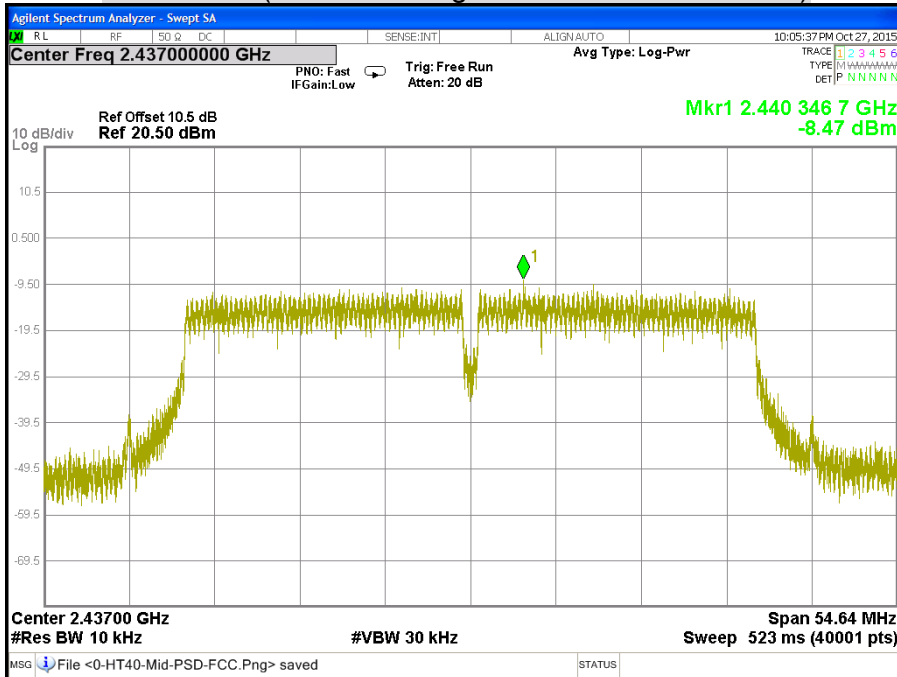

**CH High (IEEE 802.11gn HT40 Mode / Chain 0)**

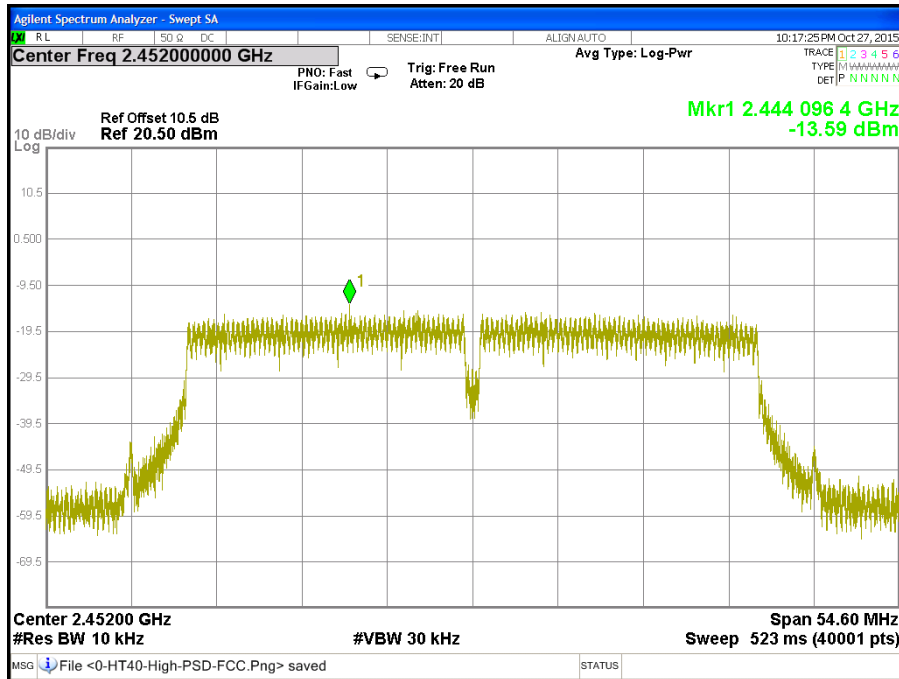

CH Low (IEEE 802.11gn HT40 Mode / Chain 1)

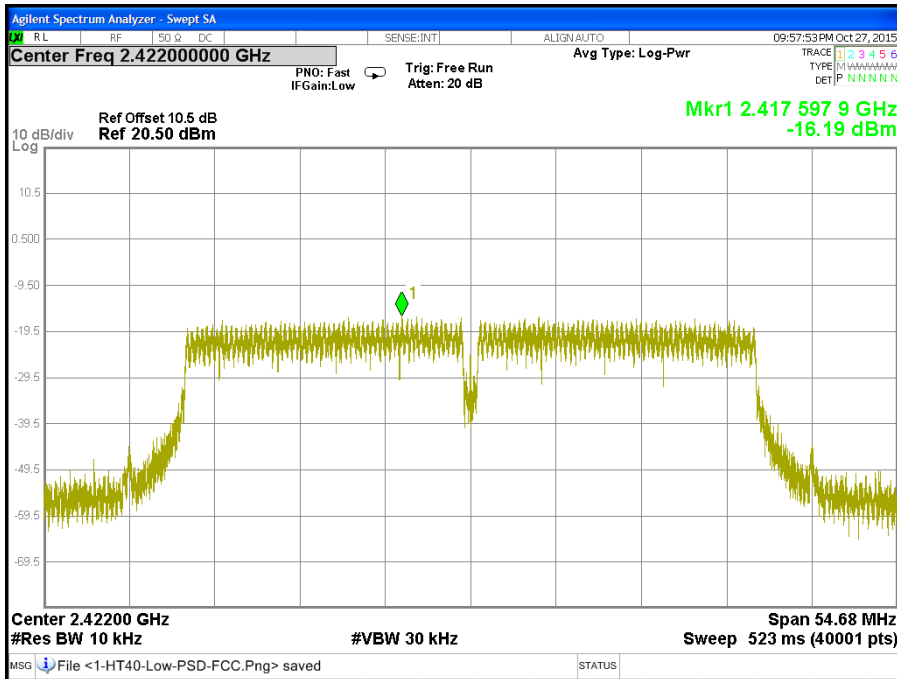

CH Middle (IEEE 802.11gn HT40 Mode / Chain 1)

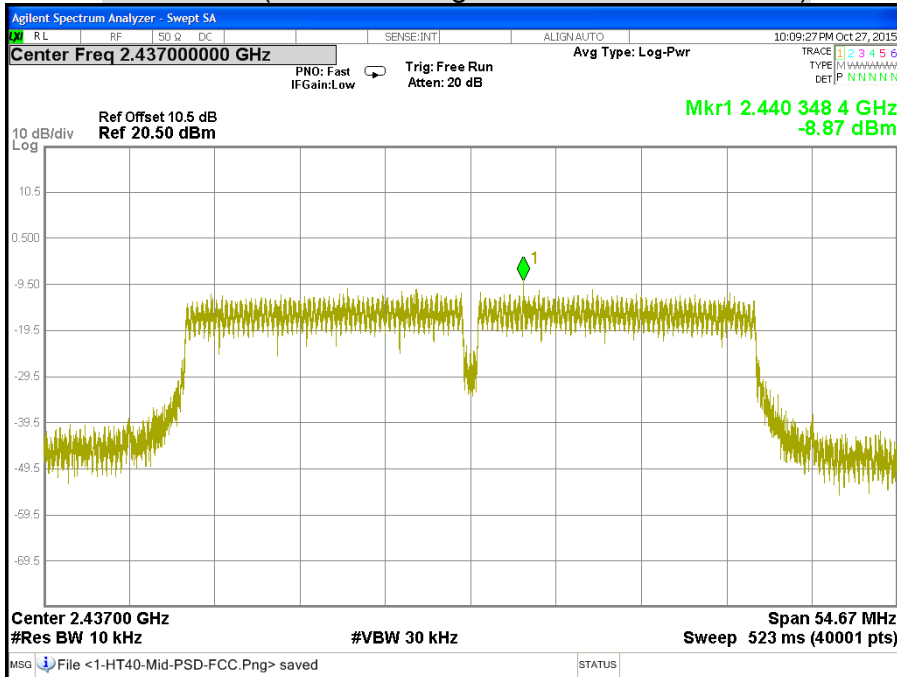

**CH High (IEEE 802.11gn HT40 Mode / Chain 1)**

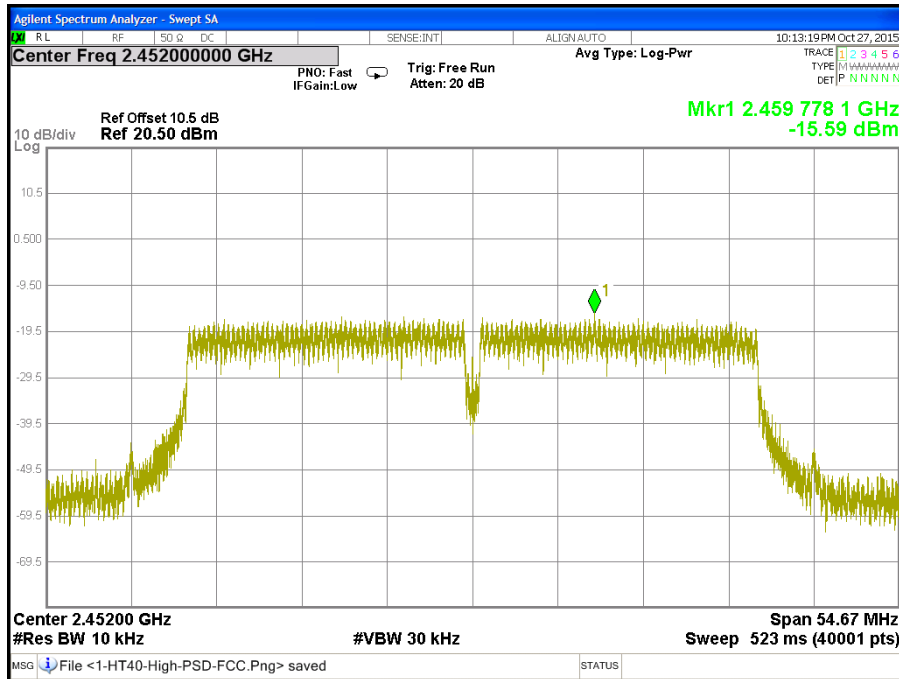

## 7.5 CONDUCTED SPURIOUS EMISSION

### LIMITS

§ 15.247(d) In any 100 kHz bandwidth outside the frequency band in which the spread spectrum intentional radiator is operating, the radio frequency power that is produced by the intentional radiator shall be at least 20 dB below that in the 100 kHz bandwidth within the and that contains the highest level of the desired power, based on either an RF conducted or a radiated measurement. Attenuation below the general limits specified in § 15.209(a) is not required. In addition, radiated emissions which fall in the restricted bands, as defined in § 15.205(a), must also comply with the radiated emission limits specified in § 15.209(a) (see § 15.205(c)).

### TEST EQUIPMENT

Name of Equipment	Manufacturer	Model	Serial Number	Calibration Due
EXA Signal Analyzer	Agilent	N9010A	MY52220817	03/19/2016

*Remark: Each piece of equipment is scheduled for calibration once a year.*

### TEST SETUP



### TEST PROCEDURE

The transmitter output is connected to a spectrum analyzer. The resolution bandwidth is set to 100 kHz. The video bandwidth is set to 300 kHz.

The spectrum from 30 MHz to 26.5 GHz is investigated with the transmitter set to the lowest, middle, and highest channels in the 2.4 GHz band.

**TEST RESULTS**

**OUT-OF-BAND SPURIOUS EMISSIONS-CONDUCTED MEASUREMENT**

CH Low (2.38GHz ~ 2.5GHz / IEEE 802.11b Mode / Chain 0)

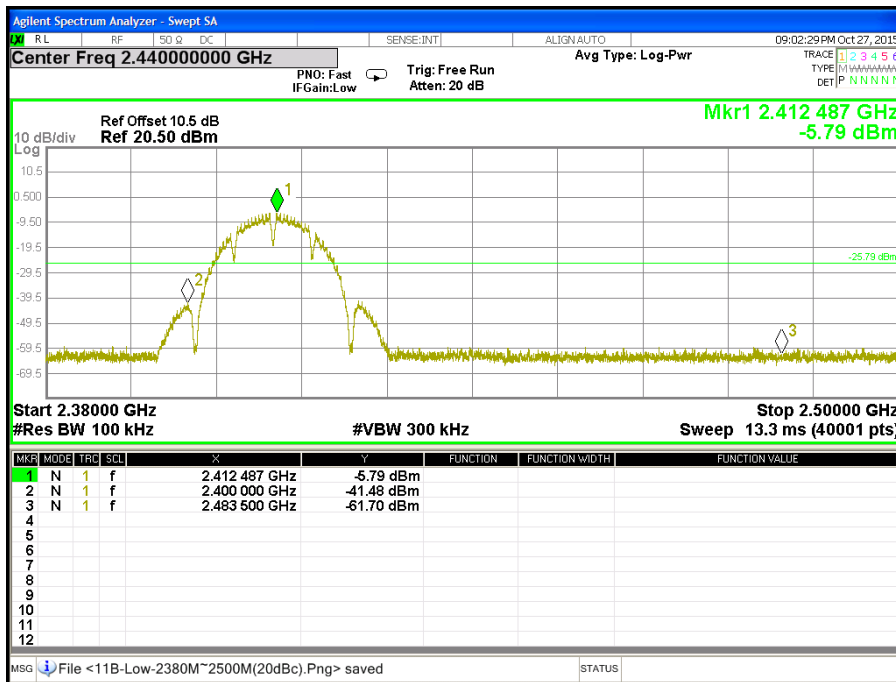

CH Low (30MHz ~ 26.5GHz / IEEE 802.11b Mode / Chain 0)

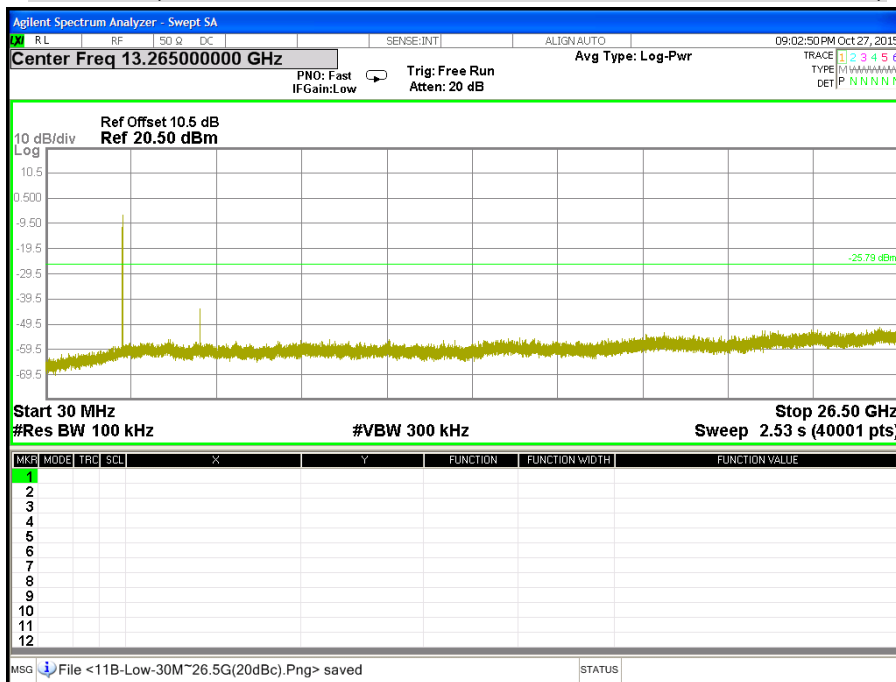

**CH Middle (2.38GHz ~ 2.5GHz / IEEE 802.11b Mode / Chain 0)**

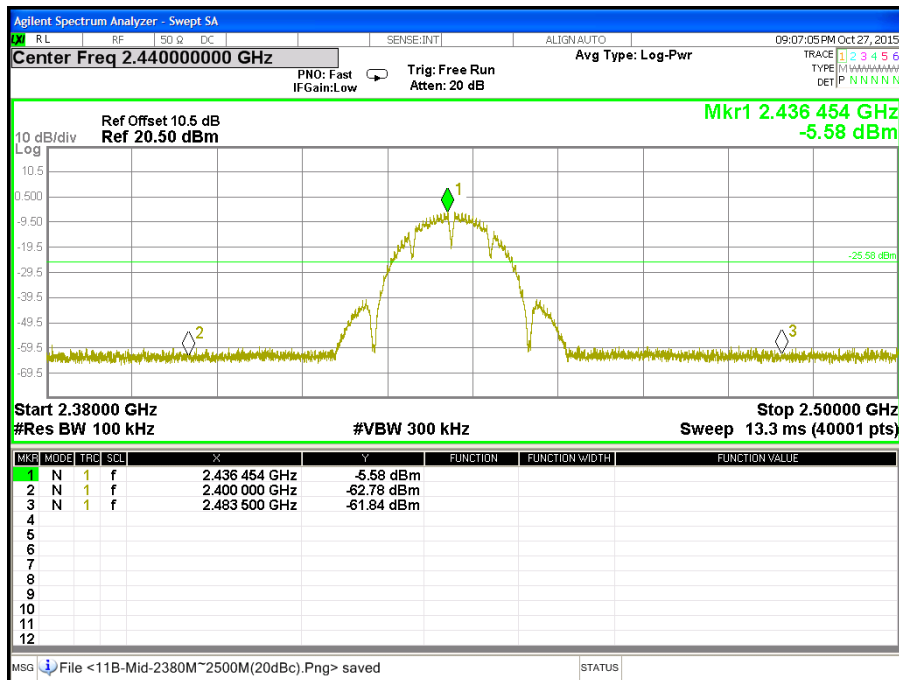

**CH Middle (30MHz ~ 26.5GHz / IEEE 802.11b Mode / Chain 0)**

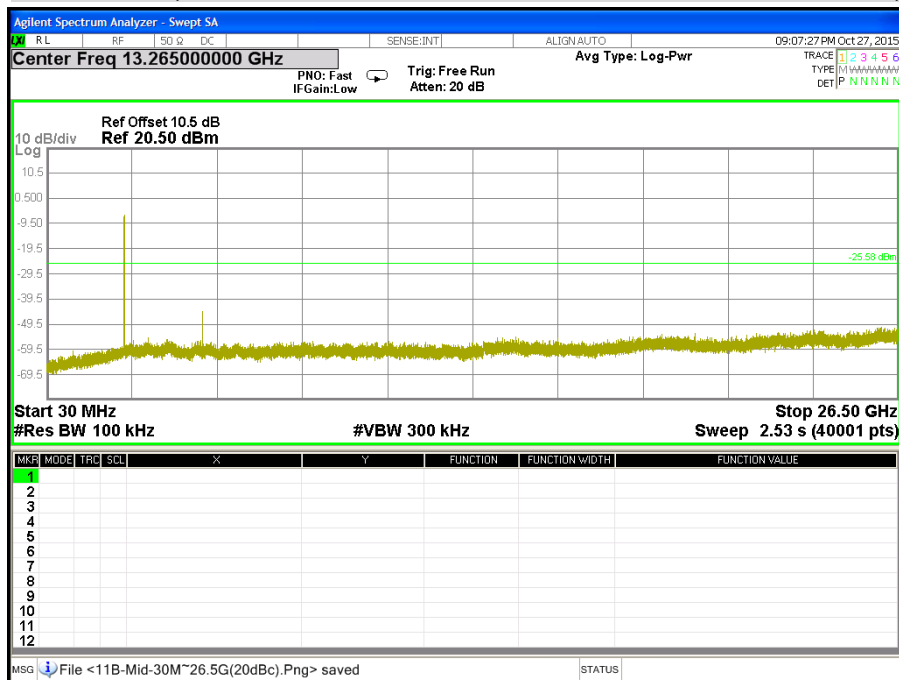

**CH High (2.38GHz ~ 2.5GHz / IEEE 802.11b Mode / Chain 0)**

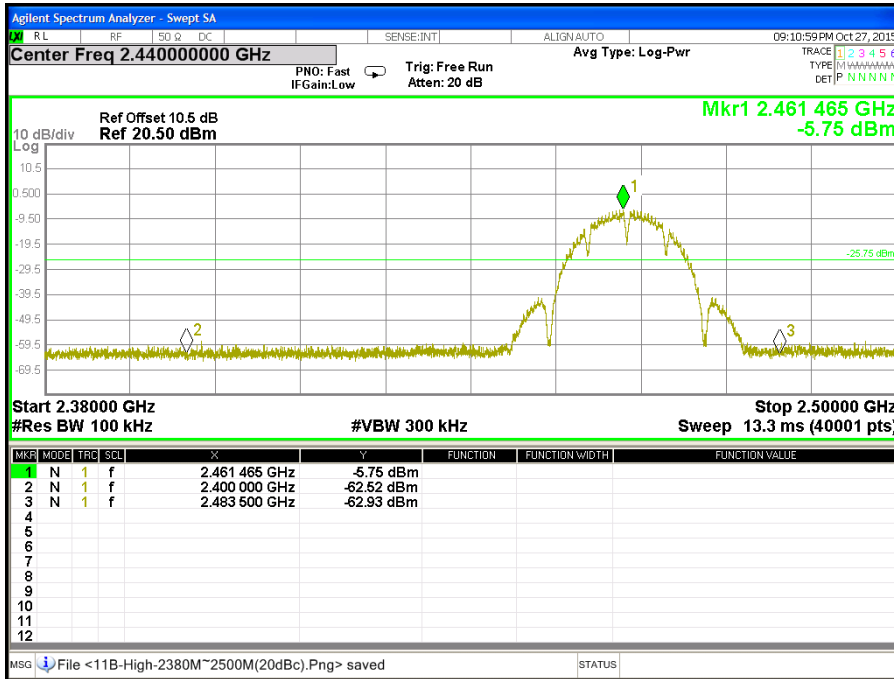

**CH High (30MHz ~ 26.5GHz / IEEE 802.11b Mode / Chain 0)**

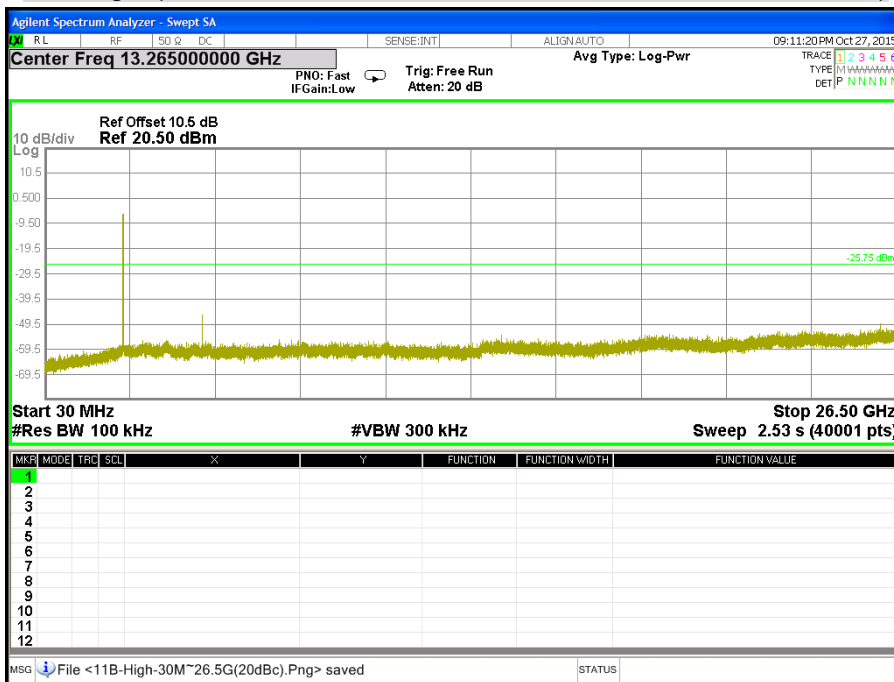



**CH Low (2.38GHz ~ 2.5GHz / IEEE 802.11g Mode / Chain 0)**

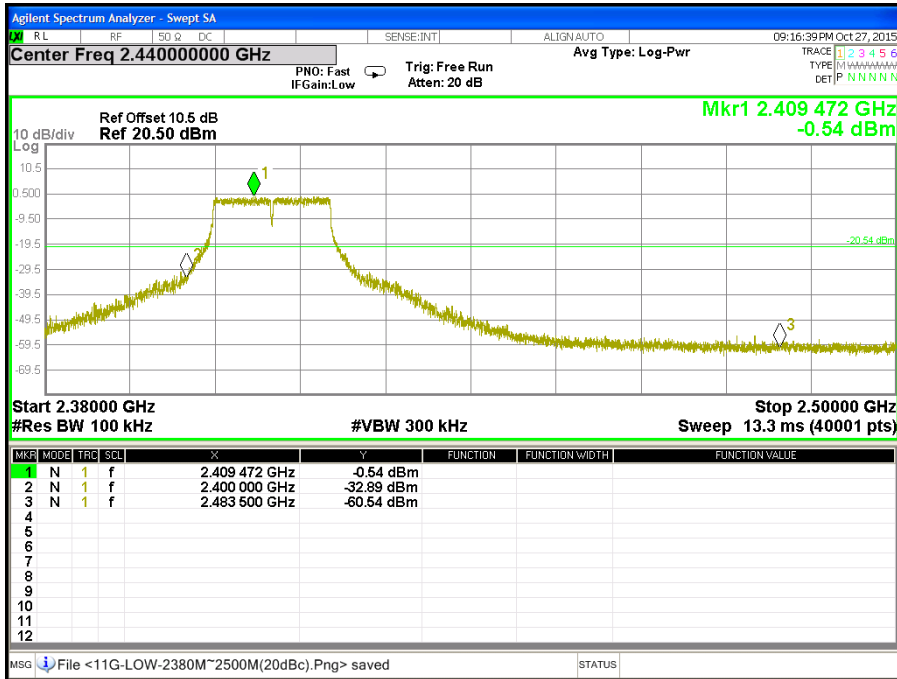

**CH Low (30MHz ~ 26.5GHz / IEEE 802.11g Mode / Chain 0)**

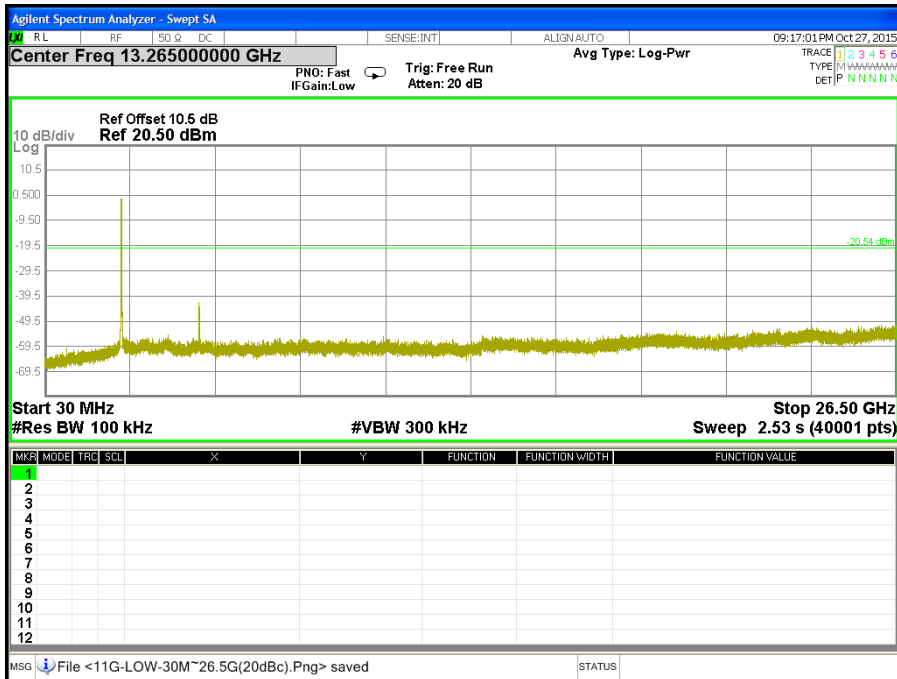

**CH Middle (2.38GHz ~ 2.5GHz / IEEE 802.11g Mode / Chain 0)**

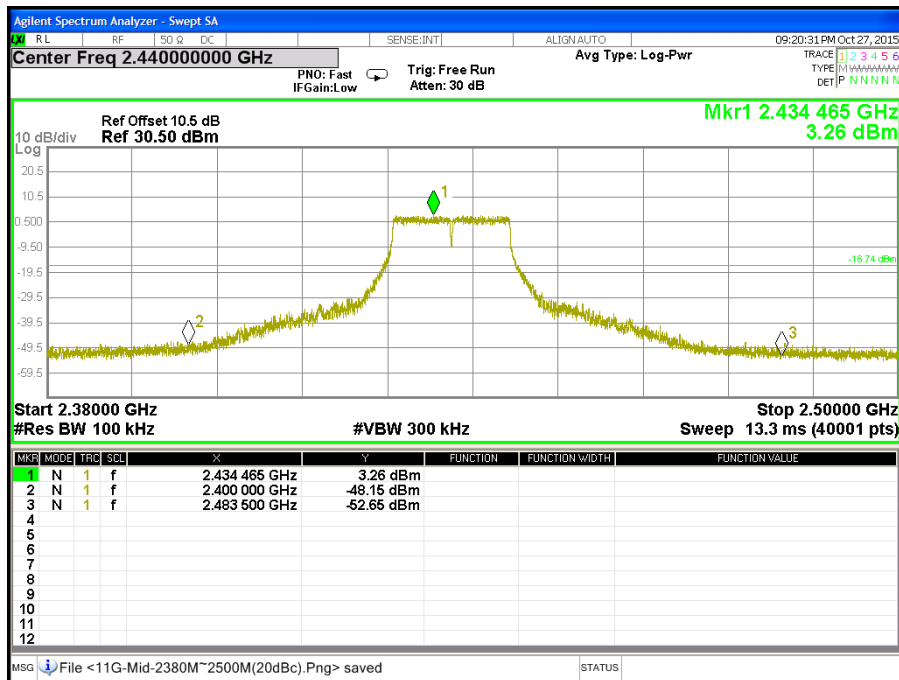

**CH Middle (30MHz ~ 26.5GHz / IEEE 802.11g Mode / Chain 0)**

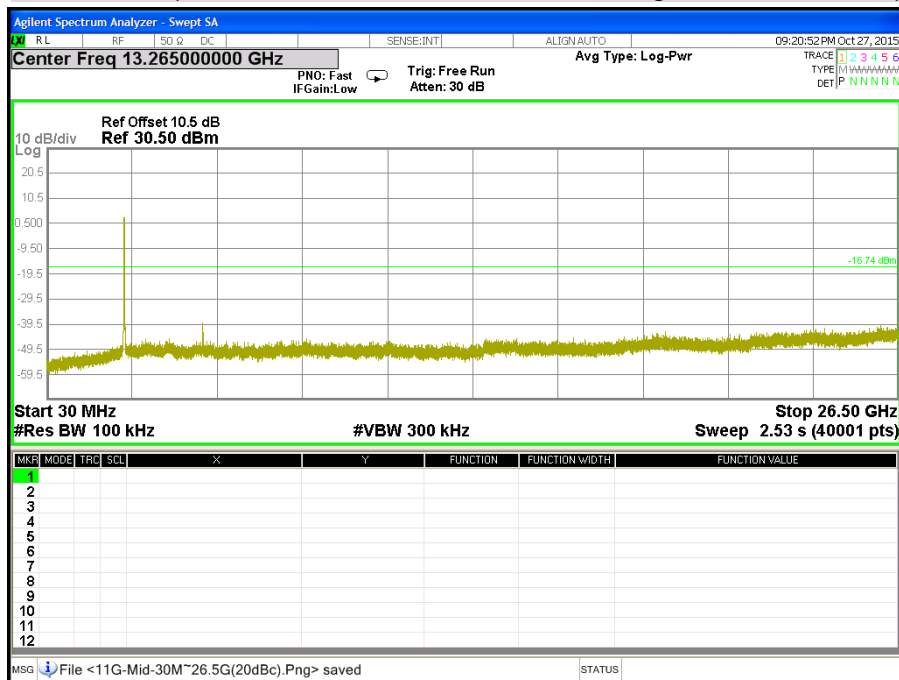

**CH High (2.38GHz ~ 2.5GHz / IEEE 802.11g Mode / Chain 0)**

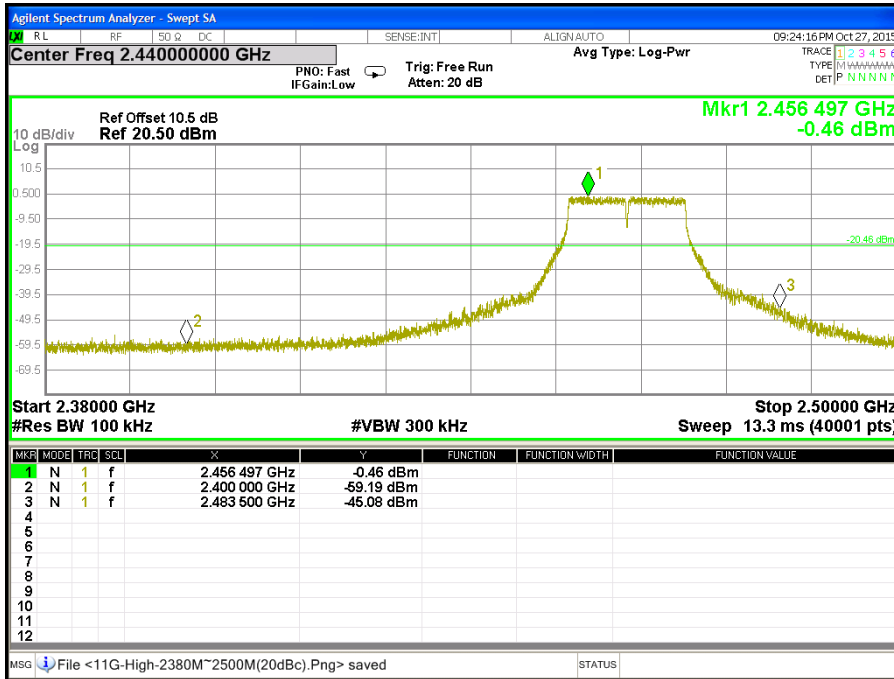

**CH High (30MHz ~ 26.5GHz / IEEE 802.11g Mode / Chain 0)**

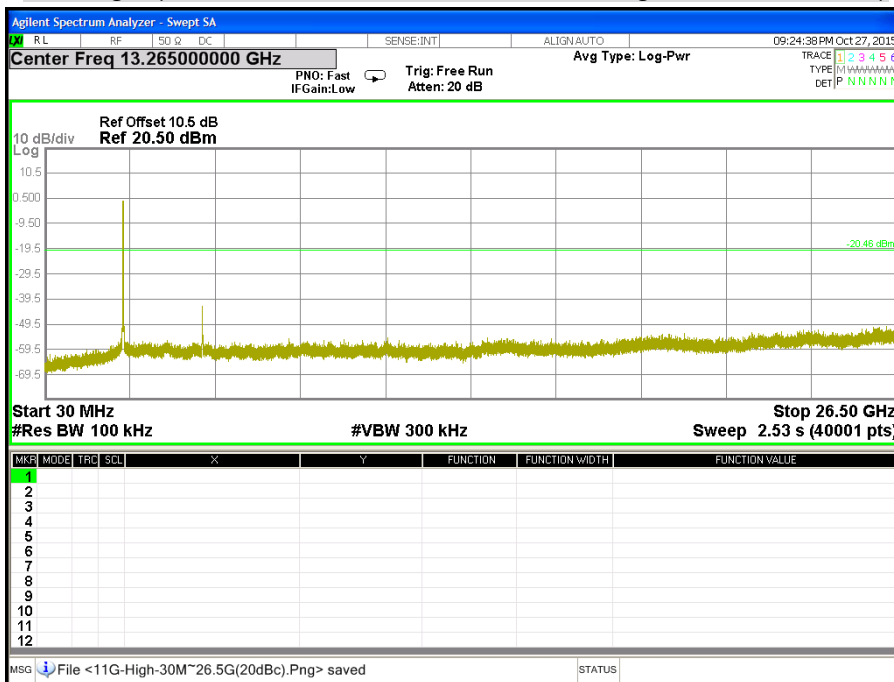

**CH Low (2.38GHz ~ 2.5GHz / IEEE 802.11gn HT20 Mode / Chain 0)**

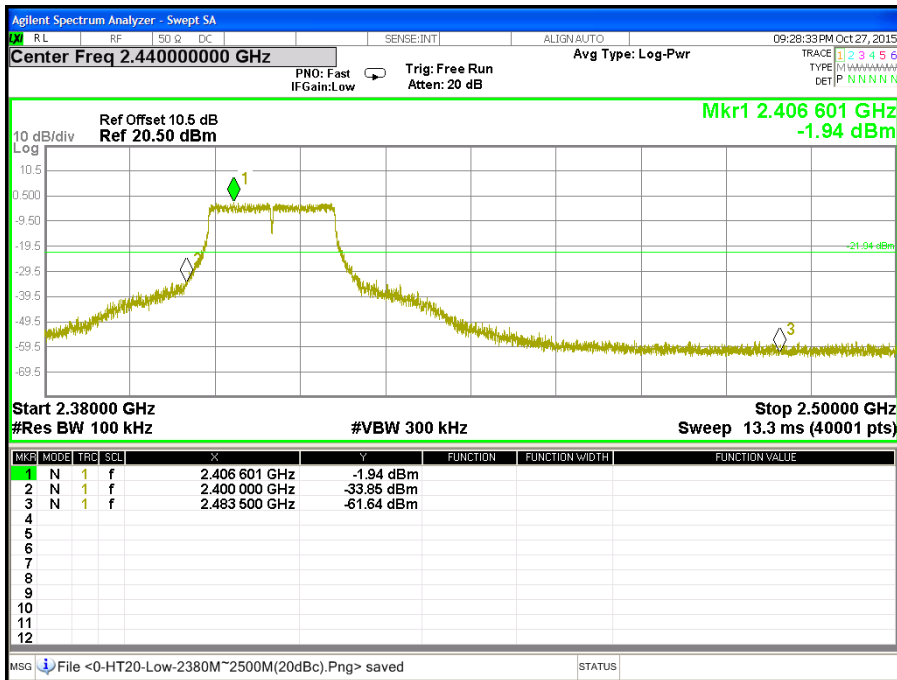

**CH Low (30MHz ~ 26.5GHz / IEEE 802.11gn HT20 Mode / Chain 0)**

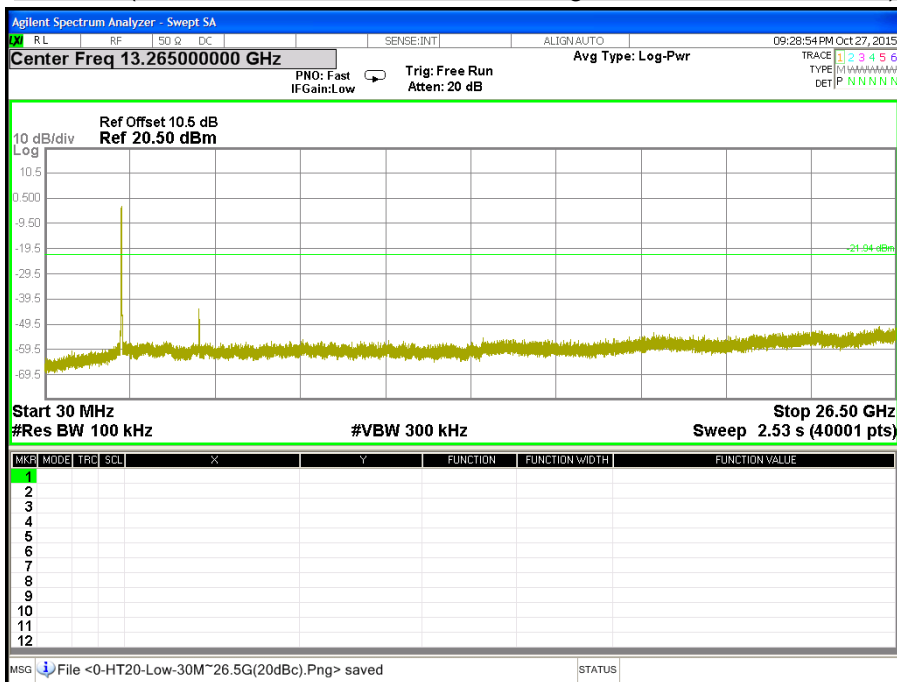

CH Middle (2.38GHz ~ 2.5GHz / IEEE 802.11gn HT20 Mode / Chain 0)

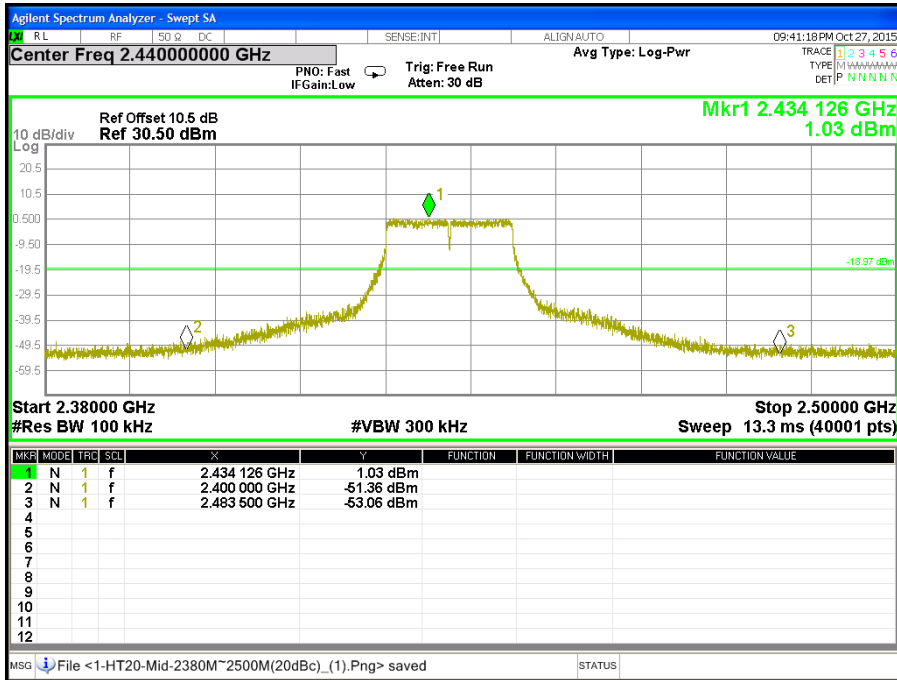

CH Middle (30MHz ~ 26.5GHz / IEEE 802.11gn HT20 Mode / Chain 0)

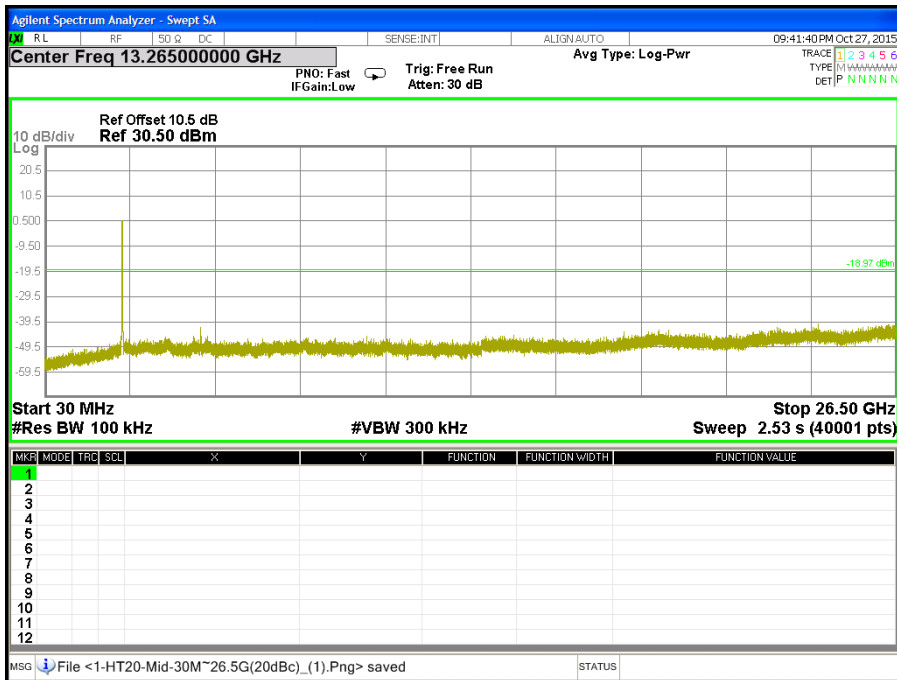

**CH High (2.38GHz ~ 2.5GHz / IEEE 802.11gn HT20 Mode / Chain 0)**

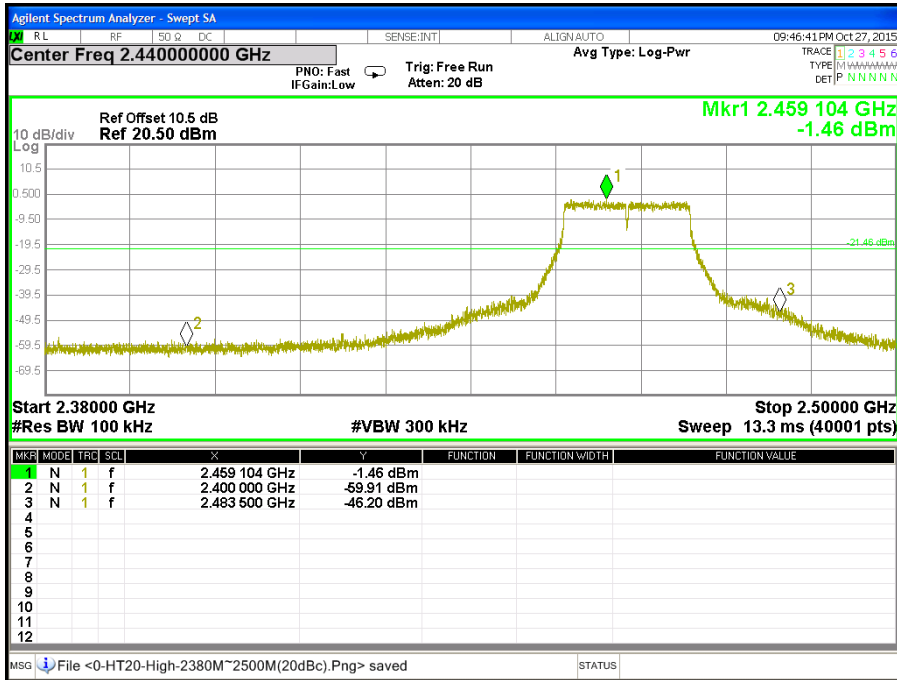

**CH High (30MHz ~ 26.5GHz / IEEE 802.11gn HT20 Mode / Chain 0)**

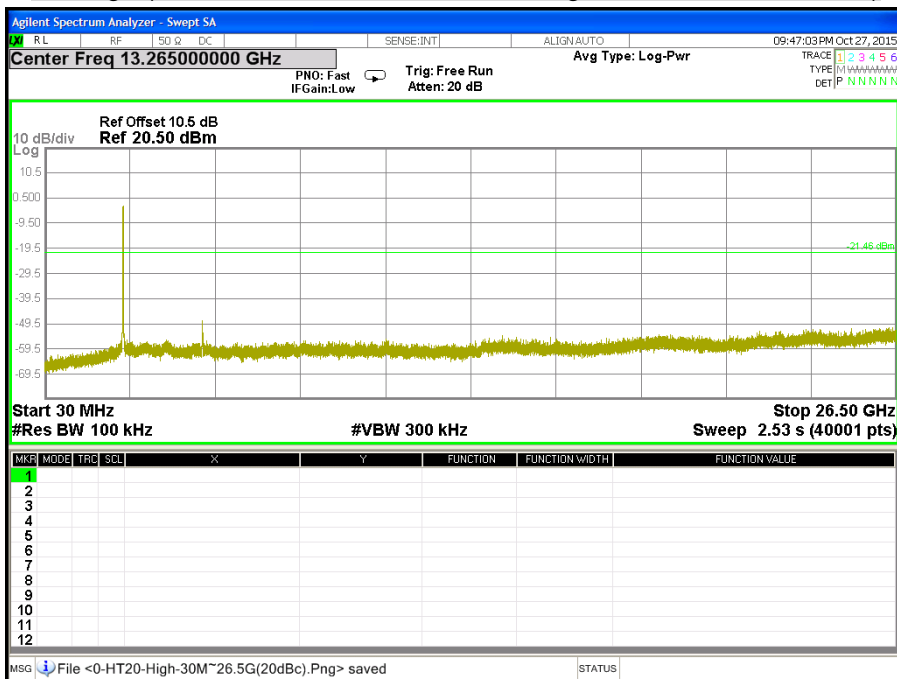

**CH Low (2.38GHz ~ 2.5GHz / IEEE 802.11gn HT20 Mode / Chain 1)**

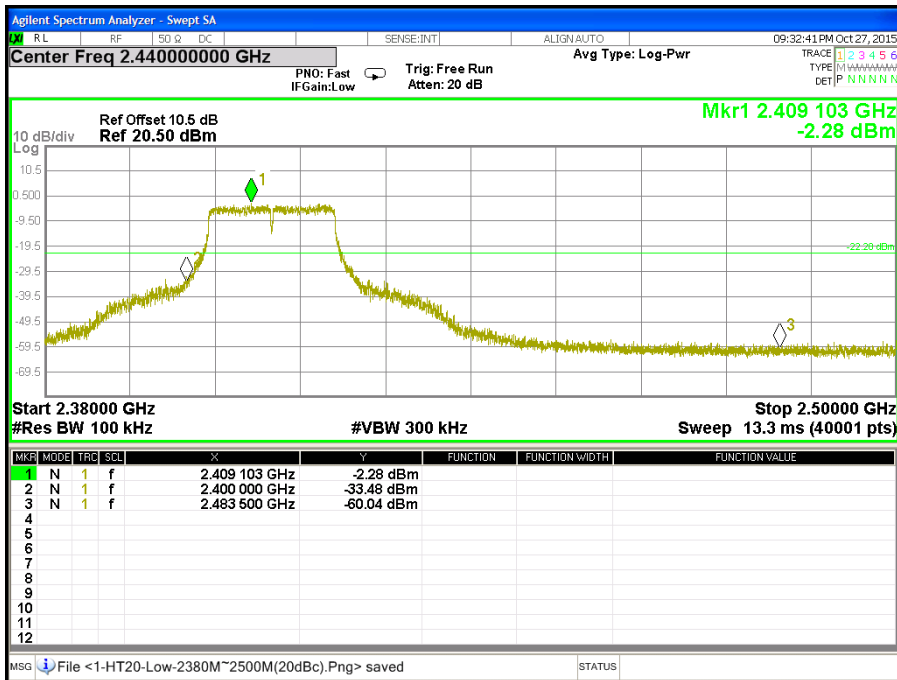

**CH Low (30MHz ~ 26.5GHz / IEEE 802.11gn HT20 Mode / Chain 1)**

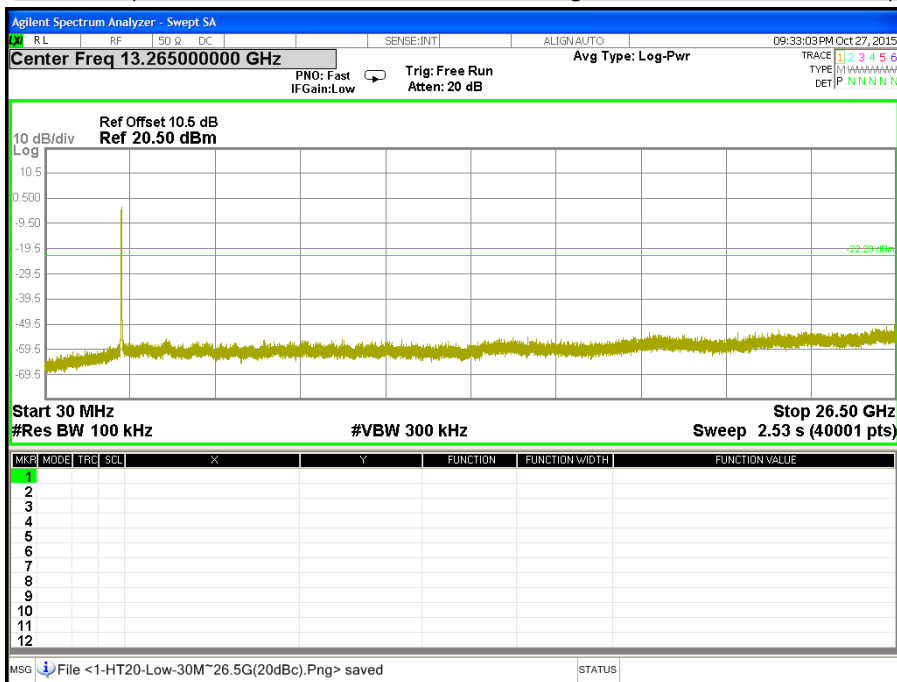

**CH Middle (2.38GHz ~ 2.5GHz / IEEE 802.11gn HT20 Mode / Chain 1)**

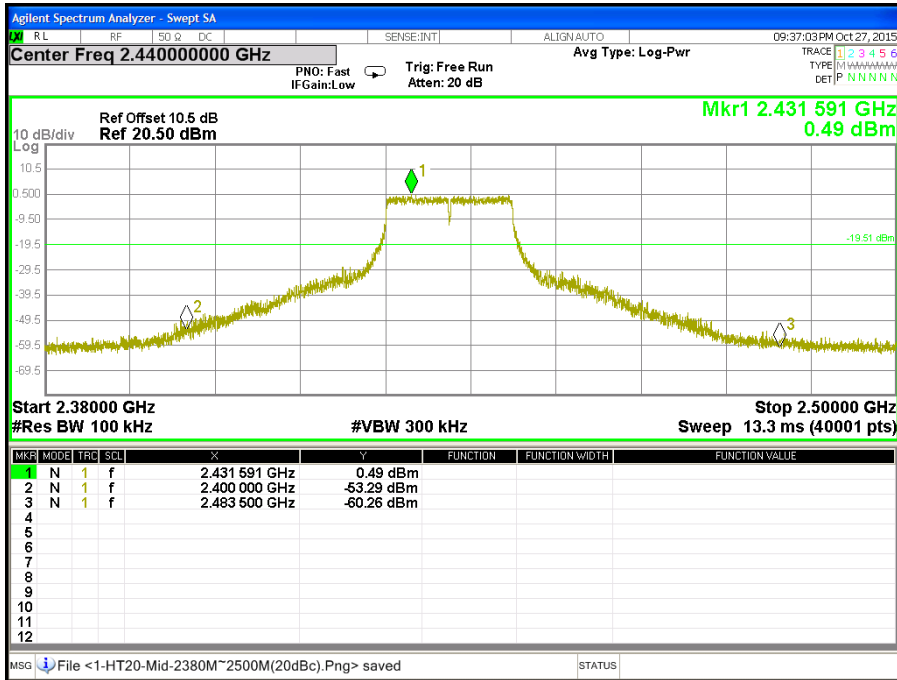

**CH Middle (30MHz ~ 26.5GHz / IEEE 802.11gn HT20 Mode / Chain 1)**

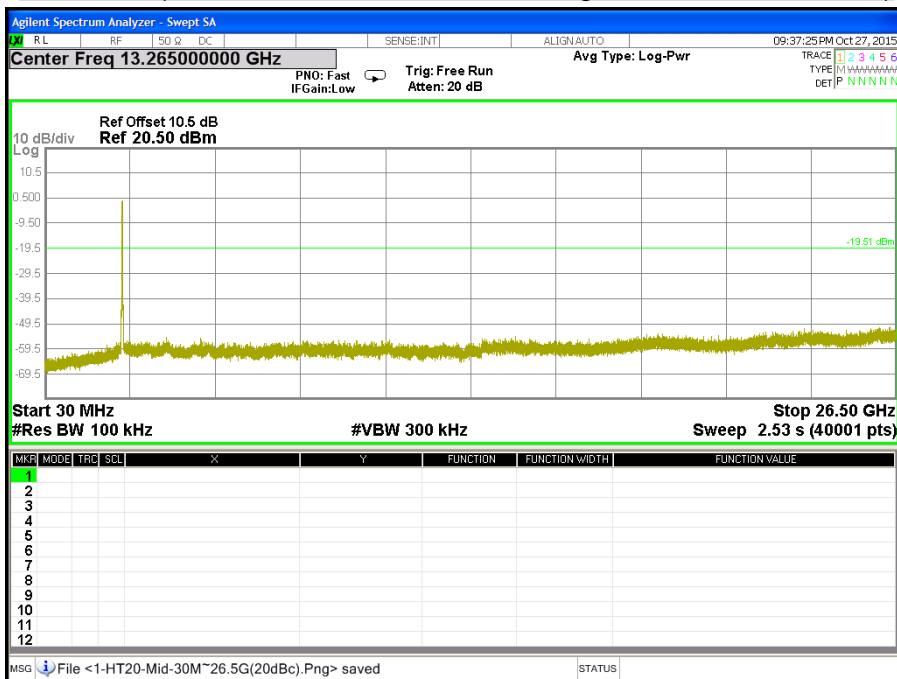



**CH High (2.38GHz ~ 2.5GHz / IEEE 802.11gn HT20 Mode / Chain 1)**

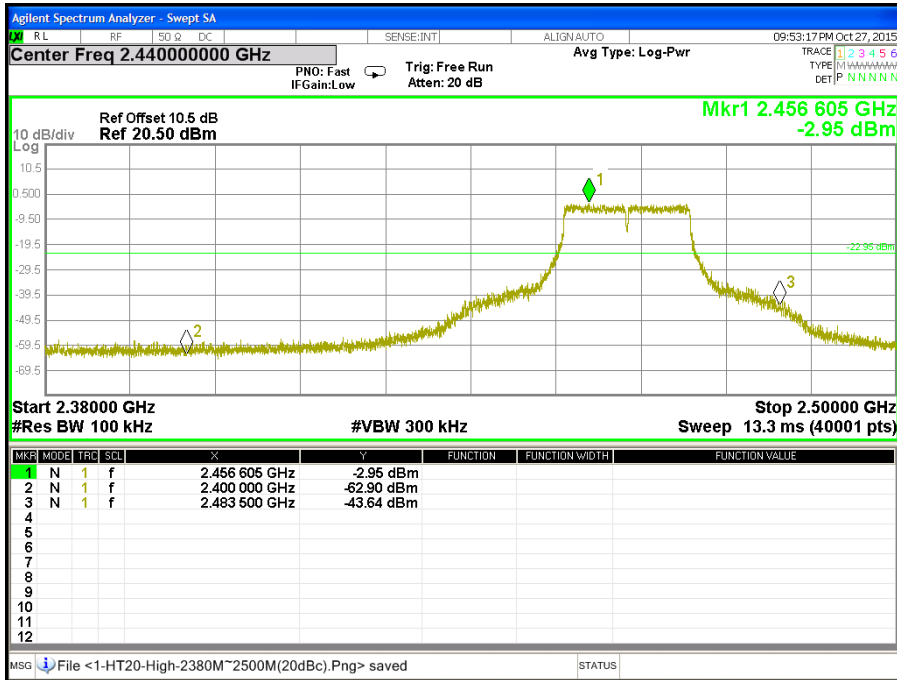

**CH High (30MHz ~ 26.5GHz / IEEE 802.11gn HT20 Mode / Chain 1)**

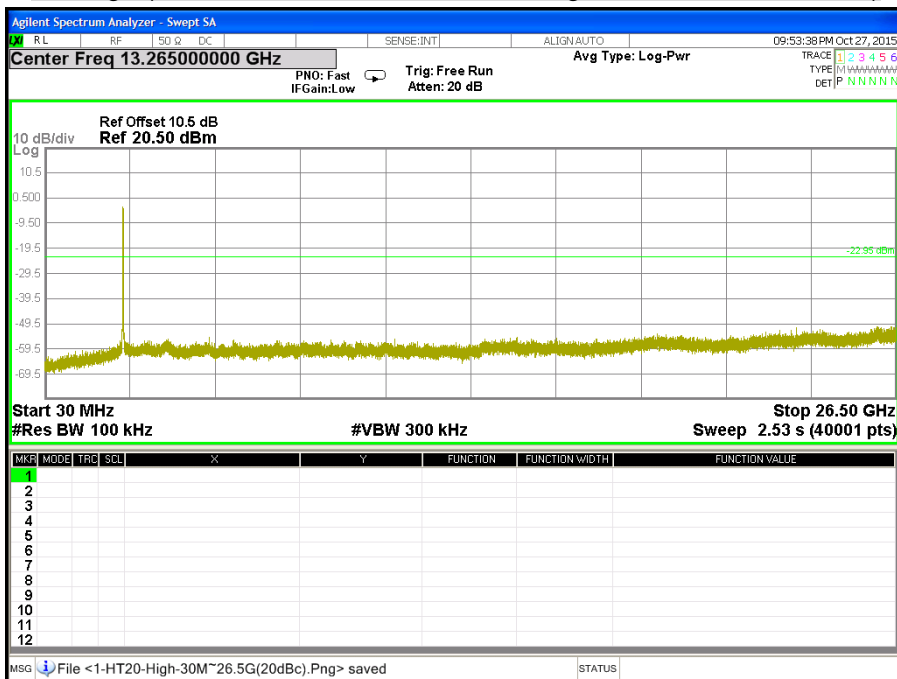

**CH Low (2.38GHz ~ 2.5GHz / IEEE 802.11gn HT40 Mode / Chain 0)**

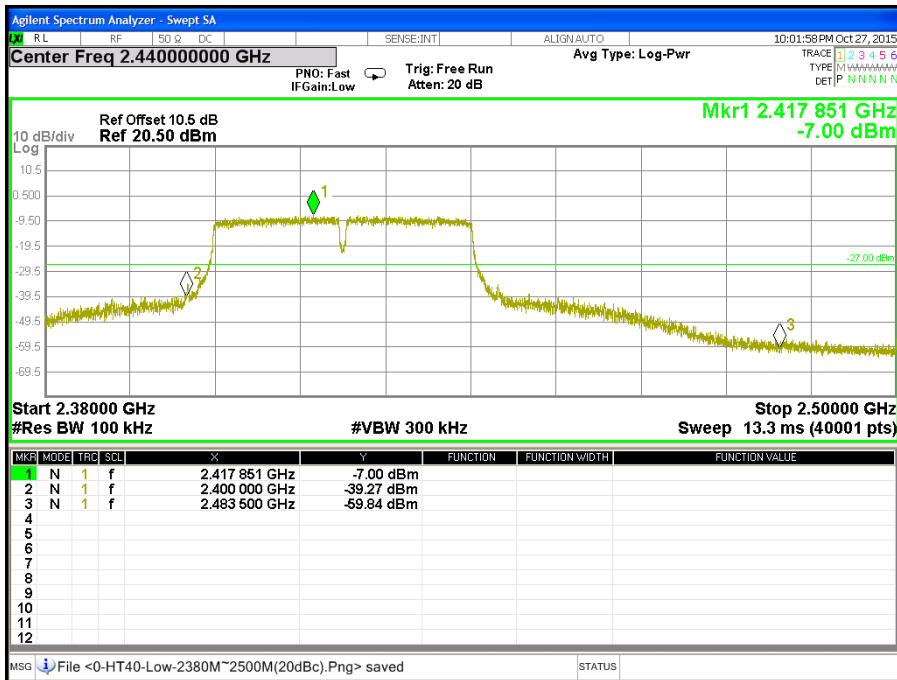

**CH Low (30MHz ~ 26.5GHz / IEEE 802.11gn HT40 Mode / Chain 0)**

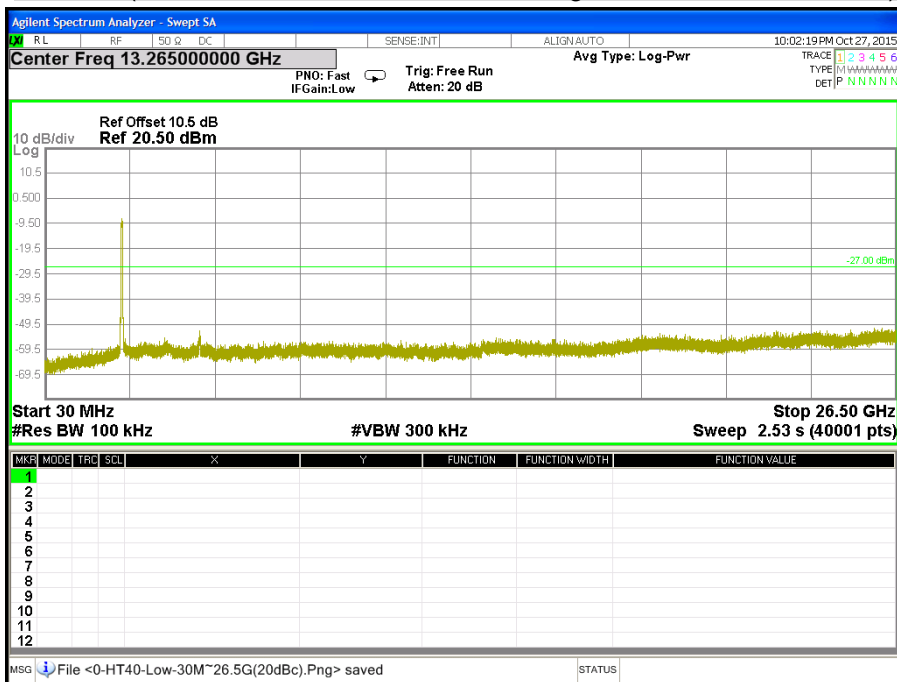

**CH Middle (2.38GHz ~ 2.5GHz / IEEE 802.11gn HT40 Mode / Chain 0)**

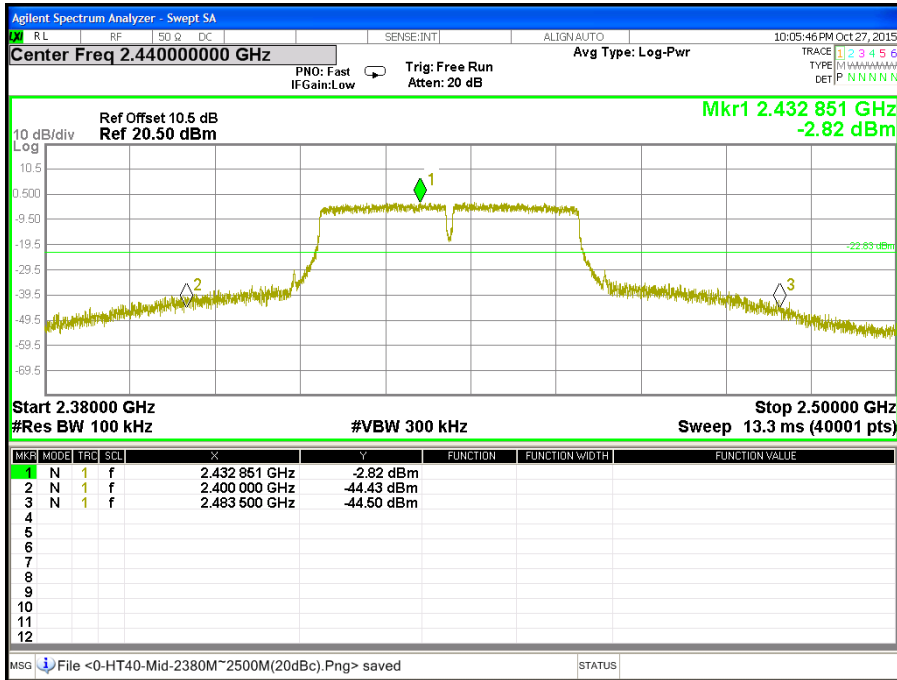

**CH Middle (30MHz ~ 26.5GHz / IEEE 802.11gn HT40 Mode / Chain 0)**

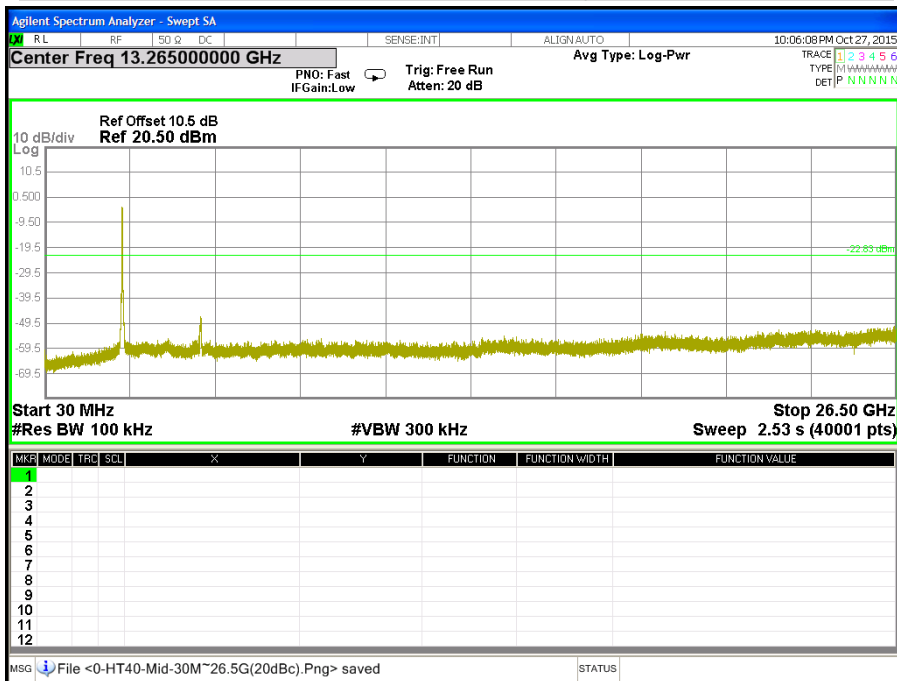

**CH High (2.38GHz ~ 2.5GHz / IEEE 802.11gn HT40 Mode / Chain 0)**

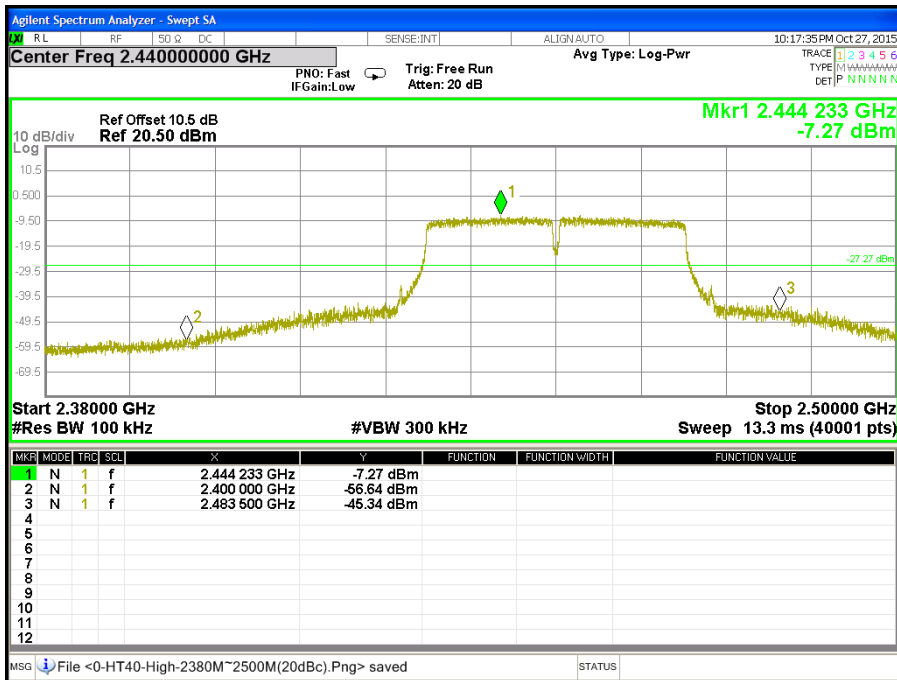

**CH High (30MHz ~ 26.5GHz / IEEE 802.11gn HT40 Mode / Chain 0)**

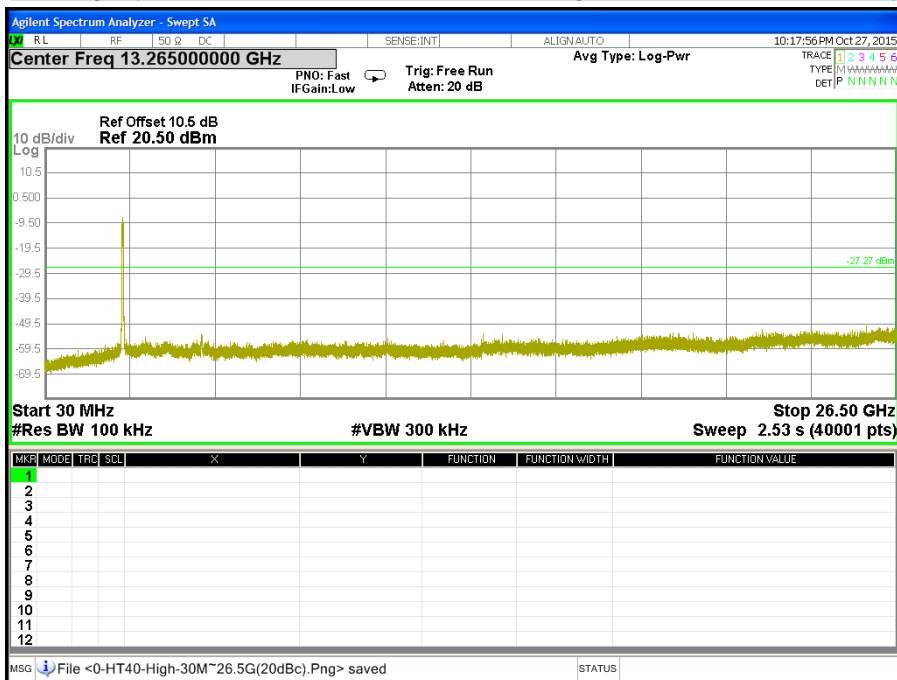

**CH Low (2.38GHz ~ 2.5GHz / IEEE 802.11gn HT40 Mode / Chain 1)**

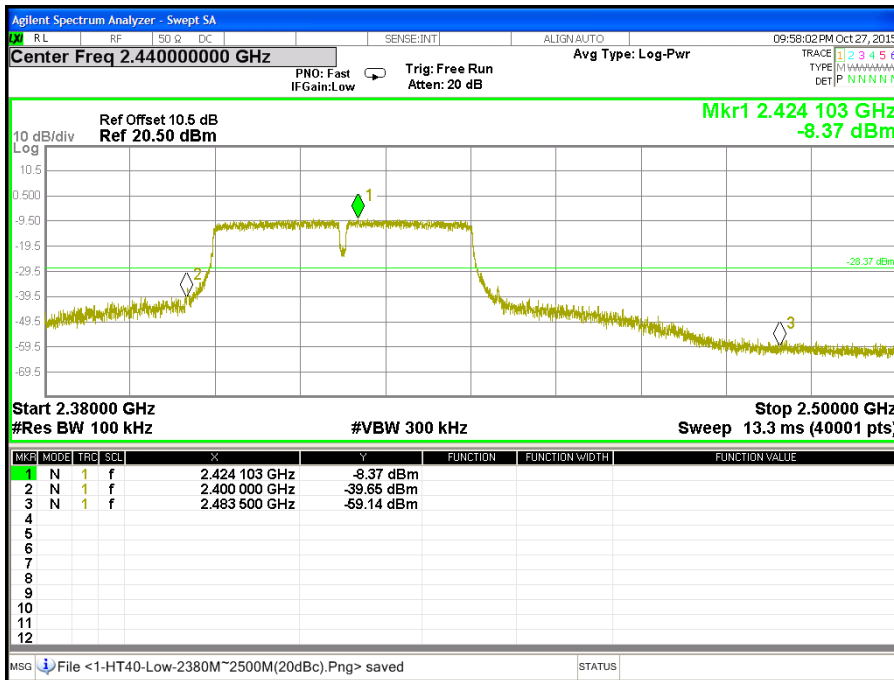

**CH Low (30MHz ~ 26.5GHz / IEEE 802.11gn HT40 Mode / Chain 1)**

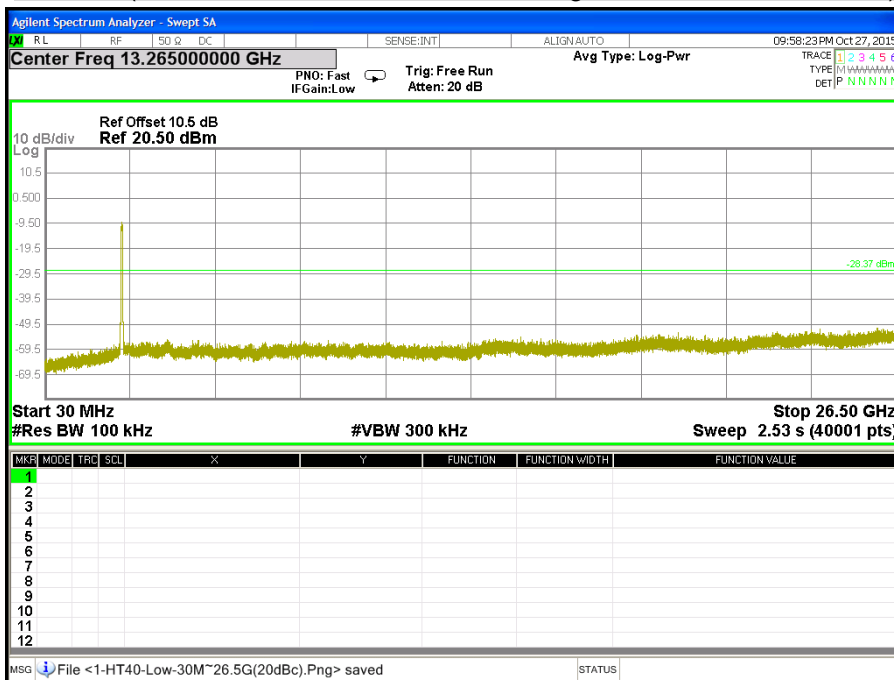

**CH Middle (2.38GHz ~ 2.5GHz / IEEE 802.11gn HT40 Mode / Chain 1)**

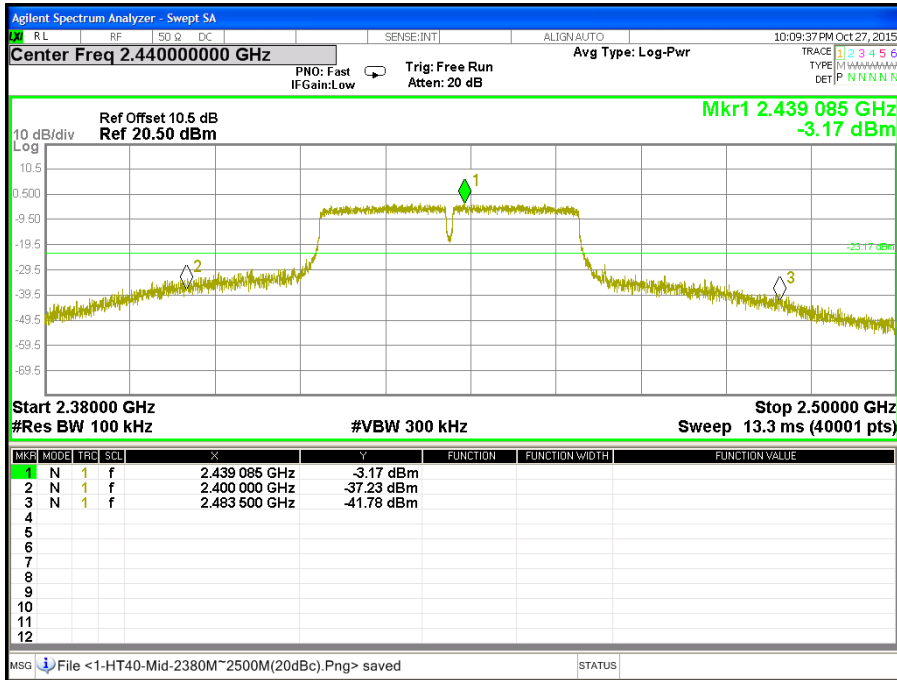

**CH Middle (30MHz ~ 26.5GHz / IEEE 802.11gn HT40 Mode / Chain 1)**

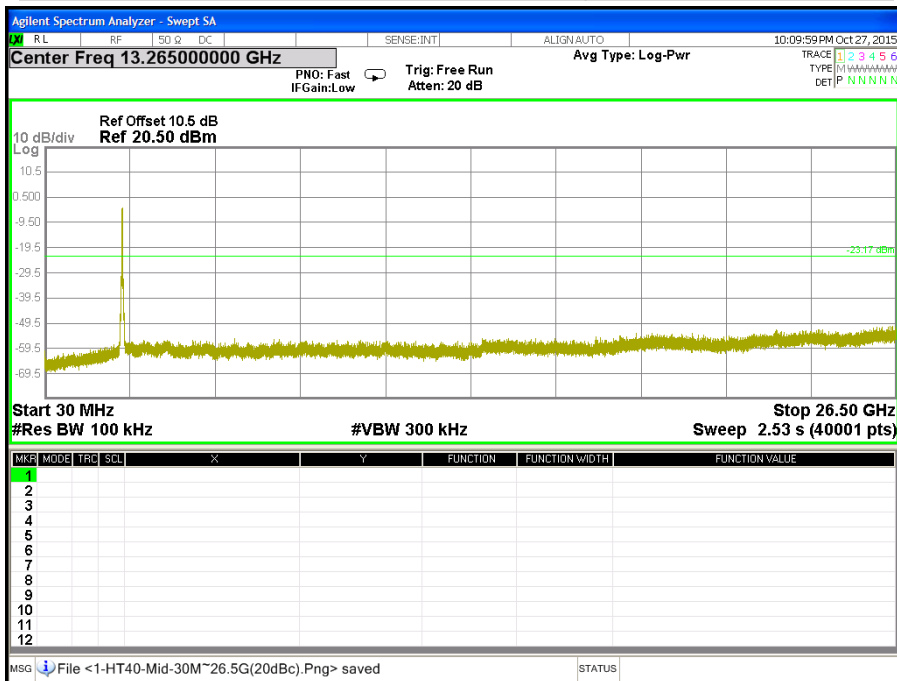

**CH High (2.38GHz ~ 2.5GHz / IEEE 802.11gn HT40 Mode / Chain 1)**

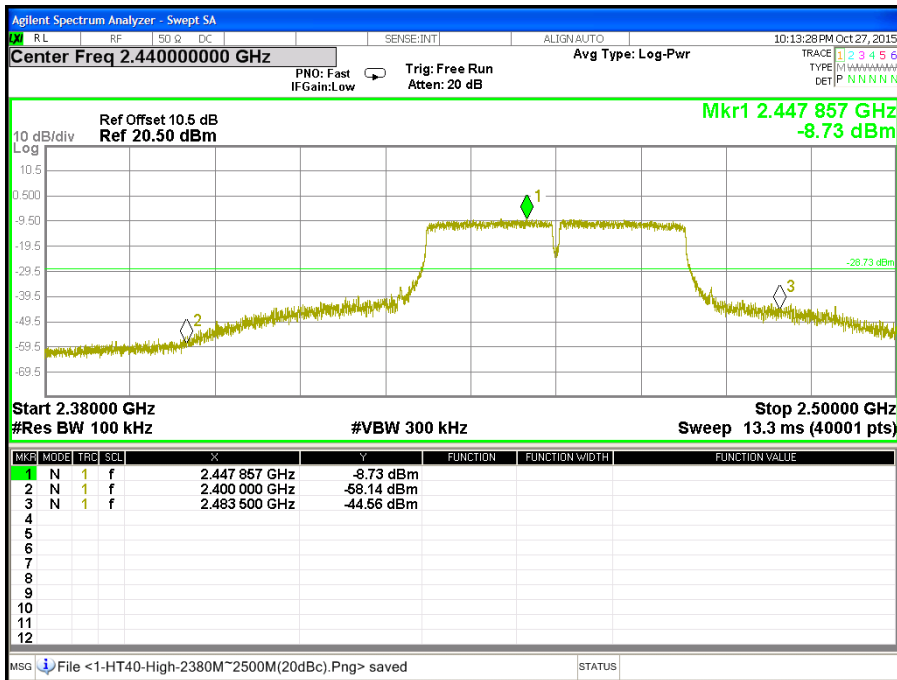

**CH High (30MHz ~ 26.5GHz / IEEE 802.11gn HT40 Mode / Chain 1)**

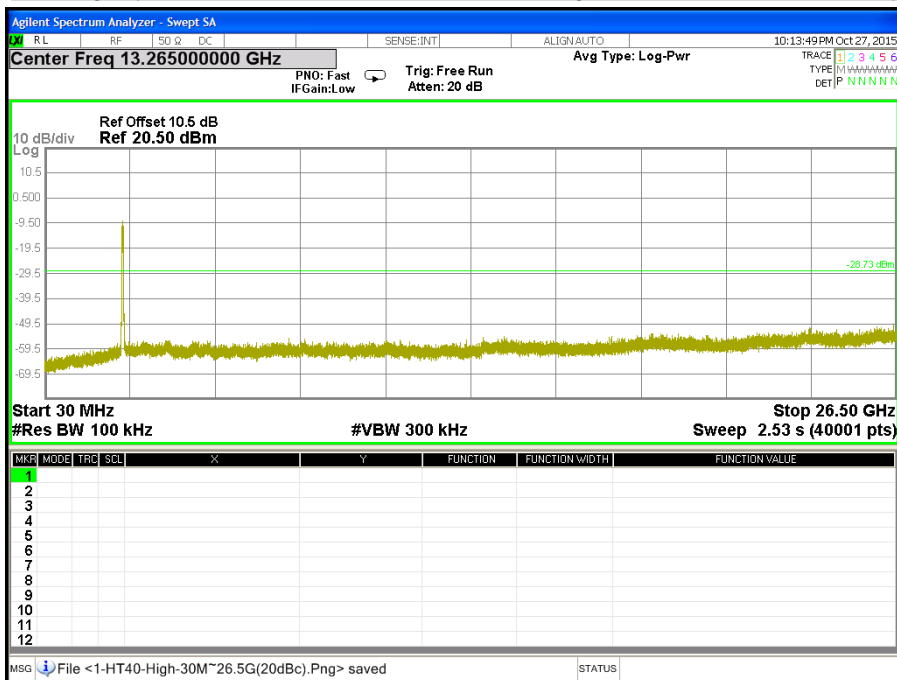

## 7.6 RADIATED EMISSION

### LIMITS

- (1) According to § 15.205 (a) Except as shown in paragraph (d) of this section, only spurious emissions are permitted in any of the frequency bands listed below:

MHz	MHz	MHz	GHz
0.090 - 0.110	16.42 - 16.423	399.9 - 410	4.5 - 5.15
<sup>1</sup> 0.495 - 0.505	16.69475 - 16.69525	608 - 614	5.35 - 5.46
2.1735 - 2.1905	16.80425 - 16.80475	960 - 1240	7.25 - 7.75
4.125 - 4.128	25.5 - 25.67	1300 - 1427	8.025 - 8.5
4.17725 - 4.17775	37.5 - 38.25	1435 - 1626.5	9.0 - 9.2
4.20725 - 4.20775	73 - 74.6	1645.5 - 1646.5	9.3 - 9.5
6.215 - 6.218	74.8 - 75.2	1660 - 1710	10.6 - 12.7
6.26775 - 6.26825	108 - 121.94	1718.8 - 1722.2	13.25 - 13.4
6.31175 - 6.31225	123 - 138	2200 - 2300	14.47 - 14.5
8.291 - 8.294	149.9 - 150.05	2310 - 2390	15.35 - 16.2
8.362 - 8.366	156.52475 - 156.52525	2483.5 - 2500	17.7 - 21.4
8.37625 - 8.38675	156.7 - 156.9	2655 - 2900	22.01 - 23.12
8.41425 - 8.41475	162.0125 - 167.17	3260 - 3267	23.6 - 24.0
12.29 - 12.293	167.72 - 173.2	3332 - 3339	31.2 - 31.8
12.51975 - 12.52025	240 - 285	3345.8 - 3338	36.43 - 36.5
12.57675 - 12.57725	322 - 335.4	3600 - 4400	( <sup>2</sup> )
13.36 - 13.41			

**Remark:**

1. <sup>1</sup> Until February 1, 1999, this restricted band shall be 0.490-0.510 MHz.
2. <sup>2</sup> Above 38.6

- (2) According to § 15.205 (b) Except as provided in paragraphs (d) and (e), the field strength of emissions appearing within these frequency bands shall not exceed the limits shown in Section 15.209. At frequencies equal to or less than 1000 MHz, compliance with the limits in Section 15.209 shall be demonstrated using measurement instrumentation employing a CISPR quasi-peak detector. Above 1000 MHz, compliance with the emission limits in Section 15.209 shall be demonstrated based on the average value of the measured emissions. The provisions in Section 15.35 apply to these measurements.



- (3) According to § 15.209 (a) Except as provided elsewhere in this Subpart, the emissions from an intentional radiator shall not exceed the field strength levels specified in the following table:

Frequency (MHz)	Field Strength (microvolts/meter)	Measurement Distance (meters)
0.009 – 0.490	2400/F(KHz)	300
0.490 – 1.705	24000/F(KHz)	30
1.705 – 30.0	30	30
30 - 88	100 **	3
88 - 216	150 **	3
216 - 960	200 **	3
Above 960	500	3

**Remark:** \*\*Except as provided in paragraph (g), fundamental emissions from intentional radiators operating under this Section shall not be located in the frequency bands 54-72 MHz, 76-88 MHz, 174-216 MHz or 470-806 MHz. However, operation within these frequency bands is permitted under other sections of this Part, e.g., Sections 15.231 and 15.241.

- (4) According to § 15.209 (b) In the emission table above, the tighter limit applies at the band edges.

**TEST EQUIPMENT**

**Radiated Emission / 966Chamber B**

Name of Equipment	Manufacture	Model	Serial Number	Calibration Due
Spectrum Analyzer	Agilent	E4446A	MY46180323	04/14/2016
EMI Test Receiver	Rohde & Schwarz	ESCI	100221	04/22/2016
Bi-log Antenna	TESEQ	CBL6112D	35403	08/04/2016
Broad-Band Horn Antenna	Schwarzbeck	BBHA 9120 D	9120D-778	08/09/2016
Double-Ridged Waveguide Horn	ETS-LINDGREN	3117	00078733	11/25/2016
Horn Antenna	COM-POWER	AH-840	03077	12/08/2016
Pre-Amplifier	Agilent	8447D	2944A10052	07/14/2016
Pre-Amplifier	Agilent	8449B	3008A01916	07/14/2016
LOOP Antenna	COM-POWER	AL-130	121060	05/24/2016

**Remark:** Each piece of equipment is scheduled for calibration once a year.

### TEST SETUP

The diagram below shows the test setup that is utilized to make the measurements for emission below 1GHz.

#### **9kHz ~ 30MHz**

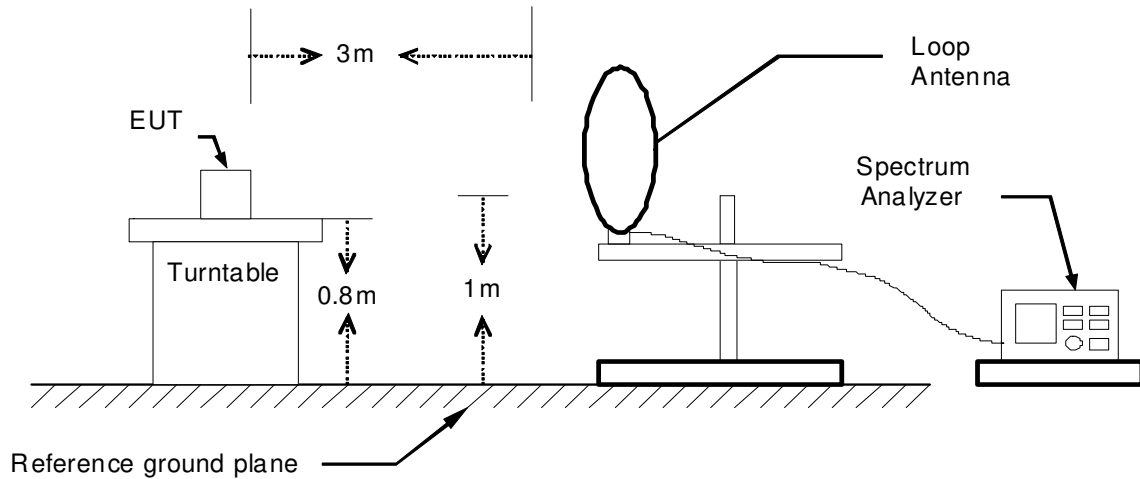

#### **30MHz ~ 1GHz**

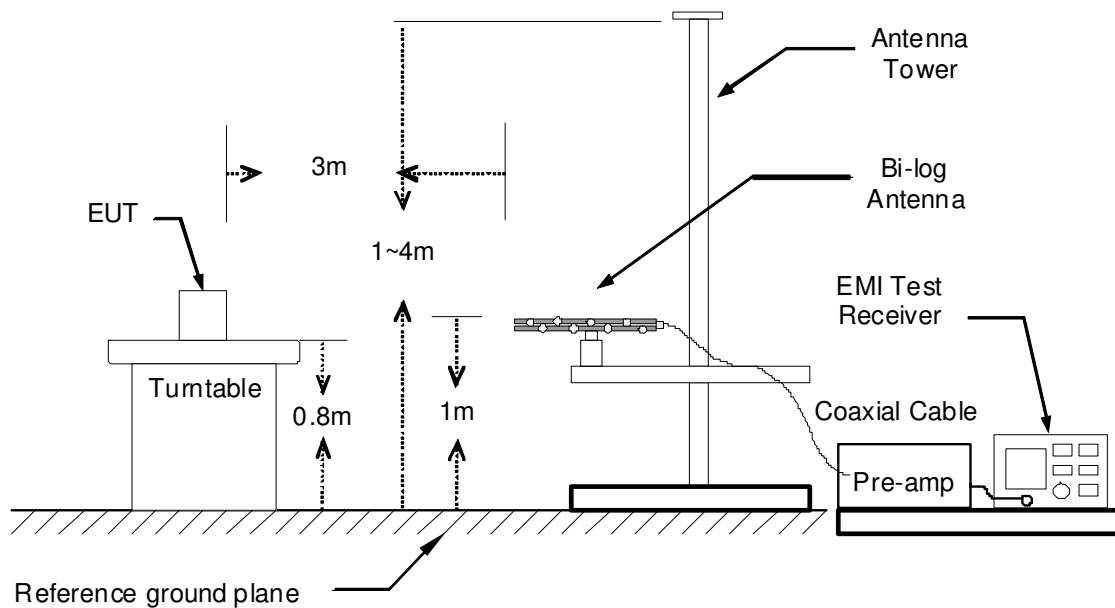

The diagram below shows the test setup that is utilized to make the measurements for emission above 1GHz.

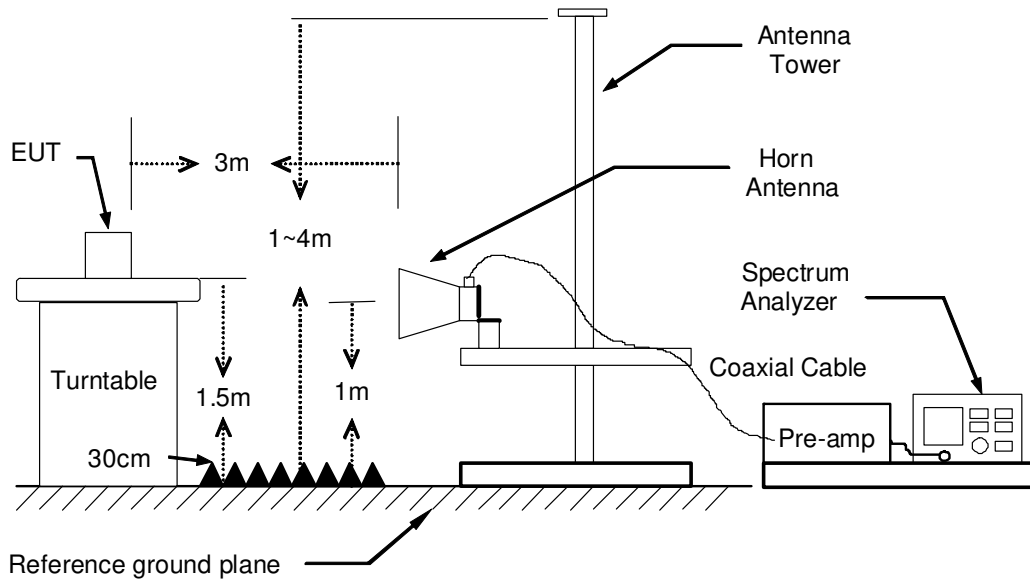

## **TEST PROCEDURE**

1. The EUT was placed on the top of a rotating table 0.8 and 1.5 meters above the ground. The table was rotated 360 degrees to determine the position of the highest radiation.
2. While measuring the radiated emission below 1GHz, the EUT was set 3 meters away from the interference-receiving antenna, which was mounted on the top of a variable-height antenna tower. While measuring the radiated emission above 1GHz, the EUT was set 3 meters away from the interference-receiving antenna.
3. The antenna is a broadband antenna, and its height is varied from one meter to four meters above the ground to determine the maximum value of the field strength. Both horizontal and vertical polarization of the antenna are set to make the measurement.
4. For each suspected emission, the EUT was arranged to its worst case and then the antenna was tuned to heights from 1 meter to 4 meters and the table was turned from 0 degrees to 360 degrees to find the maximum reading.
5. The test-receiver system was set to Peak Detect Function and Specified Bandwidth with Maximum Hold mode.
6. If the emission level of the EUT in peak mode was 10 dB lower than the limit specified, then testing could be stopped and the peak values of the EUT would be reported. Otherwise the emissions that did not have 10 dB margin would be re-tested one by one using peak, quasi-peak or average method as specified and then reported in a data sheet.

### **Remark :**

1. *The resolution bandwidth and video bandwidth of test receiver/spectrum analyzer is 120 KHz for Peak detection (PK) and Quasi-peak detection (QP) at frequency below 1GHz.*
2. *The resolution bandwidth and video bandwidth of test receiver/spectrum analyzer is 1 MHz for Peak detection and frequency above 1GHz.*
3. *The resolution bandwidth of test receiver/spectrum analyzer is 1 MHz and the video bandwidth is 10 Hz for Average detection (AV) at frequency above 1GHz.*

**TEST RESULTS**

**Below 1 GHz (9kHz ~ 30MHz)**

No emission found between lowest internal used/generated frequency to 30MHz.

**Below 1 GHz (30MHz ~ 1GHz)**

<b>Product Name</b>	300Mbps AV600 Wireless Powerline Adapter	<b>Test By</b>	Waternil Guan
<b>Test Model</b>	PL7622	<b>Test Date</b>	2015/10/23
<b>Test Mode</b>	Mode 1	<b>Temp. &amp; Humidity</b>	25°C, 58%

**966Chamber\_B at 3Meter / Horizontal**

Freq. MHz	Reading dBuV	C.F. dB/m	Result dBuV/m	Limit dBuV/m	Margin dB	Azimuth deg	Height cm	Remark
58.13	56.01	-20.65	35.36	40.00	-4.64	274	400	Peak
125.06	48.91	-14.35	34.56	43.50	-8.94	249	300	Peak
250.19	51.25	-12.67	38.58	46.00	-7.42	252	100	Peak
500.45	47.31	-8.13	39.18	46.00	-6.82	143	100	Peak
549.92	46.83	-7.29	39.54	46.00	-6.46	106	200	Peak
600.36	47.38	-6.78	40.60	46.00	-5.40	113	200	Peak
649.83	46.62	-6.11	40.51	46.00	-5.49	249	100	Peak
874.87	42.16	-3.20	38.96	46.00	-7.04	83	100	Peak

**966Chamber\_B at 3Meter / Vertical**

Freq. MHz	Reading dBuV	C.F. dB/m	Result dBuV/m	Limit dBuV/m	Margin dB	Azimuth deg	Height cm	Remark
57.16	60.27	-20.47	39.80	40.00	-0.20	8	200	QP
125.06	45.89	-14.35	31.54	43.50	-11.96	179	100	Peak
299.66	46.09	-11.53	34.56	46.00	-11.44	292	200	Peak
500.45	48.60	-8.13	40.47	46.00	-5.53	169	100	Peak
549.92	49.86	-7.29	42.57	46.00	-3.43	83	100	Peak
600.36	49.46	-6.78	42.68	46.00	-3.32	322	100	Peak
649.83	49.92	-6.11	43.81	46.00	-2.19	61	100	Peak
874.87	42.00	-3.20	38.80	46.00	-7.20	355	100	Peak

**Remark:**

1. Quasi-peak test would be performed if the peak result were greater than the quasi-peak limit.
2. Correction Factor (dB/m) = Antenna Factor (dB/m) + Cable Loss (dB) – PreAmp.Gain (dB)
3. Result (dBuV/m) = Reading (dBuV) + Correction Factor (dB/m)
4. Margin (dB) = Remark result (dBuV/m) - Quasi-peak limit (dBuV/m).

**Above 1 GHz**

<b>Product Name</b>	300Mbps AV600 Wireless Powerline Adapter	<b>Test By</b>	Waternil Guan
<b>Test Model</b>	PL7622	<b>Test Date</b>	2015/10/23
<b>Test Mode</b>	IEEE 802.11b TX / CH Low	<b>Temp. &amp; Humidity</b>	25°C, 58%

**966Chamber\_B at 3Meter / Horizontal**

Freq. MHz	Reading dBuV	C.F. dB/m	Result dBuV/m	Limit dBuV/m	Margin dB	Azimuth deg	Height cm	Remark
2052.00	47.81	1.85	49.66	74.00	-24.34	323	200	Peak
2280.00	48.02	2.51	50.53	74.00	-23.47	293	200	Peak
2830.00	48.41	3.80	52.21	74.00	-21.79	303	100	Peak
4050.00	39.66	6.54	46.20	74.00	-27.80	339	100	Peak
4830.00	38.75	8.42	47.17	74.00	-26.83	11	100	Peak
5175.00	38.76	9.14	47.90	74.00	-26.10	293	200	Peak

**966Chamber\_B at 3Meter / Vertical**

Freq. MHz	Reading dBuV	C.F. dB/m	Result dBuV/m	Limit dBuV/m	Margin dB	Azimuth deg	Height cm	Remark
1876.00	48.60	0.62	49.22	74.00	-24.78	48	100	Peak
2268.00	47.26	2.48	49.74	74.00	-24.26	41	100	Peak
2632.00	47.67	3.41	51.08	74.00	-22.92	261	200	Peak
4155.00	39.52	6.80	46.32	74.00	-27.68	238	100	Peak
4830.00	43.88	8.42	52.30	54.00	-1.70	12	200	Average
4830.00	46.78	8.42	55.20	74.00	-18.80	12	200	Peak
6255.00	36.86	11.31	48.17	74.00	-25.83	0	200	Peak

**Remark:**

- Measuring frequencies from 1 GHz to the 10th harmonic of highest fundamental frequency.
- Average test would be performed if the peak result were greater than the average limit.
- Measurements above show only up to 6 maximum emissions noted, or would be lesser, with " N/A " remark, if no specific emissions from the EUT are recorded (ie: margin>20dB from the applicable limit) and considered that's already beyond the background noise floor.
- Result = Reading + Correction Factor  
 Margin = Result – Limit  
 Remark Peak = Result(PK) – Limit(PK)  
 Remark AVG = Result(AV) – Limit(AV)

<b>Product Name</b>	300Mbps AV600 Wireless Powerline Adapter	<b>Test By</b>	Waternil Guan
<b>Test Model</b>	PL7622	<b>Test Date</b>	2015/10/23
<b>Test Mode</b>	IEEE 802.11b TX / CH Middle	<b>Temp. &amp; Humidity</b>	25°C, 58%

**966Chamber\_B at 3Meter / Horizontal**

Freq. MHz	Reading dBuV	C.F. dB/m	Result dBuV/m	Limit dBuV/m	Margin dB	Azimuth deg	Height cm	Remark
2050.00	47.25	1.85	49.10	74.00	-24.90	271	100	Peak
2250.00	47.86	2.43	50.29	74.00	-23.71	11	200	Peak
2976.00	48.27	4.09	52.36	74.00	-21.64	70	100	Peak
4875.00	38.67	8.53	47.20	74.00	-26.80	149	200	Peak
5685.00	37.82	10.16	47.98	74.00	-26.02	292	200	Peak
7230.00	37.43	12.31	49.74	74.00	-24.26	294	100	Peak

**966Chamber\_B at 3Meter / Vertical**

Freq. MHz	Reading dBuV	C.F. dB/m	Result dBuV/m	Limit dBuV/m	Margin dB	Azimuth deg	Height cm	Remark
1998.00	47.54	1.68	49.22	74.00	-24.78	0	100	Peak
2280.00	47.96	2.51	50.47	74.00	-23.53	315	200	Peak
2714.00	48.22	3.57	51.79	74.00	-22.21	7	200	Peak
3330.00	40.74	4.46	45.20	74.00	-28.80	319	100	Peak
4500.00	39.07	7.65	46.72	74.00	-27.28	108	200	Peak
4875.00	43.31	8.53	51.84	54.00	-2.16	6	200	Average
4875.00	45.32	8.53	53.85	74.00	-20.15	6	200	Peak

**Remark:**

1. Measuring frequencies from 1 GHz to the 10th harmonic of highest fundamental frequency.
2. Average test would be performed if the peak result were greater than the average limit.
3. Measurements above show only up to 6 maximum emissions noted, or would be lesser, with " N/A " remark, if no specific emissions from the EUT are recorded (ie: margin>20dB from the applicable limit) and considered that's already beyond the background noise floor.
4. Result = Reading + Correction Factor  
 Margin = Result - Limit  
 Remark Peak = Result(PK) - Limit(PK)  
 Remark AVG = Result(AV) - Limit(AV)

<b>Product Name</b>	300Mbps AV600 Wireless Powerline Adapter	<b>Test By</b>	Waternil Guan
<b>Test Model</b>	PL7622	<b>Test Date</b>	2015/10/23
<b>Test Mode</b>	IEEE 802.11b TX / CH High	<b>Temp. &amp; Humidity</b>	25°C, 58%

**966Chamber\_B at 3Meter / Horizontal**

Freq. MHz	Reading dBuV	C.F. dB/m	Result dBuV/m	Limit dBuV/m	Margin dB	Azimuth deg	Height cm	Remark
2270.00	46.87	2.48	49.35	74.00	-24.65	276	100	Peak
2396.00	48.10	2.85	50.95	74.00	-23.05	0	200	Peak
2618.00	47.99	3.38	51.37	74.00	-22.63	111	200	Peak
4650.00	39.28	8.00	47.28	74.00	-26.72	111	200	Peak
4920.00	38.85	8.63	47.48	74.00	-26.52	185	100	Peak
6450.00	37.55	11.65	49.20	74.00	-24.80	201	100	Peak

**966Chamber\_B at 3Meter / Vertical**

Freq. MHz	Reading dBuV	C.F. dB/m	Result dBuV/m	Limit dBuV/m	Margin dB	Azimuth deg	Height cm	Remark
2208.00	47.12	2.30	49.42	74.00	-24.58	90	100	Peak
2404.00	48.37	2.87	51.24	74.00	-22.76	156	100	Peak
2546.00	48.02	3.24	51.26	74.00	-22.74	70	100	Peak
3705.00	40.54	5.36	45.90	74.00	-28.10	293	100	Peak
4575.00	38.84	7.83	46.67	74.00	-27.33	56	200	Peak
4920.00	43.84	8.63	52.47	54.00	-1.53	2	200	Average
4920.00	47.77	8.63	56.40	74.00	-17.60	2	200	Peak

**Remark:**

1. Measuring frequencies from 1 GHz to the 10th harmonic of highest fundamental frequency.
2. Average test would be performed if the peak result were greater than the average limit.
3. Measurements above show only up to 6 maximum emissions noted, or would be lesser, with " N/A " remark, if no specific emissions from the EUT are recorded (ie: margin>20dB from the applicable limit) and considered that's already beyond the background noise floor.
4. Result = Reading + Correction Factor  
 Margin = Result – Limit  
 Remark Peak = Result(PK) – Limit(PK)  
 Remark AVG = Result(AV) – Limit(AV)



<b>Product Name</b>	300Mbps AV600 Wireless Powerline Adapter	<b>Test By</b>	Waternil Guan
<b>Test Model</b>	PL7622	<b>Test Date</b>	2015/10/23
<b>Test Mode</b>	IEEE 802.11g TX / CH Low	<b>Temp. &amp; Humidity</b>	25°C, 58%

**966Chamber\_B at 3Meter / Horizontal**

Freq. MHz	Reading dBuV	C.F. dB/m	Result dBuV/m	Limit dBuV/m	Margin dB	Azimuth deg	Height cm	Remark
1888.00	48.64	0.73	49.37	74.00	-24.63	210	100	Peak
2346.00	47.57	2.70	50.27	74.00	-23.73	215	100	Peak
2483.50	45.39	3.10	48.49	74.00	-25.51	145	100	Peak
3255.00	41.55	4.38	45.93	74.00	-28.07	266	200	Peak
4830.00	40.26	8.42	48.68	54.00	-5.32	199	200	Average
4830.00	51.65	8.42	60.07	74.00	-13.93	199	200	Peak
7230.00	37.89	12.31	50.20	74.00	-23.80	45	200	Peak

**966Chamber\_B at 3Meter / Vertical**

Freq. MHz	Reading dBuV	C.F. dB/m	Result dBuV/m	Limit dBuV/m	Margin dB	Azimuth deg	Height cm	Remark
2058.00	48.29	1.87	50.16	74.00	-23.84	94	100	Peak
2264.00	48.36	2.47	50.83	74.00	-23.17	47	200	Peak
2483.50	45.95	3.10	49.05	74.00	-24.95	39	100	Peak
4095.00	39.91	6.65	46.56	74.00	-27.44	15	100	Peak
4830.00	42.20	8.42	50.62	54.00	-3.38	1	200	Average
4830.00	55.00	8.42	63.42	74.00	-10.58	1	200	Peak
7200.00	38.37	12.30	50.67	74.00	-23.33	340	200	Peak

**Remark:**

1. Measuring frequencies from 1 GHz to the 10th harmonic of highest fundamental frequency.
2. Average test would be performed if the peak result were greater than the average limit.
3. Measurements above show only up to 6 maximum emissions noted, or would be lesser, with " N/A " remark, if no specific emissions from the EUT are recorded (ie: margin>20dB from the applicable limit) and considered that's already beyond the background noise floor.
4. Result = Reading + Correction Factor  
 Margin = Result – Limit  
 Remark Peak = Result(PK) – Limit(PK)  
 Remark AVG = Result(AV) – Limit(AV)

<b>Product Name</b>	300Mbps AV600 Wireless Powerline Adapter	<b>Test By</b>	Waternil Guan
<b>Test Model</b>	PL7622	<b>Test Date</b>	2015/10/23
<b>Test Mode</b>	IEEE 802.11g TX / CH Middle	<b>Temp. &amp; Humidity</b>	25°C, 58%

**966Chamber\_B at 3Meter / Horizontal**

Freq. MHz	Reading dBuV	C.F. dB/m	Result dBuV/m	Limit dBuV/m	Margin dB	Azimuth deg	Height cm	Remark
1984.00	47.68	1.56	49.24	74.00	-24.76	185	200	Peak
2390.00	46.72	2.83	49.55	74.00	-24.45	26	200	Peak
2483.50	47.03	3.10	50.13	74.00	-23.87	67	200	Peak
4875.00	34.26	8.53	42.79	54.00	-11.21	200	100	Average
4875.00	46.82	8.53	55.35	74.00	-18.65	200	100	Peak
6480.00	38.68	11.71	50.39	74.00	-23.61	147	200	Peak
7320.00	38.89	12.33	51.22	74.00	-22.78	30	200	Peak

**966Chamber\_B at 3Meter / Vertical**

Freq. MHz	Reading dBuV	C.F. dB/m	Result dBuV/m	Limit dBuV/m	Margin dB	Azimuth deg	Height cm	Remark
1988.00	47.82	1.60	49.42	74.00	-24.58	140	100	Peak
2390.00	39.42	2.83	42.25	54.00	-11.75	298	100	Average
2390.00	52.18	2.83	55.01	74.00	-18.99	298	100	Peak
2483.50	40.60	3.10	43.70	54.00	-10.30	217	100	Average
2483.50	51.94	3.10	55.04	74.00	-18.96	217	100	Peak
3825.00	40.67	5.79	46.46	74.00	-27.54	38	200	Peak
4875.00	43.65	8.53	52.18	54.00	-1.82	3	200	Average
4875.00	56.48	8.53	65.01	74.00	-8.99	3	200	Peak
6615.00	37.80	11.86	49.66	74.00	-24.34	77	100	Peak

**Remark:**

1. Measuring frequencies from 1 GHz to the 10th harmonic of highest fundamental frequency.
2. Average test would be performed if the peak result were greater than the average limit.
3. Measurements above show only up to 6 maximum emissions noted, or would be lesser, with " N/A " remark, if no specific emissions from the EUT are recorded (ie: margin>20dB from the applicable limit) and considered that's already beyond the background noise floor.
4. Result = Reading + Correction Factor  
 Margin = Result – Limit  
 Remark Peak = Result(PK) – Limit(PK)  
 Remark AVG = Result(AV) – Limit(AV)

<b>Product Name</b>	300Mbps AV600 Wireless Powerline Adapter	<b>Test By</b>	Waternil Guan
<b>Test Model</b>	PL7622	<b>Test Date</b>	2015/10/23
<b>Test Mode</b>	IEEE 802.11g TX / CH High	<b>Temp. &amp; Humidity</b>	25°C, 58%

**966Chamber\_B at 3Meter / Horizontal**

Freq. MHz	Reading dBuV	C.F. dB/m	Result dBuV/m	Limit dBuV/m	Margin dB	Azimuth deg	Height cm	Remark
1834.00	49.01	0.26	49.27	74.00	-24.73	275	200	Peak
2110.00	47.91	2.02	49.93	74.00	-24.07	190	100	Peak
2316.00	47.66	2.62	50.28	74.00	-23.72	139	100	Peak
4920.00	33.40	8.63	42.03	54.00	-11.97	157	200	Average
4920.00	46.00	8.63	54.63	74.00	-19.37	157	200	Peak
6405.00	38.31	11.57	49.88	74.00	-24.12	173	200	Peak
7380.00	37.68	12.35	50.03	74.00	-23.97	360	200	Peak

**966Chamber\_B at 3Meter / Vertical**

Freq. MHz	Reading dBuV	C.F. dB/m	Result dBuV/m	Limit dBuV/m	Margin dB	Azimuth deg	Height cm	Remark
2192.00	47.52	2.26	49.78	74.00	-24.22	341	200	Peak
2394.00	49.07	2.84	51.91	74.00	-22.09	232	200	Peak
2902.00	47.81	3.95	51.76	74.00	-22.24	217	200	Peak
4920.00	41.87	8.63	50.50	54.00	-3.50	8	200	Average
4920.00	55.11	8.63	63.74	74.00	-10.26	8	200	Peak
6345.00	37.56	11.47	49.03	74.00	-24.97	214	200	Peak
7215.00	38.04	12.31	50.35	74.00	-23.65	235	100	Peak

**Remark:**

1. Measuring frequencies from 1 GHz to the 10th harmonic of highest fundamental frequency.
2. Average test would be performed if the peak result were greater than the average limit.
3. Measurements above show only up to 6 maximum emissions noted, or would be lesser, with " N/A " remark, if no specific emissions from the EUT are recorded (ie: margin>20dB from the applicable limit) and considered that's already beyond the background noise floor.
4. Result = Reading + Correction Factor  
 Margin = Result – Limit  
 Remark Peak = Result(PK) – Limit(PK)  
 Remark AVG = Result(AV) – Limit(AV)

<b>Product Name</b>	300Mbps AV600 Wireless Powerline Adapter	<b>Test By</b>	Waternil Guan
<b>Test Model</b>	PL7622	<b>Test Date</b>	2015/10/23
<b>Test Mode</b>	IEEE 802.11gn HT20 TX / CH Low	<b>Temp. &amp; Humidity</b>	25°C, 58%

**966Chamber\_B at 3Meter / Horizontal**

Freq. MHz	Reading dBuV	C.F. dB/m	Result dBuV/m	Limit dBuV/m	Margin dB	Azimuth deg	Height cm	Remark
1900.00	47.65	0.83	48.48	74.00	-25.52	82	100	Peak
2162.00	48.53	2.17	50.70	74.00	-23.30	17	100	Peak
2646.00	48.11	3.44	51.55	74.00	-22.45	360	100	Peak
4035.00	39.82	6.51	46.33	74.00	-27.67	360	100	Peak
4815.00	43.20	8.39	51.59	74.00	-22.41	146	200	Peak
6675.00	37.18	11.92	49.10	74.00	-24.90	66	200	Peak

**966Chamber\_B at 3Meter / Vertical**

Freq. MHz	Reading dBuV	C.F. dB/m	Result dBuV/m	Limit dBuV/m	Margin dB	Azimuth deg	Height cm	Remark
1702.00	48.63	-0.89	47.74	74.00	-26.26	278	200	Peak
1866.00	48.28	0.54	48.82	74.00	-25.18	56	200	Peak
2496.00	47.72	3.14	50.86	74.00	-23.14	223	100	Peak
4830.00	40.65	8.42	49.07	54.00	-4.93	360	200	Average
4830.00	53.89	8.42	62.31	74.00	-11.69	360	200	Peak
6420.00	37.77	11.60	49.37	74.00	-24.63	360	200	Peak
7185.00	37.65	12.30	49.95	74.00	-24.05	227	200	Peak

**Remark:**

1. Measuring frequencies from 1 GHz to the 10th harmonic of highest fundamental frequency.
2. Average test would be performed if the peak result were greater than the average limit.
3. Measurements above show only up to 6 maximum emissions noted, or would be lesser, with " N/A " remark, if no specific emissions from the EUT are recorded (ie: margin>20dB from the applicable limit) and considered that's already beyond the background noise floor.
4. Result = Reading + Correction Factor  
 Margin = Result - Limit  
 Remark Peak = Result(PK) - Limit(PK)  
 Remark AVG = Result(AV) - Limit(AV)

<b>Product Name</b>	300Mbps AV600 Wireless Powerline Adapter	<b>Test By</b>	Waternil Guan
<b>Test Model</b>	PL7622	<b>Test Date</b>	2015/10/23
<b>Test Mode</b>	IEEE 802.11gn HT20 TX / CH Middle	<b>Temp. &amp; Humidity</b>	25°C, 58%

**966Chamber\_B at 3Meter / Horizontal**

Freq. MHz	Reading dBuV	C.F. dB/m	Result dBuV/m	Limit dBuV/m	Margin dB	Azimuth deg	Height cm	Remark
2272.00	48.77	2.49	51.26	74.00	-22.74	98	100	Peak
2390.00	48.63	2.83	51.46	74.00	-22.54	0	200	Peak
2483.50	46.37	3.10	49.47	74.00	-24.53	239	200	Peak
4875.00	37.00	8.53	45.53	54.00	-8.47	163	200	Average
4875.00	49.19	8.53	57.72	74.00	-16.28	163	200	Peak
6705.00	37.52	11.95	49.47	74.00	-24.53	266	100	Peak
7305.00	39.22	12.33	51.55	74.00	-22.45	43	200	Peak

**966Chamber\_B at 3Meter / Vertical**

Freq. MHz	Reading dBuV	C.F. dB/m	Result dBuV/m	Limit dBuV/m	Margin dB	Azimuth deg	Height cm	Remark
2088.00	48.06	1.96	50.02	74.00	-23.98	34	200	Peak
2390.00	47.45	2.83	50.28	74.00	-23.72	279	200	Peak
2483.50	48.85	3.10	51.95	74.00	-22.05	262	100	Peak
4860.00	44.00	8.49	52.49	54.00	-1.51	31	200	Average
4860.00	57.19	8.49	65.68	74.00	-8.32	31	200	Peak
6705.00	37.10	11.95	49.05	74.00	-24.95	0	100	Peak
8040.00	36.97	13.07	50.04	74.00	-23.96	76	100	Peak

**Remark:**

1. Measuring frequencies from 1 GHz to the 10th harmonic of highest fundamental frequency.
2. Average test would be performed if the peak result were greater than the average limit.
3. Measurements above show only up to 6 maximum emissions noted, or would be lesser, with " N/A " remark, if no specific emissions from the EUT are recorded (ie: margin>20dB from the applicable limit) and considered that's already beyond the background noise floor.
4. Result = Reading + Correction Factor  
 Margin = Result – Limit  
 Remark Peak = Result(PK) – Limit(PK)  
 Remark AVG = Result(AV) – Limit(AV)

<b>Product Name</b>	300Mbps AV600 Wireless Powerline Adapter	<b>Test By</b>	Waternil Guan
<b>Test Model</b>	PL7622	<b>Test Date</b>	2015/10/23
<b>Test Mode</b>	IEEE 802.11gn HT20 TX / CH High	<b>Temp. &amp; Humidity</b>	25°C, 58%

**966Chamber\_B at 3Meter / Horizontal**

Freq. MHz	Reading dBuV	C.F. dB/m	Result dBuV/m	Limit dBuV/m	Margin dB	Azimuth deg	Height cm	Remark
2046.00	48.09	1.83	49.92	74.00	-24.08	360	200	Peak
2356.00	48.26	2.73	50.99	74.00	-23.01	319	100	Peak
2390.00	45.46	2.83	48.29	74.00	-25.71	2	200	Peak
3255.00	41.35	4.38	45.73	74.00	-28.27	33	100	Peak
4920.00	38.00	8.63	46.63	54.00	-7.37	171	200	Average
4920.00	48.58	8.63	57.21	74.00	-16.79	171	200	Peak
6615.00	37.34	11.86	49.20	74.00	-24.80	329	100	Peak

**966Chamber\_B at 3Meter / Vertical**

Freq. MHz	Reading dBuV	C.F. dB/m	Result dBuV/m	Limit dBuV/m	Margin dB	Azimuth deg	Height cm	Remark
2390.00	45.90	2.83	48.73	74.00	-25.27	252	100	Peak
2548.00	48.94	3.25	52.19	74.00	-21.81	216	100	Peak
2864.00	47.98	3.87	51.85	74.00	-22.15	272	100	Peak
4005.00	39.71	6.43	46.14	74.00	-27.86	29	100	Peak
4920.00	44.02	8.63	52.65	54.00	-1.35	2	200	Average
4920.00	55.26	8.63	63.89	74.00	-10.11	2	200	Peak
6660.00	37.77	11.90	49.67	74.00	-24.33	169	200	Peak

**Remark:**

1. Measuring frequencies from 1 GHz to the 10th harmonic of highest fundamental frequency.
2. Average test would be performed if the peak result were greater than the average limit.
3. Measurements above show only up to 6 maximum emissions noted, or would be lesser, with " N/A " remark, if no specific emissions from the EUT are recorded (ie: margin>20dB from the applicable limit) and considered that's already beyond the background noise floor.
4. Result = Reading + Correction Factor  
 Margin = Result – Limit  
 Remark Peak = Result(PK) – Limit(PK)  
 Remark AVG = Result(AV) – Limit(AV)

<b>Product Name</b>	300Mbps AV600 Wireless Powerline Adapter	<b>Test By</b>	Waternil Guan
<b>Test Model</b>	PL7622	<b>Test Date</b>	2015/10/23
<b>Test Mode</b>	IEEE 802.11gn HT40 TX / CH Low	<b>Temp. &amp; Humidity</b>	25°C, 58%

**966Chamber\_B at 3Meter / Horizontal**

Freq. MHz	Reading dBuV	C.F. dB/m	Result dBuV/m	Limit dBuV/m	Margin dB	Azimuth deg	Height cm	Remark
1614.00	48.23	-1.65	46.58	74.00	-27.42	275	200	Peak
1844.00	48.39	0.35	48.74	74.00	-25.26	43	200	Peak
2488.00	47.94	3.12	51.06	74.00	-22.94	62	200	Peak
4845.00	41.39	8.46	49.85	74.00	-24.15	177	200	Peak
5580.00	37.59	9.92	47.51	74.00	-26.49	80	100	Peak
7200.00	37.60	12.30	49.90	74.00	-24.10	271	200	Peak

**966Chamber\_B at 3Meter / Vertical**

Freq. MHz	Reading dBuV	C.F. dB/m	Result dBuV/m	Limit dBuV/m	Margin dB	Azimuth deg	Height cm	Remark
1670.00	49.49	-1.16	48.33	74.00	-25.67	20	200	Peak
1838.00	49.05	0.29	49.34	74.00	-24.66	325	200	Peak
2490.00	49.95	3.12	53.07	74.00	-20.93	266	100	Peak
4845.00	38.16	8.46	46.62	54.00	-7.38	360	200	Average
4845.00	49.30	8.46	57.76	74.00	-16.24	360	200	Peak
5400.00	38.37	9.56	47.93	74.00	-26.07	241	100	Peak
6690.00	37.26	11.93	49.19	74.00	-24.81	55	200	Peak

**Remark:**

1. Measuring frequencies from 1 GHz to the 10th harmonic of highest fundamental frequency.
2. Average test would be performed if the peak result were greater than the average limit.
3. Measurements above show only up to 6 maximum emissions noted, or would be lesser, with " N/A " remark, if no specific emissions from the EUT are recorded (ie: margin>20dB from the applicable limit) and considered that's already beyond the background noise floor.
4. Result = Reading + Correction Factor  
 Margin = Result - Limit  
 Remark Peak = Result(PK) - Limit(PK)  
 Remark AVG = Result(AV) - Limit(AV)

<b>Product Name</b>	300Mbps AV600 Wireless Powerline Adapter	<b>Test By</b>	Waternil Guan
<b>Test Model</b>	PL7622	<b>Test Date</b>	2015/10/23
<b>Test Mode</b>	IEEE 802.11gn HT40 TX / CH Middle	<b>Temp. &amp; Humidity</b>	25°C, 58%

**966Chamber\_B at 3Meter / Horizontal**

Freq. MHz	Reading dBuV	C.F. dB/m	Result dBuV/m	Limit dBuV/m	Margin dB	Azimuth deg	Height cm	Remark
1264.00	50.33	-2.87	47.46	74.00	-26.54	301	100	Peak
2390.00	46.81	2.83	49.64	54.00	-4.36	198	200	Average
2390.00	58.51	2.83	61.34	74.00	-12.66	198	200	Peak
2484.00	47.69	3.10	50.79	54.00	-3.21	56	200	Average
2484.00	58.89	3.10	61.99	74.00	-12.01	56	200	Peak
4875.00	42.89	8.53	51.42	74.00	-22.58	179	200	Peak
5670.00	38.49	10.12	48.61	74.00	-25.39	288	100	Peak
7230.00	37.88	12.31	50.19	74.00	-23.81	0	100	Peak

**966Chamber\_B at 3Meter / Vertical**

Freq. MHz	Reading dBuV	C.F. dB/m	Result dBuV/m	Limit dBuV/m	Margin dB	Azimuth deg	Height cm	Remark
1448.00	49.58	-2.69	46.89	74.00	-27.11	94	200	Peak
2390.00	50.17	2.83	53.00	54.00	-1.00	49	100	Average
2390.00	68.37	2.83	71.20	74.00	-2.80	49	100	Peak
2483.50	50.07	3.10	53.17	54.00	-0.83	315	100	Average
2483.50	62.61	3.10	65.71	74.00	-8.29	315	100	Peak
4875.00	40.30	8.53	48.83	54.00	-5.17	12	200	Average
4875.00	53.06	8.53	61.59	74.00	-12.41	12	200	Peak
5640.00	37.90	10.06	47.96	74.00	-26.04	142	100	Peak
7905.00	37.74	12.93	50.67	74.00	-23.33	164	100	Peak

**Remark:**

1. Measuring frequencies from 1 GHz to the 10th harmonic of highest fundamental frequency.
2. Average test would be performed if the peak result were greater than the average limit.
3. Measurements above show only up to 6 maximum emissions noted, or would be lesser, with " N/A " remark, if no specific emissions from the EUT are recorded (ie: margin>20dB from the applicable limit) and considered that's already beyond the background noise floor.
4. Result = Reading + Correction Factor  
 Margin = Result - Limit  
 Remark Peak = Result(PK) - Limit(PK)  
 Remark AVG = Result(AV) - Limit(AV)



<b>Product Name</b>	300Mbps AV600 Wireless Powerline Adapter	<b>Test By</b>	Waternil Guan
<b>Test Model</b>	PL7622	<b>Test Date</b>	2015/10/23
<b>Test Mode</b>	IEEE 802.11gn HT40 TX / CH High	<b>Temp. &amp; Humidity</b>	25°C, 58%

**966Chamber\_B at 3Meter / Horizontal**

Freq. MHz	Reading dBuV	C.F. dB/m	Result dBuV/m	Limit dBuV/m	Margin dB	Azimuth deg	Height cm	Remark
1500.00	49.18	-2.64	46.54	74.00	-27.46	197	100	Peak
1784.00	49.12	-0.17	48.95	74.00	-25.05	273	100	Peak
2390.00	49.13	2.83	51.96	74.00	-22.04	7	200	Peak
4905.00	41.07	8.60	49.67	74.00	-24.33	162	200	Peak
6540.00	37.26	11.78	49.04	74.00	-24.96	281	100	Peak
7200.00	37.62	12.30	49.92	74.00	-24.08	205	200	Peak

**966Chamber\_B at 3Meter / Vertical**

Freq. MHz	Reading dBuV	C.F. dB/m	Result dBuV/m	Limit dBuV/m	Margin dB	Azimuth deg	Height cm	Remark
1352.00	49.71	-2.79	46.92	74.00	-27.08	278	100	Peak
1912.00	48.17	0.94	49.11	74.00	-24.89	285	100	Peak
2390.00	44.24	2.83	47.07	54.00	-6.93	179	100	Average
2390.00	56.28	2.83	59.11	74.00	-14.89	179	100	Peak
4905.00	37.00	8.60	45.60	54.00	-8.40	359	200	Average
4905.00	49.07	8.60	57.67	74.00	-16.33	359	200	Peak
5460.00	38.54	9.67	48.21	74.00	-25.79	60	100	Peak
7935.00	37.30	12.97	50.27	74.00	-23.73	22	200	Peak

**Remark:**

1. Measuring frequencies from 1 GHz to the 10th harmonic of highest fundamental frequency.
2. Average test would be performed if the peak result were greater than the average limit.
3. Measurements above show only up to 6 maximum emissions noted, or would be lesser, with " N/A " remark, if no specific emissions from the EUT are recorded (ie: margin>20dB from the applicable limit) and considered that's already beyond the background noise floor.
4. Result = Reading + Correction Factor  
 Margin = Result – Limit  
 Remark Peak = Result(PK) – Limit(PK)  
 Remark AVG = Result(AV) – Limit(AV)

**Restricted Band Edges**

**Detector Mode: Peak**

**Polarity: Horizontal**

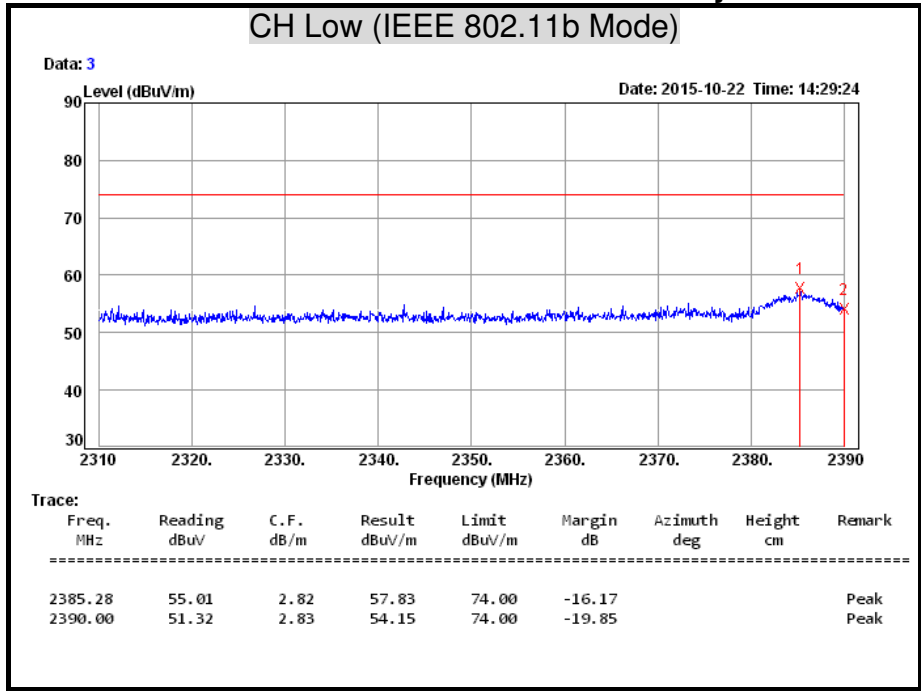

**Detector Mode: Average**

**Polarity: Horizontal**

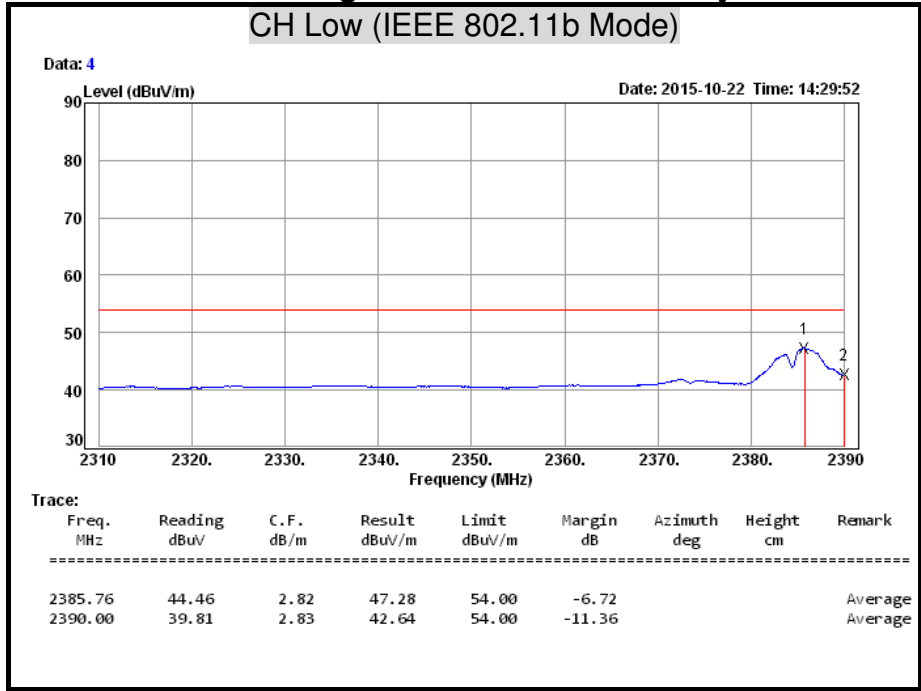

**Detector Mode: Peak Polarity: Vertical**

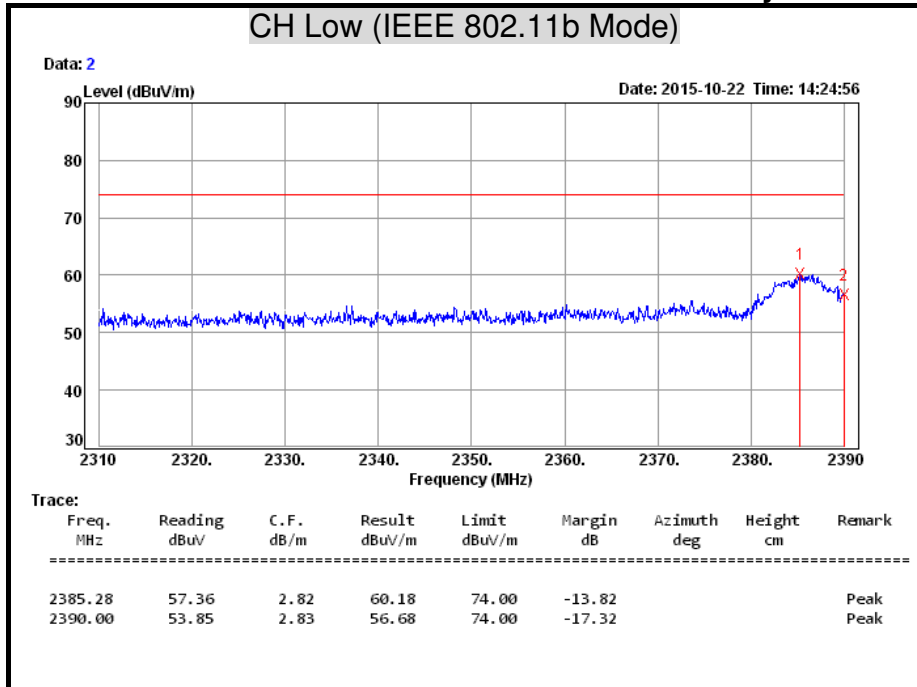

**Detector Mode: Average Polarity: Vertical**

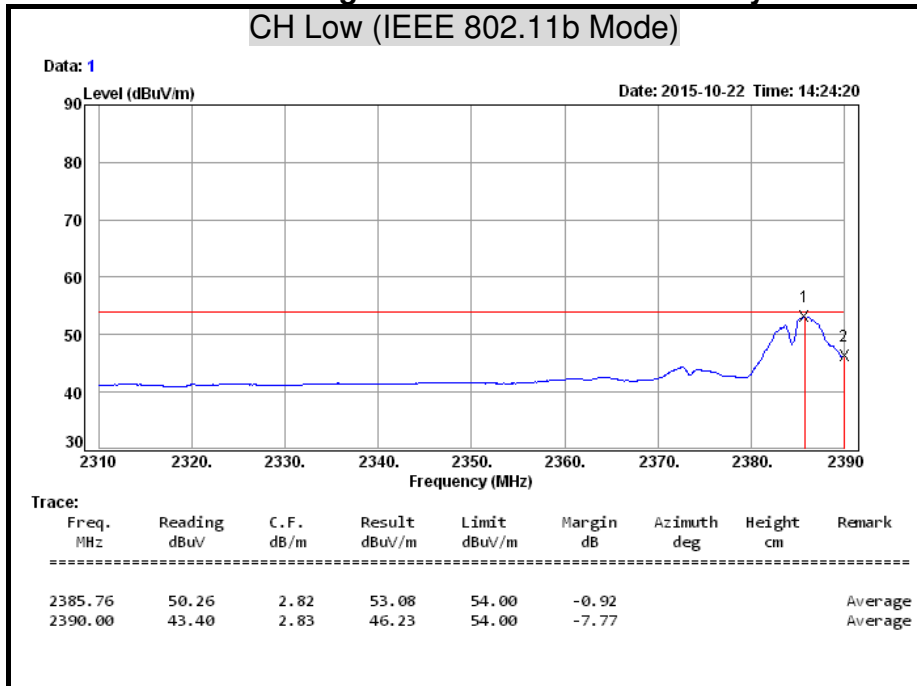

**Detector Mode: Peak Polarity: Horizontal**

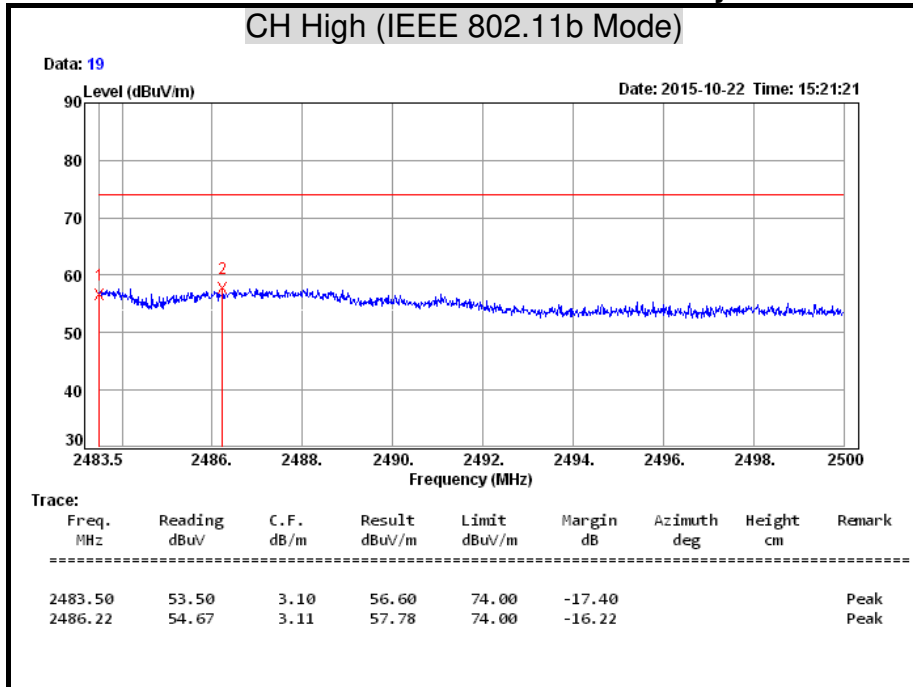

**Detector Mode: Average Polarity: Horizontal**

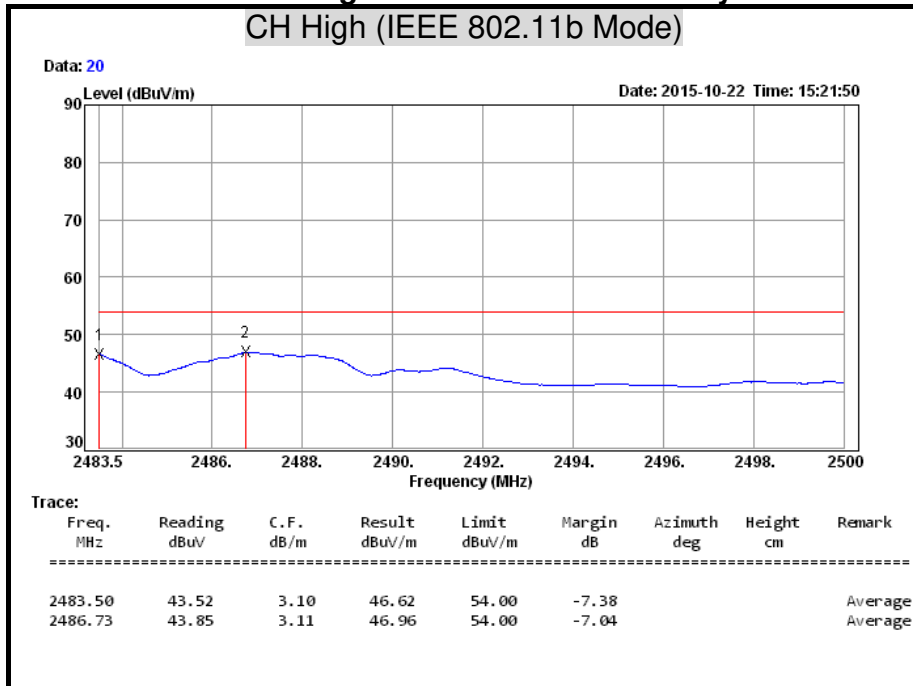

**Detector Mode: Peak Polarity: Vertical**

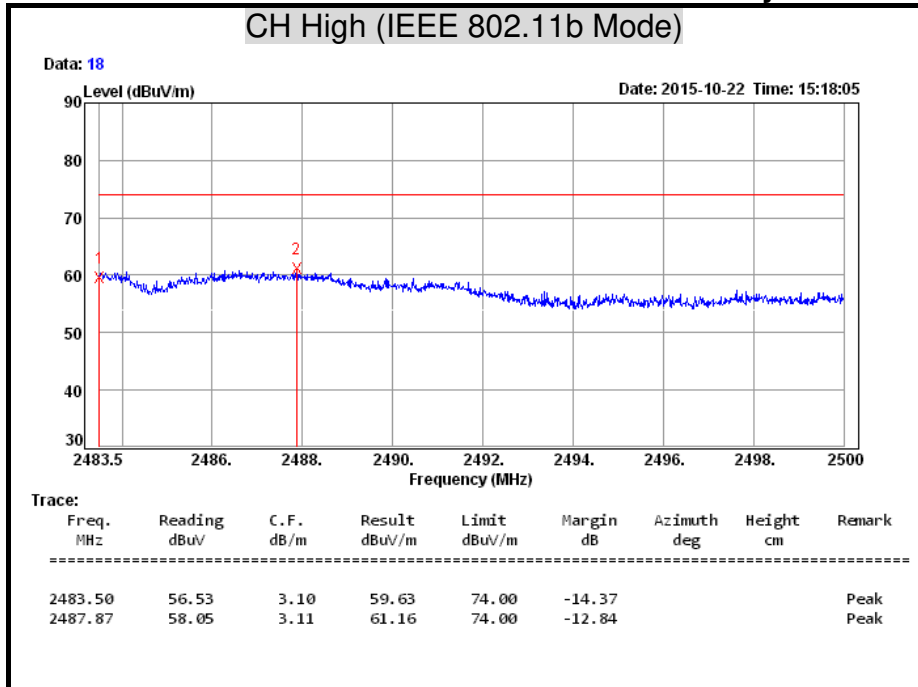

**Detector Mode: Average Polarity: Vertical**

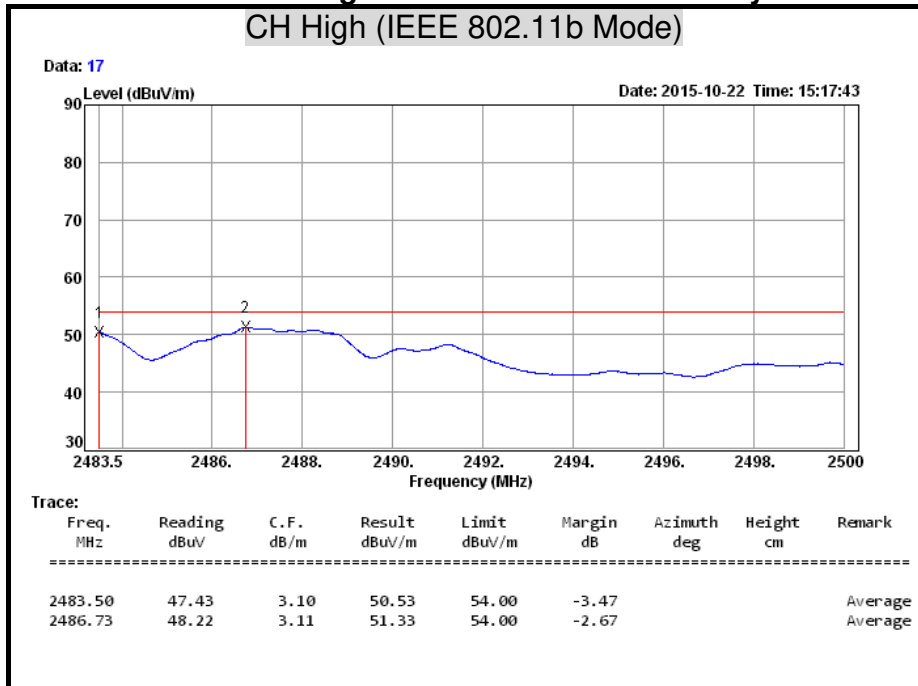

**Detector Mode: Peak Polarity: Horizontal**

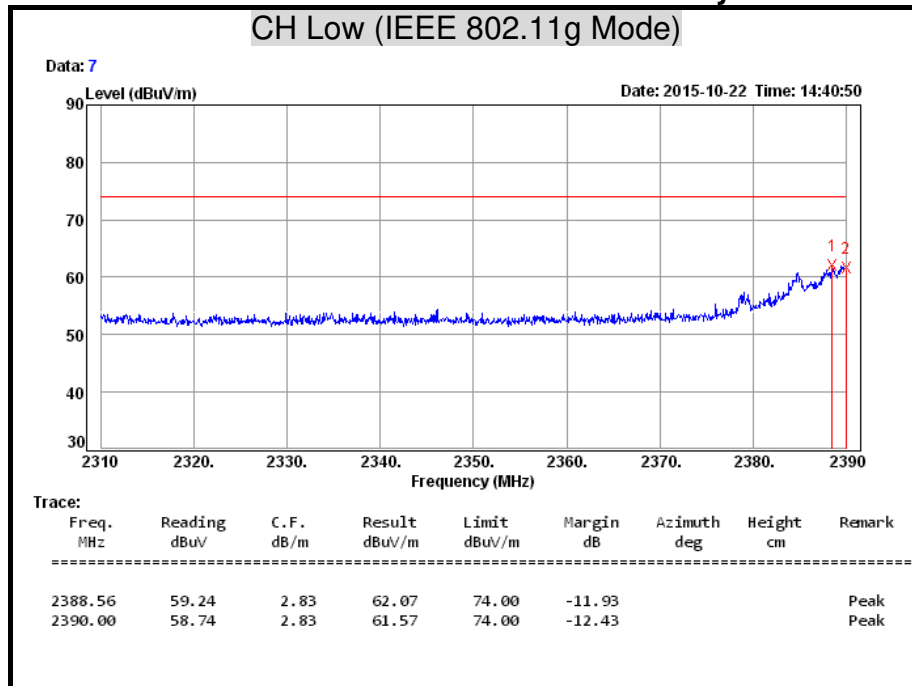

**Detector Mode: Average Polarity: Horizontal**

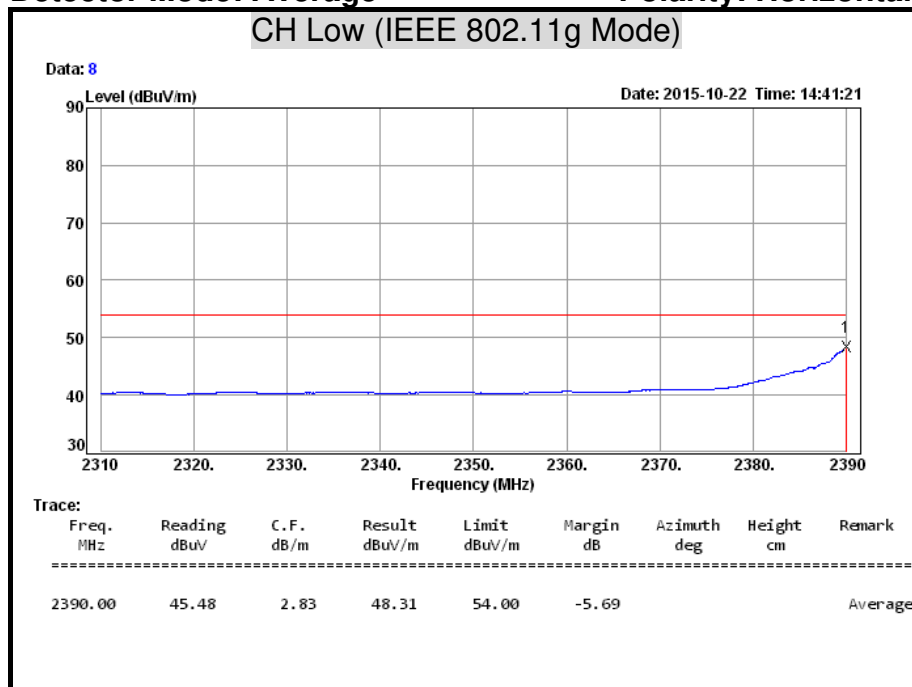

**Detector Mode: Peak Polarity: Vertical**

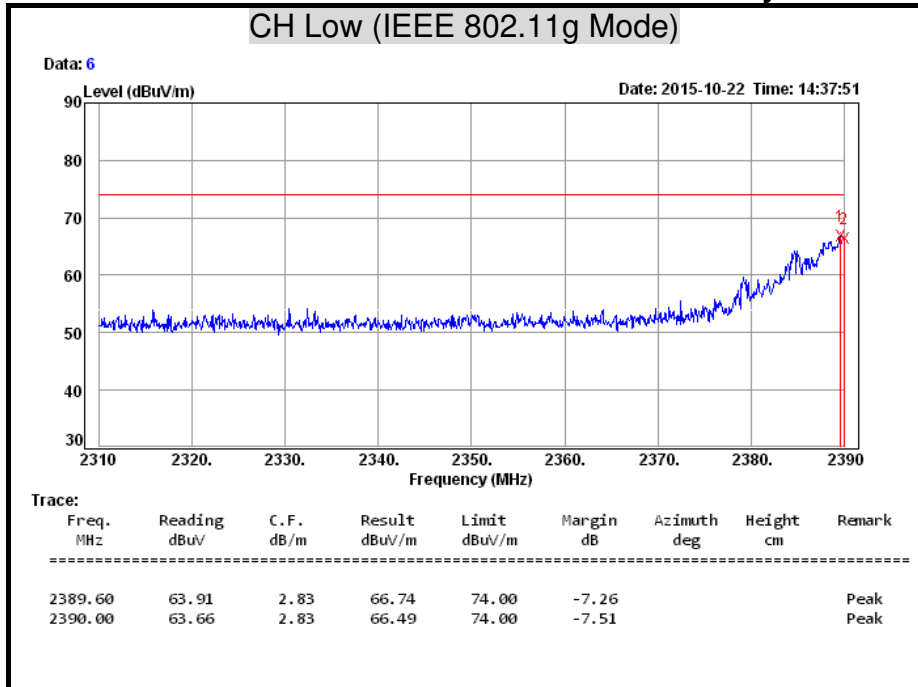

**Detector Mode: Average Polarity: Vertical**

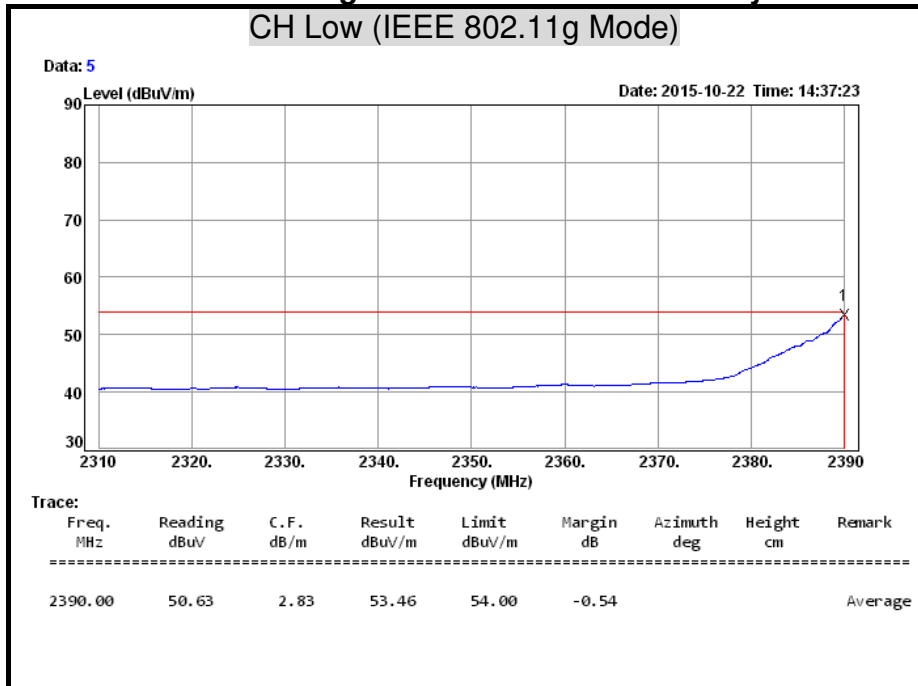

**Detector Mode: Peak Polarity: Horizontal**

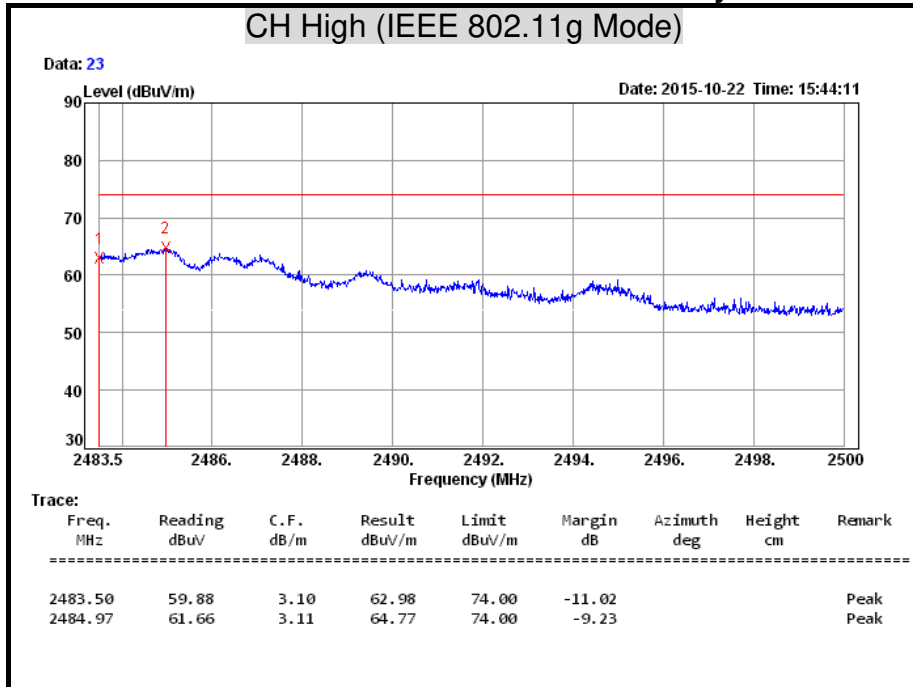

**Detector Mode: Average Polarity: Horizontal**

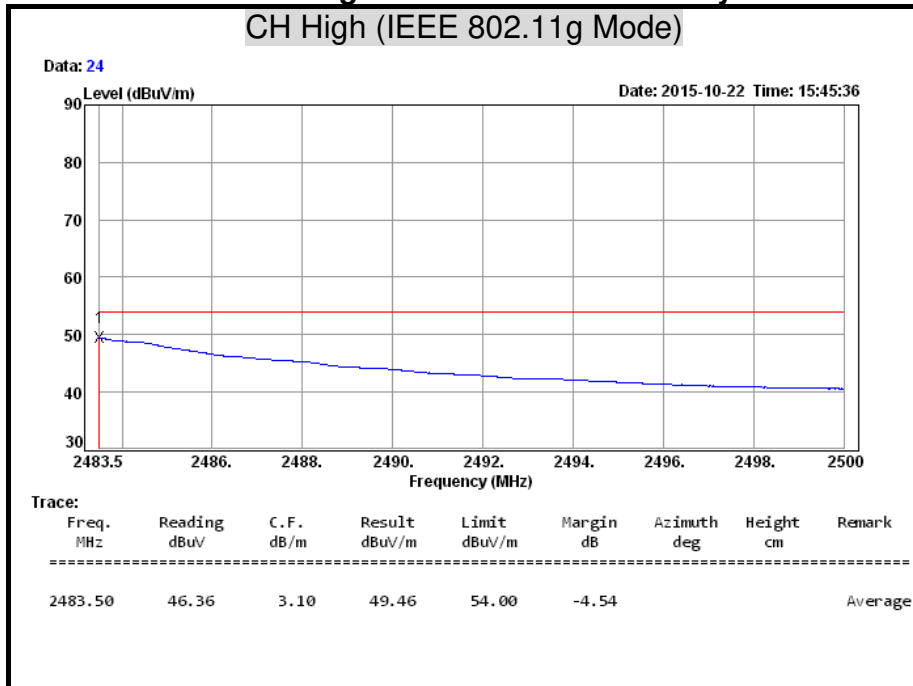



**Detector Mode: Peak Polarity: Vertical**

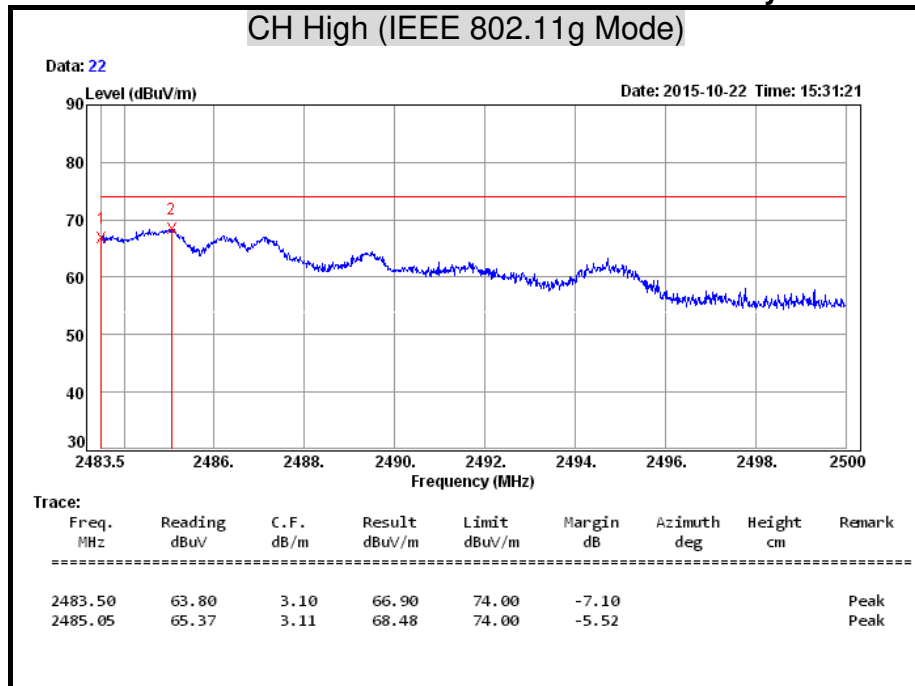

**Detector Mode: Average Polarity: Vertical**

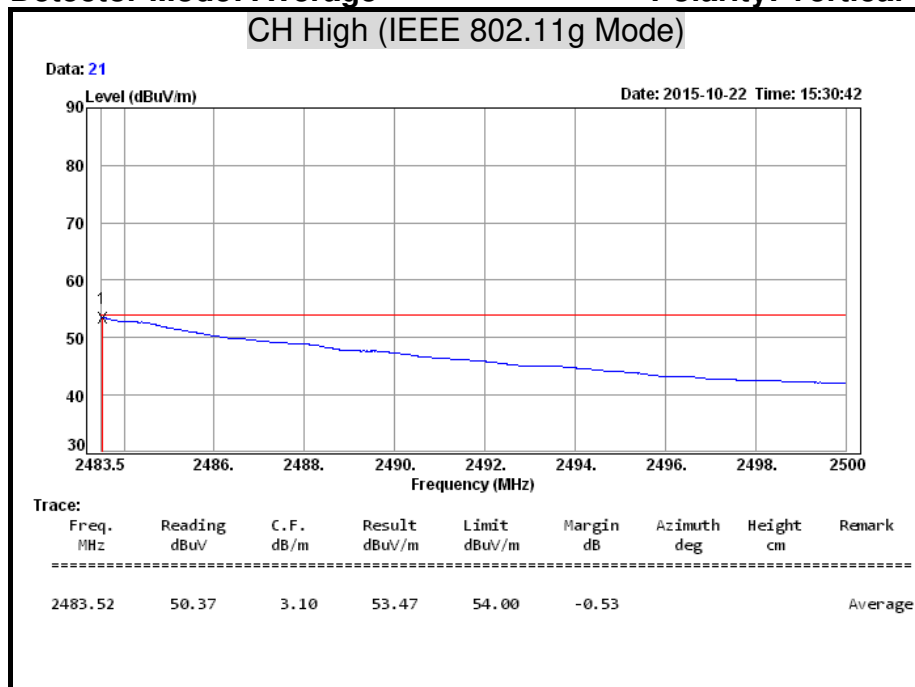

**Detector Mode: Peak Polarity: Horizontal**

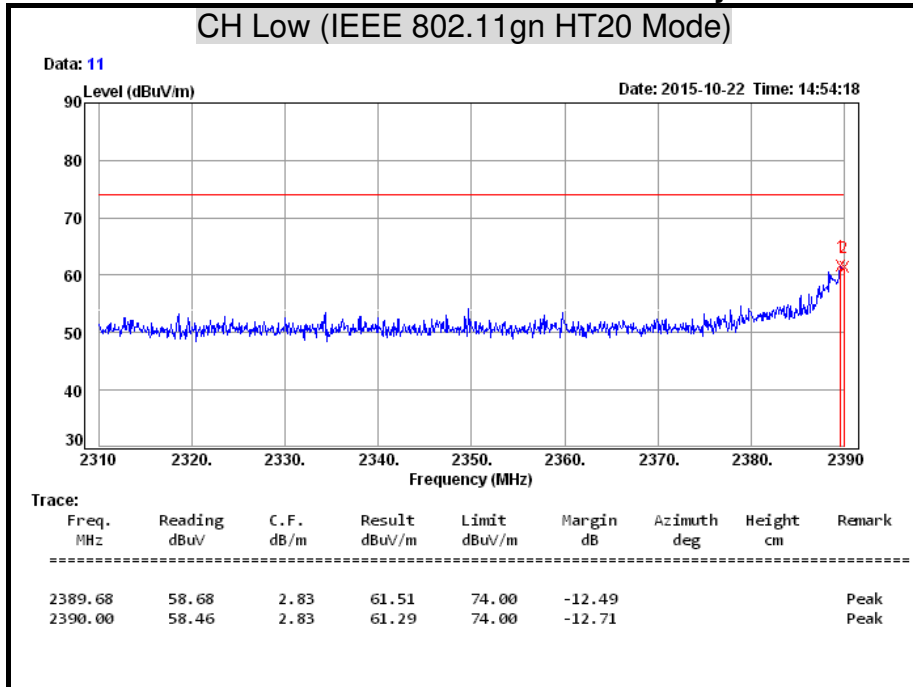

**Detector Mode: Average Polarity: Horizontal**

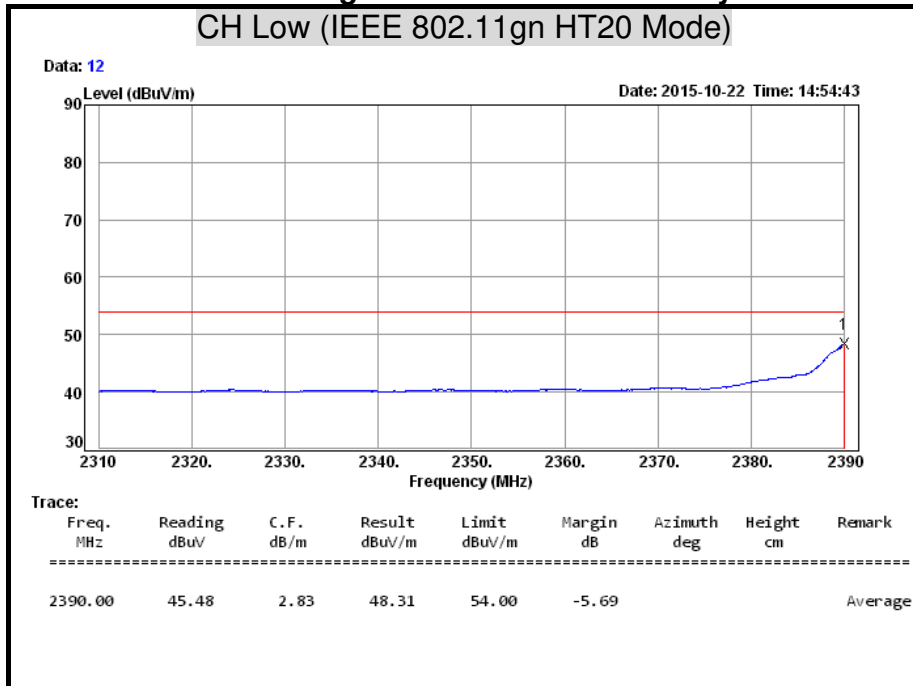

**Detector Mode: Peak Polarity: Vertical**

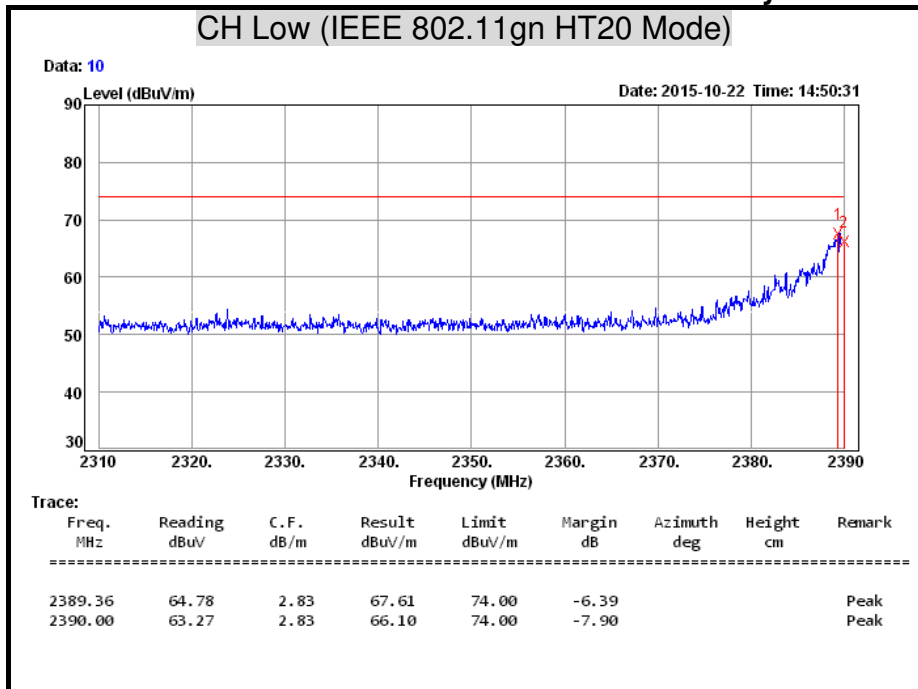

**Detector Mode: Average Polarity: Vertical**

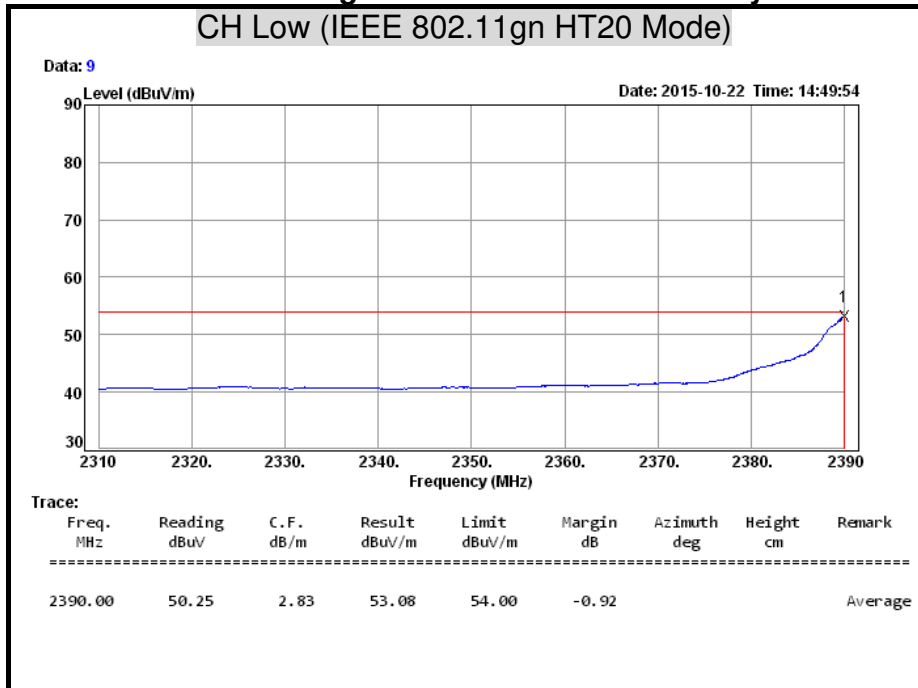

**Detector Mode: Peak Polarity: Horizontal**

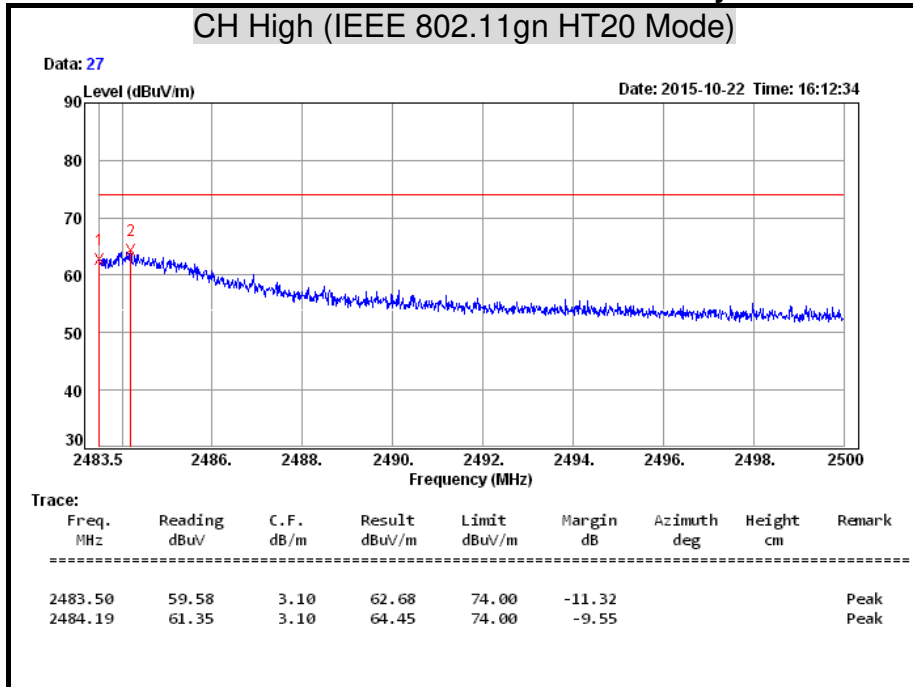

**Detector Mode: Average Polarity: Horizontal**

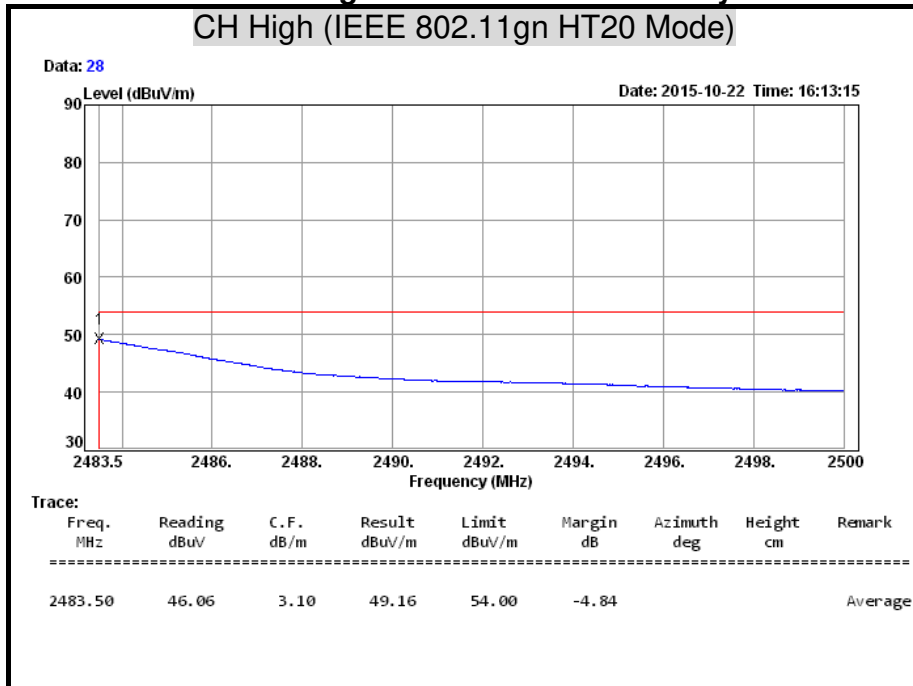

**Detector Mode: Peak** **Polarity: Vertical**

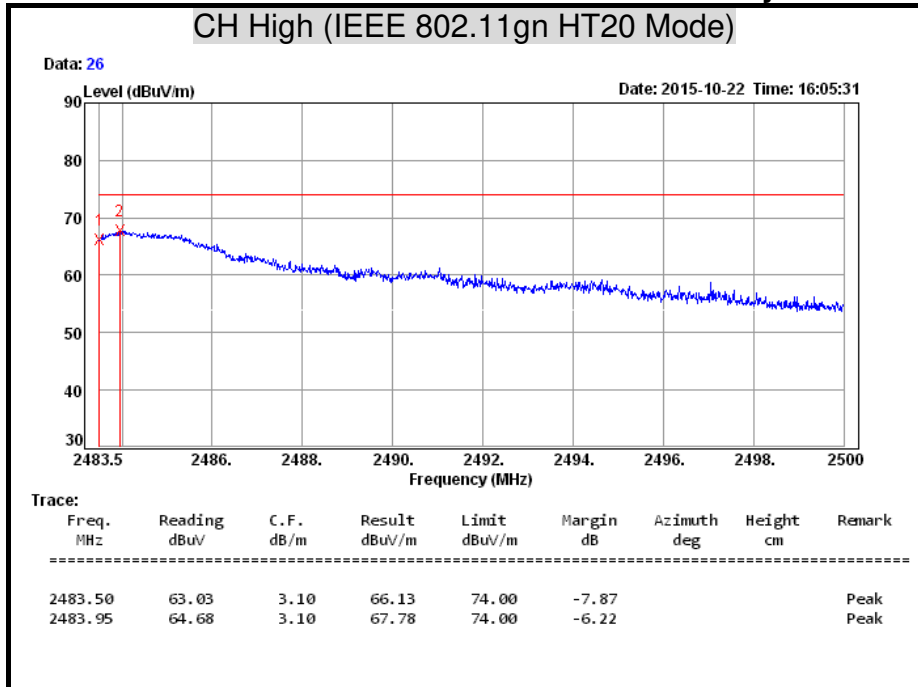

**Detector Mode: Average** **Polarity: Vertical**

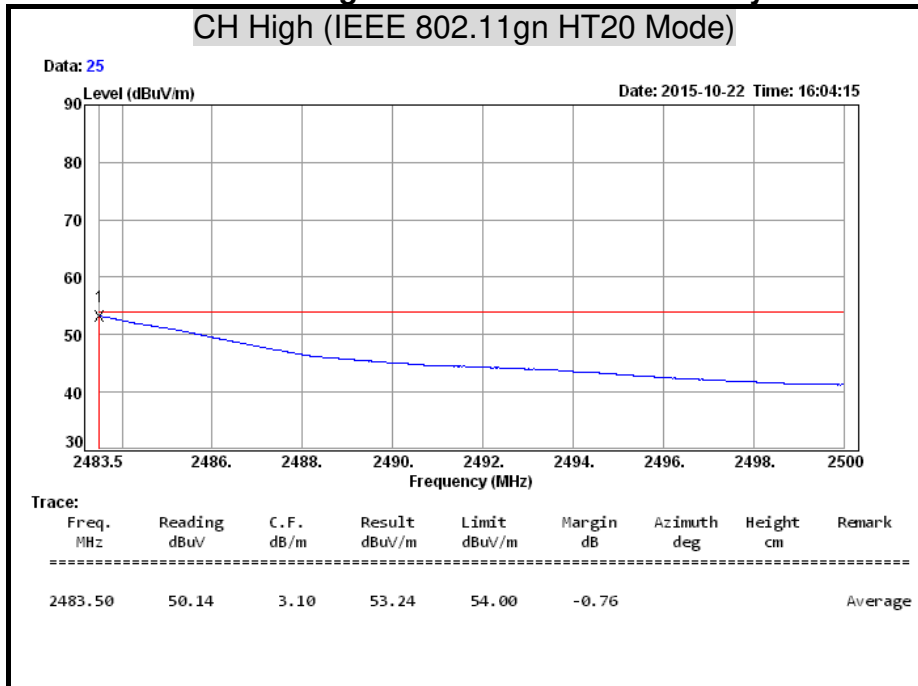

**Detector Mode: Peak Polarity: Horizontal**

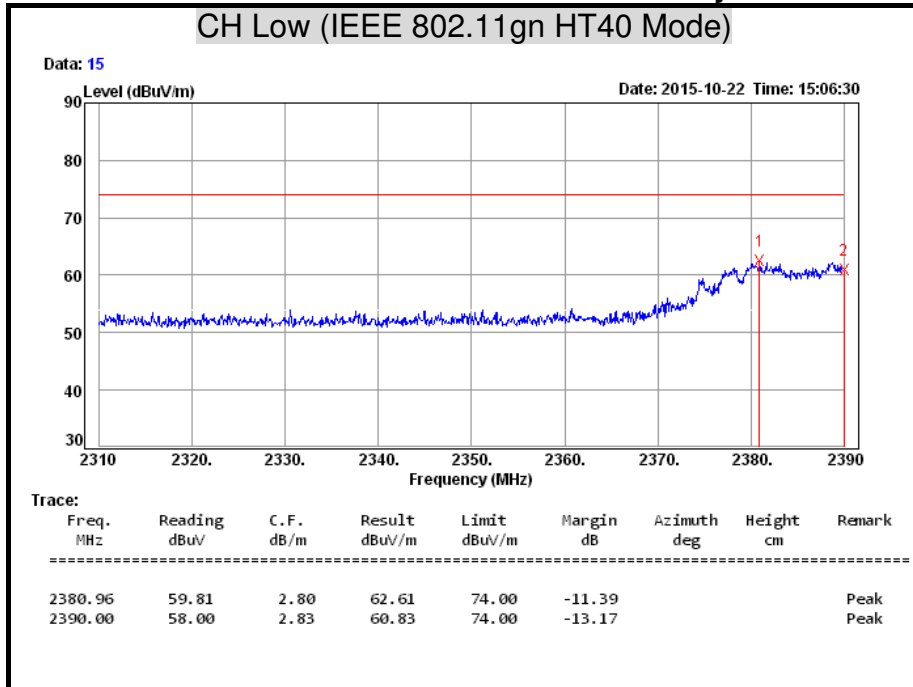

**Detector Mode: Average Polarity: Horizontal**

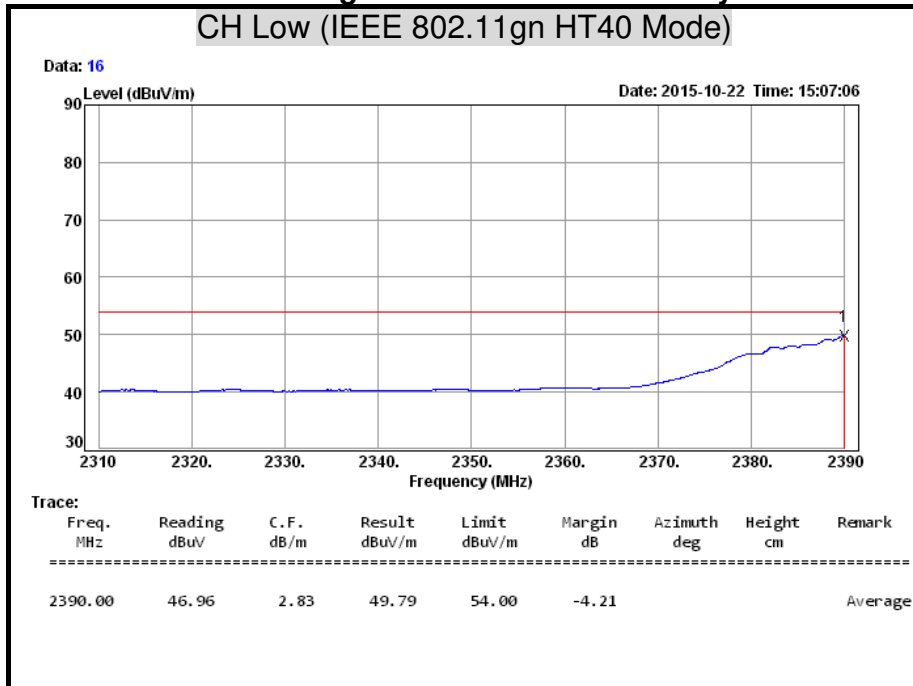

**Detector Mode: Peak Polarity: Vertical**

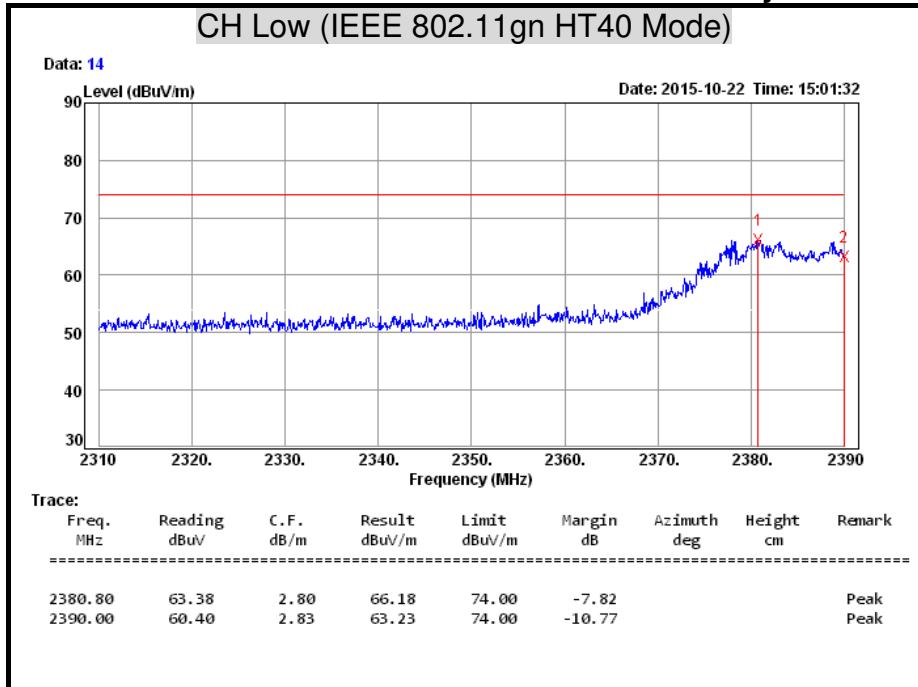

**Detector Mode: Average Polarity: Vertical**

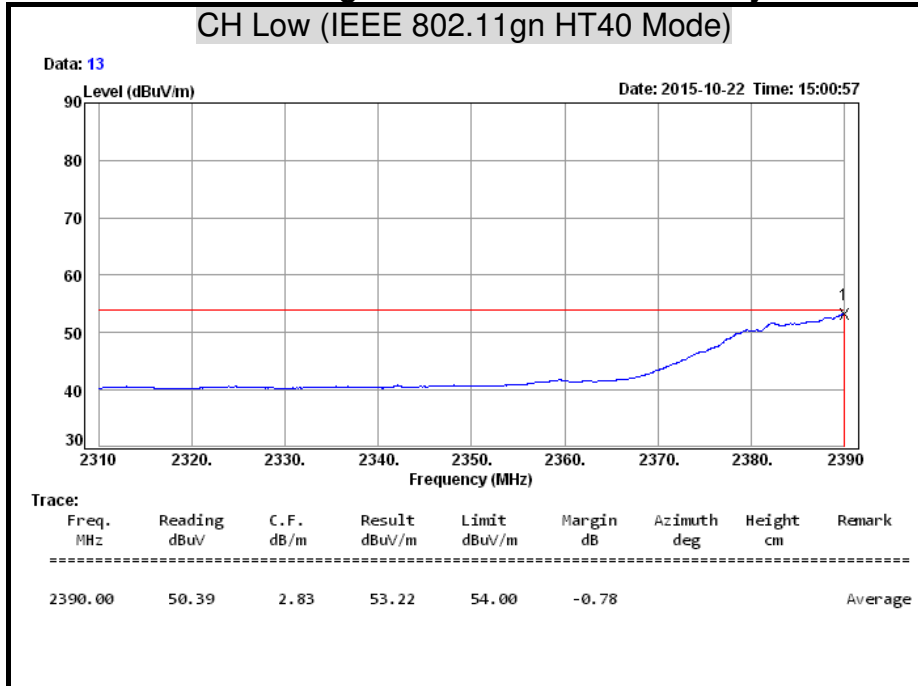

**Detector Mode: Peak Polarity: Horizontal**

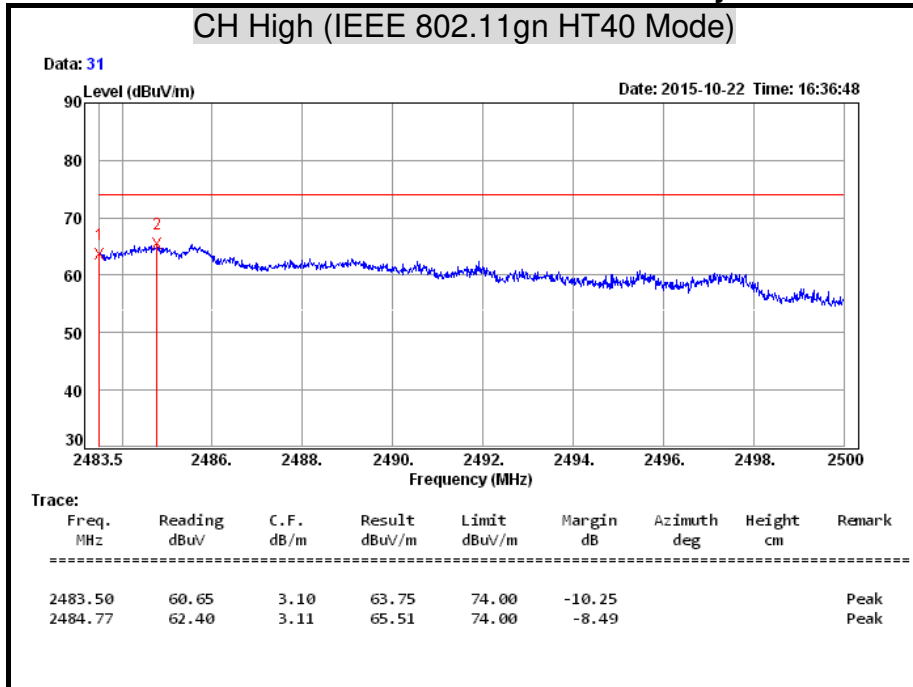

**Detector Mode: Average Polarity: Horizontal**

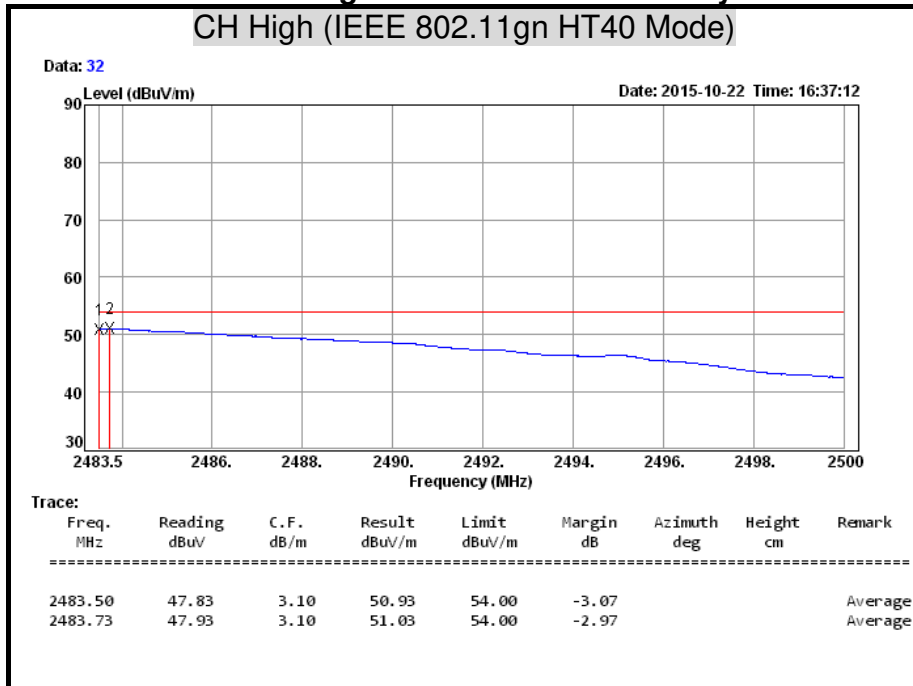



**Detector Mode: Peak** **Polarity: Vertical**

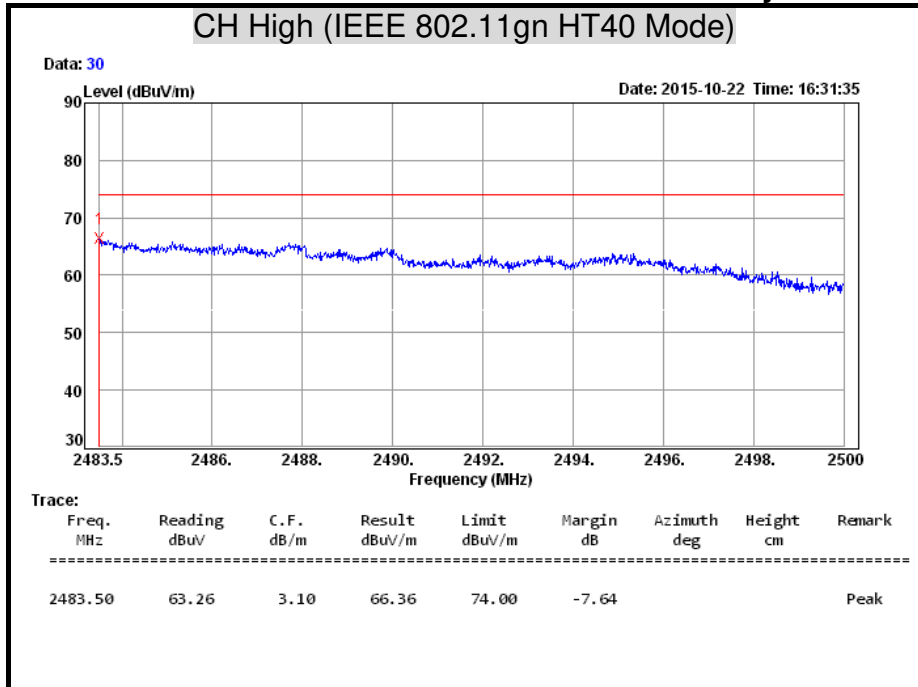

**Detector Mode: Average** **Polarity: Vertical**

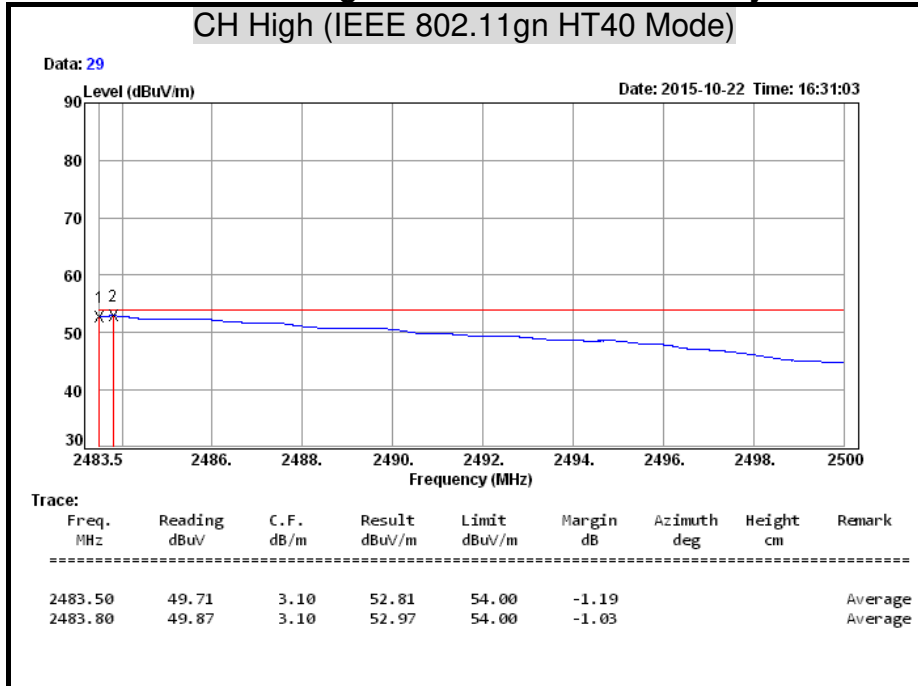

## 7.7 CONDUCTED EMISSION

### LIMITS

§ 15.207 (a) Except as shown in paragraph (b) and (c) this section, for an intentional radiator that is designed to be connected to the public utility (AC) power line, the radio frequency voltage that is conducted back onto the AC power line on any frequency or frequencies within the band 150 kHz to 30 MHz shall not exceed the limits in the following table, as measured using a 50 µH/50 ohms line impedance stabilization network (LISN). Compliance with the provisions of this paragraph shall be based on the measurement of the radio frequency voltage between each power line and ground at the power terminal. The lower limit applies at the boundary between the frequency ranges.

Frequency Range (MHz)	Conducted Limit (dBµv)	
	Quasi-peak	Average
0.15 - 0.50	66 to 56	56 to 46
0.50 - 5.00	56	46
5.00 - 30.0	60	50

### TEST EQUIPMENT

Name of Equipment	Manufacturer	Model	Serial Number	Calibration Due
L.I.S.N	Schwarzbeck	NSLK 8127	8127465	08/05/2016
L.I.S.N	Schwarzbeck	NSLK 8127	8127473	03/09/2016
EMI Test Receiver	Rohde & Schwarz	ESHS 30	838550/003	10/31/2016
Pulse Limiter	Rohde & Schwarz	ESH3-Z2	100111	06/28/2016

**Remark:** Each piece of equipment is scheduled for calibration once a year.

**TEST SETUP**

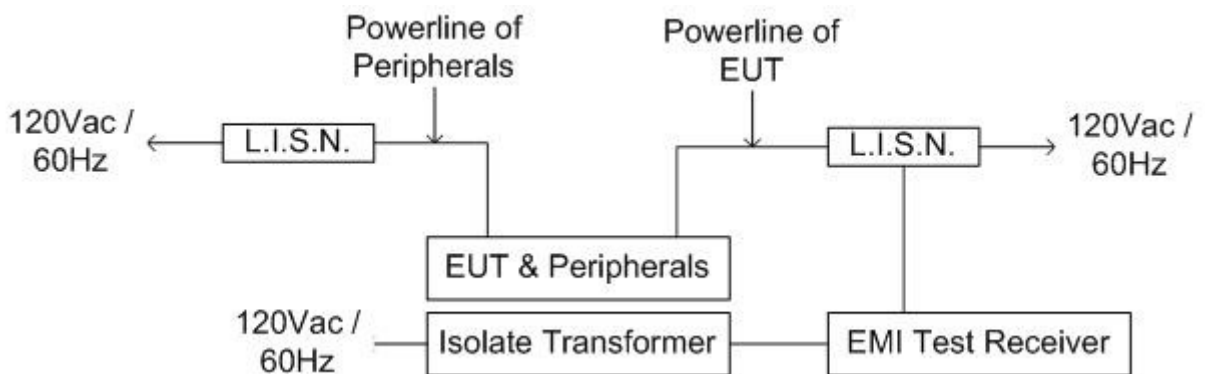
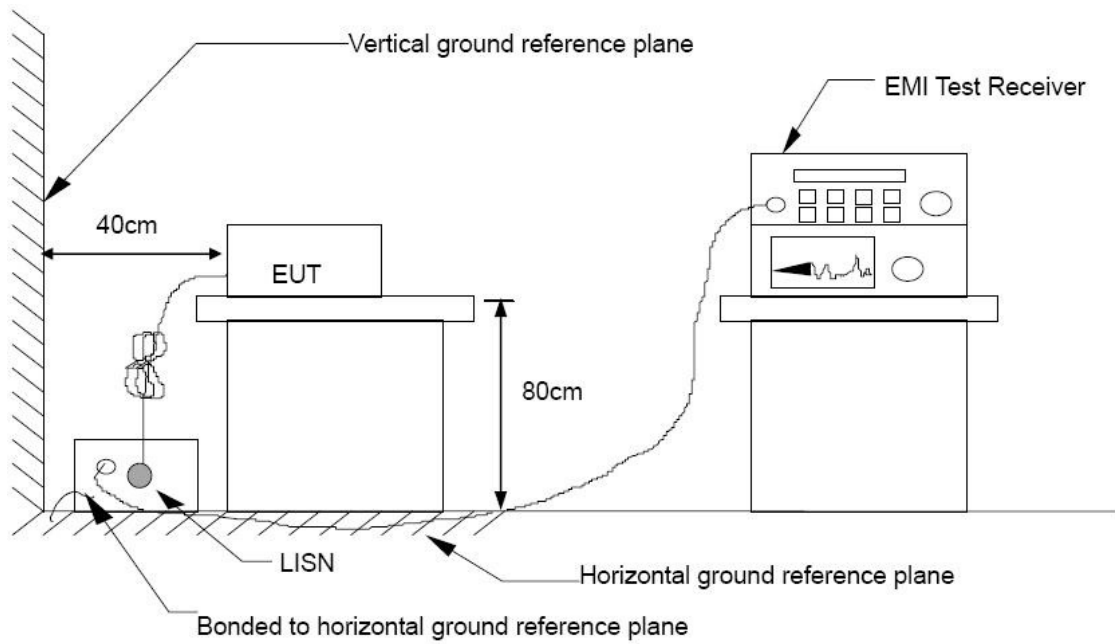

## **TEST PROCEDURE**

The basic test procedure was in accordance with ANSI C63.10:2013.

The test procedure is performed in a 4m × 3m × 2.4m (L×W×H) shielded room.

The EUT along with its peripherals were placed on a 1.0m (W) × 1.5m (L) and 0.8m in height wooden table and the EUT was adjusted to maintain a 0.4 meter space from a vertical reference plane.

The EUT was connected to power mains through a line impedance stabilization network (LISN) which provides 50 ohm coupling impedance for measuring instrument and the chassis ground was bounded to the horizontal ground plane of shielded room. All peripherals were connected to the second LISN and the chassis ground also bounded to the horizontal ground plane of shielded room.

The EUT was located so that the distance between the boundary of the EUT and the closest surface of the LISN is 0.8 m. Where a mains flexible cord was provided by the manufacturer shall be 1 m long, or if in excess of 1 m, the excess cable was folded back and forth as far as possible so as to form a bundle not exceeding 0.4 m in length.

**TEST RESULTS**

<b>Product Name</b>	300Mbps AV600 Wireless Powerline Adapter	<b>Test By</b>	Jey Li
<b>Test Model</b>	PL7622	<b>Test Date</b>	2015/11/03
<b>Test Mode</b>	Mode 1	<b>Temp. &amp; Humidity</b>	25.8°C, 48%

**LINE**

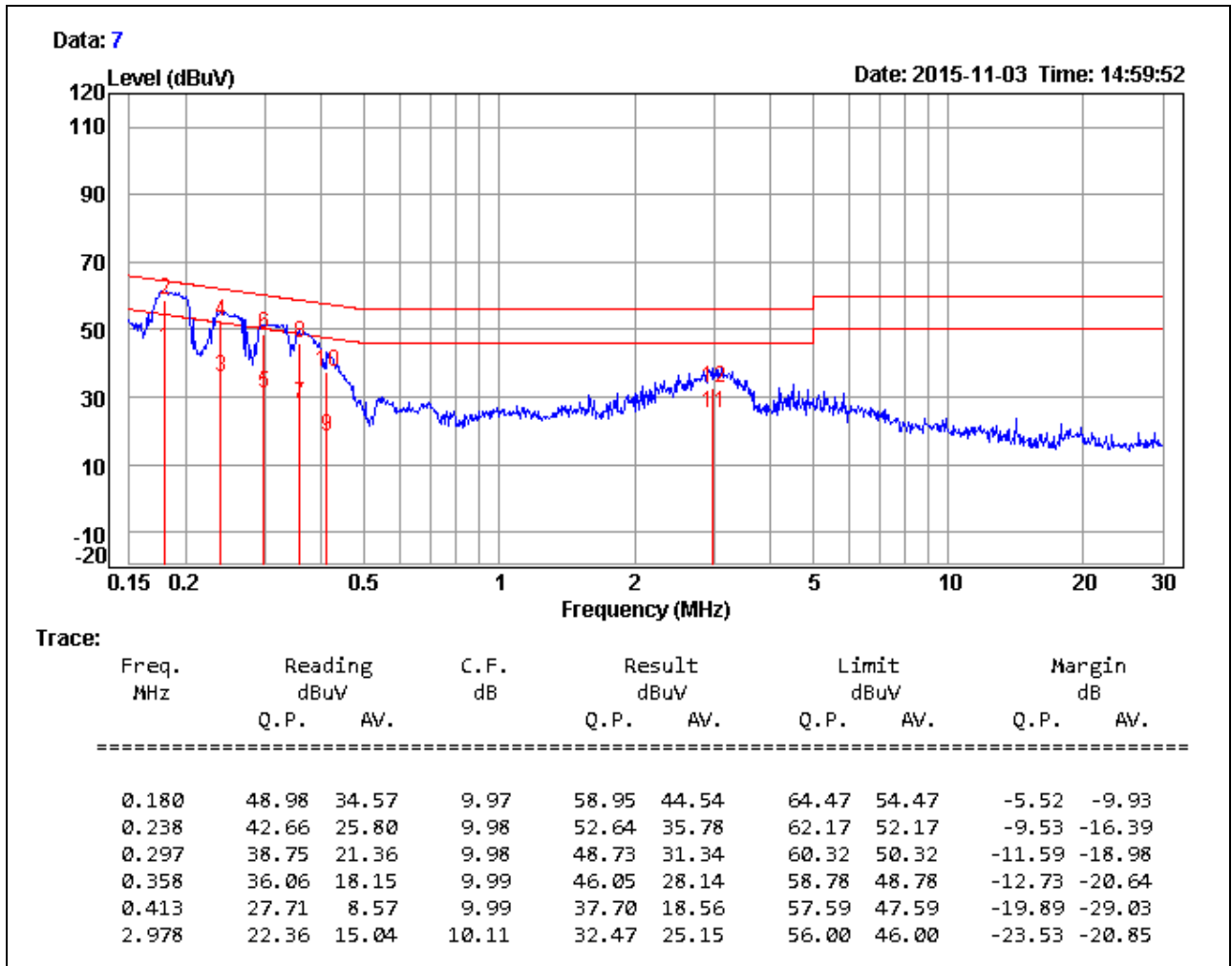

**Remark:**

1. Correction Factor = Insertion loss + Cable loss
2. Result level = Reading Value + Correction factor
3. Margin value = Result level – Limit value

<b>Product Name</b>	300Mbps AV600 Wireless Powerline Adapter	<b>Test By</b>	Jey Li
<b>Test Model</b>	PL7622	<b>Test Date</b>	2015/11/03
<b>Test Mode</b>	Mode 1	<b>Temp. &amp; Humidity</b>	25.8°C, 48%

**NEUTRAL**

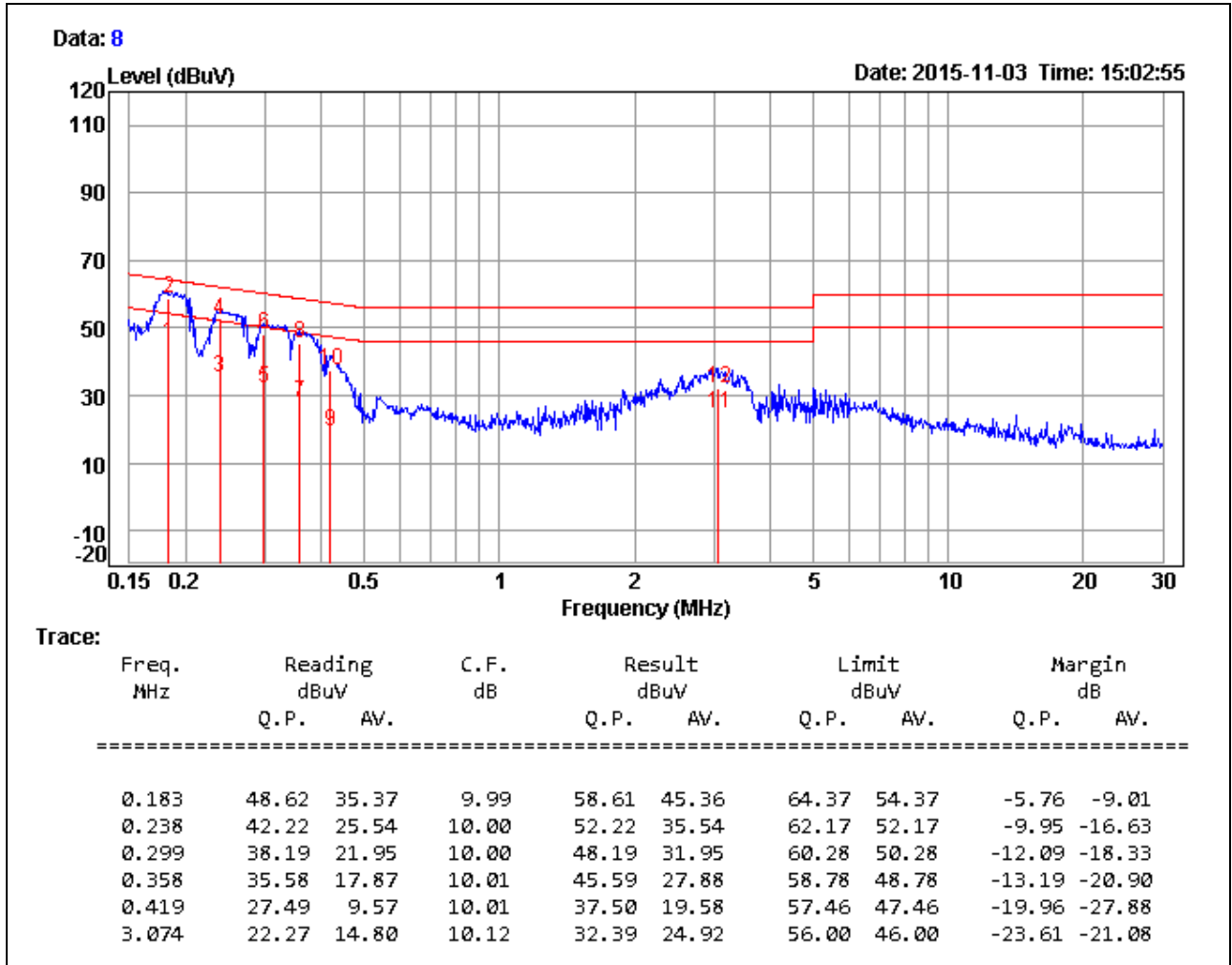

**Remark:**

1. Correction Factor = Insertion loss + Cable loss
2. Result level = Reading Value + Correction factor
3. Margin value = Result level – Limit value