

FCC Radio Test Report

FCC ID: T58NW7252008R1

This report concerns (check one) : Original Grant Class II Change

Issued Date : Oct, 13, 2008
Project No. : 0809C070
Equipment : 802.11n High-speed Wireless Broadband Router
Model Name : NW725
Applicant : Netcore Technology INC.
Address : 9F,B Block,Research&Development Building,
Tsing Hua Information Park,High-Tech Industrial
Park North Section,Nanshan,Shenzhen,China

Tested by:

Neutron Engineering Inc. EMC Laboratory

Date of Test:

Sep. 03, 2008 ~ Sep. 30, 2008

Testing Engineer : Jeff Yang
(Jeff Yang)

Technical Manager : Vic Chiu
(Vic Chiu)

Authorized Signatory : Steven Lu
(Steven Lu)

NEUTRON ENGINEERING INC.

No. 132-1, Lane 329, Sec. 2, Palain Rd.,
Shijr City, Taipei, Taiwan
TEL : (02) 2646-5426 FAX : (02) 2646-6815



Declaration

Neutron represents to the client that testing is done in accordance with standard procedures as applicable and that test instruments used has been calibrated with the standards traceable to National Measurement Laboratory (NML) of R.O.C., or National Institute of Standards and Technology (NIST) of U.S.A.

Neutron's reports apply only to the specific samples tested under conditions. It is manufacture's responsibility to ensure that additional production units of this model are manufactured with the identical electrical and mechanical components. **Neutron** shall have no liability for any declarations, inferences or generalizations drawn by the client or others from **Neutron** issued reports.

Neutron's reports must not be used by the client to claim product endorsement by the authorities or any agency of the Government.

This report is the confidential property of the client. As a mutual protection to the clients, the public and **Neutron-self**, extracts from the test report shall not be reproduced except in full with **Neutron's** authorized written approval.

Neutron's laboratory quality assurance procedures are in compliance with the **ISO Guide 17025** requirements, and accredited by the conformity assessment authorities listed in this test report.

Limitation

For the use of the authority's logo is limited unless the Test Standard(s)/Scope(s)/Item(s) mentioned in this test report is (are) included in the conformity assessment authorities acceptance respective.

Table of Contents	Page
1 . CERTIFICATION	5
2 . SUMMARY OF TEST RESULTS	6
2.1 TEST FACILITY	7
2.2 MEASUREMENT UNCERTAINTY	7
3 . GENERAL INFORMATION	8
3.1 GENERAL DESCRIPTION OF EUT	8
3.2 DESCRIPTION OF TEST MODES	10
3.3 TABLE OF PARAMETERS OF TEXT SOFTWARE SETTING	11
3.4 BLOCK DIGRAM SHOWING THE CONFIGURATION OF SYSTEM TESTED	12
3.5 DESCRIPTION OF SUPPORT UNITS	13
4 . EMC EMISSION TEST	14
4.1 CONDUCTED EMISSION MEASUREMENT	14
4.1.1 POWER LINE CONDUCTED EMISSION LIMITS	14
4.1.2 MEASUREMENT INSTRUMENTS LIST AND SETTING	14
4.1.3 TEST PROCEDURE	15
4.1.4 DEVIATION FROM TEST STANDARD	15
4.1.5 TEST SETUP	15
4.1.6 EUT OPERATING CONDITIONS	15
4.1.7 TEST RESULTS	16
4.2 RADIATED EMISSION MEASUREMENT	18
4.2.1 RADIATED EMISSION LIMITS	18
4.2.2 MEASUREMENT INSTRUMENTS LIST ANS SETTING	19
4.2.3 TEST PROCEDURE	20
4.2.4 DEVIATION FROM TEST STANDARD	20
4.2.5 TEST SETUP	21
4.2.6 EUT OPERATING CONDITIONS	21
4.2.7 TEST RESULTS (BETWEEN30 – 1000 MHZ)	22
4.2.8 TEST RESULTS (ABOVE 1000 MHZ)	26
4.2.9 TEST RESULTS (RESTRICTED BANDS REQUIREMENTS)	74
5 . BANDWIDTH TEST	90
5.1 APPLIED PROCEDURES / LIMIT	90
5.1.1 MEASUREMENT INSTRUMENTS LIST	90
5.1.2 TEST PROCEDURE	90
5.1.3 DEVIATION FROM STANDARD	90
5.1.4 TEST SETUP	90
5.1.5 EUT OPERATION CONDITIONS	90

Table of Contents	Page
5.1.6 TEST RESULTS	91
6 . PEAK OUTPUT POWER TEST	107
6.1 APPLIED PROCEDURES / LIMIT	107
6.1.1 MEASUREMENT INSTRUMENTS LIST	107
6.1.2 TEST PROCEDURE	107
6.1.3 DEVIATION FROM STANDARD	107
6.1.4 TEST SETUP	107
6.1.5 EUT OPERATION CONDITIONS	107
6.1.6 TEST RESULTS	108
7 . ANTENNA CONDUCTED SPURIOUS EMISSION	111
7.1 APPLIED PROCEDURES / LIMIT	111
7.1.1 MEASUREMENT INSTRUMENTS LIST	111
7.1.2 TEST PROCEDURE	111
7.1.3 DEVIATION FROM STANDARD	111
7.1.4 TEST SETUP	111
7.1.5 EUT OPERATION CONDITIONS	112
7.1.6 TEST RESULTS	113
8 . POWER SPECTRAL DENSITY TEST	145
8.1 APPLIED PROCEDURES / LIMIT	145
8.1.1 MEASUREMENT INSTRUMENTS LIST	145
8.1.2 TEST PROCEDURE	145
8.1.3 DEVIATION FROM STANDARD	145
8.1.4 TEST SETUP	145
8.1.5 EUT OPERATION CONDITIONS	145
8.1.6 TEST RESULTS	146
9 . RF EXPOSURE TEST	162
9.1 APPLIED PROCEDURES / LIMIT	162
9.1.1 MEASUREMENT INSTRUMENTS LIST	162
9.1.2 MPE CALCULATION METHOD	162
9.1.3 DEVIATION FROM STANDARD	163
9.1.4 TEST SETUP	163
9.1.5 EUT OPERATION CONDITIONS	163
9.1.6 TEST RESULTS	164
10 . EUT TEST PHOTO	167

1. CERTIFICATION

Equipment : 802.11n High-speed Wireless Broadband Router

Trade Name : N/A

Model Name : NW725

Applicant : Netcore Technology INC.

Date of Test : Sep. 03, 2008 ~ Sep. 30, 2008

Test Item : ENGINEERING SAMPLE

Standards : FCC Part15, Subpart C(15.247) / ANCI C63.4 : 2003

The above equipment has been tested and found compliance with the requirement of the relative standards by Neutron Engineering Inc. EMC Laboratory.

The test data, data evaluation, and equipment configuration contained in our test report (Ref No. NEI-FCCP-1-0809C070) were obtained utilizing the test procedures, test instruments, test sites that has been accredited by the Authority of NVLAP and TAF according to the ISO-17025 quality assessment standard and technical standard(s).

2. SUMMARY OF TEST RESULTS

Test procedures according to the technical standards:

FCC Part15 (15.247) , Subpart C				
Standard	Section	Test Item	Judgment	Remark
	15.207	Conducted Emission	PASS	
	15.247 (c)	Antenna conducted Spurious Emission	PASS	
	15.247 (a)(2)	6dB Bandwidth	PASS	
	15.247 (b)	Peak Output Power	PASS	
	15.247 (c)	Radiated Spurious Emission	PASS	
	15.247 (d)	Power Spectral Density	PASS	
	15.203	Antenna Requirement	PASS	
	1.1307 1.1310 2.1091 2.1093	RF Exposure Compliance	PASS	

NOTE:

(1) "N/A" denotes test is not applicable in this Test Report

2.1 TEST FACILITY

The test facilities used to collect the test data in this report is **C01/OS02** at the location of No.132-1, Lane 329, Sec. 2, Palian Road, Shijr City, Taipei, Taiwan.

Neutron's test firm number is 95335

2.2 MEASUREMENT UNCERTAINTY

The reported uncertainty of measurement $y \pm U$, where expended uncertainty **U** is based on a standard uncertainty multiplied by a coverage factor of **k=2**, providing a level of confidence of approximately **95 %**.

A. Conducted Measurement :

Test Site	Method	Measurement Frequency Range	U , (dB)	NOTE
C01	ANSI	150 KHz ~ 30MHz	1.94	

B. Radiated Measurement :

Test Site	Method	Measurement Frequency Range	Ant. H / V	U , (dB)	NOTE
OS-01	ANSI	30MHz ~ 200MHz	V	3.82	
		30MHz ~ 200MHz	H	3.60	
		200MHz ~ 1,000MHz	V	3.86	
		200MHz ~ 1,000MHz	H	3.94	
OS-02	ANSI	30MHz ~ 200MHz	V	2.48	
		30MHz ~ 200MHz	H	2.16	
		200MHz ~ 1,000MHz	V	2.50	
		200MHz ~ 1,000MHz	H	2.66	

3. GENERAL INFORMATION

3.1 GENERAL DESCRIPTION OF EUT

Equipment	802.11n High-speed Wireless Broadband Router	
Trade Name	N/A	
Model Name	NW725	
OEM Brand/Model Name	N/A	
Model Difference	N/A	
Product Description	The EUT is a 802.11n High-speed Wireless Broadband Router.	
	Operation Frequency:	2412~2462 MHz
	Modulation Type:	802.11b:CCK, DQPSK, DBPSK 802.11g:OFDM 802.11n:OFDM
	Bit Rate of Transmitter	802.11b:11/5.5/2/1 Mbps 802.11g:54/48/36/24/18/12/9/6 Mbps Draft 802.11n:up to 300Mbps
	Number Of Channel	11 CH, Please see Note 2.
	Antenna Designation:	Please see Note 3.
	Antenna Gain(Peak)	
	Output Power:	802.11b:17.08 dBm 802.11g:14.11 dBm 802.11n(20MHz):13.19dBm 802.11n(40MHz):12.11 dBm
	Based on the application, features, or specification exhibited in User's Manual, the EUT is considered as an ITE/Computing Device. More details of EUT technical specification, please refer to the User's Manual.	
	Channel List	Please refer to the Note 2.
Power Source	DC Voltage supplied from AC/DC Adapter(with core)	
Power Rating	I/P 100~240V 0.2A 50/60Hz, O/P DC 9V 700mA	
Connecting I/O Port(s)	Please refer to the User's Manual	
Products Covered	AC/DC Adapter(model name:TP090700A)	

Note
:

1. For a more detailed features description, please refer to the manufacturer's specifications or the User's Manual.

- 2 CH 01 – CH 11 for 802.11b, 802.11g, 802.11n(20MHz)
- . CH 03 – CH 09 for 802.11n(40MHz)

Channel List							
Channel	Frequency (MHz)	Channel	Frequency (MHz)	Channel	Frequency (MHz)	Channel	Frequency (MHz)
01	2412	04	2427	07	2442	10	2457
02	2417	05	2432	08	2447	11	2462
03	2422	06	2437	09	2452		

- 3 Table for Filed Antenna
- .

Ant.	Brand	Model Name	Antenna Type	Connector	Gain (dBi)
1	FRE	E421X-2000A1	Dipole Antenna	R-SMA	2.0

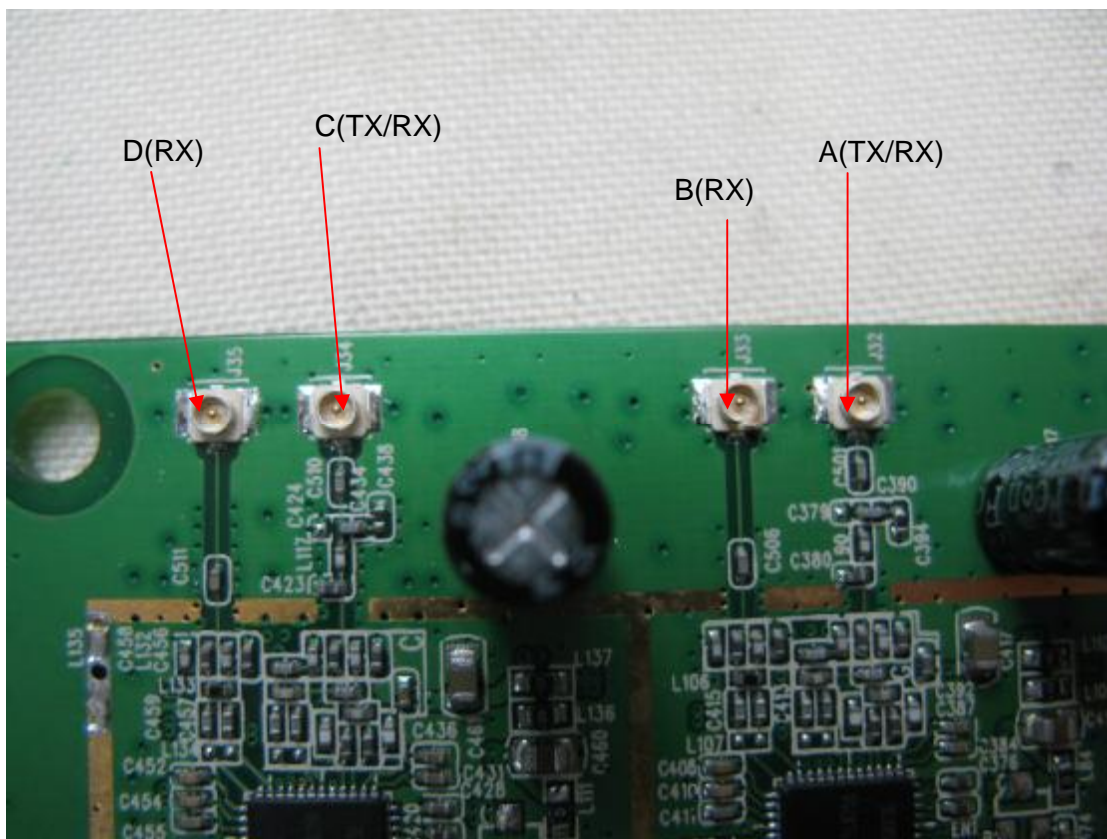

ANT A /C with Transceiver function, ANT B/D with Receiver function

- 4 The EUT incorporates MIMO function. Physically, the EUT provides two completed transmitters and four receivers (2T4R) .

Modulated type	TX Function
802.11b	1TX(Ant .A)
802.11g	1TX(Ant .A)
Draft 802.11n(20MHz)	2TX1TX(Ant .A/C)
Draft 802.11n(40MHz)	2TX1TX(Ant .A/C)

3.2 DESCRIPTION OF TEST MODES

To investigate the maximum EMI emission characteristics generates from EUT, the test system was pre-scanning tested base on the consideration of following EUT operation mode or test configuration mode which possible have effect on EMI emission level. Each of these EUT operation mode(s) or test configuration mode(s) mentioned above was evaluated respectively.

Pretest Mode	Description
Mode 1	802.11b/CH01, CH06, CH11
Mode 2	802.11g/CH01, CH06, CH11
Mode 3	802.11n/20M/CH01, CH06, CH11 (Antenna A & Antenna C & Antenna A + Antenna C)
Mode 4	802.11n/40M/CH03, CH6, CH9 (Antenna A & Antenna C & Antenna A + Antenna C)

For Conducted Test	
Final Test Mode	Description
Mode 5	Normal Link (802.11n mode)

For Radiated Test	
Final Test Mode	Description
Mode 1	802.11b/CH01, CH06, CH11
Mode 2	802.11g/CH01, CH06, CH11
Mode 3	802.11n/20M/CH01, CH06, CH11 (Antenna A & Antenna C & Antenna A + Antenna C)
Mode 4	802.11n/40M/CH03, CH6, CH9 (Antenna A & Antenna C & Antenna A + Antenna C)

Note:

- (1) The measurements are performed at the highest, middle, lowest available channels.

3.3 TABLE OF PARAMETERS OF TEXT SOFTWARE SETTING

During testing channel & power controlling software provided by the customer was used to control the operating channel as well as the output power level. The RF output power selection is for the setting of RF output power expected by the customer and is going to be fixed on the firmware of the final end product power parameters of WLAN

Test software Version	Test Program: MP_TEST		
Frequency	2412 MHz	2437 MHz	2462 MHz
IEEE 802.11b DSSS (Antenna A)	24	24	24
IEEE 802.11g OFDM (Antenna A)	28	28	27
11N-20MHz (Antenna A)	20	20	20
11N-20MHz (Antenna C)	20	20	20

Test software Version	Test Program: MP_TEST		
Frequency	2422 MHz	2437 MHz	2452 MHz
11N-40MHz (Antenna A)	15	15	15
11N-40MHz (Antenna C)	15	15	15

3.4 BLOCK DIGRAM SHOWING THE CONFIGURATION OF SYSTEM TESTED
Conducted Mode:

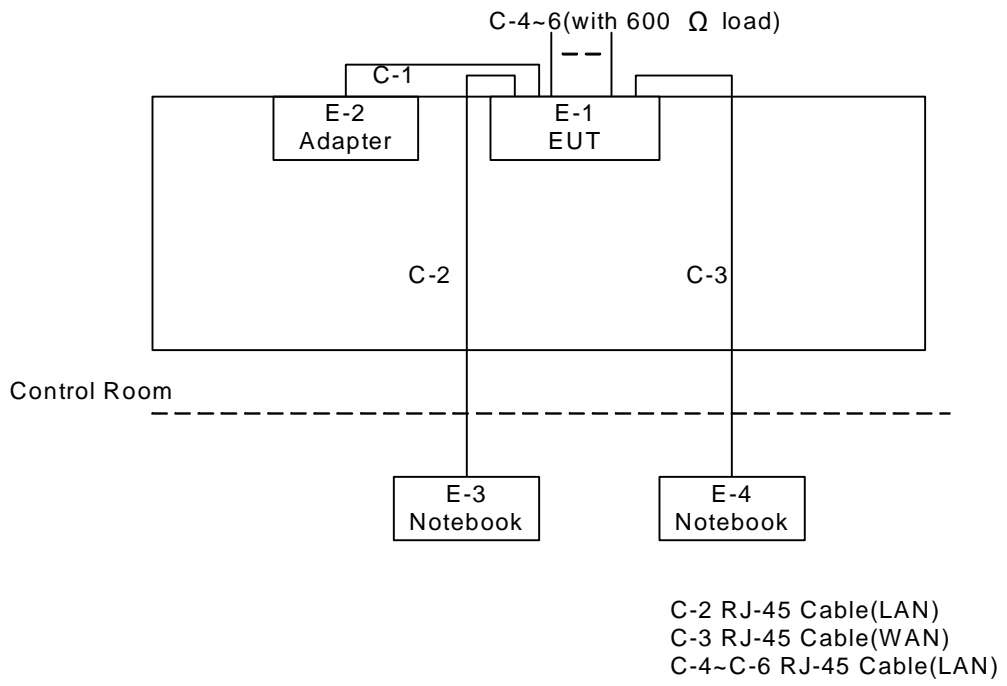

Radiated (CTX Mode):

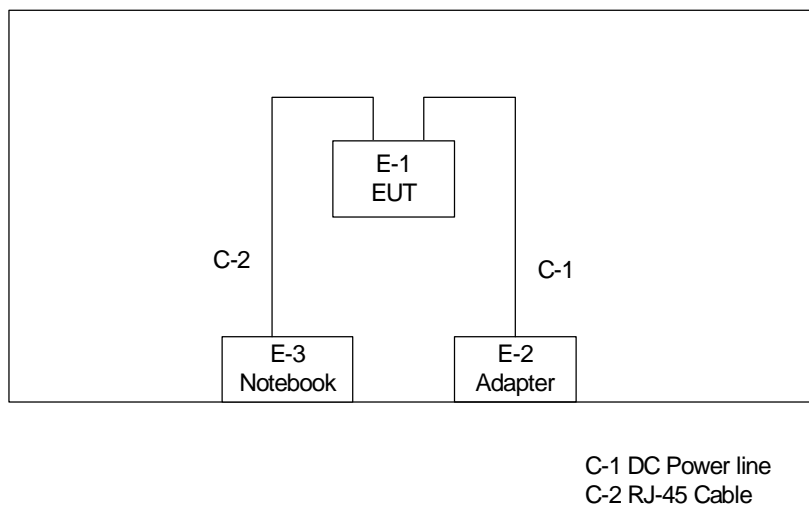

3.5 DESCRIPTION OF SUPPORT UNITS

The EUT has been tested as an independent unit together with other necessary accessories or support units. The following support units or accessories were used to form a representative test configuration during the tests.

Item	Equipment	Mfr/Brand	Model/Type No.	FCC ID	Series No.	Note
E-1	802.11n High-speed Wireless Broadband Router	N/A	NW725	T58NW7252008R1	N/A	EUT
E-2	Adapter	N/A	TP090700A	DOC	N/A	
E-3	Notebook	ARIMA	CP11	DOC	N/A	
E-4	Notebook	DELL	D600	DOC	N/A	

Item	Shielded Type	Ferrite Core	Length	Note
C-1	NO	YES	1.8M	
C-2	NO	NO	10M	Radiated mode -0.8M
C-2	NO	NO	10M	

Note:

- (1) The support equipment was authorized by Declaration of Confirmation.
- (2) For detachable type I/O cable should be specified the length in cm in 『Length』 column.

4. EMC EMISSION TEST

4.1 CONDUCTED EMISSION MEASUREMENT

4.1.1 POWER LINE CONDUCTED EMISSION Limits (Frequency Range 150KHz-30MHz)

FREQUENCY (MHz)	Class A (dBuV)		Class B (dBuV)		Standard
	Quasi-peak	Average	Quasi-peak	Average	
0.15 -0.5	79.00	66.00	66 - 56 *	56 - 46 *	CISPR
0.50 -5.0	73.00	60.00	56.00	46.00	CISPR
5.0 -30.0	73.00	60.00	60.00	50.00	CISPR

0.15 -0.5	79.00	66.00	66 - 56 *	56 - 46 *	FCC
0.50 -5.0	73.00	60.00	56.00	46.00	FCC
5.0 -30.0	73.00	60.00	60.00	50.00	FCC

Note:

- (1) The tighter limit applies at the band edges.
- (2) The limit of " * " marked band means the limitation decreases linearly with the logarithm of the frequency in the range.

4.1.2 MEASUREMENT INSTRUMENTS LIST AND SETTING

Item	Kind of Equipment	Manufacturer	Type No.	Serial No.	Calibrated until
1	LISN	EMCO	3816/2	00042991	Jan. 24, 2009
2	LISN	EMCO	3816/2	00042990	Jan. 24, 2009
3	Pulse Limiter	Electro-Metrics	EM-7600	112644	Nov. 27, 2008
4	50Ω Terminator	N/A	N/A	N/A	May.13, 2009
5	Test Cable	N/A	C01	N/A	Nov. 27, 2008
6	EMI Test Receiver	R&S	ESCI	100082	Mar. 07, 2009

Remark: " N/A" denotes No Model Name. , Serial No. or No Calibration specified.

The following table is the setting of the receiver

Receiver Parameters	Setting
Attenuation	10 dB
Start Frequency	0.15 MHz
Stop Frequency	30 MHz
IF Bandwidth	9 kHz

4.1.3 TEST PROCEDURE

- a. The EUT was placed 0.4 meters from the horizontal ground plane with EUT being connected to the power mains through a line impedance stabilization network (LISN). All other support equipments powered from additional LISN(s). The LISN provide 50 Ohm/ 50uH of coupling impedance for the measuring instrument.
- b. Interconnecting cables that hang closer than 40 cm to the ground plane shall be folded back and forth in the center forming a bundle 30 to 40 cm long.
- c. I/O cables that are not connected to a peripheral shall be bundled in the center. The end of the cable may be terminated, if required, using the correct terminating impedance. The overall length shall not exceed 1 m.
- d. LISN at least 80 cm from nearest part of EUT chassis.
- e. For the actual test configuration, please refer to the related Item –EUT Test Photos.

4.1.4 DEVIATION FROM TEST STANDARD

No deviation

4.1.5 TEST SETUP

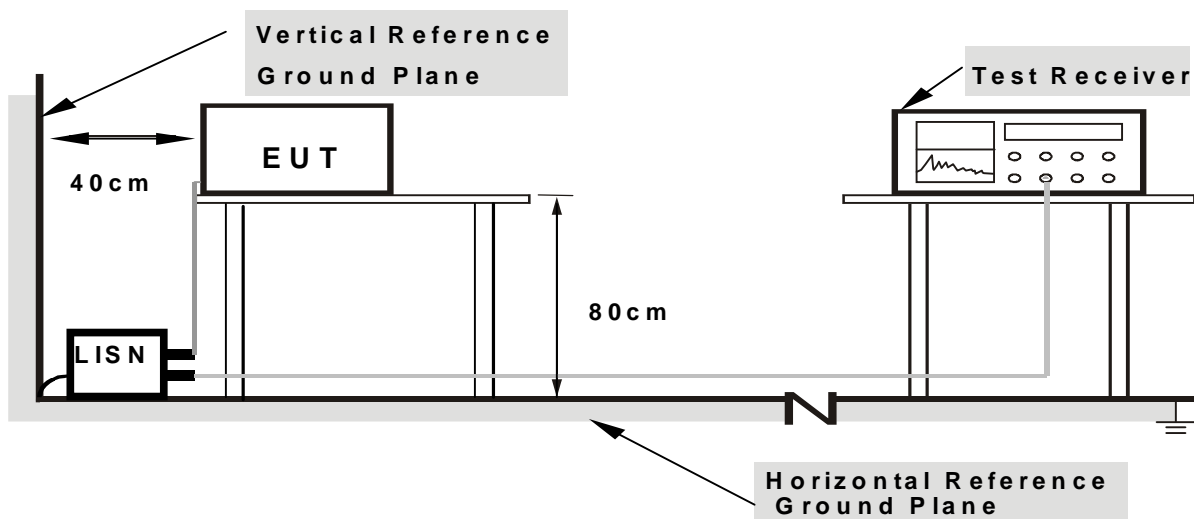

Note: 1. Support units were connected to second LISN.

2. Both of LISNs (AMN) are 80 cm from EUT and at least 80 cm from other units and other metal planes

4.1.6 EUT OPERATING CONDITIONS

The EUT was configured for testing in a typical fashion (as a customer would normally use it). The EUT has been programmed to continuously transmit during test. This operating condition was tested and used to collect the included data.

4.1.7 TEST RESULTS

EUT :	802.11n High-speed Wireless Broadband Router	Model Name :	NW725
Temperature :	29 °C	Relative Humidity :	53%
Pressure :	1010hPa	Test Power :	AC 120V/60Hz
Test Mode :	Normal Link (802.11n mode)		

Freq. (MHz)	Terminal L/N	Measured(dBuV)		Limits(dBuV)		Margin (dB)	Note
		QP-Mode	AV-Mode	QP-Mode	AV-Mode		
0.27	Line	47.66	*	61.12	51.12	-13.46	(QP)
0.40	Line	53.70	37.20	57.89	47.89	-4.19	(QP)
0.49	Line	47.19	32.83	56.10	46.10	-8.91	(QP)
0.77	Line	48.51	32.71	56.00	46.00	-7.49	(QP)
1.21	Line	47.23	30.27	56.00	46.00	-8.77	(QP)
1.69	Line	43.14	*	56.00	46.00	-12.86	(QP)

Remark

- (1) All readings are QP Mode value unless otherwise stated AVG in column of Note. If the QP Mode Measured value compliance with the QP Limits and lower than AVG Limits, the EUT shall be deemed to meet both QP & AVG Limits and then only QP Mode was measured, but AVG Mode didn't perform. In this case, a "*" marked in AVG Mode column of Interference Voltage Measured.
- (2) Measuring frequency range from 150KHz to 30MHz.

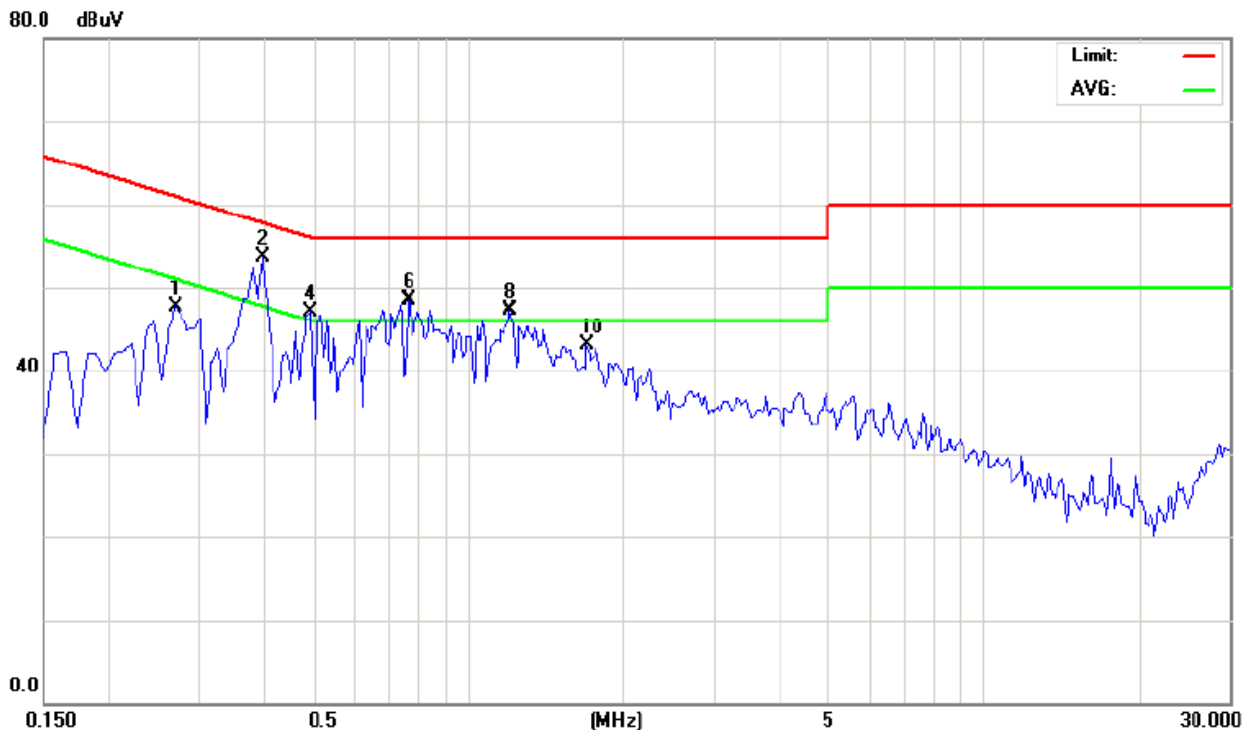

EUT :	802.11n High-speed Wireless Broadband Router	Model Name :	NW725
Temperature :	29 °C	Relative Humidity :	53%
Pressure :	1010hPa	Test Power :	AC 120V/60Hz
Test Mode :	Normal Link (802.11n mode)		

Freq. (MHz)	Terminal L/N	Measured(dBuV)		Limits(dBuV)		Margin (dB)	Note
		QP-Mode	AV-Mode	QP-Mode	AV-Mode		
0.24	Neutral	49.52	*	62.16	52.16	-12.64	(QP)
0.39	Neutral	54.70	44.90	58.07	48.07	-3.17	(AV)
0.79	Neutral	52.92	37.53	56.00	46.00	-3.08	(QP)
1.18	Neutral	49.49	35.67	56.00	46.00	-6.51	(QP)
1.73	Neutral	46.54	*	56.00	46.00	-9.46	(QP)
2.18	Neutral	43.52	*	56.00	46.00	-12.48	(QP)

Remark

- (1) All readings are QP Mode value unless otherwise stated AVG in column of Note. If the QP Mode Measured value compliance with the QP Limits and lower than AVG Limits, the EUT shall be deemed to meet both QP & AVG Limits and then only QP Mode was measured, but AVG Mode didn't perform. In this case, a "*" marked in AVG Mode column of Interference Voltage Measured.
- (2) Measuring frequency range from 150KHz to 30MHz.

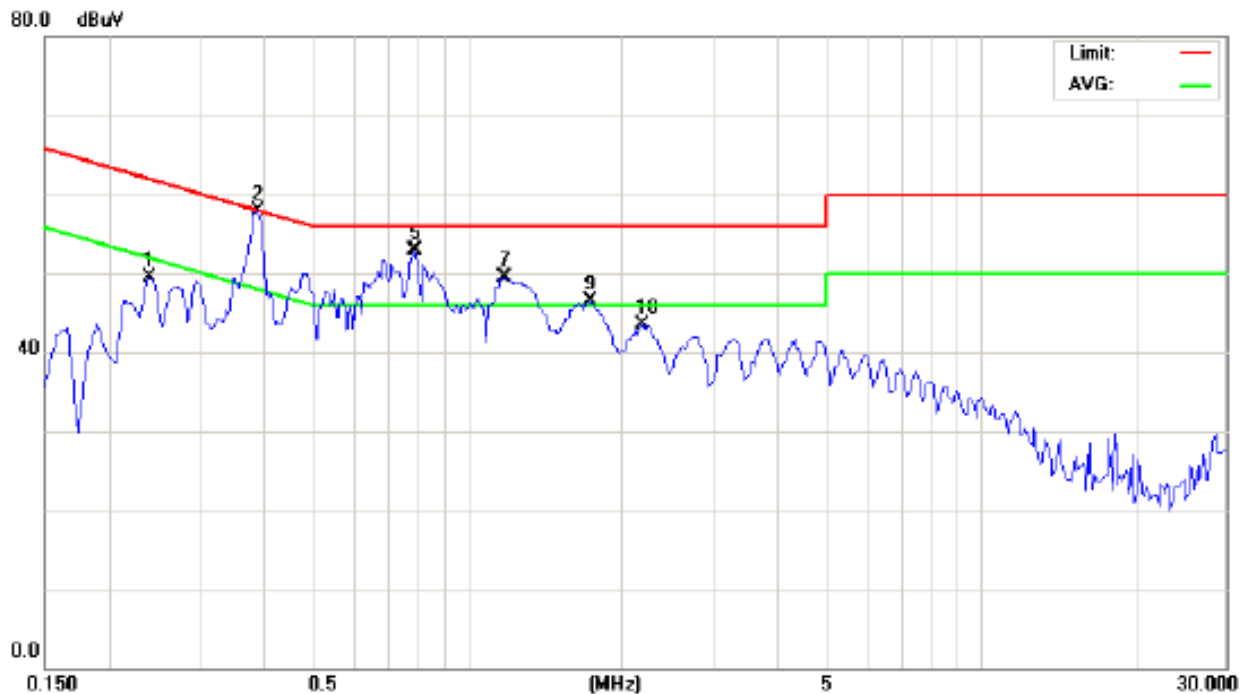

4.2 RADIATED EMISSION MEASUREMENT

4.2.1 RADIATED EMISSION LIMITS (Frequency Range 9KHz-1000MHz)

20dBc in any 100 kHz bandwidth outside the operating frequency band. In case the emission fall within the restricted band specified on 15.205(a), then the 15.209(a) limit in the table below has to be followed.

Frequencies (MHz)	Field Strength (micorvolts/meter)	Measurement Distance (meters)
0.009~0.490	2400/F(KHz)	300
0.490~1.705	24000/F(KHz)	30
1.705~30.0	30	30
30~88	100	3
88~216	150	3
216~960	200	3
Above 960	500	3

LIMITS OF RADIATED EMISSION MEASUREMENT (Above 1000MHz)

FREQUENCY (MHz)	Class A (dBuV/m) (at 3m)		Class B (dBuV/m) (at 3m)	
	PEAK	AVERAGE	PEAK	AVERAGE
Above 1000	80	60	74	54

Notes:

- (1) The limit for radiated test was performed according to FCC PART 15C.
- (2) The tighter limit applies at the band edges.
- (3) Emission level (dBuV/m)=20log Emission level (uV/m).

FREQUENCY RANGE OF RADIATED MEASUREMENT (For unintentional radiators)

Highest frequency generated or Upper frequency of measurement used in the device or on which the device operates or tunes (MHz)	Range (MHz)
Below 1.705	30
1.705 – 108	1000
108 – 500	2000
500 – 1000	5000
Above 1000	5 th harmonic of the highest frequency or 40 GHz, whichever is lower

4.2.2 MEASUREMENT INSTRUMENTS LIST AND SETTING

Item	Kind of Equipment	Manufacturer	Type No.	Serial No.	Calibrated until
1	Log-Bicon Antenna	Schwarzbeck	VULB 9160	3058	Nov. 27, 2008
2	Test Cable	N/A	10M_OS02	N/A	Nov. 27, 2008
3	Test Cable	N/A	OS02-1/-2/-3	N/A	Nov. 27, 2008
4	Pre-Amplifier	Anritsu	MH648A	M09961	Nov. 27, 2008
5	EMI Test Receiver	R&S	ESCI	100082	Jan. 30, 2009
6	Antenna Mast	Chance Most	CMTB-1.5	N/A	N/A
7	Turn Table	Chance Most	CMTB-1.5	N/A	N/A
8	Spectrum Analyzer	R&S	FSP_40	100129	Jan. 07, 2009
9	Horn Antenna	Schwarzbeck	BBHA9120D	9120D-325	Oct. 24, 2008
10	Horn Antenna	Schwarzbeck	BBHA9170	9170187	Oct. 24, 2008
11	Microwave Pre-amplifier	Agilent	8449B	3008A01714	Mar. 09, 2009
12	Microflex Cable	United Microwave	57793	1m	Mar. 09, 2009
13	Microflex Cable	United Microwave	A30A30-500 6	10M	Jul. 06, 2009

Remark: " N/A " denotes No Model Name / Serial No. and No Calibration specified.

Spectrum Parameter	Setting
Attenuation	Auto
Start Frequency	1000 MHz
Stop Frequency	10th carrier harmonic
RB / VB (Emission in restricted band)	1MHz / 1MHz for Peak, 1 MHz / 10Hz for Average
RB / VB (other emission)	100KHz / 100KHz for peak

Receiver Parameter	Setting
Attenuation	Auto
Start ~ Stop Frequency	9kHz~150kHz / RB 200Hz for QP
Start ~ Stop Frequency	150kHz~30MHz / RB 9kHz for QP
Start ~ Stop Frequency	30MHz~1000MHz / RB 120kHz for QP

4.2.3 TEST PROCEDURE

- a. The measuring distance of at 3 m shall be used for measurements at frequency up to 1GHz. For frequencies above 1GHz, any suitable measuring distance may be used.
- b. The EUT was placed on the top of a rotating table 0.8 meters above the ground at a 3 meter open area test site. The table was rotated 360 degrees to determine the position of the highest radiation.
- c. The height of the equipment or of the substitution antenna shall be 0.8 m; the height of the test antenna shall vary between 1 m to 4 m. Both horizontal and vertical polarizations of the antenna are set to make the measurement.
- d. The initial step in collecting conducted emission data is a spectrum analyzer peak detector mode pre-scanning the measurement frequency range. Significant peaks are then marked and then Quasi Peak detector mode re-measured.
- e. If the Peak Mode measured value compliance with and lower than Quasi Peak Mode Limit, the EUT shall be deemed to meet QP Limits and then no additional QP Mode measurement performed.
- f. For the actual test configuration, please refer to the related Item –EUT Test Photos.

4.2.4 DEVIATION FROM TEST STANDARD

No deviation

4.2.5 TEST SETUP

(A) Radiated Emission Test Set-Up, Frequency Below 1000MHz

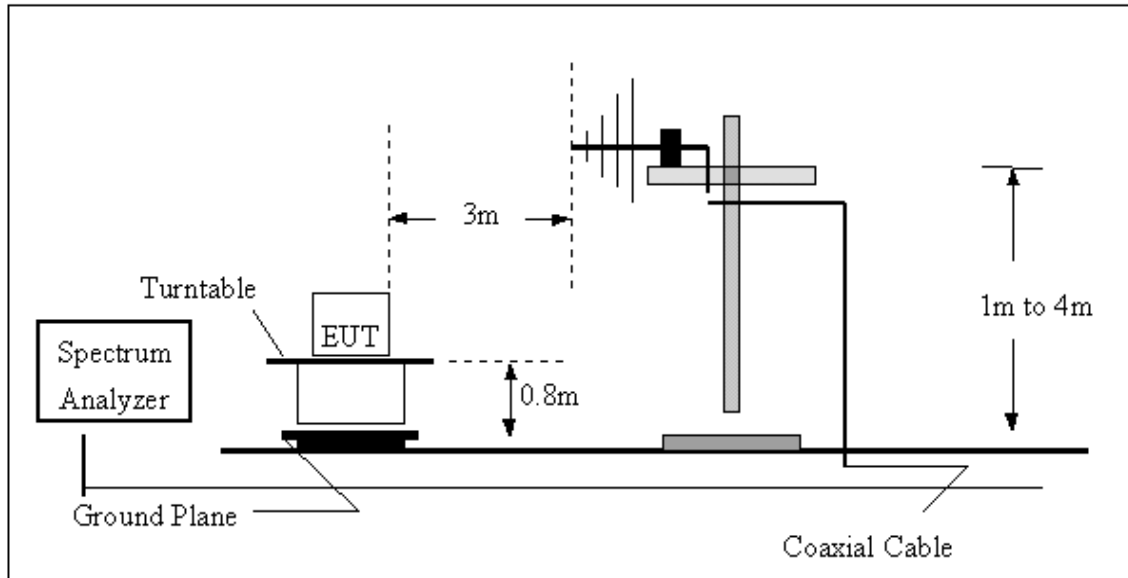

(B) Radiated Emission Test Set-Up Frequency Above 1 GHz

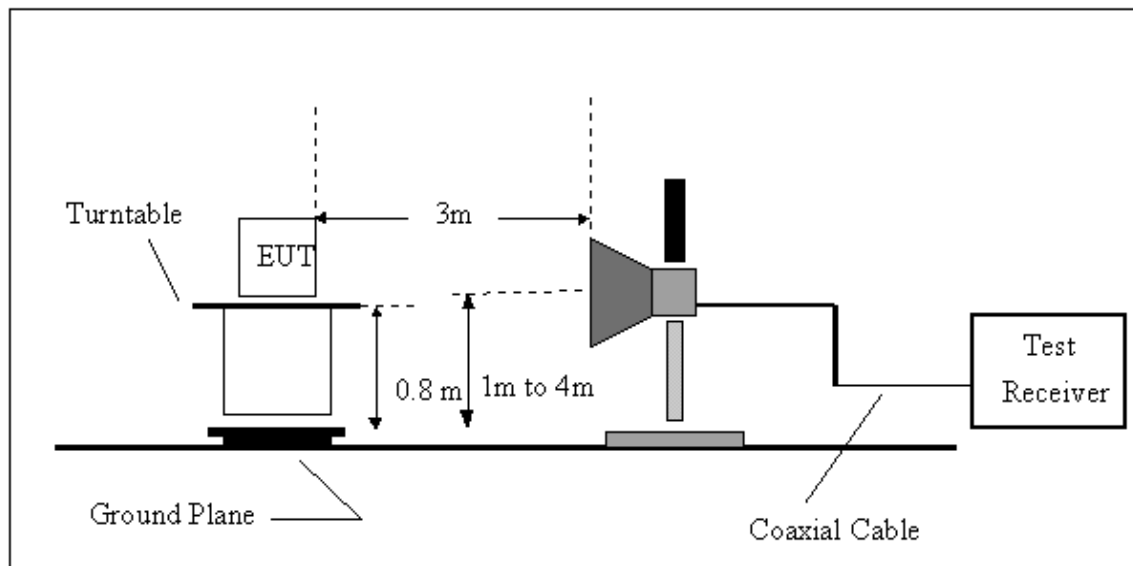

4.2.6 EUT OPERATING CONDITIONS

The EUT tested system was configured as the statements of 4.1.6 Unless otherwise a special operating condition is specified in the follows during the testing.

4.2.7 TEST RESULTS (BETWEEN 30 – 1000 MHZ)

EUT :	802.11n High-speed Wireless Broadband Router	Model Name :	NW725
Temperature :	28 °C	Relative Humidity :	62%
Pressure :	1010 hPa	Test Voltage :	AC 120V/60Hz
Test Mode :	TX G MODE CHANNEL 2437MHz		

Freq. (MHz)	Ant. H/V	Reading(RA) (dBuV)	Corr.Factor(CF) (dB)	Measured(FS) (dBuV/m)	Limits(QP) (dBuV/m)	Margin (dB)	Note
33.88	V	50.58	-13.24	37.34	40.00	- 2.66	
141.55	V	51.82	-21.00	30.82	43.50	- 12.68	
250.19	V	49.53	-16.70	32.83	46.00	- 13.17	
352.04	V	48.88	-13.34	35.54	46.00	- 10.46	
500.45	V	51.22	-10.72	40.50	46.00	- 5.50	
563.50	V	49.56	-9.17	40.39	46.00	- 5.61	

Remark :

- (1) Reading in which marked as QP or Peak means measurements by using are Quasi-Peak Mode or Peak Mode with Detector BW=120KHz ; SPA setting in RBW=120KHz, VBW =120KHz, Swp. Time = 0.3 sec./MHz ◦
- (2) All readings are Peak unless otherwise stated QP in column of 『 Note 』 . Peak denotes that the Peak reading compliance with the QP Limits and then QP Mode measurement didn't perform ◦
- (3) Measuring frequency range from 30MHz to 1000MHz ◦
- (4) If the peak scan value lower limit more than 20dB, then this signal data does not show in table ◦

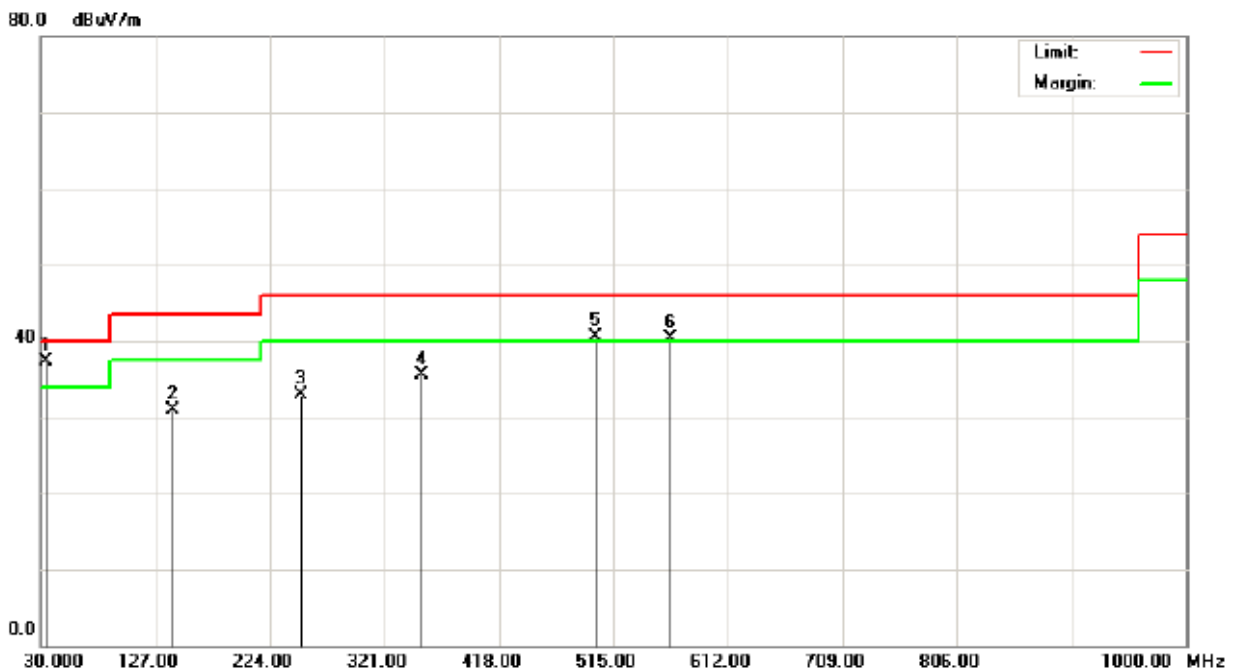

EUT :	802.11n High-speed Wireless Broadband Router	Model Name :	NW725
Temperature :	28 °C	Relative Humidity :	62%
Pressure :	1010 hPa	Test Voltage :	AC 120V/60Hz
Test Mode :	TX G MODE CHANNEL 2437MHz		

Freq. (MHz)	Ant. H/V	Reading(RA) (dBuV)	Corr.Factor(CF) (dB)	Measured(FS) (dBuV/m)	Limits(QP) (dBuV/m)	Margin (dB)	Note
97.90	H	55.90	-20.48	35.42	43.50	- 8.08	
250.19	H	59.82	-16.70	43.12	46.00	- 2.88	
281.23	H	59.18	-15.84	43.34	46.00	- 2.66	
320.03	H	52.59	-14.15	38.44	46.00	- 7.56	
421.88	H	47.50	-12.29	35.21	46.00	- 10.79	
564.47	H	45.94	-9.17	36.77	46.00	- 9.23	

Remark :

- (1) Reading in which marked as QP or Peak means measurements by using are Quasi-Peak Mode or Peak Mode with Detector BW=120KHz ; SPA setting in RBW=120KHz, VBW =120KHz, Swp. Time = 0.3 sec./MHz .
- (2) All readings are Peak unless otherwise stated QP in column of 『Note 』 . Peak denotes that the Peak reading compliance with the QP Limits and then QP Mode measurement didn't perform .
- (3) Measuring frequency range from 30MHz to 1000MHz .
- (4) If the peak scan value lower limit more than 20dB, then this signal data does not show in table .

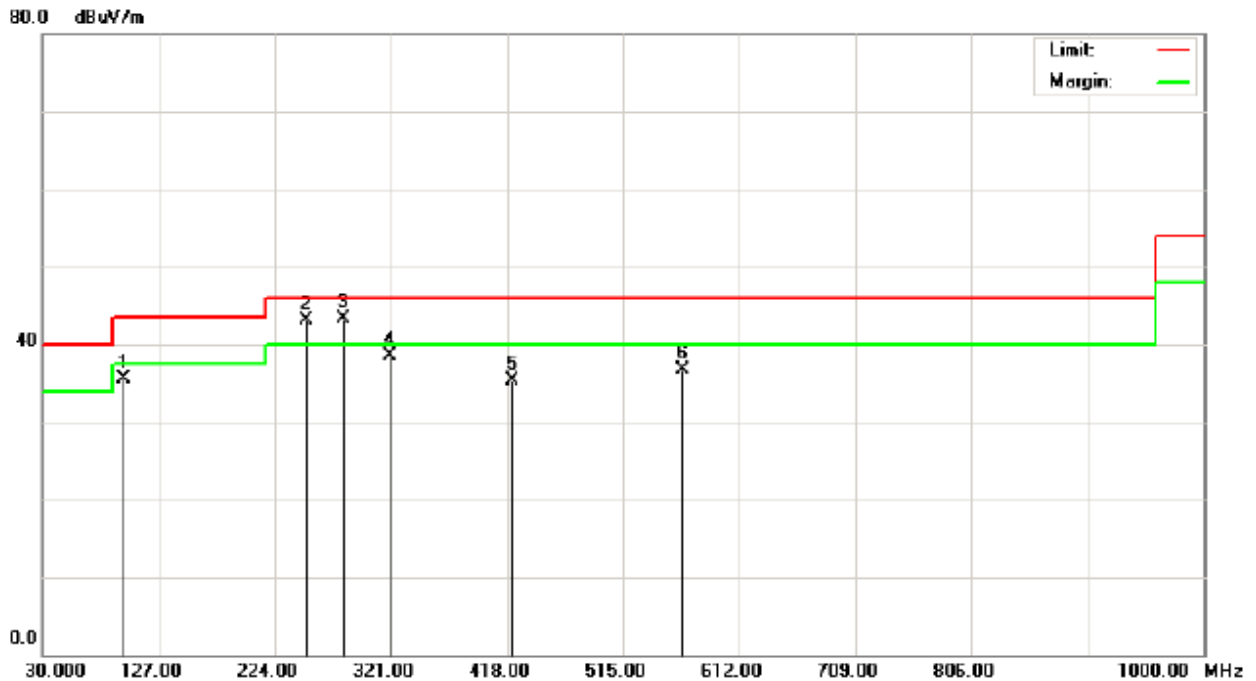

EUT :	802.11n High-speed Wireless Broadband Router	Model Name :	NW725
Temperature :	28 °C	Relative Humidity :	62%
Pressure :	1010 hPa	Test Voltage :	AC 120V/60Hz
Test Mode :	TX N MODE CHANNEL 2437MHz		

Freq. (MHz)	Ant. H/V	Reading(RA) (dBuV)	Corr.Factor(CF) (dB)	Measured(FS) (dBuV/m)	Limits(QP) (dBuV/m)	Margin (dB)	Note
33.88	V	50.12	-13.24	36.88	40.00	- 3.12	
283.17	V	54.44	-15.74	38.81	46.00	- 7.19	
352.04	V	50.33	-13.34	36.99	46.00	- 9.01	
423.82	V	52.82	-12.29	40.53	46.00	- 5.47	
500.45	V	50.35	-10.72	39.63	46.00	- 6.37	
566.41	V	48.50	-9.16	39.34	46.00	- 6.66	

Remark :

- (1) Reading in which marked as QP or Peak means measurements by using are Quasi-Peak Mode or Peak Mode with Detector BW=120KHz ; SPA setting in RBW=120KHz, VBW =120KHz, Swp. Time = 0.3 sec./MHz .
- (2) All readings are Peak unless otherwise stated QP in column of 『 Note 』 . Peak denotes that the Peak reading compliance with the QP Limits and then QP Mode measurement didn't perform .
- (3) Measuring frequency range from 30MHz to 1000MHz .
- (4) If the peak scan value lower limit more than 20dB, then this signal data does not show in table .

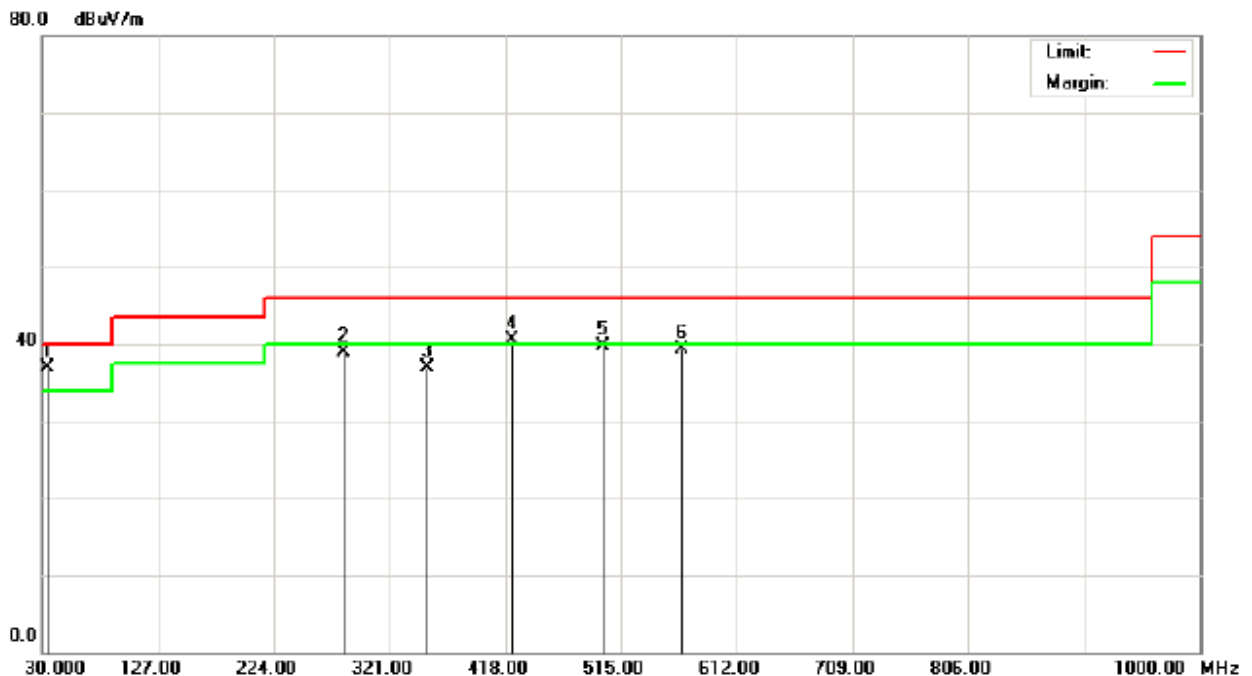

EUT :	802.11n High-speed Wireless Broadband Router	Model Name :	NW725
Temperature :	28 °C	Relative Humidity :	62%
Pressure :	1010 hPa	Test Voltage :	AC 120V/60Hz
Test Mode :	TX N MODE CHANNEL 2437MHz		

Freq. (MHz)	Ant. H/V	Reading(RA) (dBuV)	Corr.Factor(CF) (dB)	Measured(FS) (dBuV/m)	Limits(QP) (dBuV/m)	Margin (dB)	Note
97.90	H	53.18	-20.48	32.70	43.50	- 10.80	
250.19	H	60.08	-16.70	43.38	46.00	- 2.62	
281.23	H	55.02	-15.84	39.18	46.00	- 6.82	
320.03	H	53.11	-14.15	38.96	46.00	- 7.04	
500.45	H	44.67	-10.72	33.95	46.00	- 12.05	
566.41	H	46.04	-9.16	36.88	46.00	- 9.12	

Remark :

- (1) Reading in which marked as QP or Peak means measurements by using are Quasi-Peak Mode or Peak Mode with Detector BW=120KHz ; SPA setting in RBW=120KHz, VBW =120KHz, Swp. Time = 0.3 sec./MHz ◦
- (2) All readings are Peak unless otherwise stated QP in column of 『Note 』 . Peak denotes that the Peak reading compliance with the QP Limits and then QP Mode measurement didn't perform ◦
- (3) Measuring frequency range from 30MHz to 1000MHz ◦
- (4) If the peak scan value lower limit more than 20dB, then this signal data does not show in table ◦

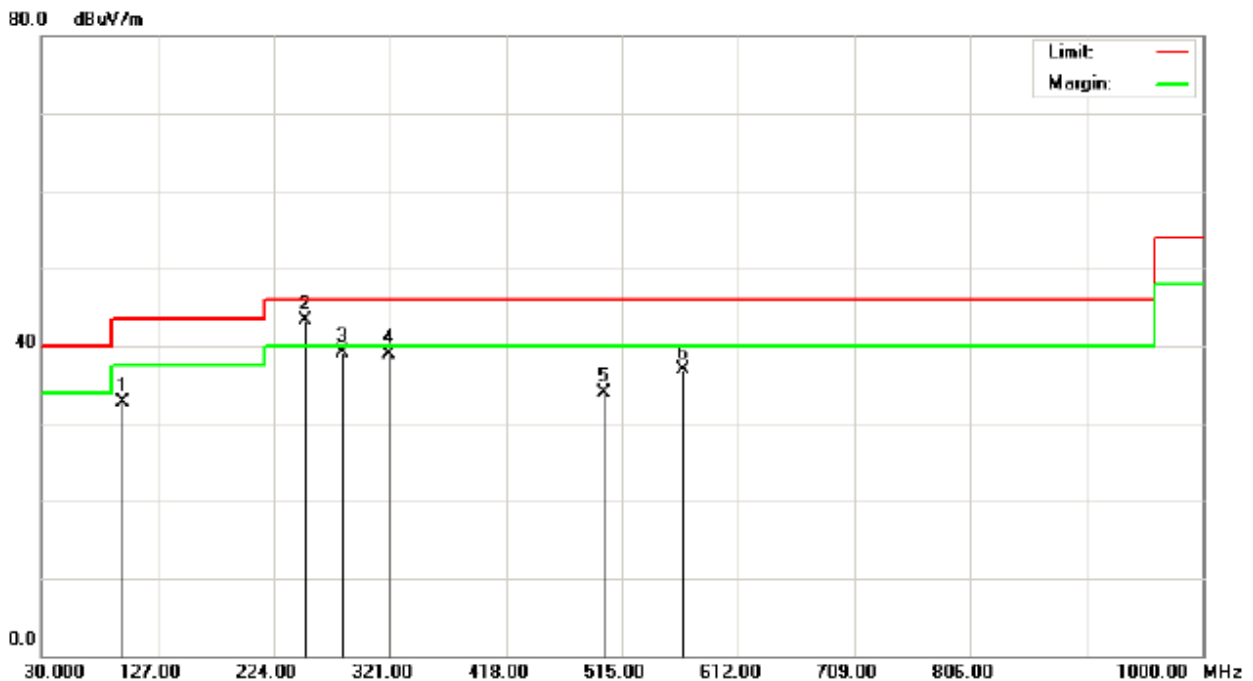

4.2.8 TEST RESULTS (ABOVE 1000 MHZ)

EUT :	802.11n High-speed Wireless Broadband Router	Model Name :	NW725
Temperature :	28 °C	Relative Humidity :	62%
Pressure :	1010 hPa	Test Voltage :	AC 120V/60Hz
Test Mode :	TX B MODE 20M-BW CHANNEL 2412MHz		

Freq. (MHz)	Ant.Pol. H/V	Reading		Ant./CF CF(dB)	Act.		Limit		Note
		Peak (dBuV)	AV (dBuV)		Peak (dBuV/m)	AV (dBuV/m)	Peak (dBuV/m)	AV (dBuV/m)	
2390.00	V	21.91	11.73	32.05	53.96	43.78	74.00	54.00	X/E
2412.78	V	78.07	74.23	32.12	110.19	106.35			X/F
1120.20	V	52.30	43.68	-8.92	43.38	34.76	74.00	54.00	X/H
4824.30	V	51.22	41.71	3.57	54.79	45.28	74.00	54.00	X/H

Remark :

- (1) All readings are Peak unless otherwise stated QP in column of 『Note』 . Peak denotes that the Peak reading compliance with the QP Limits and then QP Mode measurement didn't perform .
- (2) Measuring frequency range from 30MHz to 1000MHz or the 10th harmonic of highest fundamental frequency . "F" denotes fundamental frequency; "H" denotes spurious frequency. "E" denotes band edge frequency. (This judgment method includes the Band Edge Requirement.)
- (3) Radiated emissions measured in frequency range above 1000MHz were made with an instrument using Peak detector mode and AV detector mode of the emission .
- (4) Data of measurement within this frequency range shown " * " in the table above means the reading of emissions are attenuated more than 20dB below the permissible limits or the field strength is too small to be measured.
- (5) A preamp and high pass filter were used for this test in order to provide sufficient measurement sensitivity.
- (6) EUT Orthogonal Axis :
"X" - denotes Laid on Table ; "Y" - denotes Vertical Stand ; "Z" - denotes Side Stand
- (7) During the measurements above 1 GHz it is taken care of that the EUT is always within the 3 dB cone of radiation BW of the used antenna

TX CH01 (Above 1000 MHz, Vertical)

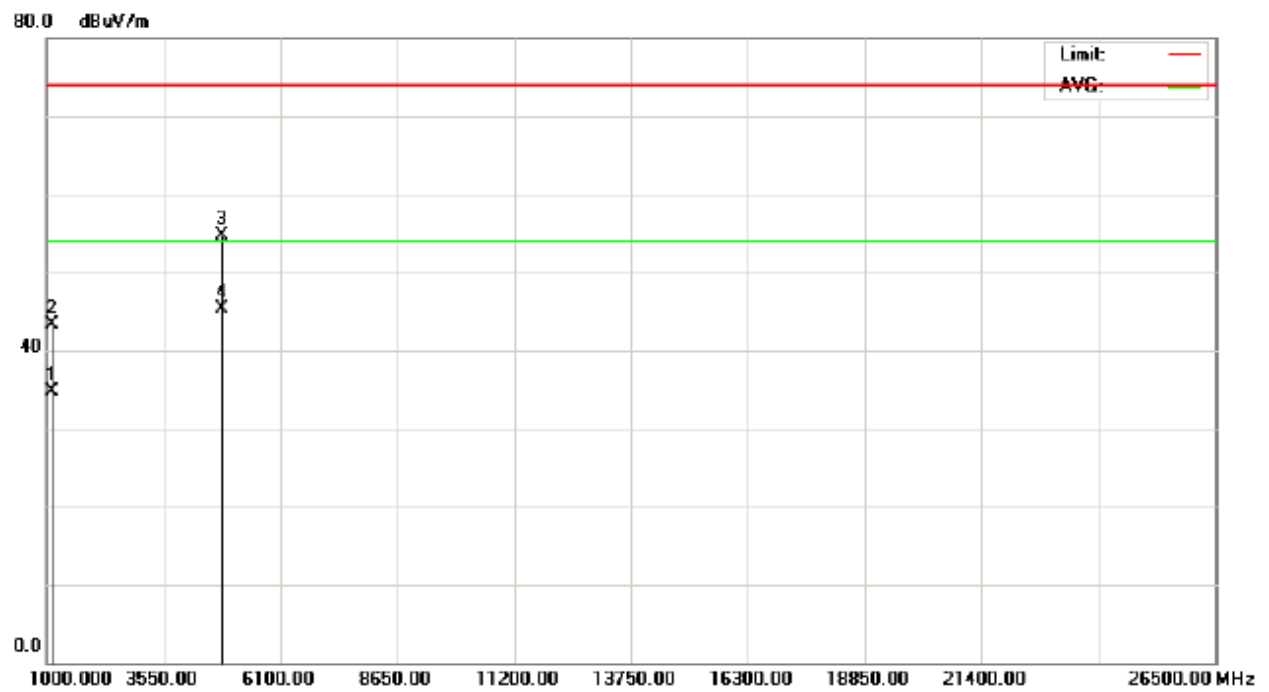
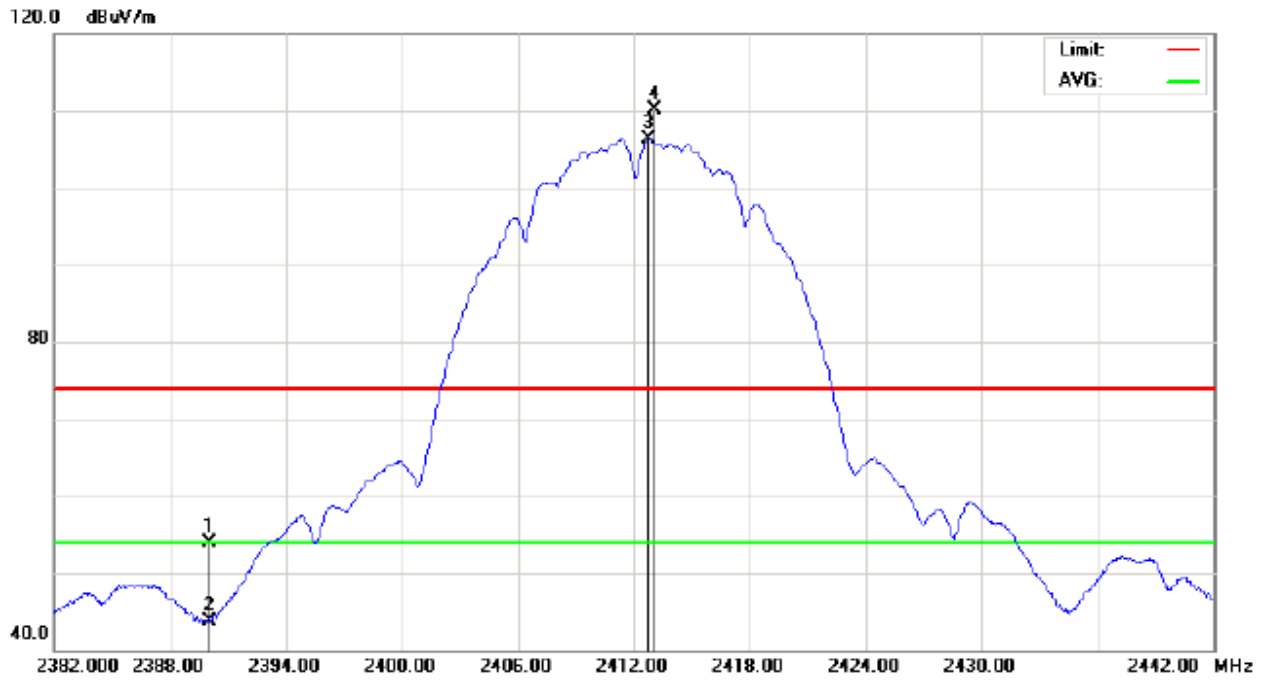

EUT :	802.11n High-speed Wireless Broadband Router	Model Name :	NW725
Temperature :	28 °C	Relative Humidity :	62%
Pressure :	1010 hPa	Test Voltage :	AC 120V/60Hz
Test Mode :	TX B MODE 20M-BW CHANNEL 2412MHz		

Freq. (MHz)	Ant.Pol. H/V	Reading		Ant./CF CF(dB)	Act.		Limit		Note
		Peak (dBuV)	AV (dBuV)		Peak (dBuV/m)	AV (dBuV/m)	Peak (dBuV/m)	AV (dBuV/m)	
2390.00	H	22.40	10.22	32.05	54.45	42.27	74.00	54.00	X/E
2412.84	H	64.82	60.99	32.12	96.94	93.11			X/F
1808.30	H	49.22	40.32	-5.31	43.91	35.01	74.00	54.00	X/H
4824.07	H	53.47	43.91	3.57	57.04	47.48	74.00	54.00	X/H

Remark :

- (1) All readings are Peak unless otherwise stated QP in column of 『 Note 』 . Peak denotes that the Peak reading compliance with the QP Limits and then QP Mode measurement didn't perform .
- (2) Measuring frequency range from 30MHz to 1000MHz or the 10th harmonic of highest fundamental frequency . "F" denotes fundamental frequency ; "H" denotes spurious frequency . "E" denotes band edge frequency . (This judgment method includes the Band Edge Requirement.)
- (3) Radiated emissions measured in frequency range above 1000MHz were made with an instrument using Peak detector mode and AV detector mode of the emission .
- (4) Data of measurement within this frequency range shown " * " in the table above means the reading of emissions are attenuated more than 20dB below the permissible limits or the field strength is too small to be measured.
- (5) A preamp and high pass filter were used for this test in order to provide sufficient measurement sensitivity.
- (6) EUT Orthogonal Axis :
"X" - denotes Laid on Table ; "Y" - denotes Vertical Stand ; "Z" - denotes Side Stand
- (7) During the measurements above 1 GHz it is taken care of that the EUT is always within the 3 dB cone of radiation BW of the used antenna

TX CH01 (Above 1000 MHz, Horizontal)

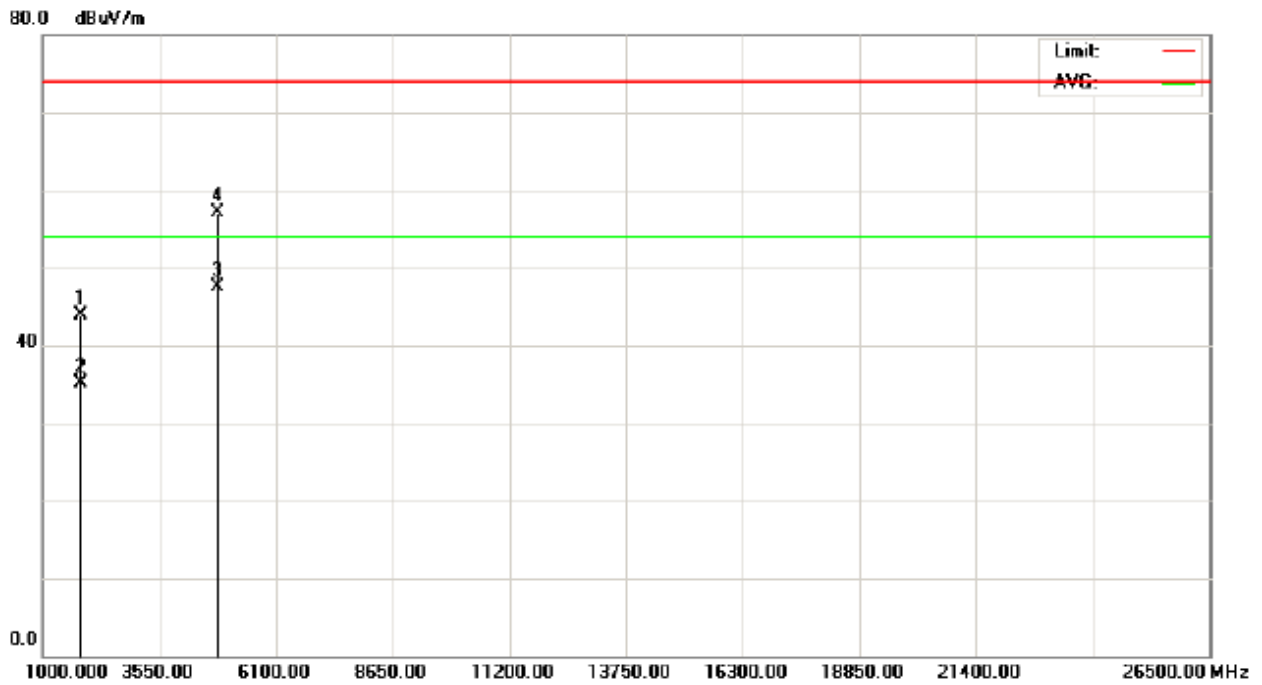
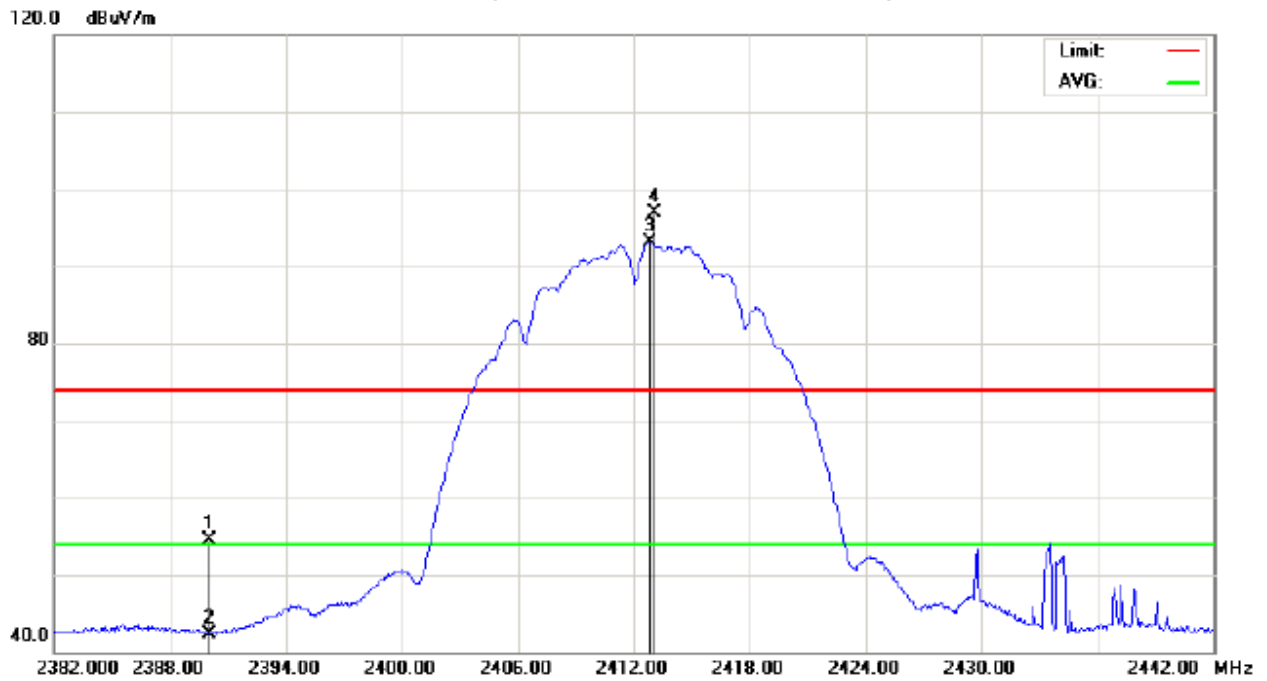

EUT :	802.11n High-speed Wireless Broadband Router	Model Name :	NW725
Temperature :	28 °C	Relative Humidity :	62%
Pressure :	1010 hPa	Test Voltage :	AC 120V/60Hz
Test Mode :	TX B MODE 20M-BW CHANNEL 2437MHz		

Freq. (MHz)	Ant.Pol. H/V	Reading		Ant./CF CF(dB)	Act.		Limit		Note
		Peak (dBuV)	AV (dBuV)		Peak (dBuV/m)	AV (dBuV/m)	Peak (dBuV/m)	AV (dBuV/m)	
2436.10	V	78.43	74.74	32.20	110.63	106.94			X/F
1120.40	V	50.44	41.78	-8.92	41.52	32.86	74.00	54.00	X/H
4874.17	V	50.19	44.76	3.72	53.91	48.48	74.00	54.00	X/H

Remark :

- (1) All readings are Peak unless otherwise stated QP in column of 『 Note 』 . Peak denotes that the Peak reading compliance with the QP Limits and then QP Mode measurement didn't perform .
- (2) Measuring frequency range from 30MHz to 1000MHz or the 10th harmonic of highest fundamental frequency . "F" denotes fundamental frequency ; "H" denotes spurious frequency . "E" denotes band edge frequency . (This judgment method includes the Band Edge Requirement.)
- (3) Radiated emissions measured in frequency range above 1000MHz were made with an instrument using Peak detector mode and AV detector mode of the emission .
- (4) Data of measurement within this frequency range shown " * " in the table above means the reading of emissions are attenuated more than 20dB below the permissible limits or the field strength is too small to be measured.
- (5) A preamp and high pass filter were used for this test in order to provide sufficient measurement sensitivity.
- (6) EUT Orthogonal Axis :
"X" - denotes Laid on Table ; "Y" - denotes Vertical Stand ; "Z" - denotes Side Stand
- (7) During the measurements above 1 GHz it is taken care of that the EUT is always within the 3 dB cone of radiation BW of the used antenna

TX CH06 (Above 1000 MHz, Vertical)

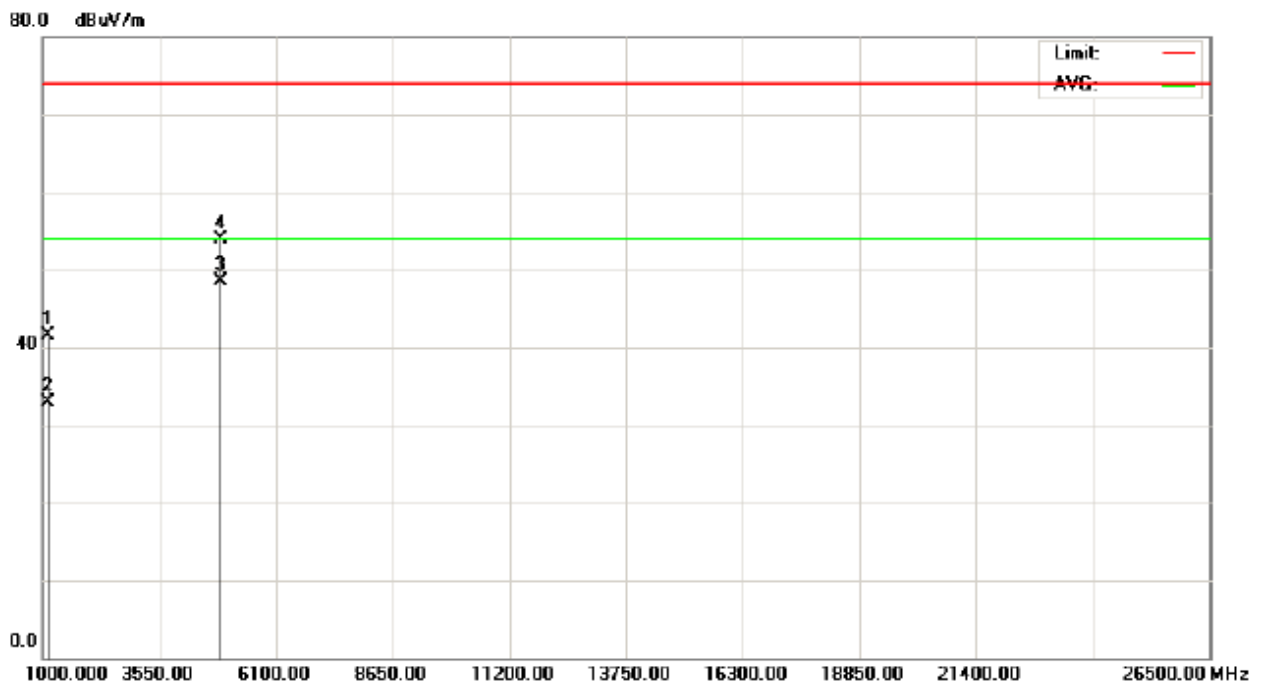
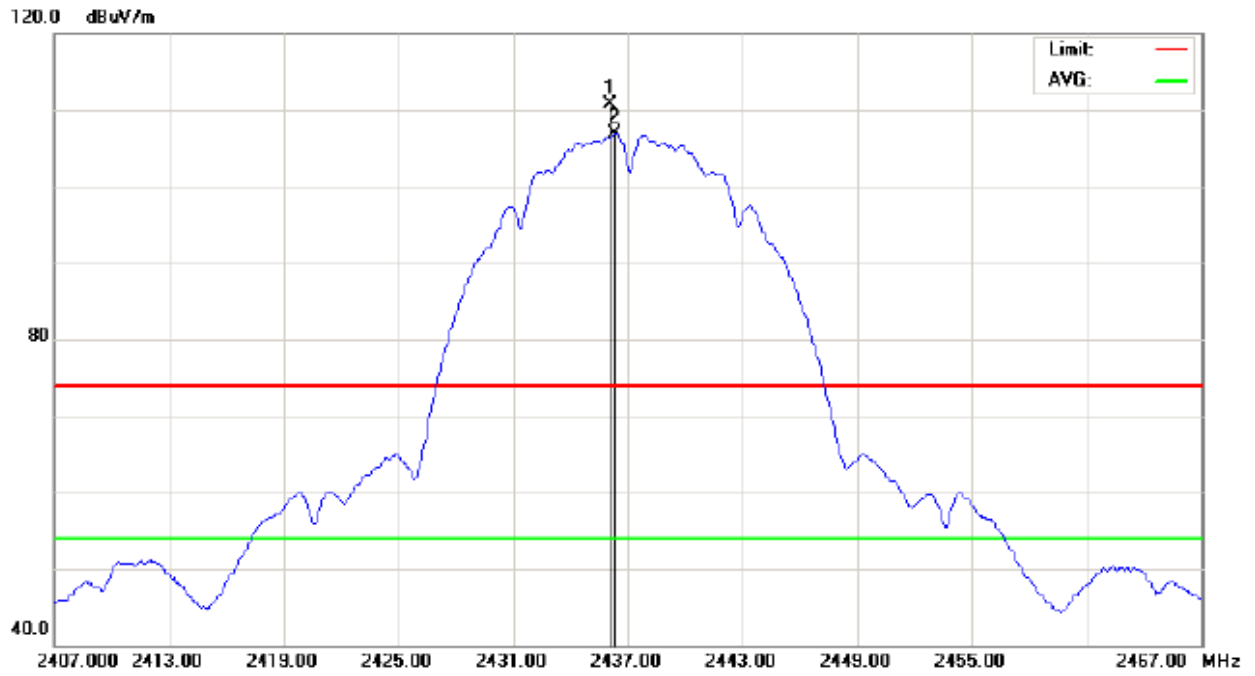

EUT :	802.11n High-speed Wireless Broadband Router	Model Name :	NW725
Temperature :	28 °C	Relative Humidity :	62%
Pressure :	1010 hPa	Test Voltage :	AC 120V/60Hz
Test Mode :	TX B MODE 20M-BW CHANNEL 2437MHz		

Freq.	Ant.Pol.	Reading		Ant./CF	Act.		Limit		Note
		Peak	AV		Peak	AV	Peak	AV	
(MHz)	H/V	(dBuV)	(dBuV)	CF(dB)	(dBuV/m)	(dBuV/m)	(dBuV/m)	(dBuV/m)	
2436.04	H	65.97	62.33	32.20	98.17	94.53			X/F
1808.40	H	47.81	39.15	-5.31	42.50	33.84	74.00	54.00	X/H
4874.04	H	51.16	41.21	3.72	54.88	44.93	74.00	54.00	X/H

Remark :

- (1) All readings are Peak unless otherwise stated QP in column of 『 Note 』 . Peak denotes that the Peak reading compliance with the QP Limits and then QP Mode measurement didn't perform .
- (2) Measuring frequency range from 30MHz to 1000MHz or the 10th harmonic of highest fundamental frequency . "F" denotes fundamental frequency ; "H" denotes spurious frequency . "E" denotes band edge frequency . (This judgment method includes the Band Edge Requirement.)
- (3) Radiated emissions measured in frequency range above 1000MHz were made with an instrument using Peak detector mode and AV detector mode of the emission .
- (4) Data of measurement within this frequency range shown " * " in the table above means the reading of emissions are attenuated more than 20dB below the permissible limits or the field strength is too small to be measured.
- (5) A preamp and high pass filter were used for this test in order to provide sufficient measurement sensitivity.
- (6) EUT Orthogonal Axis :
 "X" - denotes Laid on Table ; "Y" - denotes Vertical Stand ; "Z" - denotes Side Stand
- (7) During the measurements above 1 GHz it is taken care of that the EUT is always within the 3 dB cone of radiation BW of the used antenna

TX CH06 (Above 1000 MHz, Horizontal)

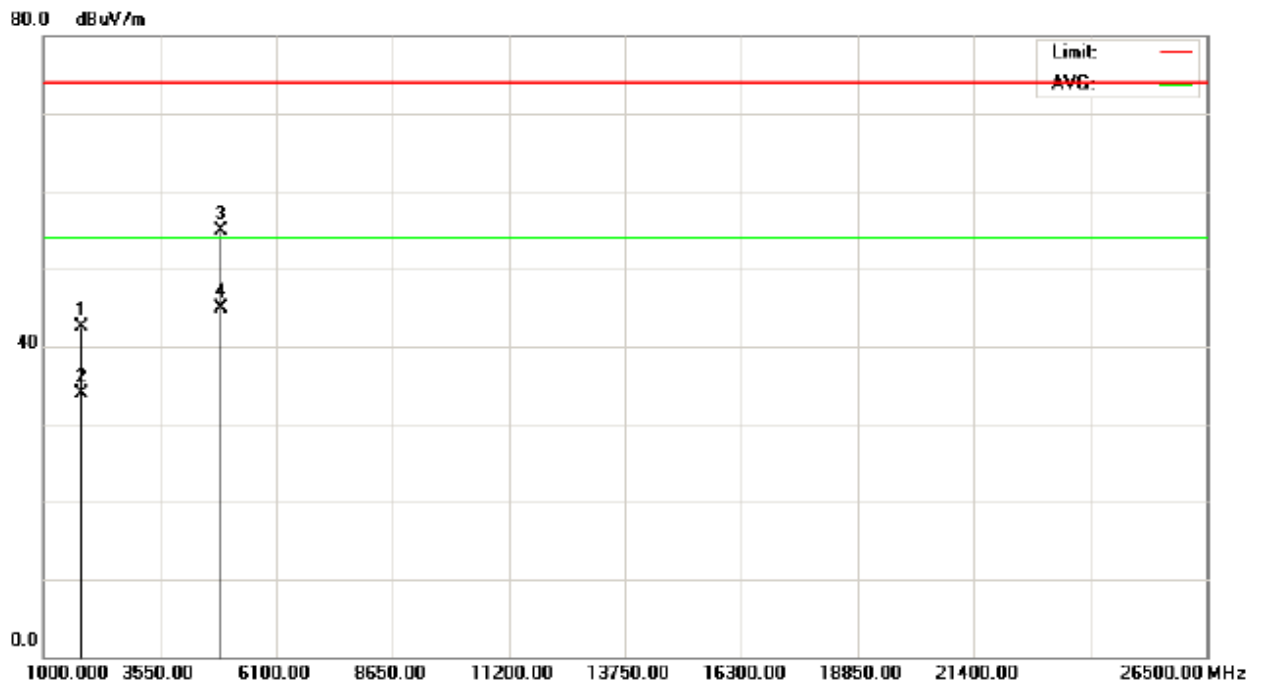
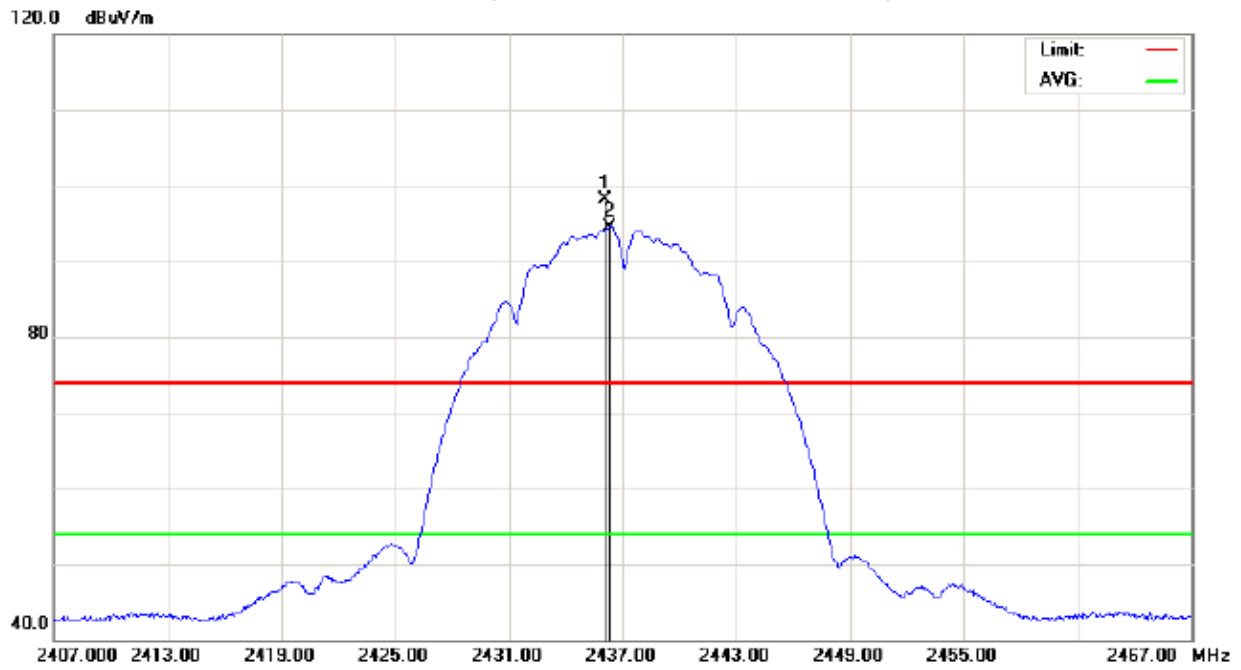

EUT :	802.11n High-speed Wireless Broadband Router	Model Name :	NW725
Temperature :	28 °C	Relative Humidity :	62%
Pressure :	1010 hPa	Test Voltage :	AC 120V/60Hz
Test Mode :	TX B MODE 20M-BW CHANNEL 2462MHz		

Freq.	Ant.Pol.	Reading		Ant./CF	Act.		Limit		Note
		Peak	AV		Peak	AV	Peak	AV	
(MHz)	H/V	(dBuV)	(dBuV)	CF(dB)	(dBuV/m)	(dBuV/m)	(dBuV/m)	(dBuV/m)	
2461.40	V	76.65	72.95	32.28	108.93	105.23			X/F
2483.50	V	25.26	15.76	32.35	57.61	48.11	74.00	54.00	X/E
1120.40	V	47.90	38.12	-8.92	38.98	29.20	74.00	54.00	X/H
4924.10	V	48.81	42.41	3.87	52.68	46.28	74.00	54.00	X/H

Remark :

- (1) All readings are Peak unless otherwise stated QP in column of 『Note』 . Peak denotes that the Peak reading compliance with the QP Limits and then QP Mode measurement didn't perform .
- (2) Measuring frequency range from 30MHz to 1000MHz or the 10th harmonic of highest fundamental frequency . "F" denotes fundamental frequency ; "H" denotes spurious frequency . "E" denotes band edge frequency . (This judgment method includes the Band Edge Requirement.)
- (3) Radiated emissions measured in frequency range above 1000MHz were made with an instrument using Peak detector mode and AV detector mode of the emission .
- (4) Data of measurement within this frequency range shown " * " in the table above means the reading of emissions are attenuated more than 20dB below the permissible limits or the field strength is too small to be measured.
- (5) A preamp and high pass filter were used for this test in order to provide sufficient measurement sensitivity.
- (6) EUT Orthogonal Axis :
 "X" - denotes Laid on Table ; "Y" - denotes Vertical Stand ; "Z" - denotes Side Stand
- (7) During the measurements above 1 GHz it is taken care of that the EUT is always within the 3 dB cone of radiation BW of the used antenna

TX CH11 (Above 1000 MHz, Vertical)

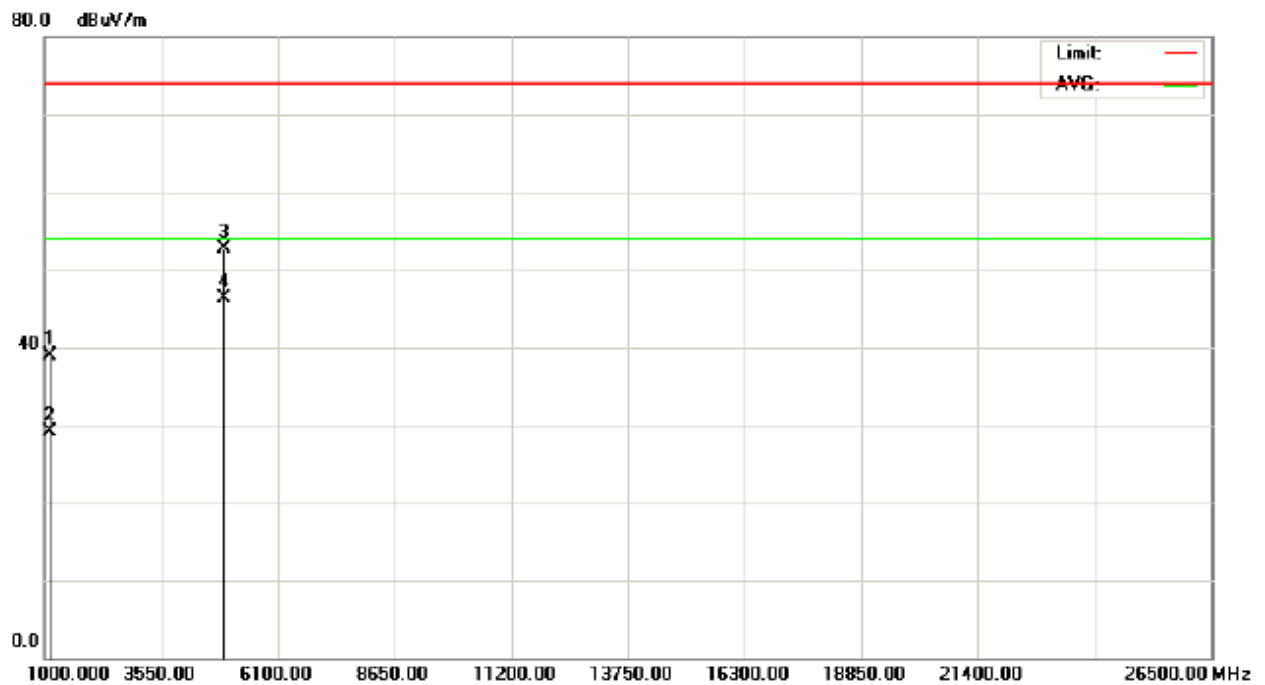
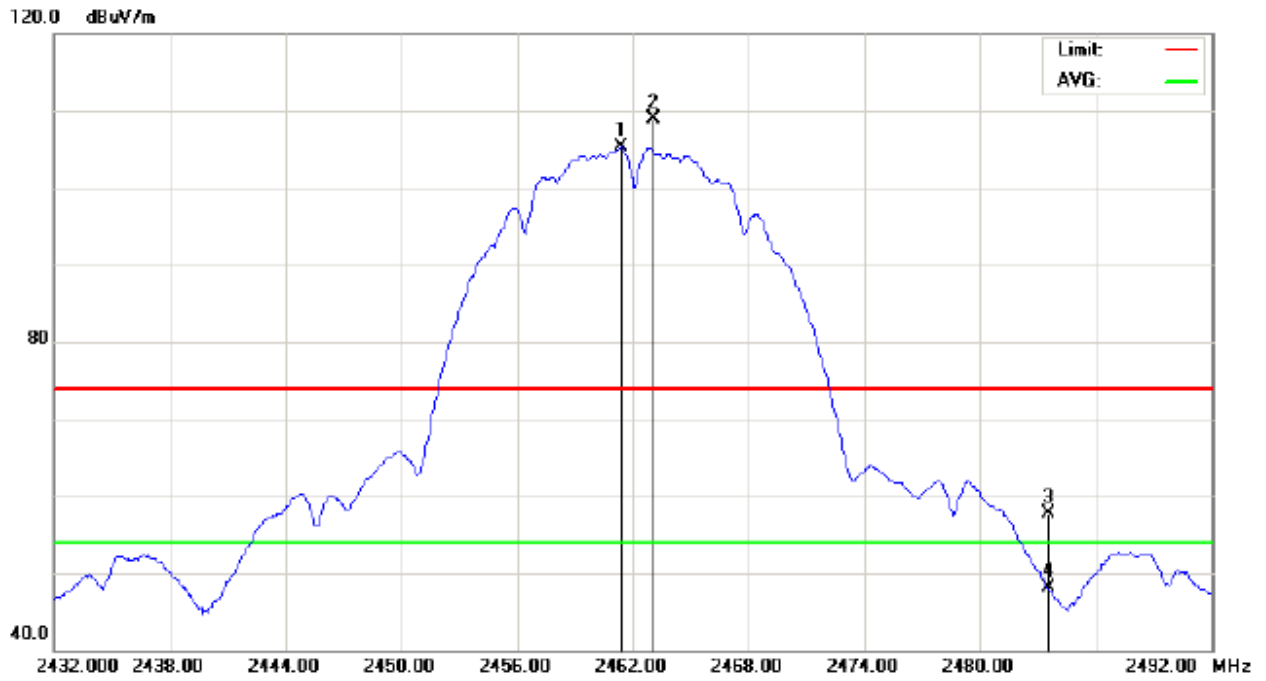

EUT :	802.11n High-speed Wireless Broadband Router	Model Name :	NW725
Temperature :	28 °C	Relative Humidity :	62%
Pressure :	1010 hPa	Test Voltage :	AC 120V/60Hz
Test Mode :	TX B MODE 20M-BW CHANNEL 2462MHz		

Freq. (MHz)	Ant.Pol. H/V	Reading		Ant./CF CF(dB)	Act.		Limit		Note
		Peak (dBuV)	AV (dBuV)		Peak (dBuV/m)	AV (dBuV/m)	Peak (dBuV/m)	AV (dBuV/m)	
2461.10	H	64.10	60.43	32.28	96.38	92.71			X/F
2483.50	H	22.54	11.08	32.35	54.89	43.43	74.00	54.00	X/E
1597.30	H	47.78	33.75	-6.54	41.24	27.23	74.00	54.00	X/H
4924.16	H	49.88	40.10	3.87	53.75	43.97	74.00	54.00	X/H

Remark :

- (1) All readings are Peak unless otherwise stated QP in column of 『 Note 』 . Peak denotes that the Peak reading compliance with the QP Limits and then QP Mode measurement didn't perform .
- (2) Measuring frequency range from 30MHz to 1000MHz or the 10th harmonic of highest fundamental frequency. "F" denotes fundamental frequency; "H" denotes spurious frequency. "E" denotes band edge frequency. (This judgment method includes the Band Edge Requirement.)
- (3) Radiated emissions measured in frequency range above 1000MHz were made with an instrument using Peak detector mode and AV detector mode of the emission .
- (4) Data of measurement within this frequency range shown " * " in the table above means the reading of emissions are attenuated more than 20dB below the permissible limits or the field strength is too small to be measured.
- (5) A preamp and high pass filter were used for this test in order to provide sufficient measurement sensitivity.
- (6) EUT Orthogonal Axis :
"X" - denotes Laid on Table ; "Y" - denotes Vertical Stand ; "Z" - denotes Side Stand
- (7) During the measurements above 1 GHz it is taken care of that the EUT is always within the 3 dB cone of radiation BW of the used antenna

TX CH11 (Above 1000 MHz, Horizontal)

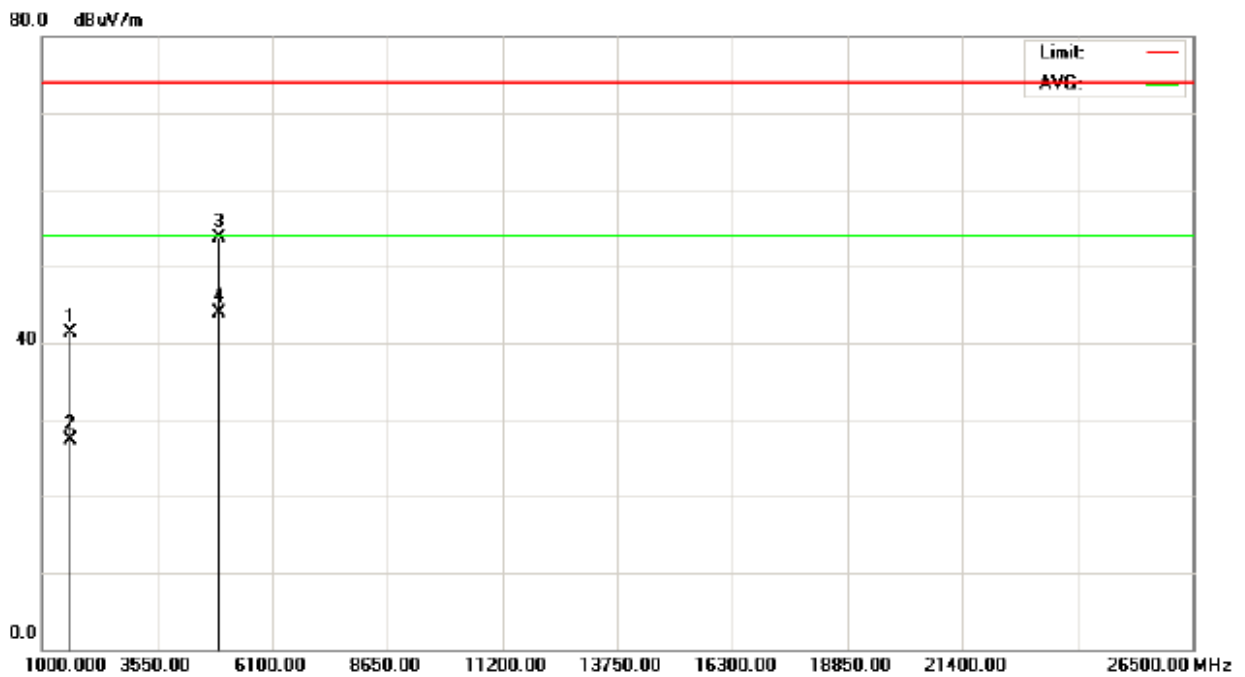
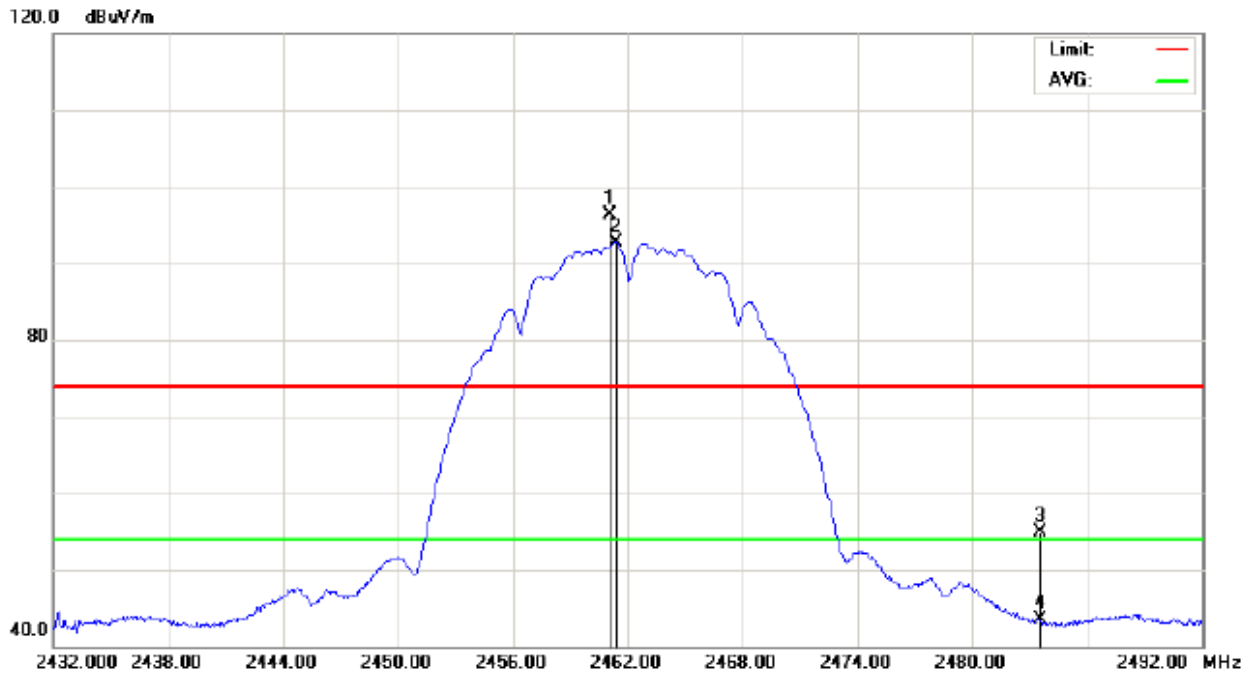

EUT :	802.11n High-speed Wireless Broadband Router	Model Name :	NW725
Temperature :	28 °C	Relative Humidity :	62%
Pressure :	1010 hPa	Test Voltage :	AC 120V/60Hz
Test Mode :	TX G MODE 20M-BW CHANNEL 2412MHz		

Freq. (MHz)	Ant.Pol. H/V	Reading		Ant./CF CF(dB)	Act.		Limit		Note
		Peak (dBuV)	AV (dBuV)		Peak (dBuV/m)	AV (dBuV/m)	Peak (dBuV/m)	AV (dBuV/m)	
2390.00	V	32.15	17.35	32.05	64.20	49.40	74.00	54.00	X/E
2415.00	V	76.97	67.88	32.13	109.10	100.01			X/F
1120.10	V	51.35	40.67	-8.92	42.43	31.75	74.00	54.00	X/H
4824.40	V	52.29	42.40	3.57	55.86	45.97	74.00	54.00	X/H

Remark :

- (1) All readings are Peak unless otherwise stated QP in column of 『Note』 . Peak denotes that the Peak reading compliance with the QP Limits and then QP Mode measurement didn't perform .
- (2) Measuring frequency range from 30MHz to 1000MHz or the 10th harmonic of highest fundamental frequency . "F" denotes fundamental frequency; "H" denotes spurious frequency. "E" denotes band edge frequency. (This judgment method includes the Band Edge Requirement.)
- (3) Radiated emissions measured in frequency range above 1000MHz were made with an instrument using Peak detector mode and AV detector mode of the emission .
- (4) Data of measurement within this frequency range shown " * " in the table above means the reading of emissions are attenuated more than 20dB below the permissible limits or the field strength is too small to be measured.
- (5) A preamp and high pass filter were used for this test in order to provide sufficient measurement sensitivity.
- (6) EUT Orthogonal Axis :
"X" - denotes Laid on Table ; "Y" - denotes Vertical Stand ; "Z" - denotes Side Stand
- (7) During the measurements above 1 GHz it is taken care of that the EUT is always within the 3 dB cone of radiation BW of the used antenna

TX CH01 (Above 1000 MHz, Vertical)

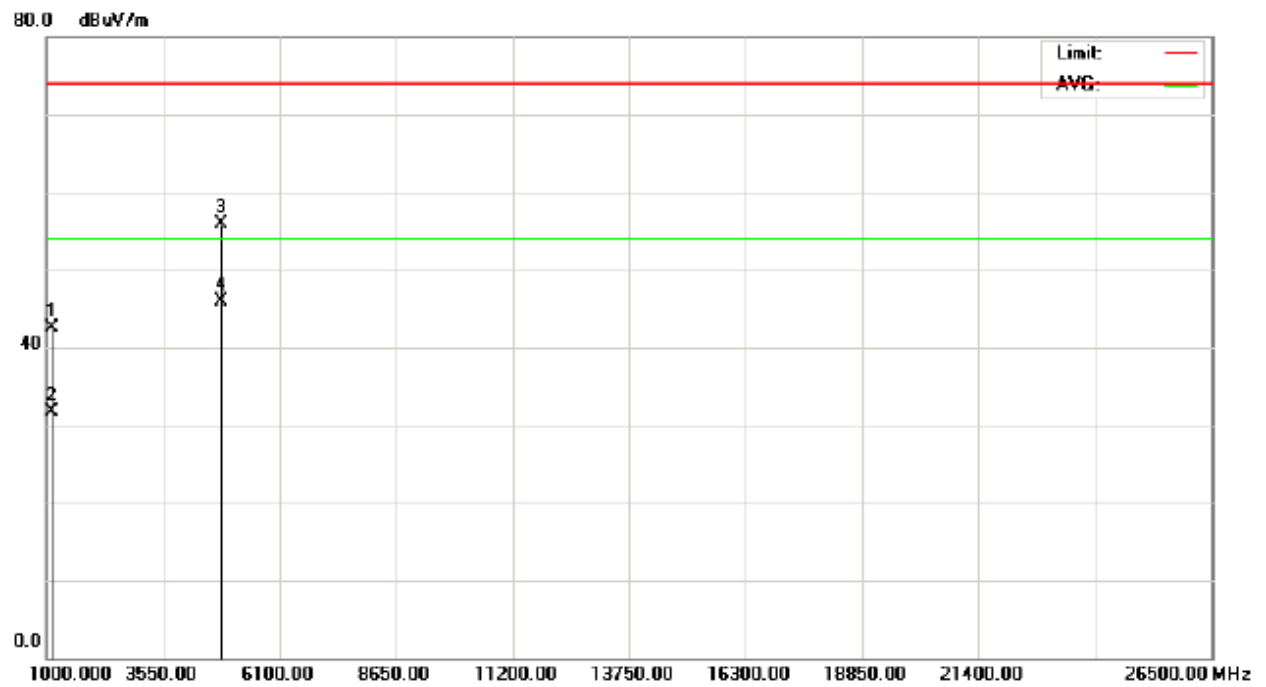
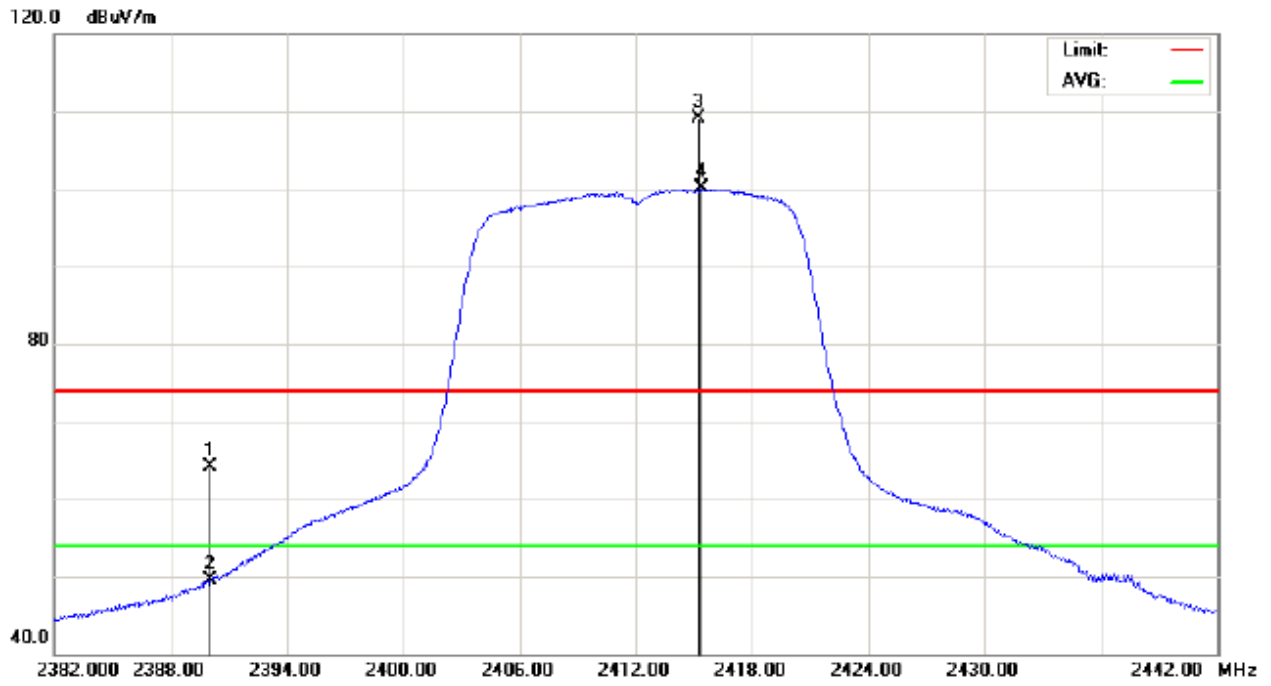

EUT :	802.11n High-speed Wireless Broadband Router	Model Name :	NW725
Temperature :	28 °C	Relative Humidity :	62%
Pressure :	1010 hPa	Test Voltage :	AC 120V/60Hz
Test Mode :	TX G MODE 20M-BW CHANNEL 2412MHz		

Freq. (MHz)	Ant.Pol. H/V	Reading		Ant./CF CF(dB)	Act.		Limit		Note
		Peak (dBuV)	AV (dBuV)		Peak (dBuV/m)	AV (dBuV/m)	Peak (dBuV/m)	AV (dBuV/m)	
2390.00	H	23.66	11.49	32.05	55.71	43.54	74.00	54.00	X/E
2415.24	H	63.76	54.63	32.13	95.89	86.76			X/F
1808.40	H	49.53	39.68	-5.31	44.22	34.37	74.00	54.00	X/H
4824.07	H	52.32	41.84	3.57	55.89	45.41	74.00	54.00	X/H

Remark :

- (1) All readings are Peak unless otherwise stated QP in column of 『 Note 』 . Peak denotes that the Peak reading compliance with the QP Limits and then QP Mode measurement didn't perform .
- (2) Measuring frequency range from 30MHz to 1000MHz or the 10th harmonic of highest fundamental frequency . "F" denotes fundamental frequency ; "H" denotes spurious frequency . "E" denotes band edge frequency . (This judgment method includes the Band Edge Requirement.)
- (3) Radiated emissions measured in frequency range above 1000MHz were made with an instrument using Peak detector mode and AV detector mode of the emission .
- (4) Data of measurement within this frequency range shown " * " in the table above means the reading of emissions are attenuated more than 20dB below the permissible limits or the field strength is too small to be measured.
- (5) A preamp and high pass filter were used for this test in order to provide sufficient measurement sensitivity.
- (6) EUT Orthogonal Axis :
"X" - denotes Laid on Table ; "Y" - denotes Vertical Stand ; "Z" - denotes Side Stand
- (7) During the measurements above 1 GHz it is taken care of that the EUT is always within the 3 dB cone of radiation BW of the used antenna

TX CH01 (Above 1000 MHz, Horizontal)

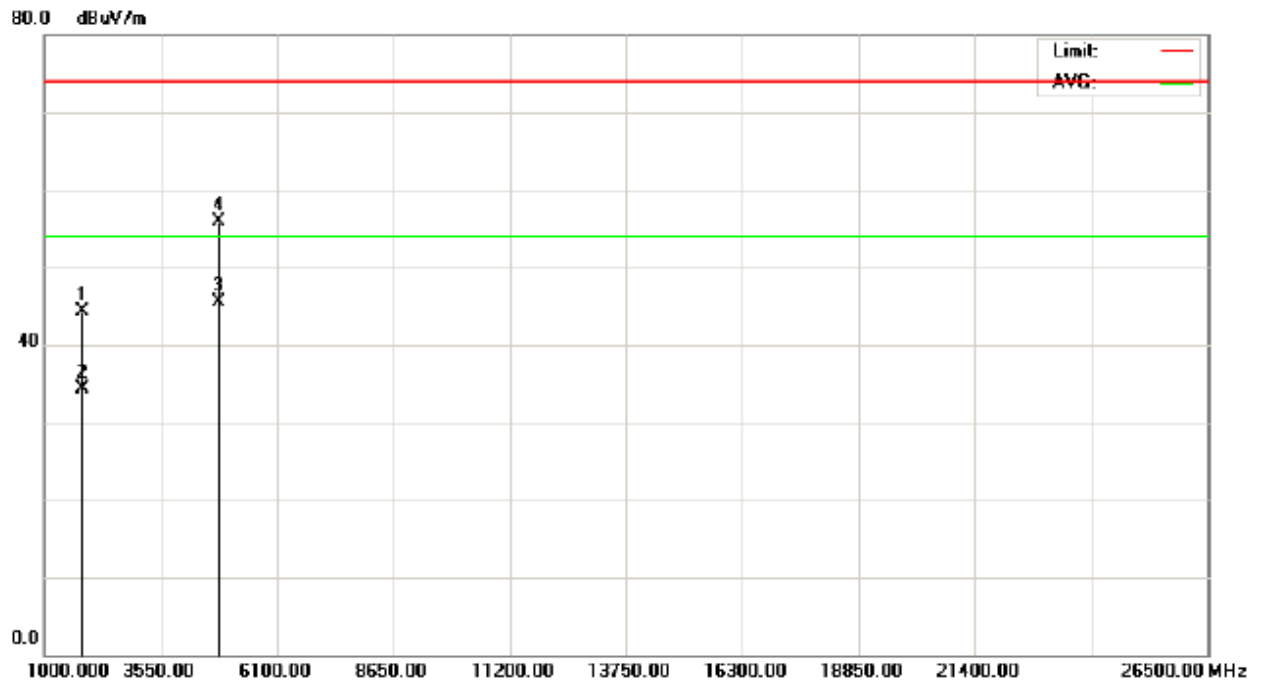
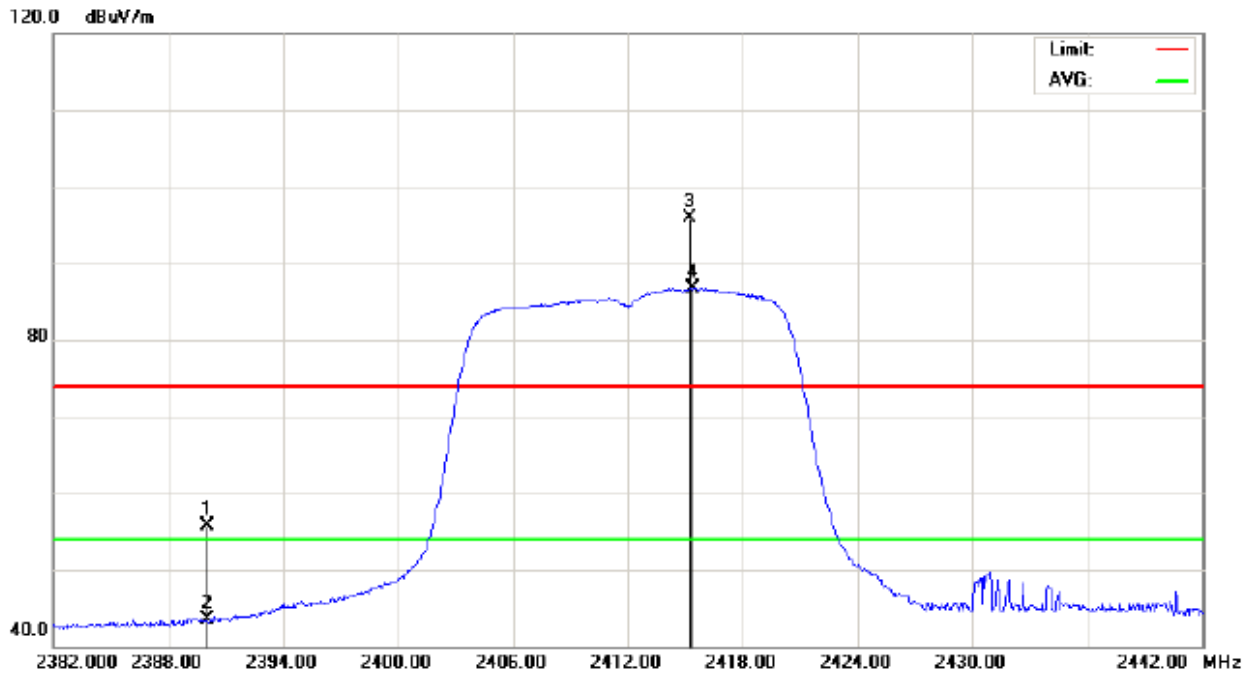

EUT :	802.11n High-speed Wireless Broadband Router	Model Name :	NW725
Temperature :	28 °C	Relative Humidity :	62%
Pressure :	1010 hPa	Test Voltage :	AC 120V/60Hz
Test Mode :	TX G MODE 20M-BW CHANNEL 2437MHz		

Freq. (MHz)	Ant.Pol. H/V	Reading		Ant./CF CF(dB)	Act.		Limit		Note
		Peak (dBuV)	AV (dBuV)		Peak (dBuV/m)	AV (dBuV/m)	Peak (dBuV/m)	AV (dBuV/m)	
2434.72	V	77.27	68.40	32.19	109.46	100.59			X/F
1120.70	V	51.20	40.28	-8.92	42.28	31.36	74.00	54.00	X/H
4874.00	V	51.51	42.10	3.72	55.23	45.82	74.00	54.00	X/H

Remark :

- (1) All readings are Peak unless otherwise stated QP in column of 『 Note 』 . Peak denotes that the Peak reading compliance with the QP Limits and then QP Mode measurement didn't perform .
- (2) Measuring frequency range from 30MHz to 1000MHz or the 10th harmonic of highest fundamental frequency. "F" denotes fundamental frequency; "H" denotes spurious frequency. "E" denotes band edge frequency. (This judgment method includes the Band Edge Requirement.)
- (3) Radiated emissions measured in frequency range above 1000MHz were made with an instrument using Peak detector mode and AV detector mode of the emission .
- (4) Data of measurement within this frequency range shown " * " in the table above means the reading of emissions are attenuated more than 20dB below the permissible limits or the field strength is too small to be measured.
- (5) A preamp and high pass filter were used for this test in order to provide sufficient measurement sensitivity.
- (6) EUT Orthogonal Axis :
"X" - denotes Laid on Table ; "Y" - denotes Vertical Stand ; "Z" - denotes Side Stand
- (7) During the measurements above 1 GHz it is taken care of that the EUT is always within the 3 dB cone of radiation BW of the used antenna

TX CH06 (Above 1000 MHz, Vertical)

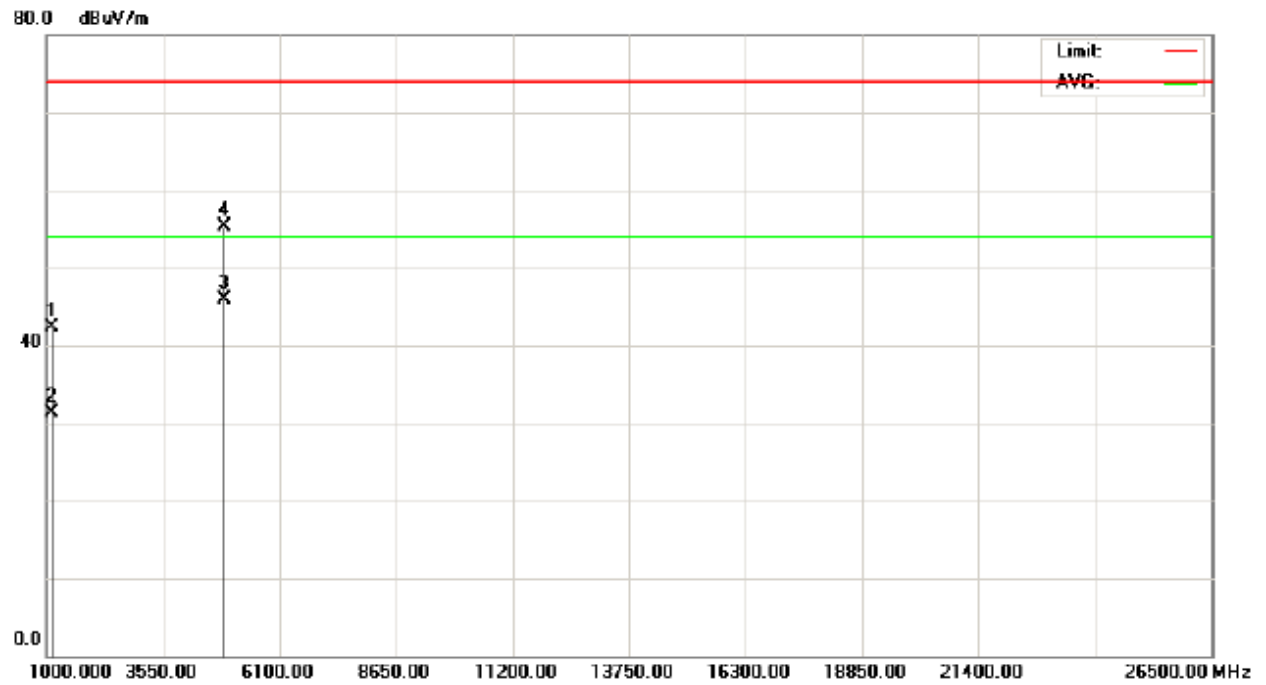
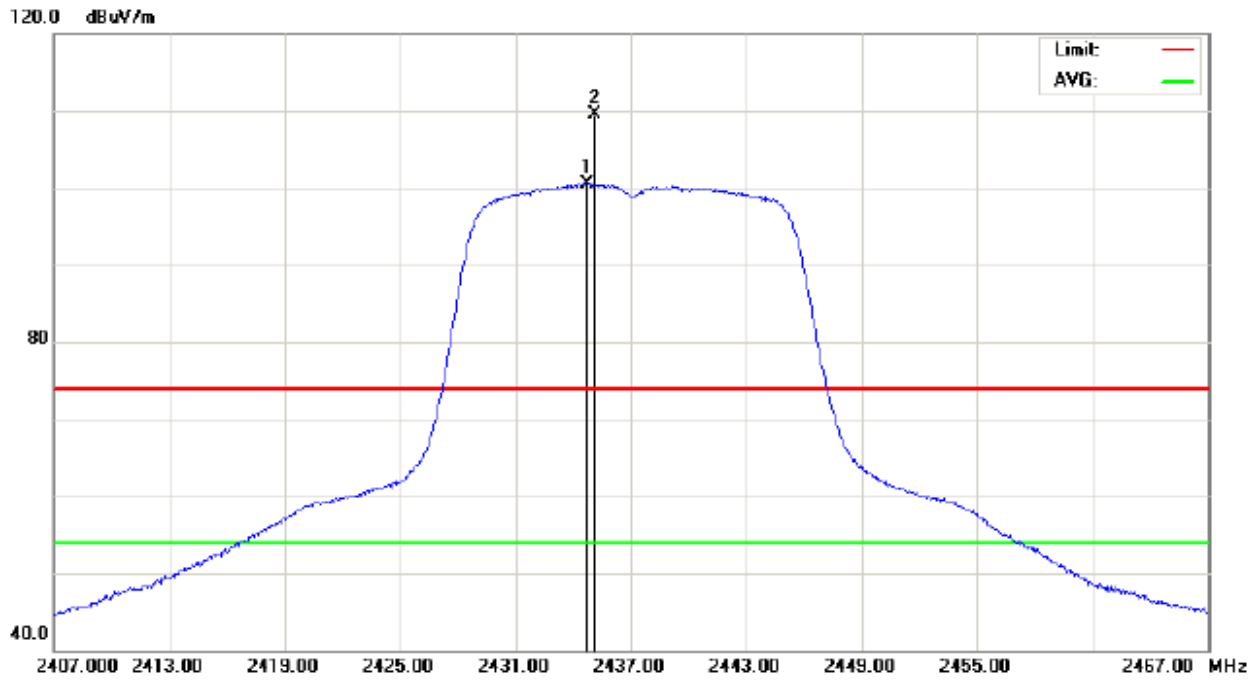

EUT :	802.11n High-speed Wireless Broadband Router	Model Name :	NW725
Temperature :	28 °C	Relative Humidity :	62%
Pressure :	1010 hPa	Test Voltage :	AC 120V/60Hz
Test Mode :	TX G MODE 20M-BW CHANNEL 2437MHz		

Freq.	Ant.Pol.	Reading		Ant./CF	Act.		Limit		Note
		Peak	AV		Peak	AV	Peak	AV	
(MHz)	H/V	(dBuV)	(dBuV)	CF(dB)	(dBuV/m)	(dBuV/m)	(dBuV/m)	(dBuV/m)	
2433.82	H	63.96	55.59	32.19	96.15	87.78			X/F
1809.20	H	48.21	40.10	-5.31	42.90	34.79	74.00	54.00	X/H
4874.04	H	50.35	40.67	3.72	54.07	44.39	74.00	54.00	X/H

Remark :

- (1) All readings are Peak unless otherwise stated QP in column of 『 Note 』 . Peak denotes that the Peak reading compliance with the QP Limits and then QP Mode measurement didn't perform .
- (2) Measuring frequency range from 30MHz to 1000MHz or the 10th harmonic of highest fundamental frequency . "F" denotes fundamental frequency ; "H" denotes spurious frequency . "E" denotes band edge frequency . (This judgment method includes the Band Edge Requirement.)
- (3) Radiated emissions measured in frequency range above 1000MHz were made with an instrument using Peak detector mode and AV detector mode of the emission .
- (4) Data of measurement within this frequency range shown " * " in the table above means the reading of emissions are attenuated more than 20dB below the permissible limits or the field strength is too small to be measured.
- (5) A preamp and high pass filter were used for this test in order to provide sufficient measurement sensitivity.
- (6) EUT Orthogonal Axis :
 "X" - denotes Laid on Table ; "Y" - denotes Vertical Stand ; "Z" - denotes Side Stand
- (7) During the measurements above 1 GHz it is taken care of that the EUT is always within the 3 dB cone of radiation BW of the used antenna

TX CH06 (Above 1000 MHz, Horizontal)

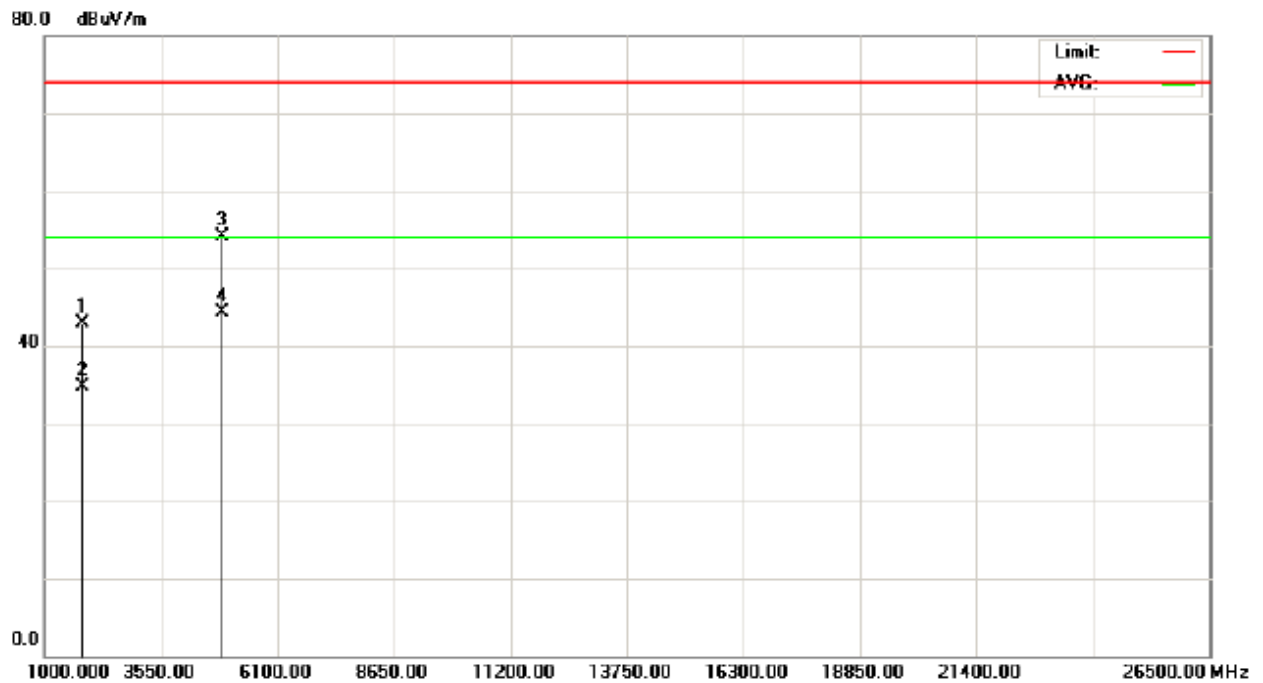
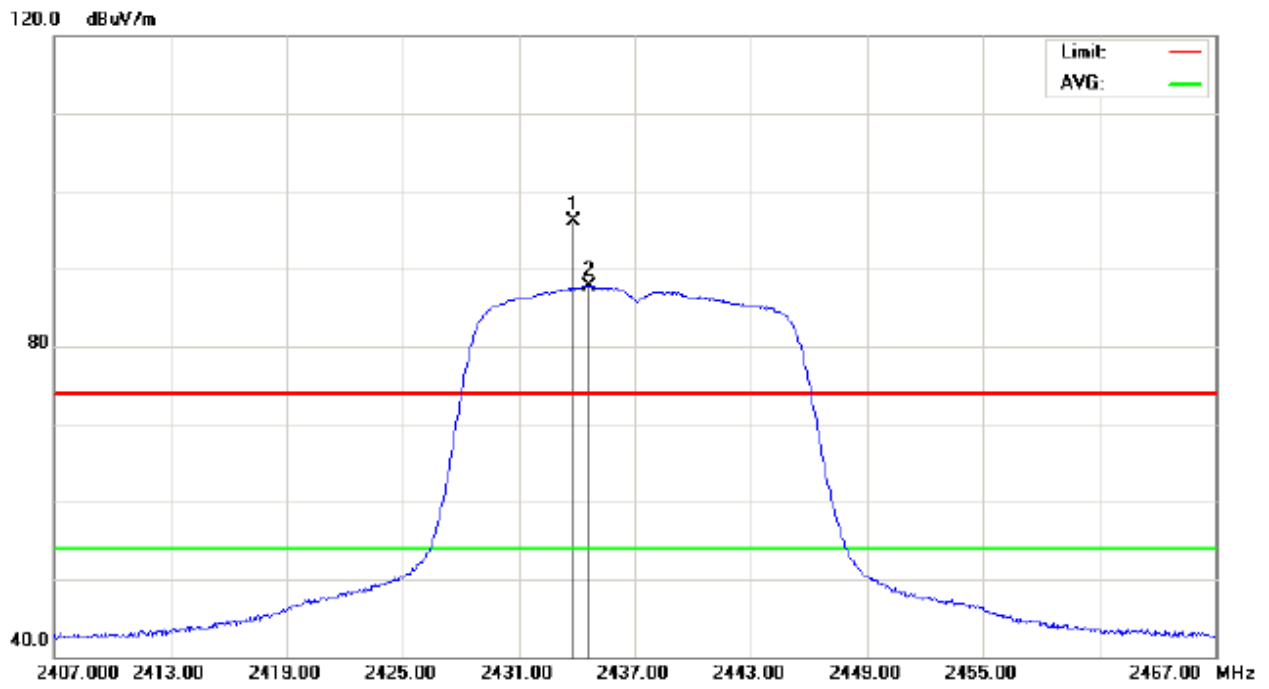

EUT :	802.11n High-speed Wireless Broadband Router	Model Name :	NW725
Temperature :	28 °C	Relative Humidity :	62%
Pressure :	1010 hPa	Test Voltage :	AC 120V/60Hz
Test Mode :	TX G MODE 20M-BW CHANNEL 2462MHz		

Freq.	Ant.Pol.	Reading		Ant./CF	Act.		Limit		Note
		Peak	AV		Peak	AV	Peak	AV	
(MHz)	H/V	(dBuV)	(dBuV)	CF(dB)	(dBuV/m)	(dBuV/m)	(dBuV/m)	(dBuV/m)	
2458.76	V	74.41	65.35	32.27	106.68	97.62			X/F
2483.50	V	34.45	20.19	32.35	66.80	52.54	74.00	54.00	X/E
1120.60	V	49.80	40.20	-8.92	40.88	31.28	74.00	54.00	X/H
4924.11	V	49.59	41.29	3.87	53.46	45.16	74.00	54.00	X/H

Remark :

- (1) All readings are Peak unless otherwise stated QP in column of 『 Note 』 . Peak denotes that the Peak reading compliance with the QP Limits and then QP Mode measurement didn't perform .
- (2) Measuring frequency range from 30MHz to 1000MHz or the 10th harmonic of highest fundamental frequency . "F" denotes fundamental frequency; "H" denotes spurious frequency. "E" denotes band edge frequency. (This judgment method includes the Band Edge Requirement.)
- (3) Radiated emissions measured in frequency range above 1000MHz were made with an instrument using Peak detector mode and AV detector mode of the emission .
- (4) Data of measurement within this frequency range shown " * " in the table above means the reading of emissions are attenuated more than 20dB below the permissible limits or the field strength is too small to be measured.
- (5) A preamp and high pass filter were used for this test in order to provide sufficient measurement sensitivity.
- (6) EUT Orthogonal Axis :
 "X" - denotes Laid on Table ; "Y" - denotes Vertical Stand ; "Z" - denotes Side Stand
- (7) During the measurements above 1 GHz it is taken care of that the EUT is always within the 3 dB cone of radiation BW of the used antenna

TX CH11 (Above 1000 MHz, Vertical)

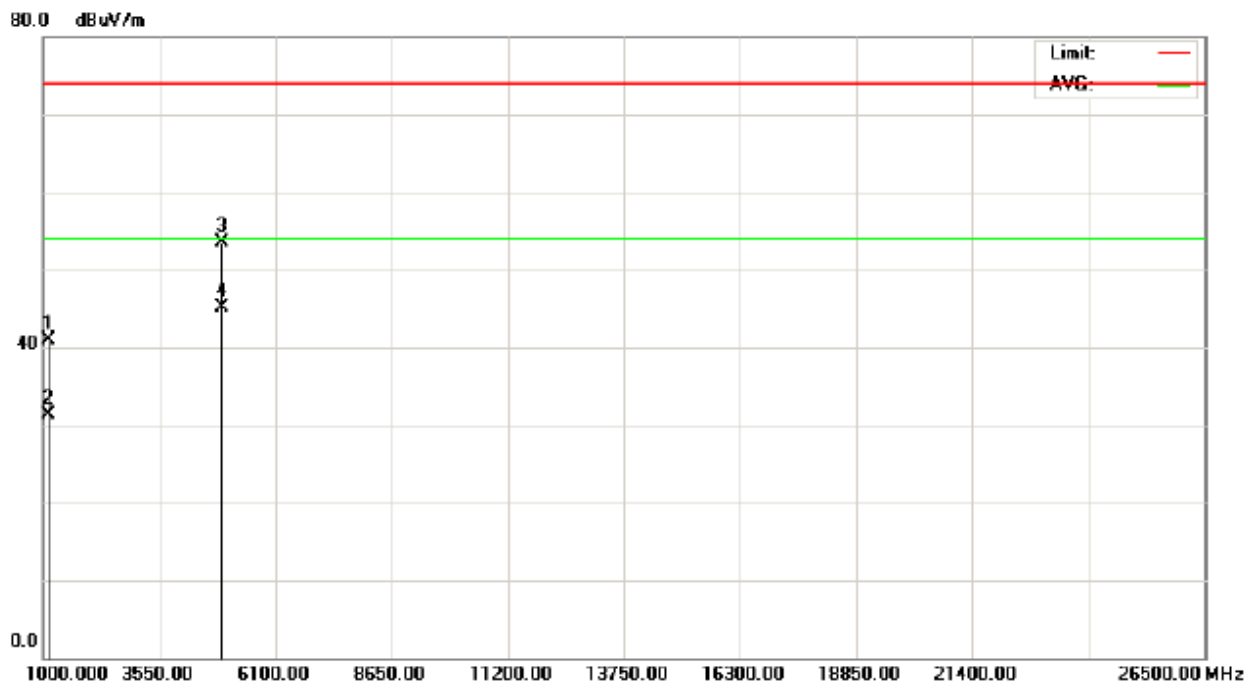
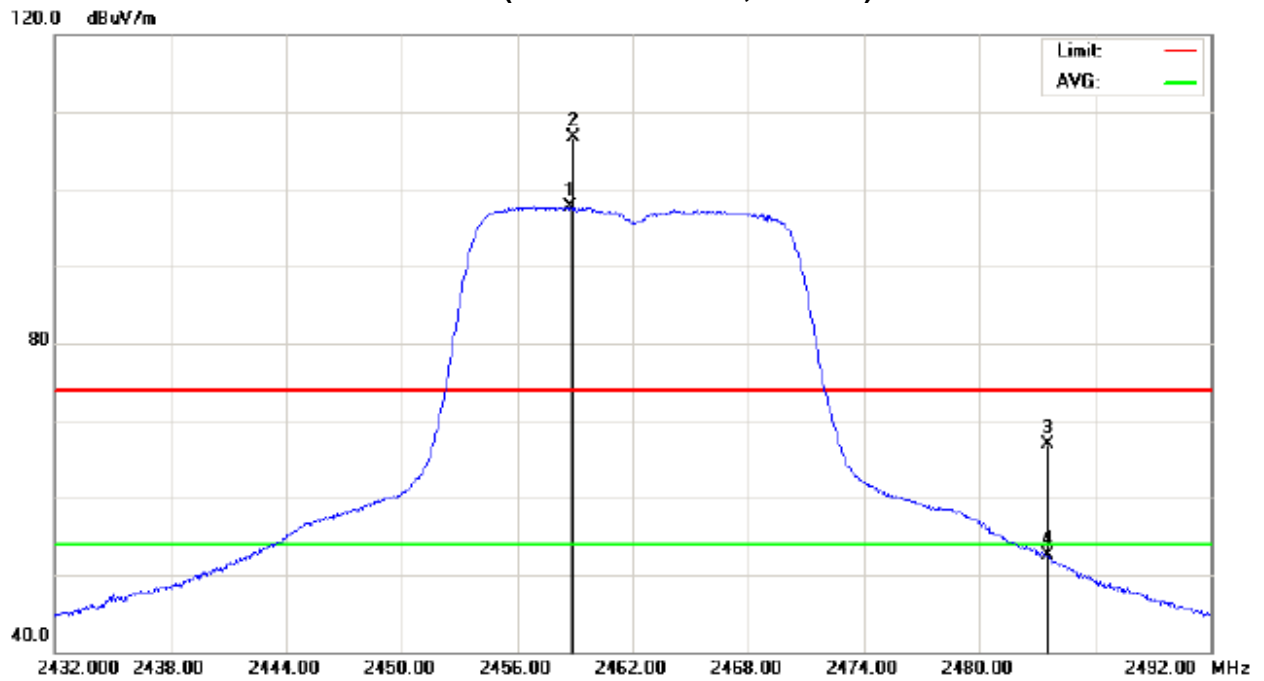

EUT :	802.11n High-speed Wireless Broadband Router	Model Name :	NW725
Temperature :	28 °C	Relative Humidity :	62%
Pressure :	1010 hPa	Test Voltage :	AC 120V/60Hz
Test Mode :	TX G MODE 20M-BW CHANNEL 2462MHz		

Freq. (MHz)	Ant.Pol. H/V	Reading		Ant./CF CF(dB)	Act.		Limit		Note
		Peak (dBuV)	AV (dBuV)		Peak (dBuV/m)	AV (dBuV/m)	Peak (dBuV/m)	AV (dBuV/m)	
2468.54	H	63.05	53.99	32.30	95.35	86.29			X/F
2483.50	H	24.47	12.00	32.35	56.82	44.35	74.00	54.00	X/E
1120.20	H	50.24	38.63	-8.92	41.32	29.71	74.00	54.00	X/H
4924.09	H	51.31	40.95	3.87	55.18	44.82	74.00	54.00	X/H

Remark :

- (1) All readings are Peak unless otherwise stated QP in column of 『 Note 』 . Peak denotes that the Peak reading compliance with the QP Limits and then QP Mode measurement didn't perform .
- (2) Measuring frequency range from 30MHz to 1000MHz or the 10th harmonic of highest fundamental frequency. "F" denotes fundamental frequency; "H" denotes spurious frequency. "E" denotes band edge frequency. (This judgment method includes the Band Edge Requirement.)
- (3) Radiated emissions measured in frequency range above 1000MHz were made with an instrument using Peak detector mode and AV detector mode of the emission .
- (4) Data of measurement within this frequency range shown " * " in the table above means the reading of emissions are attenuated more than 20dB below the permissible limits or the field strength is too small to be measured.
- (5) A preamp and high pass filter were used for this test in order to provide sufficient measurement sensitivity.
- (6) EUT Orthogonal Axis :
"X" - denotes Laid on Table ; "Y" - denotes Vertical Stand ; "Z" - denotes Side Stand
- (7) During the measurements above 1 GHz it is taken care of that the EUT is always within the 3 dB cone of radiation BW of the used antenna

TX CH11 (Above 1000 MHz, Horizontal)

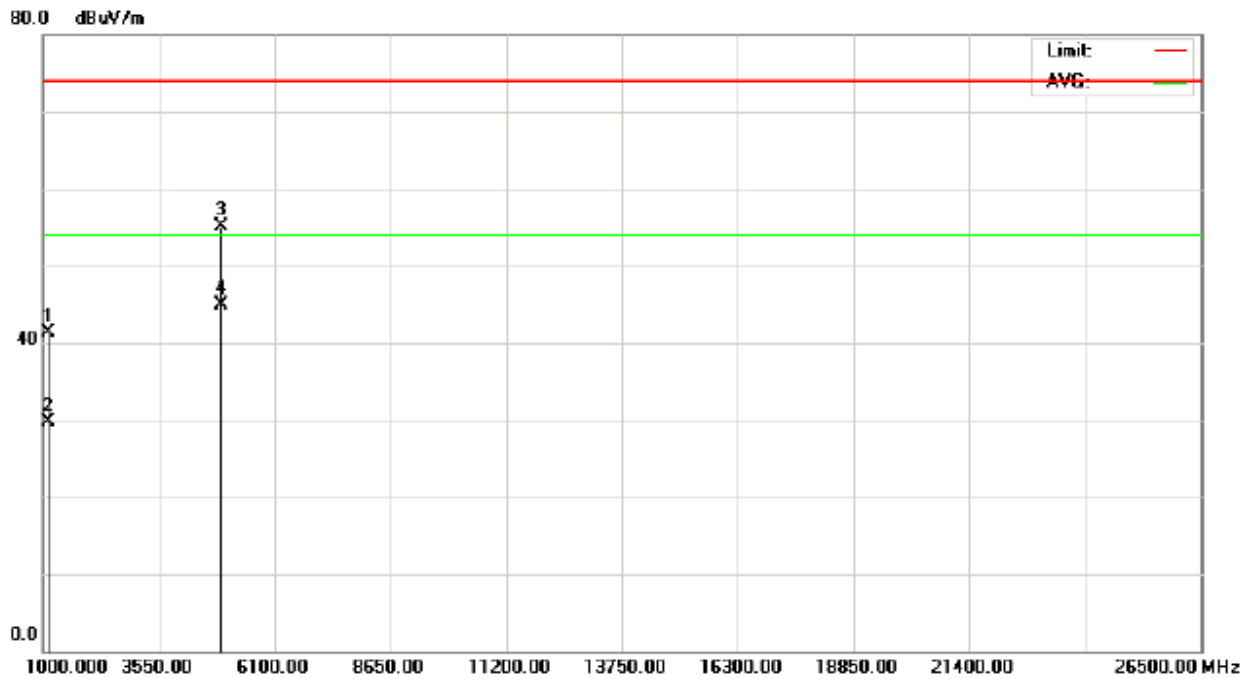
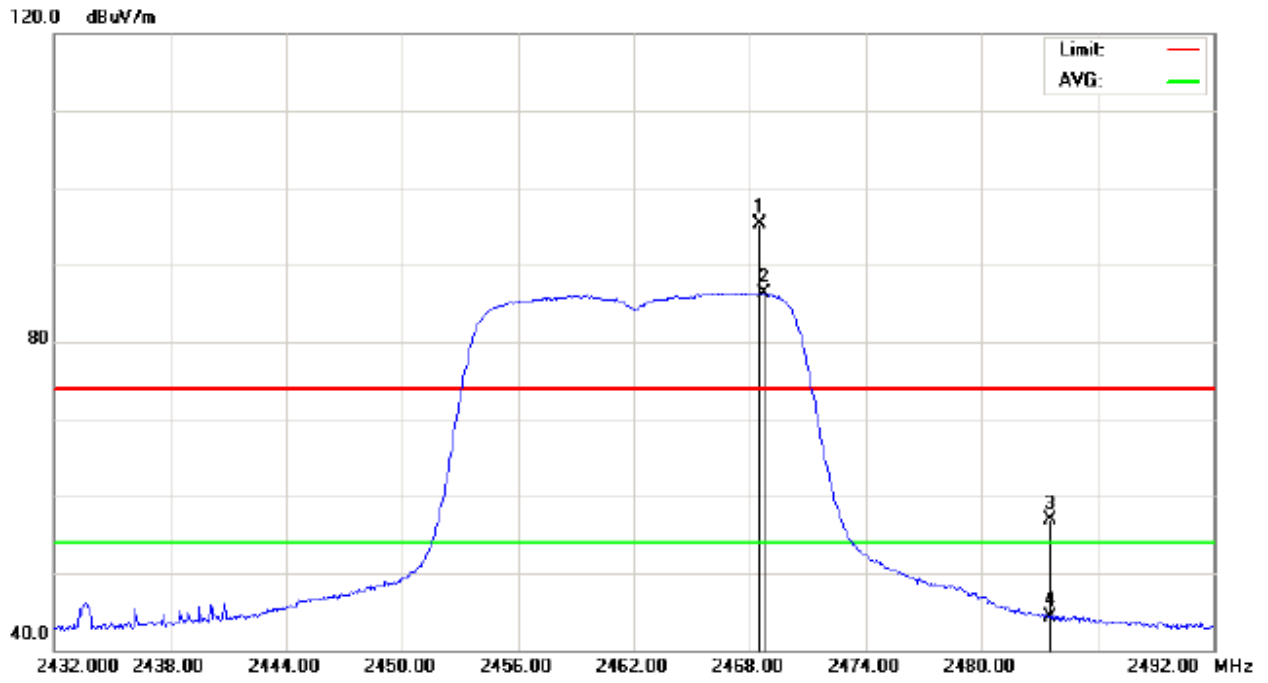

EUT :	802.11n High-speed Wireless Broadband Router	Model Name :	NW725
Temperature :	28 °C	Relative Humidity :	62%
Pressure :	1010 hPa	Test Voltage :	AC 120V/60Hz
Test Mode :	TX N MODE 20M-BW CHANNEL 2412MHz (Antenna A+C)		

Freq. (MHz)	Ant.Pol. H/V	Reading		Ant./CF CF(dB)	Act.		Limit		Note
		Peak (dBuV)	AV (dBuV)		Peak (dBuV/m)	AV (dBuV/m)	Peak (dBuV/m)	AV (dBuV/m)	
2390.00	V	33.47	18.58	32.05	65.52	50.63	74.00	54.00	X/E
2407.38	V	77.66	68.56	32.10	109.76	100.67			X/F
1120.30	V	53.02	42.41	-8.92	44.10	33.49	74.00	54.00	X/H
4824.50	V	51.02	40.34	3.57	54.59	43.91	74.00	54.00	X/H

Remark :

- (1) All readings are Peak unless otherwise stated QP in column of 『Note』 . Peak denotes that the Peak reading compliance with the QP Limits and then QP Mode measurement didn't perform .
- (2) Measuring frequency range from 30MHz to 1000MHz or the 10th harmonic of highest fundamental frequency . "F" denotes fundamental frequency ; "H" denotes spurious frequency . "E" denotes band edge frequency . (This judgment method includes the Band Edge Requirement.)
- (3) Radiated emissions measured in frequency range above 1000MHz were made with an instrument using Peak detector mode and AV detector mode of the emission .
- (4) Data of measurement within this frequency range shown " * " in the table above means the reading of emissions are attenuated more than 20dB below the permissible limits or the field strength is too small to be measured.
- (5) A preamp and high pass filter were used for this test in order to provide sufficient measurement sensitivity.
- (6) EUT Orthogonal Axis :
"X" - denotes Laid on Table ; "Y" - denotes Vertical Stand ; "Z" - denotes Side Stand
- (7) During the measurements above 1 GHz it is taken care of that the EUT is always within the 3 dB cone of radiation BW of the used antenna

TX CH01 (Above 1000 MHz, Vertical)

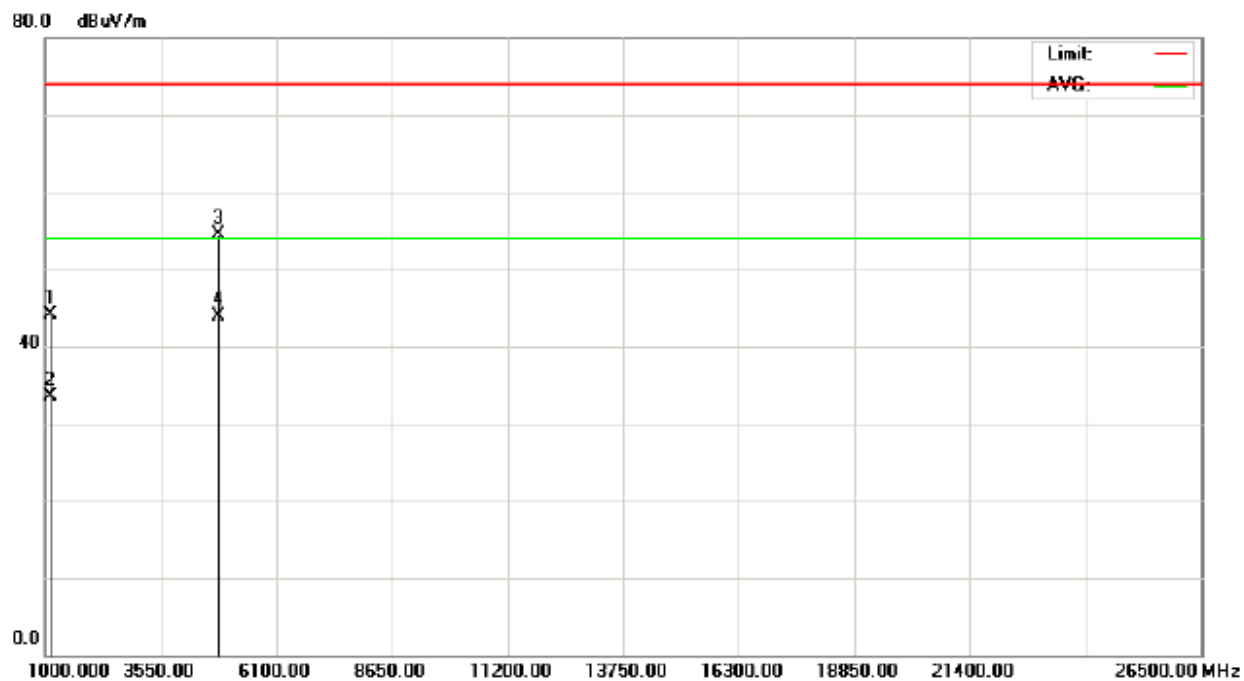
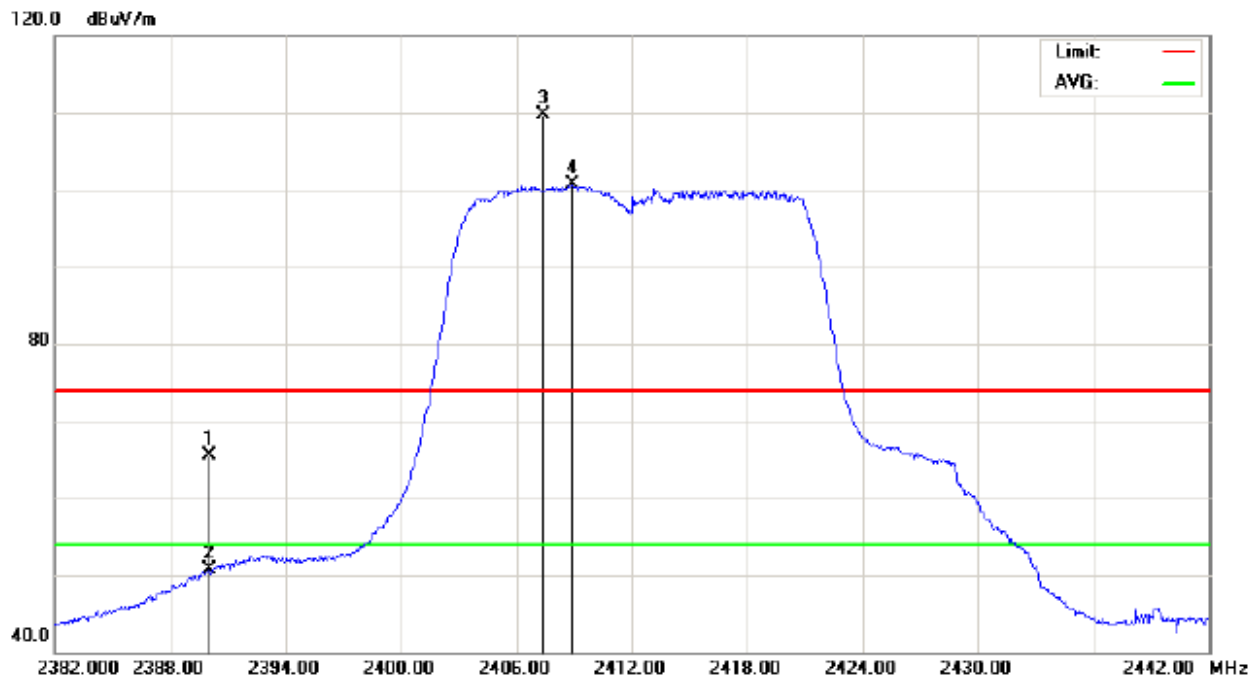

EUT :	802.11n High-speed Wireless Broadband Router	Model Name :	NW725
Temperature :	28 °C	Relative Humidity :	62%
Pressure :	1010 hPa	Test Voltage :	AC 120V/60Hz
Test Mode :	TX N MODE 20M-BW CHANNEL 2412MH (Antenna A+C)		

Freq. (MHz)	Ant.Pol. H/V	Reading		Ant./CF CF(dB)	Act.		Limit		Note
		Peak (dBuV)	AV (dBuV)		Peak (dBuV/m)	AV (dBuV/m)	Peak (dBuV/m)	AV (dBuV/m)	
2390.00	H	21.62	11.52	32.05	53.67	43.57	74.00	54.00	X/E
2415.18	H	67.78	58.29	32.13	99.91	90.42			X/F
1808.40	H	48.69	40.12	-5.31	43.38	34.81	74.00	54.00	X/H
4824.09	H	52.97	42.32	3.57	56.54	45.89	74.00	54.00	X/H

Remark :

- (1) All readings are Peak unless otherwise stated QP in column of 『Note』 . Peak denotes that the Peak reading compliance with the QP Limits and then QP Mode measurement didn't perform .
- (2) Measuring frequency range from 30MHz to 1000MHz or the 10th harmonic of highest fundamental frequency . "F" denotes fundamental frequency; "H" denotes spurious frequency. "E" denotes band edge frequency. (This judgment method includes the Band Edge Requirement.)
- (3) Radiated emissions measured in frequency range above 1000MHz were made with an instrument using Peak detector mode and AV detector mode of the emission .
- (4) Data of measurement within this frequency range shown " * " in the table above means the reading of emissions are attenuated more than 20dB below the permissible limits or the field strength is too small to be measured.
- (5) A preamp and high pass filter were used for this test in order to provide sufficient measurement sensitivity.
- (6) EUT Orthogonal Axis :
"X" - denotes Laid on Table ; "Y" - denotes Vertical Stand ; "Z" - denotes Side Stand
- (7) During the measurements above 1 GHz it is taken care of that the EUT is always within the 3 dB cone of radiation BW of the used antenna

TX CH01 (Above 1000 MHz, Horizontal)

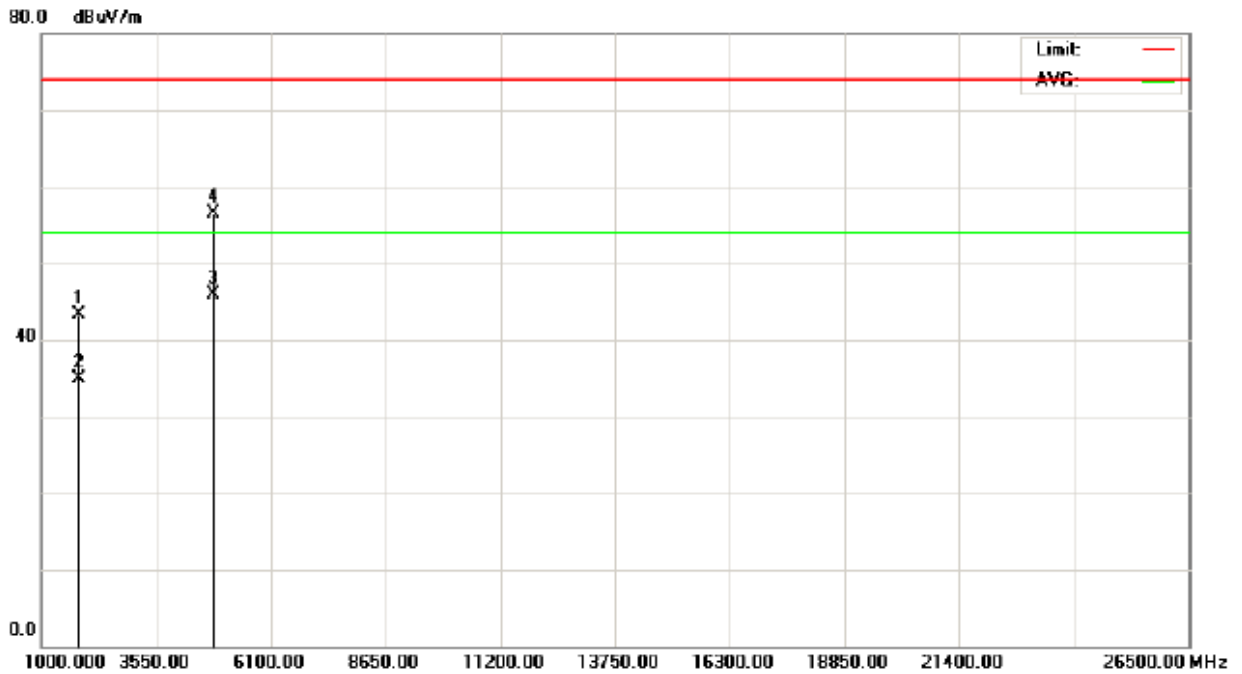
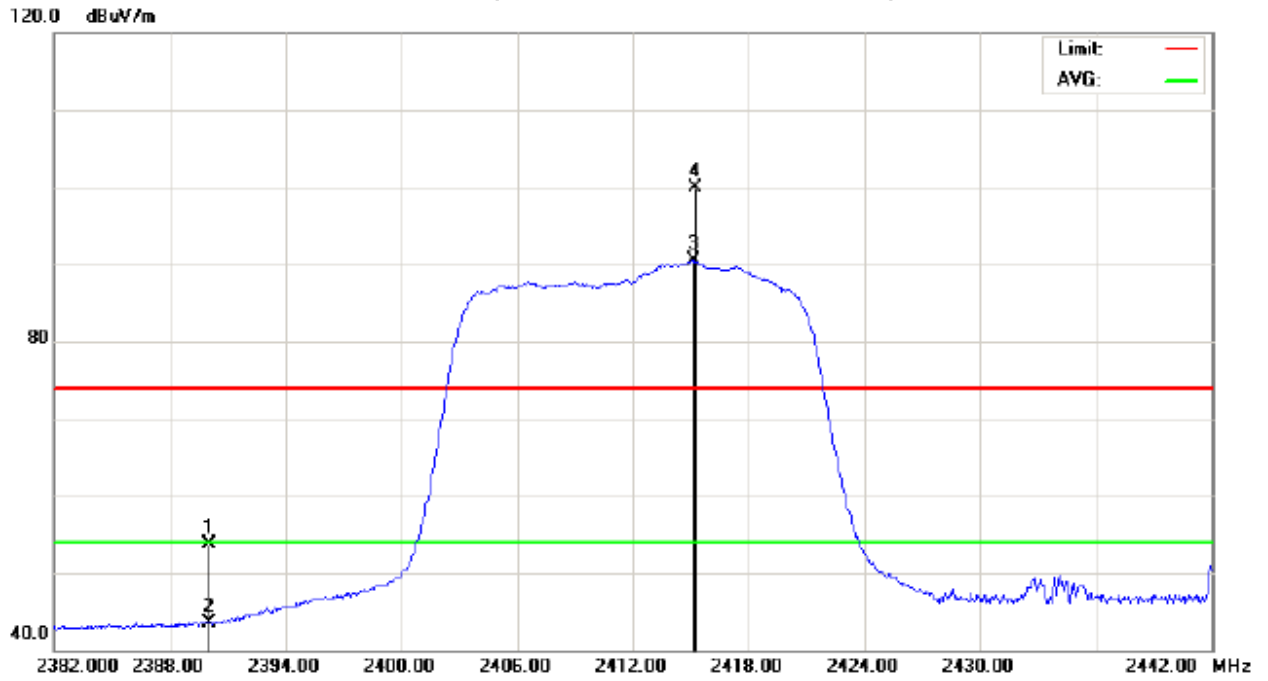

EUT :	802.11n High-speed Wireless Broadband Router	Model Name :	NW725
Temperature :	28 °C	Relative Humidity :	62%
Pressure :	1010 hPa	Test Voltage :	AC 120V/60Hz
Test Mode :	TX N MODE 20M-BW CHANNEL 2437MHz (Antenna A+C)		

Freq. (MHz)	Ant.Pol. H/V	Reading		Ant./CF CF(dB)	Act.		Limit		Note
		Peak (dBuV)	AV (dBuV)		Peak (dBuV/m)	AV (dBuV/m)	Peak (dBuV/m)	AV (dBuV/m)	
2438.80	V	79.06	69.92	32.20	111.26	102.13			X/F
1120.40	V	51.19	40.22	-8.92	42.27	31.30	74.00	54.00	X/H
4874.06	V	51.19	43.64	3.72	54.91	47.36	74.00	54.00	X/H

Remark :

- (1) All readings are Peak unless otherwise stated QP in column of 『 Note 』 . Peak denotes that the Peak reading compliance with the QP Limits and then QP Mode measurement didn't perform .
- (2) Measuring frequency range from 30MHz to 1000MHz or the 10th harmonic of highest fundamental frequency. "F" denotes fundamental frequency; "H" denotes spurious frequency. "E" denotes band edge frequency. (This judgment method includes the Band Edge Requirement.)
- (3) Radiated emissions measured in frequency range above 1000MHz were made with an instrument using Peak detector mode and AV detector mode of the emission .
- (4) Data of measurement within this frequency range shown " * " in the table above means the reading of emissions are attenuated more than 20dB below the permissible limits or the field strength is too small to be measured.
- (5) A preamp and high pass filter were used for this test in order to provide sufficient measurement sensitivity.
- (6) EUT Orthogonal Axis :
"X" - denotes Laid on Table ; "Y" - denotes Vertical Stand ; "Z" - denotes Side Stand
- (7) During the measurements above 1 GHz it is taken care of that the EUT is always within the 3 dB cone of radiation BW of the used antenna

TX CH06 (Above 1000 MHz, Vertical)

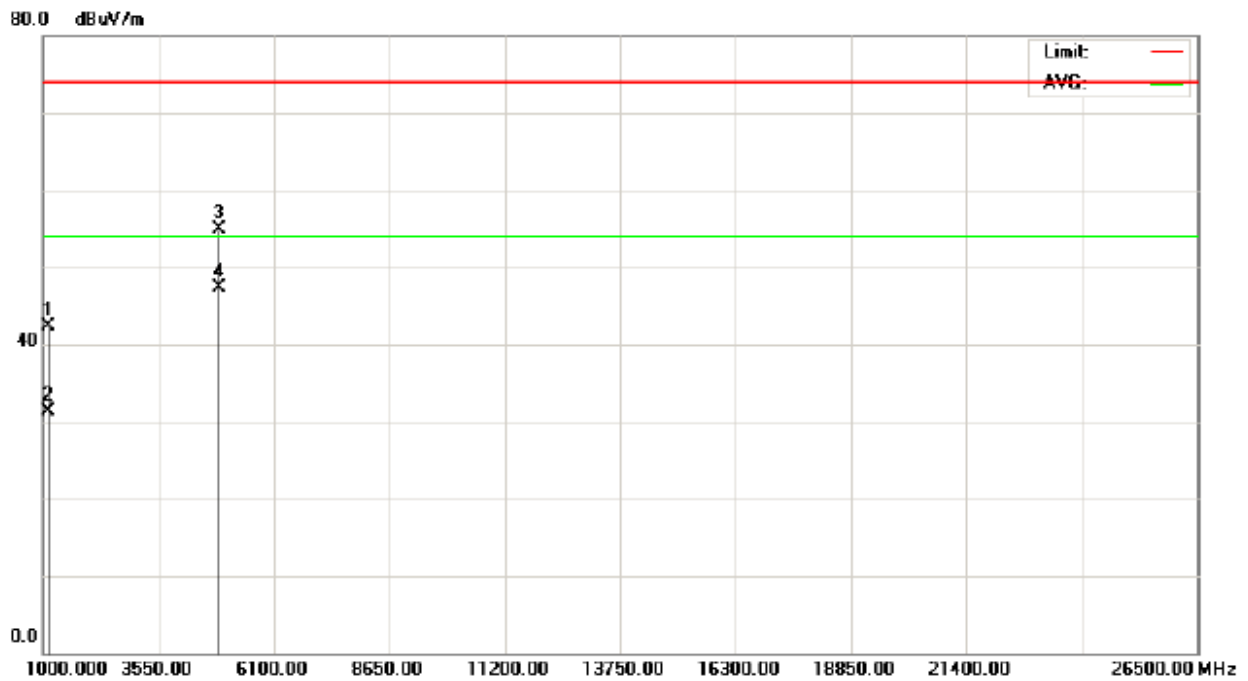
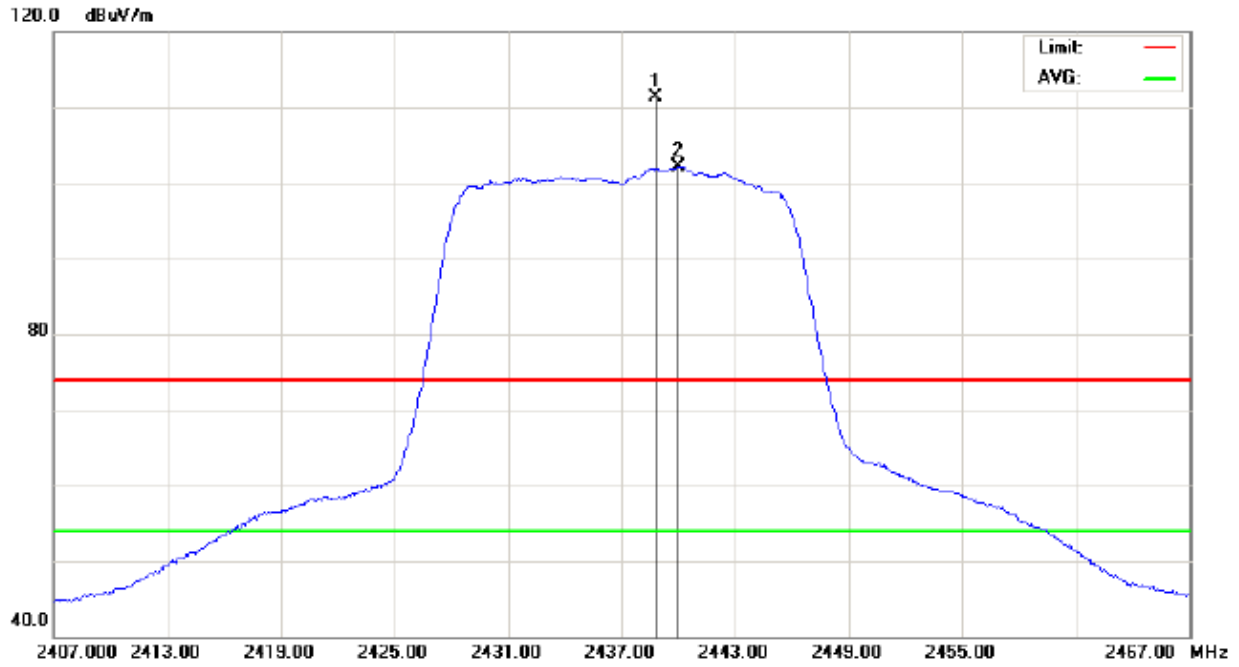

EUT :	802.11n High-speed Wireless Broadband Router	Model Name :	NW725
Temperature :	28 °C	Relative Humidity :	62%
Pressure :	1010 hPa	Test Voltage :	AC 120V/60Hz
Test Mode :	TX N MODE 20M-BW CHANNEL 2437MHz (Antenna A+C)		

Freq. (MHz)	Ant.Pol. H/V	Reading		Ant./CF CF(dB)	Act.		Limit		Note
		Peak (dBuV)	AV (dBuV)		Peak (dBuV/m)	AV (dBuV/m)	Peak (dBuV/m)	AV (dBuV/m)	
2433.88	H	68.40	58.72	32.19	100.59	90.91			X/F
1808.40	H	49.52	40.11	-5.31	44.21	34.80	74.00	54.00	X/H
4874.09	H	50.36	41.19	3.72	54.08	44.91	74.00	54.00	X/H

Remark :

- (1) All readings are Peak unless otherwise stated QP in column of 『 Note 』 . Peak denotes that the Peak reading compliance with the QP Limits and then QP Mode measurement didn't perform .
- (2) Measuring frequency range from 30MHz to 1000MHz or the 10th harmonic of highest fundamental frequency . "F" denotes fundamental frequency ; "H" denotes spurious frequency . "E" denotes band edge frequency . (This judgment method includes the Band Edge Requirement.)
- (3) Radiated emissions measured in frequency range above 1000MHz were made with an instrument using Peak detector mode and AV detector mode of the emission .
- (4) Data of measurement within this frequency range shown " * " in the table above means the reading of emissions are attenuated more than 20dB below the permissible limits or the field strength is too small to be measured.
- (5) A preamp and high pass filter were used for this test in order to provide sufficient measurement sensitivity.
- (6) EUT Orthogonal Axis :
 "X" - denotes Laid on Table ; "Y" - denotes Vertical Stand ; "Z" - denotes Side Stand
- (7) During the measurements above 1 GHz it is taken care of that the EUT is always within the 3 dB cone of radiation BW of the used antenna

TX CH06 (Above 1000 MHz, Horizontal)

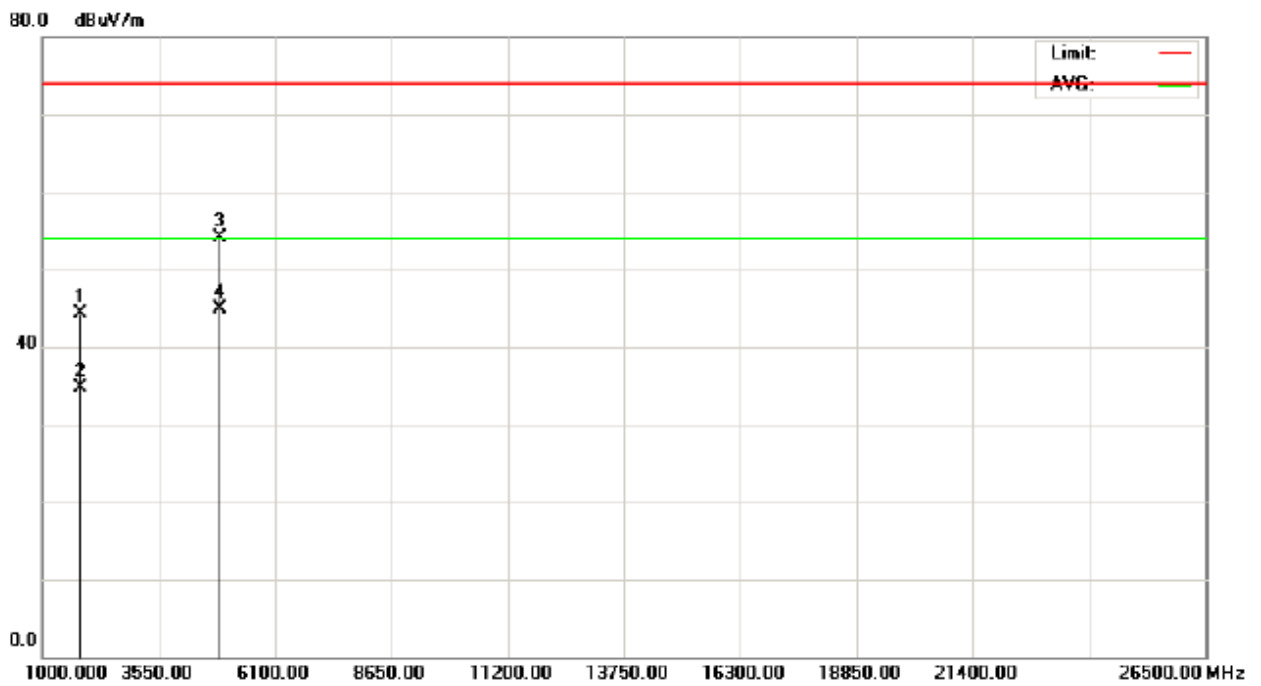
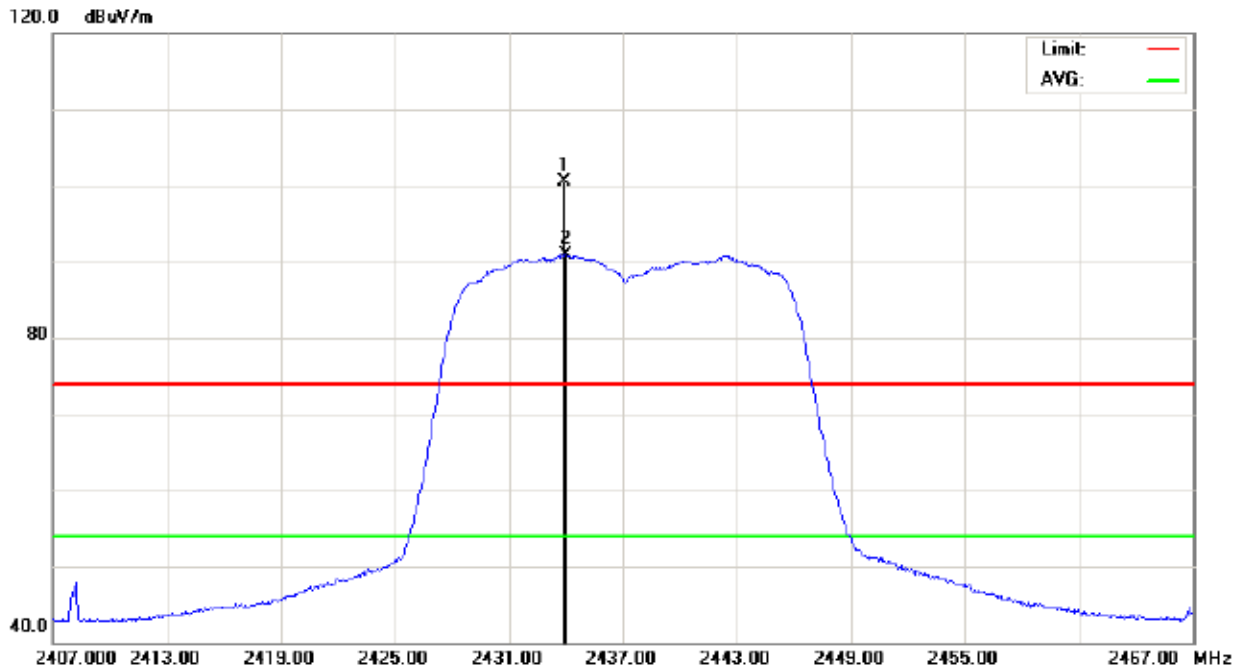

EUT :	802.11n High-speed Wireless Broadband Router	Model Name :	NW725
Temperature :	28 °C	Relative Humidity :	62%
Pressure :	1010 hPa	Test Voltage :	AC 120V/60Hz
Test Mode :	TX N MODE 20M-BW CHANNEL 2462MHz (Antenna A+C)		

Freq.	Ant.Pol.	Reading		Ant./CF	Act.		Limit		Note
		Peak	AV		Peak	AV	Peak	AV	
(MHz)	H/V	(dBuV)	(dBuV)	CF(dB)	(dBuV/m)	(dBuV/m)	(dBuV/m)	(dBuV/m)	
2465.18	V	72.73	68.14	32.29	105.02	100.43			X/F
2483.50	V	37.42	19.94	32.35	69.77	52.29	74.00	54.00	X/E
1120.40	V	49.69	41.34	3.87	53.56	45.21	74.00	54.00	X/H
4924.08	V	49.69	41.34	3.87	53.56	45.21	74.00	54.00	X/H

Remark :

- (1) All readings are Peak unless otherwise stated QP in column of 『Note』 . Peak denotes that the Peak reading compliance with the QP Limits and then QP Mode measurement didn't perform .
- (2) Measuring frequency range from 30MHz to 1000MHz or the 10th harmonic of highest fundamental frequency . "F" denotes fundamental frequency; "H" denotes spurious frequency. "E" denotes band edge frequency. (This judgment method includes the Band Edge Requirement.)
- (3) Radiated emissions measured in frequency range above 1000MHz were made with an instrument using Peak detector mode and AV detector mode of the emission .
- (4) Data of measurement within this frequency range shown " * " in the table above means the reading of emissions are attenuated more than 20dB below the permissible limits or the field strength is too small to be measured.
- (5) A preamp and high pass filter were used for this test in order to provide sufficient measurement sensitivity.
- (6) EUT Orthogonal Axis :
 "X" - denotes Laid on Table ; "Y" - denotes Vertical Stand ; "Z" - denotes Side Stand
- (7) During the measurements above 1 GHz it is taken care of that the EUT is always within the 3 dB cone of radiation BW of the used antenna

TX CH11 (Above 1000 MHz, Vertical)

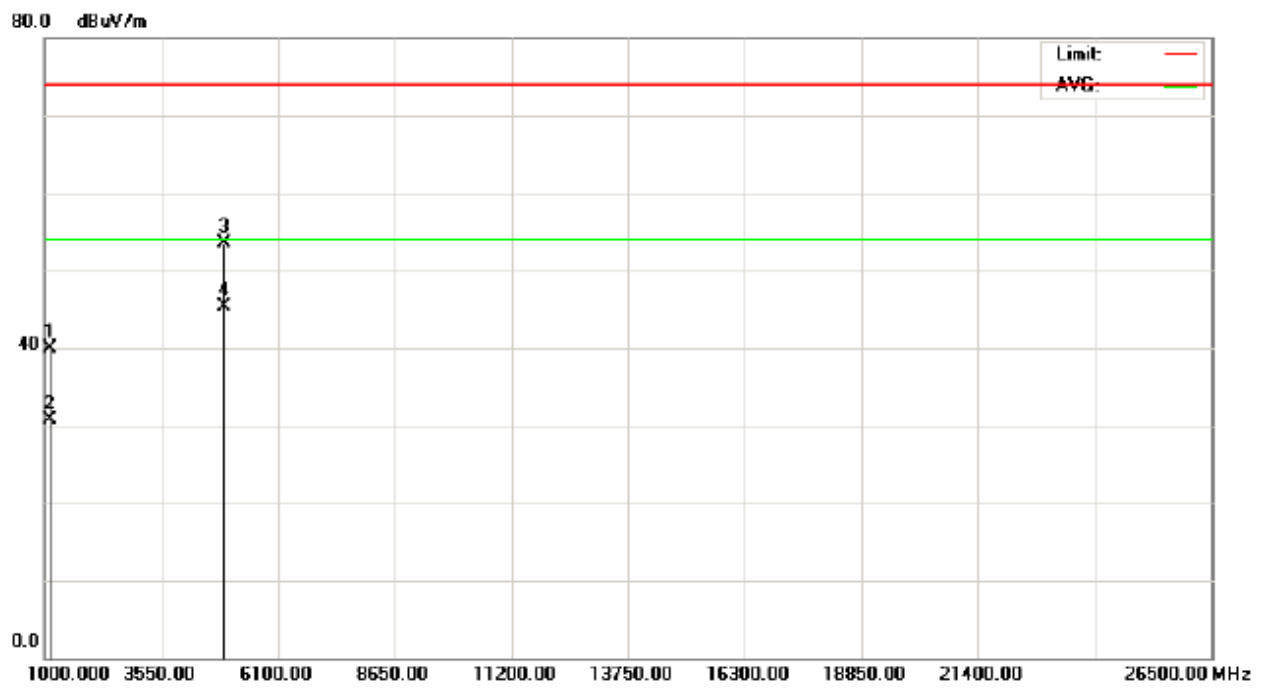
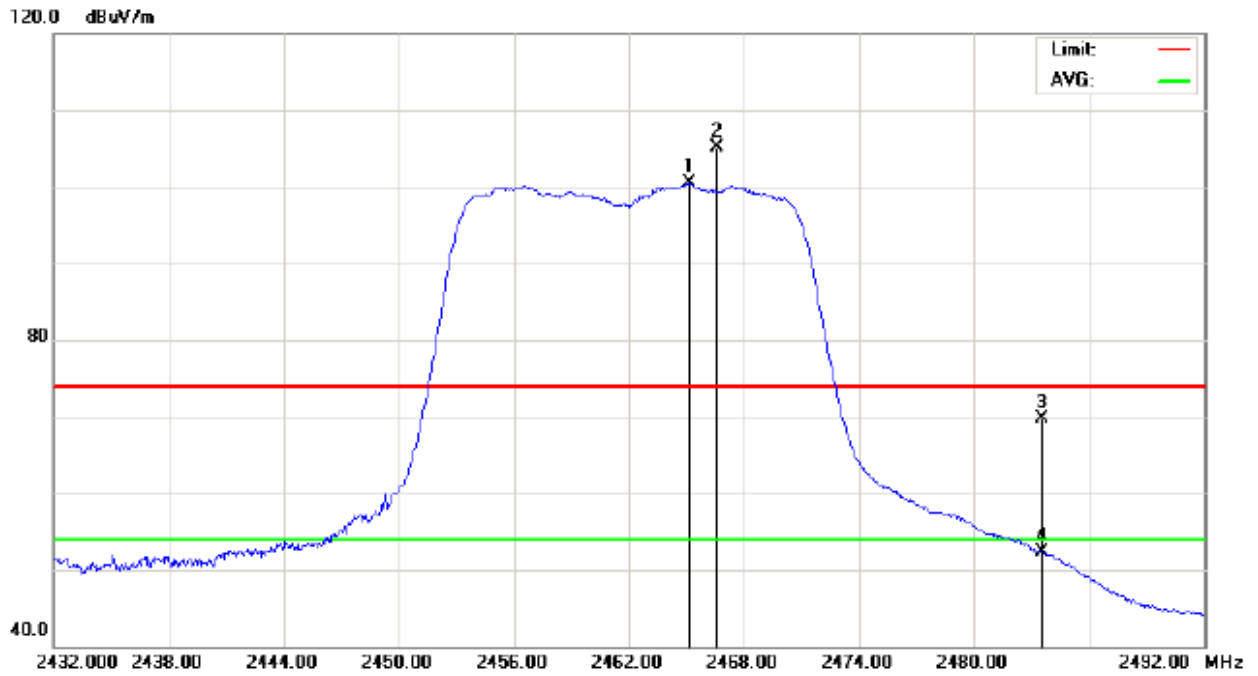

EUT :	802.11n High-speed Wireless Broadband Router	Model Name :	NW725
Temperature :	28 °C	Relative Humidity :	62%
Pressure :	1010 hPa	Test Voltage :	AC 120V/60Hz
Test Mode :	TX N MODE 20M-BW CHANNEL 2462MHz (Antenna A+C)		

Freq. (MHz)	Ant.Pol. H/V	Reading		Ant./CF CF(dB)	Act.		Limit		Note
		Peak (dBuV)	AV (dBuV)		Peak (dBuV/m)	AV (dBuV/m)	Peak (dBuV/m)	AV (dBuV/m)	
2466.92	H	68.12	60.57	32.29	100.41	92.87			X/F
2483.50	H	27.00	14.16	32.35	59.35	46.51	74.00	54.00	X/E
1597.40	H	49.34	36.23	-6.54	42.80	29.70	74.00	54.00	X/H
4924.06	H	50.33	41.21	3.87	54.20	45.08	74.00	54.00	X/H

Remark :

- (1) All readings are Peak unless otherwise stated QP in column of 『 Note 』 . Peak denotes that the Peak reading compliance with the QP Limits and then QP Mode measurement didn't perform .
- (2) Measuring frequency range from 30MHz to 1000MHz or the 10th harmonic of highest fundamental frequency. "F" denotes fundamental frequency; "H" denotes spurious frequency. "E" denotes band edge frequency. (This judgment method includes the Band Edge Requirement.)
- (3) Radiated emissions measured in frequency range above 1000MHz were made with an instrument using Peak detector mode and AV detector mode of the emission .
- (4) Data of measurement within this frequency range shown " * " in the table above means the reading of emissions are attenuated more than 20dB below the permissible limits or the field strength is too small to be measured.
- (5) A preamp and high pass filter were used for this test in order to provide sufficient measurement sensitivity.
- (6) EUT Orthogonal Axis :
"X" - denotes Laid on Table ; "Y" - denotes Vertical Stand ; "Z" - denotes Side Stand
- (7) During the measurements above 1 GHz it is taken care of that the EUT is always within the 3 dB cone of radiation BW of the used antenna

TX CH11 (Above 1000 MHz, Horizontal)

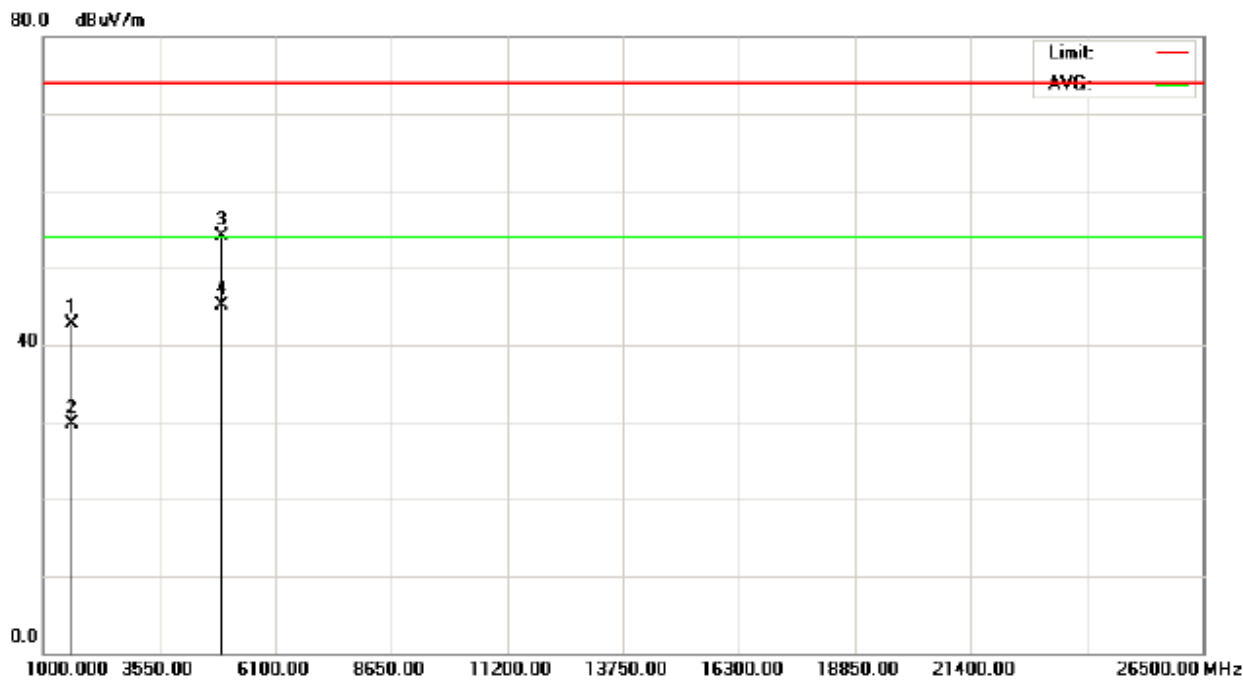
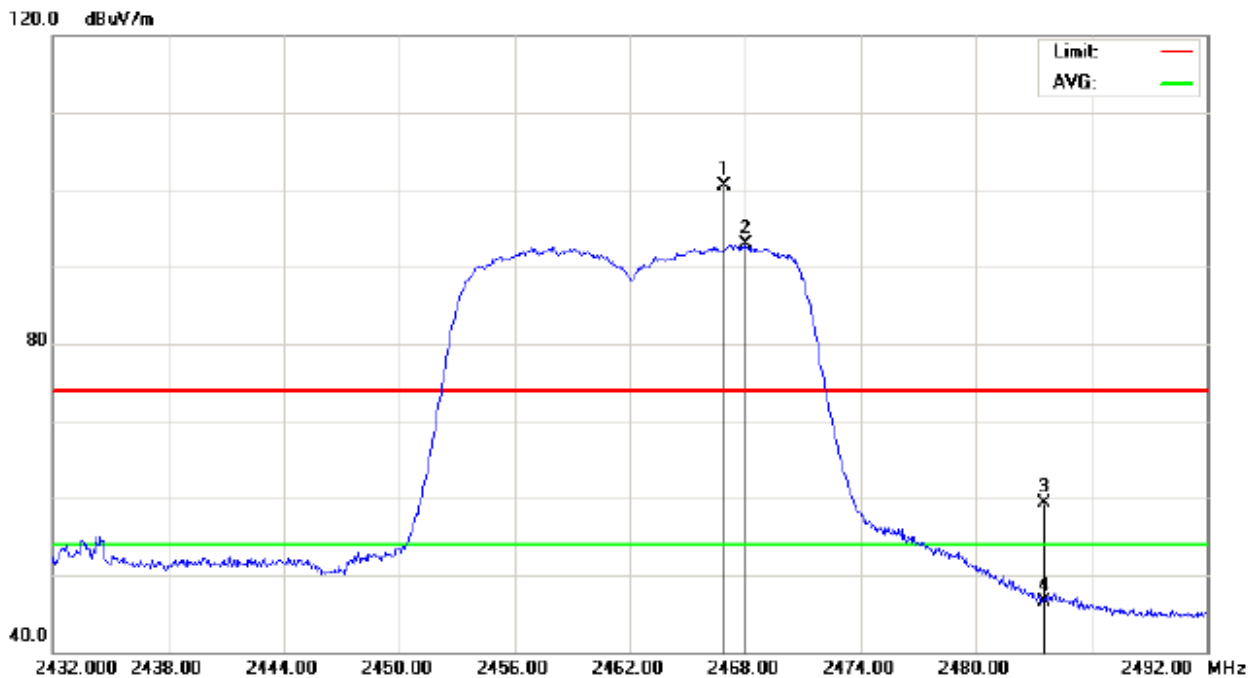

EUT :	802.11n High-speed Wireless Broadband Router	Model Name :	NW725
Temperature :	28 °C	Relative Humidity :	62%
Pressure :	1010 hPa	Test Voltage :	AC 120V/60Hz
Test Mode :	TX N MODE 40M-BW CHANNEL 2422MHz (Antenna A+C)		

Freq. (MHz)	Ant.Pol. H/V	Reading		Ant./CF CF(dB)	Act.		Limit		Note
		Peak (dBuV)	AV (dBuV)		Peak (dBuV/m)	AV (dBuV/m)	Peak (dBuV/m)	AV (dBuV/m)	
2390.00	V	31.00	21.19	32.05	63.05	53.24	74.00	54.00	X/E
2426.72	V	73.04	63.79	32.17	105.23	95.96			X/F
1120.60	V	49.64	40.34	-8.92	40.72	31.42	74.00	54.00	X/H
4844.20	V	51.26	40.51	3.63	54.89	44.14	74.00	54.00	X/H

Remark :

- (1) All readings are Peak unless otherwise stated QP in column of 『Note』 . Peak denotes that the Peak reading compliance with the QP Limits and then QP Mode measurement didn't perform .
- (2) Measuring frequency range from 30MHz to 1000MHz or the 10th harmonic of highest fundamental frequency . "F" denotes fundamental frequency; "H" denotes spurious frequency. "E" denotes band edge frequency. (This judgment method includes the Band Edge Requirement.)
- (3) Radiated emissions measured in frequency range above 1000MHz were made with an instrument using Peak detector mode and AV detector mode of the emission .
- (4) Data of measurement within this frequency range shown " * " in the table above means the reading of emissions are attenuated more than 20dB below the permissible limits or the field strength is too small to be measured.
- (5) A preamp and high pass filter were used for this test in order to provide sufficient measurement sensitivity.
- (6) EUT Orthogonal Axis :
"X" - denotes Laid on Table ; "Y" - denotes Vertical Stand ; "Z" - denotes Side Stand
- (7) During the measurements above 1 GHz it is taken care of that the EUT is always within the 3 dB cone of radiation BW of the used antenna

TX CH03 (Above 1000 MHz, Vertical)

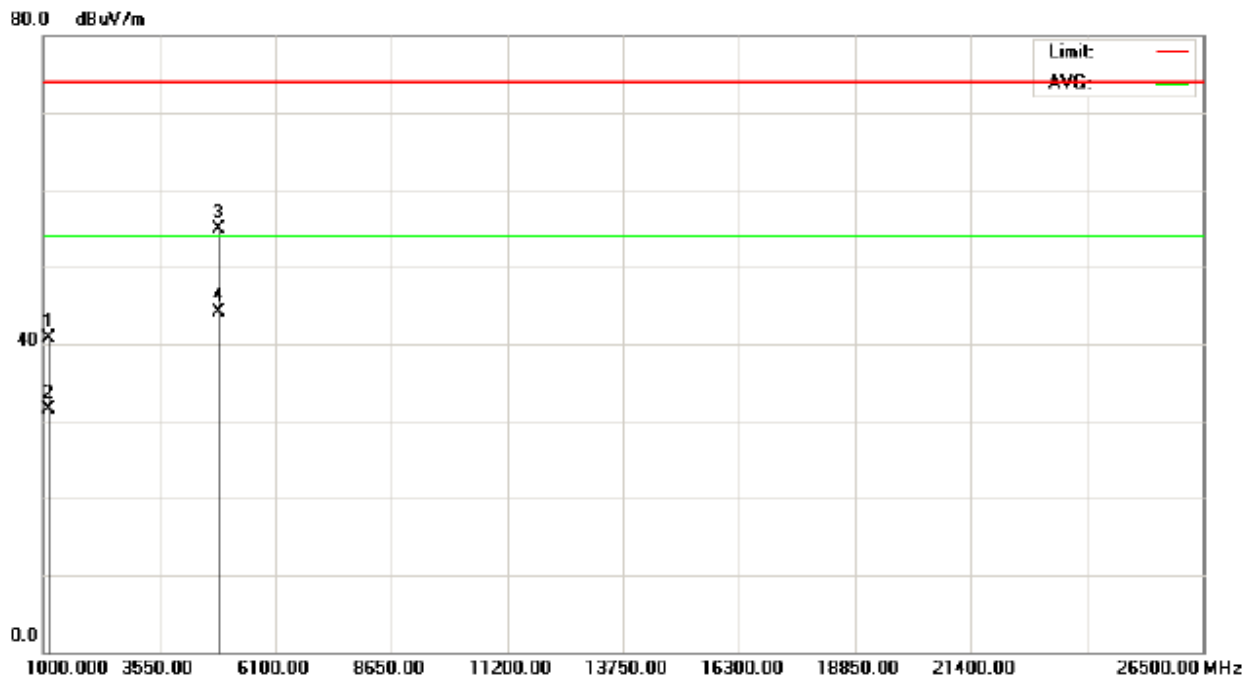
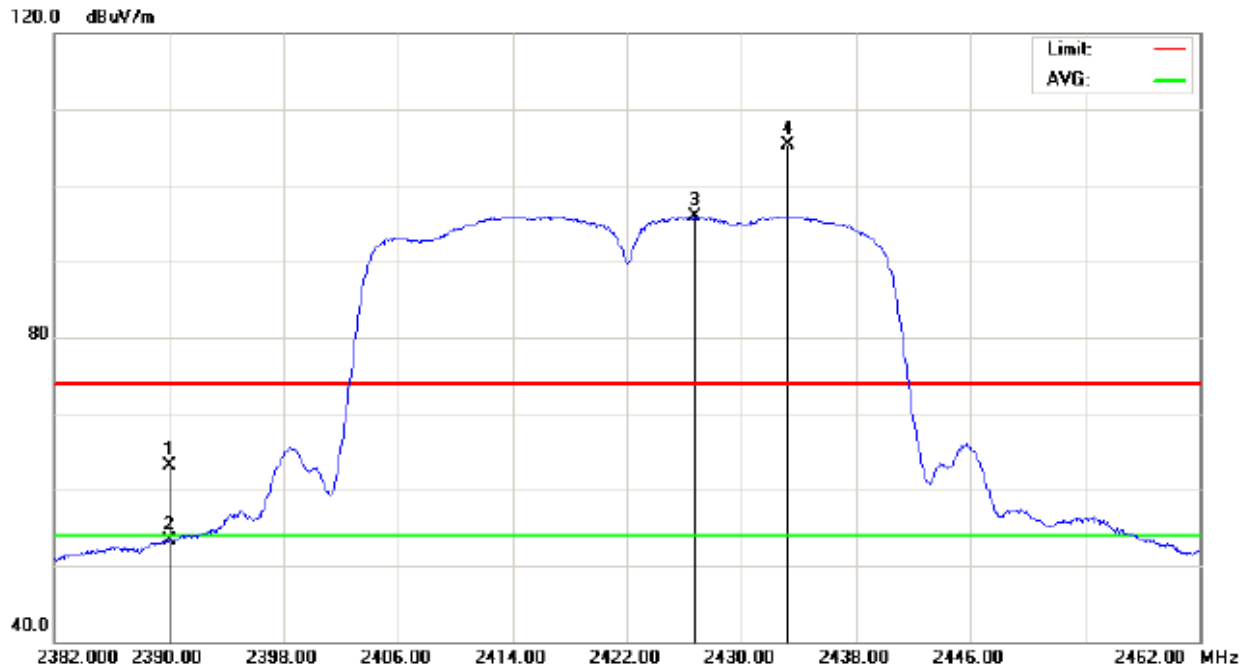

EUT :	802.11n High-speed Wireless Broadband Router	Model Name :	NW725
Temperature :	28 °C	Relative Humidity :	62%
Pressure :	1010 hPa	Test Voltage :	AC 120V/60Hz
Test Mode :	TX N MODE 40M-BW CHANNEL 2422MHz (Antenna A+C)		

Freq. (MHz)	Ant.Pol. H/V	Reading		Ant./CF CF(dB)	Act.		Limit		Note
		Peak (dBuV)	AV (dBuV)		Peak (dBuV/m)	AV (dBuV/m)	Peak (dBuV/m)	AV (dBuV/m)	
2390.00	H	23.74	12.35	32.05	55.79	44.40	74.00	54.00	X/E
2429.92	H	60.06	52.51	32.18	92.26	84.69			X/F
1598.60	H	50.13	38.22	-6.53	43.60	31.69	74.00	54.00	X/H
4844.30	H	50.43	40.38	3.63	54.06	44.01	74.00	54.00	X/H

Remark :

- (1) All readings are Peak unless otherwise stated QP in column of 『 Note 』 . Peak denotes that the Peak reading compliance with the QP Limits and then QP Mode measurement didn't perform .
- (2) Measuring frequency range from 30MHz to 1000MHz or the 10th harmonic of highest fundamental frequency . "F" denotes fundamental frequency ; "H" denotes spurious frequency . "E" denotes band edge frequency . (This judgment method includes the Band Edge Requirement.)
- (3) Radiated emissions measured in frequency range above 1000MHz were made with an instrument using Peak detector mode and AV detector mode of the emission .
- (4) Data of measurement within this frequency range shown " * " in the table above means the reading of emissions are attenuated more than 20dB below the permissible limits or the field strength is too small to be measured.
- (5) A preamp and high pass filter were used for this test in order to provide sufficient measurement sensitivity.
- (6) EUT Orthogonal Axis :
"X" - denotes Laid on Table ; "Y" - denotes Vertical Stand ; "Z" - denotes Side Stand
- (7) During the measurements above 1 GHz it is taken care of that the EUT is always within the 3 dB cone of radiation BW of the used antenna

TX CH03 (Above 1000 MHz, Horizontal)

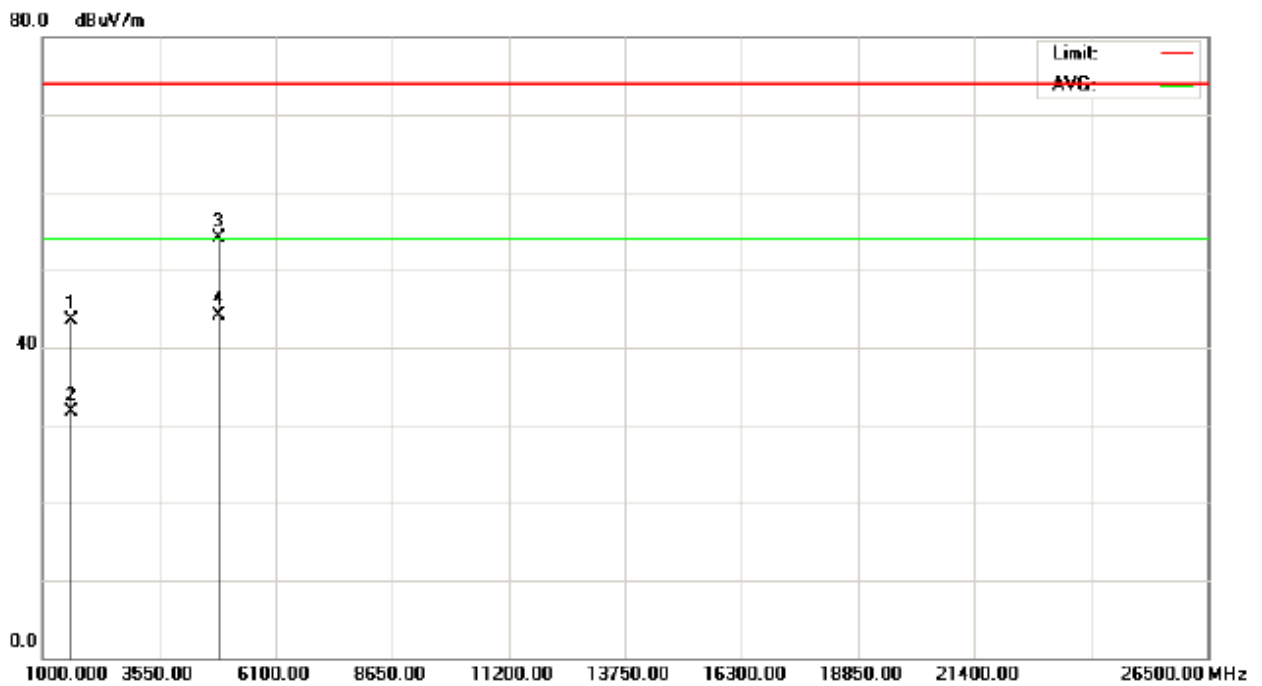
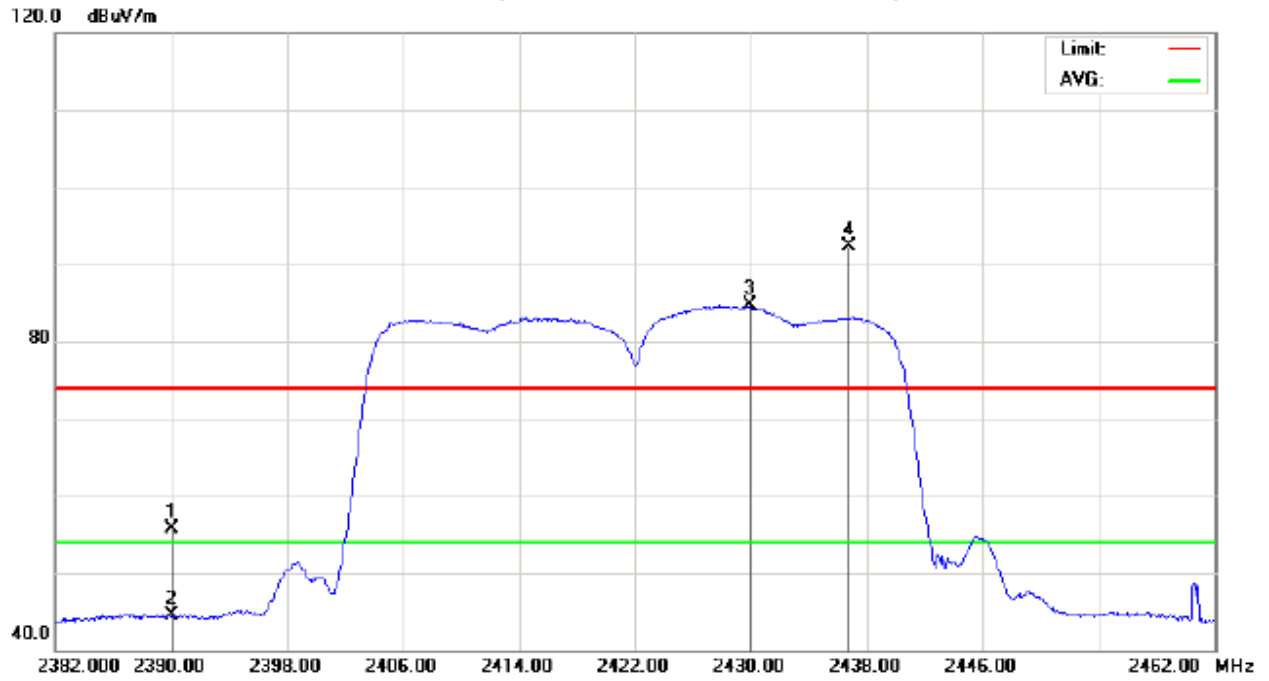

EUT :	802.11n High-speed Wireless Broadband Router	Model Name :	NW725
Temperature :	28 °C	Relative Humidity :	62%
Pressure :	1010 hPa	Test Voltage :	AC 120V/60Hz
Test Mode :	TX N MODE 40M-BW CHANNEL 2437MHz (Antenna A+C)		

Freq. (MHz)	Ant.Pol. H/V	Reading		Ant./CF CF(dB)	Act.		Limit		Note
		Peak (dBuV)	AV (dBuV)		Peak (dBuV/m)	AV (dBuV/m)	Peak (dBuV/m)	AV (dBuV/m)	
2444.20	V	71.96	63.33	32.22	104.18	95.55			X/F
1120.60	V	50.65	41.33	-8.92	41.73	32.41	74.00	54.00	X/H
4874.06	V	50.22	42.13	3.72	53.94	45.85	74.00	54.00	X/H

Remark :

- (1) All readings are Peak unless otherwise stated QP in column of 『 Note 』 . Peak denotes that the Peak reading compliance with the QP Limits and then QP Mode measurement didn't perform .
- (2) Measuring frequency range from 30MHz to 1000MHz or the 10th harmonic of highest fundamental frequency . "F" denotes fundamental frequency ; "H" denotes spurious frequency . "E" denotes band edge frequency . (This judgment method includes the Band Edge Requirement.)
- (3) Radiated emissions measured in frequency range above 1000MHz were made with an instrument using Peak detector mode and AV detector mode of the emission .
- (4) Data of measurement within this frequency range shown " * " in the table above means the reading of emissions are attenuated more than 20dB below the permissible limits or the field strength is too small to be measured.
- (5) A preamp and high pass filter were used for this test in order to provide sufficient measurement sensitivity.
- (6) EUT Orthogonal Axis :
"X" - denotes Laid on Table ; "Y" - denotes Vertical Stand ; "Z" - denotes Side Stand
- (7) During the measurements above 1 GHz it is taken care of that the EUT is always within the 3 dB cone of radiation BW of the used antenna

TX CH06 (Above 1000 MHz, Vertical)

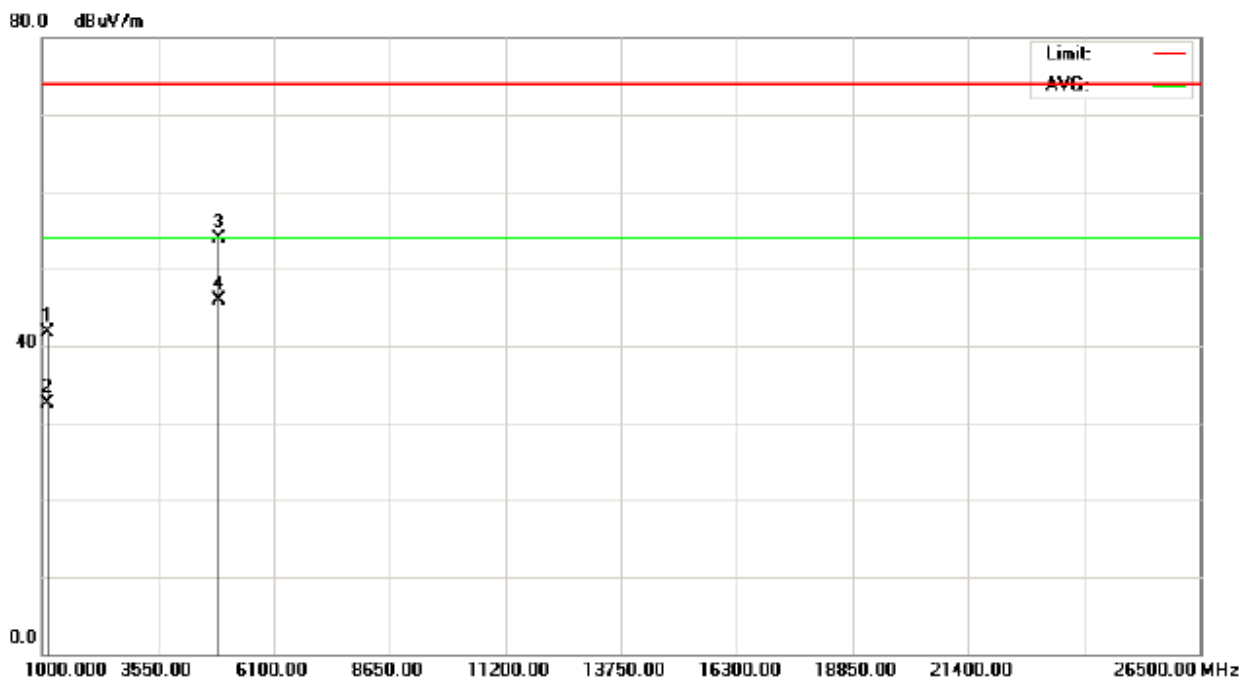
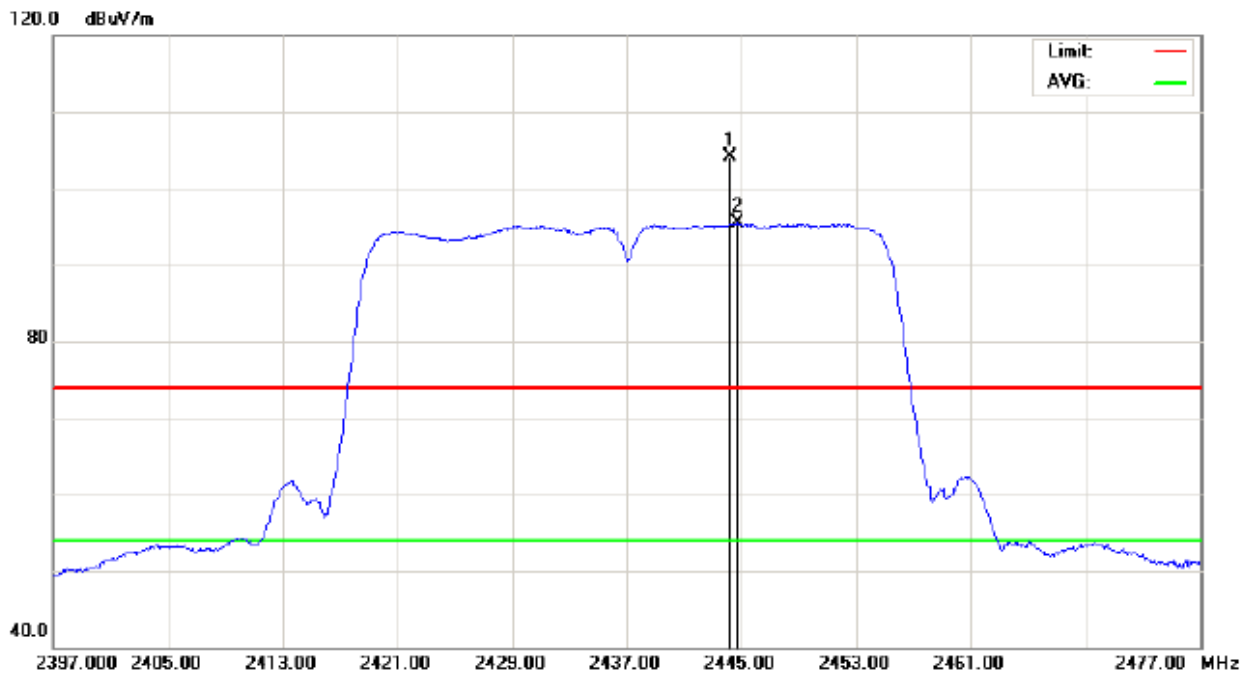

EUT :	802.11n High-speed Wireless Broadband Router	Model Name :	NW725
Temperature :	28 °C	Relative Humidity :	62%
Pressure :	1010 hPa	Test Voltage :	AC 120V/60Hz
Test Mode :	TX N MODE 40M-BW CHANNEL 2437MHz (Antenna A+C)		

Freq.	Ant.Pol.	Reading		Ant./CF	Act.		Limit		Note
		Peak	AV		Peak	AV	Peak	AV	
(MHz)	H/V	(dBuV)	(dBuV)	CF(dB)	(dBuV/m)	(dBuV/m)	(dBuV/m)	(dBuV/m)	
2433.32	H	62.15	53.07	32.19	94.34	85.26			X/F
1808.40	H	50.23	40.25	-5.31	44.92	34.94	74.00	54.00	X/H
4874.07	H	50.84	41.16	3.72	54.56	44.88	74.00	54.00	X/H

Remark :

- (1) All readings are Peak unless otherwise stated QP in column of 『 Note 』 . Peak denotes that the Peak reading compliance with the QP Limits and then QP Mode measurement didn't perform .
- (2) Measuring frequency range from 30MHz to 1000MHz or the 10th harmonic of highest fundamental frequency . "F" denotes fundamental frequency ; "H" denotes spurious frequency . "E" denotes band edge frequency . (This judgment method includes the Band Edge Requirement.)
- (3) Radiated emissions measured in frequency range above 1000MHz were made with an instrument using Peak detector mode and AV detector mode of the emission .
- (4) Data of measurement within this frequency range shown " * " in the table above means the reading of emissions are attenuated more than 20dB below the permissible limits or the field strength is too small to be measured.
- (5) A preamp and high pass filter were used for this test in order to provide sufficient measurement sensitivity.
- (6) EUT Orthogonal Axis :
 "X" - denotes Laid on Table ; "Y" - denotes Vertical Stand ; "Z" - denotes Side Stand
- (7) During the measurements above 1 GHz it is taken care of that the EUT is always within the 3 dB cone of radiation BW of the used antenna

TX CH06 (Above 1000 MHz, Horizontal)

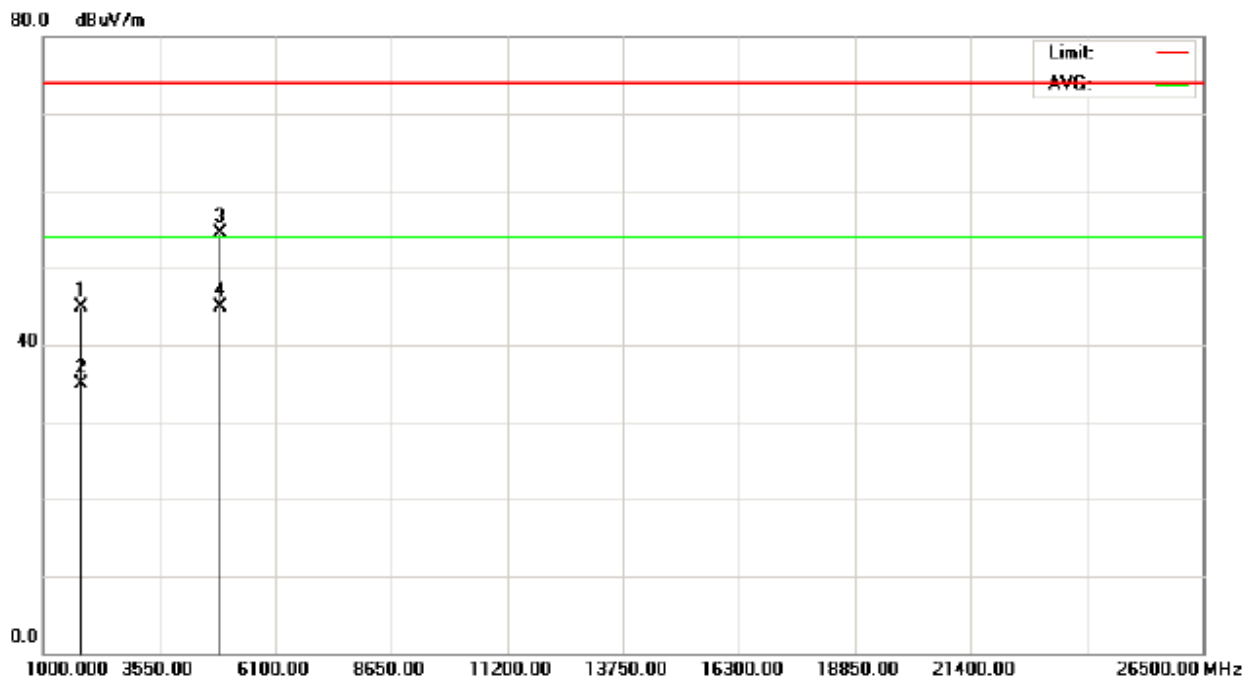
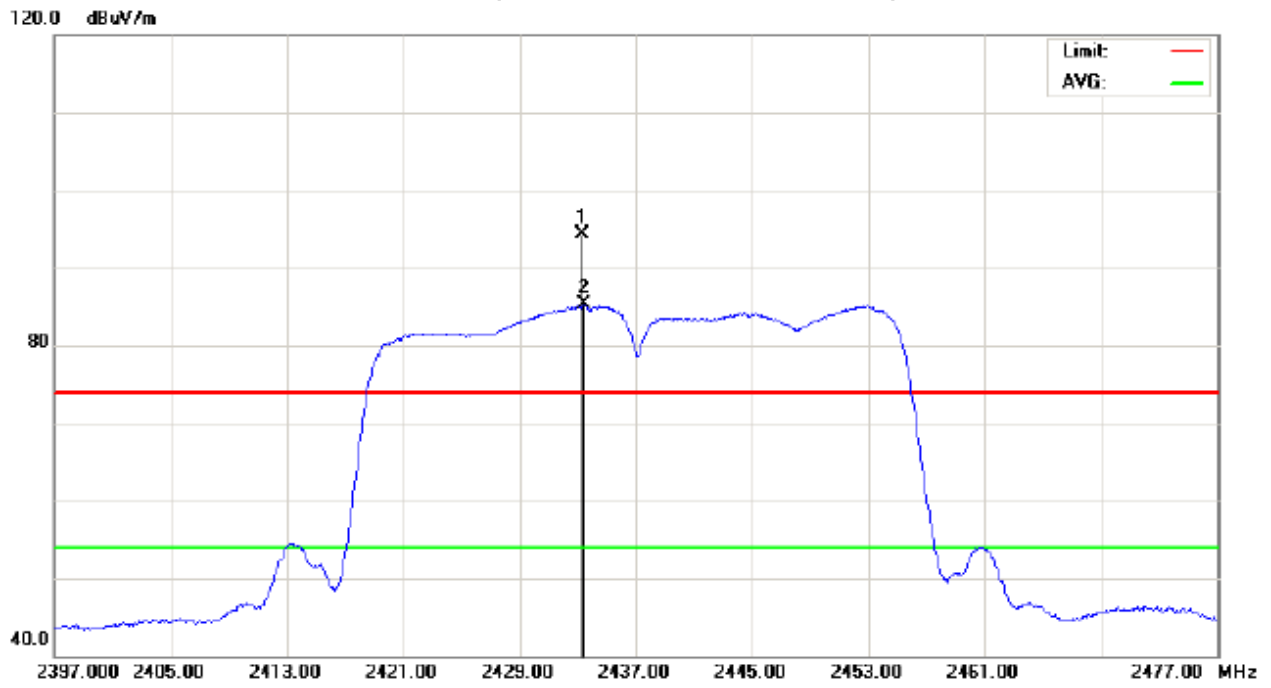

EUT :	802.11n High-speed Wireless Broadband Router	Model Name :	NW725
Temperature :	28 °C	Relative Humidity :	62%
Pressure :	1010 hPa	Test Voltage :	AC 120V/60Hz
Test Mode :	TX N MODE 40M-BW CHANNEL 2452MHz (Antenna A+C)		

Freq.	Ant.Pol.	Reading		Ant./CF	Act.		Limit		Note
		Peak	AV		Peak	AV	Peak	AV	
(MHz)	H/V	(dBuV)	(dBuV)	CF(dB)	(dBuV/m)	(dBuV/m)	(dBuV/m)	(dBuV/m)	
2457.60	V	73.57	62.56	32.26	105.83	94.83			X/F
2483.50	V	29.29	20.72	32.35	61.64	53.07	74.00	54.00	X/E
1120.40	V	53.73	41.31	-8.92	44.81	32.39	74.00	54.00	X/H
4824.70	V	52.23	41.02	3.57	55.80	44.59	74.00	54.00	X/H

Remark :

- (1) All readings are Peak unless otherwise stated QP in column of 『Note』 . Peak denotes that the Peak reading compliance with the QP Limits and then QP Mode measurement didn't perform .
- (2) Measuring frequency range from 30MHz to 1000MHz or the 10th harmonic of highest fundamental frequency . "F" denotes fundamental frequency ; "H" denotes spurious frequency . "E" denotes band edge frequency . (This judgment method includes the Band Edge Requirement.)
- (3) Radiated emissions measured in frequency range above 1000MHz were made with an instrument using Peak detector mode and AV detector mode of the emission .
- (4) Data of measurement within this frequency range shown " * " in the table above means the reading of emissions are attenuated more than 20dB below the permissible limits or the field strength is too small to be measured.
- (5) A preamp and high pass filter were used for this test in order to provide sufficient measurement sensitivity.
- (6) EUT Orthogonal Axis :
 "X" - denotes Laid on Table ; "Y" - denotes Vertical Stand ; "Z" - denotes Side Stand
- (7) During the measurements above 1 GHz it is taken care of that the EUT is always within the 3 dB cone of radiation BW of the used antenna

TX CH09 (Above 1000 MHz, Vertical)

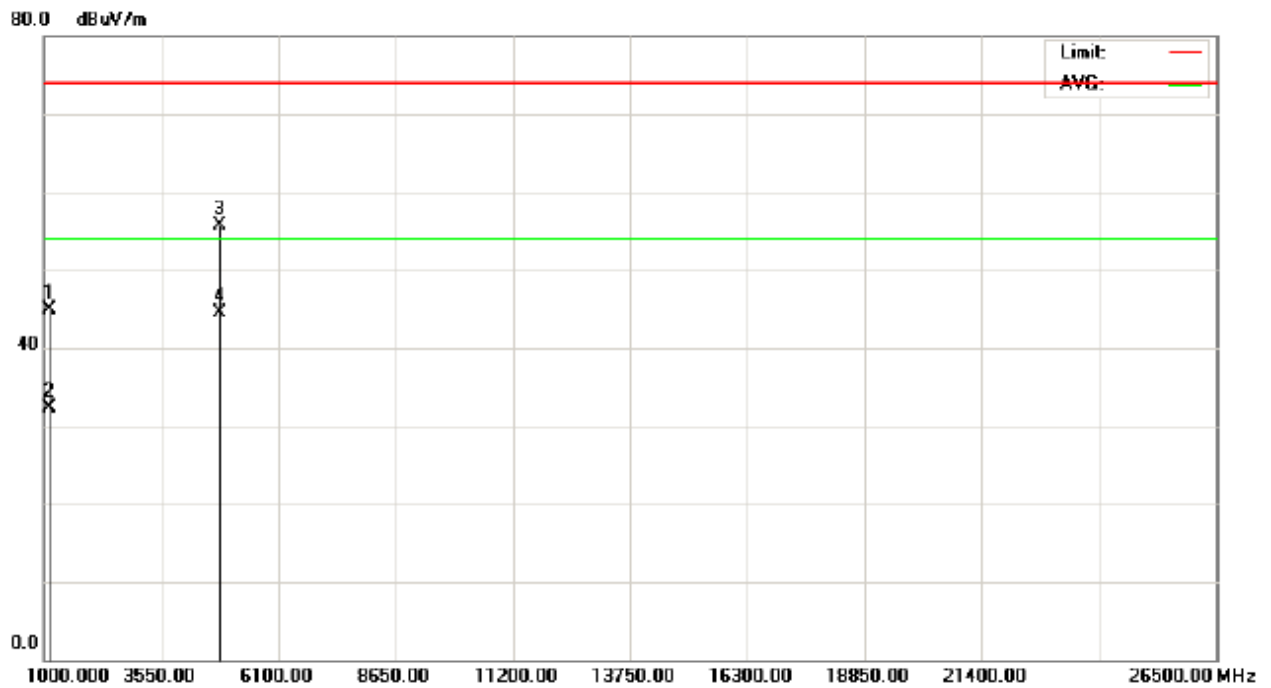
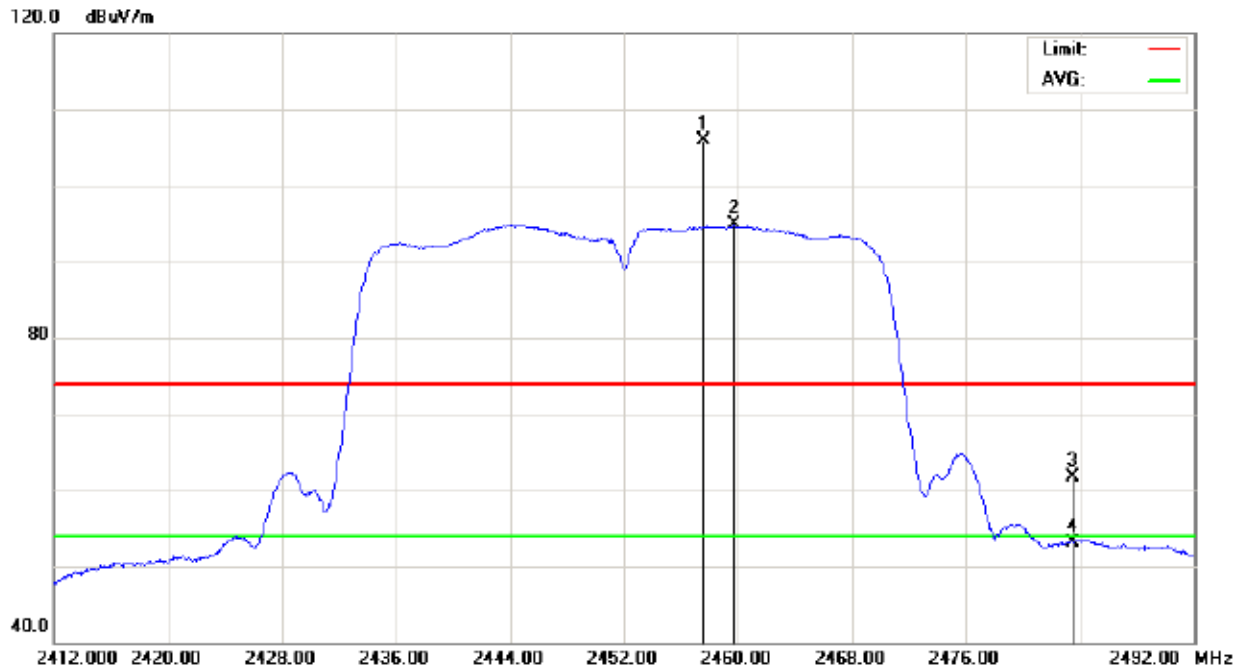

EUT :	802.11n High-speed Wireless Broadband Router	Model Name :	NW725
Temperature :	28 °C	Relative Humidity :	62%
Pressure :	1010 hPa	Test Voltage :	AC 120V/60Hz
Test Mode :	TX N MODE 40M-BW CHANNEL 2452MHz (Antenna A+C)		

Freq. (MHz)	Ant.Pol. H/V	Reading		Ant./CF CF(dB)	Act.		Limit		Note
		Peak (dBuV)	AV (dBuV)		Peak (dBuV/m)	AV (dBuV/m)	Peak (dBuV/m)	AV (dBuV/m)	
2455.60	H	62.97	53.58	32.26	95.23	85.84			X/F
2483.50	H	23.33	13.07	32.35	55.68	45.42	74.00	54.00	X/E
1818.60	H	49.32	41.03	-5.31	44.01	35.72	74.00	54.00	X/H
4904.13	H	49.37	39.96	3.81	53.18	43.77	74.00	54.00	X/H

Remark :

- (1) All readings are Peak unless otherwise stated QP in column of 『Note』 . Peak denotes that the Peak reading compliance with the QP Limits and then QP Mode measurement didn't perform .
- (2) Measuring frequency range from 30MHz to 1000MHz or the 10th harmonic of highest fundamental frequency. "F" denotes fundamental frequency; "H" denotes spurious frequency. "E" denotes band edge frequency. (This judgment method includes the Band Edge Requirement.)
- (3) Radiated emissions measured in frequency range above 1000MHz were made with an instrument using Peak detector mode and AV detector mode of the emission .
- (4) Data of measurement within this frequency range shown " * " in the table above means the reading of emissions are attenuated more than 20dB below the permissible limits or the field strength is too small to be measured.
- (5) A preamp and high pass filter were used for this test in order to provide sufficient measurement sensitivity.
- (6) EUT Orthogonal Axis :
"X" - denotes Laid on Table ; "Y" - denotes Vertical Stand ; "Z" - denotes Side Stand
- (7) During the measurements above 1 GHz it is taken care of that the EUT is always within the 3 dB cone of radiation BW of the used antenna

TX CH09 (Above 1000 MHz, Horizontal)

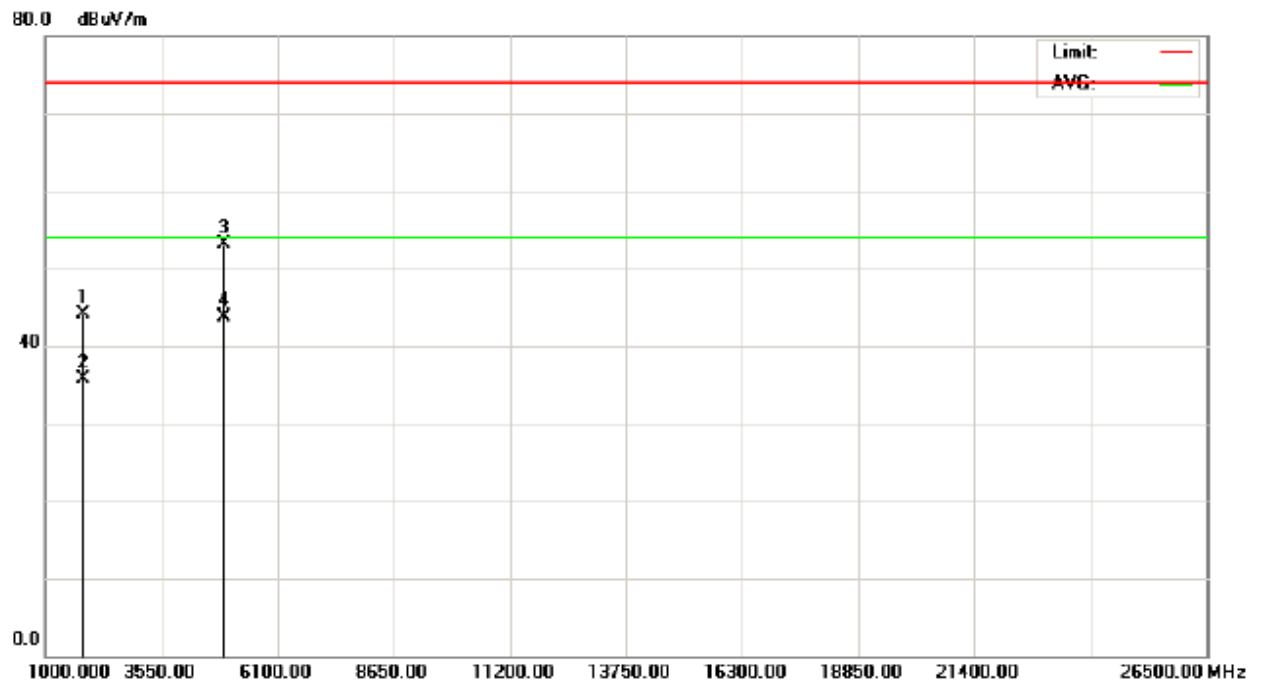
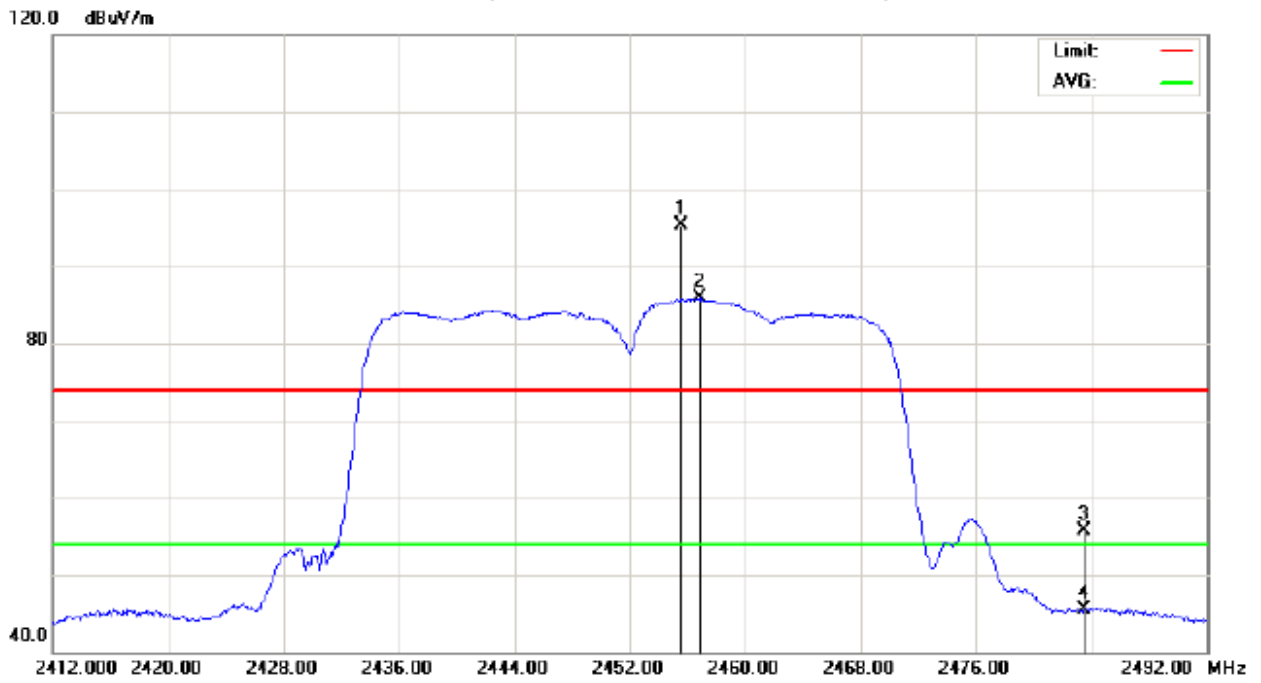

4.2.9 TEST RESULTS (RESTRICTED BANDS REQUIREMENTS)

EUT :	802.11n High-speed Wireless Broadband Router	Model Name :	NW725
Temperature :	28 °C	Relative Humidity :	62%
Pressure :	1010 hPa	Test Voltage :	AC 120V/60Hz
Test Mode :	TX B MODE 20M-BW CHANNEL 2412MHz/2462MHz (Vertical)		
Note :	1. The transmitter was setup to transmit at the lowest channel (CH01). Then the field strength was measured at 2310-2390 MHz. 2. The transmitter was setup to transmit at the highest channel (CH11). Then the field strength was measured at 2483.5-2500 MHz.		

Freq.	Ant.Pol.	Reading		Ant./CF	Act.		Limit		Note
		Peak	AV		Peak	AV	Peak	AV	
(MHz)	H/V	(dBuV)	(dBuV)	CF(dB)	(dBuV/m)	(dBuV/m)	(dBuV/m)	(dBuV/m)	
2390.00	V	21.91	11.73	32.05	53.96	43.78	74.00	54.00	CH01
2483.50	V	25.26	15.76	32.35	57.61	48.11	74.00	54.00	CH11

Remark :

- (1) Radiated emissions measured in frequency range above 1000MHz were made with an instrument using Peak detector mode and AV detector mode of the emission .
- (2) EUT Orthogonal Axis :
 "X" - denotes Laid on Table ; "Y" - denotes Vertical Stand ; "Z" - denotes Side Stand
- (3) During the measurements above 1 GHz it is taken care of that the EUT is always within the 3 dB cone of radiation BW of the used antenna

Restricted Bands Requirements, Vertical CH01

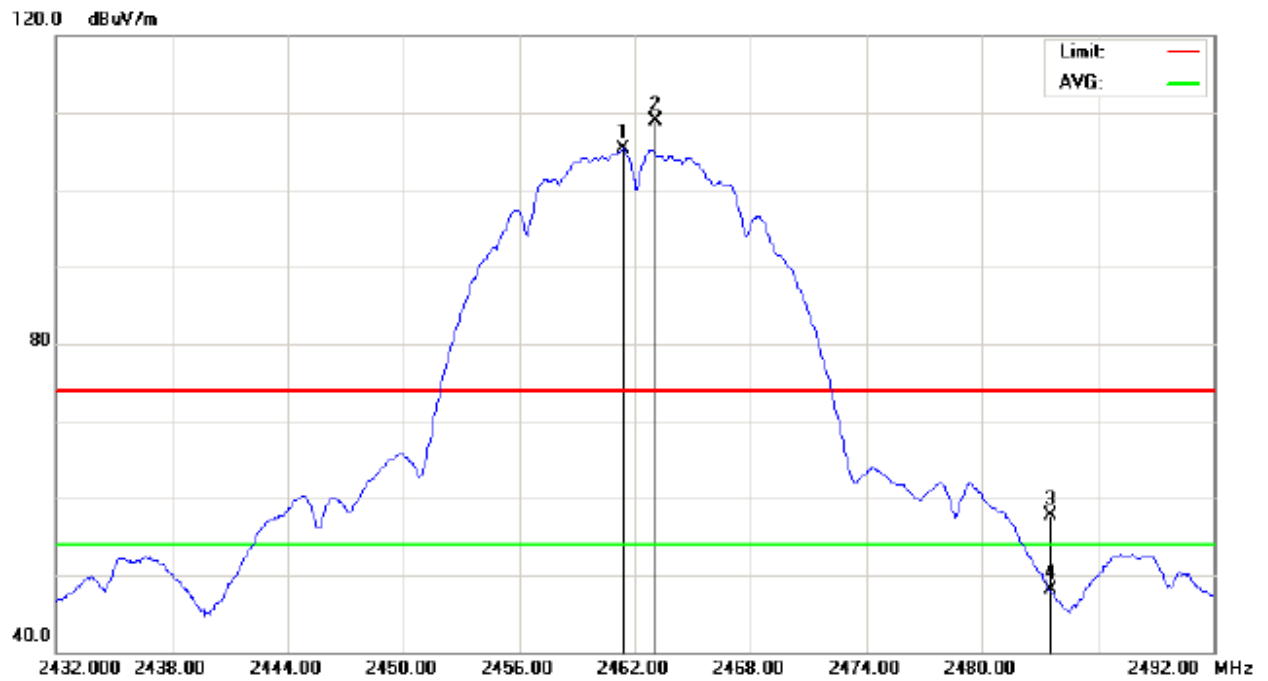
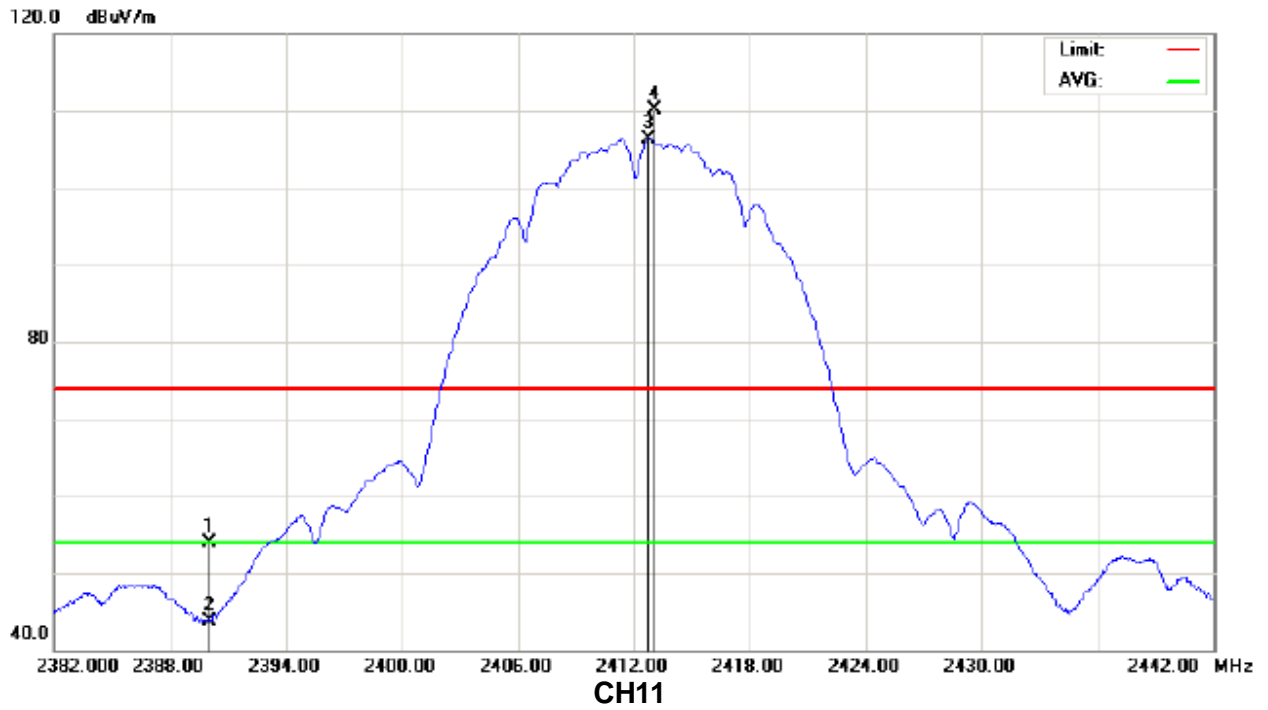

EUT :	802.11n High-speed Wireless Broadband Router	Model Name :	NW725
Temperature :	28 °C	Relative Humidity :	62%
Pressure :	1010 hPa	Test Voltage :	AC 120V/60Hz
Test Mode :	TX B MODE 20M-BW CHANNEL 2412MHz/2462MHz (Horizontal)		
Note :	1. The transmitter was setup to transmit at the lowest channel (CH01). Then the field strength was measured at 2310-2390 MHz. 2. The transmitter was setup to transmit at the highest channel (CH11). Then the field strength was measured at 2483.5-2500 MHz.		

Freq.	Ant.Pol.	Reading		Ant./CF	Act.		Limit		Note
		Peak	AV		Peak	AV	Peak	AV	
(MHz)	H/V	(dBuV)	(dBuV)	CF(dB)	(dBuV/m)	(dBuV/m)	(dBuV/m)	(dBuV/m)	
2390.00	H	22.40	10.22	32.05	54.45	42.27	74.00	54.00	CH01
2483.50	H	22.54	11.08	32.35	54.89	43.43	74.00	54.00	CH11

Remark :

- (1) Radiated emissions measured in frequency range above 1000MHz were made with an instrument using Peak detector mode and AV detector mode of the emission .
- (2) EUT Orthogonal Axis :
 "X" - denotes Laid on Table ; "Y" - denotes Vertical Stand ; "Z" - denotes Side Stand
- (3) During the measurements above 1 GHz it is taken care of that the EUT is always within the 3 dB cone of radiation BW of the used antenna

Restricted Bands Requirements, Horizontal
CH01

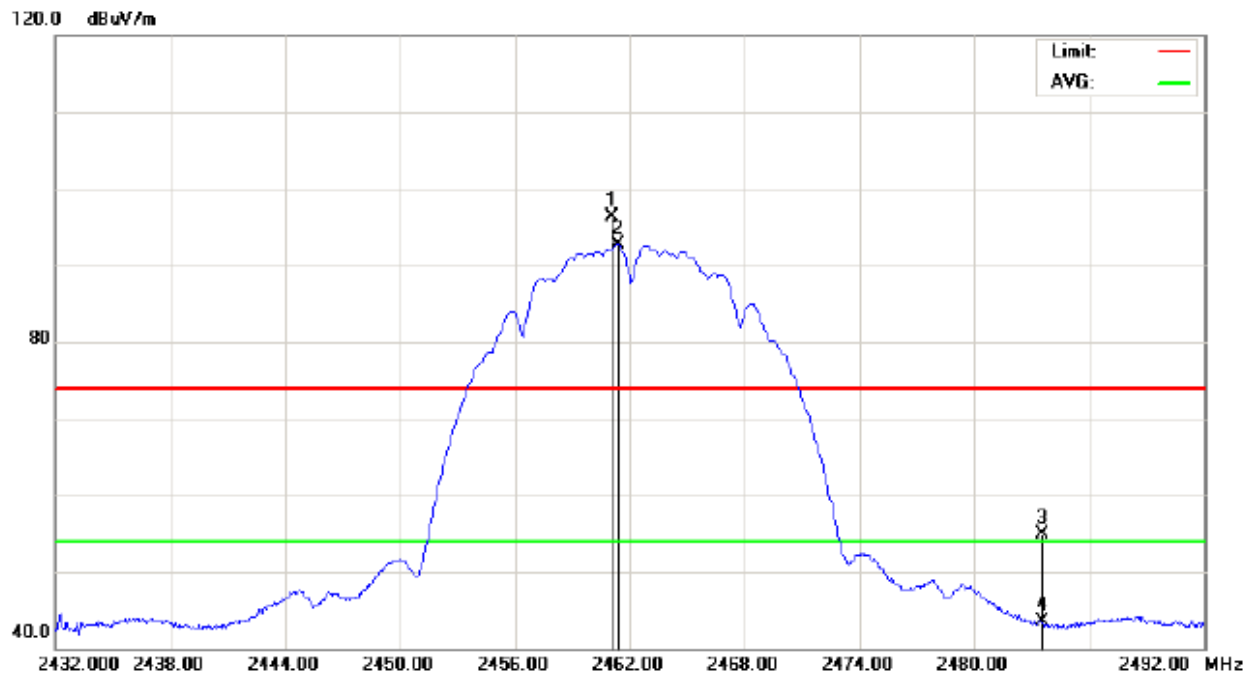
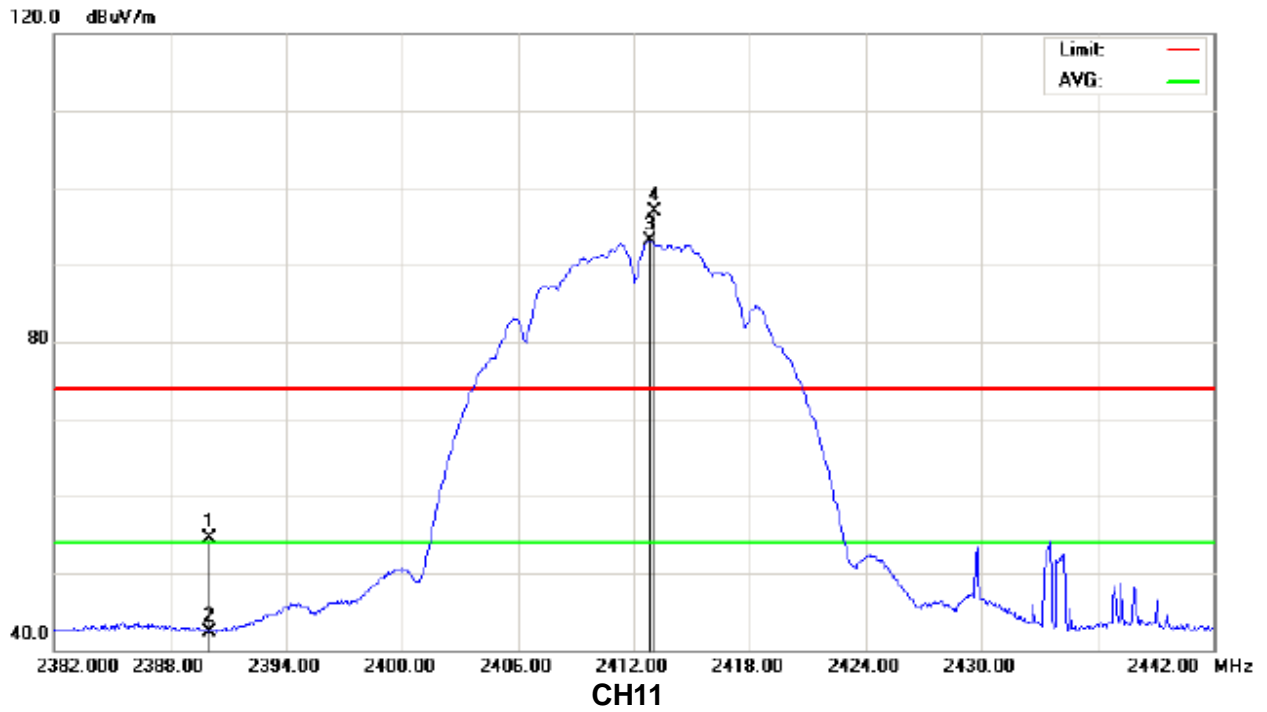

EUT :	802.11n High-speed Wireless Broadband Router	Model Name :	NW725
Temperature :	28 °C	Relative Humidity :	65%
Pressure :	1010 hPa	Test Voltage :	AC 120V/60Hz
Test Mode :	TX G MODE 20M-BW CHANNEL 2412MHz/2462MHz (Vertical)		
Note :	1. The transmitter was setup to transmit at the lowest channel (CH01). Then the field strength was measured at 2310-2390 MHz. 2. The transmitter was setup to transmit at the highest channel (CH11). Then the field strength was measured at 2483.5-2500 MHz.		

Freq.	Ant.Pol.	Reading		Ant./CF	Act.		Limit		Note
		Peak	AV		Peak	AV	Peak	AV	
(MHz)	H/V	(dBuV)	(dBuV)	CF(dB)	(dBuV/m)	(dBuV/m)	(dBuV/m)	(dBuV/m)	
2390.00	V	32.15	17.35	32.05	64.20	49.40	74.00	54.00	CH01
2483.50	V	34.45	20.19	32.35	66.80	52.54	74.00	54.00	CH11

Remark :

- (1) Radiated emissions measured in frequency range above 1000MHz were made with an instrument using Peak detector mode and AV detector mode of the emission .
- (2) EUT Orthogonal Axis :
 "X" - denotes Laid on Table ; "Y" - denotes Vertical Stand ; "Z" - denotes Side Stand
- (3) During the measurements above 1 GHz it is taken care of that the EUT is always within the 3 dB cone of radiation BW of the used antenna

Restricted Bands Requirements, Vertical
CH01

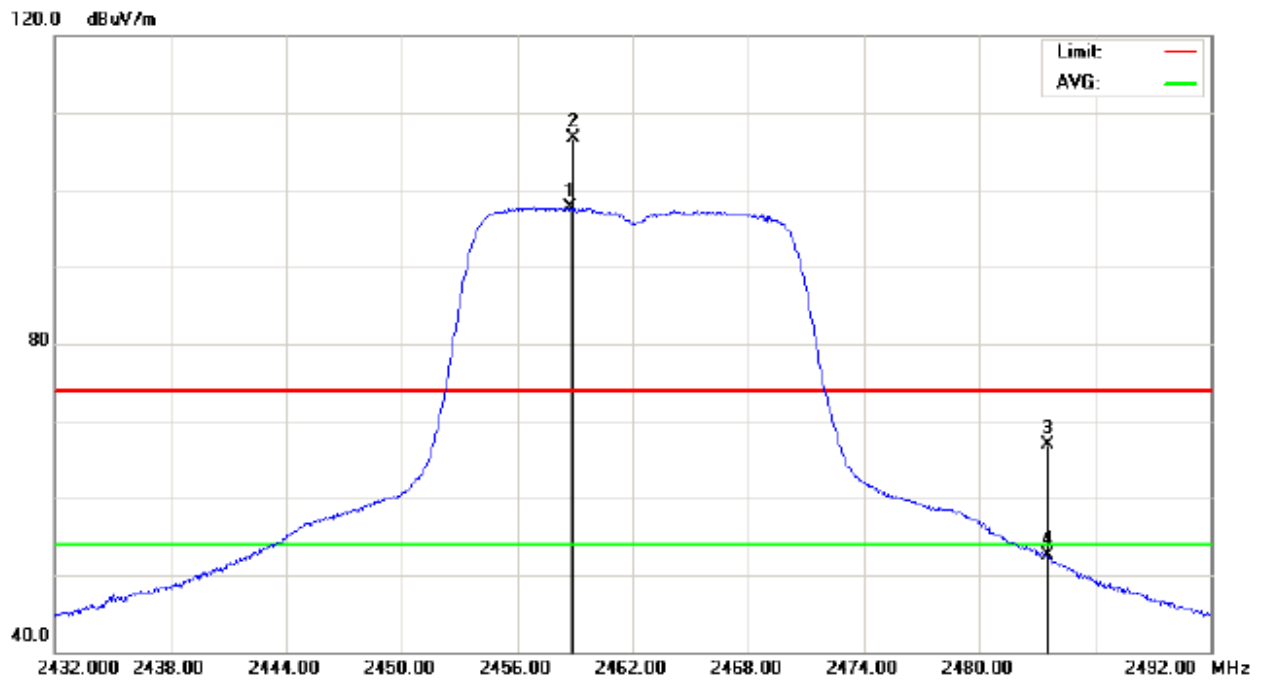
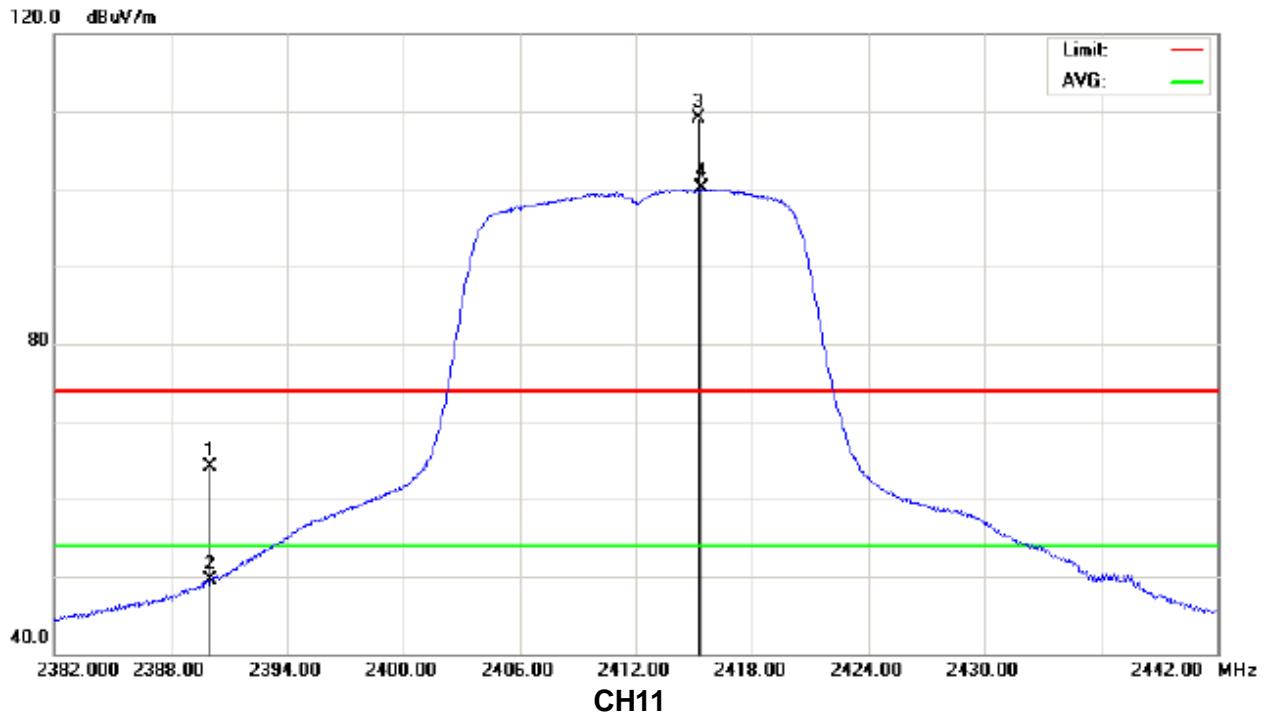

EUT :	802.11n High-speed Wireless Broadband Router	Model Name :	NW725
Temperature :	28 °C	Relative Humidity :	65%
Pressure :	1010 hPa	Test Voltage :	AC 120V/60Hz
Test Mode :	TX G MODE 20M-BW CHANNEL 2412MHz/2462MHz (Horizontal)		
Note :	1. The transmitter was setup to transmit at the lowest channel (CH01). Then the field strength was measured at 2310-2390 MHz. 2. The transmitter was setup to transmit at the highest channel (CH11). Then the field strength was measured at 2483.5-2500 MHz.		

Freq.	Ant.Pol.	Reading		Ant./CF	Act.		Limit		Note
		Peak	AV		Peak	AV	Peak	AV	
(MHz)	H/V	(dBuV)	(dBuV)	CF(dB)	(dBuV/m)	(dBuV/m)	(dBuV/m)	(dBuV/m)	
2390.00	H	23.66	11.49	32.05	55.71	43.54	74.00	54.00	CH01
2483.50	H	24.47	12.00	32.35	56.82	44.35	74.00	54.00	CH11

Remark :

- (1) Radiated emissions measured in frequency range above 1000MHz were made with an instrument using Peak detector mode and AV detector mode of the emission .
- (2) EUT Orthogonal Axis :
 "X" - denotes Laid on Table ; "Y" - denotes Vertical Stand ; "Z" - denotes Side Stand
- (3) During the measurements above 1 GHz it is taken care of that the EUT is always within the 3 dB cone of radiation BW of the used antenna

Restricted Bands Requirements, Horizontal
CH01

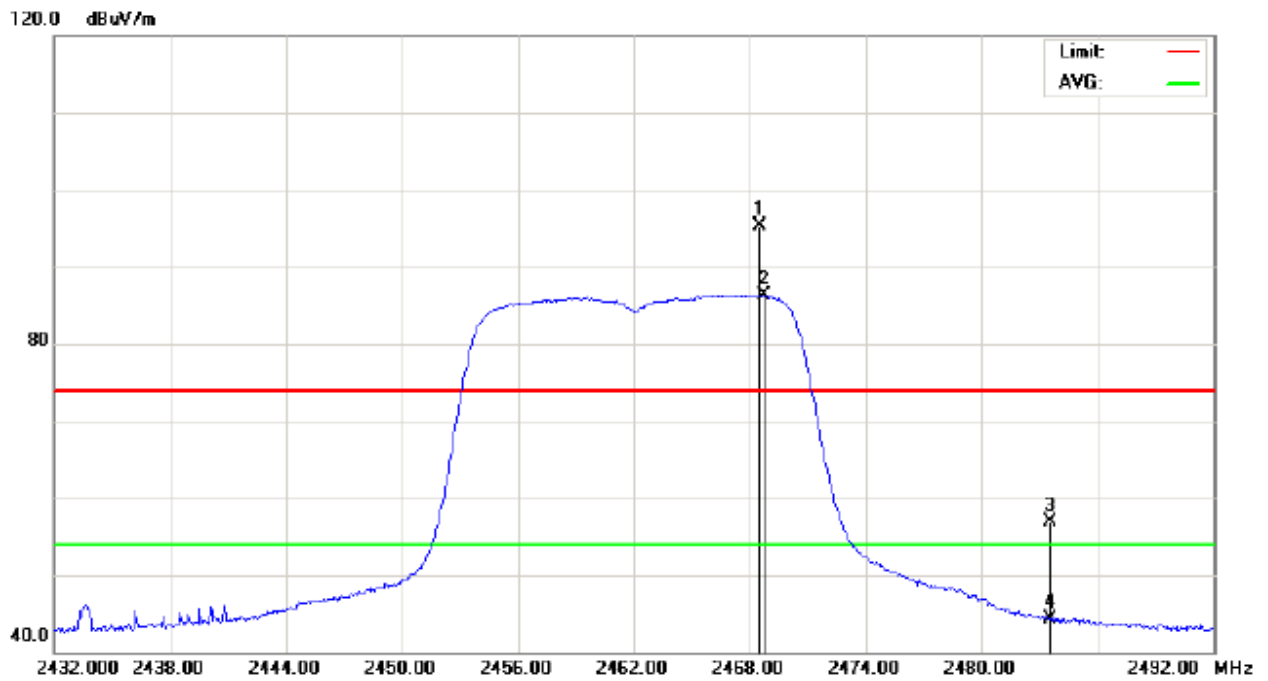
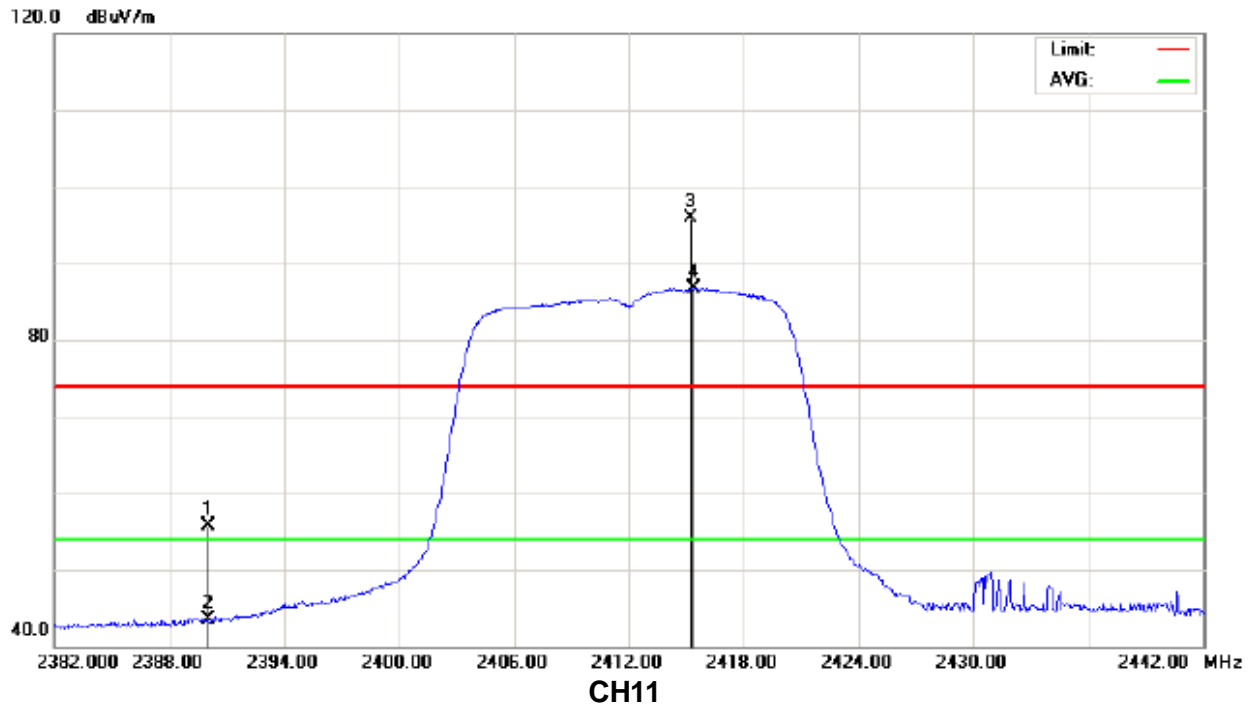

EUT :	802.11n High-speed Wireless Broadband Router	Model Name :	NW725
Temperature :	28 °C	Relative Humidity :	65%
Pressure :	1010 hPa	Test Voltage :	AC 120V/60Hz
Test Mode :	TX N MODE 20M-BW CHANNEL 2412MHz/2462MHz (Vertical) (Antenna A+C)		
Note :	1. The transmitter was setup to transmit at the lowest channel (CH01). Then the field strength was measured at 2310-2390 MHz. 2. The transmitter was setup to transmit at the highest channel (CH11). Then the field strength was measured at 2483.5-2500 MHz.		

Freq.	Ant.Pol.	Reading		Ant./CF	Act.		Limit		Note
		Peak	AV		Peak	AV	Peak	AV	
(MHz)	H/V	(dBuV)	(dBuV)	CF(dB)	(dBuV/m)	(dBuV/m)	(dBuV/m)	(dBuV/m)	
2390.00	V	33.47	18.58	32.05	65.52	50.63	74.00	54.00	CH01
2483.50	V	37.42	19.94	32.35	69.77	52.29	74.00	54.00	CH11

Remark :

- (1) Radiated emissions measured in frequency range above 1000MHz were made with an instrument using Peak detector mode and AV detector mode of the emission .
- (2) EUT Orthogonal Axis :
 "X" - denotes Laid on Table ; "Y" - denotes Vertical Stand ; "Z" - denotes Side Stand
- (3) During the measurements above 1 GHz it is taken care of that the EUT is always within the 3 dB cone of radiation BW of the used antenna

Restricted Bands Requirements, Vertical
CH01

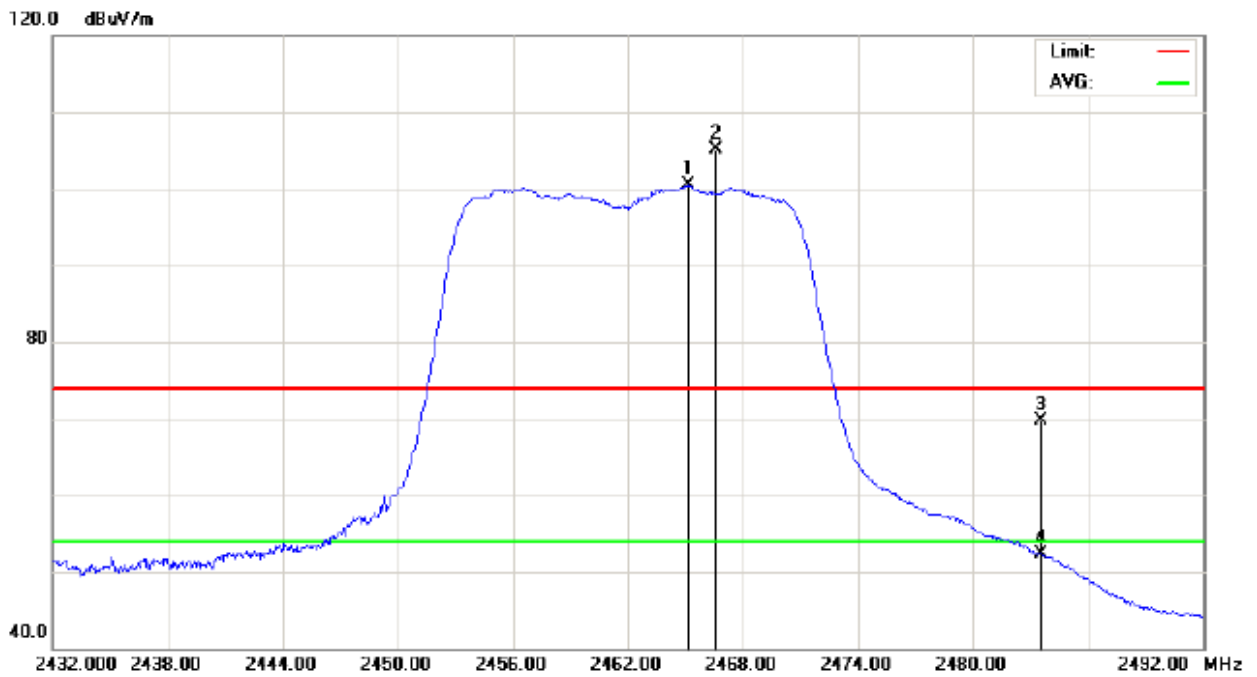
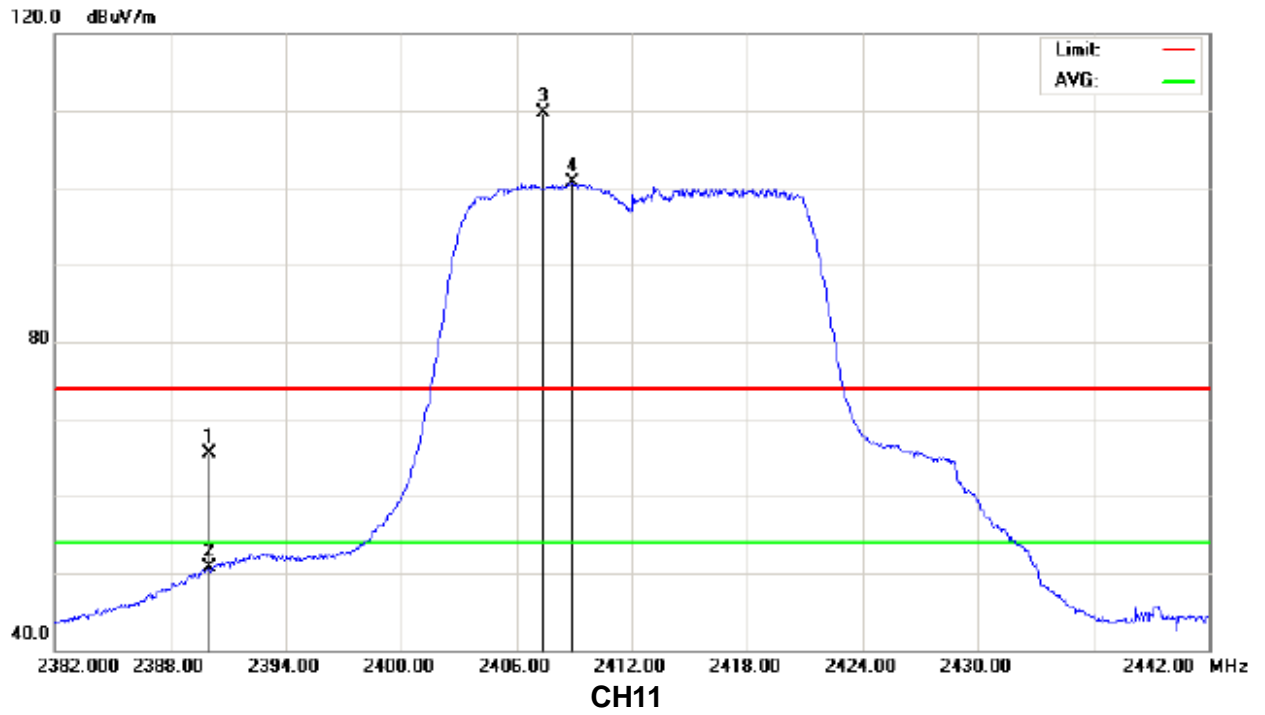

EUT :	802.11n High-speed Wireless Broadband Router	Model Name :	NW725
Temperature :	28 °C	Relative Humidity :	65%
Pressure :	1010 hPa	Test Voltage :	AC 120V/60Hz
Test Mode :	TX N MODE 20M-BW CHANNEL 2412MHz/2462MHz (Horizontal) (Antenna A+C)		
Note :	1. The transmitter was setup to transmit at the lowest channel (CH01). Then the field strength was measured at 2310-2390 MHz. 2. The transmitter was setup to transmit at the highest channel (CH11). Then the field strength was measured at 2483.5-2500 MHz.		

Freq.	Ant.Pol.	Reading		Ant./CF	Act.		Limit		Note
		Peak	AV		Peak	AV	Peak	AV	
(MHz)	H/V	(dBuV)	(dBuV)	CF(dB)	(dBuV/m)	(dBuV/m)	(dBuV/m)	(dBuV/m)	
2390.00	H	21.62	11.52	32.05	53.67	43.57	74.00	54.00	CH01
2483.50	H	27.00	14.16	32.35	59.35	46.51	74.00	54.00	CH11

Remark :

- (1) Radiated emissions measured in frequency range above 1000MHz were made with an instrument using Peak detector mode and AV detector mode of the emission .
- (2) EUT Orthogonal Axis :
 "X" - denotes Laid on Table ; "Y" - denotes Vertical Stand ; "Z" - denotes Side Stand
- (3) During the measurements above 1 GHz it is taken care of that the EUT is always within the 3 dB cone of radiation BW of the used antenna

Restricted Bands Requirements, Horizontal
CH01

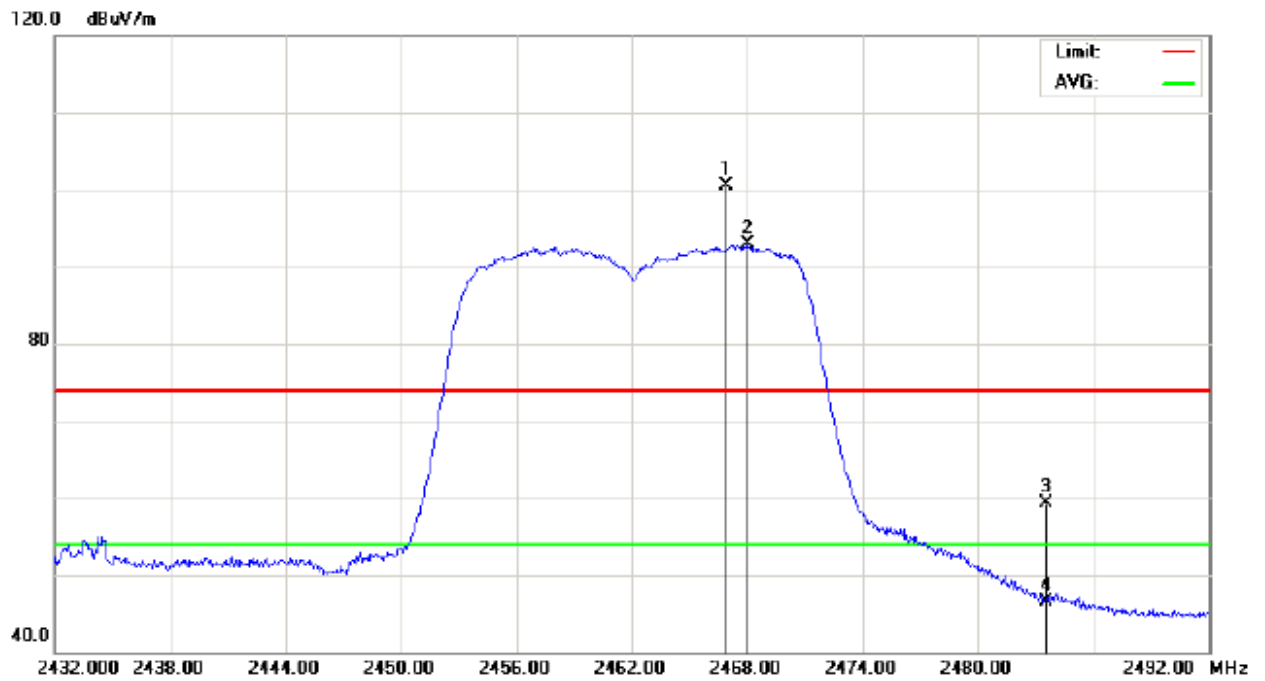
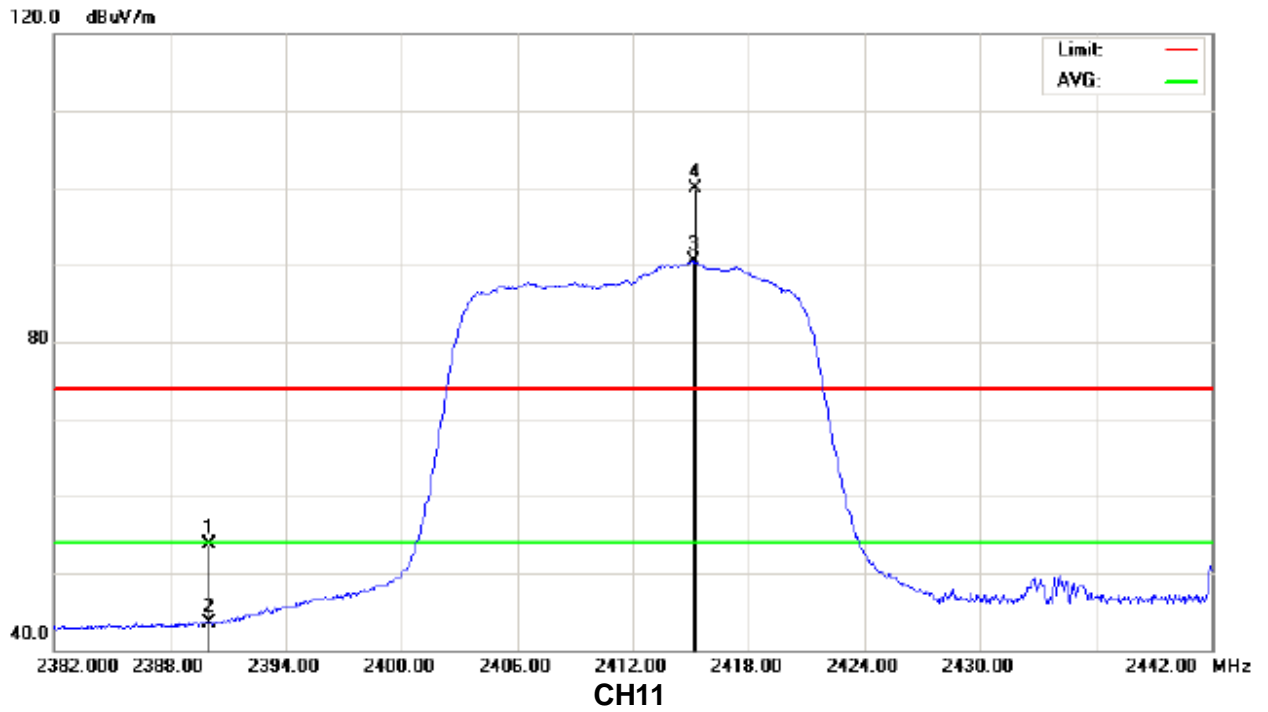

EUT :	802.11n High-speed Wireless Broadband Router	Model Name :	NW725
Temperature :	28 °C	Relative Humidity :	65%
Pressure :	1010 hPa	Test Voltage :	AC 120V/60Hz
Test Mode :	TX N MODE 40M-BW CHANNEL 2422MHz/2452MHz (Vertical) (Antenna A+C)		
Note :	1. The transmitter was setup to transmit at the lowest channel (CH03). Then the field strength was measured at 2310-2390 MHz. 2. The transmitter was setup to transmit at the highest channel (CH09). Then the field strength was measured at 2483.5-2500 MHz.		

Freq.	Ant.Pol.	Reading		Ant./CF	Act.		Limit		Note
		Peak	AV		Peak	AV	Peak	AV	
(MHz)	H/V	(dBuV)	(dBuV)	CF(dB)	(dBuV/m)	(dBuV/m)	(dBuV/m)	(dBuV/m)	
2390.00	V	31.00	21.19	32.05	63.05	53.24	74.00	54.00	CH03
2483.50	V	29.29	20.72	32.35	61.64	53.07	74.00	54.00	CH09

Remark :

- (1) Radiated emissions measured in frequency range above 1000MHz were made with an instrument using Peak detector mode and AV detector mode of the emission .
- (2) EUT Orthogonal Axis :
 "X" - denotes Laid on Table ; "Y" - denotes Vertical Stand ; "Z" - denotes Side Stand
- (3) During the measurements above 1 GHz it is taken care of that the EUT is always within the 3 dB cone of radiation BW of the used antenna

Restricted Bands Requirements, Vertical
CH03

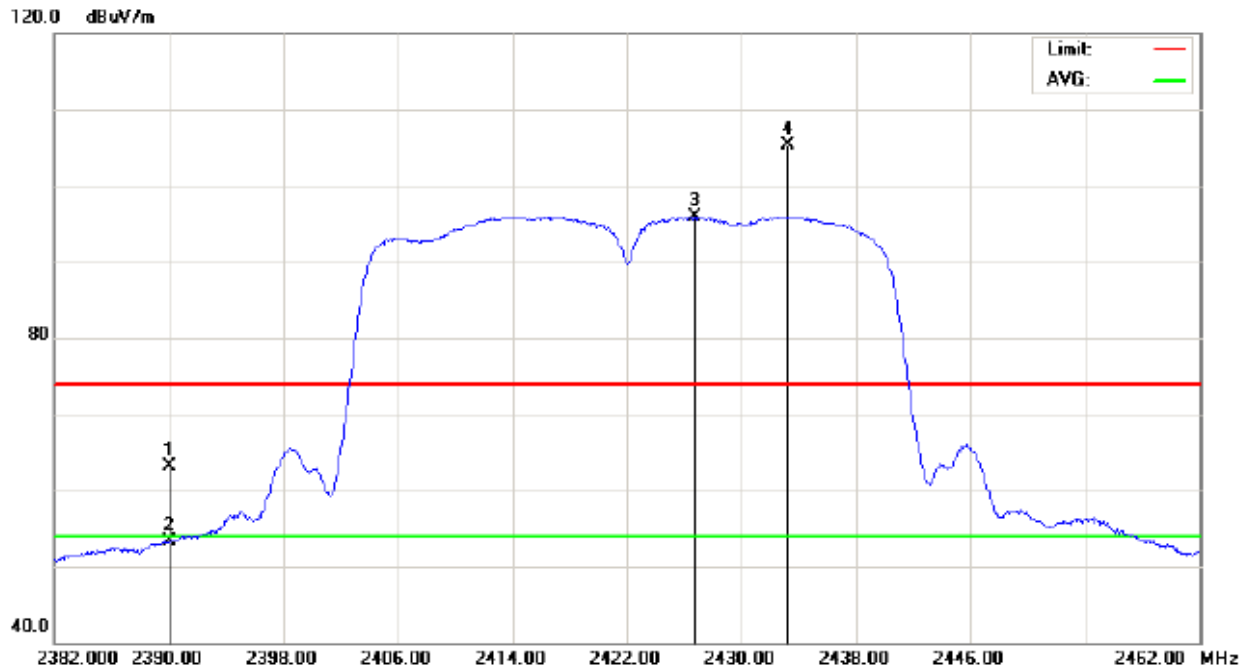

CH09

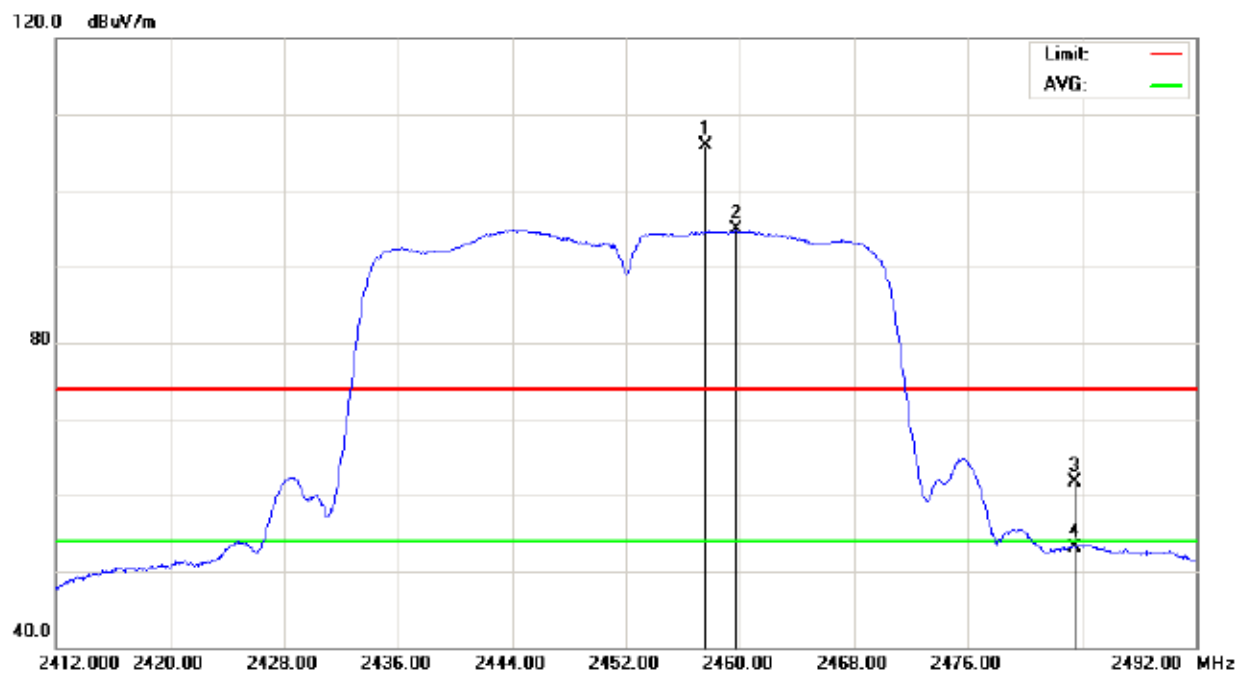

EUT :	802.11n High-speed Wireless Broadband Router	Model Name :	NW725
Temperature :	28 °C	Relative Humidity :	65%
Pressure :	1010 hPa	Test Voltage :	AC 120V/60Hz
Test Mode :	TX N MODE 40M-BW CHANNEL 2422MHz/2452MHz (Horizontal) (Antenna A+C)		
Note :	1. The transmitter was setup to transmit at the lowest channel (CH03). Then the field strength was measured at 2310-2390 MHz. 2. The transmitter was setup to transmit at the highest channel (CH09). Then the field strength was measured at 2483.5-2500 MHz.		

Freq.	Ant.Pol.	Reading		Ant./CF	Act.		Limit		Note
		Peak	AV		Peak	AV	Peak	AV	
(MHz)	H/V	(dBuV)	(dBuV)	CF(dB)	(dBuV/m)	(dBuV/m)	(dBuV/m)	(dBuV/m)	
2390.00	H	23.74	12.35	32.05	55.79	44.40	74.00	54.00	CH03
2483.50	H	23.33	13.07	32.35	55.68	45.42	74.00	54.00	CH09

Remark :

- (1) Radiated emissions measured in frequency range above 1000MHz were made with an instrument using Peak detector mode and AV detector mode of the emission .
- (2) EUT Orthogonal Axis :
 "X" - denotes Laid on Table ; "Y" - denotes Vertical Stand ; "Z" - denotes Side Stand
- (3) During the measurements above 1 GHz it is taken care of that the EUT is always within the 3 dB cone of radiation BW of the used antenna

Restricted Bands Requirements, Horizontal
CH03

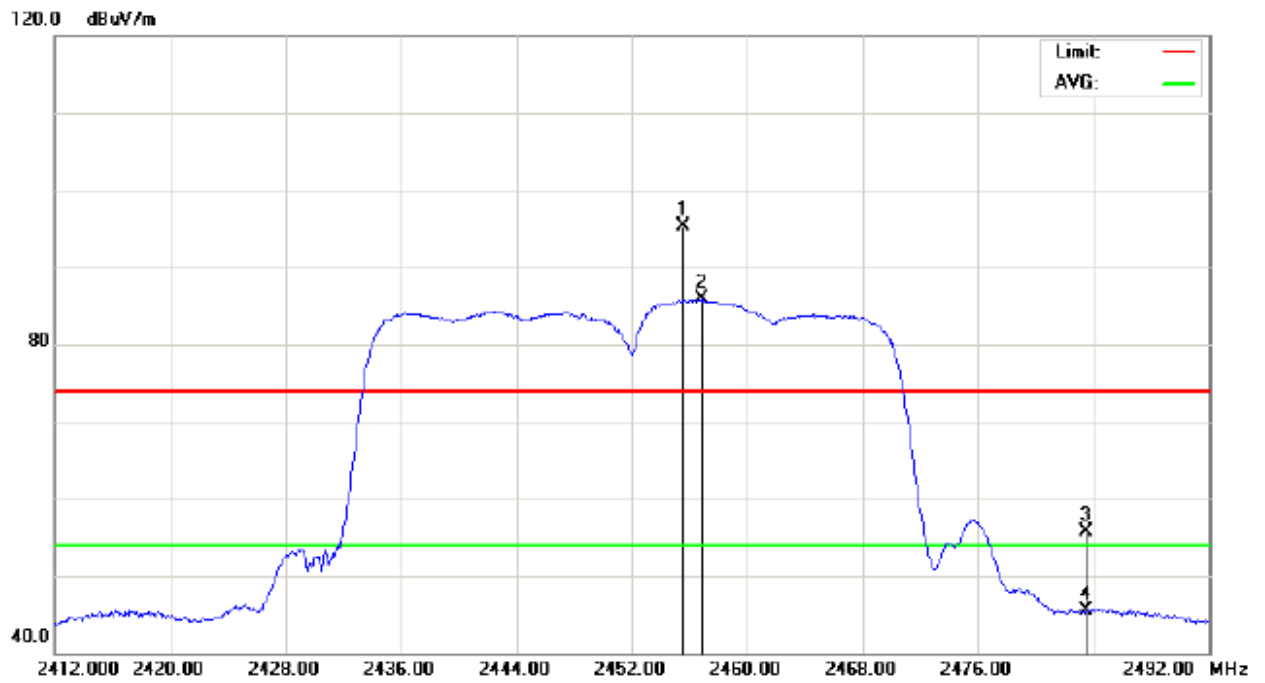
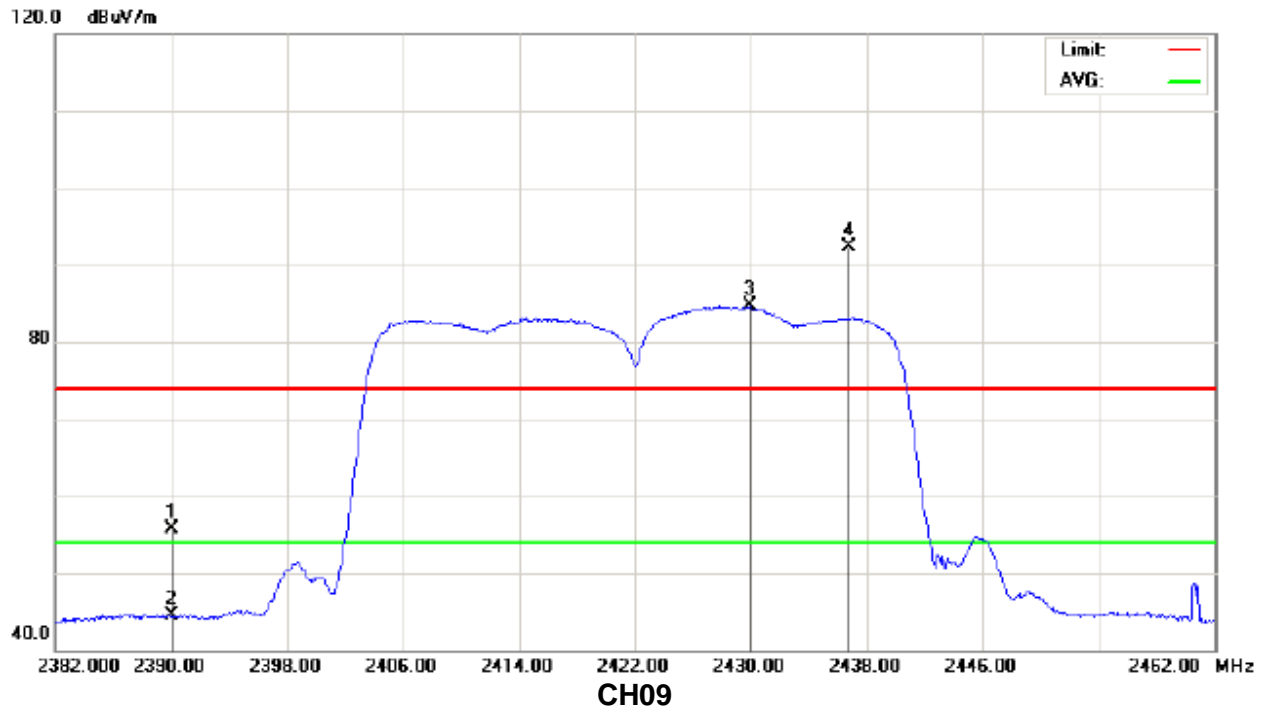

5. BANDWIDTH TEST

5.1 Applied procedures / limit

FCC Part15 (15.247) , Subpart C				
Section	Test Item	Limit	Frequency Range (MHz)	Result
15.247 (a)(2)	Bandwidth	$\geq 500\text{KHz}$ (6dB bandwidth)	2400-2483.5	PASS

5.1.1 MEASUREMENT INSTRUMENTS LIST

Item	Kind of Equipment	Manufacturer	Type No.	Serial No.	Calibrated until
1	Spectrum Analyzer	R&S	FSP_40	100129	Jan. 07, 2009

Remark: " N/A" denotes No Model Name. , Serial No. or No Calibration specified.

5.1.2 TEST PROCEDURE

- a. The EUT was directly connected to the spectrum analyzer and antenna output port as show in the block diagram below,
- b. Spectrum Setting : RBW= 100KHz, VBW=100KHz, Sweep time = 20 ms.

5.1.3 DEVIATION FROM STANDARD

No deviation.

5.1.4 TEST SETUP



5.1.5 EUT OPERATION CONDITIONS

The EUT tested system was configured as the statements of 4.1.6 Unless otherwise a special operating condition is specified in the follows during the testing.

5.1.6 TEST RESULTS

EUT :	802.11n High-speed Wireless Broadband Router	Model Name :	NW725
Temperature :	25 °C	Relative Humidity :	60%
Pressure :	1016 hPa	Test Voltage :	AC 120V/60Hz
Test Mode :	TX B mode /CH01, CH06, CH11		

Test Channel	Frequency (MHz)	Bandwidth (MHz)	99% Occupied BW (MHz)	LIMIT (MHz)
CH01	2412	9.98	14.69	>=500KHz
CH06	2437	9.90	14.61	>=500KHz
CH11	2462	9.98	14.61	>=500KHz

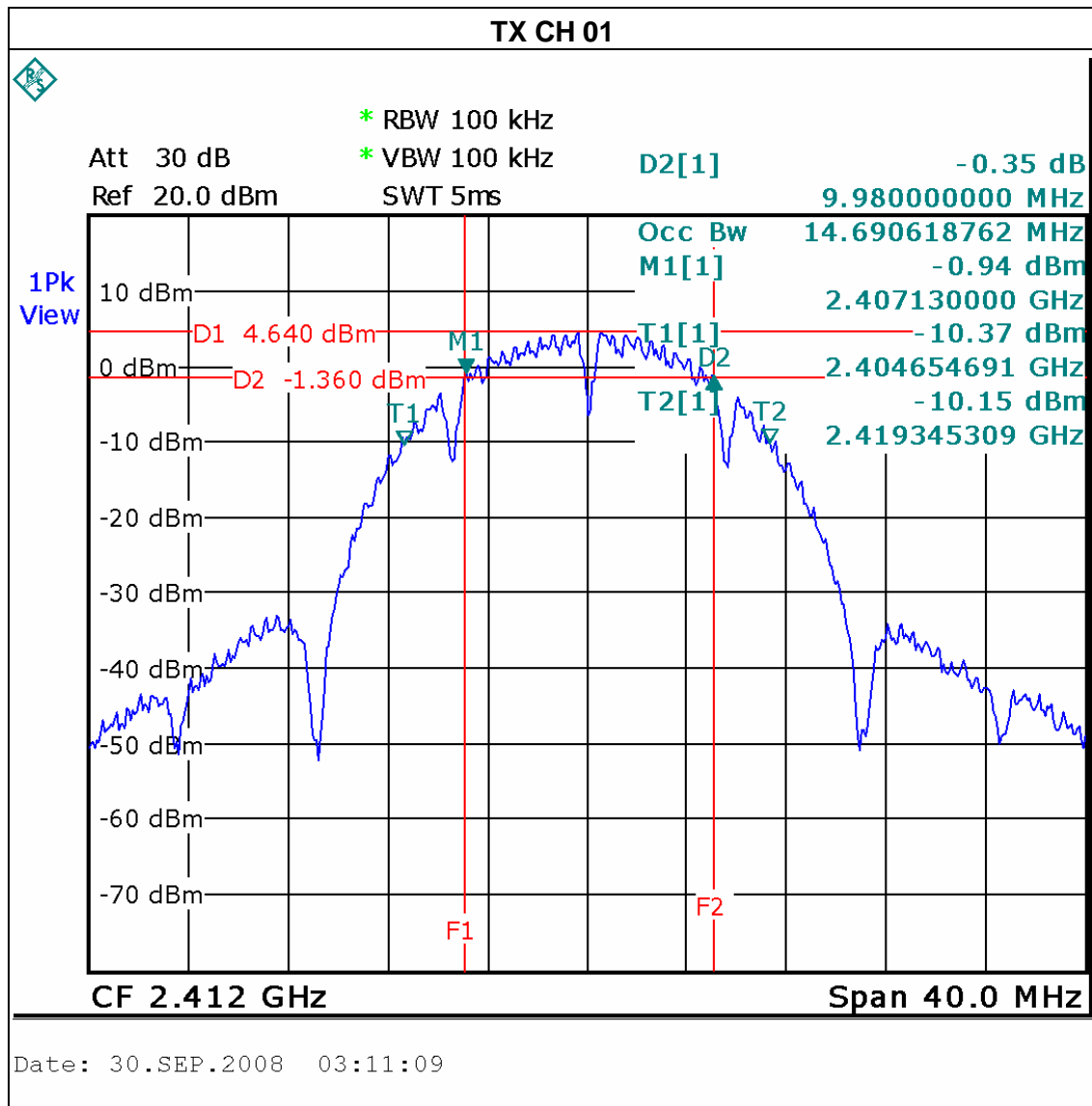

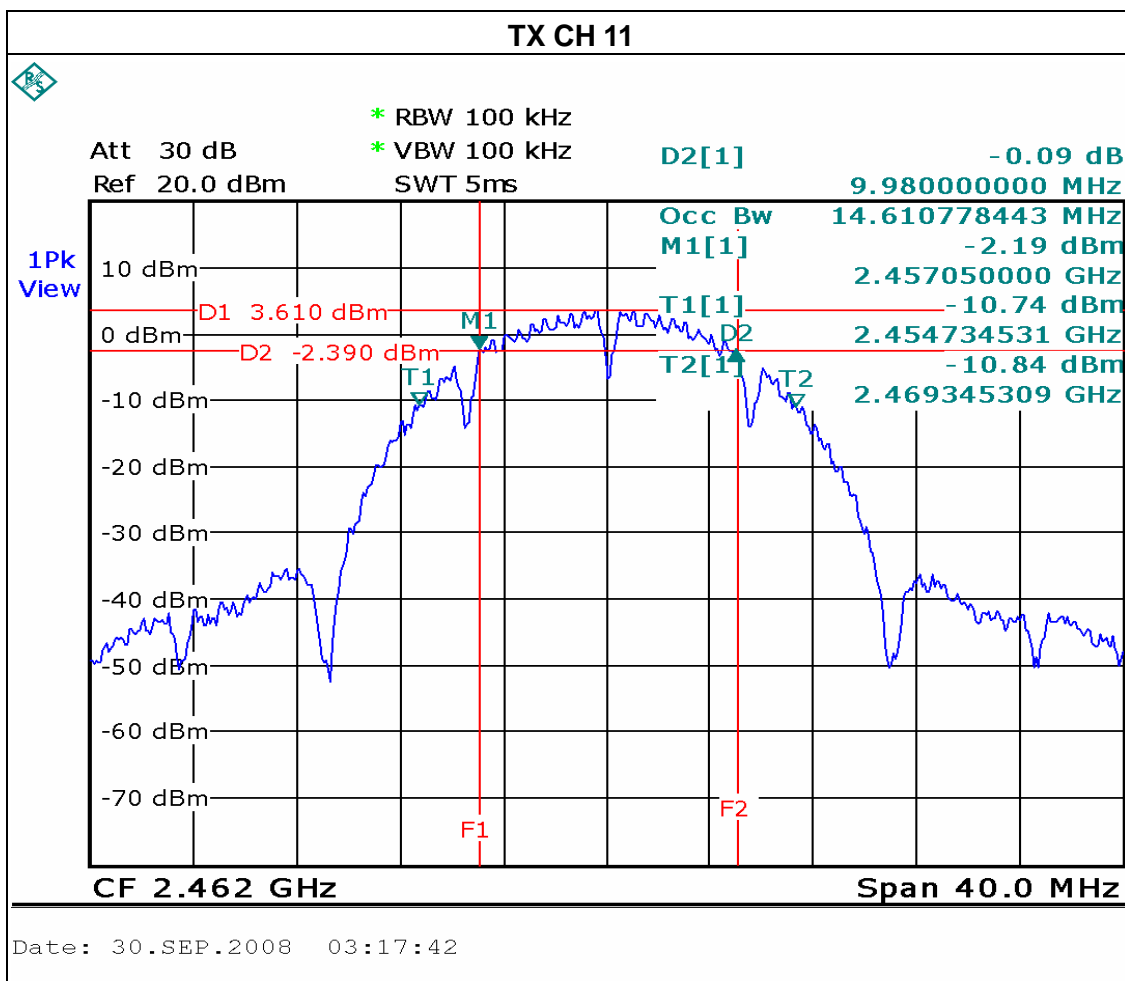
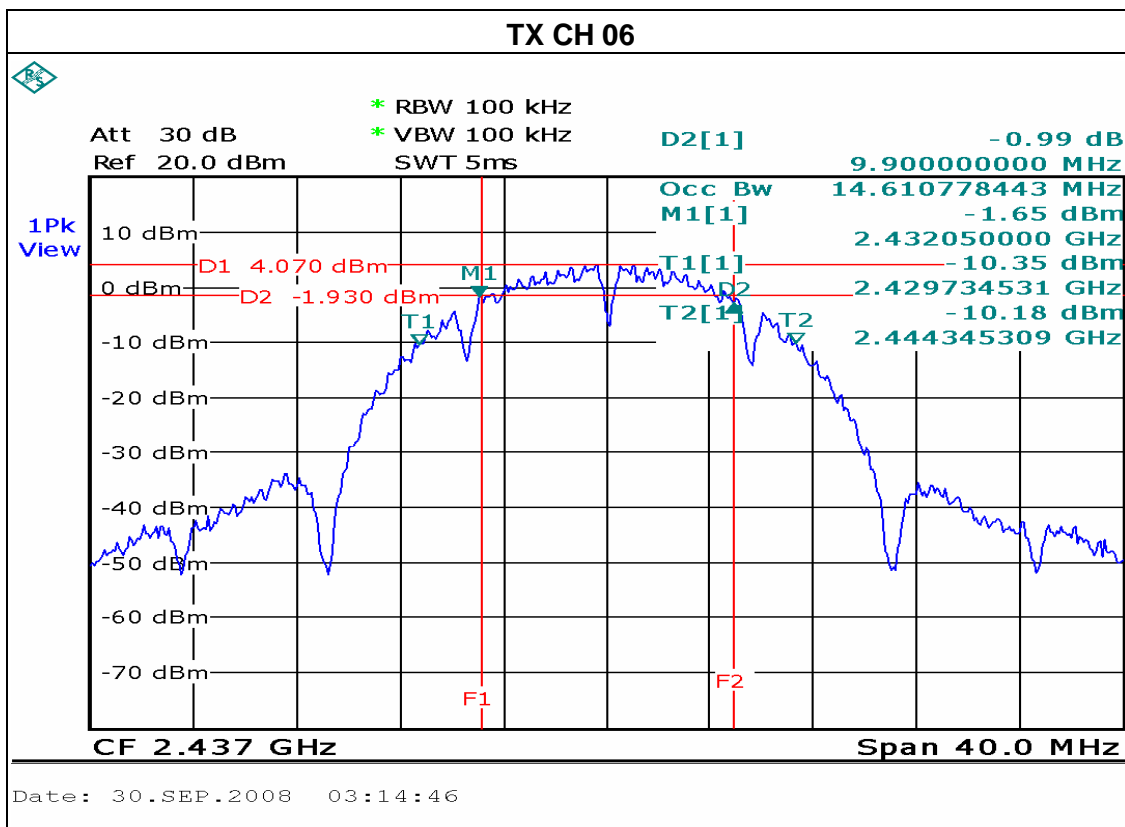

EUT :	802.11n High-speed Wireless Broadband Router	Model Name :	NW725
Temperature :	25 °C	Relative Humidity :	60%
Pressure :	1016 hPa	Test Voltage :	AC 120V/60Hz
Test Mode :	TX G mode /CH01, CH06, CH11		

Test Channel	Frequency (MHz)	Bandwidth (MHz)	99% Occupied BW (MHz)	LIMIT (MHz)
CH01	2412	16.45	16.45	>=500KHz
CH06	2437	16.61	16.45	>=500KHz
CH11	2462	16.61	16.45	>=500KHz

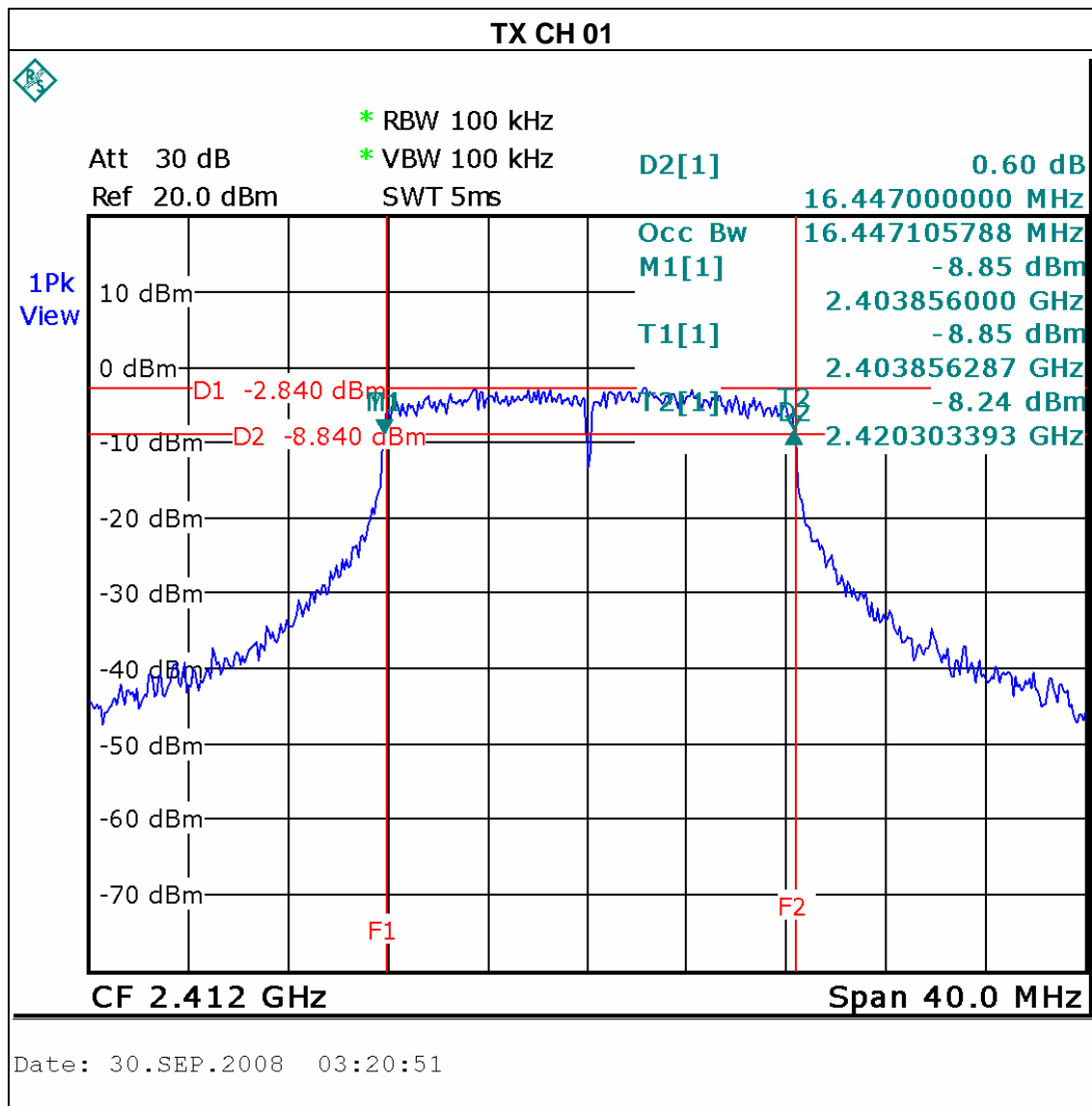

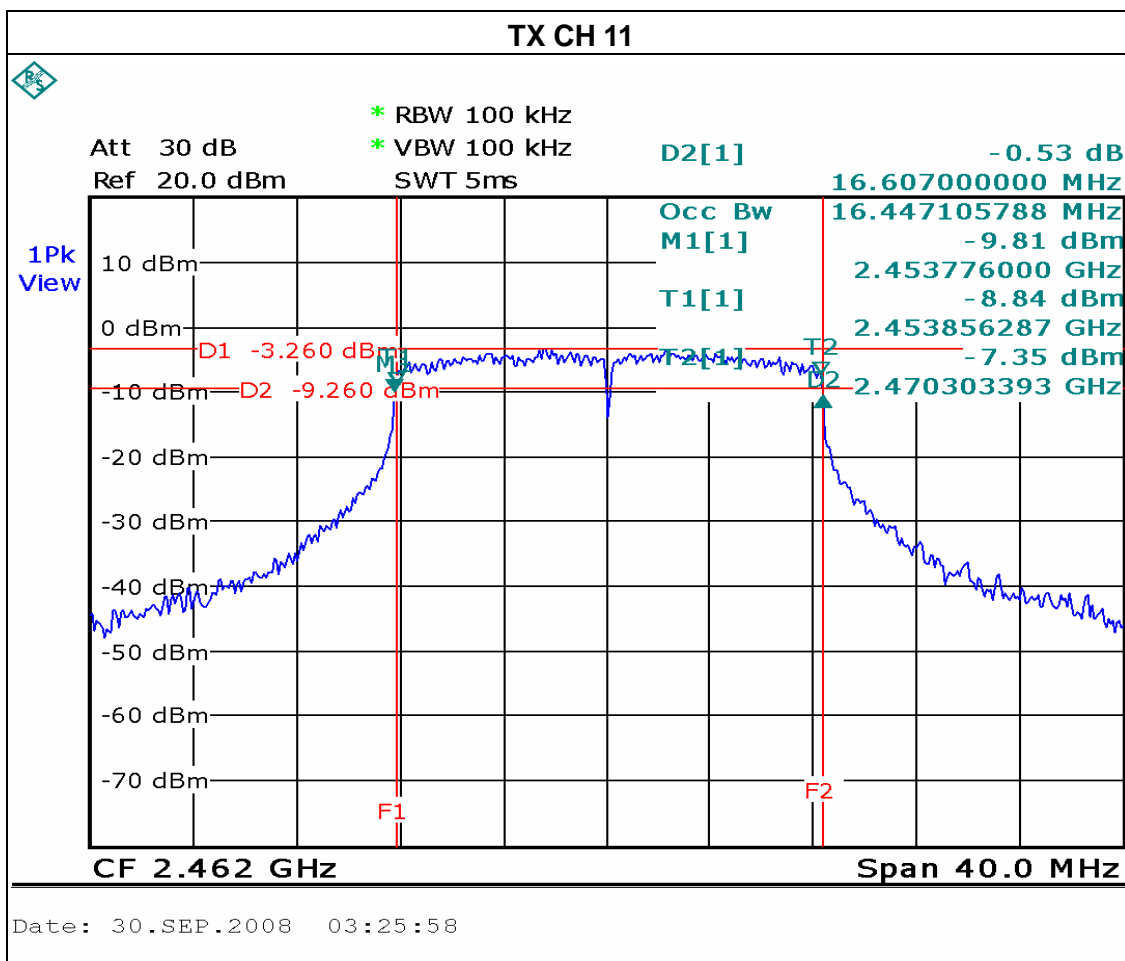
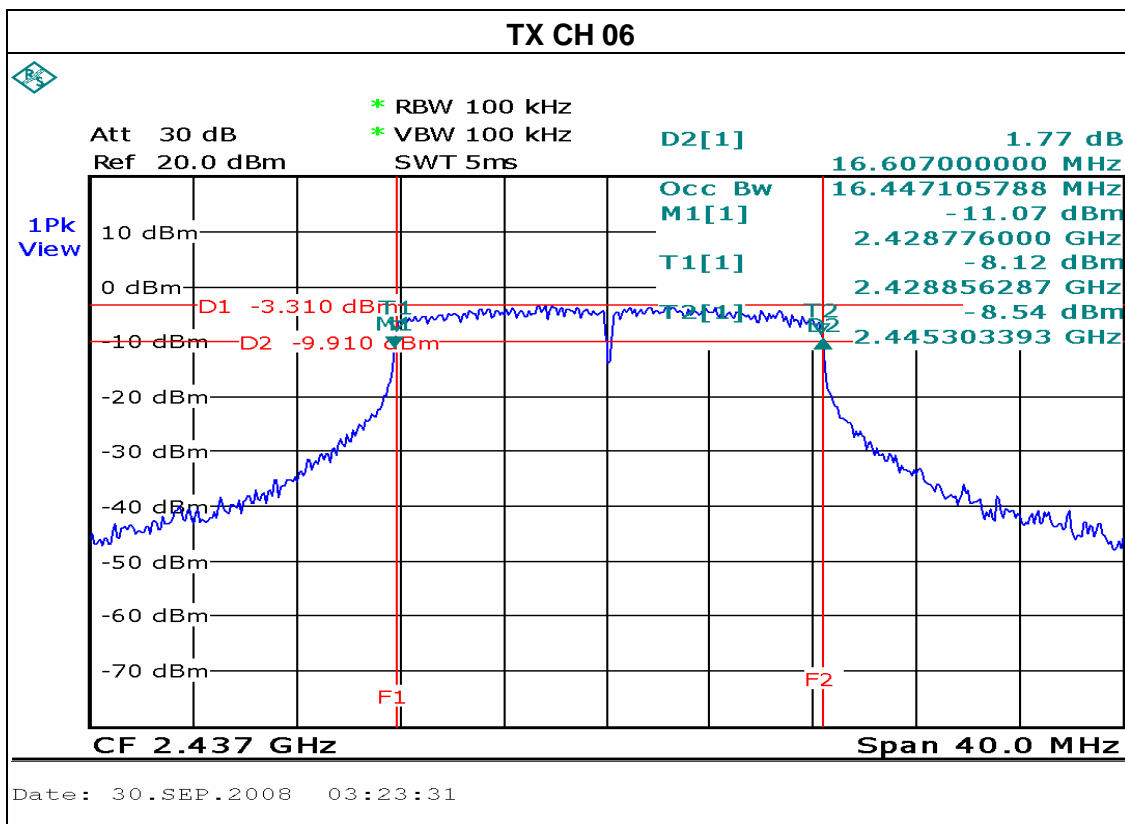

EUT :	802.11n High-speed Wireless Broadband Router	Model Name :	NW725
Temperature :	25 °C	Relative Humidity :	60%
Pressure :	1016 hPa	Test Voltage :	AC 120V/60Hz
Test Mode :	802.11n/20M/CH01, CH06, CH11(Antenna A)		

Test Channel	Frequency (MHz)	Bandwidth (MHz)	99% Occupied BW (MHz)	LIMIT (MHz)
CH01	2412	17.73	17.64	>=500KHz
CH06	2437	17.73	17.72	>=500KHz
CH11	2462	17.73	17.72	>=500KHz

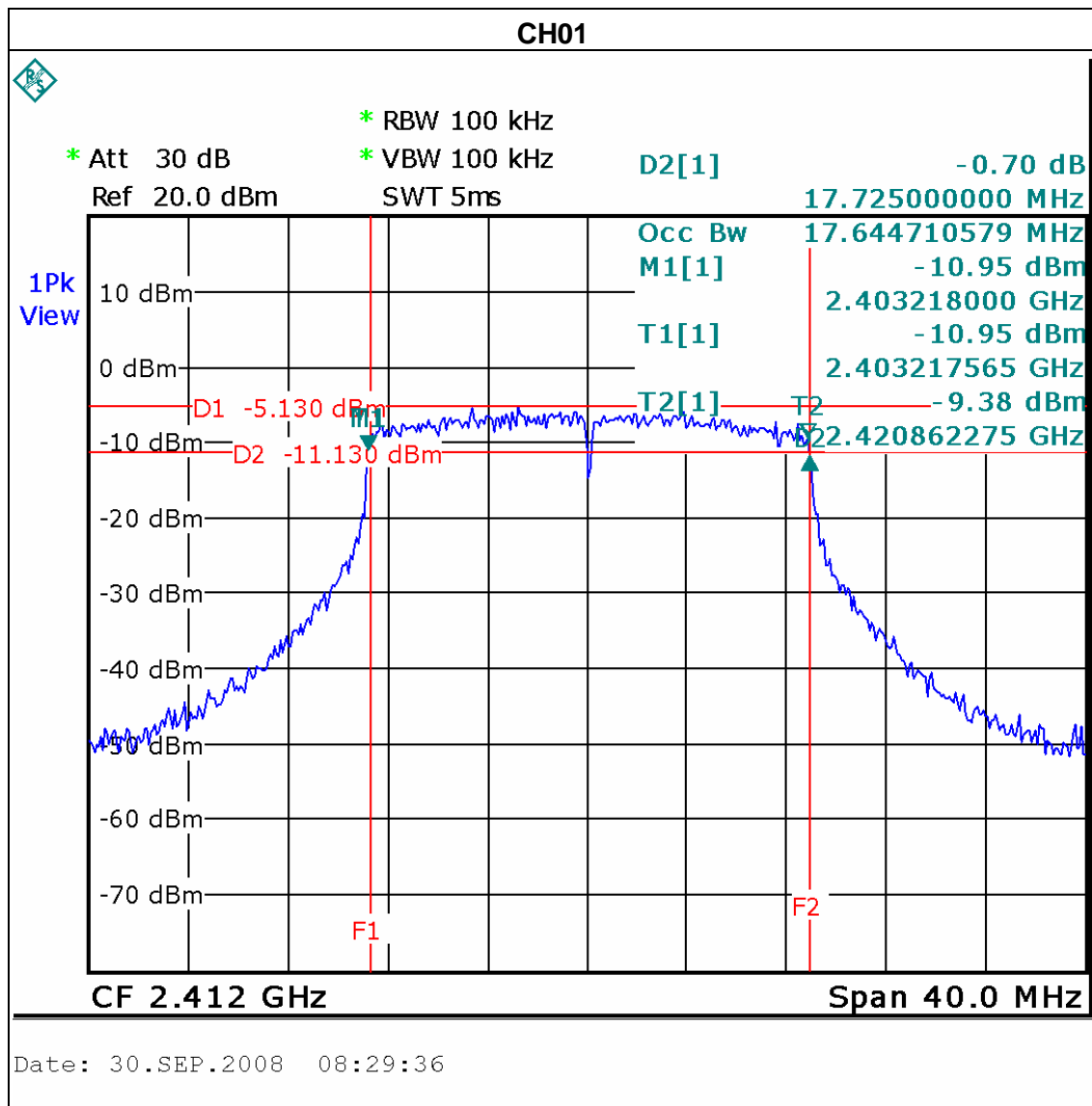

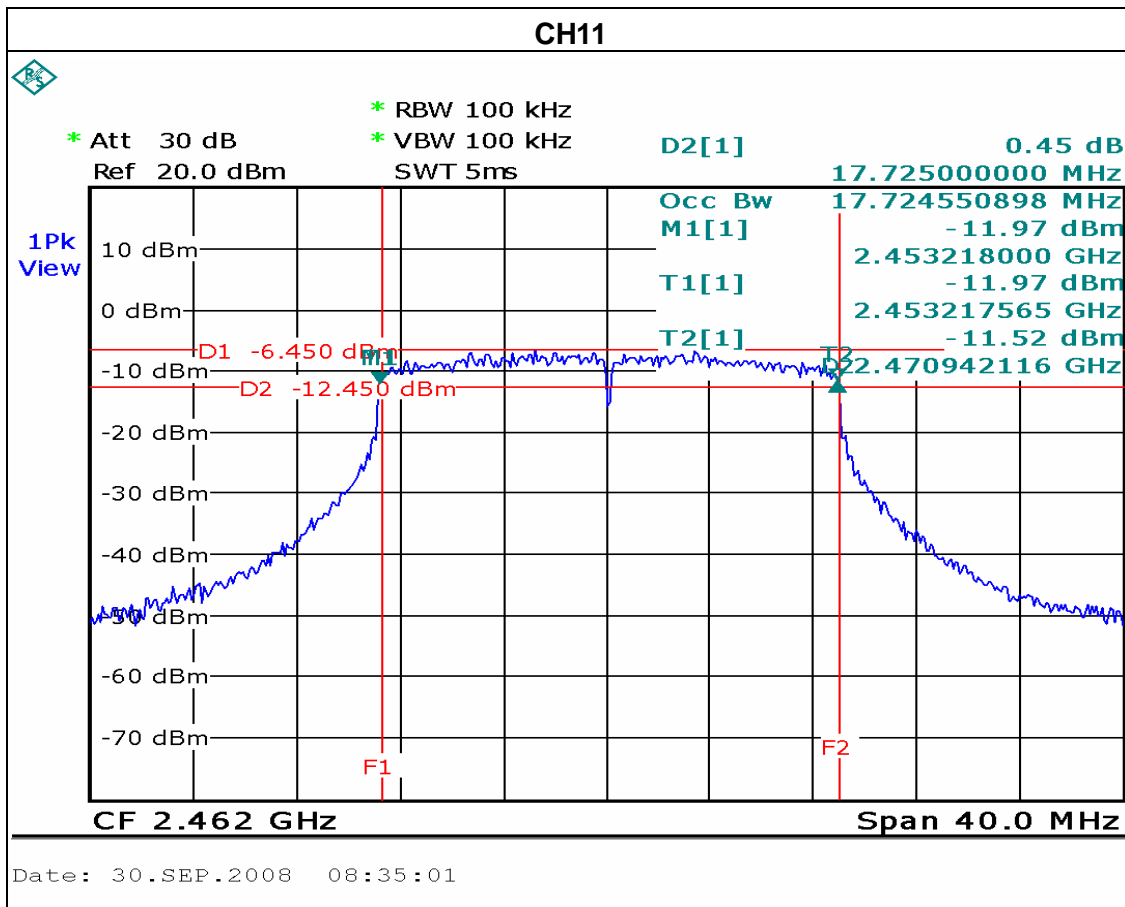
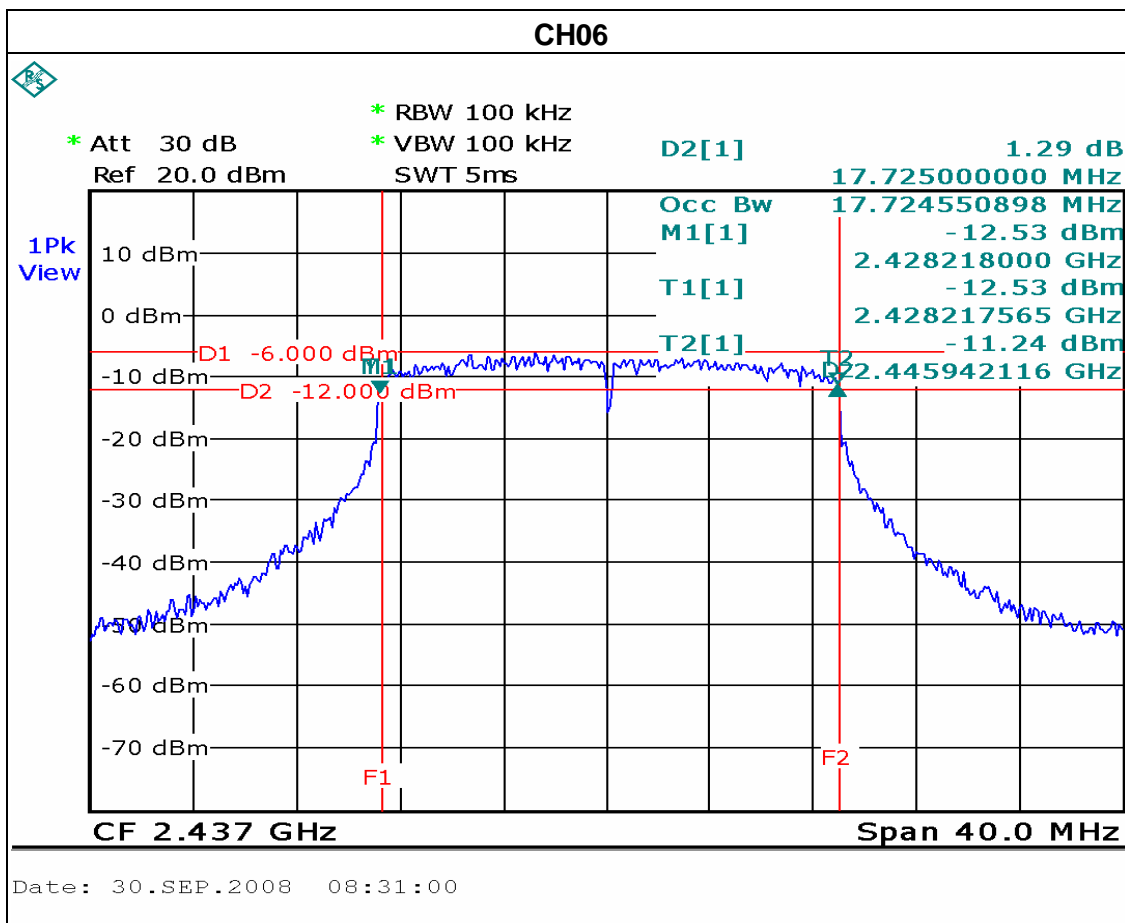

EUT :	802.11n High-speed Wireless Broadband Router	Model Name :	NW725
Temperature :	25 °C	Relative Humidity :	60%
Pressure :	1016 hPa	Test Voltage :	AC 120V/60Hz
Test Mode :	802.11n/20M/CH01, CH06, CH11(Antenna C)		

Test Channel	Frequency (MHz)	Bandwidth (MHz)	99% Occupied BW (MHz)	LIMIT (MHz)
CH01	2412	17.73	17.64	>=500KHz
CH06	2437	17.73	17.64	>=500KHz
CH11	2462	17.80	17.72	>=500KHz

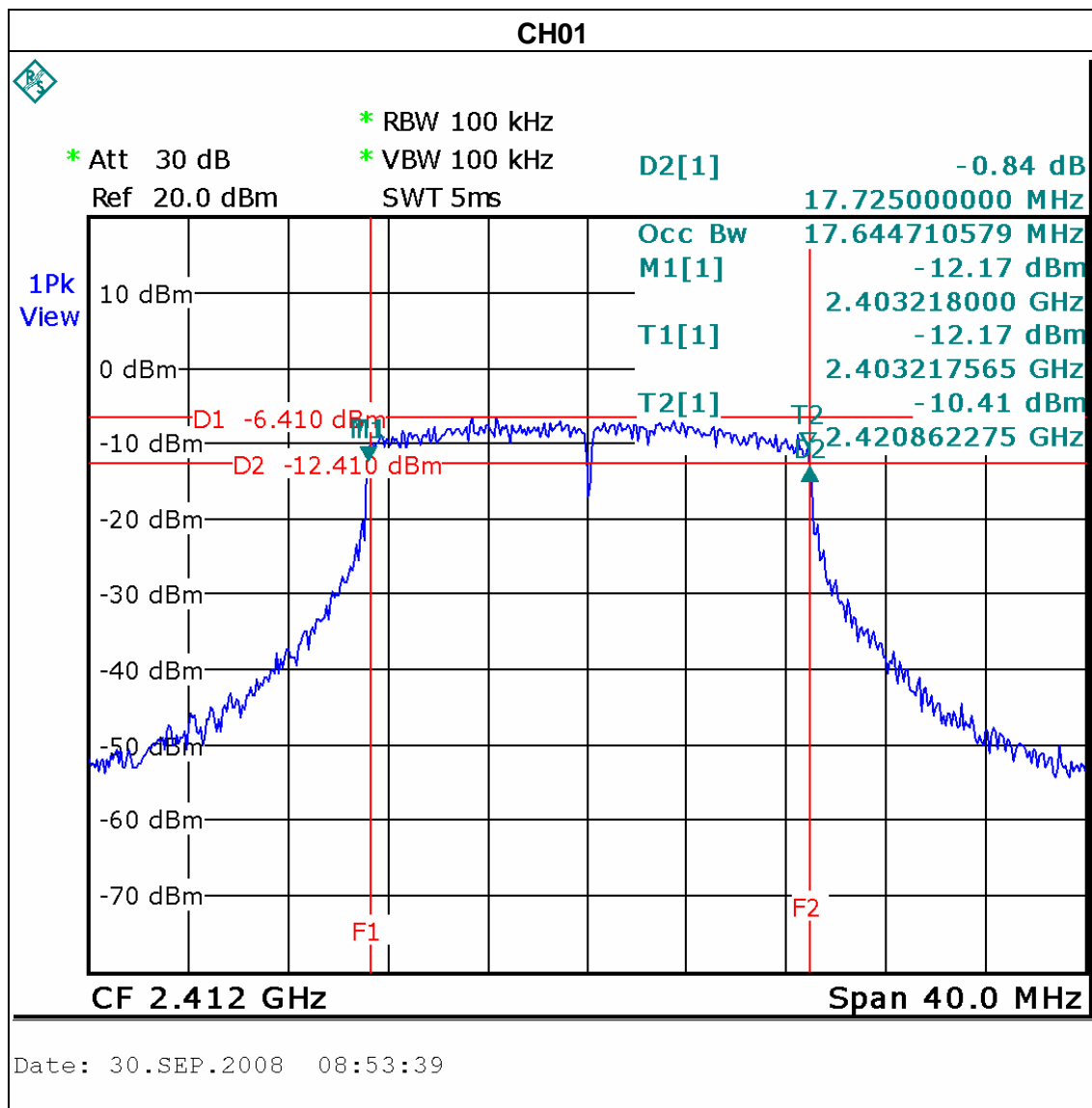

EUT :	802.11n High-speed Wireless Broadband Router	Model Name :	NW725
Temperature :	25 °C	Relative Humidity :	60%
Pressure :	1016 hPa	Test Voltage :	AC 120V/60Hz
Test Mode :	802.11n/20M/CH01, CH06, CH11(Antenna A+C)		

Test Channel	Frequency (MHz)	Bandwidth (MHz)	99% Occupied BW (MHz)	LIMIT (MHz)
CH01	2412	12.46	14.93	>=500KHz
CH06	2437	17.80	17.80	>=500KHz
CH11	2462	17.88	17.88	>=500KHz

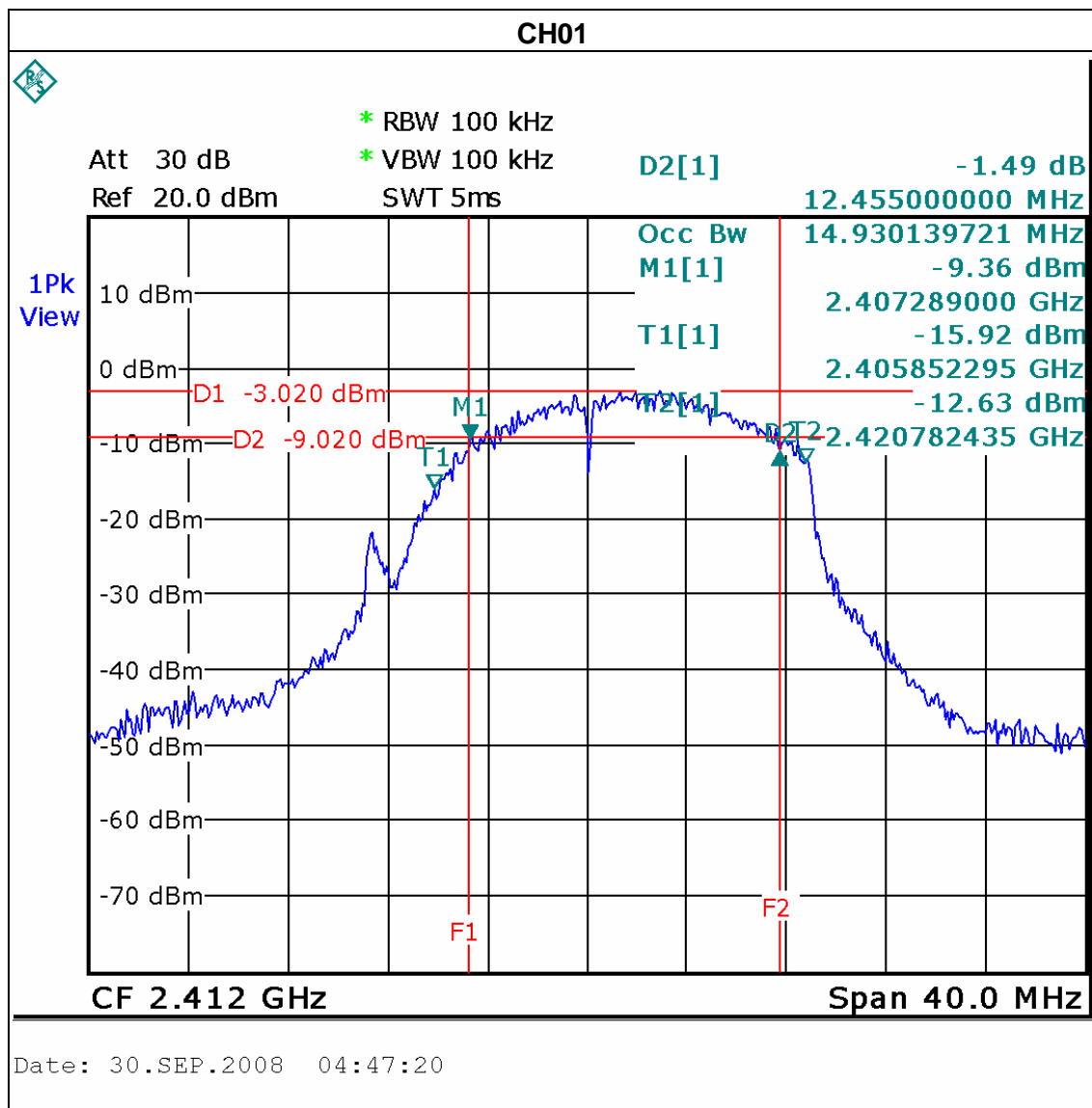

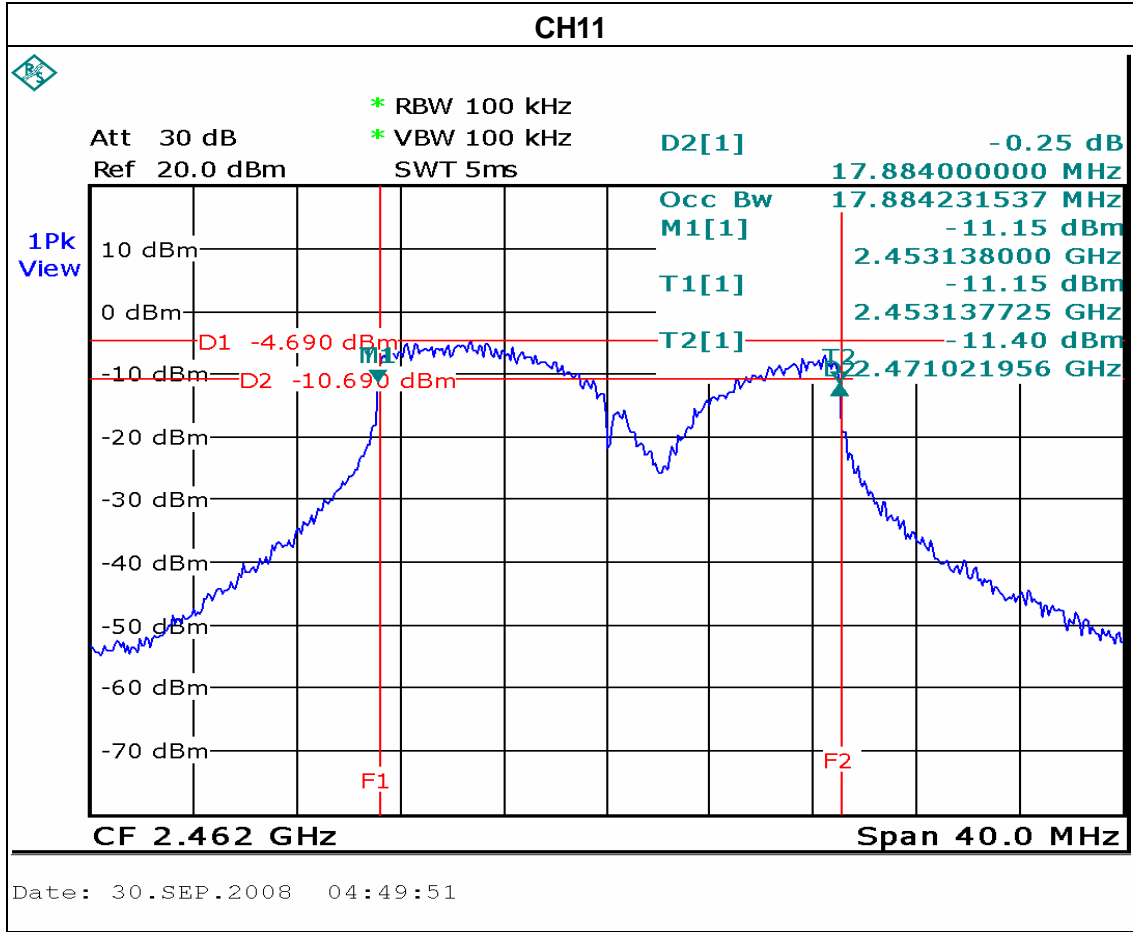
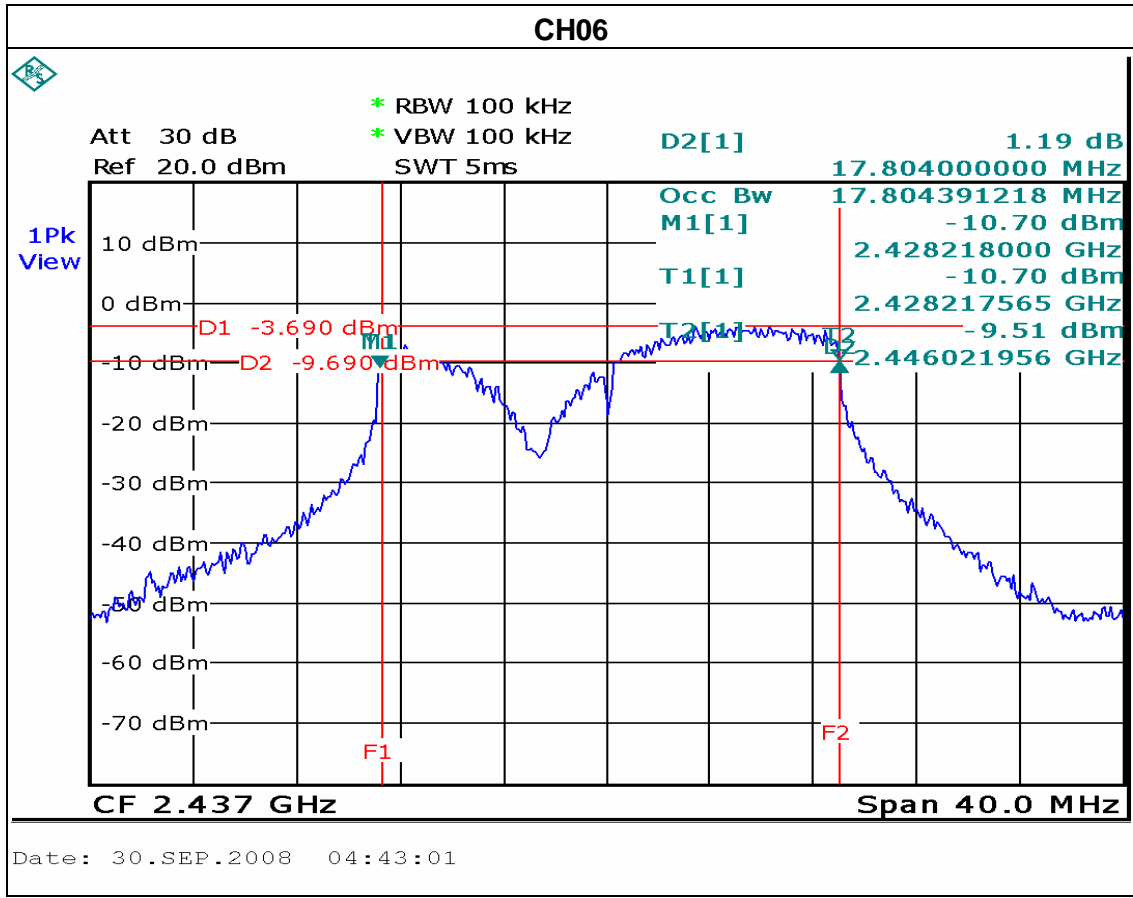

EUT :	802.11n High-speed Wireless Broadband Router	Model Name :	NW725
Temperature :	25 °C	Relative Humidity :	60%
Pressure :	1016 hPa	Test Voltage :	AC 120V/60Hz
Test Mode :	802.11n/40M/CH03, CH06, CH09(Antenna A)		

Test Channel	Frequency (MHz)	Bandwidth (MHz)	99% Occupied BW (MHz)	LIMIT (MHz)
CH03	2422	36.53	36.05	>=500KHz
CH06	2437	36.41	35.93	>=500KHz
CH09	2452	36.41	36.05	>=500KHz

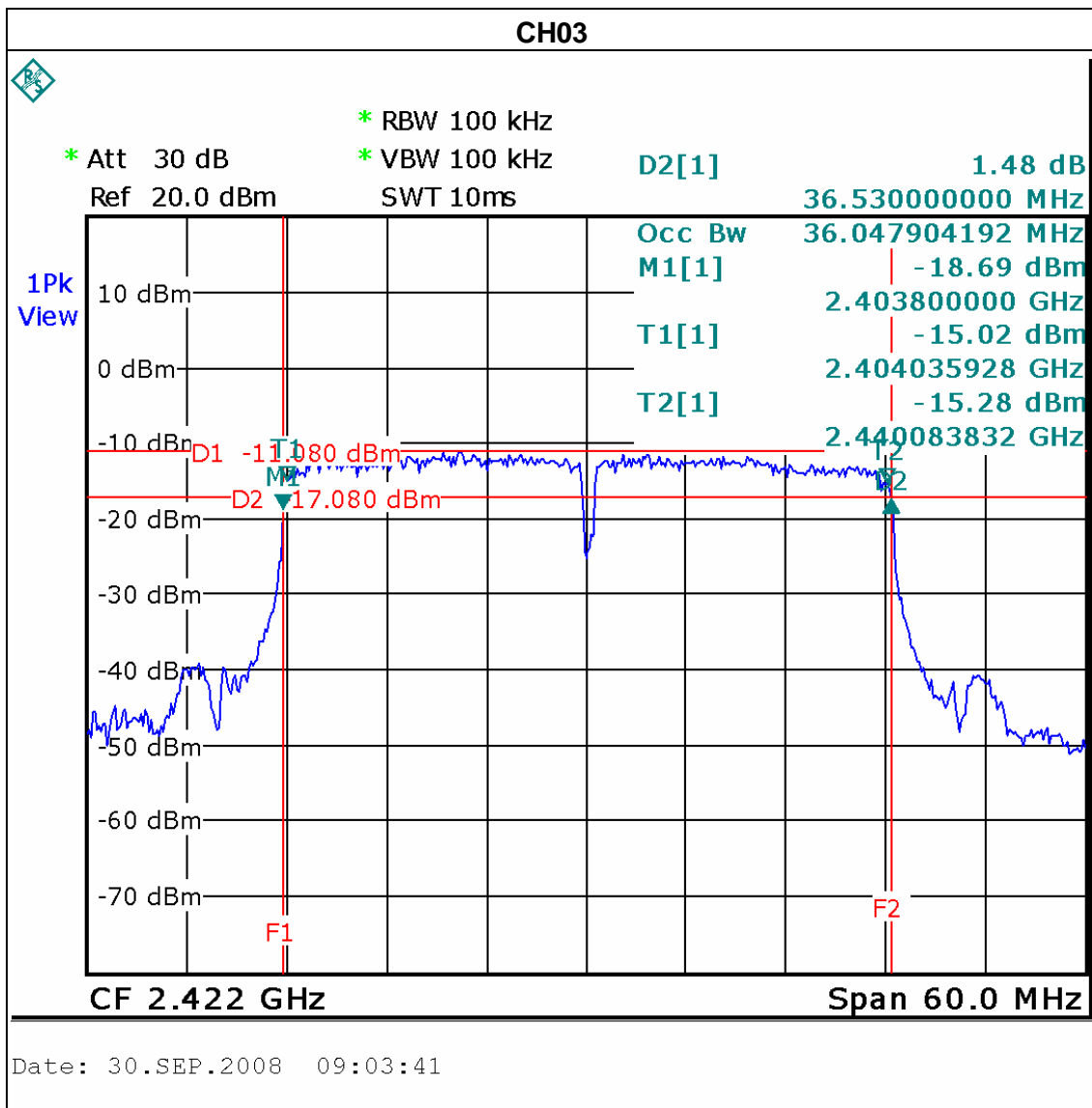

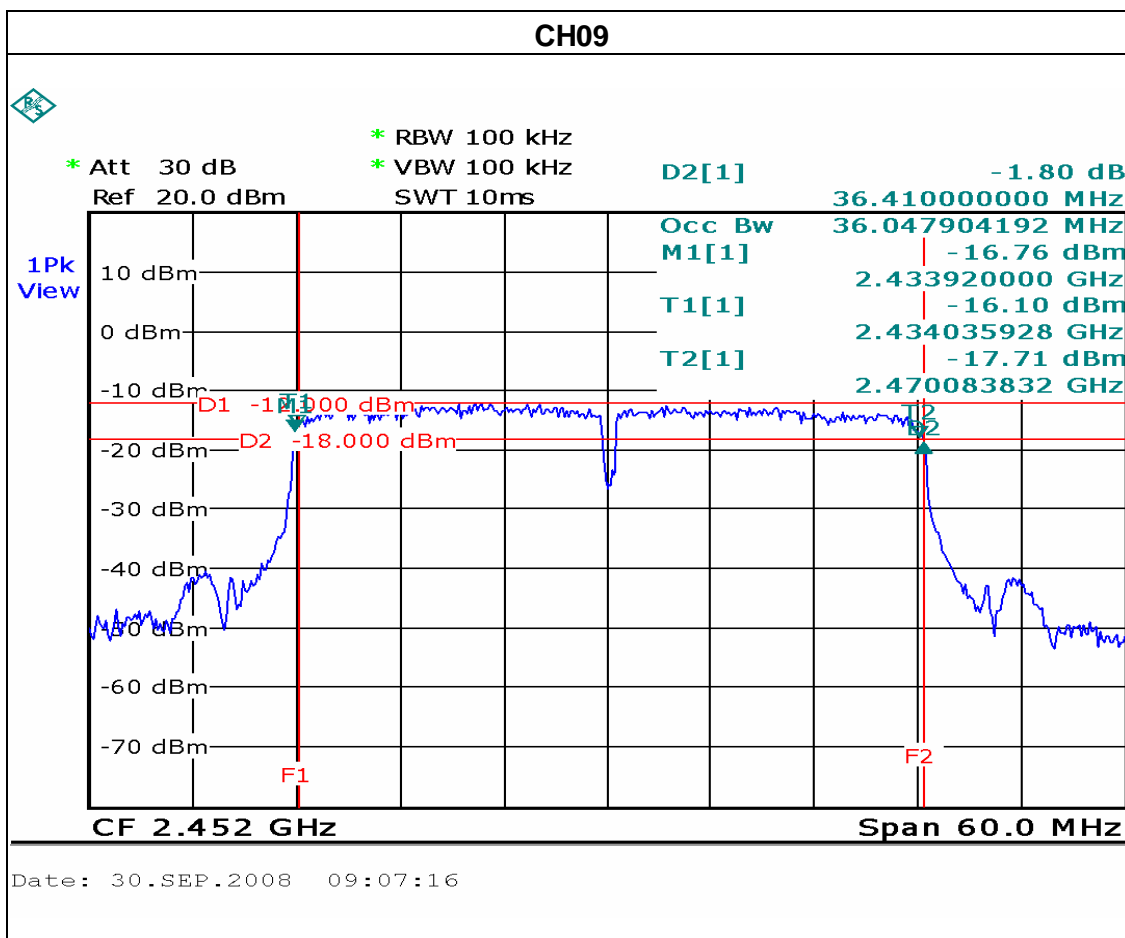
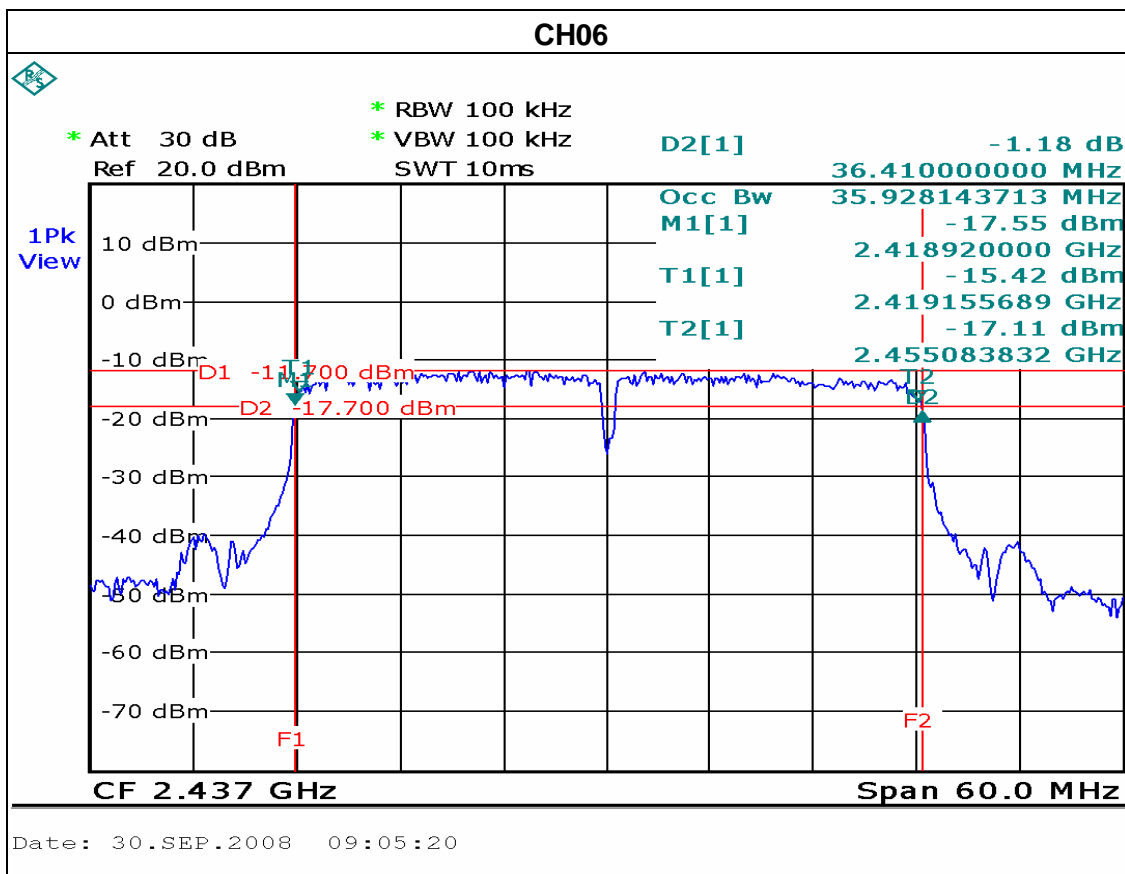

EUT :	802.11n High-speed Wireless Broadband Router	Model Name :	NW725
Temperature :	25 °C	Relative Humidity :	60%
Pressure :	1016 hPa	Test Voltage :	AC 120V/60Hz
Test Mode :	802.11n/40M/CH03, CH06, CH09(Antenna C)		

Test Channel	Frequency (MHz)	Bandwidth (MHz)	99% Occupied BW (MHz)	LIMIT (MHz)
CH03	2422	36.29	36.05	>=500KHz
CH06	2437	36.17	35.93	>=500KHz
CH09	2452	36.41	35.93	>=500KHz

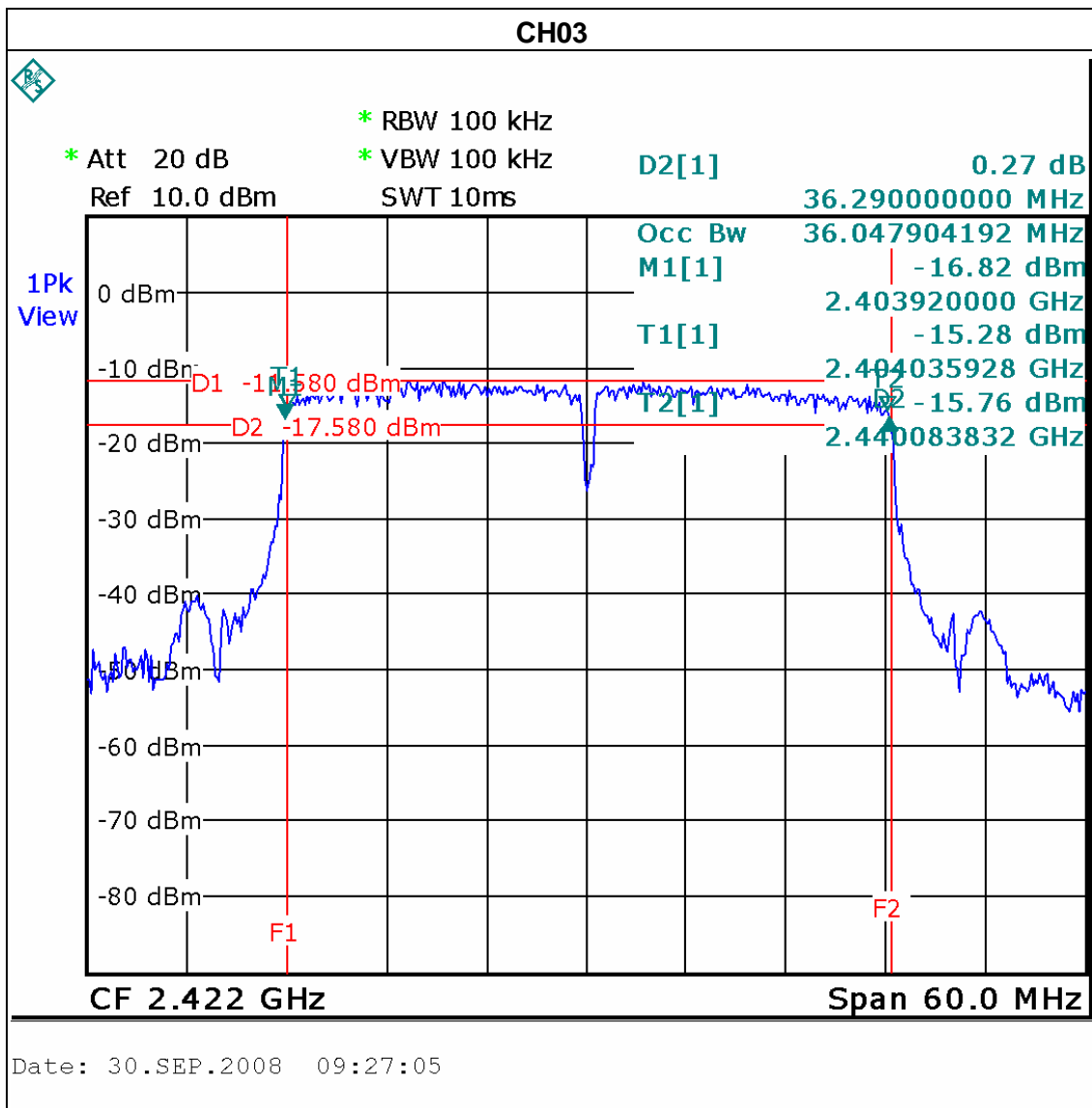

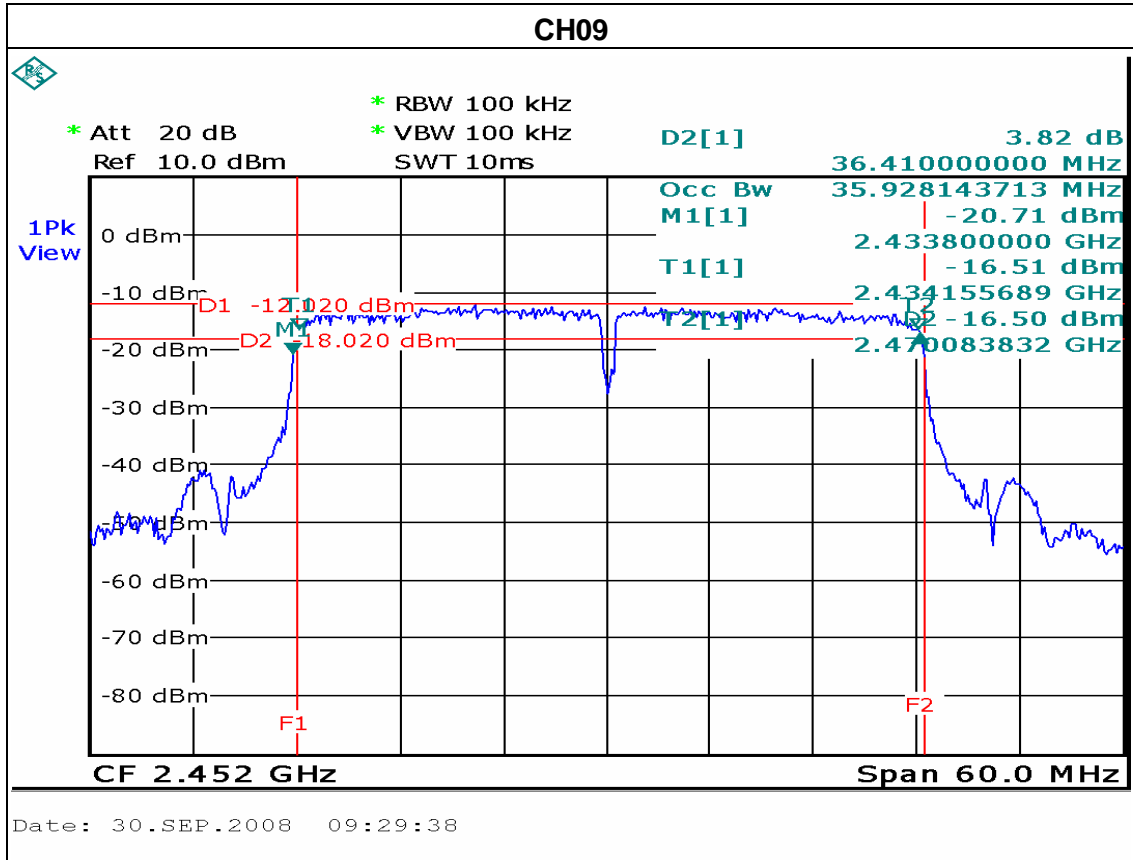
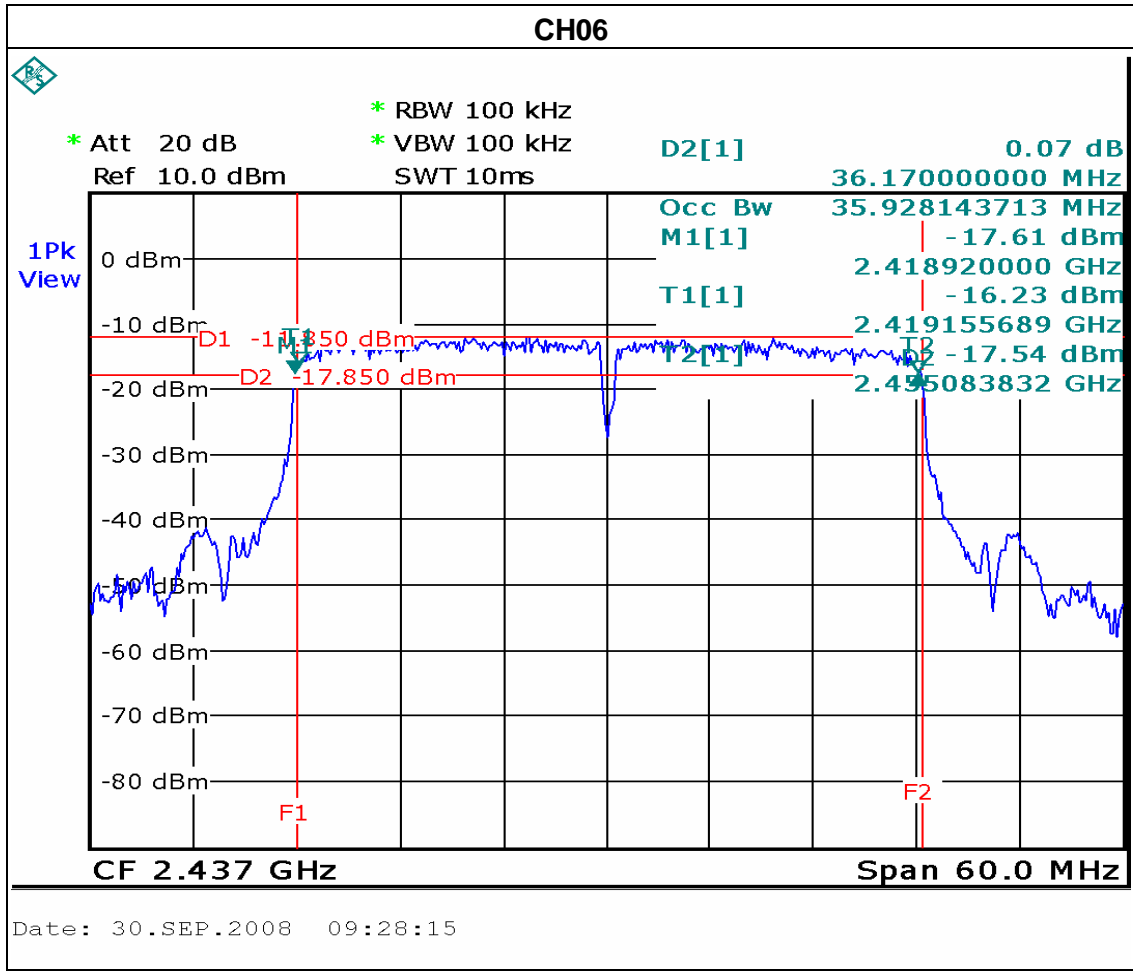

EUT :	802.11n High-speed Wireless Broadband Router	Model Name :	NW725
Temperature :	25 °C	Relative Humidity :	60%
Pressure :	1016 hPa	Test Voltage :	AC 120V/60Hz
Test Mode :	802.11n/40M/CH03, CH06, CH09(Antenna A+C)		

Test Channel	Frequency (MHz)	Bandwidth (MHz)	99% Occupied BW (MHz)	LIMIT (MHz)
CH03	2422	36.29	36.29	>=500KHz
CH06	2437	36.29	36.17	>=500KHz
CH09	2452	31.14	33.53	>=500KHz

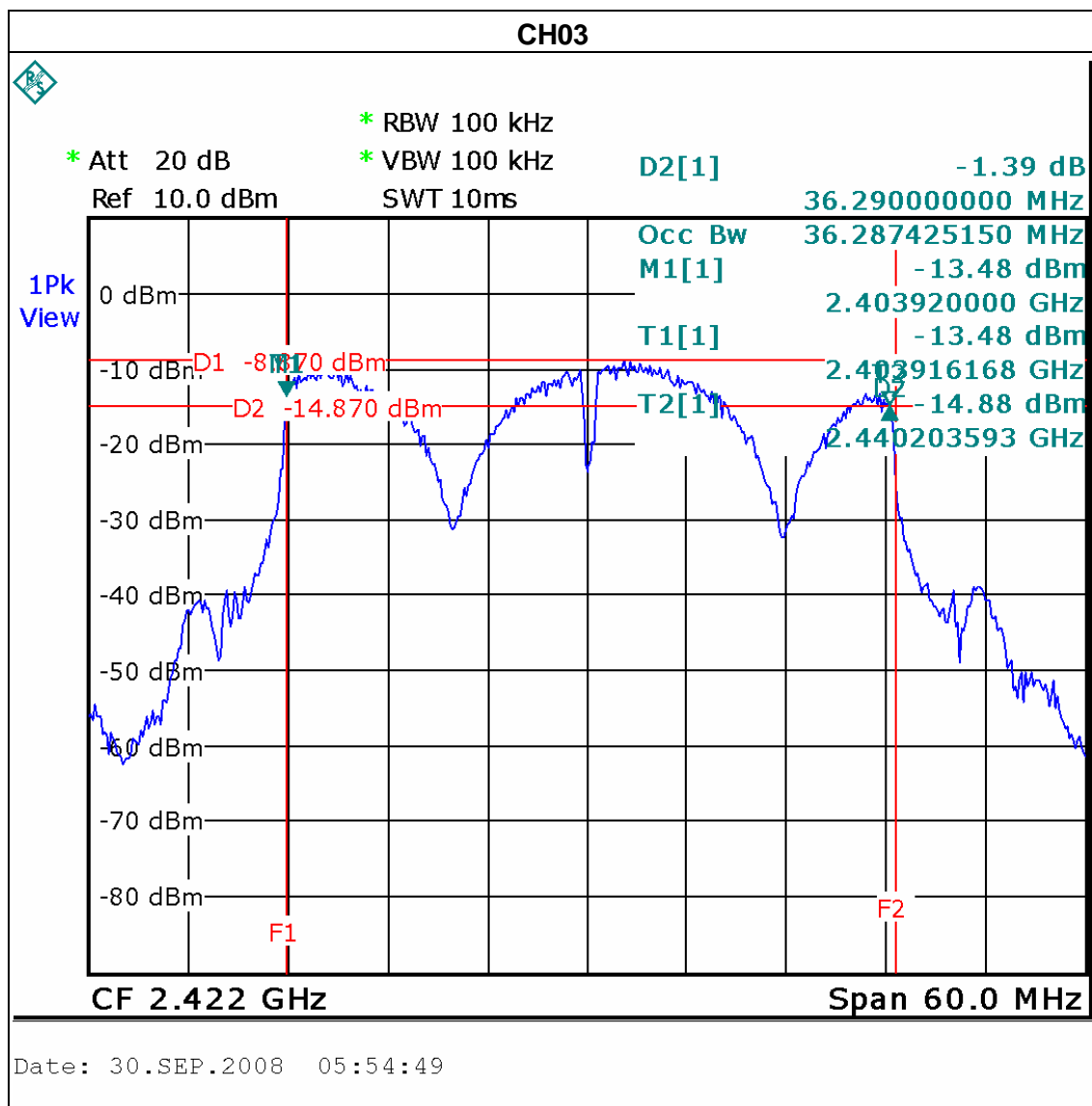

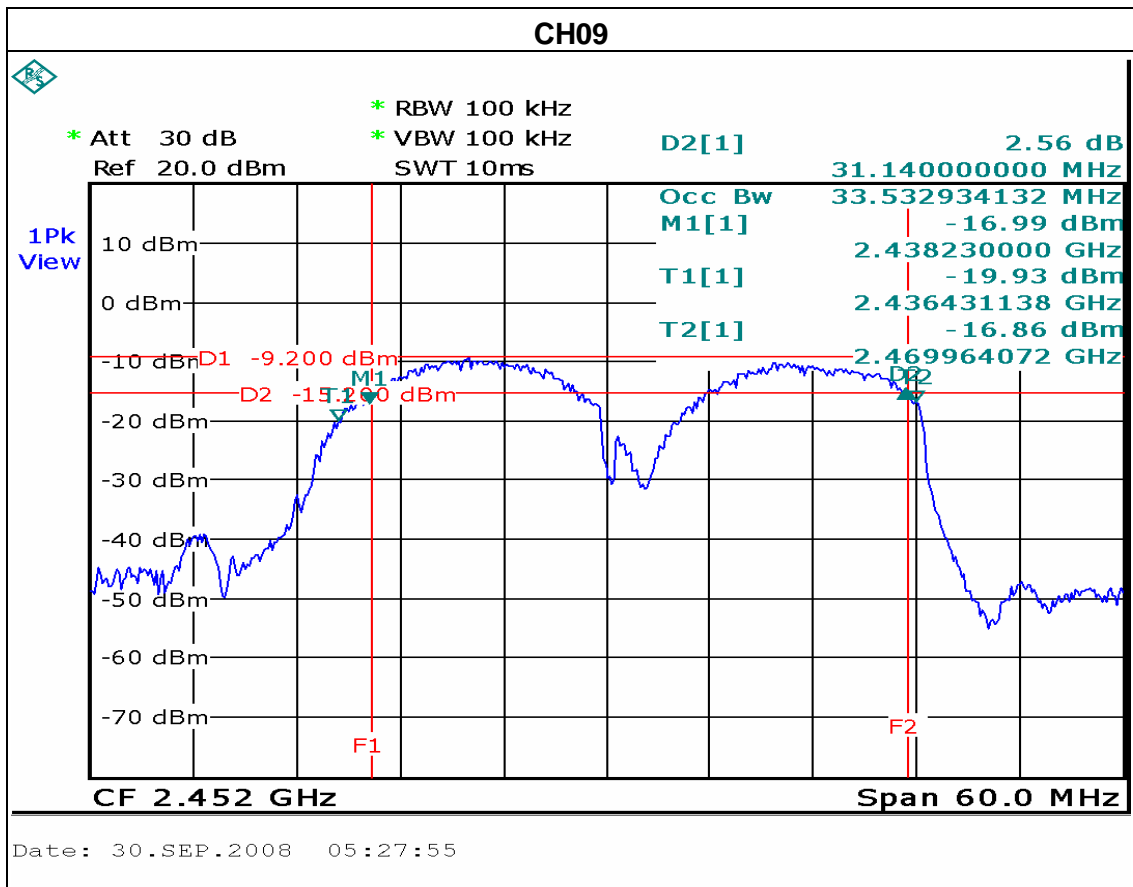
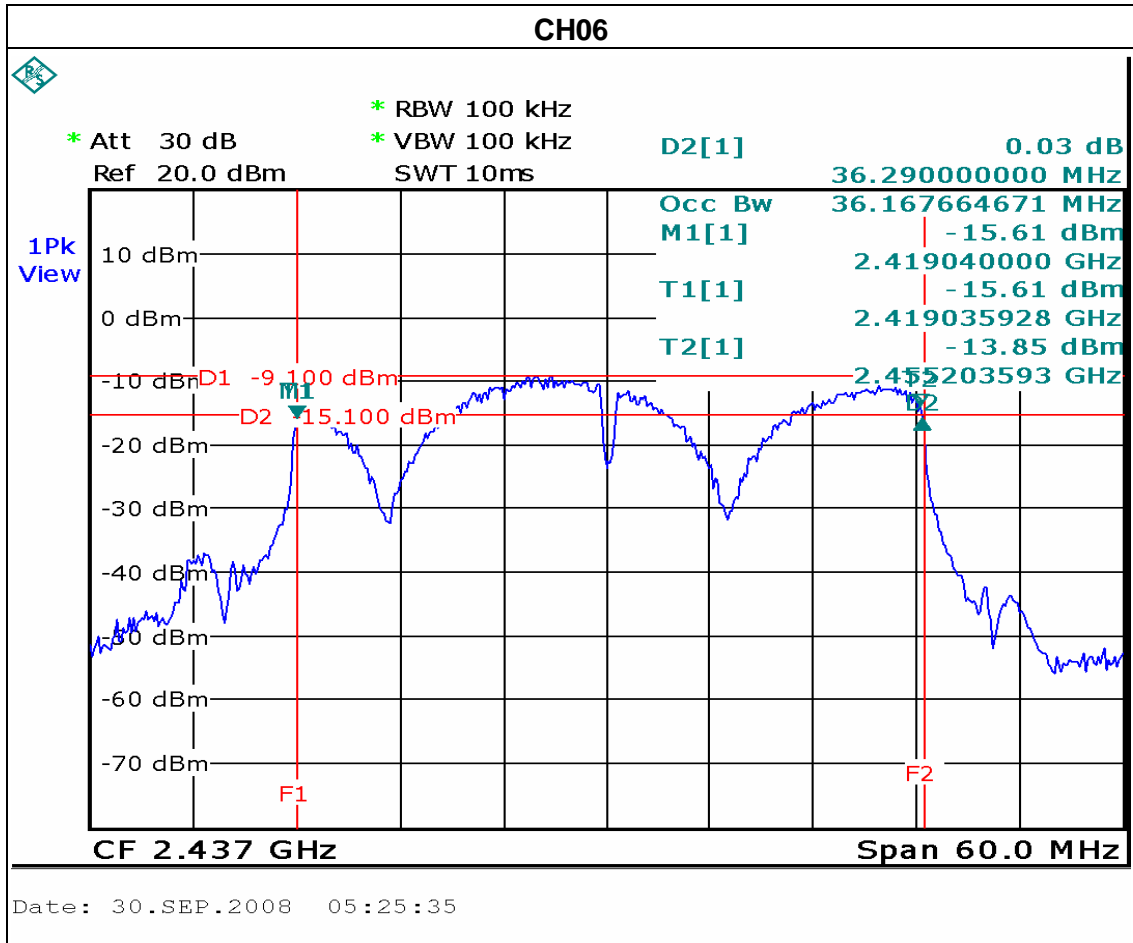

6. PEAK OUTPUT POWER TEST

6.1 Applied procedures / limit

FCC Part15 (15.247) , Subpart C				
Section	Test Item	Limit	Frequency Range (MHz)	Result
15.247 (b)(1)	Peak Output Power	1 watt or 30dBm	2400-2483.5	PASS

6.1.1 MEASUREMENT INSTRUMENTS LIST

Item	Kind of Equipment	Manufacturer	Type No.	Serial No.	Calibrated until
1	Power Meter	Anritsu	ML2487A	6K00004714	Feb. 12, 2009
2	Power Meter Sensor	Anritsu	MA2491A	34138	Feb. 12, 2009

Remark: " N/A" denotes No Model Name. , Serial No. or No Calibration specified.

6.1.2 TEST PROCEDURE

- a. The EUT was directly connected to the power metter and antenna output port as show in the block diagram below,

6.1.3 DEVIATION FROM STANDARD

No deviation.

6.1.4 TEST SETUP



6.1.5 EUT OPERATION CONDITIONS

The EUT tested system was configured as the statements of 4.1.6 Unless otherwise a special operating condition is specified in the follows during the testing.

6.1.6 TEST RESULTS

EUT :	802.11n High-speed Wireless Broadband Router	Model Name :	NW725
Temperature :	25 °C	Relative Humidity :	60%
Pressure :	1016 hPa	Test Voltage :	AC 120V/60Hz
Test Mode :	TX B mode /CH01, CH06, CH11		

Test Channel	Frequency (MHz)	Peak Output Power (dBm)	LIMIT (dBm)	LIMIT (W)
CH01	2412 MHz	17.00	30	1
CH06	2437 MHz	17.02	30	1
CH11	2462 MHz	17.08	30	1

EUT :	802.11n High-speed Wireless Broadband Router	Model Name :	NW725
Temperature :	25 °C	Relative Humidity :	60%
Pressure :	1016 hPa	Test Voltage :	AC 120V/60Hz
Test Mode :	TX G mode /CH01, CH06, CH11		

Test Channel	Frequency (MHz)	Peak Output Power (dBm)	LIMIT (dBm)	LIMIT (W)
CH01	2412 MHz	14.00	30	1
CH06	2437 MHz	14.03	30	1
CH11	2462 MHz	14.11	30	1

EUT :	802.11n High-speed Wireless Broadband Router	Model Name :	NW725
Temperature :	25 °C	Relative Humidity :	60%
Pressure :	1016 hPa	Test Voltage :	AC 120V/60Hz
Test Mode :	802.11n/20M/CH01, CH06, CH11		

Antenna A					
Test Channel	Frequency (MHz)	Peak Output Power		LIMIT (dBm)	LIMIT (W)
		(mW)	(dBm)		
CH01	2412	10.0462	10.02	30	1
CH06	2437	10.2565	10.11	30	1
CH11	2462	10.5682	10.24	30	1

Antenna C					
Test Channel	Frequency (MHz)	Peak Output Power		LIMIT (dBm)	LIMIT (W)
		(mW)	(dBm)		
CH01	2412	9.9083	9.96	30	1
CH06	2437	10.0000	10.00	30	1
CH11	2462	10.2565	10.11	30	1

Total (Antenna A + Antenna C)					
Test Channel	Frequency (MHz)	Peak Output Power		LIMIT (dBm)	LIMIT (W)
		(mW)	(dBm)		
CH01	2412	19.9545	13.00	30	1
CH06	2437	20.2565	13.06	30	1
CH11	2462	20.8247	13.19	30	1

EUT :	802.11n High-speed Wireless Broadband Router	Model Name :	NW725
Temperature :	25 °C	Relative Humidity :	60%
Pressure :	1016 hPa	Test Voltage :	AC 120V/60Hz
Test Mode :	802.11n/40M/CH03, CH06, CH09		

Antenna A					
Test Channel	Frequency (MHz)	Peak Output Power		LIMIT (dBm)	LIMIT (W)
		(mW)	(dBm)		
CH03	2422	7.9433	9.00	30	1
CH06	2437	8.0353	9.05	30	1
CH09	2452	8.1283	9.10	30	1

Antenna C					
Test Channel	Frequency (MHz)	Peak Output Power		LIMIT (dBm)	LIMIT (W)
		(mW)	(dBm)		
CH03	2422	7.9799	9.02	30	1
CH06	2437	8.0168	9.04	30	1
CH09	2452	8.1096	9.09	30	1

Total (Antenna A + Antenna C)					
Test Channel	Frequency (MHz)	Peak Output Power		LIMIT (dBm)	LIMIT (W)
		(mW)	(dBm)		
CH03	2422	15.9786	12.04	30	1
CH06	2437	16.0521	12.06	30	1
CH09	2452	16.2379	12.11	30	1

7. ANTENNA CONDUCTED SPURIOUS EMISSION

7.1 Applied procedures / limit

20dBc in any 100 kHz bandwidth outside the operating frequency band. In case the emission fall within the restricted band specified on 15.205(a), then the 15.209(a) limit in the table below has to be followed.

Frequencies (MHz)	Field Strength (micровolts/meter)	Measurement Distance (meters)
0.009~0.490	2400/F(KHz)	300
0.490~1.705	24000/F(KHz)	30
1.705~30.0	30	30
30~88	100	3
88~216	150	3
216~960	200	3
Above 960	500	3

7.1.1 MEASUREMENT INSTRUMENTS LIST

Item	Kind of Equipment	Manufacturer	Type No.	Serial No.	Calibrated until
1	Spectrum Analyzer	R&S	FSP_40	100129	Jan. 07, 2009

Remark: " N/A" denotes No Model Name. , Serial No. or No Calibration specified.

The following table is the setting of the spectrum analyzer.

Spectrum Parameter	Setting
Attenuation	Auto
Span Frequency	100 MHz
RB / VB (emission in restricted band)	1MHz / 1MHz for Peak, 1 MHz / 10Hz for Average
RB / VB (other emission)	100 KHz /100 KHz for Peak

7.1.2 TEST PROCEDURE

- a. The EUT was directly connected to the spectrum analyzer and antenna output port as show in the block diagram below,
- b. Spectrum Setting : RBW= 100KHz, VBW=100KHz, Sweep time = 200 ms.

7.1.3 DEVIATION FROM STANDARD

No deviation.

7.1.4 TEST SETUP

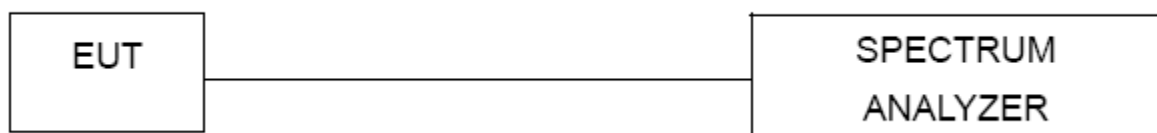

7.1.5 EUT OPERATION CONDITIONS

The EUT tested system was configured as the statements of 4.1.6 Unless otherwise a special operating condition is specified in the follows during the testing.

7.1.6 TEST RESULTS

EUT :	802.11n High-speed Wireless Broadband Router	Model Name :	NW725
Temperature :	25 °C	Relative Humidity :	60%
Pressure :	1016 hPa	Test Voltage :	AC 120V/60Hz
Test Mode :	TX B mode CH01, CH11		

Channel of Worst Data: CH01			
The max. radio frequency power in any 100kHz bandwidth outside the frequency band		The max. radio frequency power in any 100 kHz bandwidth within the frequency band.	
FREQUENCY(MHz)	POWER(dBm)	FREQUENCY(MHz)	POWER(dBm)
2385.18	-48.46	2483.50	-51.40
Result			
In any 100kHz bandwidth outside the frequency band, the radio frequency power is at least 20dB below that in the 100kHz bandwidth within the band that contains the highest level of the desired power.			

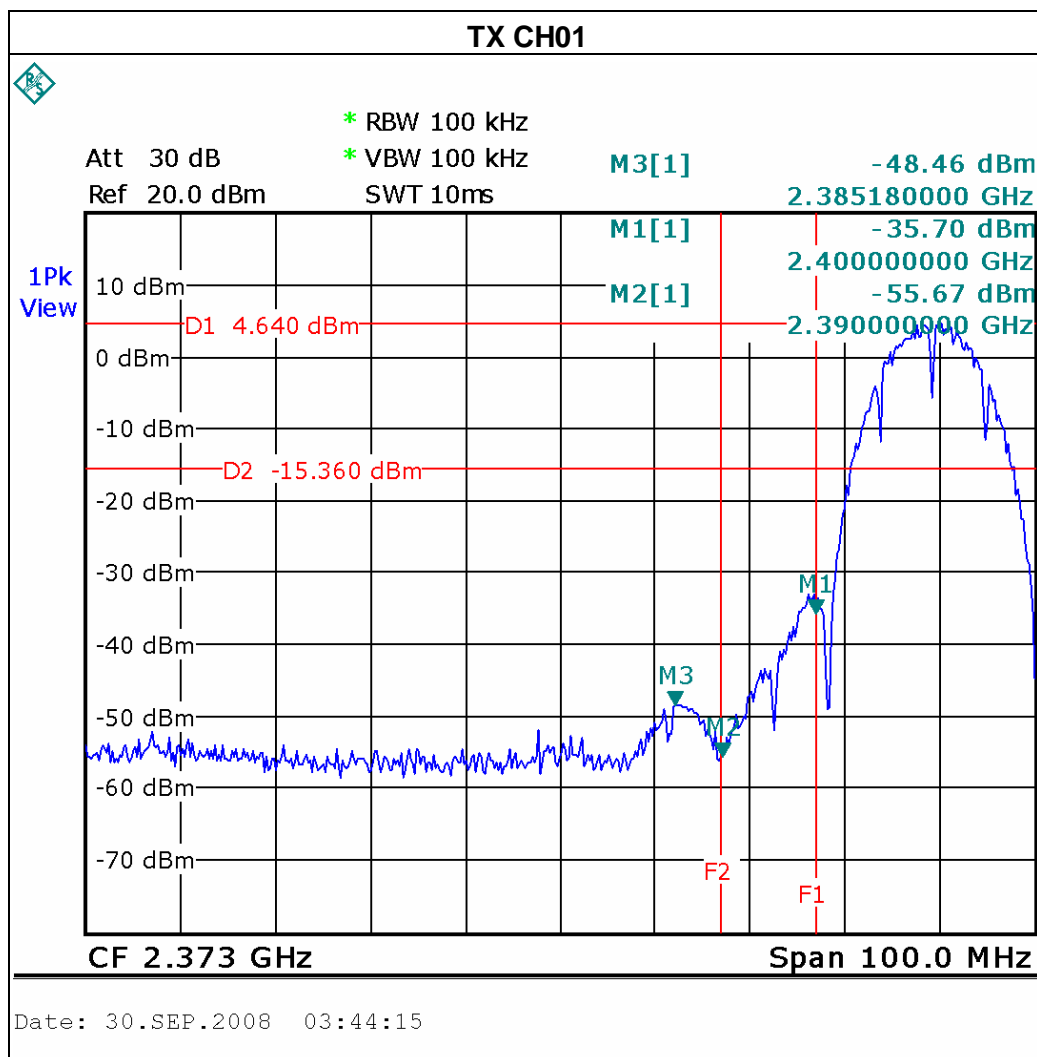

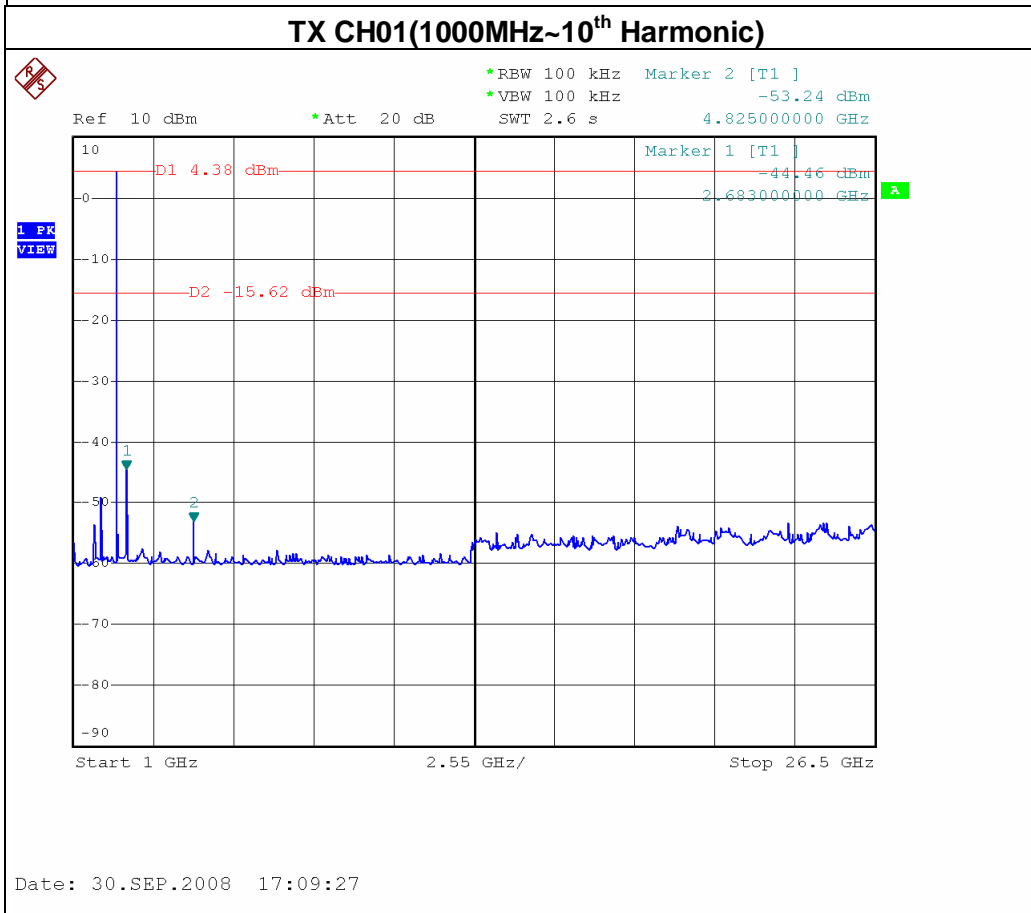
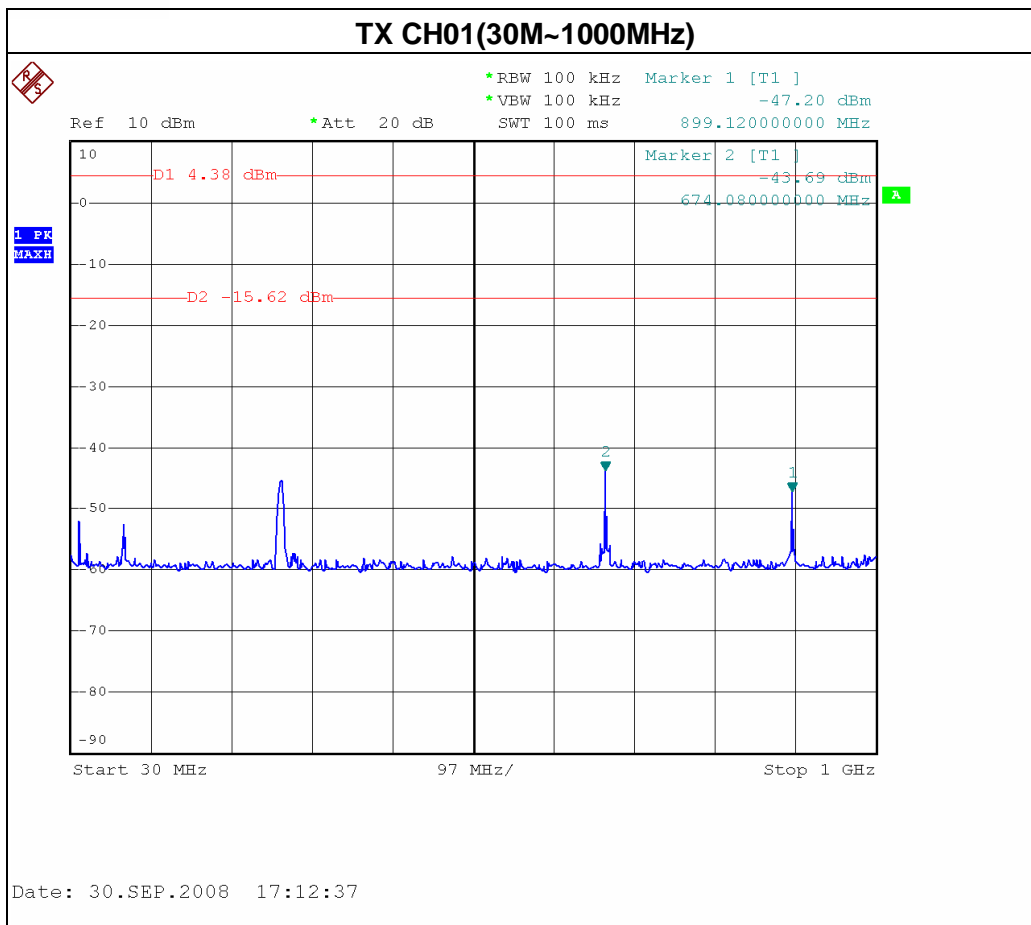

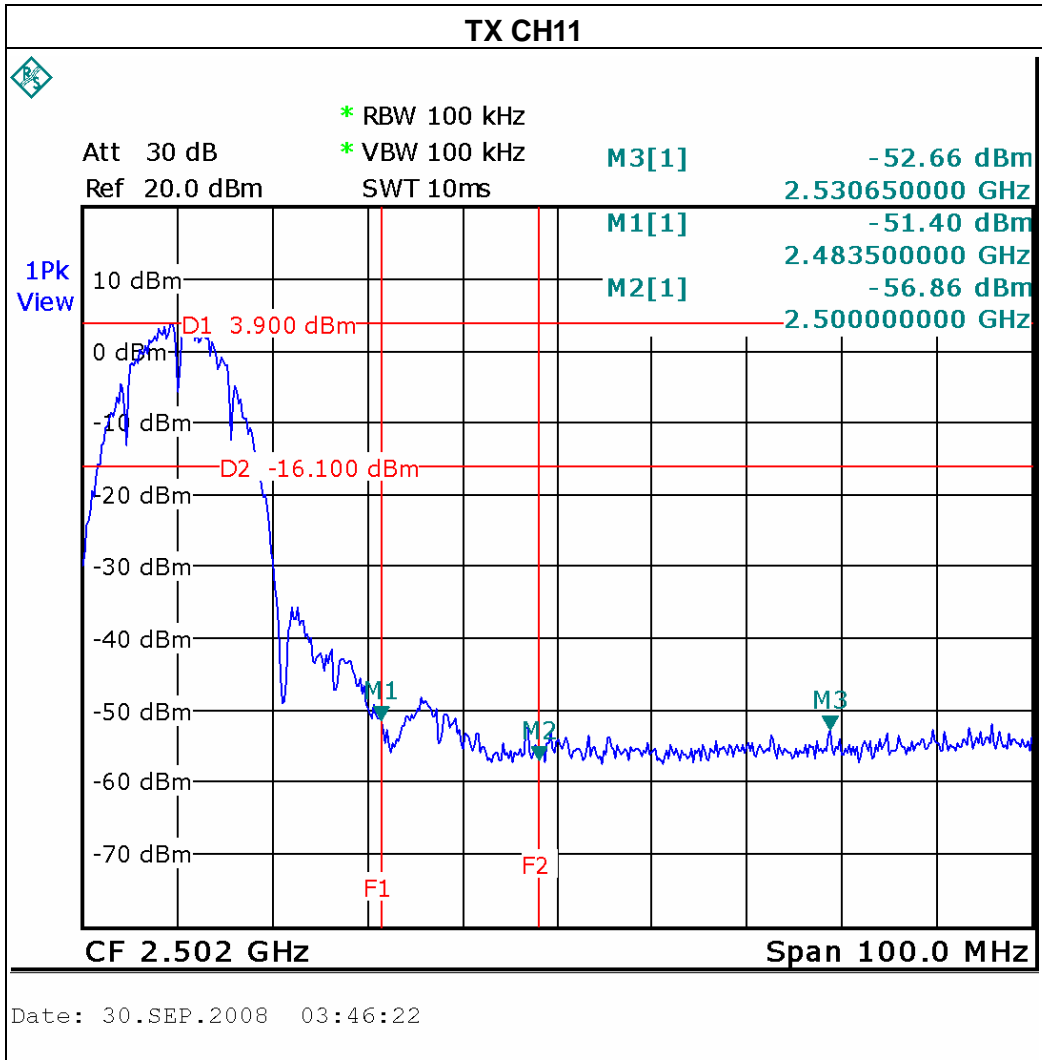

EUT :	802.11n High-speed Wireless Broadband Router	Model Name :	NW725
Temperature :	25 °C	Relative Humidity :	60%
Pressure :	1016 hPa	Test Voltage :	AC 120V/60Hz
Test Mode :	TX G mode CH01, CH11		

Channel of Worst Data: CH11			
The max. radio frequency power in any 100kHz bandwidth outside the frequency band		The max. radio frequency power in any 100 kHz bandwidth within the frequency band.	
FREQUENCY(MHz)	POWER(dBm)	FREQUENCY(MHz)	POWER(dBm)
2390.00	-46.99	2483.50	-46.76

Result

In any 100kHz bandwidth outside the frequency band, the radio frequency power is at least 20dB below that in the 100kHz bandwidth within the band that contains the highest level of the desired power.

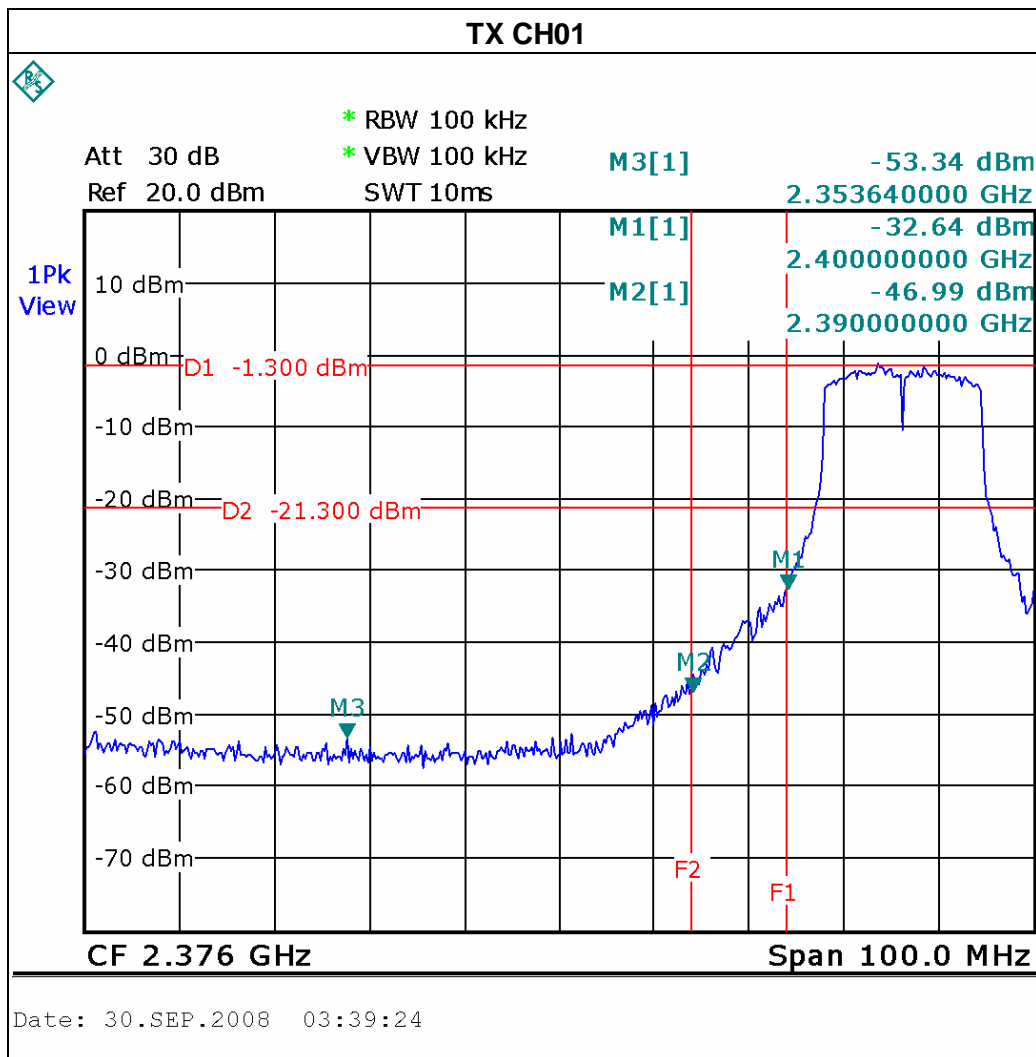

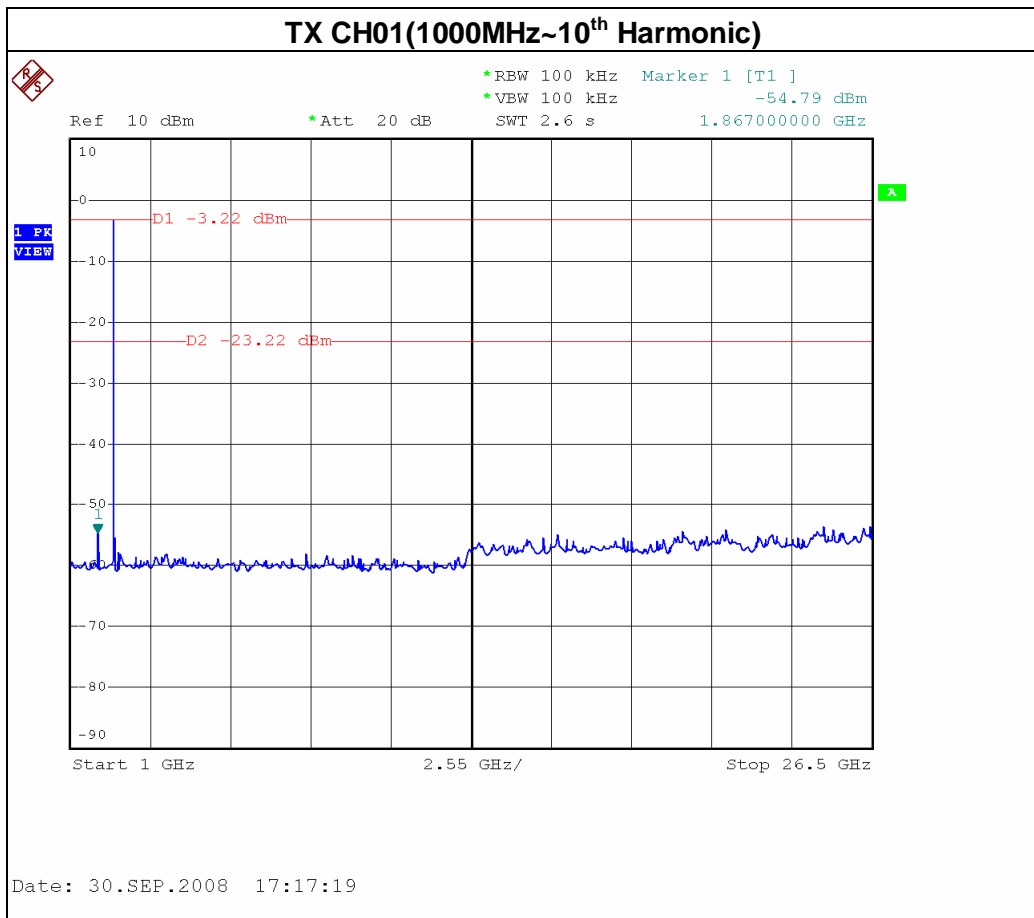
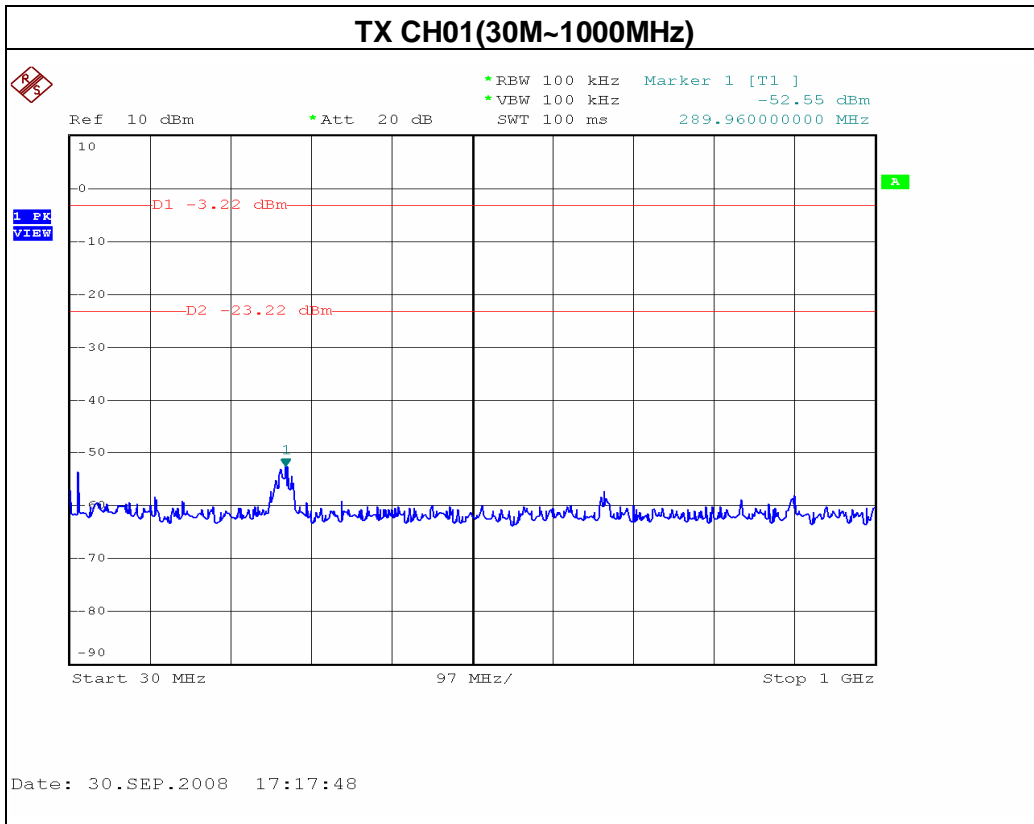

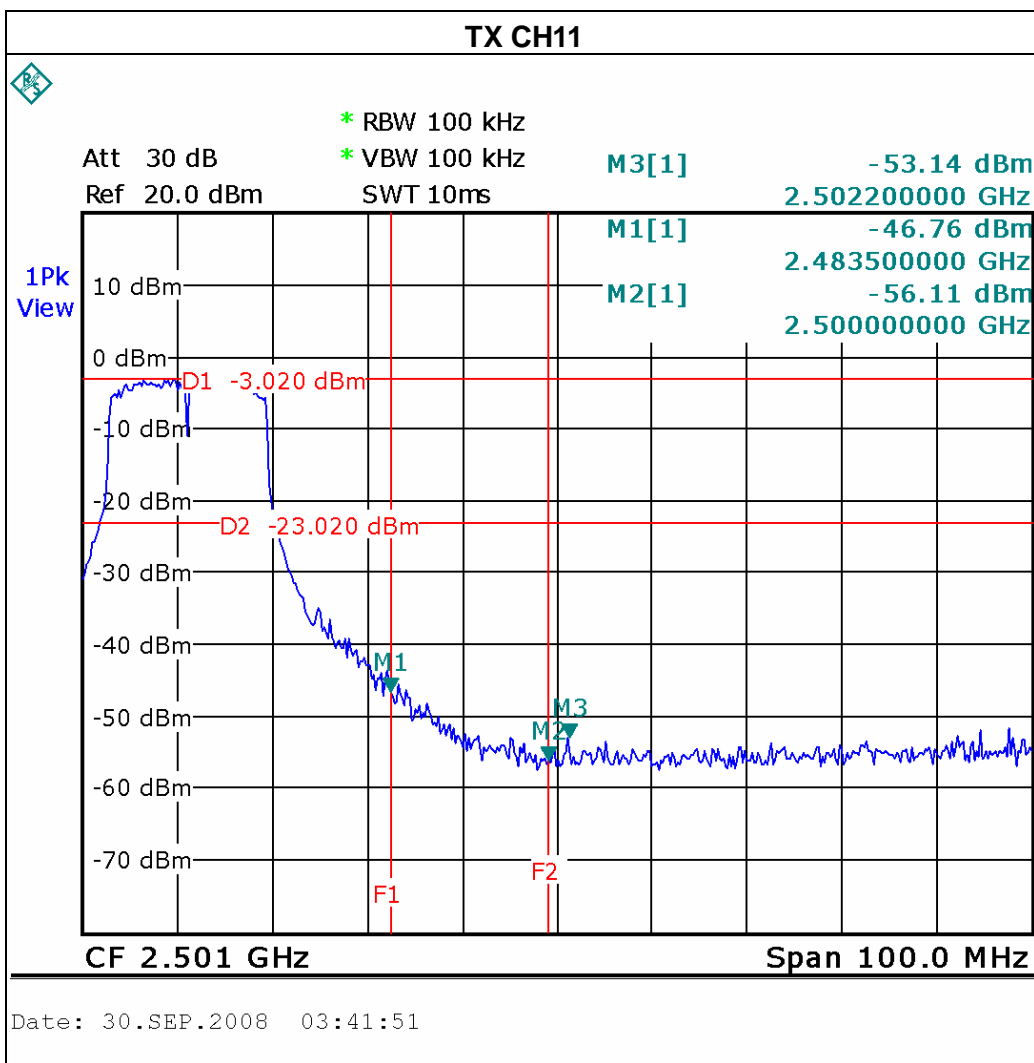

EUT :	802.11n High-speed Wireless Broadband Router	Model Name :	NW725
Temperature :	25 °C	Relative Humidity :	60%
Pressure :	1016 hPa	Test Voltage :	AC 120V/60Hz
Test Mode :	802.11n/20M/CH01, CH11 (Antenna A)		

Channel of Worst Data: CH11			
The max. radio frequency power in any 100kHz bandwidth outside the frequency band		The max. radio frequency power in any 100 kHz bandwidth within the frequency band.	
FREQUENCY(MHz)	POWER(dBm)	FREQUENCY(MHz)	POWER(dBm)
2390.00	-52.38	2483.50	-49.57

Result

In any 100kHz bandwidth outside the frequency band, the radio frequency power is at least 20dB below that in the 100kHz bandwidth within the band that contains the highest level of the desired power.

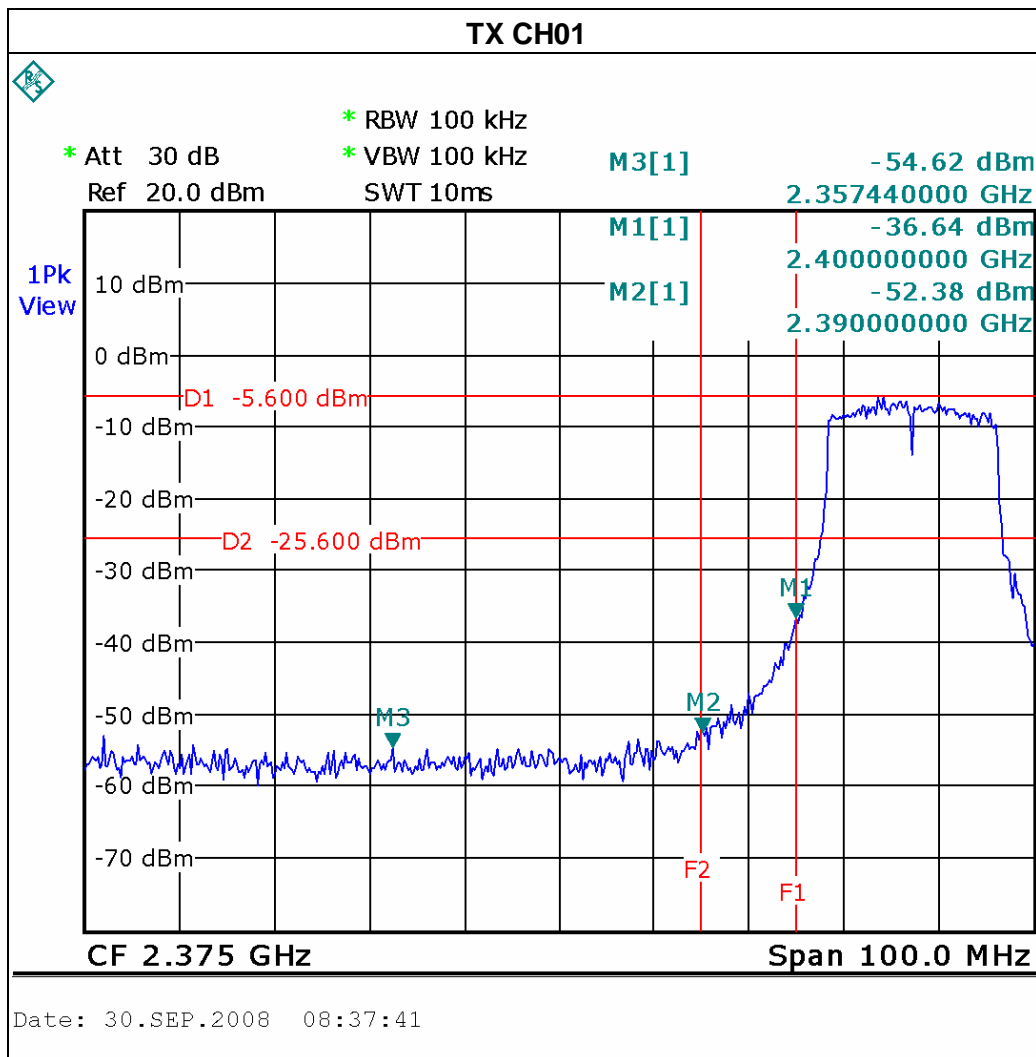

EUT :	802.11n High-speed Wireless Broadband Router	Model Name :	NW725
Temperature :	25 °C	Relative Humidity :	60%
Pressure :	1016 hPa	Test Voltage :	AC 120V/60Hz
Test Mode :	802.11n/20M/CH01, CH11 (Antenna C)		

Channel of Worst Data: CH01			
The max. radio frequency power in any 100kHz bandwidth outside the frequency band		The max. radio frequency power in any 100 kHz bandwidth within the frequency band.	
FREQUENCY(MHz)	POWER(dBm)	FREQUENCY(MHz)	POWER(dBm)
2377.79.00	-53.62	2484.03	-53.73
Result			

In any 100kHz bandwidth outside the frequency band, the radio frequency power is at least 20dB below that in the 100kHz bandwidth within the band that contains the highest level of the desired power.

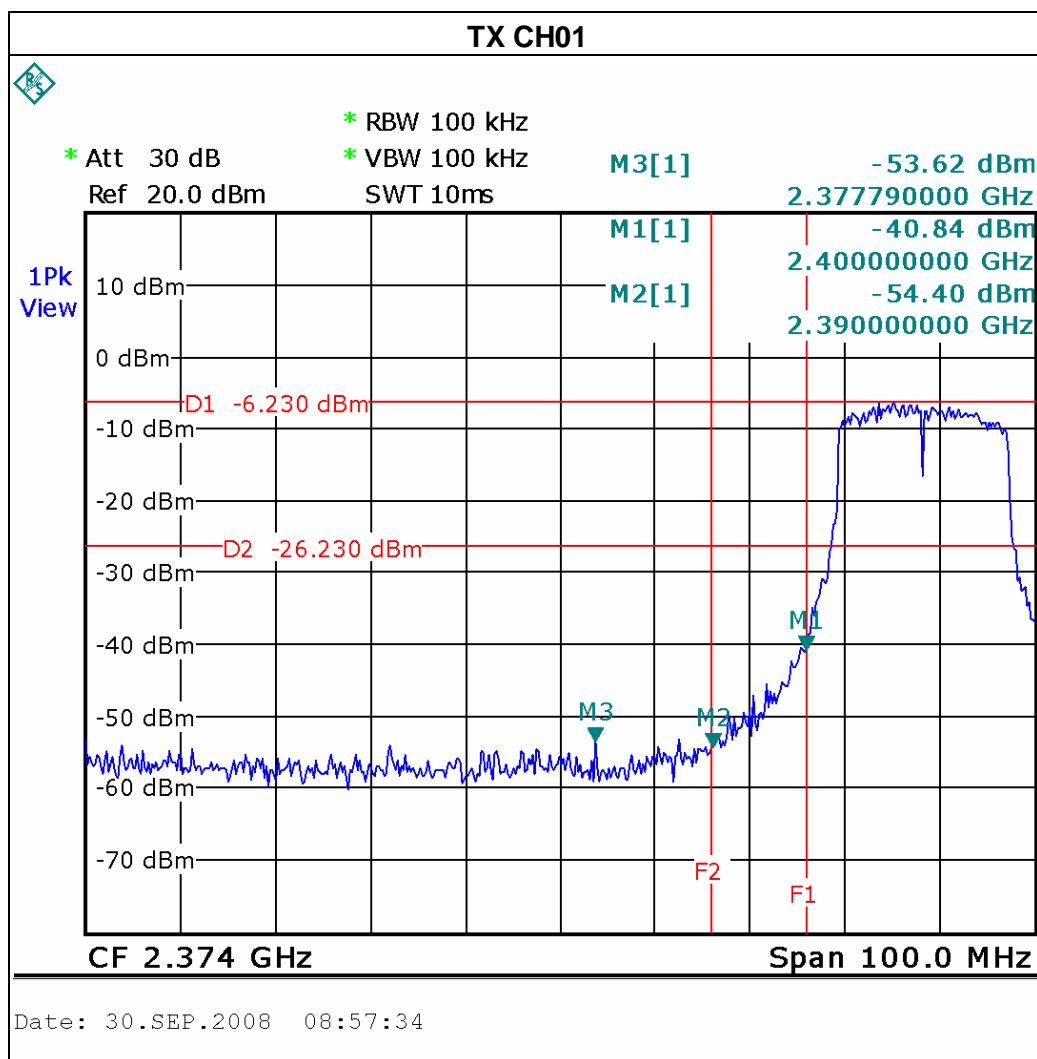

EUT :	802.11n High-speed Wireless Broadband Router	Model Name :	NW725
Temperature :	25 °C	Relative Humidity :	60%
Pressure :	1016 hPa	Test Voltage :	AC 120V/60Hz
Test Mode :	802.11n/20M/CH01, CH11 (Antenna A + Antenna C)		

Channel of Worst Data: CH01			
The max. radio frequency power in any 100kHz bandwidth outside the frequency band		The max. radio frequency power in any 100 kHz bandwidth within the frequency band.	
FREQUENCY(MHz)	POWER(dBm)	FREQUENCY(MHz)	POWER(dBm)
2390.00	-47.45	2483.50	-51.56

Result

In any 100kHz bandwidth outside the frequency band, the radio frequency power is at least 20dB below that in the 100kHz bandwidth within the band that contains the highest level of the desired power.

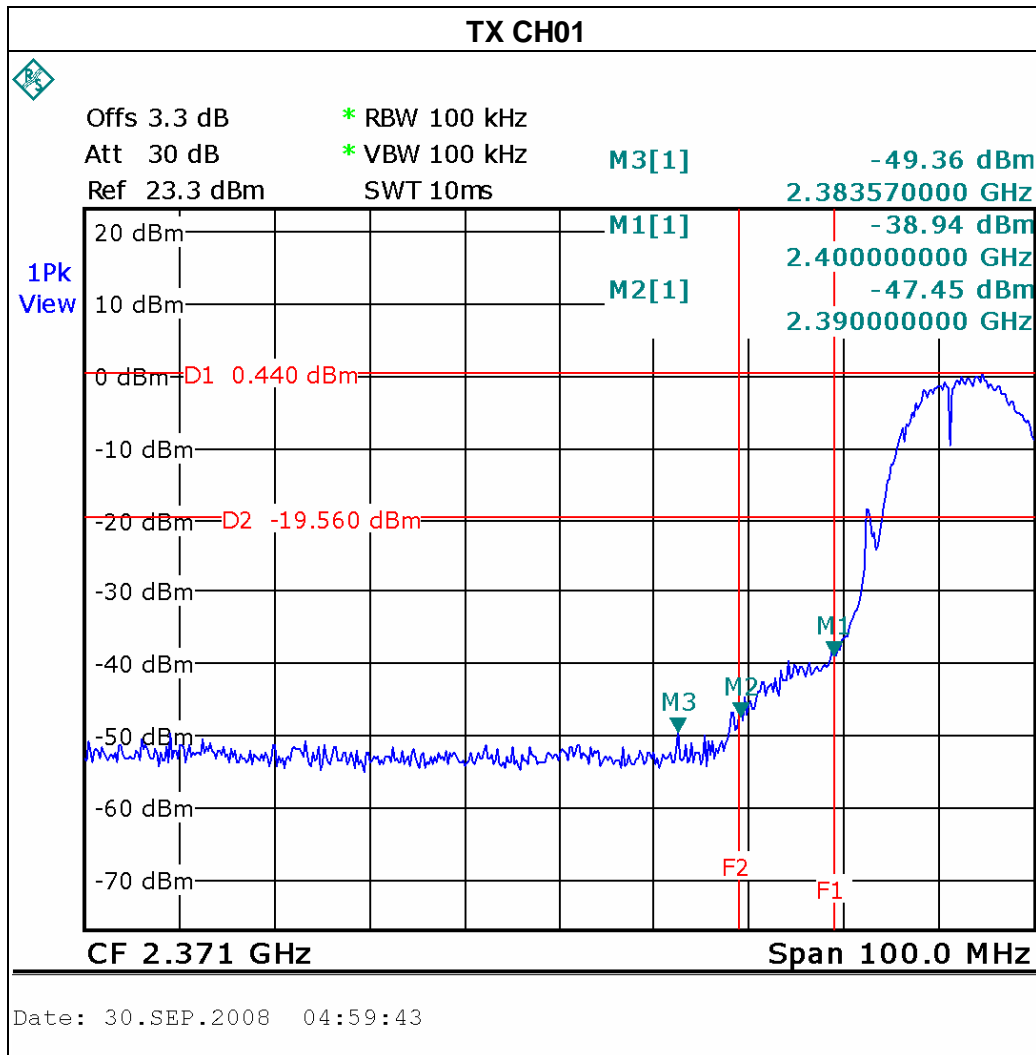

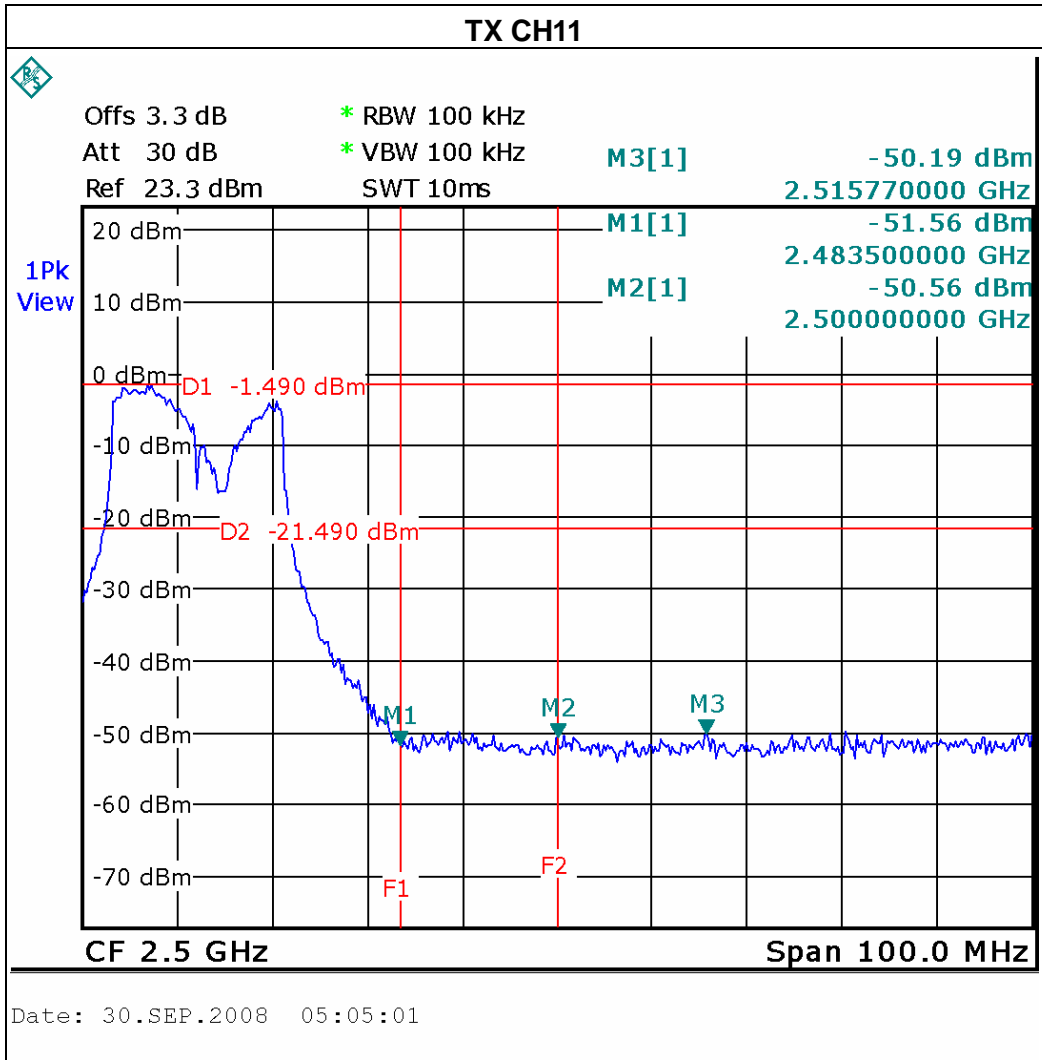

EUT :	802.11n High-speed Wireless Broadband Router	Model Name :	NW725
Temperature :	25 °C	Relative Humidity :	60%
Pressure :	1016 hPa	Test Voltage :	AC 120V/60Hz
Test Mode :	802.11n/40M/CH03, CH09 (Antenna A)		

Channel of Worst Data: CH03			
The max. radio frequency power in any 100kHz bandwidth outside the frequency band		The max. radio frequency power in any 100 kHz bandwidth within the frequency band.	
FREQUENCY(MHz)	POWER(dBm)	FREQUENCY(MHz)	POWER(dBm)
2387.01	-47.79	2483.50	-52.10
Result			

In any 100kHz bandwidth outside the frequency band, the radio frequency power is at least 20dB below that in the 100kHz bandwidth within the band that contains the highest level of the desired power.

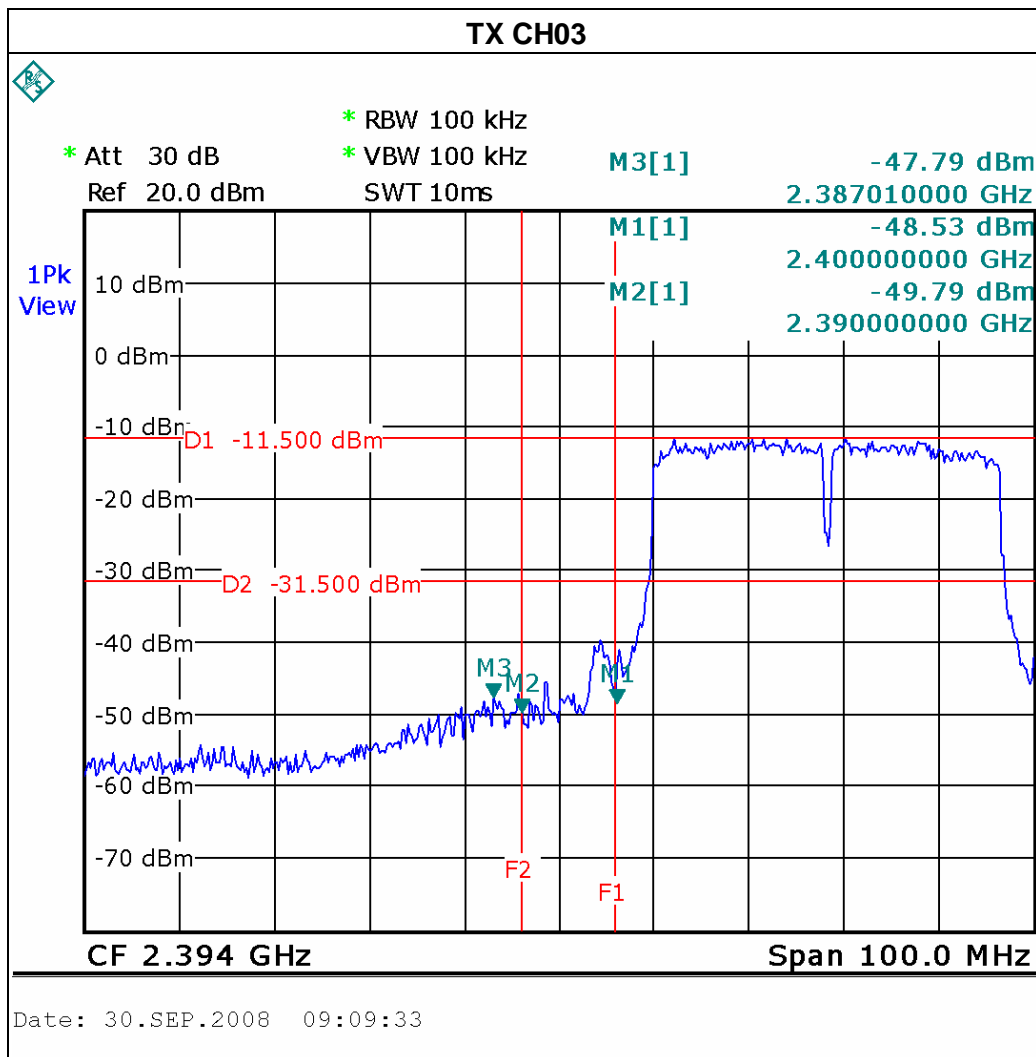

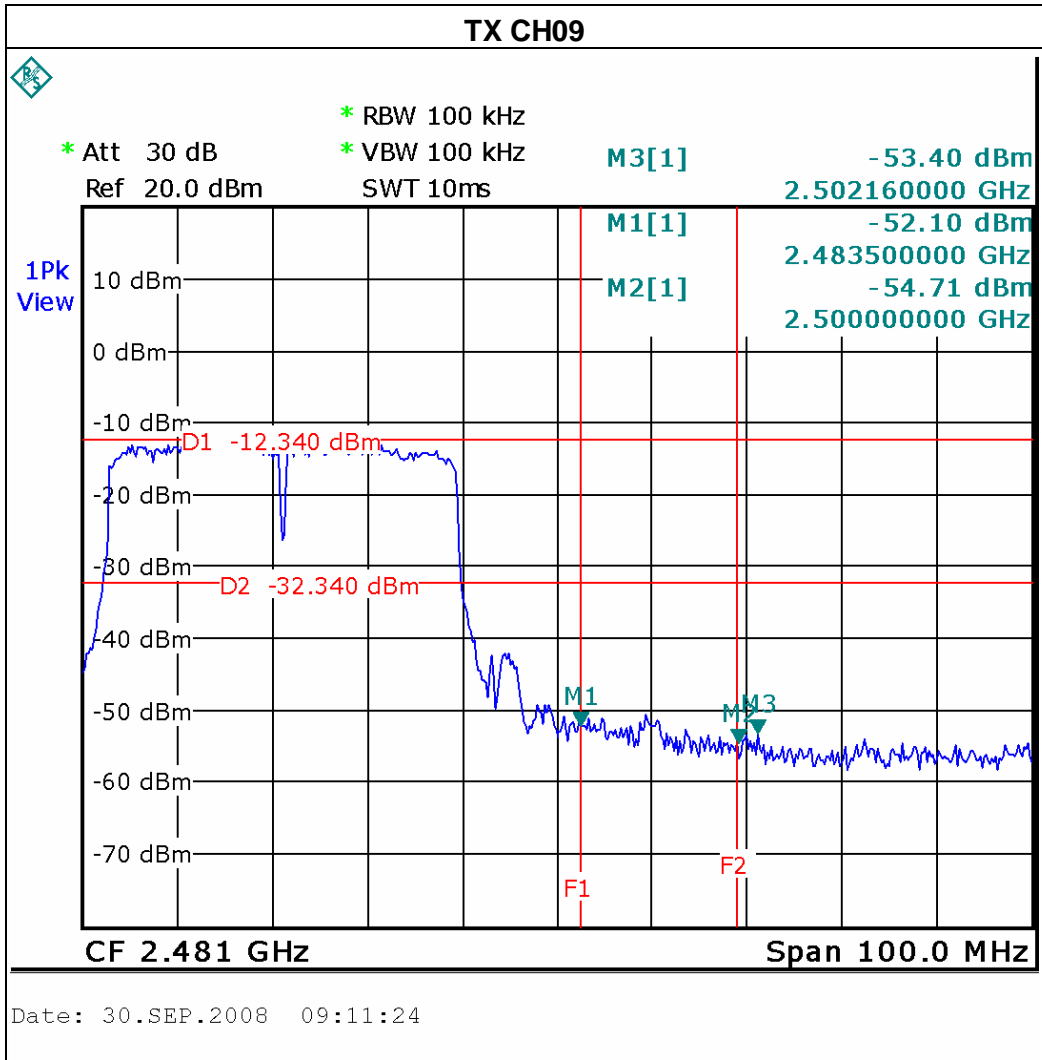

EUT :	802.11n High-speed Wireless Broadband Router	Model Name :	NW725
Temperature :	25 °C	Relative Humidity :	60%
Pressure :	1016 hPa	Test Voltage :	AC 120V/60Hz
Test Mode :	802.11n/40M/CH03, CH09 (Antenna C)		

Channel of Worst Data: CH03			
The max. radio frequency power in any 100kHz bandwidth outside the frequency band		The max. radio frequency power in any 100 kHz bandwidth within the frequency band.	
FREQUENCY(MHz)	POWER(dBm)	FREQUENCY(MHz)	POWER(dBm)
2387.61	-50.63	2483.50	-54.72

Result

In any 100kHz bandwidth outside the frequency band, the radio frequency power is at least 20dB below that in the 100kHz bandwidth within the band that contains the highest level of the desired power.

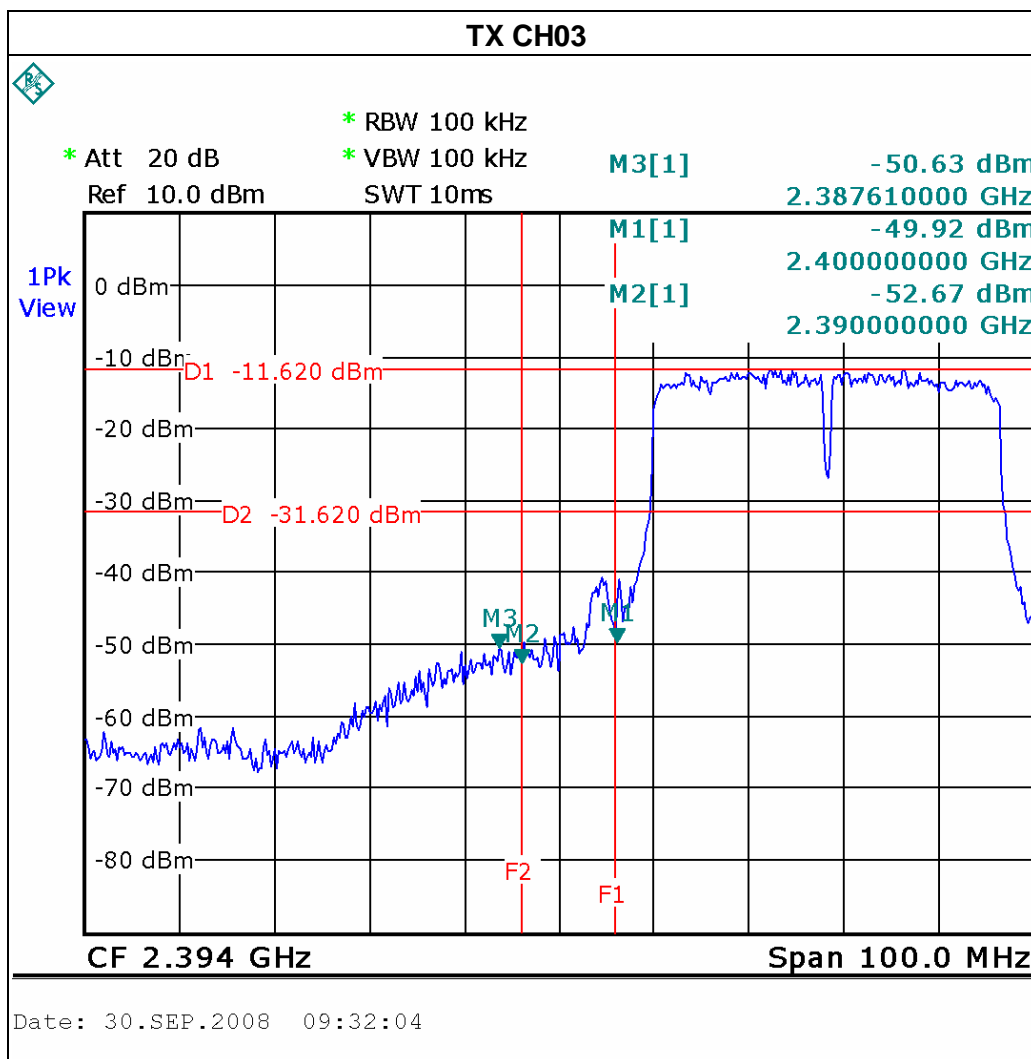

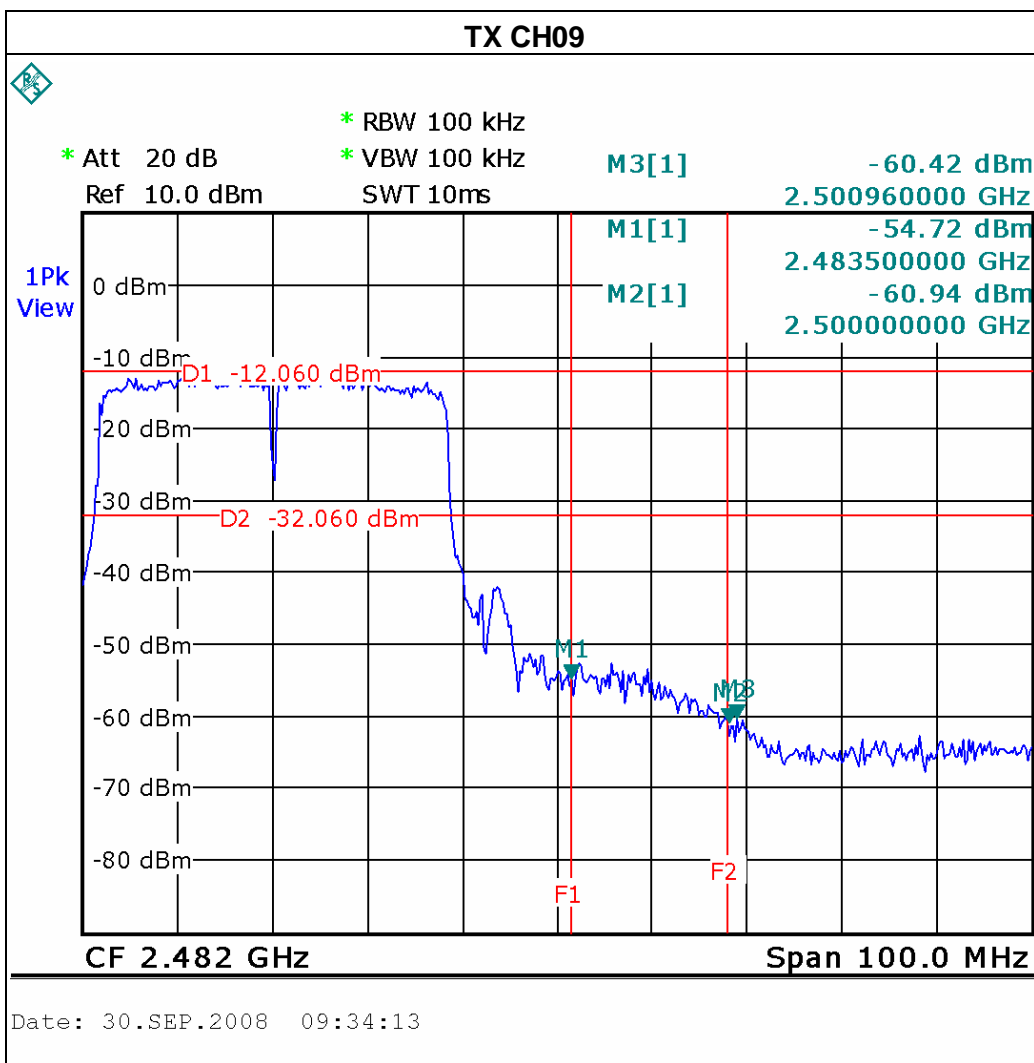

EUT :	802.11n High-speed Wireless Broadband Router	Model Name :	NW725
Temperature :	25 °C	Relative Humidity :	60%
Pressure :	1016 hPa	Test Voltage :	AC 120V/60Hz
Test Mode :	802.11n/40M/CH03, CH09 (Antenna A + Antenna C)		

Channel of Worst Data: CH03			
The max. radio frequency power in any 100kHz bandwidth outside the frequency band		The max. radio frequency power in any 100 kHz bandwidth within the frequency band.	
FREQUENCY(MHz)	POWER(dBm)	FREQUENCY(MHz)	POWER(dBm)
2386.02	-42.25	2483.50	-45.62
Result			
In any 100kHz bandwidth outside the frequency band, the radio frequency power is at least 20dB below that in the 100kHz bandwidth within the band that contains the highest level of the desired power.			

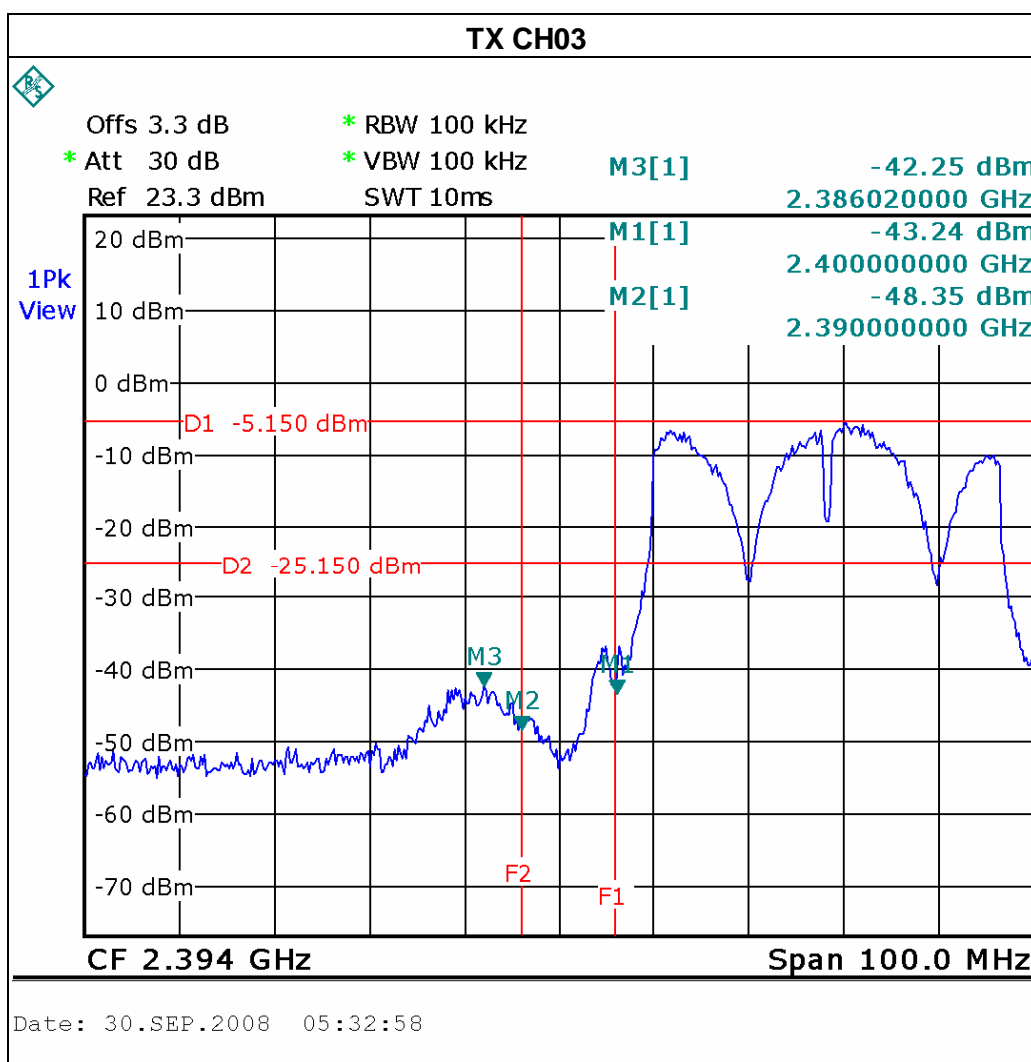

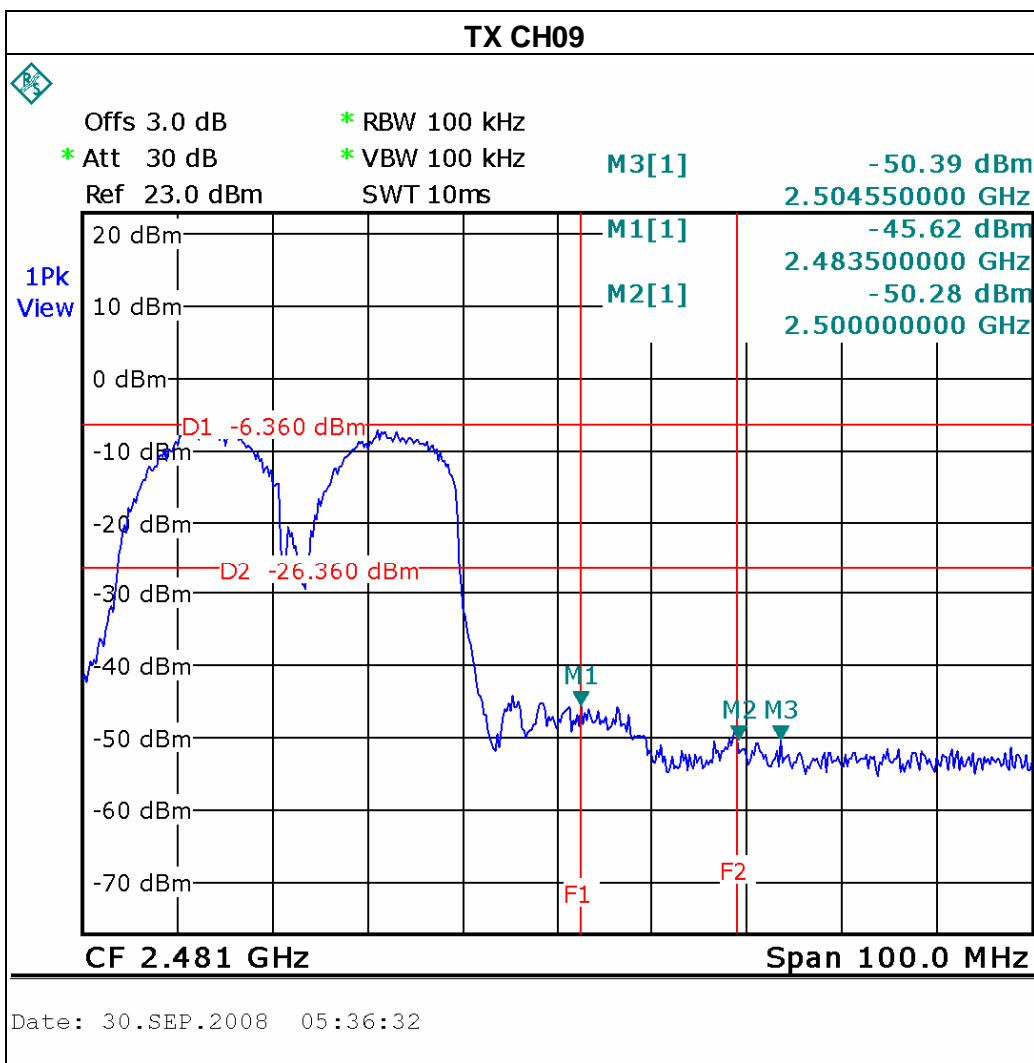

8. POWER SPECTRAL DENSITY TEST

8.1 Applied procedures / limit

FCC Part15 (15.247) , Subpart C				
Section	Test Item	Limit	Frequency Range (MHz)	Result
15.247 (d)	Power Spectral Density	8 dBm (in any 3KHz)	2400-2483.5	PASS

8.1.1 MEASUREMENT INSTRUMENTS LIST

Item	Kind of Equipment	Manufacturer	Type No.	Serial No.	Calibrated until
1	Spectrum Analyzer	R&S	FSP_40	100129	Jan. 07, 2009

Remark: " N/A" denotes No Model Name. , Serial No. or No Calibration specified.

8.1.2 TEST PROCEDURE

- a. The EUT was directly connected to the spectrum analyzer and antenna output port as show in the block diagram below,
- b. Spectrum Setting : RBW=3KHz, VBW=30 KHz, Sweep time = 500s.

8.1.3 DEVIATION FROM STANDARD

No deviation.

8.1.4 TEST SETUP



8.1.5 EUT OPERATION CONDITIONS

The EUT tested system was configured as the statements of 4.1.6 Unless otherwise a special operating condition is specified in the follows during the testing.

8.1.6 TEST RESULTS

EUT :	802.11n High-speed Wireless Broadband Router	Model Name :	NW725
Temperature :	25 °C	Relative Humidity :	60%
Pressure :	1016 hPa	Test Voltage :	AC 120V/60Hz
Test Mode :	TX B mode CH01, CH06, CH11		

Test Channel	Frequency (MHz)	Power Density (dBm)	LIMIT (dBm)
CH01	2412 MHz	-15.03	8
CH06	2437 MHz	-15.74	8
CH11	2462 MHz	-16.11	8

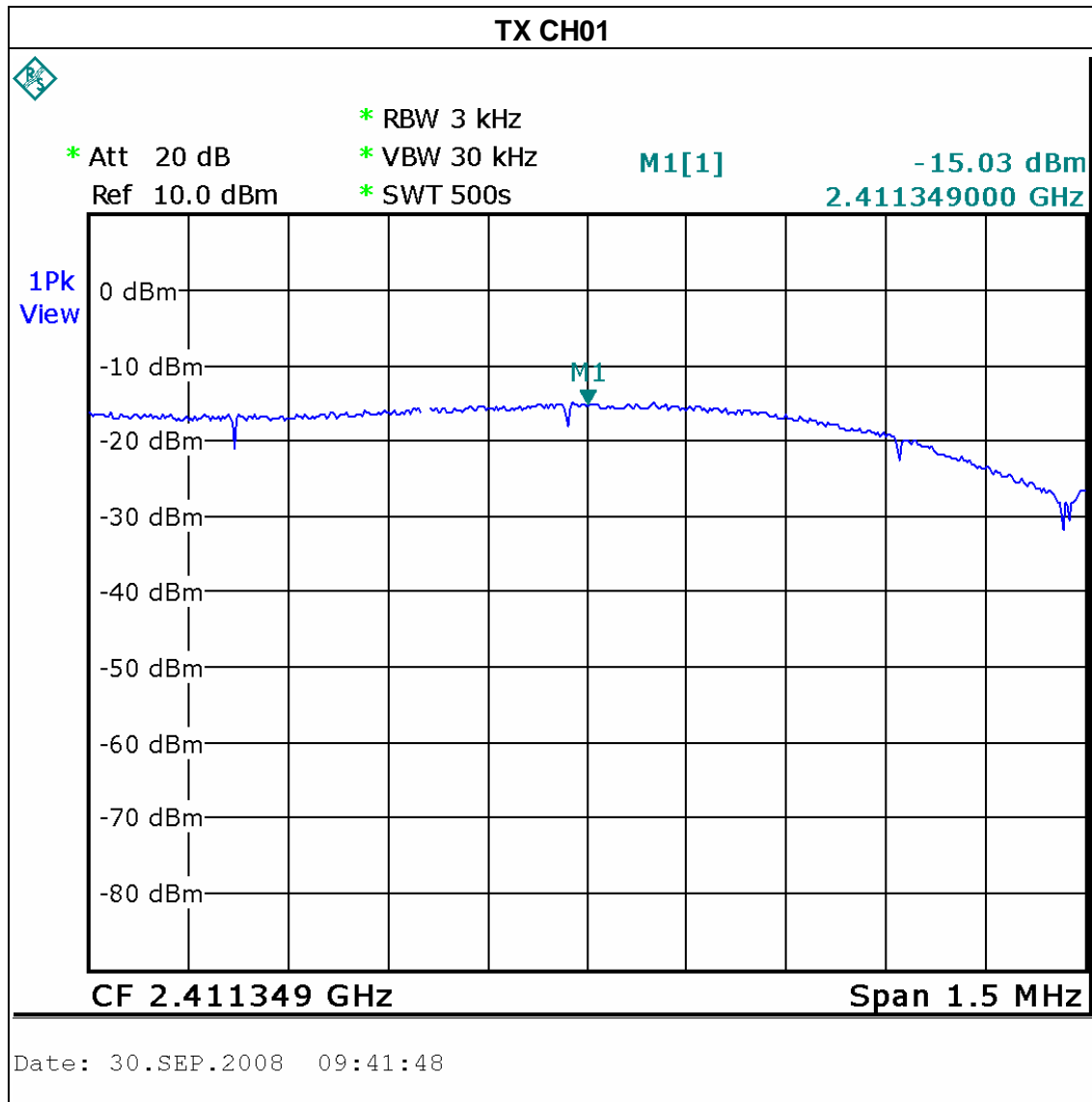

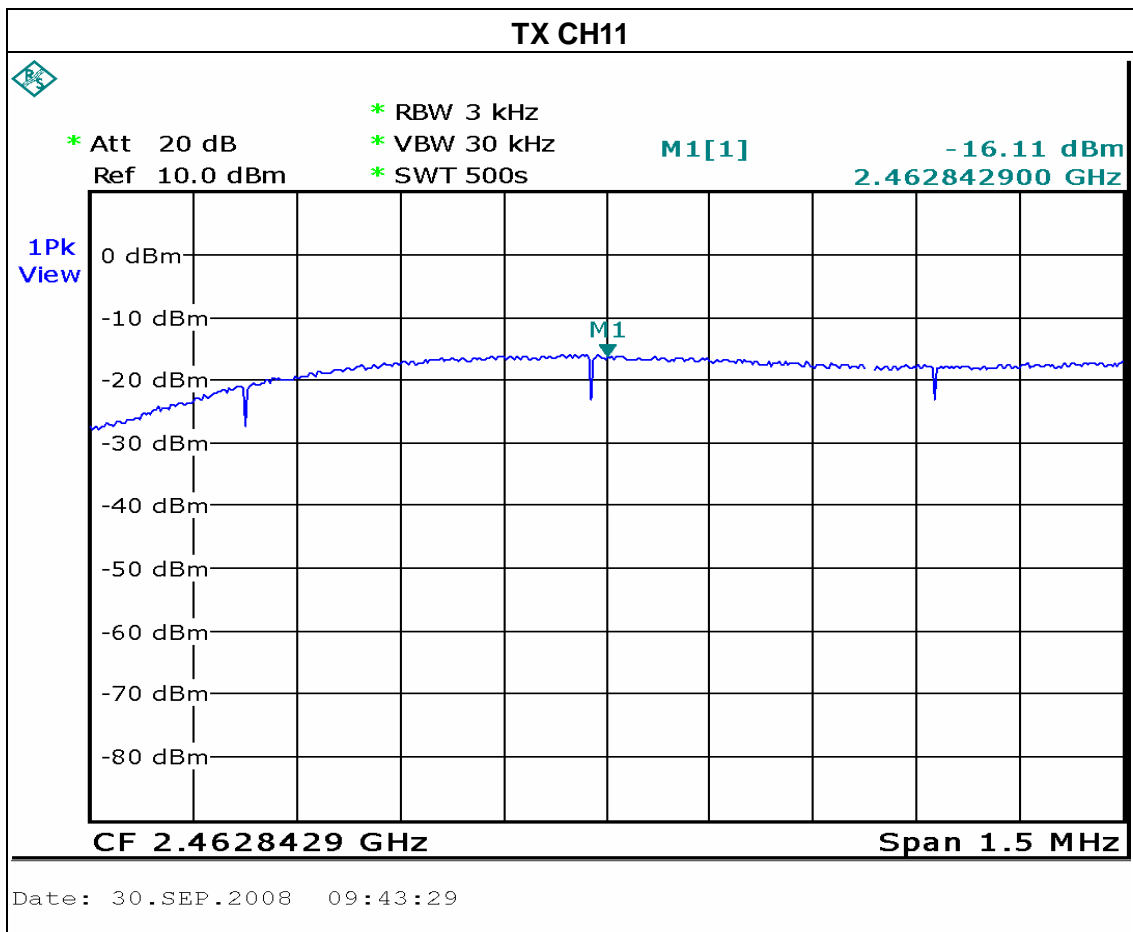
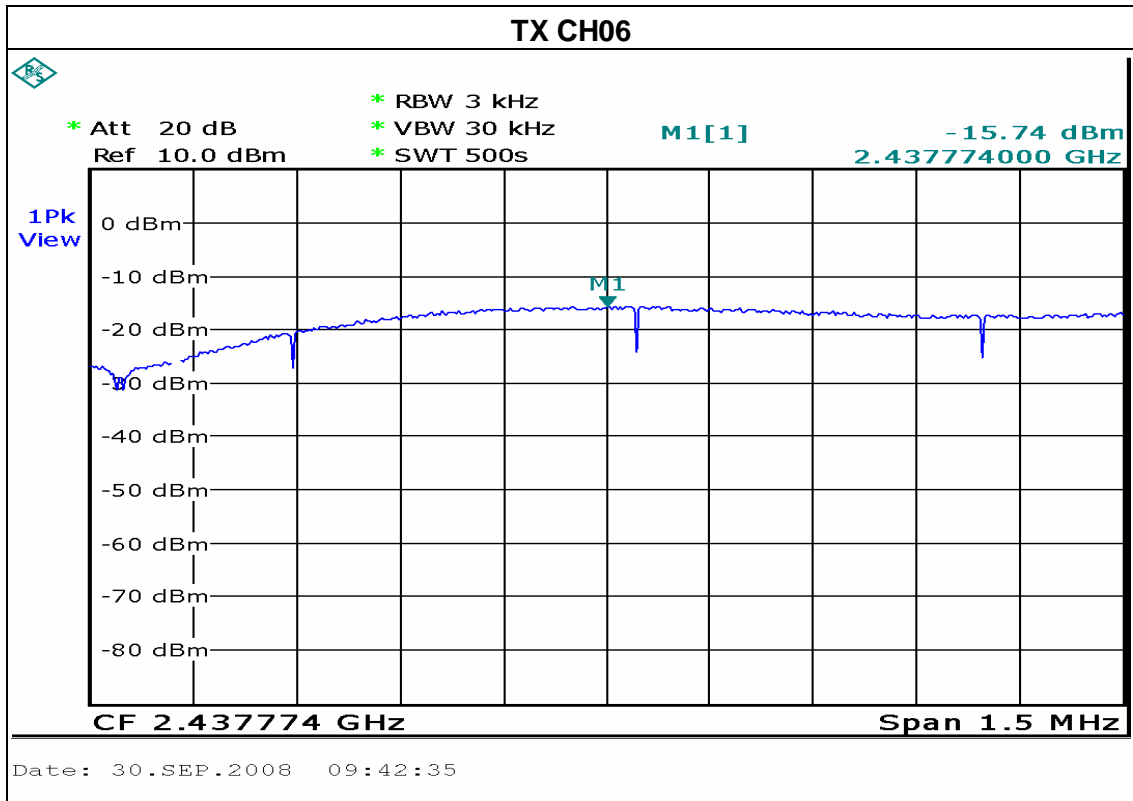

EUT :	802.11n High-speed Wireless Broadband Router	Model Name :	NW725
Temperature :	25 °C	Relative Humidity :	60%
Pressure :	1016 hPa	Test Voltage :	AC 120V/60Hz
Test Mode :	TX G mode CH01, CH06, CH11		

Test Channel	Frequency (MHz)	Power Density (dBm)	LIMIT (dBm)
CH01	2412 MHz	-16.50	8
CH06	2437 MHz	-17.08	8
CH11	2462 MHz	-17.52	8

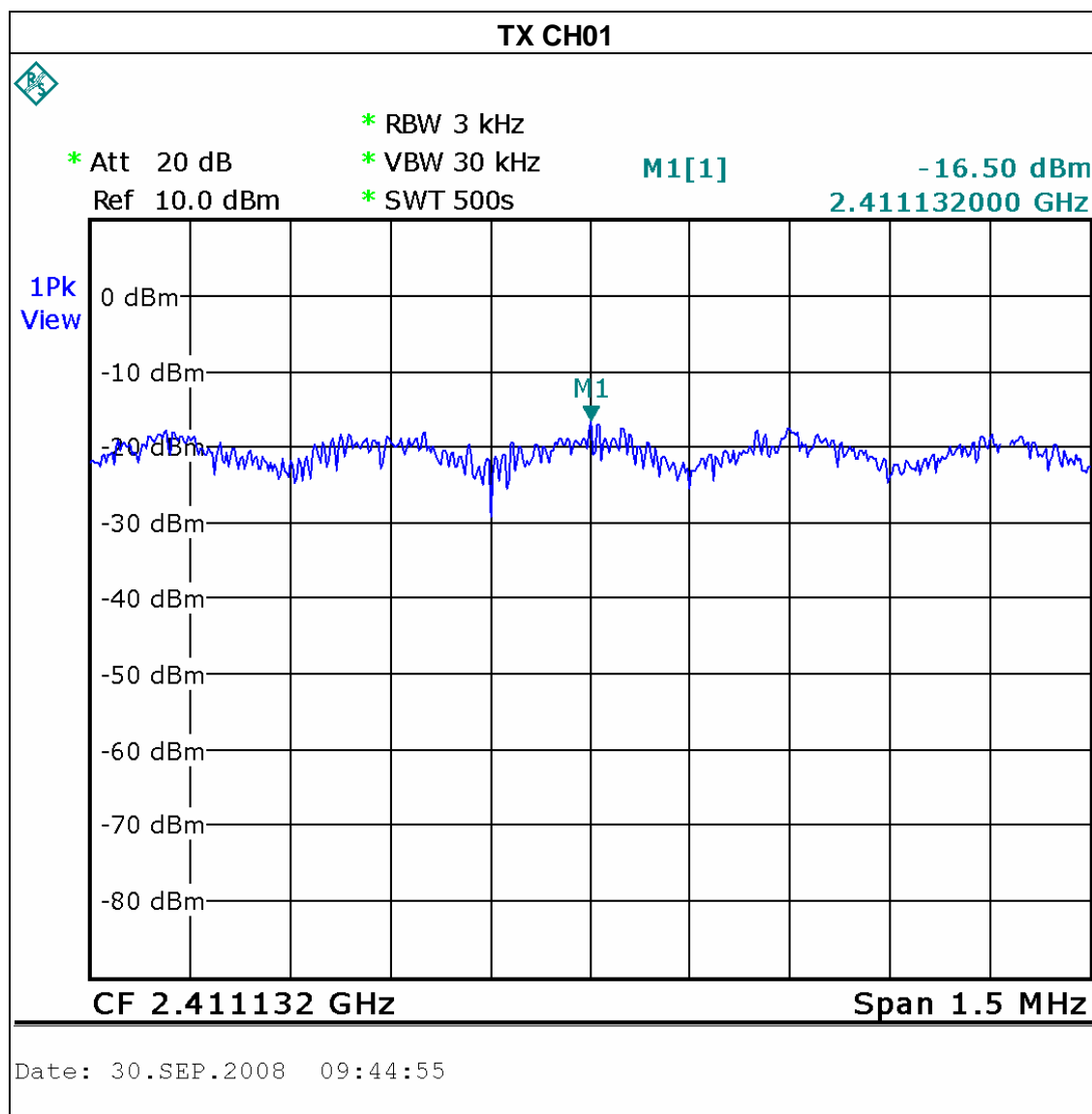

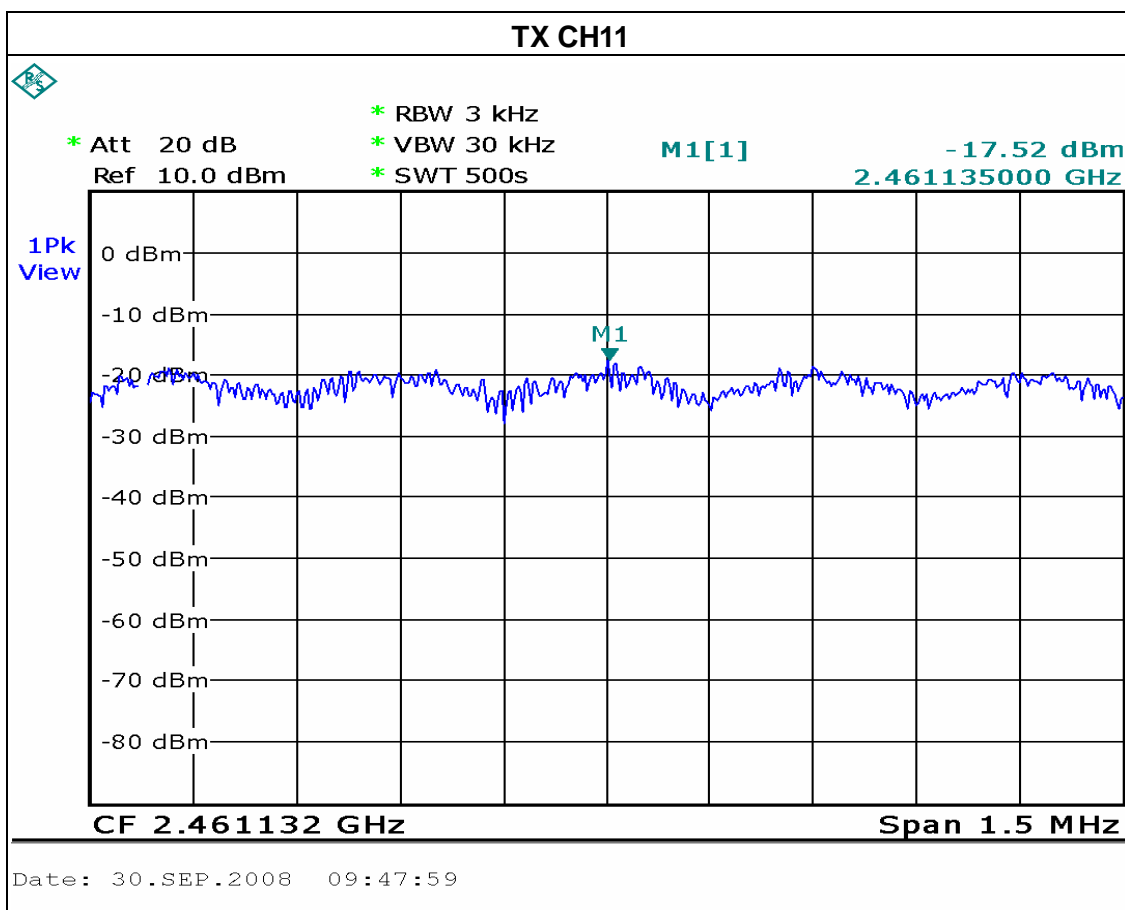
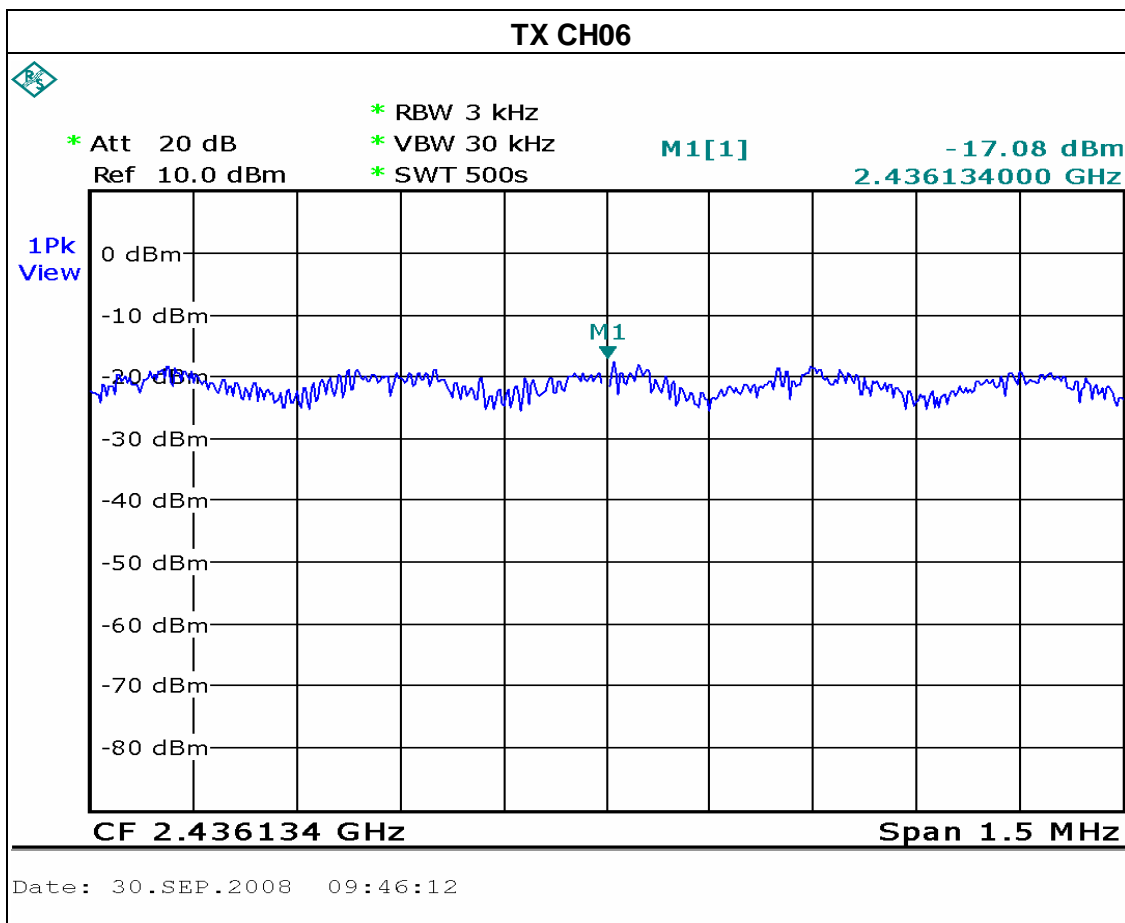

EUT :	802.11n High-speed Wireless Broadband Router	Model Name :	NW725
Temperature :	25 °C	Relative Humidity :	60%
Pressure :	1016 hPa	Test Voltage :	AC 120V/60Hz
Test Mode :	802.11n/20M/CH01, CH06, CH11(Antenna A)		

Test Channel	Frequency (MHz)	Power Density (dBm)	LIMIT (dBm)
CH01	2412	-19.36	8
CH06	2437	-20.04	8
CH11	2462	-20.57	8

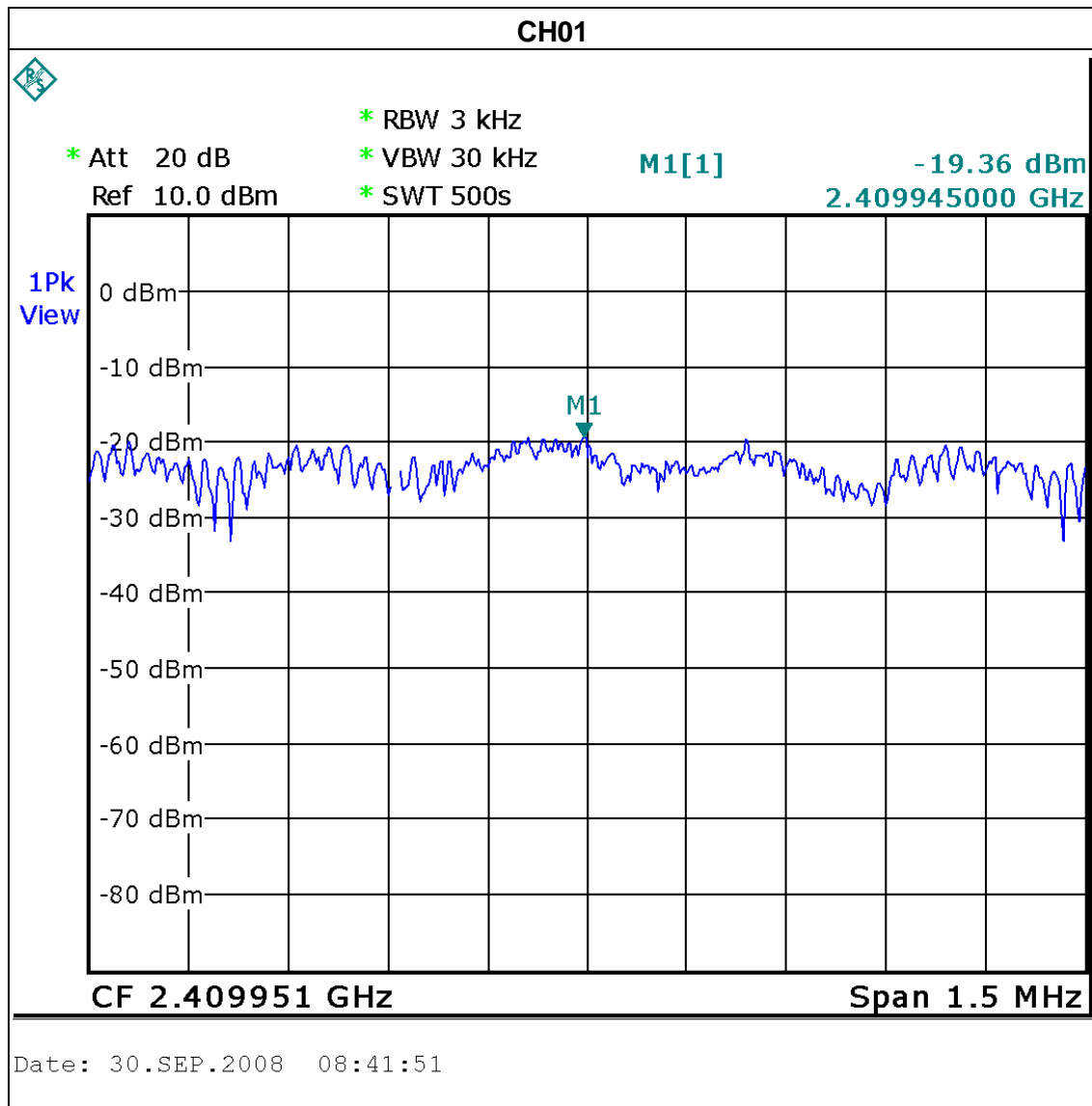

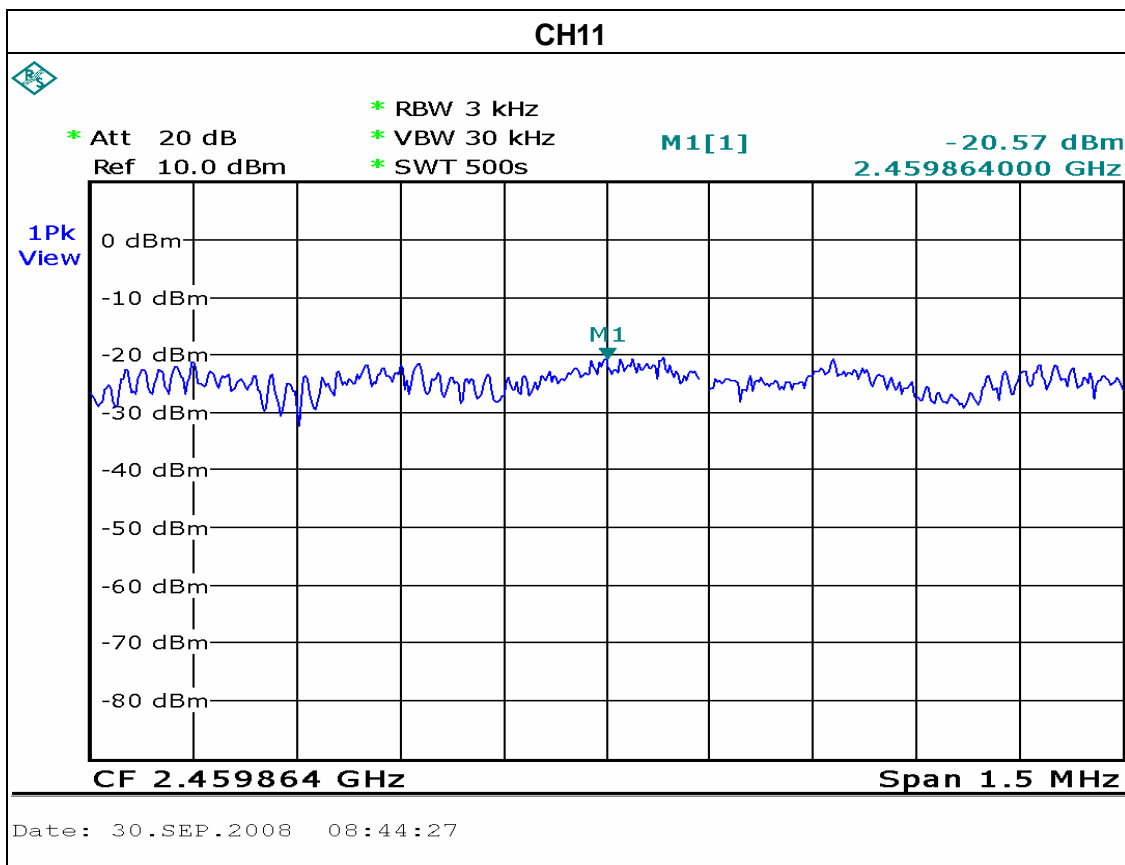
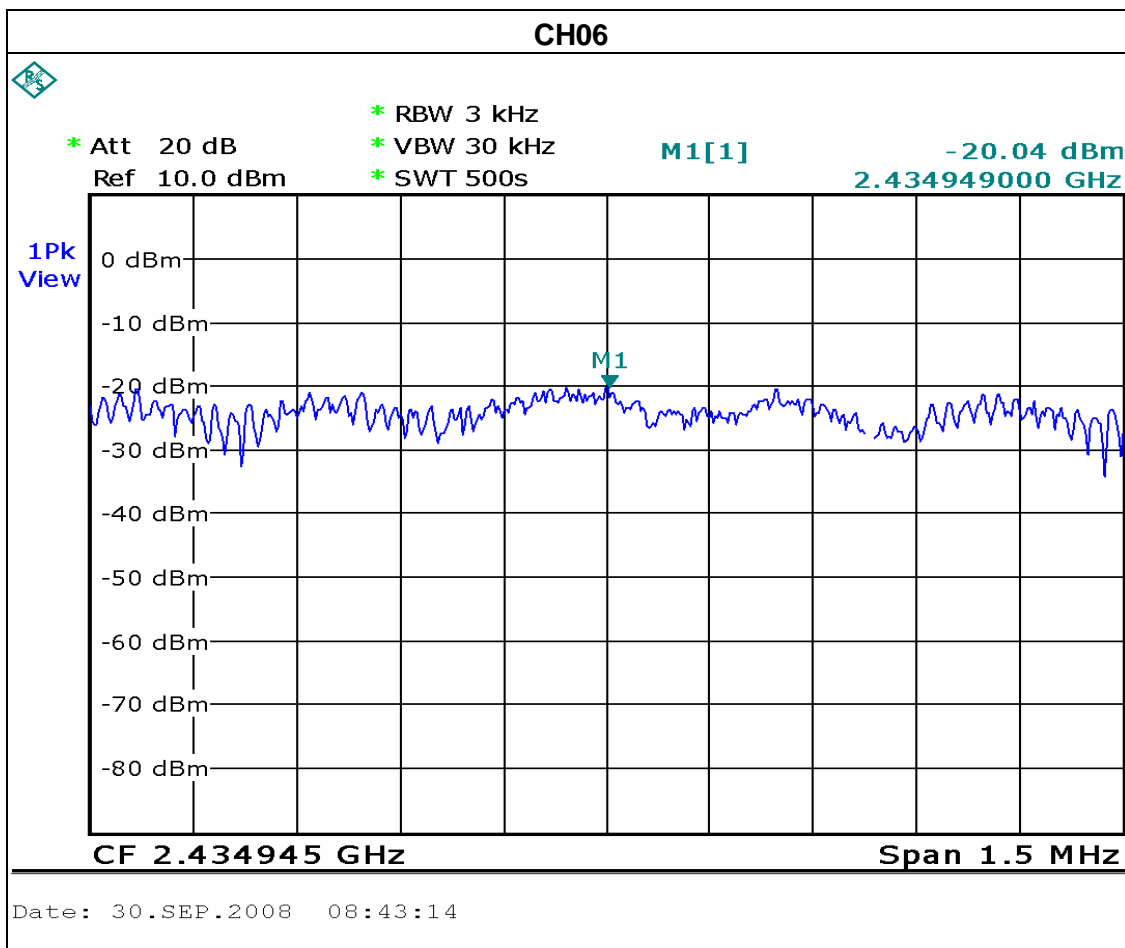

EUT :	802.11n High-speed Wireless Broadband Router	Model Name :	NW725
Temperature :	25 °C	Relative Humidity :	60%
Pressure :	1016 hPa	Test Voltage :	AC 120V/60Hz
Test Mode :	802.11n/20M/CH01, CH06, CH11(Antenna C)		

Test Channel	Frequency (MHz)	Power Density (dBm)	LIMIT (dBm)
CH01	2412	-19.82	8
CH06	2437	-20.28	8
CH11	2462	-20.61	8

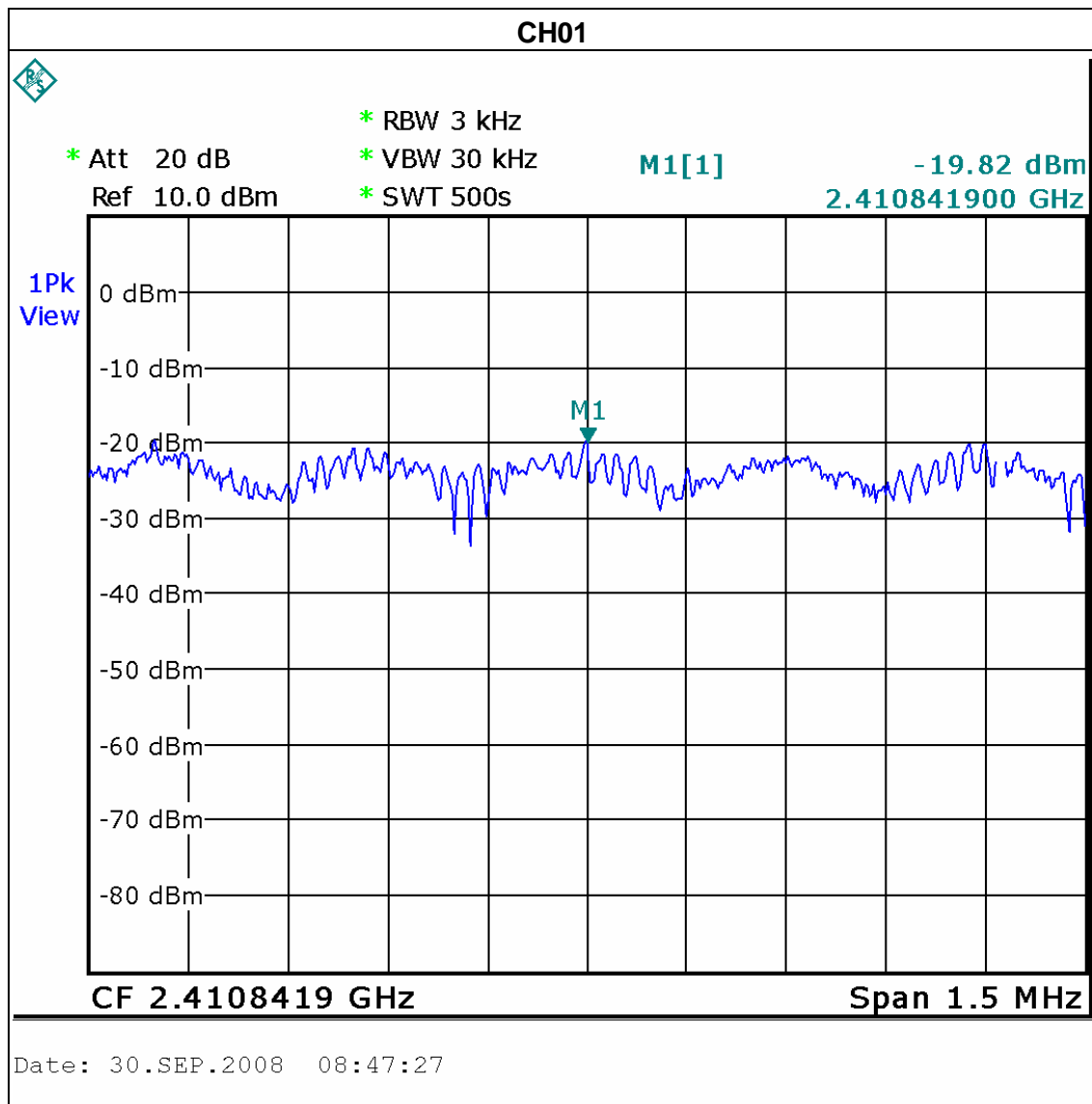

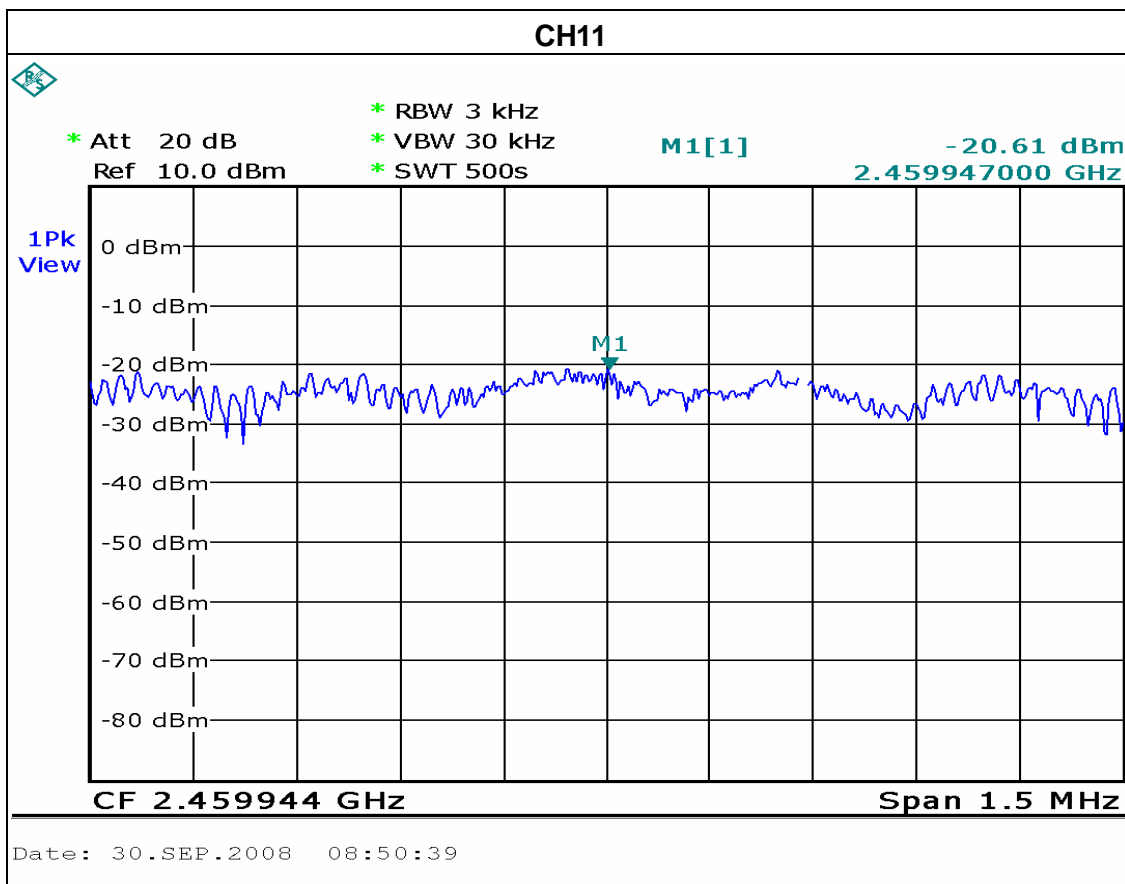
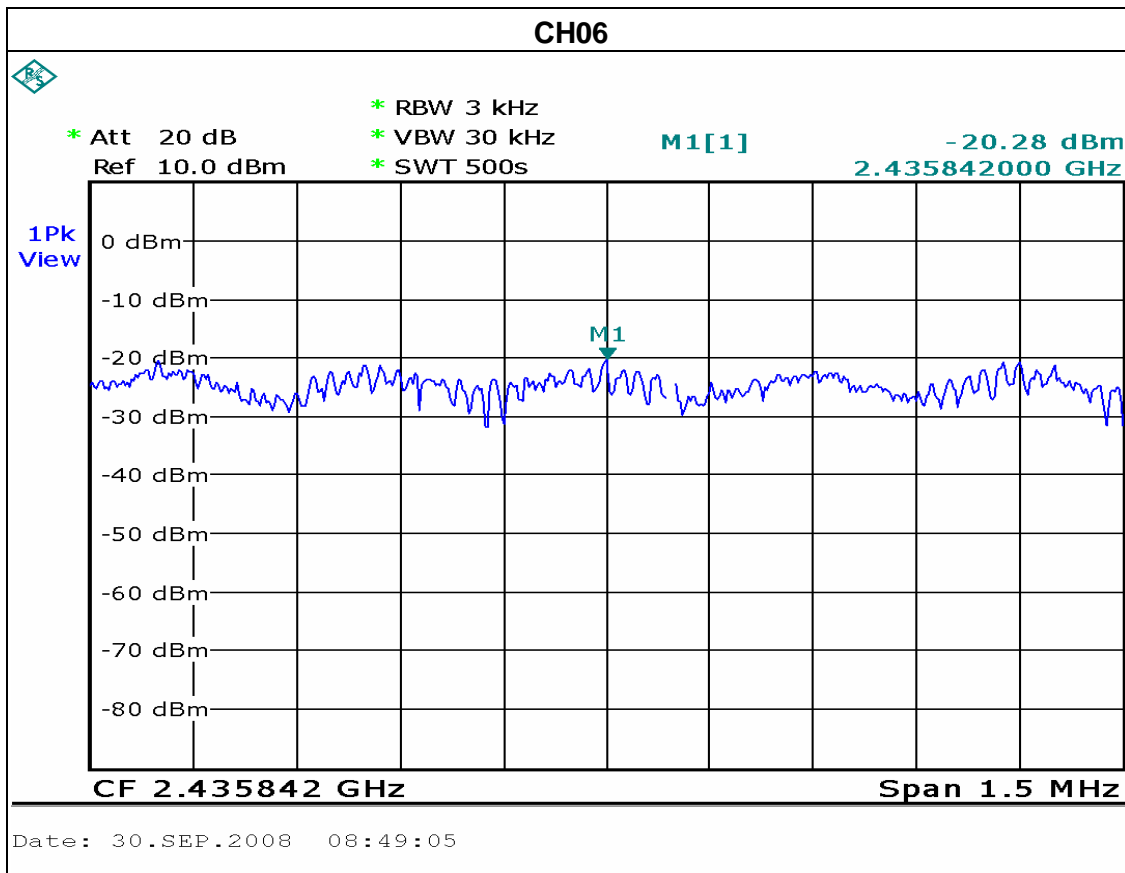

EUT :	802.11n High-speed Wireless Broadband Router	Model Name :	NW725
Temperature :	25 °C	Relative Humidity :	60%
Pressure :	1016 hPa	Test Voltage :	AC 120V/60Hz
Test Mode :	802.11n/20M/CH01, CH06, CH11(Antenna A & Antenna C)		

Test Channel	Frequency (MHz)	Power Density (dBm)	LIMIT (dBm)
CH01	2412	-13.13	8
CH06	2437	-15.07	8
CH11	2462	-14.02	8

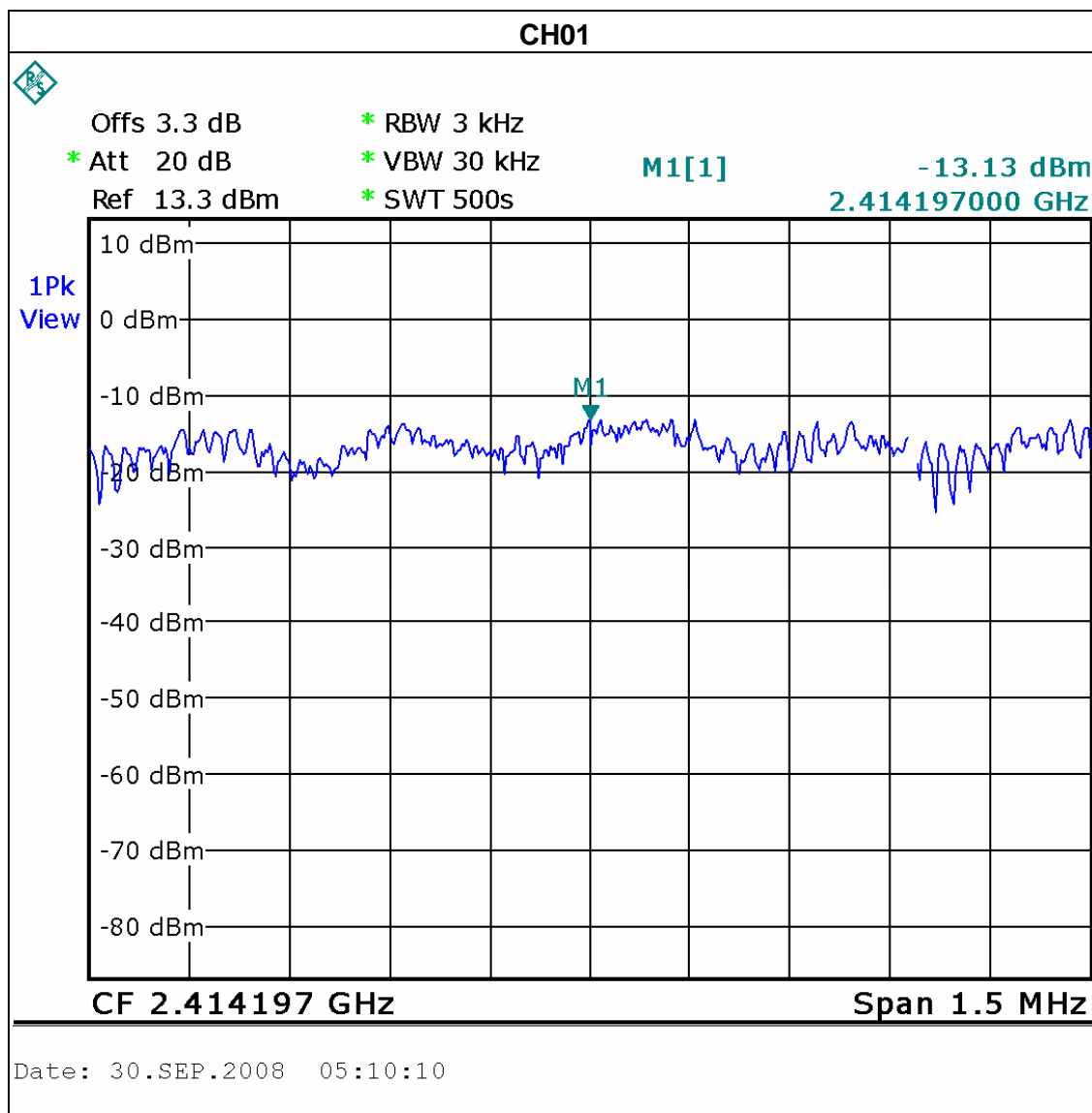

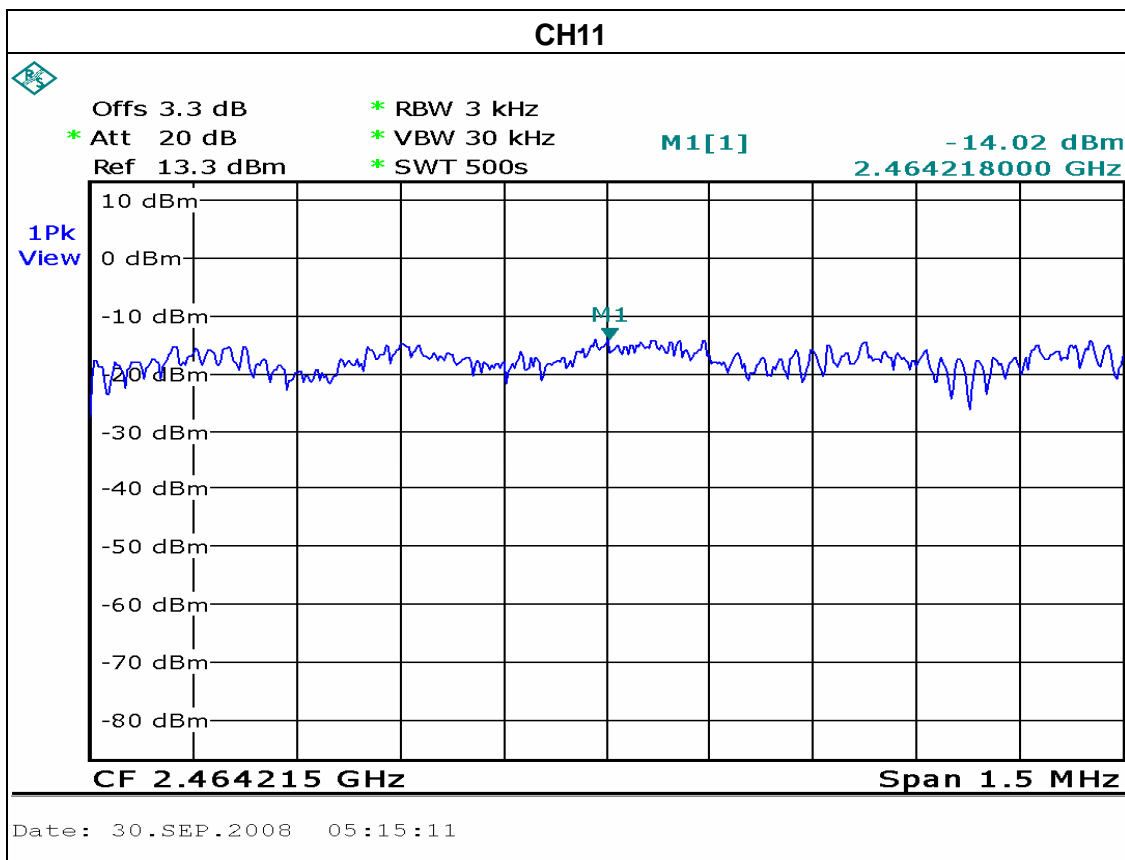
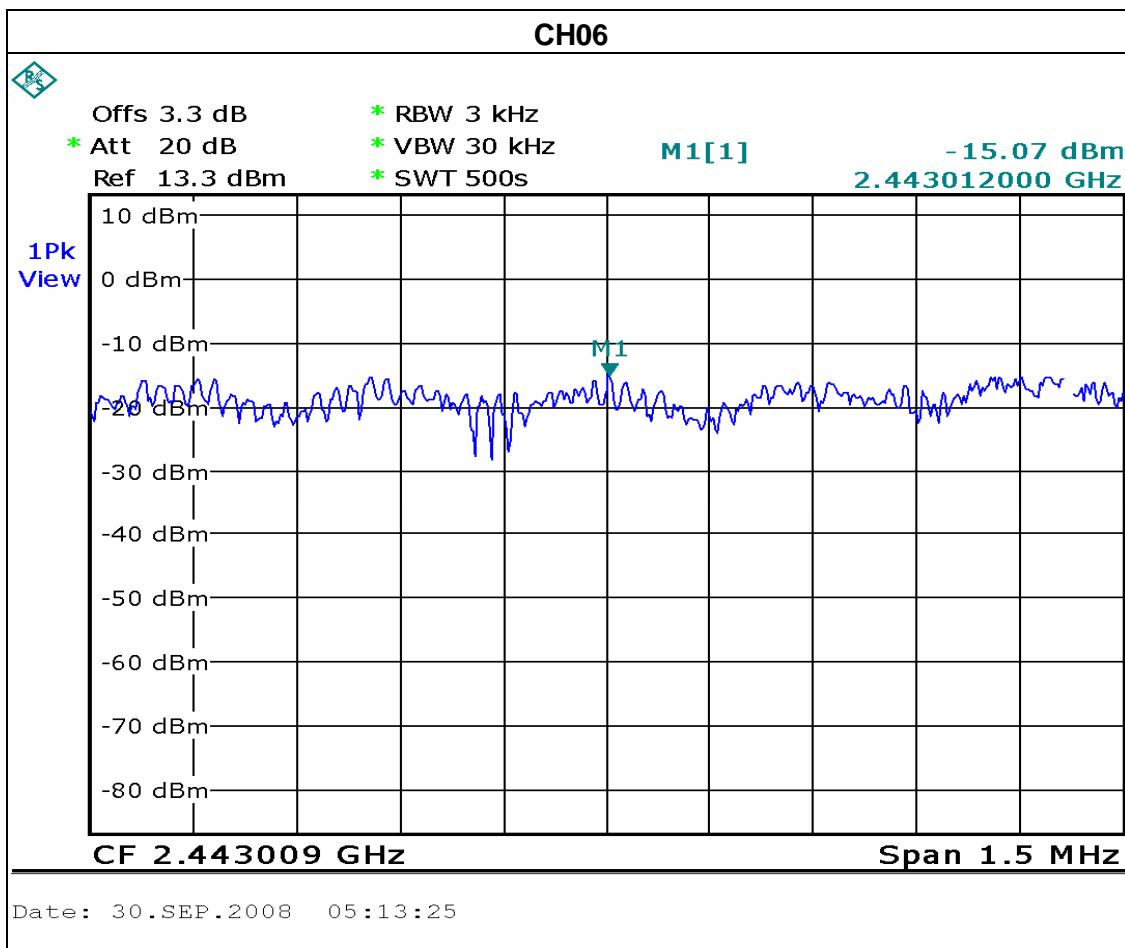

EUT :	802.11n High-speed Wireless Broadband Router	Model Name :	NW725
Temperature :	25 °C	Relative Humidity :	60%
Pressure :	1016 hPa	Test Voltage :	AC 120V/60Hz
Test Mode :	802.11n/40M/CH03, CH06, CH09(Antenna A)		

Test Channel	Frequency (MHz)	Power Density (dBm)	LIMIT (dBm)
CH03	2422	-23.95	8
CH06	2437	-21.84	8
CH09	2452	-22.17	8

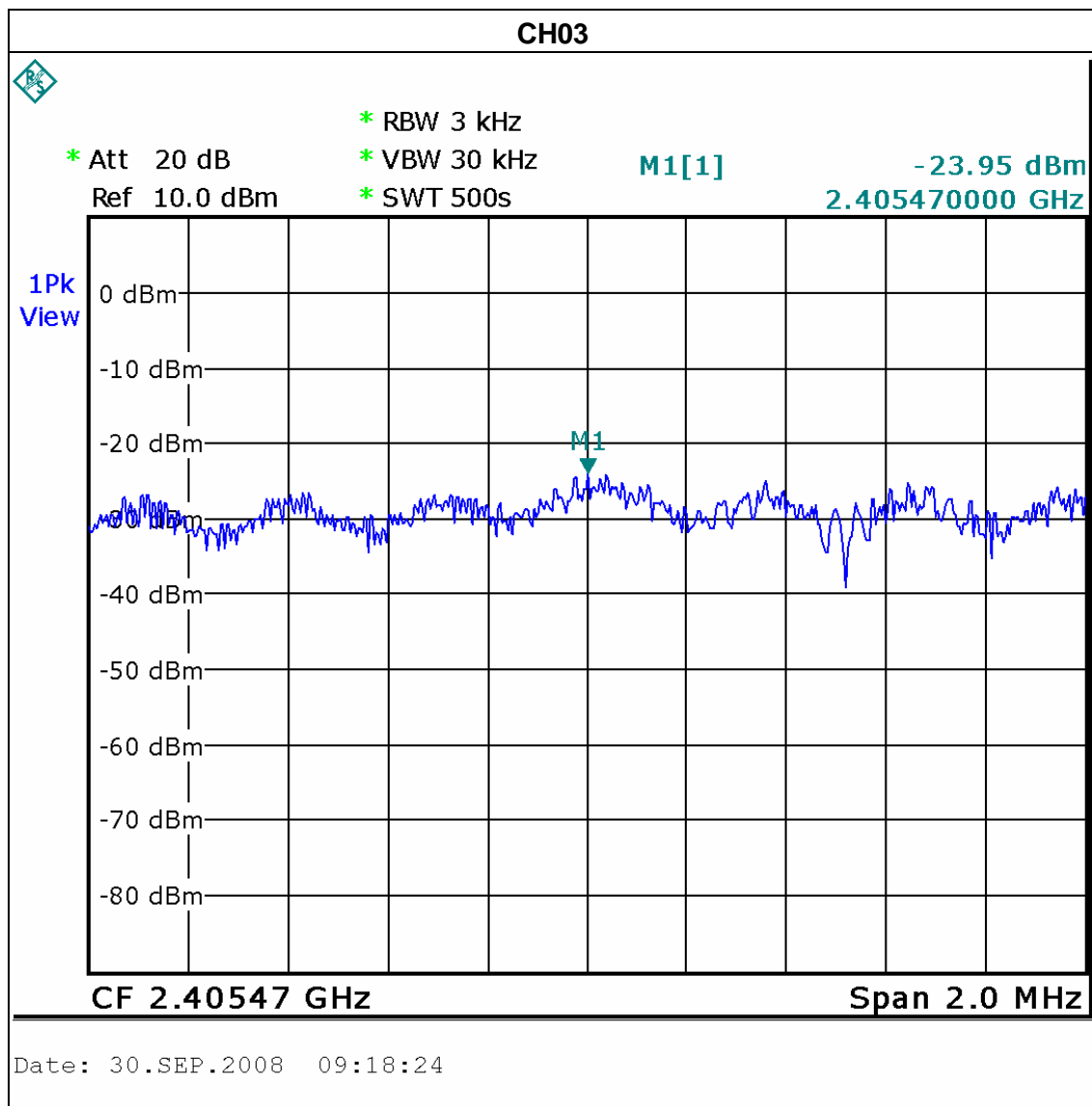

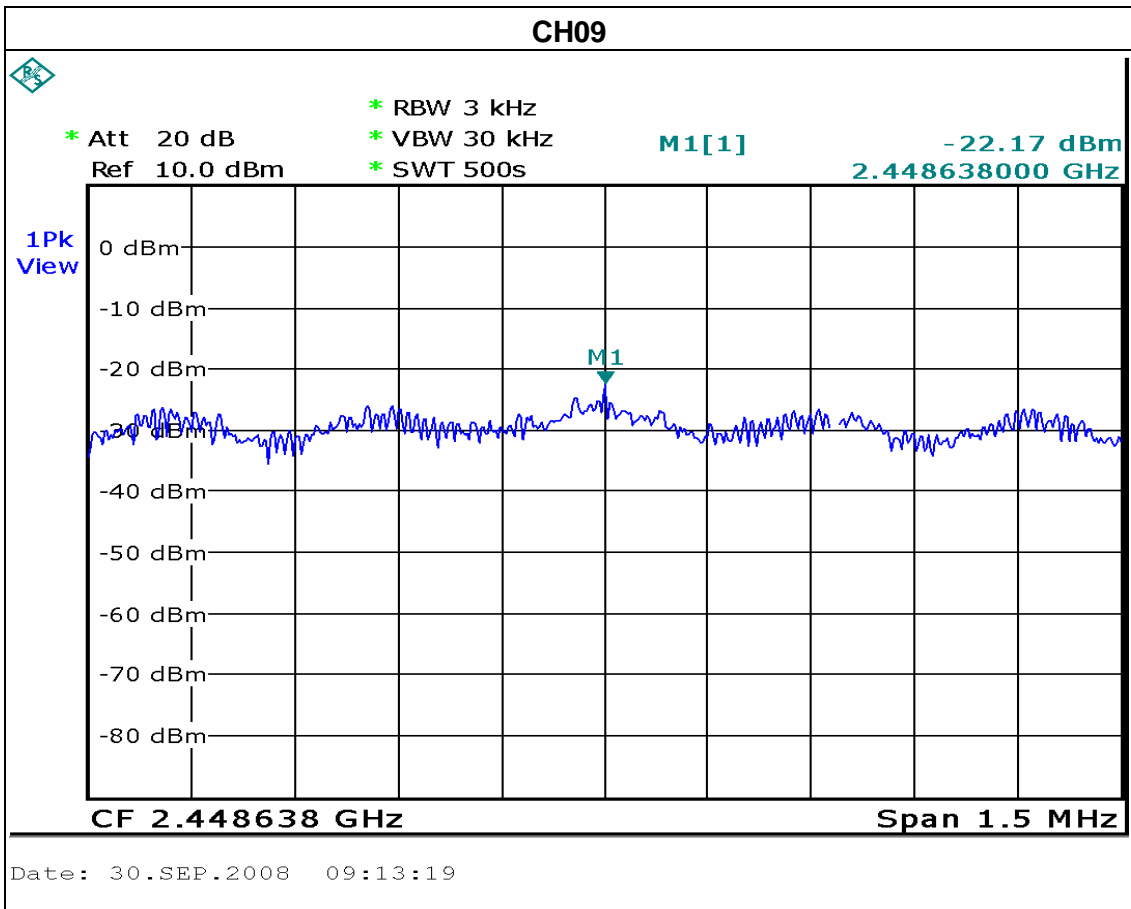
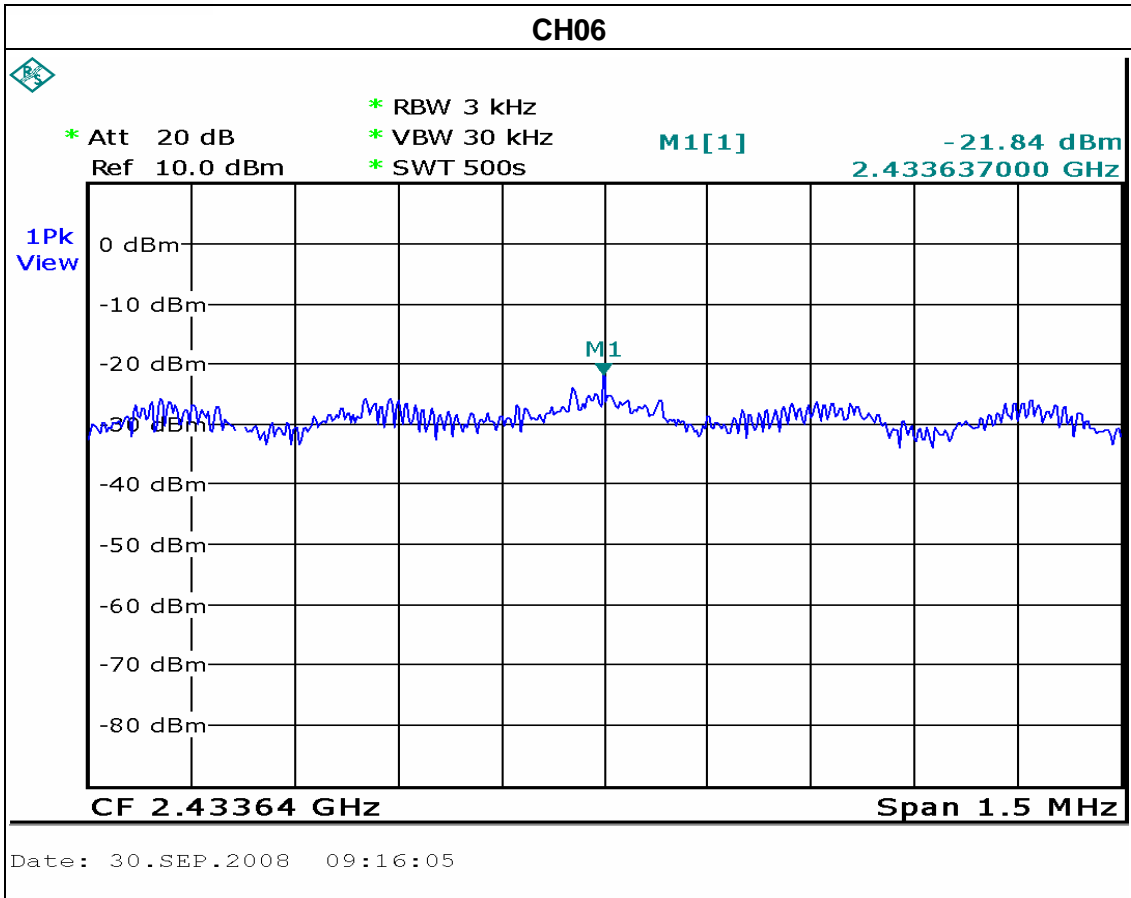

EUT :	802.11n High-speed Wireless Broadband Router	Model Name :	NW725
Temperature :	25 °C	Relative Humidity :	60%
Pressure :	1016 hPa	Test Voltage :	AC 120V/60Hz
Test Mode :	802.11n/40M/CH03, CH06, CH09(Antenna C)		

Test Channel	Frequency (MHz)	Power Density (dBm)	LIMIT (dBm)
CH03	2422	-24.52	8
CH06	2437	-24.10	8
CH09	2452	-22.87	8

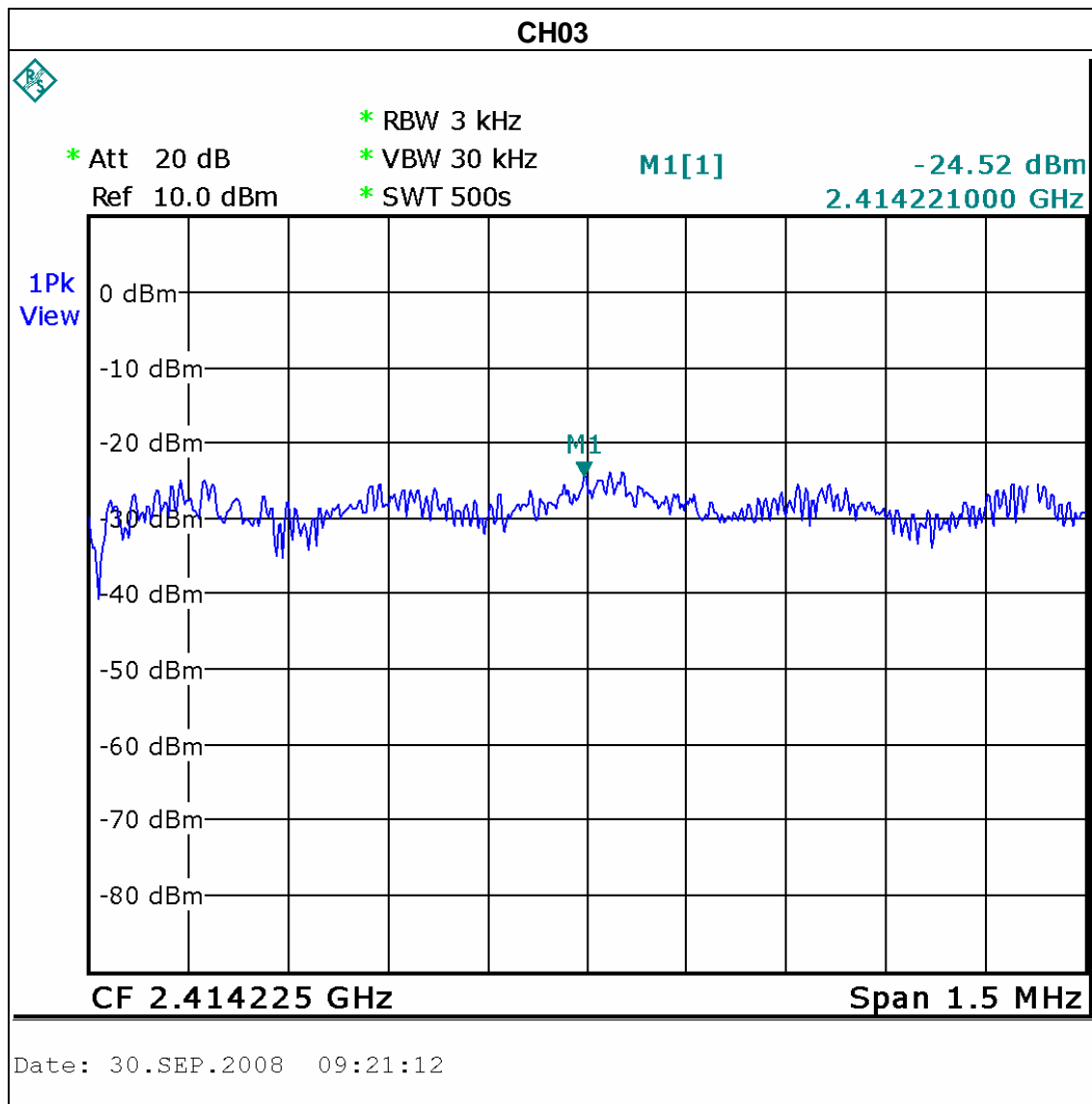

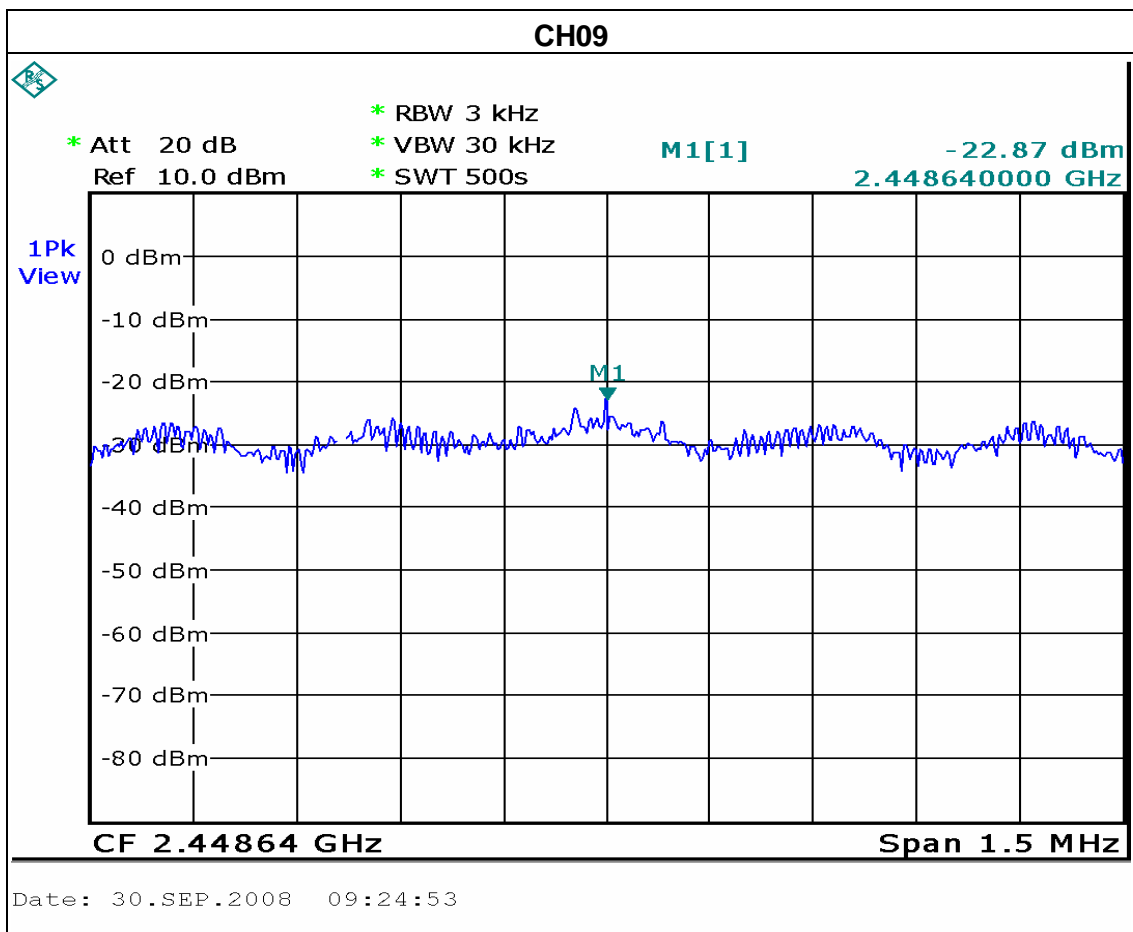
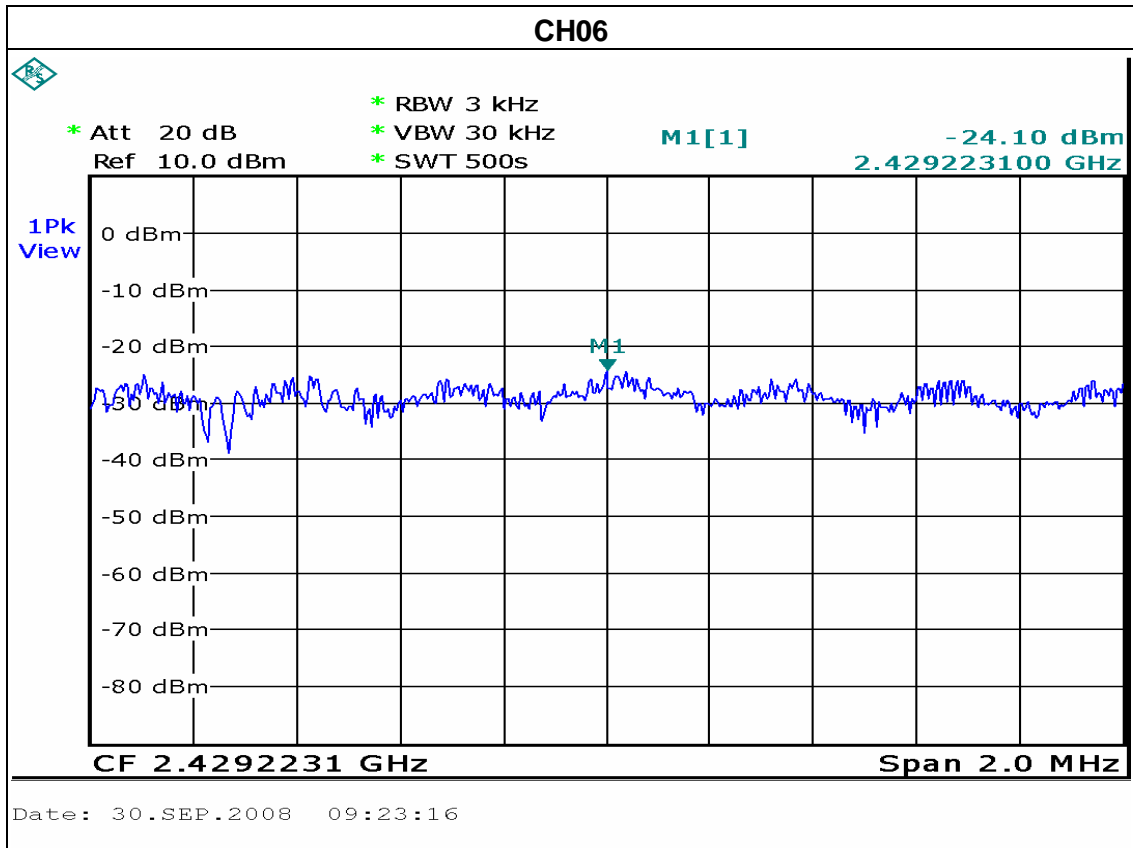

EUT :	802.11n High-speed Wireless Broadband Router	Model Name :	NW725
Temperature :	25 °C	Relative Humidity :	60%
Pressure :	1016 hPa	Test Voltage :	AC 120V/60Hz
Test Mode :	802.11n/40M/CH03, CH06, CH09(Antenna A & Antenna C)		

Test Channel	Frequency (MHz)	Power Density (dBm)	LIMIT (dBm)
CH03	2422	-18.12	8
CH06	2437	-15.67	8
CH09	2452	-18.43	8

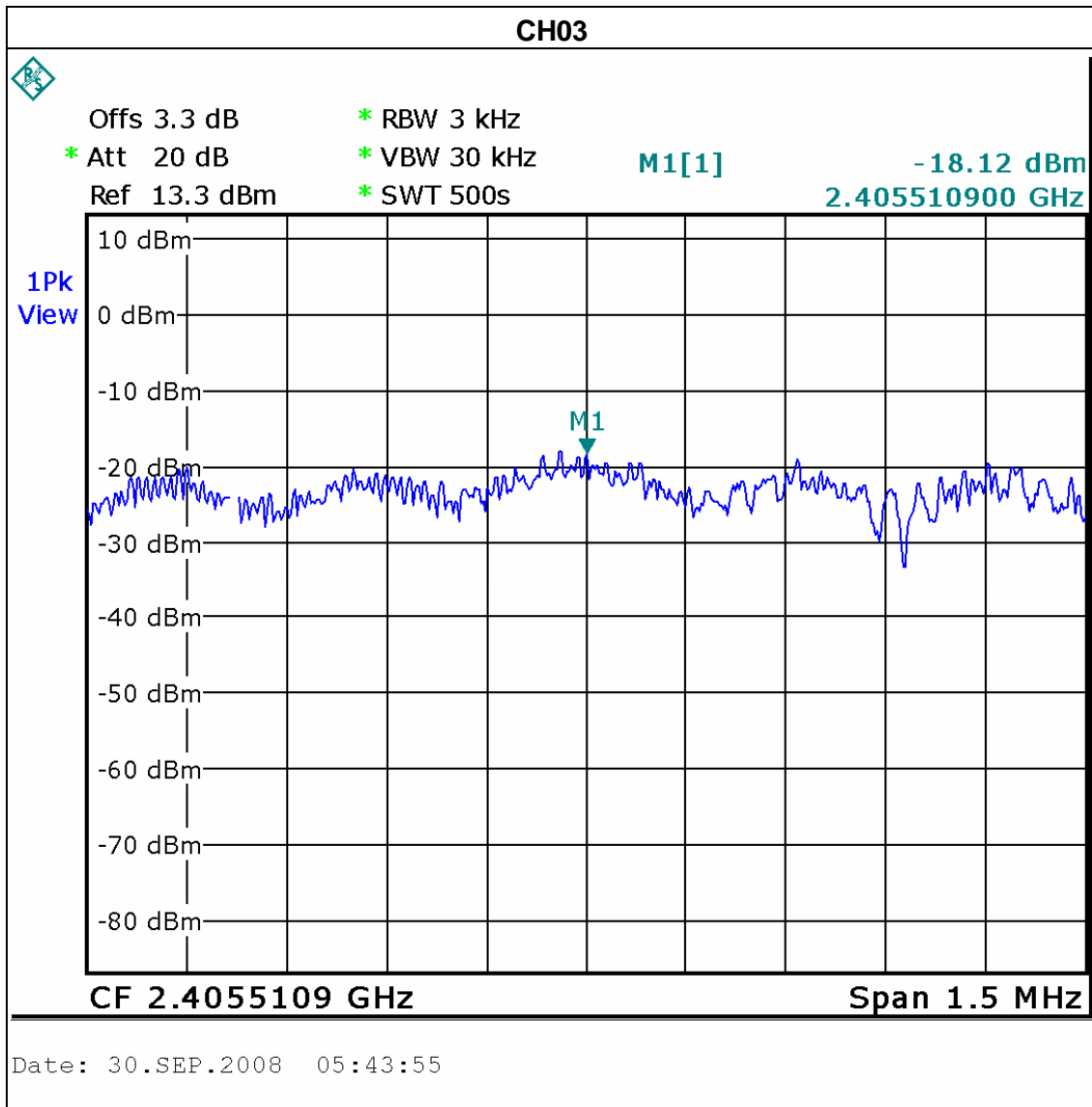

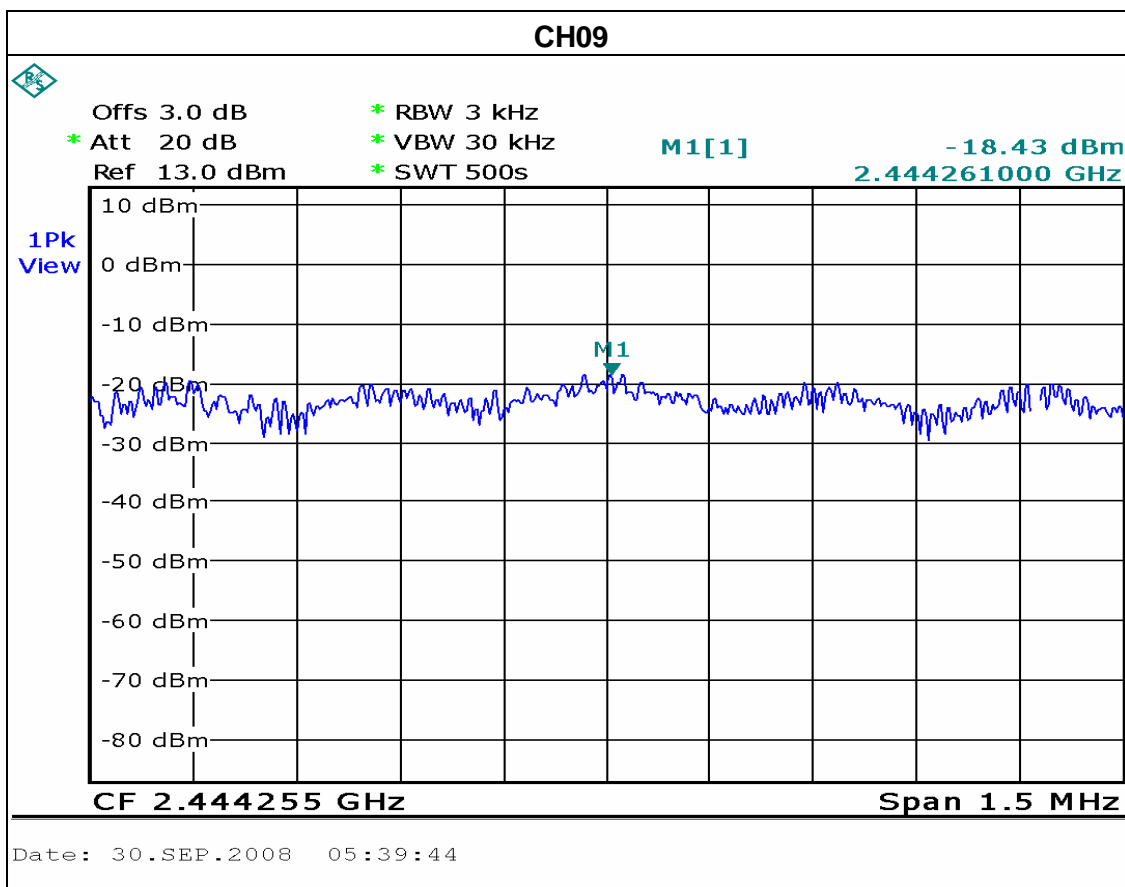
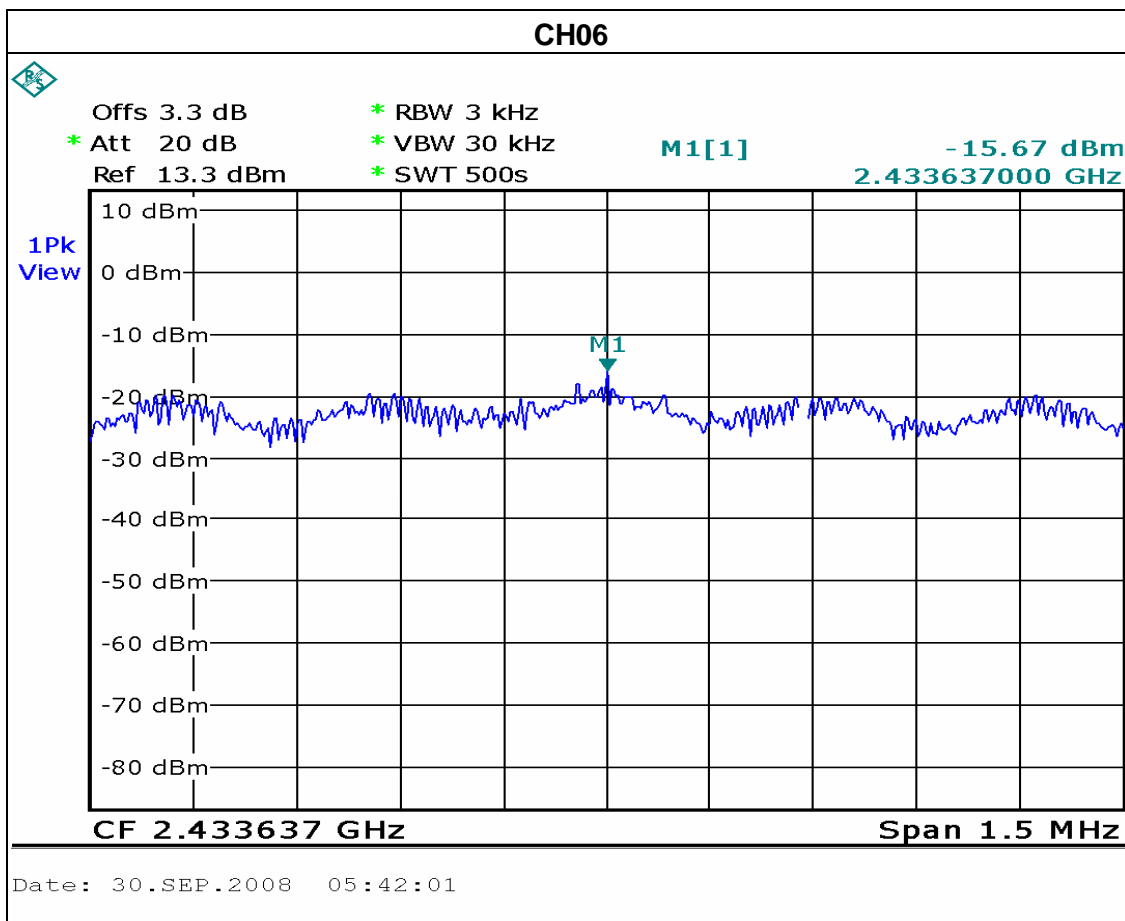

9. RF EXPOSURE TEST

9.1 APPLIED PROCEDURES / LIMIT

Systems operating under the provisions of this section shall be operated in a manner that ensures that the public is not exposed to radio frequency energy levels in excess limit for maximum permissible exposure. In accordance with 47 CFR FCC Part 2 Subpart J, section 2.1091 this device has been defined as a mobile device whereby a distance of 0.2 m normally can be maintained between the user and the device.

(A) Limits for Occupational / Controlled Exposure

Frequency Range (MHz)	Electric Field Strength (E) (V/m)	Magnetic Field Strength (H) (A/m)	Power Density (S) (mW/ cm ²)	Averaging Time E ² , H ² or S (minutes)
0.3-3.0	614	1.63	(100)*	6
3.0-30	1842 / f	4.89 / f	(900 / f)*	6
30-300	61.4	0.163	1.0	6
300-1500			F/300	6
1500-100,000			5	6

(B) Limits for General Population / Uncontrolled Exposure

Frequency Range (MHz)	Electric Field Strength (E) (V/m)	Magnetic Field Strength (H) (A/m)	Power Density (S) (mW/ cm ²)	Averaging Time E ² , H ² or S (minutes)
0.3-1.34	614	1.63	(100)*	30
1.34-30	824/f	2.19/f	(180/f)*	30
30-300	27.5	0.073	0.2	30
300-1500			F/1500	30
1500-100,000			1.0	30

Note: f = frequency in MHz ; *Plane-wave equivalent power density

9.1.1 MEASUREMENT INSTRUMENTS LIST

Item	Kind of Equipment	Manufacturer	Type No.	Serial No.	Calibrated until
1	Spectrum Analyzer	R&S	FSP_40	100129	Jan. 07, 2009

Remark: " N/A" denotes No Model Name , Serial No. or No Calibration specified.

9.1.2 MPE CALCULATION METHOD

$$E \text{ (V/m)} = \frac{\sqrt{30 \times P \times G}}{d} \qquad \text{Power Density: } Pd \text{ (W/m}^2\text{)} = \frac{E^2}{377}$$

E = Electric field (V/m)

P = Peak RF output power (W)

G = EUT Antenna numeric gain (numeric)

d = Separation distance between radiator and human body (m)

The formula can be changed to

$$Pd = \frac{30 \times P \times G}{377 \times d^2}$$

From the peak EUT RF output power, the minimum mobile separation distance, d=0.2m, as well as the gain of the used antenna, the RF power density can be obtained

9.1.3 DEVIATION FROM STANDARD

No deviation.

9.1.4 TEST SETUP

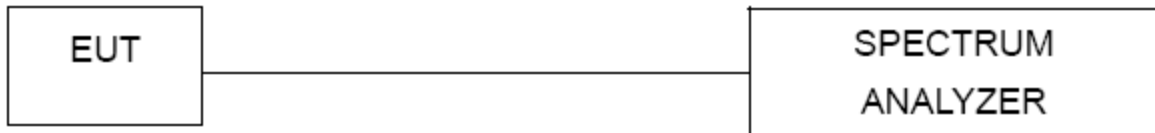

9.1.5 EUT OPERATION CONDITIONS

The EUT tested system was configured as the statements of 4.1.6 Unless otherwise a special operating condition is specified in the follows during the testing.

9.1.6 TEST RESULTS

EUT :	802.11n High-speed Wireless Broadband Router	Model Name :	NW725
Temperature :	25 °C	Relative Humidity :	60%
Pressure :	1016 hPa	Test Voltage :	AC 120V/60Hz
Test Mode :	TX B mode CH01, CH06, CH11		

Antenna Gain (dBi)	Antenna Gain (numeric)	Peak Output Power (dBm)	Peak Output Power (mW)	Power Density (S) (mW/cm ²)	Limit of Power Density (S) (mW/cm ²)	Test Result
2.0	1.5849	17.00	50.1187	0.015811	1	Complies
2.0	1.5849	17.02	50.3501	0.015884	1	Complies
2.0	1.5849	17.08	51.0505	0.016105	1	Complies

EUT :	802.11n High-speed Wireless Broadband Router	Model Name :	NW725
Temperature :	25 °C	Relative Humidity :	60%
Pressure :	1016 hPa	Test Voltage :	AC 120V/60Hz
Test Mode :	TX G mode CH01, CH06, CH11		

Antenna Gain (dBi)	Antenna Gain (numeric)	Peak Output Power (dBm)	Peak Output Power (mW)	Power Density (S) (mW/cm ²)	Limit of Power Density (S) (mW/cm ²)	Test Result
2.0	1.5849	14.00	25.1189	0.007924	1	Complies
2.0	1.5849	14.03	25.2930	0.007979	1	Complies
2.0	1.5849	14.11	25.7632	0.008127	1	Complies

EUT :	802.11n High-speed Wireless Broadband Router	Model Name :	NW725
Temperature :	25 °C	Relative Humidity :	60%
Pressure :	1016 hPa	Test Voltage :	AC 120V/60Hz
Test Mode :	TX N/20M/CH01, CH06, CH11(Antenna A)		

Antenna Gain (dBi)	Antenna Gain (numeric)	Peak Output Power (dBm)	Peak Output Power (mW)	Power Density (S) (mW/cm ²)	Limit of Power Density (S) (mW/cm ²)	Test Result
2.0	1.5849	10.02	10.0462	0.003169	1	Complies
2.0	1.5849	10.11	10.2565	0.003236	1	Complies
2.0	1.5849	10.24	10.5682	0.003334	1	Complies

EUT :	802.11n High-speed Wireless Broadband Router	Model Name :	NW725
Temperature :	25 °C	Relative Humidity :	60%
Pressure :	1016 hPa	Test Voltage :	AC 120V/60Hz
Test Mode :	TX N/20M/CH01, CH06, CH11(Antenna C)		

Antenna Gain (dBi)	Antenna Gain (numeric)	Peak Output Power (dBm)	Peak Output Power (mW)	Power Density (S) (mW/cm ²)	Limit of Power Density (S) (mW/cm ²)	Test Result
2.0	1.5849	9.96	9.9083	0.003126	1	Complies
2.0	1.5849	10.00	10.0000	0.003155	1	Complies
2.0	1.5849	10.11	10.2565	0.003236	1	Complies

EUT :	802.11n High-speed Wireless Broadband Router	Model Name :	NW725
Temperature :	25 °C	Relative Humidity :	60%
Pressure :	1016 hPa	Test Voltage :	AC 120V/60Hz
Test Mode :	TX N/20M/CH01, CH06, CH11(Antenna A+C)		

Antenna Gain (dBi)	Antenna Gain (numeric)	Peak Output Power (dBm)	Peak Output Power (mW)	Power Density (S) (mW/cm ²)	Limit of Power Density (S) (mW/cm ²)	Test Result
2.0	1.5849	13.00	19.9526	0.006294	1	Complies
2.0	1.5849	13.06	20.2302	0.006382	1	Complies
2.0	1.5849	13.19	20.8449	0.006576	1	Complies

EUT :	802.11n High-speed Wireless Broadband Router	Model Name :	NW725
Temperature :	25 °C	Relative Humidity :	60%
Pressure :	1016 hPa	Test Voltage :	AC 120V/60Hz
Test Mode :	TX N/40M/CH03, CH06, CH09(Antenna A)		

Antenna Gain (dBi)	Antenna Gain (numeric)	Peak Output Power (dBm)	Peak Output Power (mW)	Power Density (S) (mW/cm ²)	Limit of Power Density (S) (mW/cm ²)	Test Result
2.0	1.5849	9.00	7.9433	0.002506	1	Complies
2.0	1.5849	9.05	8.0353	0.002535	1	Complies
2.0	1.5849	9.10	8.1283	0.002564	1	Complies

EUT :	802.11n High-speed Wireless Broadband Router	Model Name :	NW725
Temperature :	25 °C	Relative Humidity :	60%
Pressure :	1016 hPa	Test Voltage :	AC 120V/60Hz
Test Mode :	TX N/40M/CH03, CH06, CH09(Antenna C)		

Antenna Gain (dBi)	Antenna Gain (numeric)	Peak Output Power (dBm)	Peak Output Power (mW)	Power Density (S) (mW/cm ²)	Limit of Power Density (S) (mW/cm ²)	Test Result
2.0	1.5849	9.02	7.9799	0.002517	1	Complies
2.0	1.5849	9.04	8.0168	0.002529	1	Complies
2.0	1.5849	9.09	8.1096	0.002558	1	Complies

EUT :	802.11n High-speed Wireless Broadband Router	Model Name :	NW725
Temperature :	25 °C	Relative Humidity :	60%
Pressure :	1016 hPa	Test Voltage :	AC 120V/60Hz
Test Mode :	TX N/40M/CH03, CH06, CH09(Antenna A+C)		

Antenna Gain (dBi)	Antenna Gain (numeric)	Peak Output Power (dBm)	Peak Output Power (mW)	Power Density (S) (mW/cm ²)	Limit of Power Density (S) (mW/cm ²)	Test Result
2.0	1.5849	12.04	15.9956	0.005046	1	Complies
2.0	1.5849	12.06	16.0694	0.005069	1	Complies
2.0	1.5849	12.11	16.2555	0.005128	1	Complies

10. EUT TEST PHOTO

Conducted Measurement Photos



Radiated Measurement Photos

