

FCC Radio Test Report

FCC ID: T58N2R

Project No. : 1907T039
Equipment : AC1200 Wireless Daul Band Gigabit Router
Test Model : N2
Series Model : N2U
Applicant : NETIS SYSTEMS CO., LTD
Address : Floor 8, Building B, TongFang Information Harbor,
No.11 Langshan Road, Nanshan District, Shenzhen,
China.

Date of Receipt : 2019/7/4
Date of Test : 2019/7/4 ~ 2019/9/4
Issued Date : 2019/11/13
Tested by : BTL Inc.

Testing Engineer :

(Tim Lee)

Technical Manager :

(Pike Lee)

Authorized Signatory :

(Andy Chiu)

B T L I N C .

No.18, Ln. 171, Sec. 2, Jiuzong Rd.,
Neihu Dist., Taipei City 114, Taiwan
TEL: +886-2-2657-3299 FAX: +886-2-2657-3331



Declaration

BTL represents to the client that testing is done in accordance with standard procedures as applicable and that test instruments used has been calibrated with standards traceable to international standard(s) and/or national standard(s).

BTL's reports apply only to the specific samples tested under conditions. It is manufacture's responsibility to ensure that additional production units of this model are manufactured with the identical electrical and mechanical components. **BTL** shall have no liability for any declarations, inferences or generalizations drawn by the client or others from **BTL** issued reports.

The report must not be used by the client to claim product certification, approval, or endorsement by NIST, A2LA, or any agency of the U.S. Government.

This report is the confidential property of the client. As a mutual protection to the clients, the public and ourselves, the test report shall not be reproduced, except in full, without our written approval.

BTL's laboratory quality assurance procedures are in compliance with the **ISO/IEC 17025** requirements, and accredited by the conformity assessment authorities listed in this test report.

BTL is not responsible for the sampling stage, so the results only apply to the sample as received.

The information, data and test plan are provided by manufacturer which may affect the validity of results, so it is manufacturer's responsibility to ensure that the apparatus meets the essential requirements of applied standards and in all the possible configurations as representative of its intended use.

Limitation

For the use of the authority's logo is limited unless the Test Standard(s)/Scope(s)/Item(s) mentioned in this test report is (are) included in the conformity assessment authorities acceptance respective.

Please note that the measurement uncertainty is provided for informational purpose only and are not use in determining the Pass/Fail results.

CONTENTS

REPORT ISSUED HISTORY	5
1 CERTIFICATION	6
2 SUMMARY OF TEST RESULTS	7
2.1 TEST FACILITY	8
2.2 MEASUREMENT UNCERTAINTY	8
3 GENERAL INFORMATION	10
3.1 DESCRIPTION OF EUT	10
3.2 TEST MODES	13
3.3 PARAMETERS OF TEST SOFTWARE	15
3.4 DUTY CYCLE	16
3.5 BLOCK DIAGRAM SHOWING THE CONFIGURATION OF SYSTEM TESTED	17
3.6 SUPPORT UNITS	18
4 AC POWER LINE CONDUCTED EMISSIONS TEST	19
4.1 LIMIT	19
4.2 TEST PROCEDURE	19
4.3 DEVIATION FROM TEST STANDARD	19
4.4 TEST SETUP	20
4.5 EUT OPERATING CONDITIONS	20
4.6 TEST RESULT	20
5 RADIATED EMISSIONS TEST	21
5.1 LIMIT	21
5.2 TEST PROCEDURE	22
5.3 DEVIATION FROM TEST STANDARD	22
5.4 TEST SETUP	23
5.5 EUT OPERATING CONDITIONS	24
5.6 TEST RESULT – 9 KHZ TO 30 MHZ	24
5.7 TEST RESULT – 30MHZ TO 1000 MHZ	24
5.8 TEST RESULT – ABOVE 1000 MHZ	25
6 BANDWIDTH TEST	26
6.1 LIMIT	26
6.2 TEST PROCEDURE	26
6.3 DEVIATION FROM TEST STANDARD	26
6.4 TEST SETUP	26
6.5 EUT OPERATING CONDITIONS	26
6.6 TEST RESULT	26
7 PEAK OUTPUT POWER TEST	27
7.1 LIMIT	27
7.2 TEST PROCEDURE	27
7.3 DEVIATION FROM TEST STANDARD	27
7.4 TEST SETUP	27
7.5 EUT OPERATING CONDITIONS	27

7.6	TEST RESULT	27
8	POWER SPECTRAL DENSITY	28
8.1	LIMIT	28
8.2	TEST PROCEDURE	28
8.3	DEVIATION FROM TEST STANDARD	28
8.4	TEST SETUP	28
8.5	EUT OPERATING CONDITIONS	28
8.6	TEST RESULT	28
9	FREQUENCY STABILITY TEST	29
9.1	LIMIT	29
9.2	TEST PROCEDURE	29
9.3	DEVIATION FROM TEST STANDARD	29
9.4	TEST SETUP	29
9.5	EUT OPERATING CONDITIONS	29
9.6	TEST RESULT	29
10	LIST OF MEASURING EQUIPMENTS	30
11	EUT TEST PHOTO	31
APPENDIX A	AC POWER LINE CONDUCTED EMISSIONS	35
APPENDIX B	RADIATED EMISSIONS - 9 KHZ TO 30 MHZ	38
APPENDIX C	RADIATED EMISSIONS - 30 MHZ TO 1000 MHZ	43
APPENDIX D	RADIATED EMISSIONS - ABOVE 1000 MHZ	46
APPENDIX E	BANDWIDTH	97
APPENDIX F	CONDUCTED OUTPUT POWER	102
APPENDIX G	POWER SPECTRAL DENSITY	115
APPENDIX H	FREQUENCY STABILITY	126

REPORT ISSUED HISTORY

Report Version	Description	Issued Date
R00	Original Issue.	2019/9/20
R01	Revised Typo.	2019/9/20
R02	Added model name.	2019/10/15
R03	Change address.	2019/11/13

1 CERTIFICATION

Equipment : AC1200 Wireless Daul Band Gigabit Router
Brand Name : 
Test Model : N2
Series Model : N2U
Applicant : NETIS SYSTEMS CO., LTD
Manufacturer : NETIS SYSTEMS CO., LTD
Address : Floor 8, Building B, TongFang Information Harbor, No.11 Langshan Road,
Nanshan District, Shenzhen, China.
Date of Test : 2019/7/4 ~ 2019/9/4
Test Sample : Engineering Sample
Standard(s) : FCC Part15, Subpart E (15.407)
ANSI C63.10-2013

The above equipment has been tested and found in compliance with the requirement of the relative standards by BTL Inc.

The test data, data evaluation, and equipment configuration contained in our test report (Ref No. BTL-FCCP-2-1907T039) were obtained utilizing the test procedures, test instruments, test sites that has been accredited by the Authority of TAF according to the ISO/IEC 17025 quality assessment standard and technical standard(s).

Test results included in this report is only for the RLAN 5GHz part.

2 SUMMARY OF TEST RESULTS

Test procedures according to the technical standards.

FCC Part15, Subpart E (15.407)				
FCC Clause No	Description	Test Result	Judgement	Remark
15.207 15.407(b)	AC Power Line Conducted Emissions	APPENDIX A	Pass	-----
15.205 15.209 15.407(b)	Radiated Emissions	APPENDIX B APPENDIX C APPENDIX D	Pass	-----
15.407(a)	Bandwidth	APPENDIX E	Pass	-----
15.407(a)	Peak Output Power	APPENDIX F	Pass	-----
15.407(a)	Power Spectral Density	APPENDIX G	Pass	-----
15.407(g)	Frequency Stability	APPENDIX H	Pass	-----
15.203	Antenna Requirement	-----	Pass	-----
15.407(c)	Automatically Discontinue Transmission	-----	Pass	NOTE (2)

NOTE:

- (1) "N/A" denotes test is not applicable in this Test Report.
- (2) During no any information transmission, the EUT can automatically discontinue transmission and become standby mode for power saving.
The EUT can detect the controlling signal of ACK message transmitting from remote device and verify whether it shall resend or discontinue transmission.

2.1 TEST FACILITY

The test facilities used to collect the test data in this report:

- C05:** (FCC RN:674415; FCC DN:TW0659)
 No. 68-1, Ln. 169, Sec. 2, Datong Rd., Xizhi Dist., New Taipei City 221, Taiwan
- CB15:** (FCC RN:674415; FCC DN:TW0659)
 No. 68-1, Ln. 169, Sec. 2, Datong Rd., Xizhi Dist., New Taipei City 221, Taiwan
- SR06** (FCC RN:674415; FCC DN:TW0659)
 No. 68-1, Ln. 169, Sec. 2, Datong Rd., Xizhi Dist., New Taipei City 221, Taiwan

2.2 MEASUREMENT UNCERTAINTY

Where relevant, the following measurement uncertainty levels have been estimated for tests performed on the EUT as specified in CISPR 16-4-2. The BTL measurement uncertainty is less than the CISPR 16-4-2 U_{CISPR} requirement.

The reported uncertainty of measurement $y \pm U$, where expanded uncertainty U is based on a standard uncertainty multiplied by a coverage factor of $k=2$, providing a level of confidence of approximately 95 %.

A. AC power line conducted emissions test:

Test Site	Method	Measurement Frequency Range	U (dB)
C05	CISPR	150 kHz ~ 30MHz	3.44

B. Radiated emissions below 1 GHz test:

Test Site	Method	Measurement Frequency Range	Ant. H / V	U (dB)
CB15 (3m)	CISPR	30 MHz ~ 200 MHz	V	4.20
		30 MHz ~ 200 MHz	H	3.64
		200 MHz ~ 1,000 MHz	V	4.56
		200 MHz ~ 1,000 MHz	H	3.90

C. Radiated emissions above 1 GHz test:

Test Site	Method	Measurement Frequency Range	Ant. H / V	U (dB)
CB15 (3m)	CISPR	1 GHz ~ 6 GHz	V	4.46
		1 GHz ~ 6 GHz	H	4.40
		6 GHz ~18 GHz	V	3.88
		6 GHz ~18 GHz	H	4.00

Test Site	Method	Measurement Frequency Range	U (dB)
CB15 (1m)	CISPR	18 GHz ~ 26.5 GHz	4.62
		26.5 GHz ~ 40 GHz	5.12

D. Conducted tests:

Item	Method	U
Bandwidth	ANSI	3.8 %
Output Power	ANSI	0.95 dB
Power Spectral Density	ANSI	0.86 dB
Conducted Spurious Emissions	ANSI	2.71 dB

NOTE:

Unless specifically mentioned, the uncertainty of measurement has not been taken into account to declare the compliance or non-compliance to the specification.

Our calculated Measurement Instrumentation Uncertainty is shown in the tables above. These are our U_{lab} values in CISPR 16-4-2 terminology.

Since Table 1 of CISPR 16-4-2 has values of measurement instrumentation uncertainty, called U_{CISPR} , as follows:

Conducted Disturbance (mains port) – 150 kHz – 30 MHz : 3.6 dB

Radiated Disturbance (electric field strength on an open area test site or alternative test site) – 30 MHz – 1000 MHz : 5.2 dB

3 GENERAL INFORMATION

3.1 DESCRIPTION OF EUT

Equipment	AC1200 Wireless Dual Band Gigabit Router
Brand Name	
Test Model	N2
Series Model	N2U
Model Difference	Different model distribute to different area.
Power Source	DC Voltage supplied from AC/DC adapter.
Power Rating	I/P: 100-240V~50/60Hz, 0.5A O/P: 12V---1.0A
Frequency Range	UNII-1: 5150 MHz to 5250 MHz UNII-3: 5725 MHz to 5850 MHz
Operation Frequency	UNII-1: 5180 MHz to 5240 MHz UNII-3: 5745 MHz to 5825 MHz
Modulation Type	OFDM
Bit Rate of Transmitter	up to 866 Mbps
Maximum Output Power for UNII-1	IEEE 802.11a: 18.62 dBm (0.0728 W) IEEE 802.11n (HT20): 20.31 dBm (0.1073 W) IEEE 802.11n (HT40): 14.38 dBm (0.0274 W) IEEE 802.11ac (VHT20): 20.01 dBm (0.1002 W) IEEE 802.11ac (VHT40): 14.26 dBm (0.0267 W) IEEE 802.11ac (VHT80): 11.90 dBm (0.0155 W)
Maximum Output Power for UNII-3	IEEE 802.11a: 16.01 dBm (0.0399 W) IEEE 802.11n (HT20): 13.36 dBm (0.0217 W) IEEE 802.11n (HT40): 15.18 dBm (0.0330 W) IEEE 802.11ac (VHT20): 13.31 dBm (0.0214 W) IEEE 802.11ac (VHT40): 15.00 dBm (0.0316 W) IEEE 802.11ac (VHT80): 17.04 dBm (0.0505 W)
Products Covered	3 * Adapter: (1) AMIGO / AMS195-1201000FB (2) AMIGO / AMS195-1201000FU (3) AMIGO / AMS195-1201000FV

NOTE:

(1) For a more detailed features description, please refer to the manufacturer's specifications or the user's manual.

(2) Channel List:

UNII-1					
IEEE 802.11a IEEE 802.11n (HT20) IEEE 802.11ac (VHT20)		IEEE 802.11n (HT40) IEEE 802.11ac (VHT40)		IEEE 802.11ac (VHT80)	
Channel	Frequency (MHz)	Channel	Frequency (MHz)	Channel	Frequency (MHz)
36	5180	38	5190	42	5210
40	5200	46	5230		
44	5220				
48	5240				

UNII-3					
IEEE 802.11a IEEE 802.11n (HT20) IEEE 802.11ac (VHT20)		IEEE 802.11n (HT40) IEEE 802.11ac (VHT40)		IEEE 802.11ac (VHT80)	
Channel	Frequency (MHz)	Channel	Frequency (MHz)	Channel	Frequency (MHz)
149	5745	151	5755	155	5775
153	5765	159	5795		
157	5785				
161	5805				
165	5825				

(3) Table for Filed Antenna:

For UNII-1:

Ant.	Brand	Model	Type	Connector	Gain (dBi)
1	RF link	RF21C04436A	Dipole	IPEX	5.32
2	RF link	RF21C04437A	Dipole	IPEX	5.32

For UNII-3:

Ant.	Brand	Model	Type	Connector	Gain (dBi)
1	RF link	RF21C04436A	Dipole	IPEX	5.32
2	RF link	RF21C04437A	Dipole	IPEX	5.32

NOTE:

- (a) The EUT incorporates a MIMO function. Physically, the EUT provides two completed transmitters and receivers (2T2R). 2.4 GHz and 5GHz can't transmit simultaneously.
- (b) For Power Spectral Density(CDD mode):
 Directional Gain = $10\log [(10^{G1/20} + 10^{G2/20} + \dots + 10^{Gn/20})^2/N_{ANT}] = 8.33 \text{ dBi}$.
 For UNII-1:
 The Direction gain exceeds 6 dBi, so the reduced power spectral density limits =
 Limit - (Directional Gain - 6 dBi) = 17 - (8.33 - 6) = 14.67 dBm/MHz.
 . For UNII-3:
 The Direction gain exceeds 6 dBi, so the reduced power spectral density limits =
 Limit - (Directional Gain - 6 dBi) = 30 - (8.33 - 6) = 27.67 dBm/500kHz.
- (c) For Conducted Output Power (CDD mode)
 For $N_{ANT} = 2 < 5$,
 Direction gain = $G_{ANT} + 0 = 5.32 + 0 = 5.32 \text{ dBi}$.
 The Direction gain is less than 6 dBi, so conducted power limits will not be reduced.

Operating Mode / TX Mode	1TX	2TX
IEEE 802.11a	V (ANT 1)	-
IEEE 802.11n (HT20)	-	V (ANT 1+ANT 2)
IEEE 802.11n (HT40)	-	V (ANT 1+ANT 2)
IEEE 802.11ac (VHT20)	-	V (ANT 1+ANT 2)
IEEE 802.11ac (VHT40)	-	V (ANT 1+ANT 2)
IEEE 802.11ac (VHT80)	-	V (ANT 1+ANT 2)

3.2 TEST MODES

The test system was pre-tested based on the consideration of all possible combinations of EUT operation mode.

Following mode(s) as (were) found to be the worst case(s) and selected for the final test.

AC power line conducted emissions test	
Test Mode	Description
4	TX AC (VHT80) MODE

Radiated emissions test for Bandedge	
Test Mode	Description
1	UNII-1_TX A MODE CHANNEL 36/48
2	UNII-1_TX N (HT20) MODE CHANNEL 36/48
3	UNII-1_TX N (HT40) MODE CHANNEL 38/46
4	UNII-1_TX AC (VHT80) MODE CHANNEL 42
5	UNII-3_TX A MODE CHANNEL 149/165
6	UNII-3_TX N (HT20) MODE CHANNEL 149/165
7	UNII-3_TX N (HT40) MODE CHANNEL 151/159
8	UNII-3_TX AC (VHT80) MODE CHANNEL 155

Radiated emissions test for Harmonic	
Test Mode	Description
1	UNII-1_TX A MODE CHANNEL 36/40/48
2	UNII-1_TX N (HT20) MODE CHANNEL 36/40/48
3	UNII-1_TX N (HT40) MODE CHANNEL 38/46
4	UNII-1_TX AC (VHT80) MODE CHANNEL 42
5	UNII-3_TX A MODE CHANNEL 149/157/165
6	UNII-3_TX N (HT20) MODE CHANNEL 149/157/165
7	UNII-3_TX N (HT40) MODE CHANNEL 151/159
8	UNII-3_TX AC (VHT80) MODE CHANNEL 155

Conducted test	
Test Mode	Description
1	UNII-1_TX A MODE CHANNEL 36/40/48
2	UNII-1_TX N (HT20) MODE CHANNEL 36/40/48
3	UNII-1_TX N (HT20) MODE CHANNEL 38/46
4	UNII-1_TX AC (VHT80) MODE CHANNEL 42
5	UNII-3_TX A MODE CHANNEL 149/157/165
6	UNII-3_TX N (HT20) MODE CHANNEL 149/157/165
7	UNII-3_TX N (HT20) MODE CHANNEL 151/159
8	UNII-3_TX AC (VHT80) MODE CHANNEL 155

NOTE:

- (1) The measurements are performed at the low, middle and high available channels.
- (2) For radiated emission tests, the highest output powers were set for final test.
- (3) For radiated emission below 1 GHz test, the IEEE 802.11ac (VHT80) for UNII-3 was found to be the worst case and recorded.

3.3 PARAMETERS OF TEST SOFTWARE

UNII-1			
Test Software	MP_TEST(v1.3.8.0)		
Mode	5180 MHz	5200 MHz	5240 MHz
IEEE 802.11a	108	108	109
IEEE 802.11n (HT20)	108/106	108/105	109/108
IEEE 802.11ac (VHT20)	108/106	108/105	109/108
Mode	5190 MHz	5230 MHz	
IEEE 802.11n (HT40)	84/82	80/76	
IEEE 802.11ac (VHT40)	84/82	80/76	
Mode	5210 MHz		
IEEE 802.11ac (VHT80)	72/72		

UNII-3			
Test Software	MP_TEST(v1.3.8.0)		
Mode	5745 MHz	5785 MHz	5825 MHz
IEEE 802.11a	80	82	82
IEEE 802.11n (HT20)	65/80	58/83	60/83
IEEE 802.11ac (VHT20)	65/80	58/83	60/83
Mode	5755 MHz	5795 MHz	
IEEE 802.11n (HT40)	70/92	72/93	
IEEE 802.11ac (VHT40)	70/92	72/93	
Mode	5775 MHz		
IEEE 802.11ac (VHT80)	85/100		

3.4 DUTY CYCLE

If duty cycle is $\geq 98\%$, duty factor is not required.
 If duty cycle is $< 98\%$, duty factor shall be considered.

<p style="text-align: center;">IEEE 802.11a</p> <p>Date: 5.AUG.2019 16:36:36</p>	<p style="text-align: center;">IEEE 802.11n (HT20)</p> <p>Date: 5.AUG.2019 16:37:41</p>
<p>Duty cycle = 100 % Duty Factor = $10 * \log(1 / 1) = 0$</p>	<p>Duty cycle = 100 % Duty Factor = $10 * \log(1 / 1) = 0$</p>
<p style="text-align: center;">IEEE 802.11n (HT40)</p> <p>Date: 5.AUG.2019 16:39:20</p>	<p style="text-align: center;">IEEE 802.11ac (VHT80)</p> <p>Date: 5.AUG.2019 16:40:38</p>
<p>Duty cycle = 100 % Duty Factor = $10 * \log(1 / 1) = 0$</p>	<p>Duty cycle = 100 % Duty Factor = $10 * \log(1 / 1) = 0$</p>

3.5 BLOCK DIAGRAM SHOWING THE CONFIGURATION OF SYSTEM TESTED

Equipment letters and Cable numbers refer to item numbers described in the tables of clause 3.6.

For conduction test

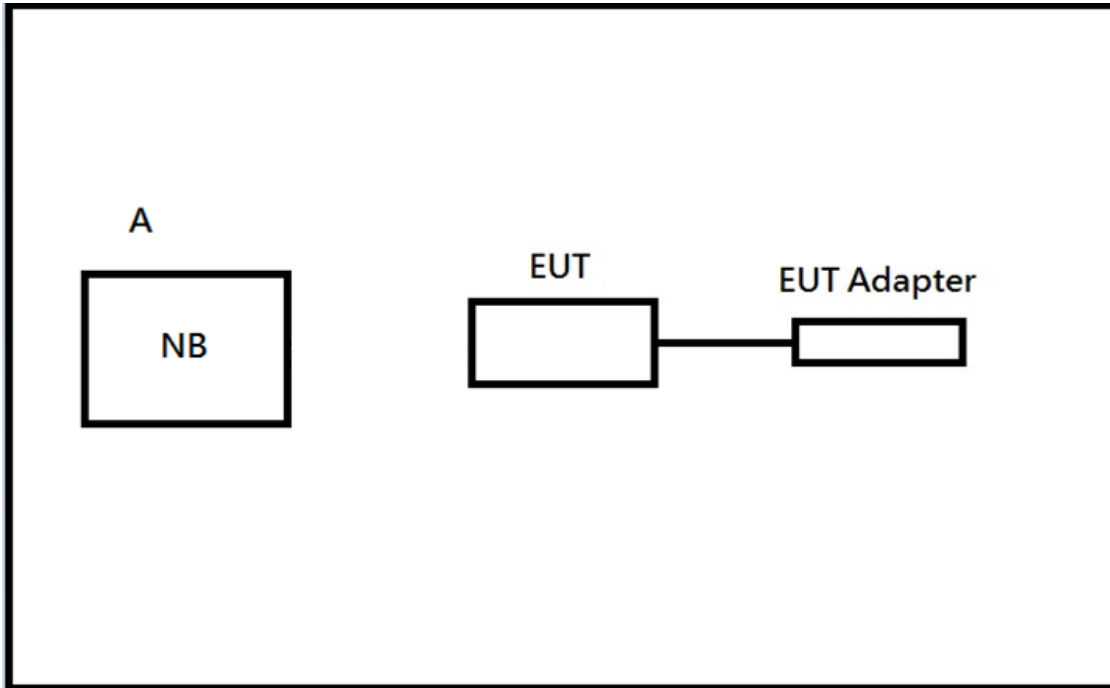

For other test

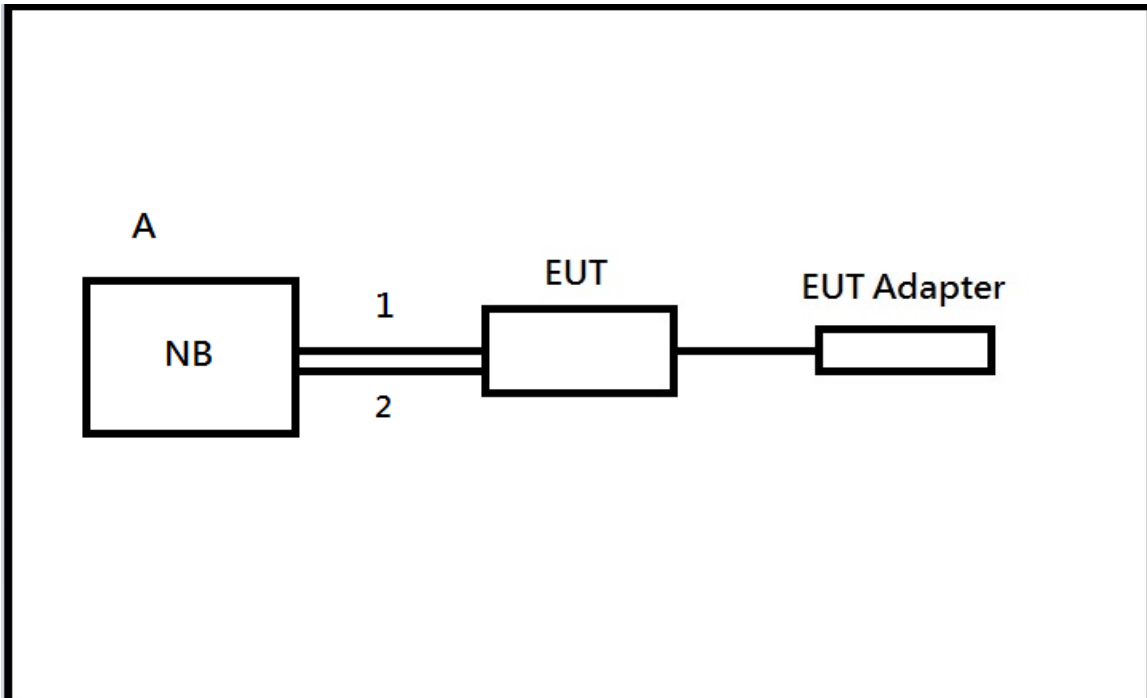

3.6 SUPPORT UNITS

Item	Equipment	Brand	Model No.	Series No.	Remarks
A	NB	HP	TPN-I119	NA	NA

Item	Shielded	Ferrite Core	Length	Cable Type	Remarks
1	NO	NO	0.2m	USB fixture	Furnished at test lab
2	NO	NO	1.5m	LAN	Furnished at test lab

4 AC POWER LINE CONDUCTED EMISSIONS TEST

4.1 LIMIT

Frequency (MHz)	Class A (dB μ V)		Class B (dB μ V)	
	Quasi-peak	Average	Quasi-peak	Average
0.15 - 0.5	79	66	66 - 56 *	56 - 46 *
0.50 - 5.0	73	60	56	46
5.0 - 30.0	73	60	60	50

NOTE:

- (1) The tighter limit applies at the band edges.
- (2) The limit of " * " marked band means the limitation decreases linearly with the logarithm of the frequency in the range.
- (3) The test result calculated as following:
 Measurement Value = Reading Level + Correct Factor
 Correct Factor = Insertion Loss + Cable Loss + Attenuator Factor (if use)
 Margin Level = Measurement Value – Limit Value

The following table is the setting of the receiver.

Receiver Parameter	Setting
Attenuation	10 dB
Start Frequency	0.15 MHz
Stop Frequency	30 MHz
IF Bandwidth	9 KHz

4.2 TEST PROCEDURE

- a. The EUT was placed 0.8 m above the horizontal ground plane with the EUT being connected to the power mains through a line impedance stabilization network (LISN).
 All other support equipment were powered from an additional LISN(s).
 The LISN provides 50 Ohm/50uH of impedance for the measuring instrument.
- b. Interconnecting cables that hang closer than 40 cm to the ground plane shall be folded back and forth in the center forming a bundle to keep the cable above 40 cm.
- c. Excess I/O cables that are not connected to a peripheral shall be bundled in the center.
 The end of the cable will be terminated, using the correct terminating impedance.
 The overall length shall not exceed 1 m.
- d. The LISN is spaced at least 80 cm from the nearest part of the EUT chassis.
- e. For the actual test configuration, please refer to the related Item - EUT Test Photos.

NOTE:

1. In the results, each reading is marked as Peak, QP or AVG per the detector used.
 BW=9 kHz (6 dB Bandwidth)
2. All readings are Peak unless otherwise stated QP or AVG in column of Note. Both the QP and the AVG readings must be less than the limit for compliance.

4.3 DEVIATION FROM TEST STANDARD

No deviation.

4.4 TEST SETUP

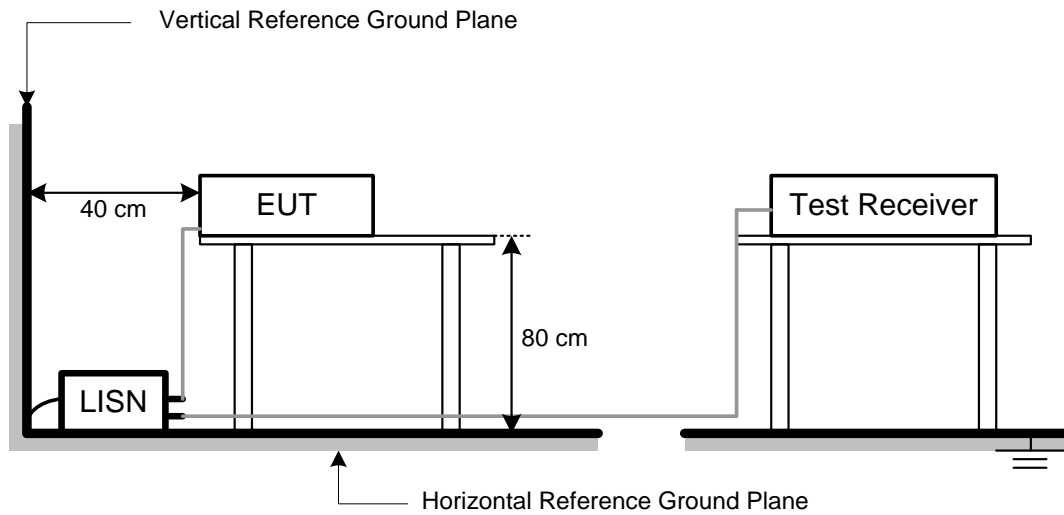

4.5 EUT OPERATING CONDITIONS

The EUT was programmed to be in normal link mode.

4.6 TEST RESULT

Temperature: 25 °C Relative Humidity: 45 % Test Voltage: AC 120V/50Hz

Please refer to the APPENDIX A.

5 RADIATED EMISSIONS TEST

5.1 LIMIT

In case the emission fall within the restricted band specified on 15.205(a), then the 15.209(a) limit in the table below has to be followed.

LIMITS OF RADIATED EMISSIONS MEASUREMENT (9 kHz to 1000 MHz)

Frequency (MHz)	Field Strength (microvolts/meter)	Measurement Distance (meters)
0.009~0.490	2400/F(KHz)	300
0.490~1.705	24000/F(KHz)	30
1.705~30.0	30	30
30~88	100	3
88~216	150	3
216~960	200	3
960~1000	500	3

LIMITS OF UNWANTED EMISSION OUT OF THE RESTRICTED BANDS

Frequency (MHz)	EIRP Limit (dBm)	Equivalent Field Strength at 3m (dBμV/m)
5150-5250	-27	68.3
5250-5350	-27	68.3
5470-5725	-27	68.3
5725-5850	-27 (NOTE 2)	68.3
	10 (NOTE 2)	105.3
	15.6 (NOTE 2)	110.9
	27 (NOTE 2)	122.3

NOTE:

- The following formula is used to convert the equipment isotropic radiated power (eirp) to field strength: $E = \frac{1000000\sqrt{30P}}{3}$ μV/m, where P is the eirp (Watts)
- According to FCC 16-24, All emissions shall be limited to a level of -27 dBm/MHz at 75 MHz or more above or below the band edge increasing linearly to 10 dBm/MHz at 25 MHz above or below the band edge, and from 25 MHz above or below the band edge increasing linearly to a level of 15.6 dBm/MHz at 5 MHz above or below the band edge, and from 5 MHz above or below the band edge increasing linearly to a level of 27 dBm/MHz at the band edge.

5.2 TEST PROCEDURE

- a. The measuring distance of 3 m shall be used for measurements. The EUT was placed on the top of a rotating table 0.8 meter above the ground at a 3 meter semi-anechoic chamber. The table was rotated 360 degrees to determine the position of the highest radiation.(below 1GHz)
- b. The measuring distance of 3 m shall be used for measurements. The EUT was placed on the top of a rotating table 1.5 meter above the ground at a 3 meter semi-anechoic chamber. The table was rotated 360 degrees to determine the position of the highest radiation.(above 1GHz)
- c. The height of the equipment or of the substitution antenna shall be 0.8 m or 1.5 m, the height of the test antenna shall vary between 1 m to 4 m. Both horizontal and vertical polarizations of the antenna are set to make the measurement.
- d. For each suspected emission, the EUT was arranged to its worst case and then the antenna was tuned to heights find the maximum reading (used Bore sight function).
- e. The receiver system was set to peak and average detect function and specified bandwidth with maximum hold mode when the test frequency is above 1GHz.
- f. The initial step in collecting radiated emission data is a receiver peak detector mode pre-scanning the measurement frequency range. Significant peaks are then marked and then Quasi Peak detector mode re-measured.
- g. All readings are Peak unless otherwise stated QP in column of Note. Peak denotes that the Peak reading compliance with the QP Limits and then QP Mode measurement didn't perform. (below 1GHz)
- h. All readings are Peak Mode value unless otherwise stated AVG in column of Note. If the Peak Mode Measured value compliance with the Peak Limits and lower than AVG Limits, the EUT shall be deemed to meet both Peak & AVG Limits and then only Peak Mode was measured, but AVG Mode didn't perform. (above 1GHz)
- i. For the actual test configuration, please refer to the related Item –EUT Test Photos.

5.3 DEVIATION FROM TEST STANDARD

No deviation.

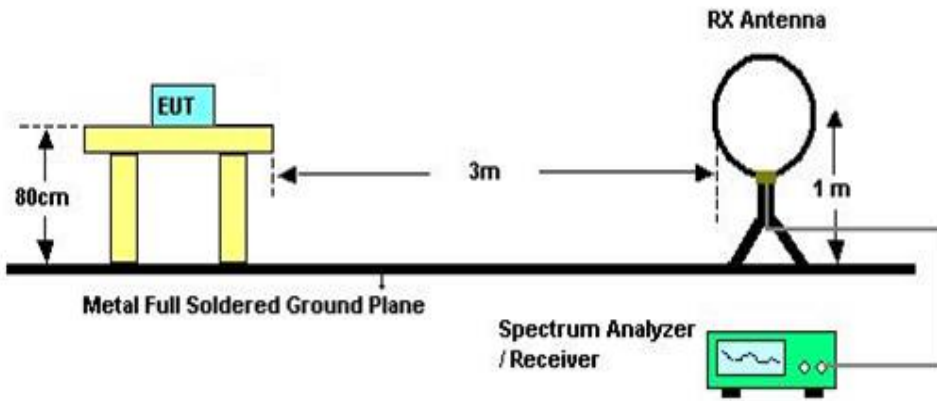
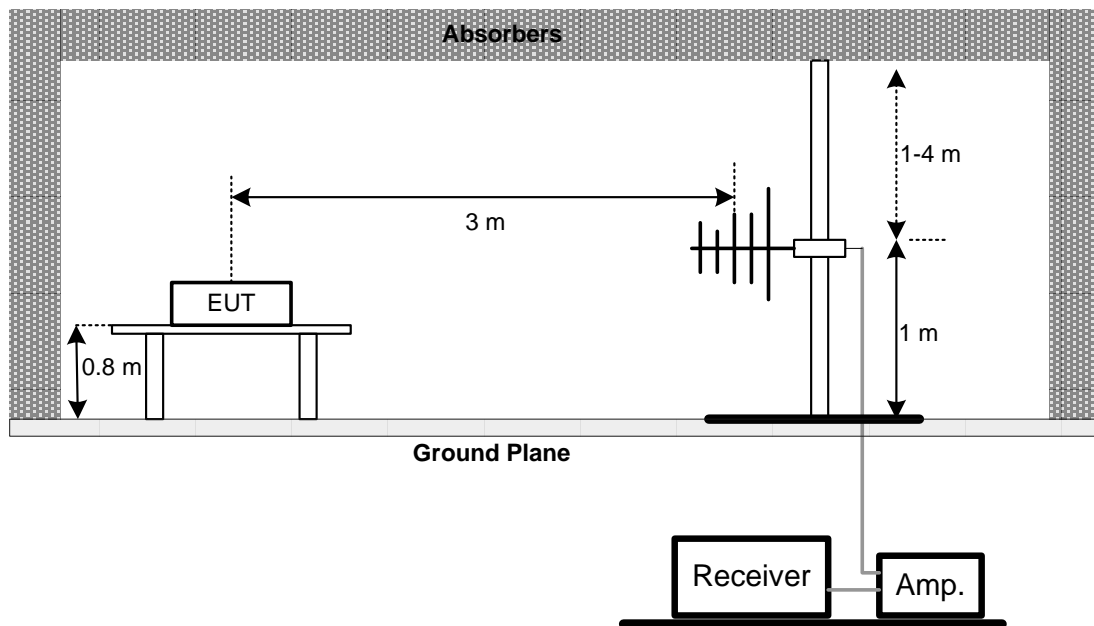
5.4 TEST SETUP**Below 30 MHz****30 MHz to 1 GHz**

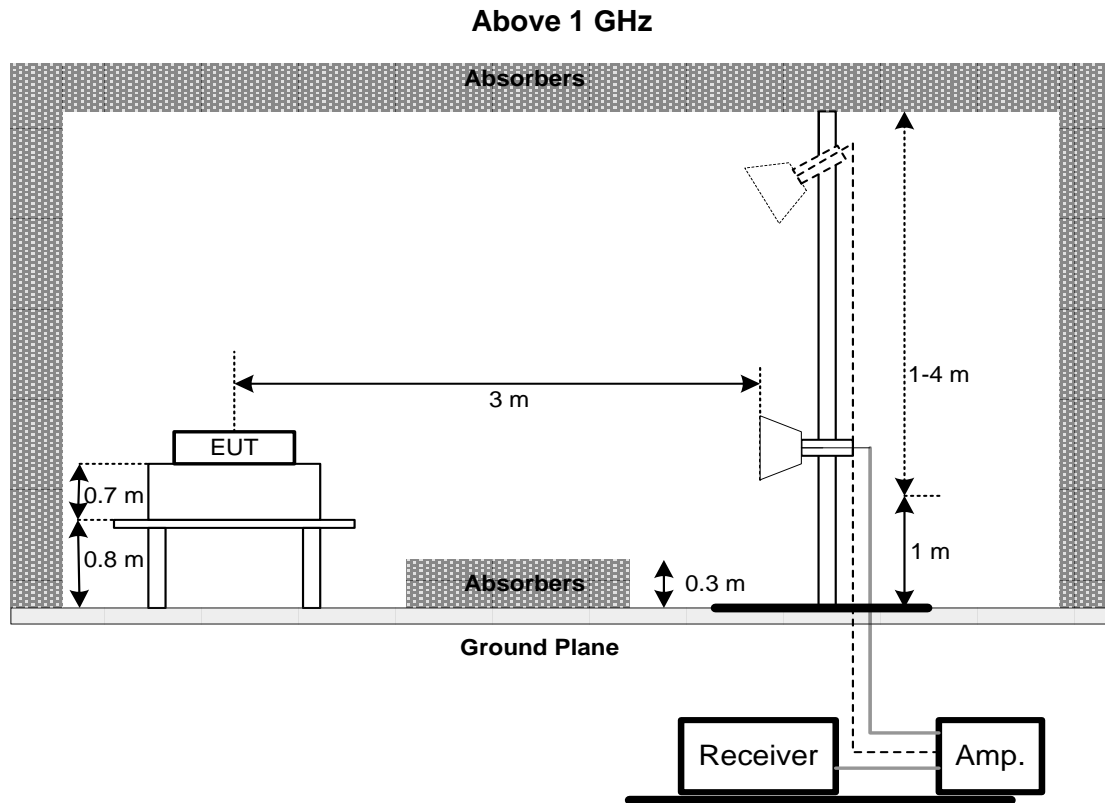

5.5 EUT OPERATING CONDITIONS

The EUT was programmed to be in continuously transmitting mode.

5.6 TEST RESULT – 9 KHZ TO 30 MHZ

Temperature: 23 °C Relative Humidity: 62 % Test Voltage: AC 120V/50Hz

Please refer to the APPENDIX B.

NOTE:

- (1) The amplitude of spurious emissions which are attenuated by more than 20 dB below the permissible value has no need to be reported.
- (2) Distance extrapolation factor = $40 \log (\text{specific distance} / \text{test distance})$ (dB).
- (3) Limit line = specific limits (dBuV) + distance extrapolation factor.

5.7 TEST RESULT – 30MHZ TO 1000 MHZ

Temperature: 23 °C Relative Humidity: 62 % Test Voltage: AC 120V/50Hz

Please refer to the APPENDIX C.

5.8 TEST RESULT – ABOVE 1000 MHZ

Temperature: 23 °C Relative Humidity: 62 % Test Voltage: AC 120V/50Hz

Please refer to the APPENDIX D.

NOTE:

- (1) No limit: This is fundamental signal, the judgment is not applicable.
For fundamental signal judgment was referred to Peak output test.

6 BANDWIDTH TEST

6.1 LIMIT

FCC Part15, Subpart E (15.407)		
Section	Test Item	Frequency Range (MHz)
15.407(a)	26 dB Bandwidth	5150-5250
		5250-5350
		5470-5725
	Minimum 500 kHz 6 dB Bandwidth	5725-5850

6.2 TEST PROCEDURE

- The EUT was directly connected to the spectrum analyzer and antenna output port as show in the block diagram below.
- Spectrum Setting:

Spectrum Parameter	Setting
Attenuation	Auto
Span Frequency	> 26 dB Bandwidth
RBW	300 kHz(Bandwidth 20 MHz) 1 MHz(Bandwidth 40 MHz and 80 MHz)
VBW	1 MHz(Bandwidth 20 MHz) 3 MHz(Bandwidth 40 MHz and 80 MHz)
Detector	Peak
Trace	Max Hold
Sweep Time	Auto

6.3 DEVIATION FROM TEST STANDARD

No deviation.

6.4 TEST SETUP

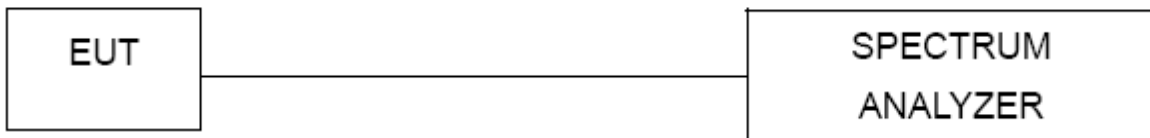

6.5 EUT OPERATING CONDITIONS

The EUT was programmed to be in continuously transmitting mode.

6.6 TEST RESULT

Please refer to the APPENDIX E.

7 PEAK OUTPUT POWER TEST

7.1 LIMIT

FCC Part15, Subpart E (15.407)			
Section	Test Item	Limit	Frequency Range (MHz)
15.407(a)	Maximum Output Power	Fixed:1 Watt (30 dBm) Mobile and portable: 250 mW (24 dBm)	5150-5250
		250 mW (24 dBm)	5250-5350 5470-5725
		1 Watt (30dBm)	5725-5850

Note: The maximum e.i.r.p at any elevation angle above 30 degrees as measured from the horizon must not exceed 125 mW(21 dBm).

7.2 TEST PROCEDURE

- The EUT was directly connected to the power meter and antenna output port as show in the block diagram below.
- Spectrum Setting:

Spectrum Parameter	Setting
Attenuation	Auto
Span Frequency	Encompass the entire emissions bandwidth (EBW) of the signal
RBW	= 1 MHz
VBW	≥ 3 MHz
Detector	RMS
Trace	Max Hold
Sweep Time	auto

- The maximum peak conducted output power was performed in accordance with method of FCC KDB 789033 D02 General UNII Test Procedures New Rules v02r01.

7.3 DEVIATION FROM TEST STANDARD

No deviation.

7.4 TEST SETUP



7.5 EUT OPERATING CONDITIONS

The EUT was programmed to be in continuously transmitting mode.

7.6 TEST RESULT

Please refer to the APPENDIX F.

8 POWER SPECTRAL DENSITY

8.1 LIMIT

FCC Part15, Subpart E (15.407)			
Section	Test Item	Limit	Frequency Range (MHz)
15.407(a)	Power Spectral Density	Other than Mobile and portable: 17 dBm/MHz Mobile and portable: 11 dBm/MHz	5150-5250
		11 dBm/MHz	5250-5350
			5470-5725
		30 dBm/500 kHz	5725-5850

8.2 TEST PROCEDURE

- The EUT was directly connected to the spectrum analyzer and antenna output port as show in the block diagram below.
- Spectrum Setting:

Spectrum Parameter	Setting
Attenuation	Auto
Span Frequency	Encompass the entire emissions bandwidth (EBW) of the signal
RBW	= 1 MHz
VBW	≥ 3 MHz
Detector	RMS
Trace	Max Hold
Sweep Time	Auto

8.3 DEVIATION FROM TEST STANDARD

No deviation.

8.4 TEST SETUP



8.5 EUT OPERATING CONDITIONS

The EUT was programmed to be in continuously transmitting mode.

8.6 TEST RESULT

Please refer to the APPENDIX G.

9 FREQUENCY STABILITY TEST

9.1 LIMIT

FCC Part15, Subpart E (15.407)			
Section	Test Item	Limit	Frequency Range (MHz)
15.407(g)	Frequency Stability	Specified in the user's manual	5150-5250
			5250-5350
			5470-5725
			5725-5850

9.2 TEST PROCEDURE

- The EUT was directly connected to the spectrum analyzer and antenna output port as show in the block diagram below.
- Spectrum Setting:

Spectrum Parameter	Setting
Attenuation	Auto
Span Frequency	Entire absence of modulation emissions bandwidth
RBW	10 kHz
VBW	10 kHz
Sweep Time	Auto

- The test extreme voltage is to change the primary supply voltage from 85 to 115 percent of the nominal value.
- User manual temperature is 0°C~40°C.

9.3 DEVIATION FROM TEST STANDARD

No deviation.

9.4 TEST SETUP

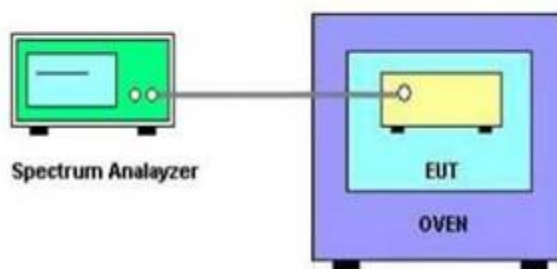

9.5 EUT OPERATING CONDITIONS

The EUT was programmed to be in continuously transmitting mode.

9.6 TEST RESULT

Please refer to the APPENDIX H.

10 LIST OF MEASURING EQUIPMENTS

AC Power Line Conducted Emissions

Item	Kind of Equipment	Manufacturer	Type No.	Serial No.	Calibrated until
1	TWO-LINE V-NETWORK	R&S	ENV216	101050	2020/3/17
2	Test Cable	EMCI	EMCCFD300-BM -BMR-6000	170715	2020/8/5
3	EMI Test Receiver	R&S	ESR7	101433	2019/12/4
4	Measurement Software	EZ	EZ EMC (Version NB-03A)	N/A	N/A

Radiated Emissions

Item	Kind of Equipment	Manufacturer	Type No.	Serial No.	Calibrated until
1	Preamplifier	EMCI	EMC001340	980555	2020/4/11
2	Preamplifier	EMCI	EMC02325B	980217	2020/4/11
3	Preamplifier	EMCI	EMC012645B	980267	2020/4/11
4	Preamplifier	EMCI	EMC2654045	980030	2020/2/1
5	Test Cable	EMCI	EMC104-SM-SM-800	150207	2020/4/11
6	Test Cable	EMCI	EMC104-SM-SM-3000	151205	2020/4/11
7	Test Cable	EMCI	EMC-SM-SM-7000	180408	2020/4/11
8	MXE EMI Receiver	Agilent	N9038A	MY55420127	2020/3/25
9	Signal Analyzer	Agilent	N9010A	MY56480554	2020/6/5
10	Loop Ant	EMCO	EMCI-LPA600	274	2020/5/30
11	Horn Ant	SCHWARZBECK	BBHA 9120D	9120D-1342	2020/6/9
12	Horn Ant	Schwarzbeck	BBHA 9170	187	2019/12/21
13	Trilog-Broadband Antenna	Schwarzbeck	VULB 9168	000992	2020/5/28
14	5dB Attenuator	EMCI	EMCI-N-6-05	AT-N0508	2020/5/28

26 dB Bandwidth

Item	Kind of Equipment	Manufacturer	Type No.	Serial No.	Calibrated until
1	Spectrum Analyzer	R&S	FSP40	100129	2020/5/22

Peak Output Power

Item	Kind of Equipment	Manufacturer	Type No.	Serial No.	Calibrated until
1	Power Meter	Anritsu	ML2495A	1128008	2019/12/5
2	Power Sensor	Anritsu	MA2411B	1126001	2019/12/5

Power Spectral Density

Item	Kind of Equipment	Manufacturer	Type No.	Serial No.	Calibrated until
1	Spectrum Analyzer	R&S	FSP40	100129	2020/5/22

Frequency Stability

Item	Kind of Equipment	Manufacturer	Type No.	Serial No.	Calibrated until
1	Spectrum Analyzer	R&S	FSP40	100129	2020/5/22

Remark: "N/A" denotes no model name, no serial no. or no calibration specified.
All calibration period of equipment list is one year.

APPENDIX A AC POWER LINE CONDUCTED EMISSIONS**CONTINUE ON NEXT PAGE**

Test Mode	TX AC (VHT80) MODE	Phase	Line
-----------	--------------------	-------	------

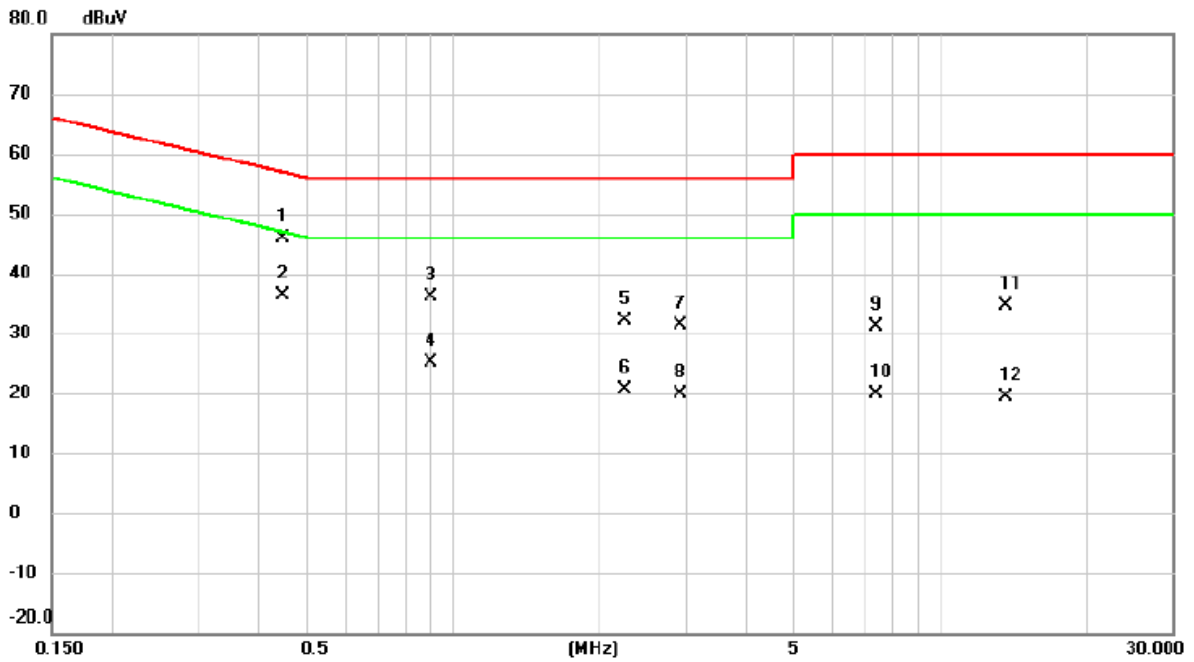

No.	Mk.	Freq.	Reading	Correct	Measure-	Limit	Margin	Detector	Comment
		MHz	Level	Factor	ment				
			dBuV	dB	dBuV	dBuV	dB		
1		0.4470	36.25	9.63	45.88	56.93	-11.05	QP	
2	*	0.4470	26.65	9.63	36.28	46.93	-10.65	AVG	
3		0.9014	26.50	9.65	36.15	56.00	-19.85	QP	
4		0.9014	15.48	9.65	25.13	46.00	-20.87	AVG	
5		2.2582	22.51	9.72	32.23	56.00	-23.77	QP	
6		2.2582	10.89	9.72	20.61	46.00	-25.39	AVG	
7		2.9355	21.52	9.75	31.27	56.00	-24.73	QP	
8		2.9355	10.22	9.75	19.97	46.00	-26.03	AVG	
9		7.3882	21.37	9.85	31.22	60.00	-28.78	QP	
10		7.3882	10.08	9.85	19.93	50.00	-30.07	AVG	
11		13.6297	24.69	9.94	34.63	60.00	-25.37	QP	
12		13.6297	9.38	9.94	19.32	50.00	-30.68	AVG	

Test Mode	TX AC (VHT80) MODE	Phase	Neutral
-----------	--------------------	-------	---------

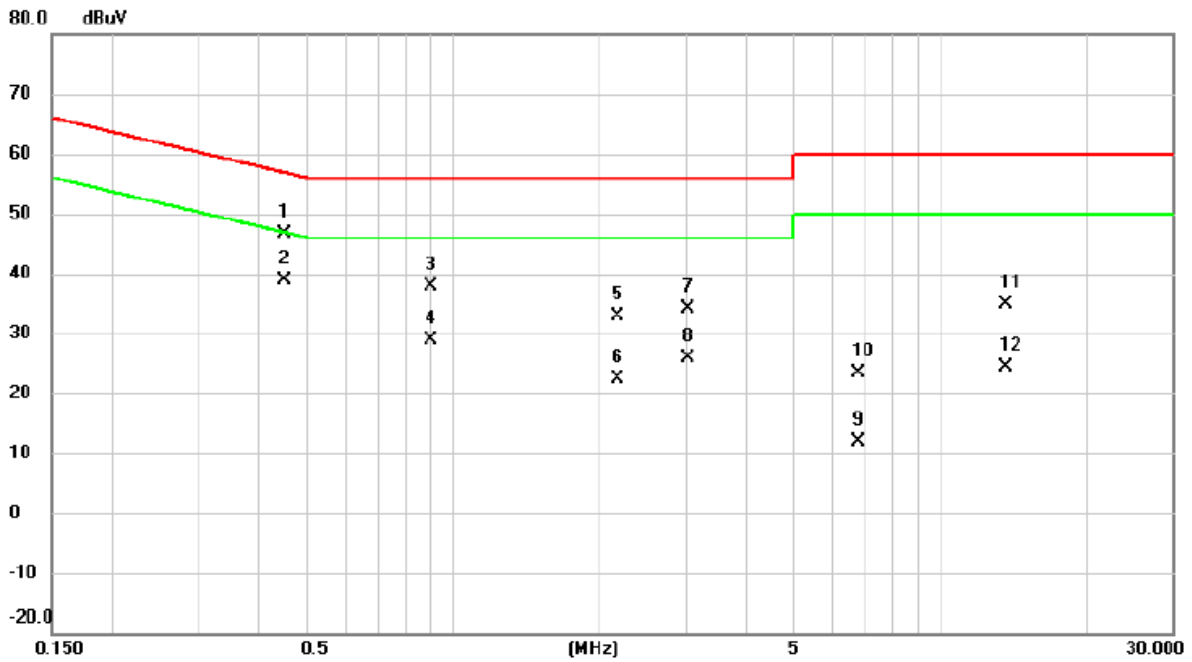

No.	Mk.	Freq. MHz	Reading Level dBuV	Correct Factor dB	Measure- ment dBuV	Limit dBuV	Margin dB	Detector	Comment
1		0.4515	37.05	9.58	46.63	56.85	-10.22	QP	
2	*	0.4515	29.18	9.58	38.76	46.85	-8.09	AVG	
3		0.9015	28.39	9.61	38.00	56.00	-18.00	QP	
4		0.9015	19.21	9.61	28.82	46.00	-17.18	AVG	
5		2.1773	23.26	9.68	32.94	56.00	-23.06	QP	
6		2.1773	12.77	9.68	22.45	46.00	-23.55	AVG	
7		3.0323	24.43	9.72	34.15	56.00	-21.85	QP	
8		3.0323	16.21	9.72	25.93	46.00	-20.07	AVG	
9		6.7628	2.17	9.79	11.96	60.00	-48.04	QP	
10		6.7628	13.61	9.79	23.40	50.00	-26.60	AVG	
11		13.6680	24.98	9.87	34.85	60.00	-25.15	QP	
12		13.6680	14.42	9.87	24.29	50.00	-25.71	AVG	

APPENDIX B RADIATED EMISSIONS - 9 KHZ TO 30 MHZ**CONTINUE ON NEXT PAGE**

Test Mode	UNII-3_TX AC (VHT80) MODE 5775 MHz	Azimuth Angle	90°
-----------	------------------------------------	---------------	-----

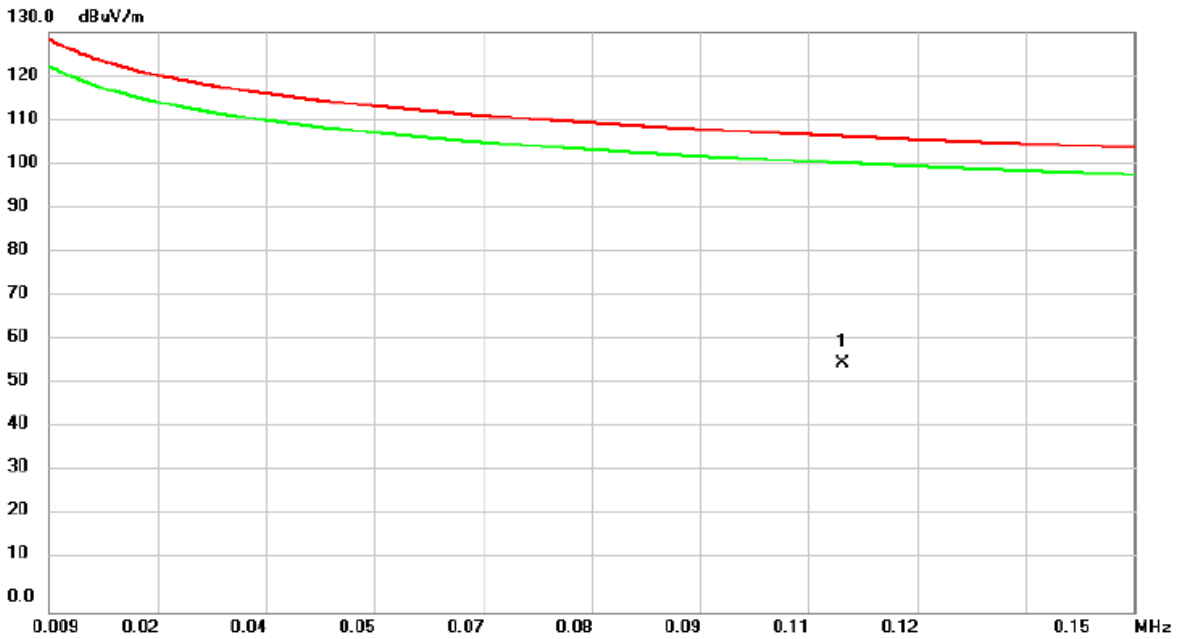

No.	Mk.	Freq.	Reading Level	Correct Factor	Measurement	Limit	Over	Detector	Comment
		MHz	dBuV	dB	dBuV/m	dBuV/m	dB		
1	*	0.1121	40.30	15.34	55.64	106.61	-50.97	AVG	

Test Mode	UNII-3_TX AC (VHT80) MODE 5775 MHz	Azimuth Angle	90°
-----------	------------------------------------	---------------	-----

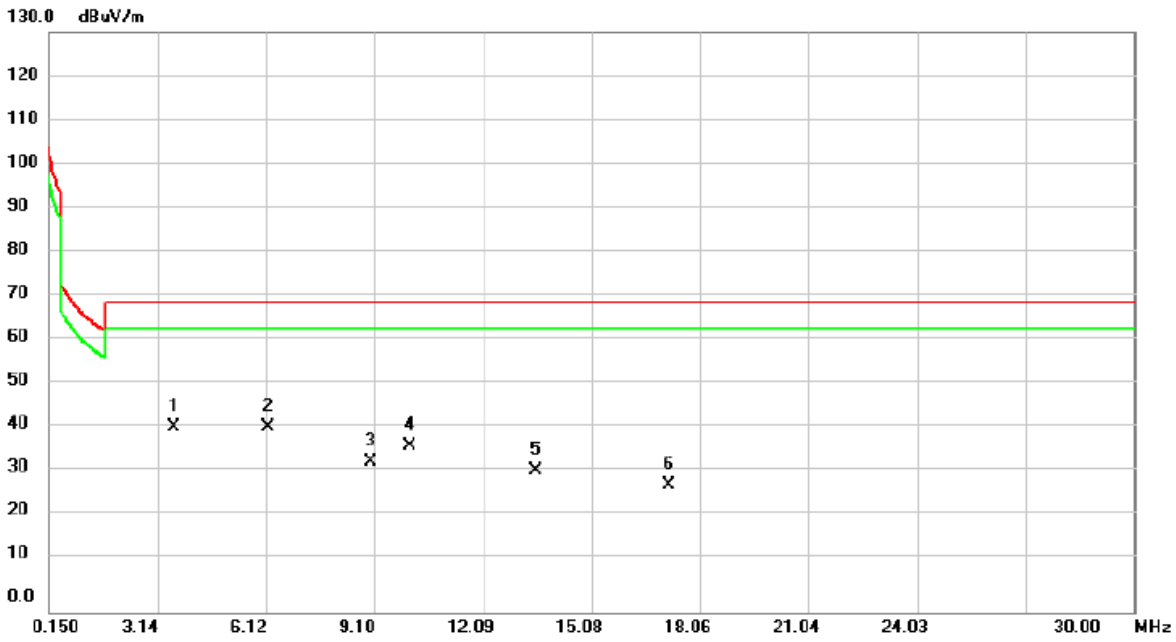

No.	Mk.	Freq.	Reading Level	Correct Factor	Measurement	Limit	Over	Detector	Comment
		MHz	dBuV	dB	dBuV/m	dBuV/m	dB		
1		3.5827	44.89	-3.57	41.32	69.54	-28.22	QP	
2	*	6.1797	45.24	-3.85	41.39	69.54	-28.15	QP	
3		8.9856	38.05	-4.51	33.54	69.54	-36.00	QP	
4		10.0900	41.67	-4.51	37.16	69.54	-32.38	QP	
5		13.5526	36.40	-4.59	31.81	69.54	-37.73	QP	
6		17.1944	34.11	-5.66	28.45	69.54	-41.09	QP	

Test Mode	UNII-3_TX AC (VHT80) MODE 5775 MHz	Azimuth Angle	0°
-----------	------------------------------------	---------------	----

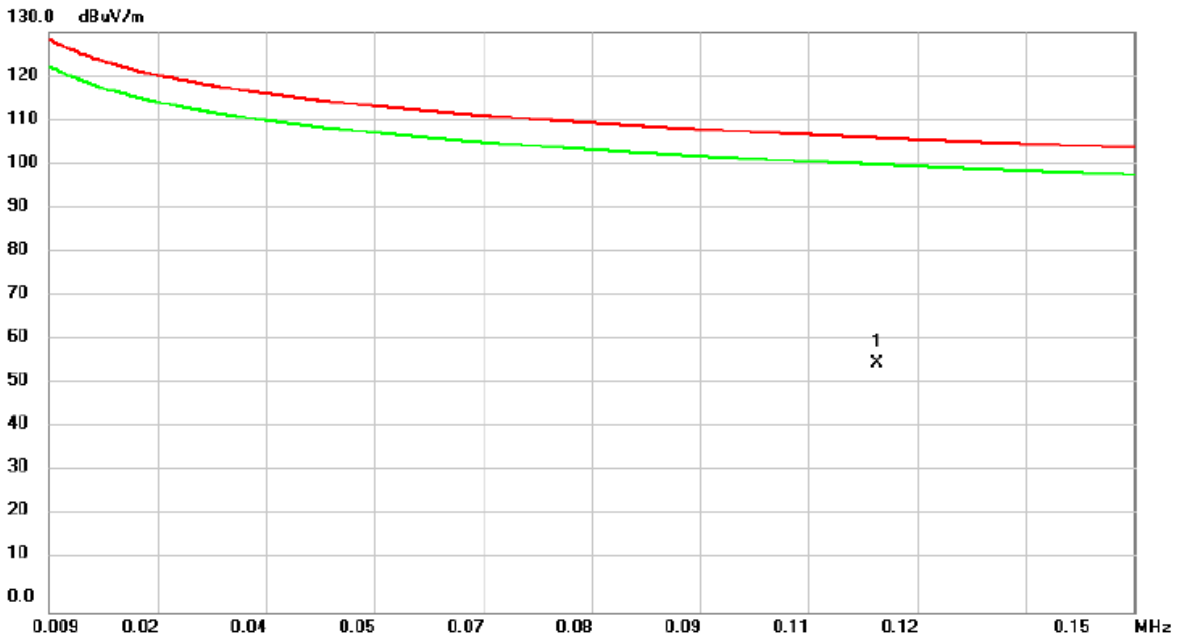

No.	Mk.	Freq.	Reading Level	Correct Factor	Measurement	Limit	Over	Detector	Comment
		MHz	dBuV	dB	dBuV/m	dBuV/m	dB		
1	*	0.1166	40.67	15.09	55.76	106.27	-50.51	AVG	

Test Mode	UNII-3_TX AC (VHT80) MODE 5775 MHz	Azimuth Angle	0°
-----------	------------------------------------	---------------	----

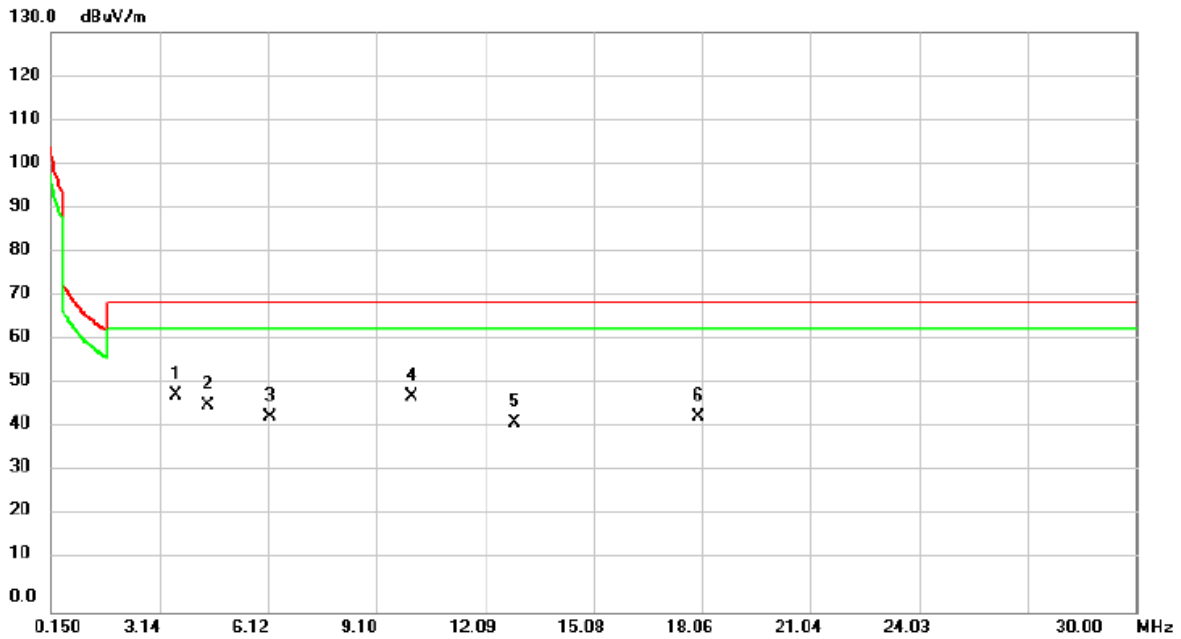

No.	Mk.	Freq.	Reading Level	Correct Factor	Measurement	Limit	Over	Detector	Comment
		MHz	dBuV	dB	dBuV/m	dBuV/m	dB		
1	*	3.5826	52.10	-3.57	48.53	69.54	-21.01	QP	
2		4.4782	49.90	-3.68	46.22	69.54	-23.32	QP	
3		6.1797	47.69	-3.85	43.84	69.54	-25.70	QP	
4		10.0900	52.89	-4.51	48.38	69.54	-21.16	QP	
5		12.8958	47.00	-4.59	42.41	69.54	-27.13	QP	
6		17.9704	49.76	-5.97	43.79	69.54	-25.75	QP	

APPENDIX C RADIATED EMISSIONS - 30 MHZ TO 1000 MHZ**CONTINUE ON NEXT PAGE**

Test Mode	UNII-3_TX AC (VHT80) MODE 5775 MHz	Polarization	Vertical
-----------	------------------------------------	--------------	----------

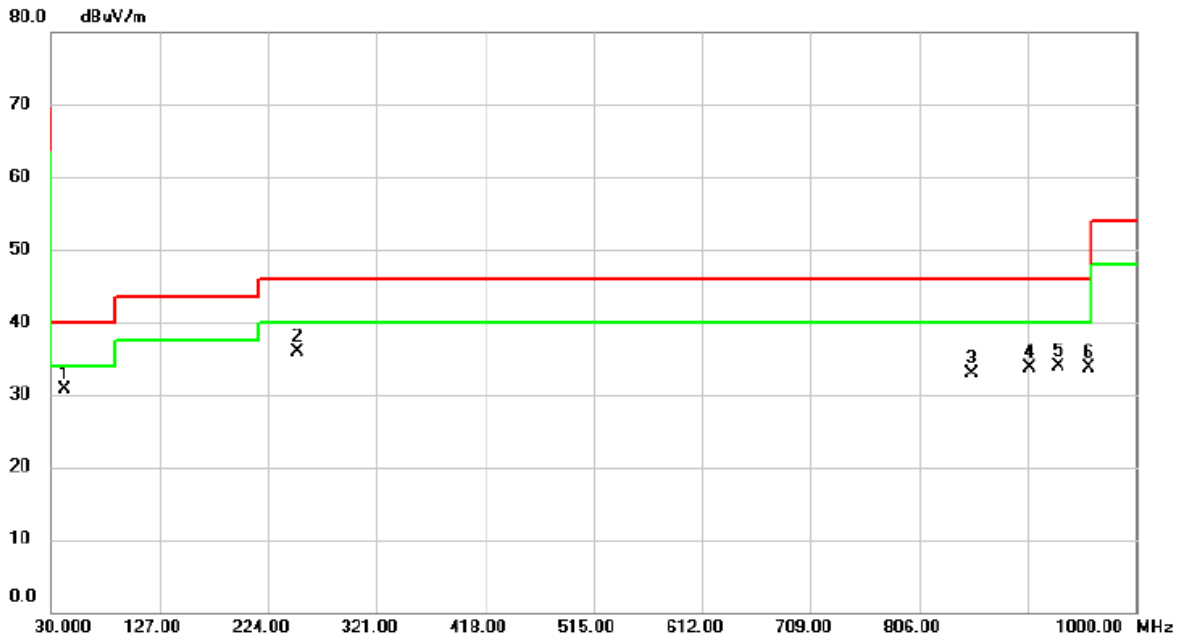

No.	Mk.	Freq. MHz	Reading Level dBuV	Correct Factor dB	Measure- ment dBuV/m	Limit dBuV/m	Over dB	Detector	Comment
1	*	42.6100	39.20	-8.45	30.75	40.00	-9.25	peak	
2		250.1900	44.72	-8.80	35.92	46.00	-10.08	peak	
3		852.5600	29.25	3.75	33.00	46.00	-13.00	peak	
4		904.9400	29.16	4.51	33.67	46.00	-12.33	peak	
5		931.1300	28.98	4.87	33.85	46.00	-12.15	peak	
6		957.3200	28.52	5.25	33.77	46.00	-12.23	peak	

Test Mode	UNII-3_TX AC (VHT80) MODE 5775 MHz	Polarization	Horizontal
-----------	------------------------------------	--------------	------------

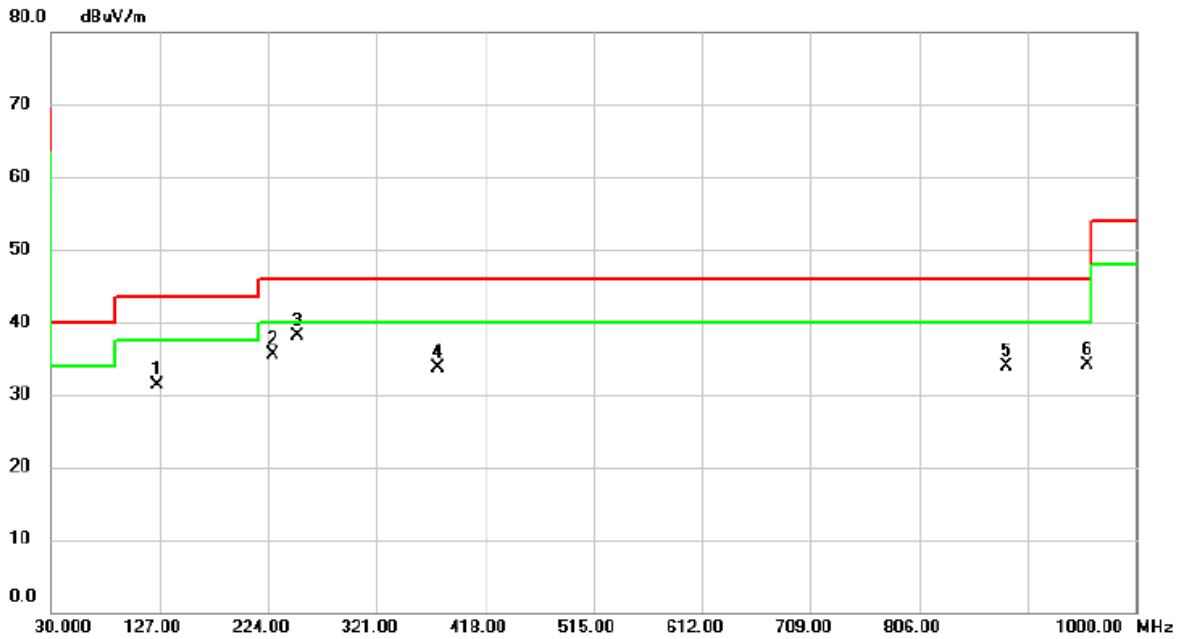

No.	Mk.	Freq. MHz	Reading Level dBuV	Correct Factor dB	Measure- ment dBuV/m	Limit dBuV/m	Over dB	Detector	Comment
1		125.0600	42.07	-10.72	31.35	43.50	-12.15	peak	
2		227.8800	45.24	-9.78	35.46	46.00	-10.54	peak	
3	*	250.1900	46.95	-8.80	38.15	46.00	-7.85	peak	
4		375.3200	38.97	-5.31	33.66	46.00	-12.34	peak	
5		883.6000	29.72	4.21	33.93	46.00	-12.07	peak	
6		956.3500	28.90	5.24	34.14	46.00	-11.86	peak	

APPENDIX D RADIATED EMISSIONS - ABOVE 1000 MHZ**CONTINUE ON NEXT PAGE**

Test Mode	UNII-1_TX A Mode 5180MHz	Polarization	Vertical
-----------	--------------------------	--------------	----------

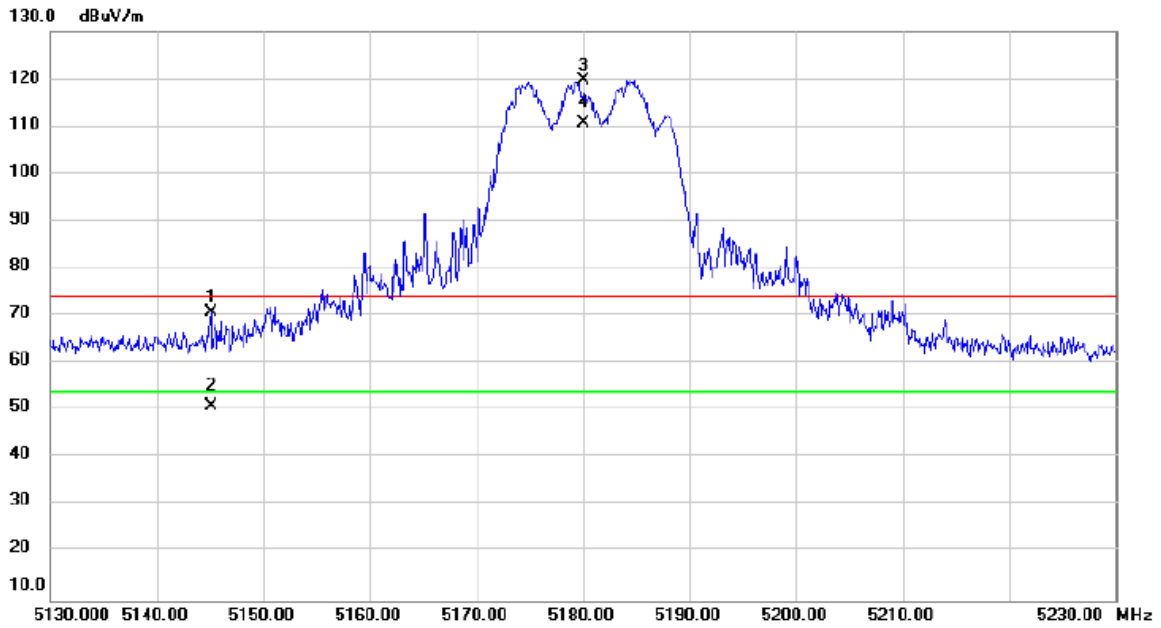

No.	Mk.	Freq. MHz	Reading Level dBuV	Correct Factor dB	Measure- ment dBuV/m	Limit dBuV/m	Over dB	Detector	Comment
1		5145.100	33.26	37.61	70.87	74.00	-3.13	peak	
2		5145.100	13.32	37.61	50.93	54.00	-3.07	AVG	
3	X	5180.000	82.12	37.65	119.77	74.00	45.77	peak	No Limit
4	*	5180.000	72.95	37.65	110.60	54.00	56.60	AVG	No Limit

Test Mode	UNII-1_TX A Mode 5240MHz	Polarization	Vertical
-----------	--------------------------	--------------	----------

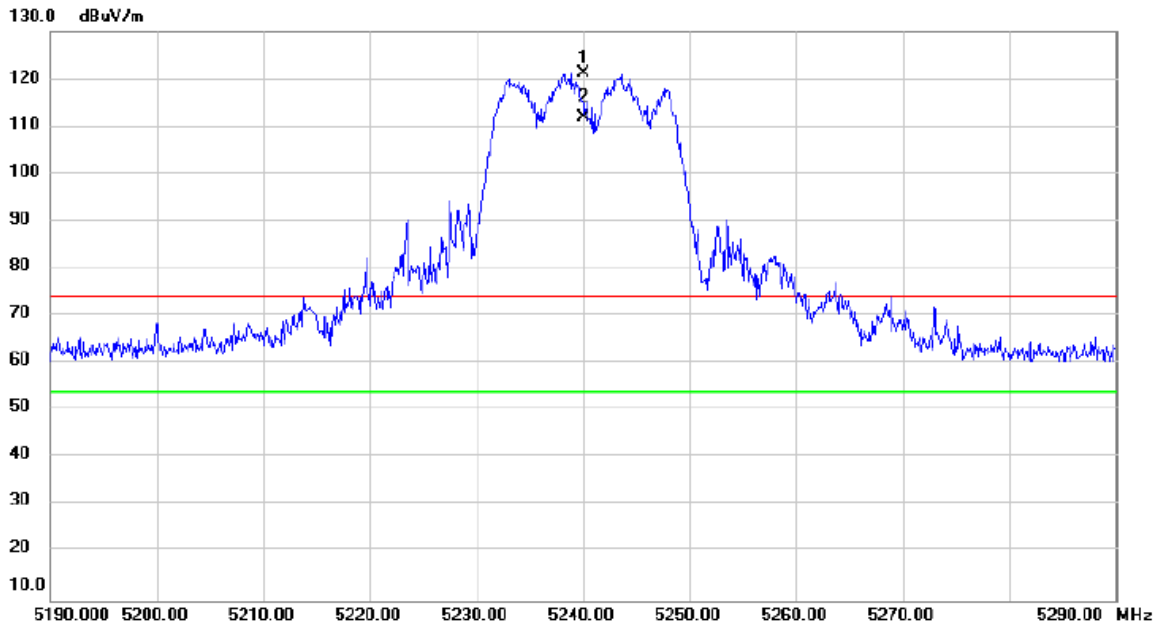

No.	Mk.	Freq.	Reading Level	Correct Factor	Measurement	Limit	Over	Detector	Comment
		MHz	dBuV	dB	dBuV/m	dBuV/m	dB		
1	X	5240.000	83.36	37.71	121.07	74.00	47.07	peak	No Limit
2	*	5240.000	74.14	37.71	111.85	54.00	57.85	AVG	No Limit

Test Mode	UNII-1_TX N (HT20) Mode 5180MHz	Polarization	Vertical
-----------	---------------------------------	--------------	----------

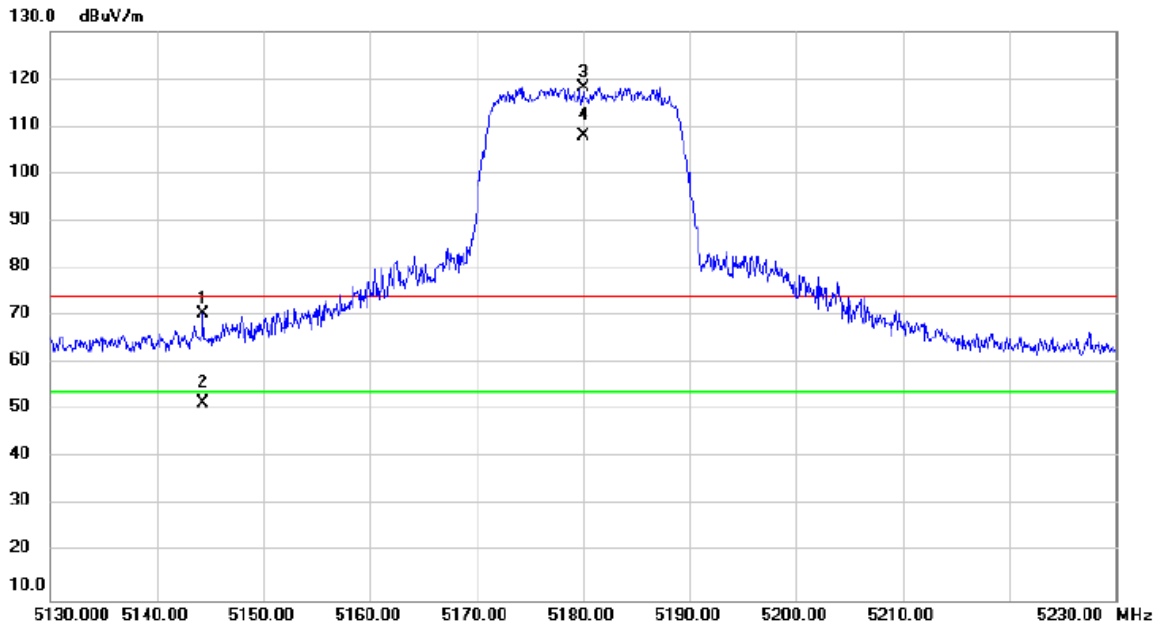

No.	Mk.	Freq. MHz	Reading Level dBuV	Correct Factor dB	Measure- ment dBuV/m	Limit dBuV/m	Over dB	Detector	Comment
1		5144.400	32.93	37.61	70.54	74.00	-3.46	peak	
2		5144.400	13.86	37.61	51.47	54.00	-2.53	AVG	
3	X	5180.000	80.52	37.65	118.17	74.00	44.17	peak	No Limit
4	*	5180.000	70.26	37.65	107.91	54.00	53.91	AVG	No Limit

Test Mode	UNII-1_TX N (HT20) Mode 5240MHz	Polarization	Vertical
-----------	---------------------------------	--------------	----------

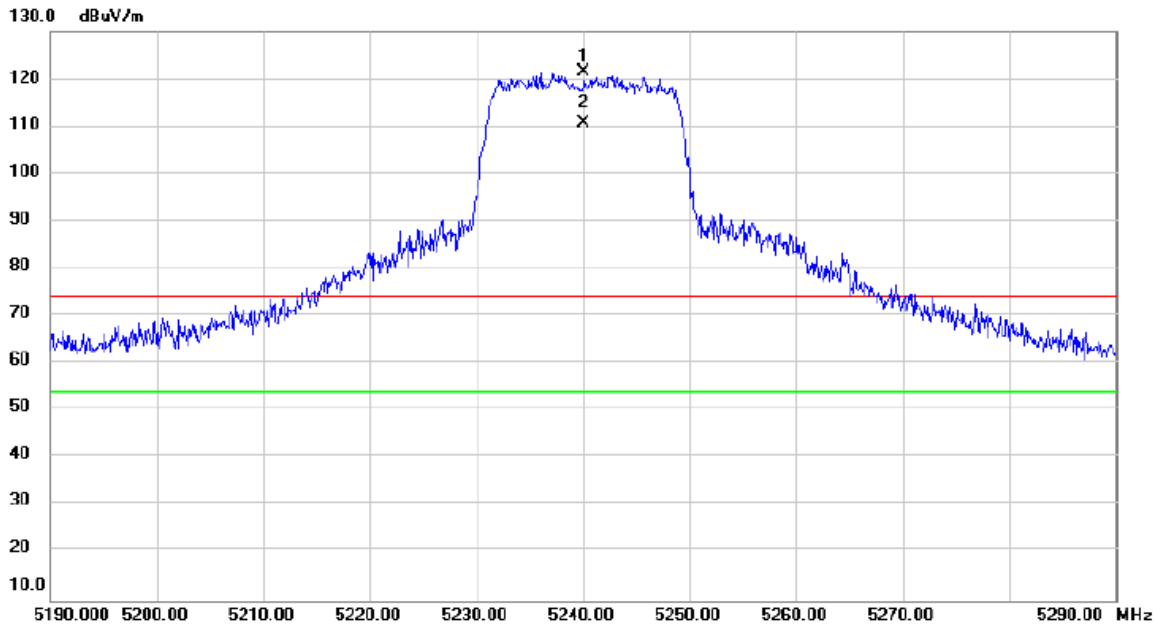

No.	Mk.	Freq. MHz	Reading Level dBuV	Correct Factor dB	Measure- ment dBuV/m	Limit dBuV/m	Over dB	Detector	Comment
1	X	5240.000	83.80	37.71	121.51	74.00	47.51	peak	No Limit
2	*	5240.000	72.94	37.71	110.65	54.00	56.65	AVG	No Limit

Test Mode	UNII-1_TX N (HT40) Mode 5190MHz	Polarization	Vertical
-----------	---------------------------------	--------------	----------

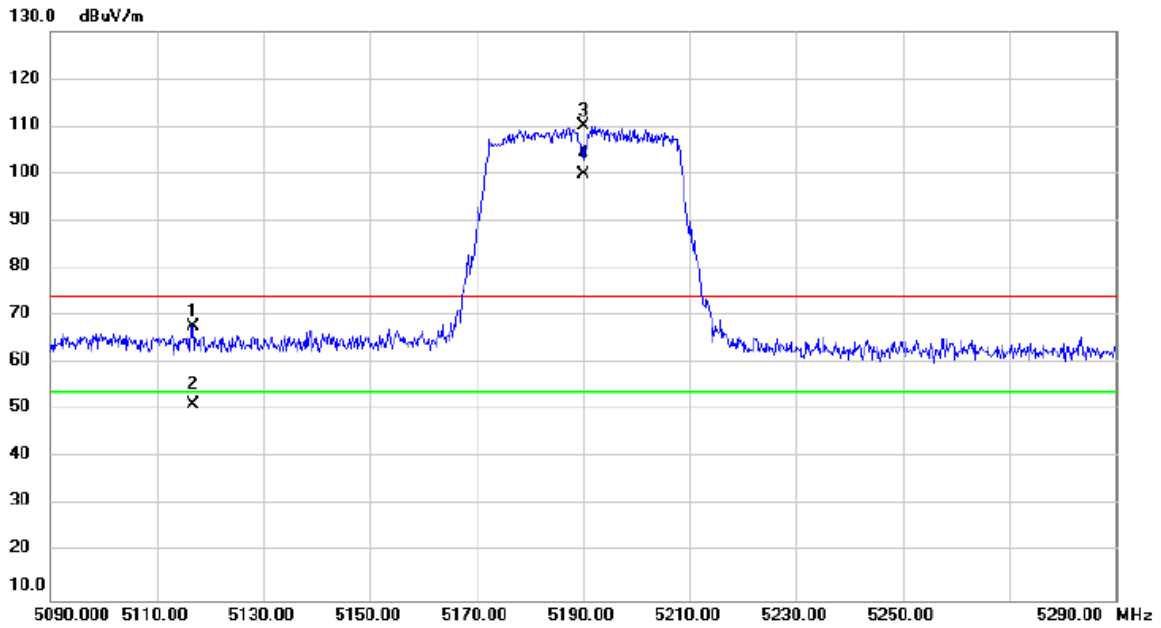

No.	Mk.	Freq. MHz	Reading Level dBuV	Correct Factor dB	Measure- ment dBuV/m	Limit dBuV/m	Over dB	Detector	Comment
1		5116.800	30.26	37.57	67.83	74.00	-6.17	peak	
2		5116.800	13.61	37.57	51.18	54.00	-2.82	AVG	
3	X	5190.000	72.51	37.65	110.16	74.00	36.16	peak	No Limit
4	*	5190.000	62.17	37.65	99.82	54.00	45.82	AVG	No Limit

Test Mode	UNII-1_TX N (HT40) Mode 5230MHz	Polarization	Vertical
-----------	---------------------------------	--------------	----------

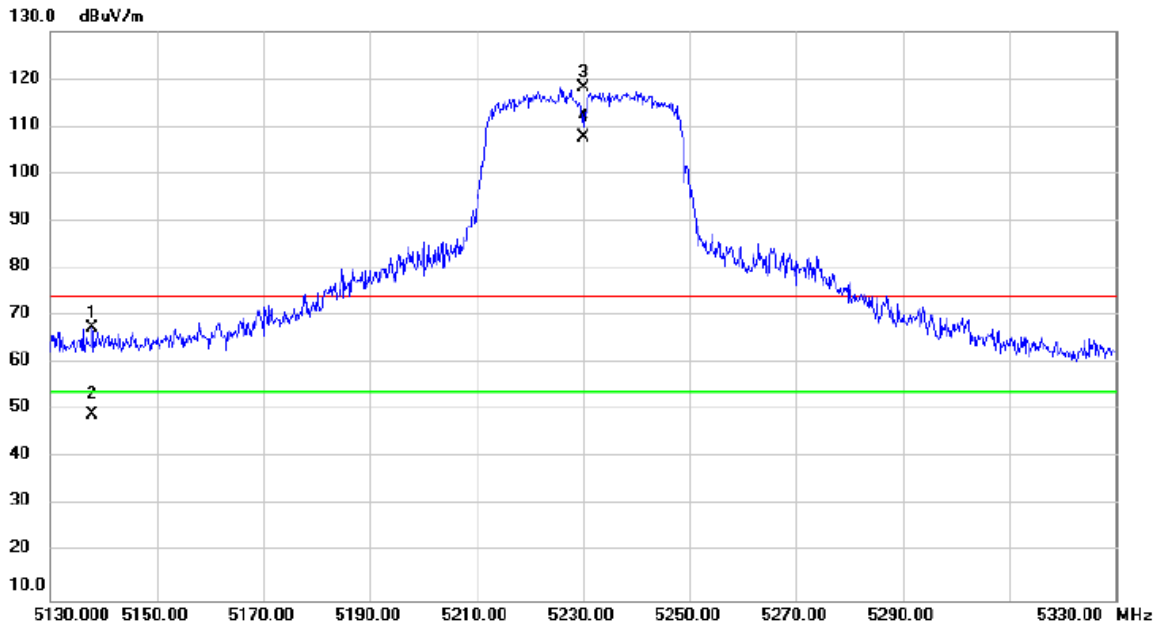

No.	Mk.	Freq. MHz	Reading Level dBuV	Correct Factor dB	Measure- ment dBuV/m	Limit dBuV/m	Over dB	Detector	Comment
1		5137.800	29.77	37.59	67.36	74.00	-6.64	peak	
2		5137.800	11.68	37.59	49.27	54.00	-4.73	AVG	
3	X	5230.000	80.36	37.70	118.06	74.00	44.06	peak	No Limit
4	*	5230.000	70.06	37.70	107.76	54.00	53.76	AVG	No Limit

Test Mode	UNII-1_TX AC (VHT80) Mode 5210MHz	Polarization	Vertical
-----------	-----------------------------------	--------------	----------

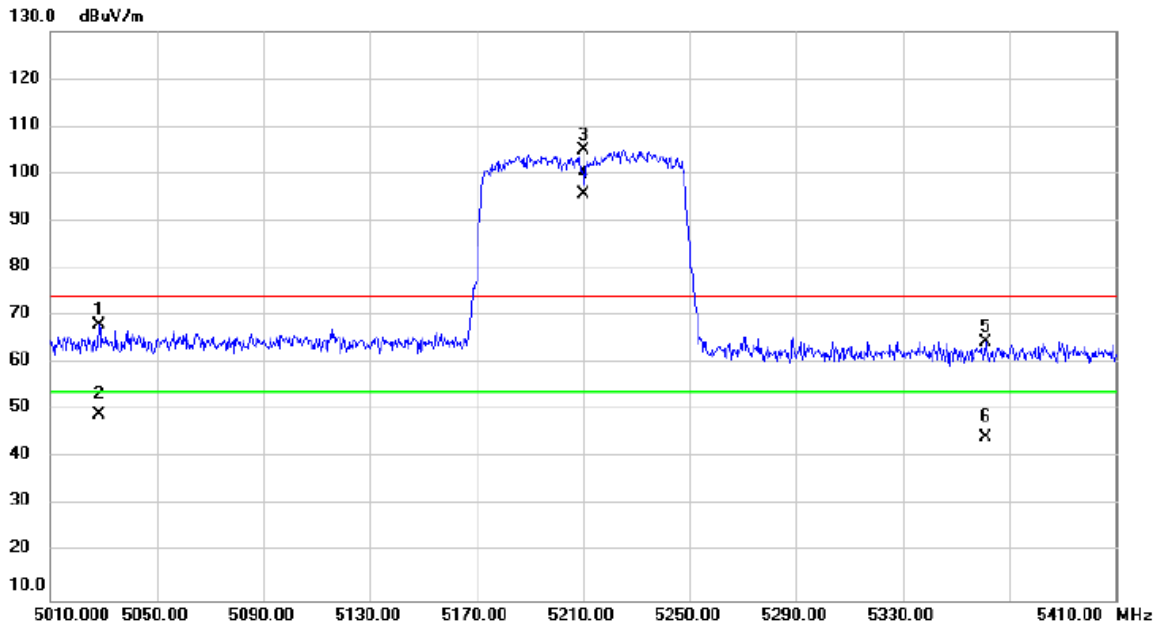

No.	Mk.	Freq. MHz	Reading Level dBuV	Correct Factor dB	Measure- ment dBuV/m	Limit dBuV/m	Over dB	Detector	Comment
1		5028.400	30.60	37.48	68.08	74.00	-5.92	peak	
2		5028.400	11.82	37.48	49.30	54.00	-4.70	AVG	
3	X	5210.000	67.23	37.68	104.91	74.00	30.91	peak	No Limit
4	*	5210.000	58.07	37.68	95.75	54.00	41.75	AVG	No Limit
5		5361.200	26.68	37.86	64.54	74.00	-9.46	peak	
6		5361.200	6.38	37.86	44.24	54.00	-9.76	AVG	

Test Mode	UNII-3_TX A Mode 5745MHz	Polarization	Vertical
-----------	--------------------------	--------------	----------

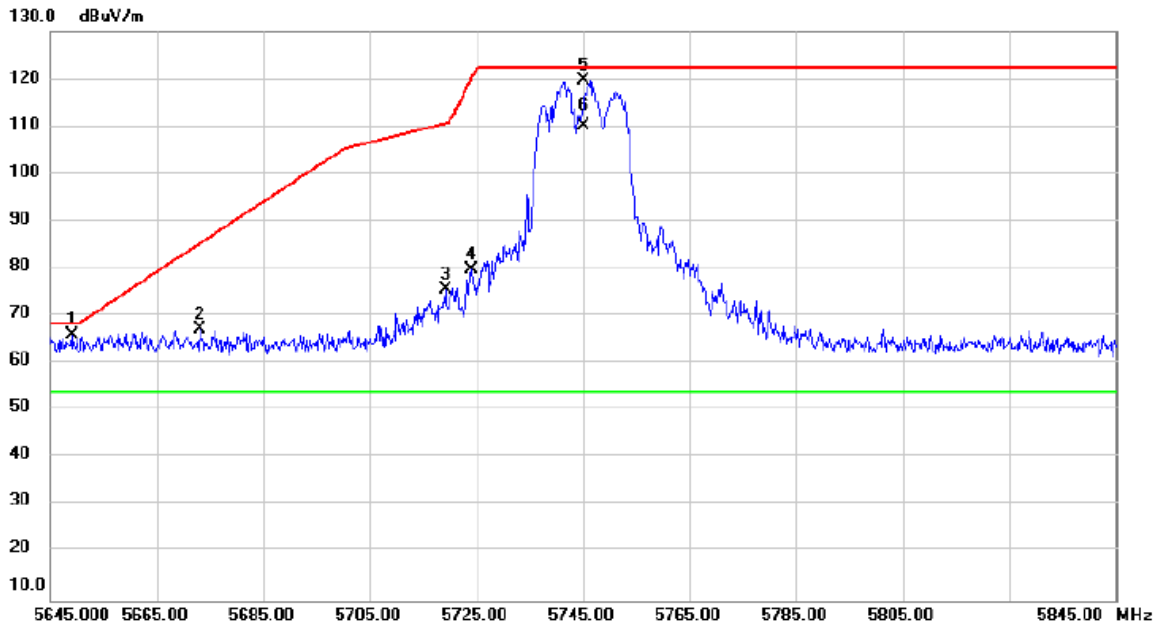

No.	Mk.	Freq. MHz	Reading Level dBuV	Correct Factor dB	Measure- ment dBuV/m	Limit dBuV/m	Over dB	Detector	Comment
1		5649.000	27.71	38.22	65.93	68.20	-2.27	peak	
2		5673.000	28.80	38.25	67.05	85.26	-18.21	peak	
3		5719.200	37.13	38.32	75.45	110.58	-35.13	peak	
4		5724.200	41.39	38.32	79.71	120.38	-40.67	peak	
5		5745.000	81.31	38.35	119.66	122.20	-2.54	peak	No Limit
6	*	5745.000	71.67	38.35	110.02	54.00	56.02	AVG	No Limit

Test Mode	UNII-3_TX A Mode 5825MHz	Polarization	Vertical
-----------	--------------------------	--------------	----------

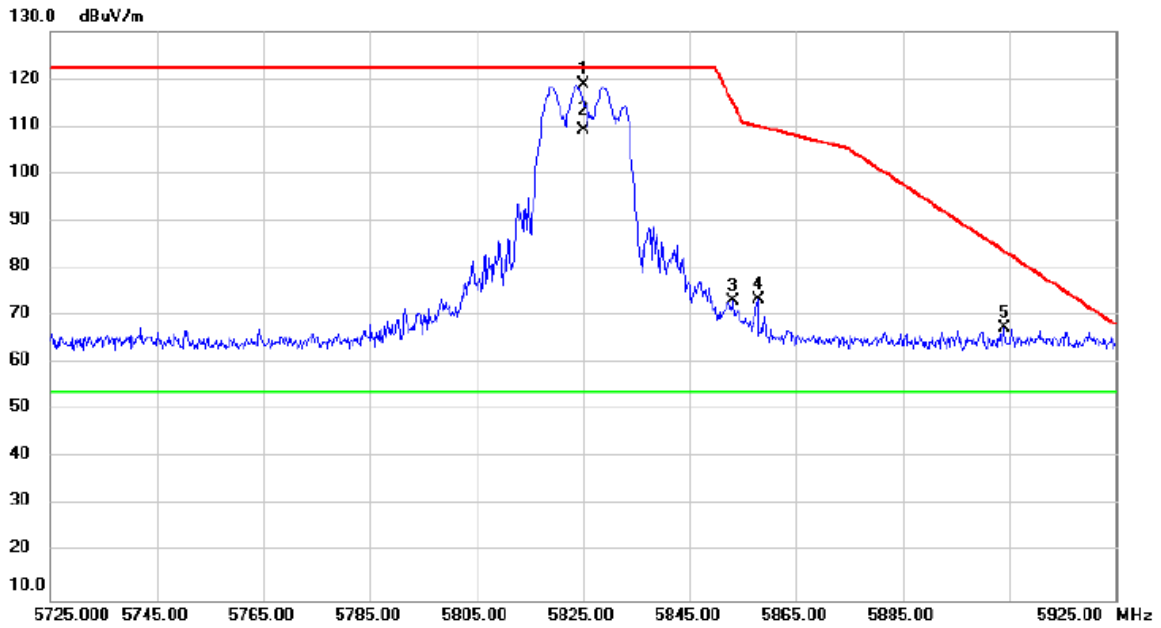

No.	Mk.	Freq. MHz	Reading Level dBuV	Correct Factor dB	Measure- ment dBuV/m	Limit dBuV/m	Over dB	Detector	Comment
1		5825.000	80.21	38.47	118.68	122.20	-3.52	peak	No Limit
2	*	5825.000	70.82	38.47	109.29	54.00	55.29	AVG	No Limit
3		5853.200	34.57	38.50	73.07	114.90	-41.83	peak	
4		5857.800	34.92	38.51	73.43	110.01	-36.58	peak	
5		5904.000	28.84	38.58	67.42	83.70	-16.28	peak	

Test Mode	UNII-3_TX N (HT20) Mode 5745MHz	Polarization	Vertical
-----------	---------------------------------	--------------	----------

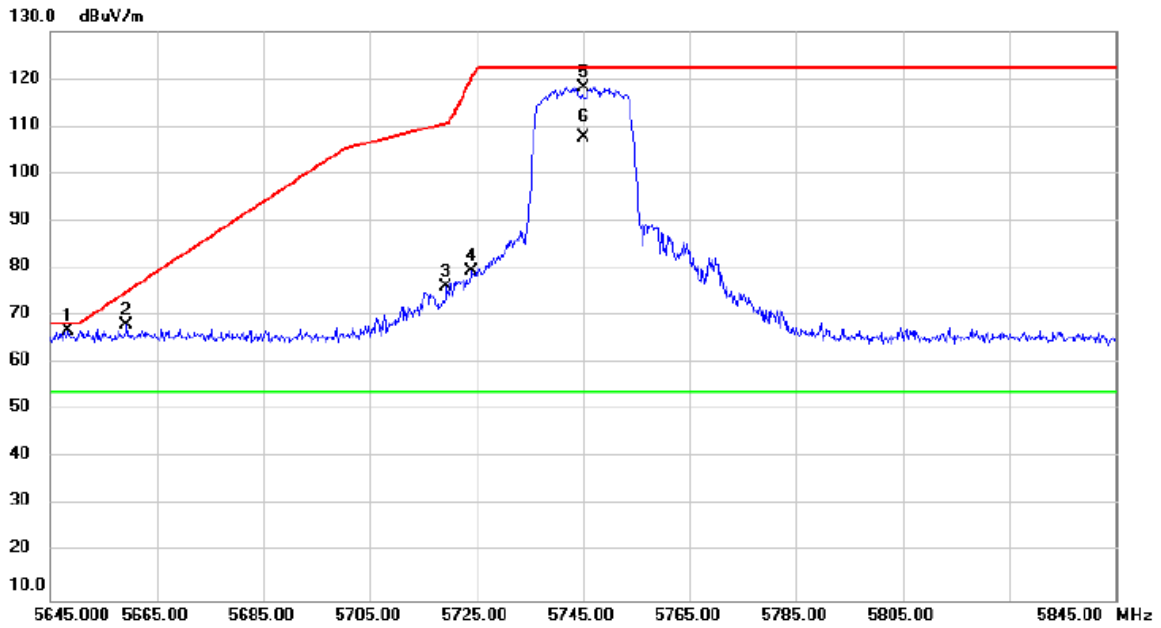

No.	Mk.	Freq. MHz	Reading Level dBuV	Correct Factor dB	Measure- ment dBuV/m	Limit dBuV/m	Over dB	Detector	Comment
1		5648.400	28.52	38.22	66.74	68.20	-1.46	peak	
2		5659.400	29.83	38.23	68.06	75.18	-7.12	peak	
3		5719.400	37.77	38.32	76.09	110.63	-34.54	peak	
4		5724.200	41.19	38.32	79.51	120.38	-40.87	peak	
5		5745.000	79.89	38.35	118.24	122.20	-3.96	peak	No Limit
6	*	5745.000	69.17	38.35	107.52	54.00	53.52	AVG	No Limit

Test Mode	UNII-3_TX N (HT20) Mode 5825MHz	Polarization	Vertical
-----------	---------------------------------	--------------	----------

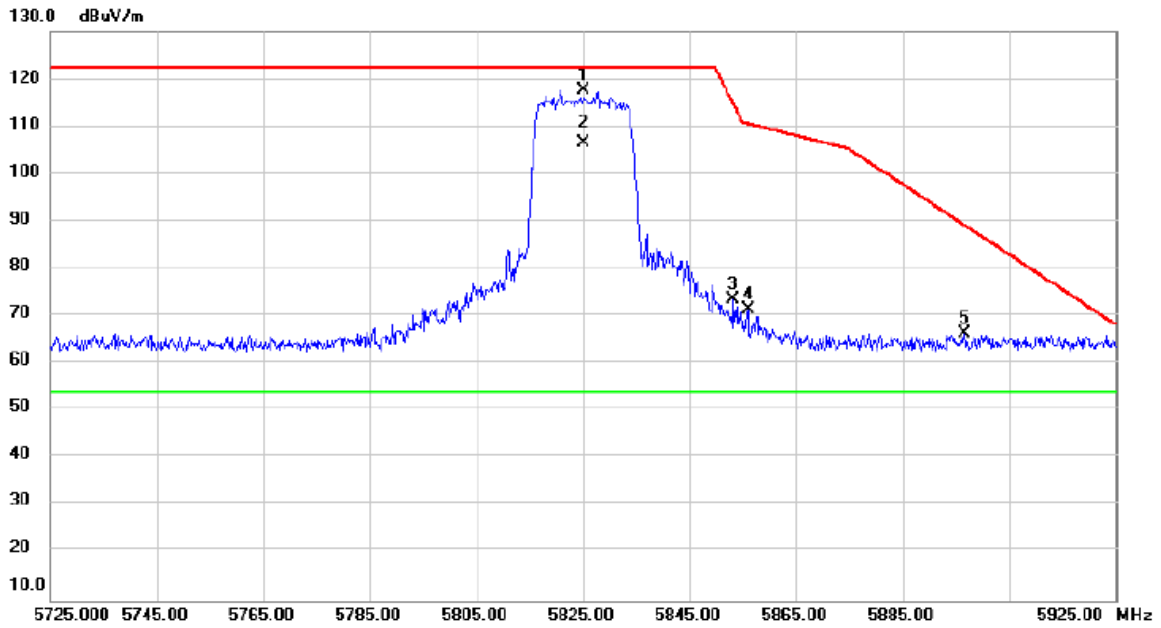

No.	Mk.	Freq. MHz	Reading Level dBuV	Correct Factor dB	Measure- ment dBuV/m	Limit dBuV/m	Over dB	Detector	Comment
1		5825.000	79.01	38.47	117.48	122.20	-4.72	peak	No Limit
2	*	5825.000	67.89	38.47	106.36	54.00	52.36	AVG	No Limit
3		5853.200	34.89	38.50	73.39	114.90	-41.51	peak	
4		5856.000	32.92	38.51	71.43	110.52	-39.09	peak	
5		5896.600	27.78	38.57	66.35	89.18	-22.83	peak	

Test Mode	UNII-3_TX N (HT40) Mode 5755MHz	Polarization	Vertical
-----------	---------------------------------	--------------	----------

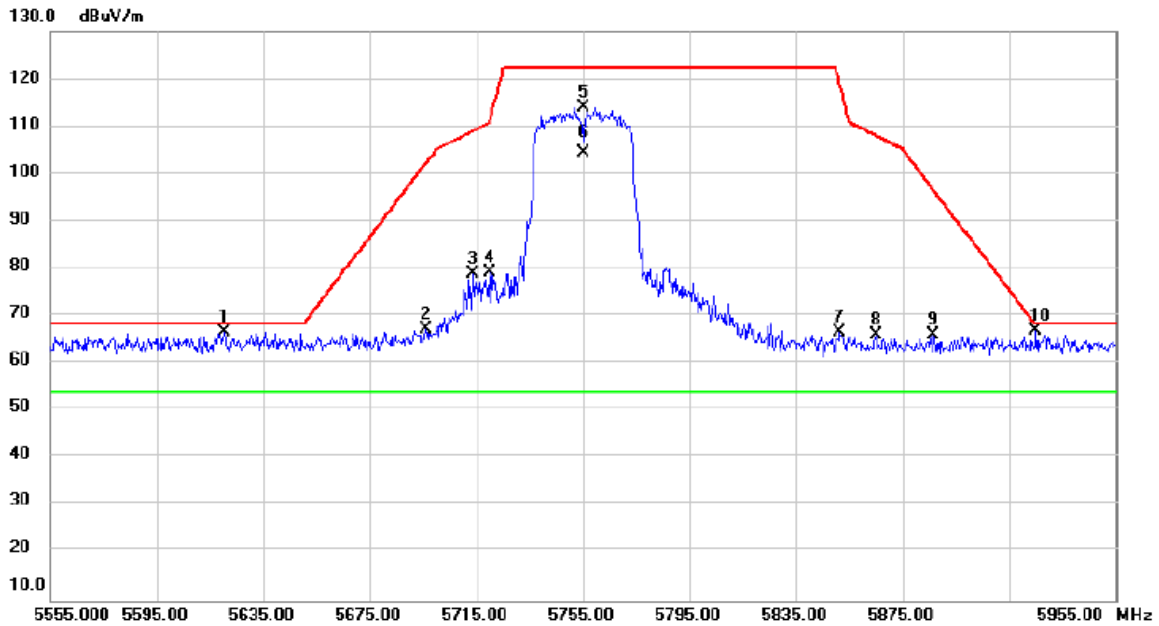

No.	Mk.	Freq. MHz	Reading Level dBuV	Correct Factor dB	Measure- ment dBuV/m	Limit dBuV/m	Over dB	Detector	Comment
1		5620.200	28.37	38.18	66.55	68.20	-1.65	peak	
2		5696.200	28.87	38.28	67.15	102.40	-35.25	peak	
3		5713.800	40.44	38.31	78.75	109.07	-30.32	peak	
4		5719.800	40.80	38.32	79.12	110.74	-31.62	peak	
5		5755.000	75.70	38.37	114.07	122.20	-8.13	peak	No Limit
6	*	5755.000	65.91	38.37	104.28	54.00	50.28	AVG	No Limit
7		5851.400	28.13	38.50	66.63	119.01	-52.38	peak	
8		5865.000	27.41	38.52	65.93	108.00	-42.07	peak	

Test Mode	UNII-3_TX N (HT40) Mode 5795MHz	Polarization	Vertical
-----------	---------------------------------	--------------	----------

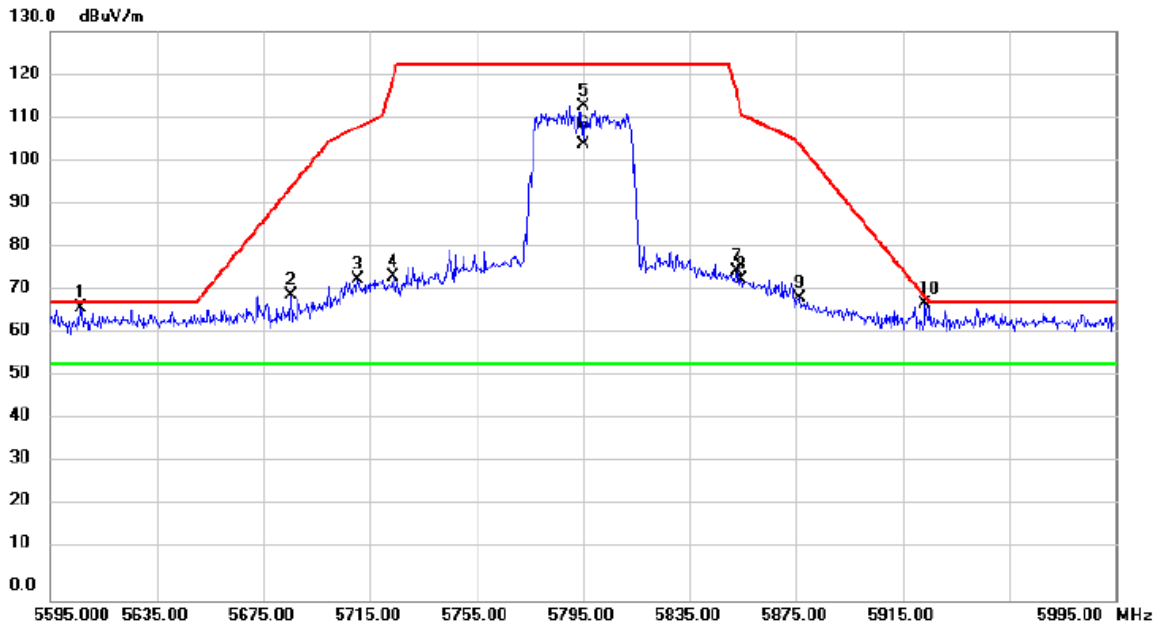

No.	Mk.	Freq. MHz	Reading Level dBuV	Correct Factor dB	Measure- ment dBuV/m	Limit dBuV/m	Over dB	Detector	Comment
1		5606.600	28.63	38.16	66.79	68.20	-1.41	peak	
2		5685.400	31.39	38.27	69.66	94.43	-24.77	peak	
3		5710.600	35.06	38.30	73.36	108.17	-34.81	peak	
4		5723.800	35.58	38.32	73.90	119.46	-45.56	peak	
5		5795.000	74.36	38.42	112.78	122.20	-9.42	peak	No Limit
6	*	5795.000	65.77	38.42	104.19	54.00	50.19	AVG	No Limit
7		5852.600	36.74	38.50	75.24	116.27	-41.03	peak	
8		5854.600	34.85	38.51	73.36	111.71	-38.35	peak	

Test Mode	UNII-3_TX AC (VHT80) Mode 5775MHz	Polarization	Vertical
-----------	-----------------------------------	--------------	----------

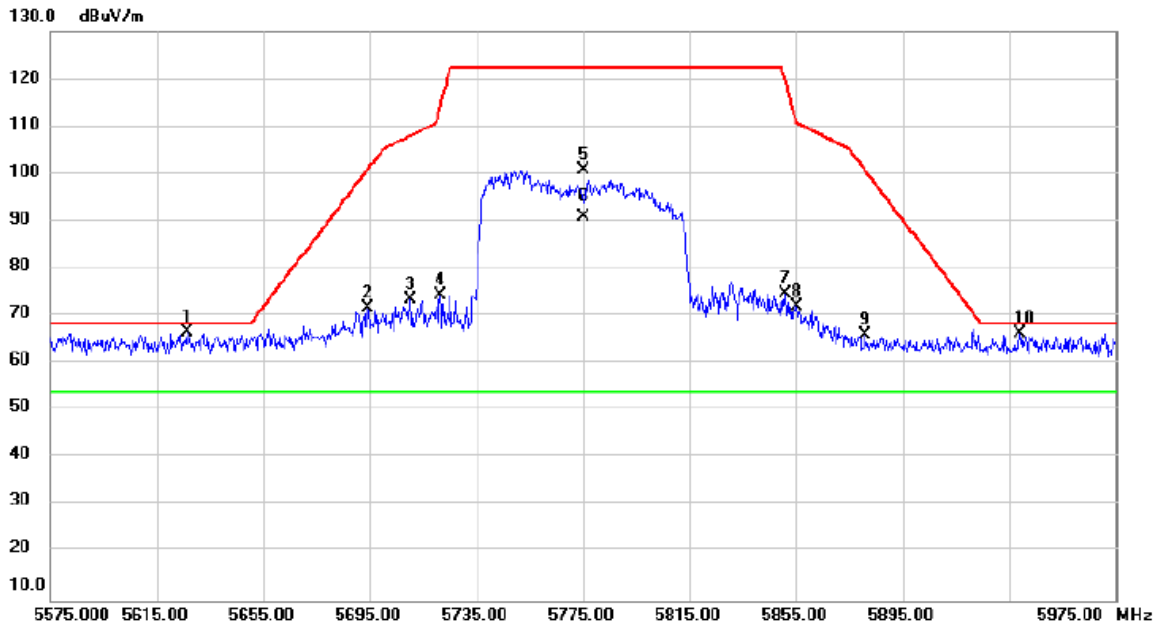

No.	Mk.	Freq. MHz	Reading Level dBuV	Correct Factor dB	Measure- ment dBuV/m	Limit dBuV/m	Over dB	Detector	Comment
1		5626.600	28.27	38.19	66.46	68.20	-1.74	peak	
2		5694.200	33.41	38.28	71.69	100.92	-29.23	peak	
3		5710.200	35.24	38.30	73.54	108.06	-34.52	peak	
4		5721.400	36.10	38.32	74.42	113.99	-39.57	peak	
5		5775.000	62.28	38.39	100.67	122.20	-21.53	peak	No Limit
6	*	5775.000	52.54	38.39	90.93	54.00	36.93	AVG	No Limit
7		5851.000	36.14	38.50	74.64	119.92	-45.28	peak	
8		5855.400	33.43	38.51	71.94	110.69	-38.75	peak	

Test Mode	UNII-1_TX A Mode 5180MHz	Polarization	Vertical
-----------	--------------------------	--------------	----------

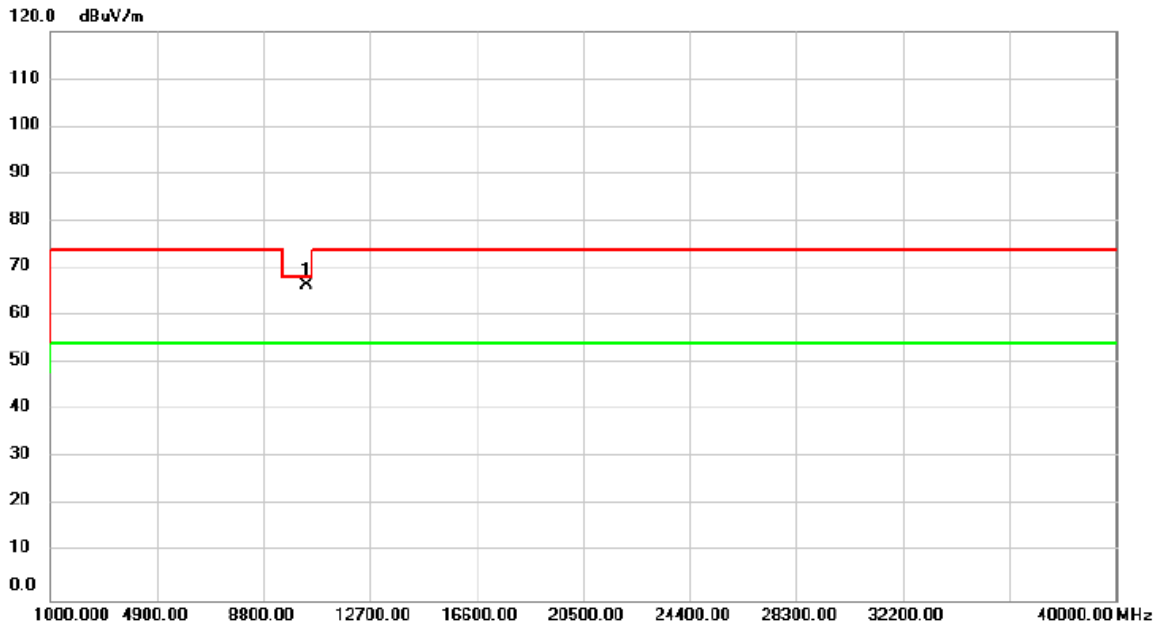

No.	Mk.	Freq. MHz	Reading Level dBuV	Correct Factor dB	Measure- ment dBuV/m	Limit dBuV/m	Over dB	Detector	Comment
1	*	10360.00	62.64	3.68	66.32	68.20	-1.88	peak	

Test Mode	UNII-1_TX A Mode 5180MHz	Polarization	Horizontal
-----------	--------------------------	--------------	------------

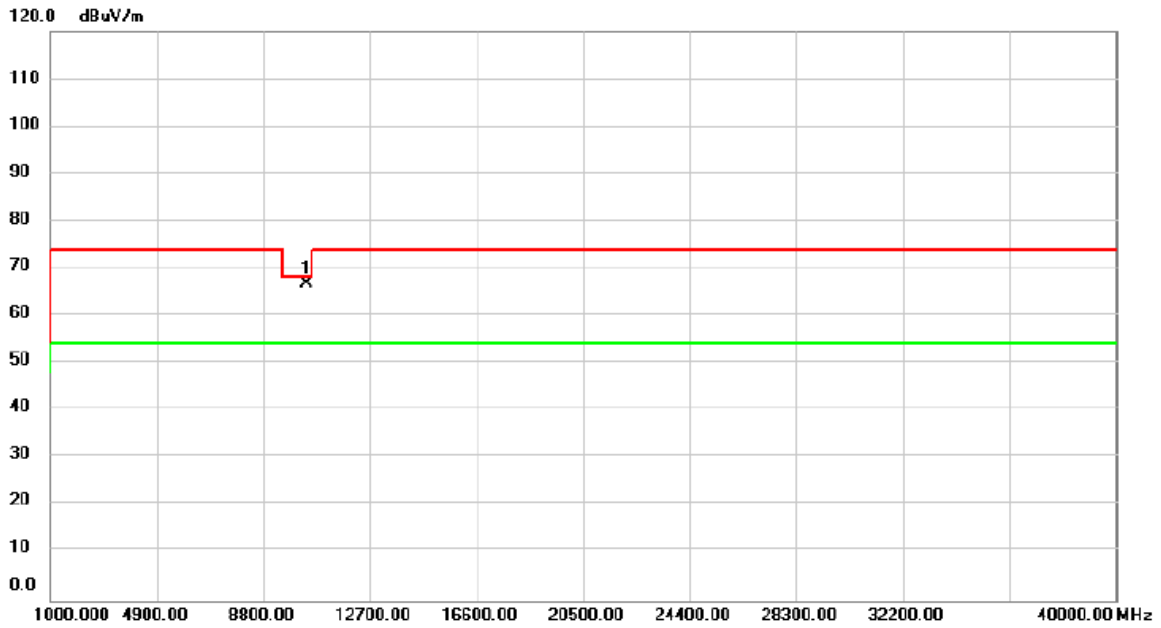

No.	Mk.	Freq. MHz	Reading Level dBuV	Correct Factor dB	Measure- ment dBuV/m	Limit dBuV/m	Over dB	Detector	Comment
1	*	10360.00	63.07	3.68	66.75	68.20	-1.45	peak	

Test Mode	UNII-1_TX A Mode 5200MHz	Polarization	Vertical
-----------	--------------------------	--------------	----------

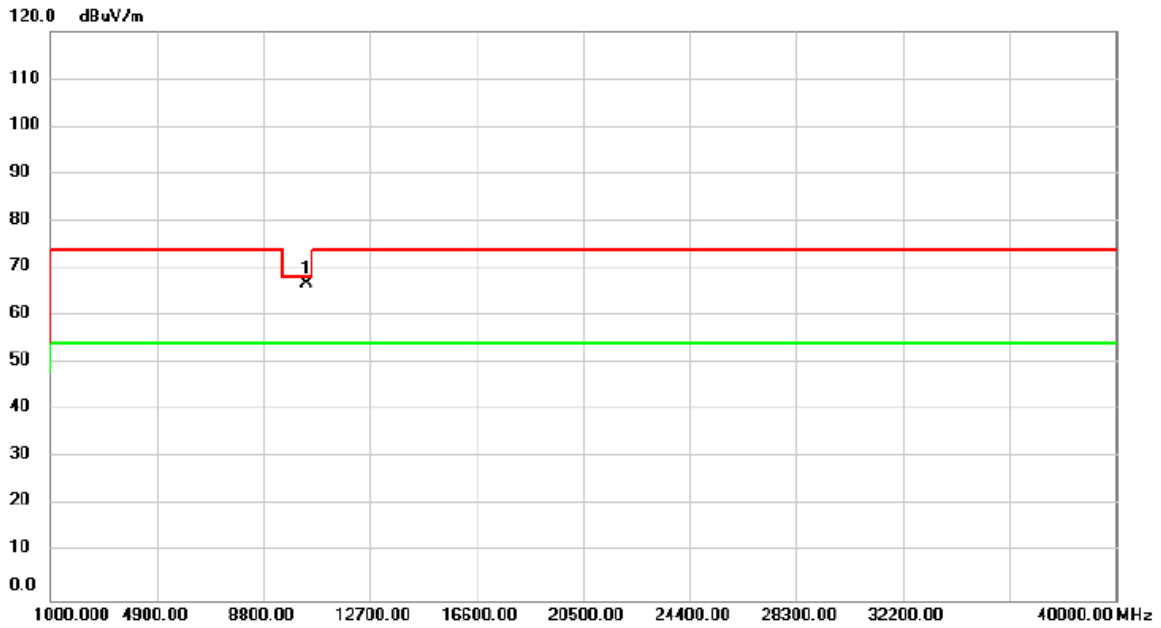

No.	Mk.	Freq. MHz	Reading Level dBuV	Correct Factor dB	Measure- ment dBuV/m	Limit dBuV/m	Over dB	Detector	Comment
1	*	10400.00	63.14	3.74	66.88	68.20	-1.32	peak	

Test Mode	UNII-1_TX A Mode 5200MHz	Polarization	Horizontal
-----------	--------------------------	--------------	------------

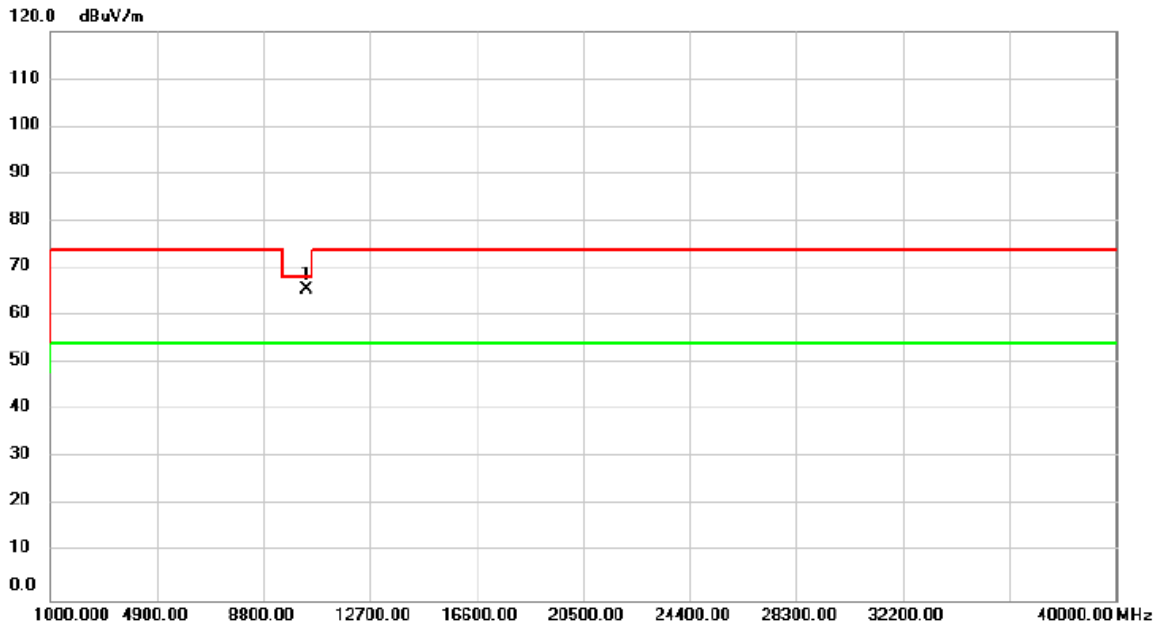

No.	Mk.	Freq. MHz	Reading Level dBuV	Correct Factor dB	Measure- ment dBuV/m	Limit dBuV/m	Over dB	Detector	Comment
1	*	10400.00	61.69	3.74	65.43	68.20	-2.77	peak	

Test Mode	UNII-1_TX A Mode 5240MHz	Polarization	Vertical
-----------	--------------------------	--------------	----------

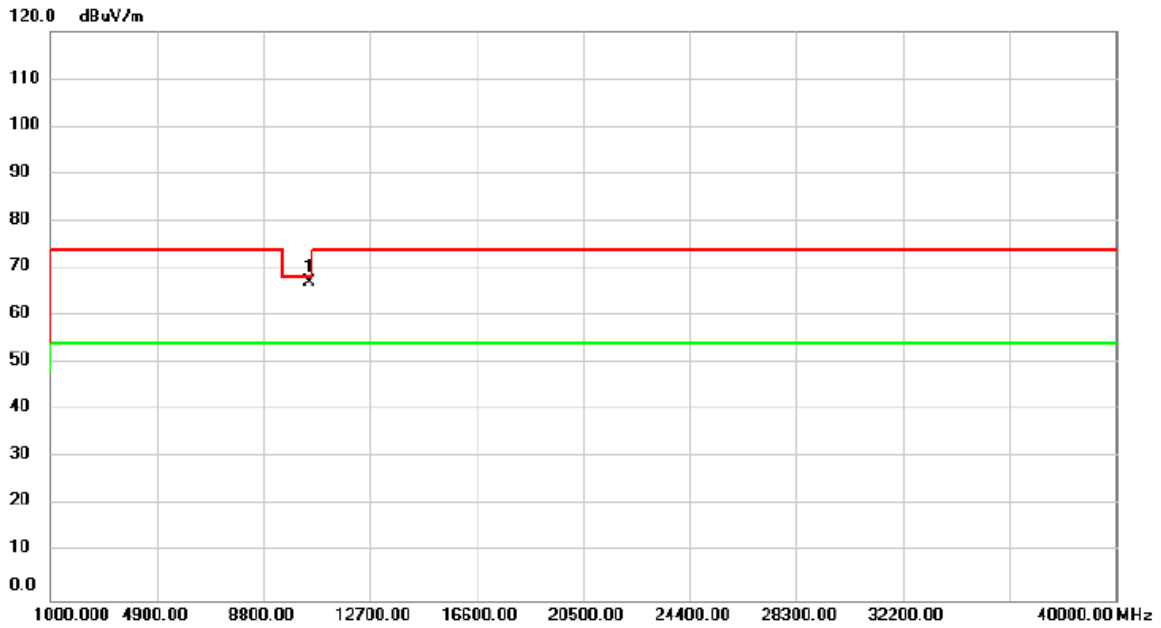

No.	Mk.	Freq. MHz	Reading Level dBuV	Correct Factor dB	Measure- ment dBuV/m	Limit dBuV/m	Over dB	Detector	Comment
1	*	10480.00	63.16	3.84	67.00	68.20	-1.20	peak	

Test Mode	UNII-1_TX A Mode 5240MHz	Polarization	Horizontal
-----------	--------------------------	--------------	------------

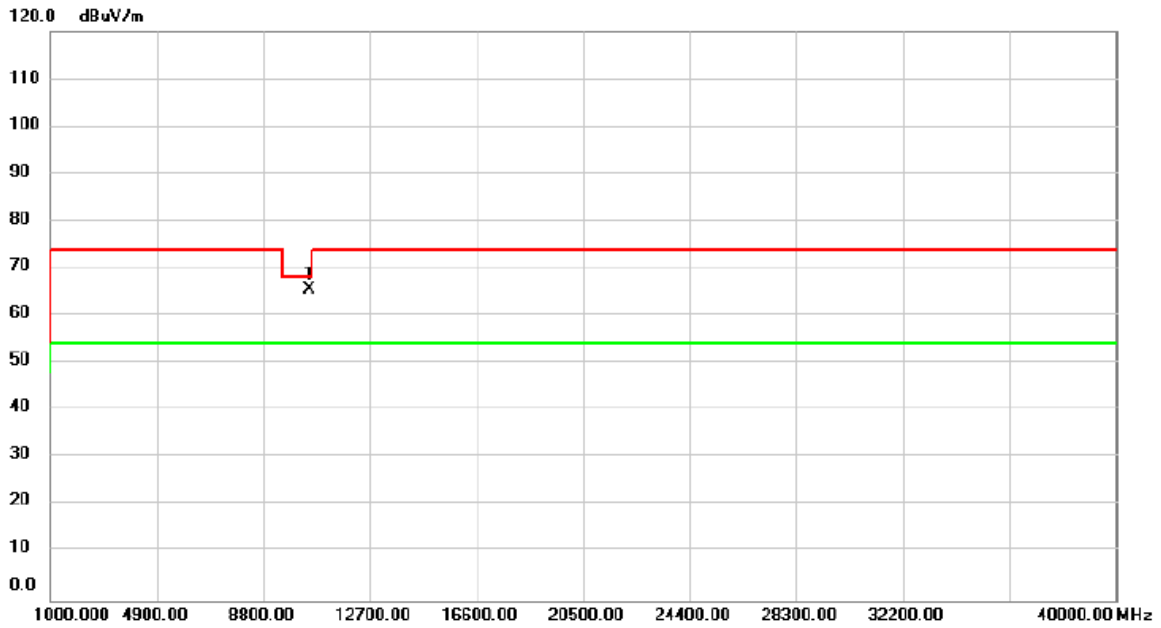

No.	Mk.	Freq. MHz	Reading Level dBuV	Correct Factor dB	Measure- ment dBuV/m	Limit dBuV/m	Over dB	Detector	Comment
1	*	10480.00	61.79	3.84	65.63	68.20	-2.57	peak	

Test Mode	UNII-1_TX N (HT20) Mode 5180MHz	Polarization	Vertical
-----------	---------------------------------	--------------	----------

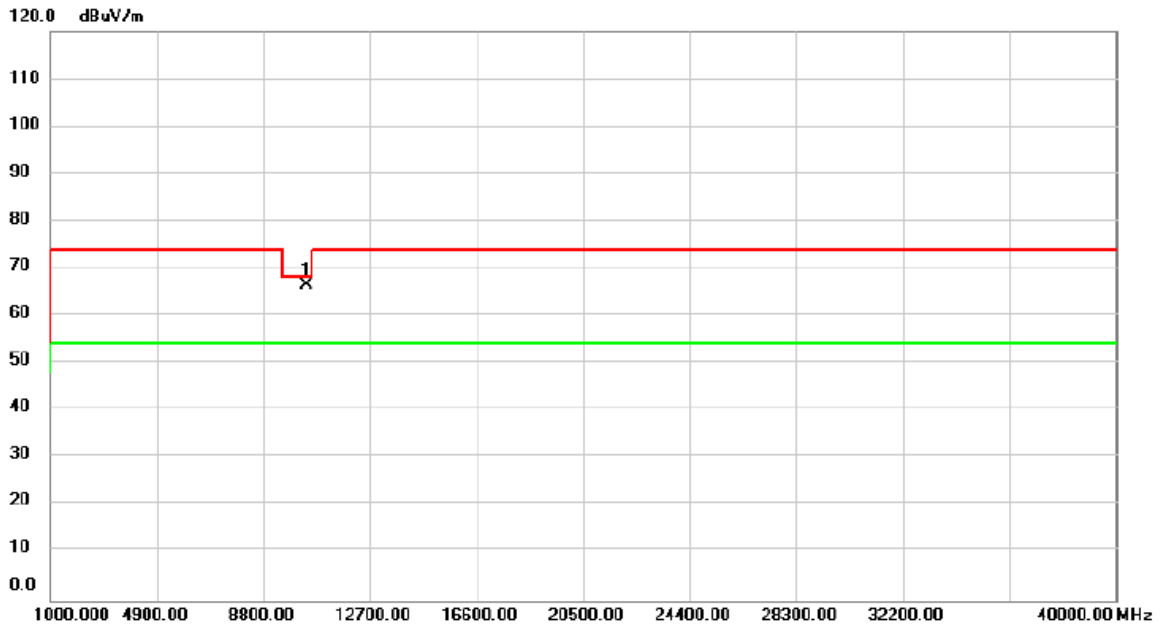

No.	Mk.	Freq. MHz	Reading Level dBuV	Correct Factor dB	Measure- ment dBuV/m	Limit dBuV/m	Over dB	Detector	Comment
1	*	10360.00	62.82	3.68	66.50	68.20	-1.70	peak	

Test Mode	UNII-1_TX N (HT20) Mode 5180MHz	Polarization	Horizontal
-----------	---------------------------------	--------------	------------

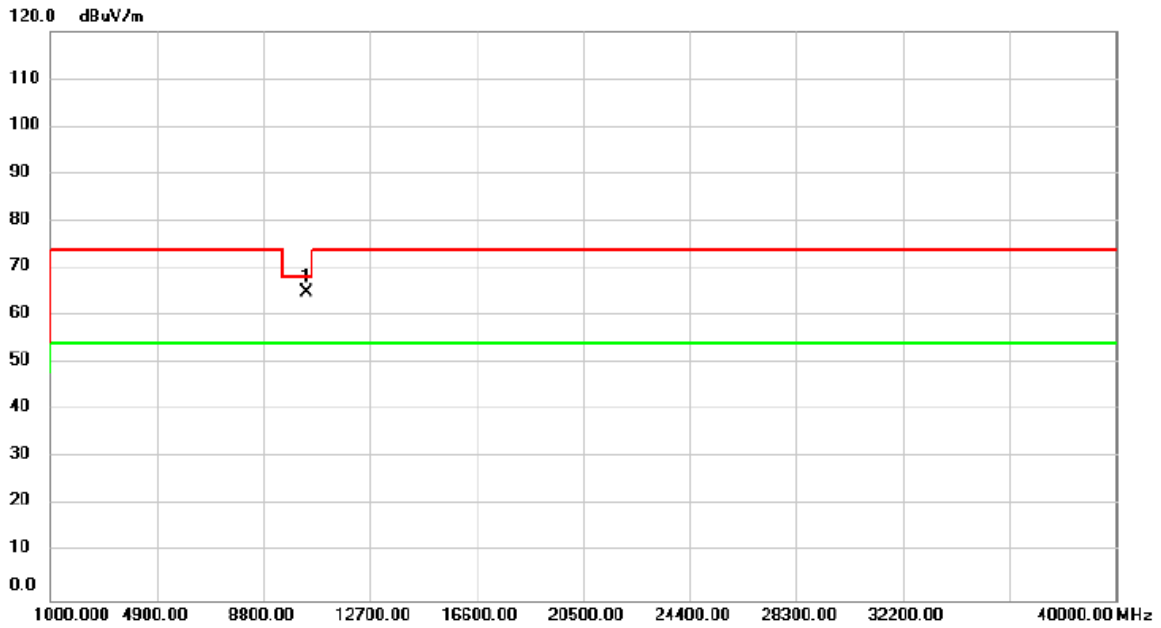

No.	Mk.	Freq. MHz	Reading Level dBuV	Correct Factor dB	Measure- ment dBuV/m	Limit dBuV/m	Over dB	Detector	Comment
1	*	10360.00	61.26	3.68	64.94	68.20	-3.26	peak	

Test Mode	UNII-1_TX N (HT20) Mode 5200MHz	Polarization	Vertical
-----------	---------------------------------	--------------	----------

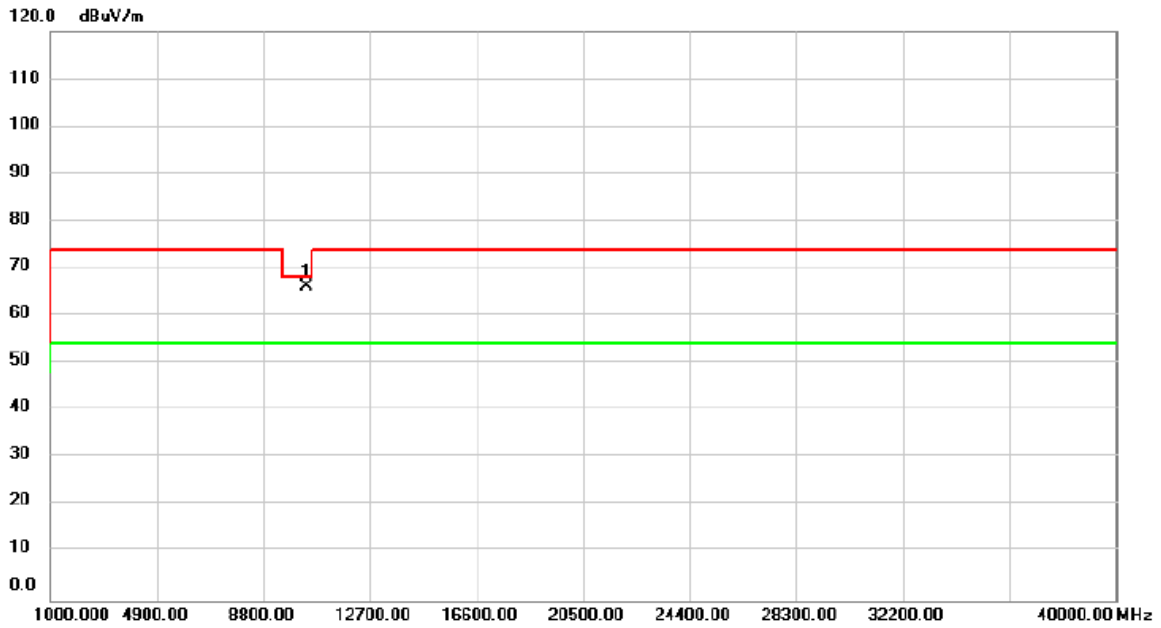

No.	Mk.	Freq. MHz	Reading Level dBuV	Correct Factor dB	Measure- ment dBuV/m	Limit dBuV/m	Over dB	Detector	Comment
1	*	10400.00	62.33	3.74	66.07	68.20	-2.13	peak	

Test Mode	UNII-1_TX N (HT20) Mode 5200MHz	Polarization	Horizontal
-----------	---------------------------------	--------------	------------

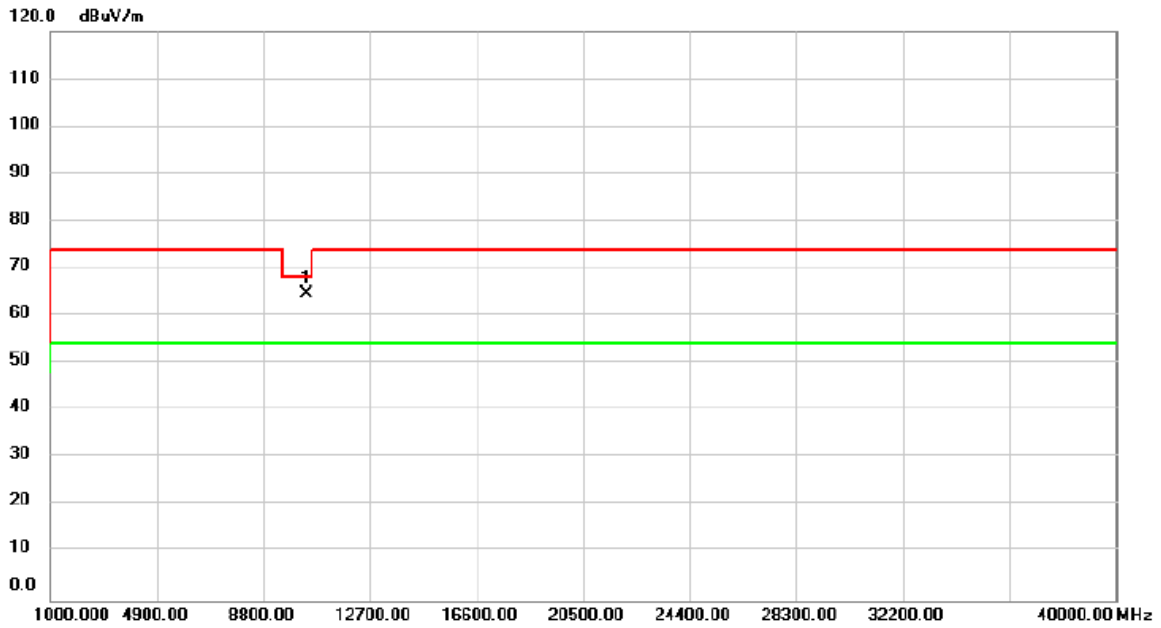

No.	Mk.	Freq. MHz	Reading Level dBuV	Correct Factor dB	Measure- ment dBuV/m	Limit dBuV/m	Over dB	Detector	Comment
1	*	10400.00	60.99	3.74	64.73	68.20	-3.47	peak	

Test Mode	UNII-1_TX N (HT20) Mode 5240MHz	Polarization	Vertical
-----------	---------------------------------	--------------	----------

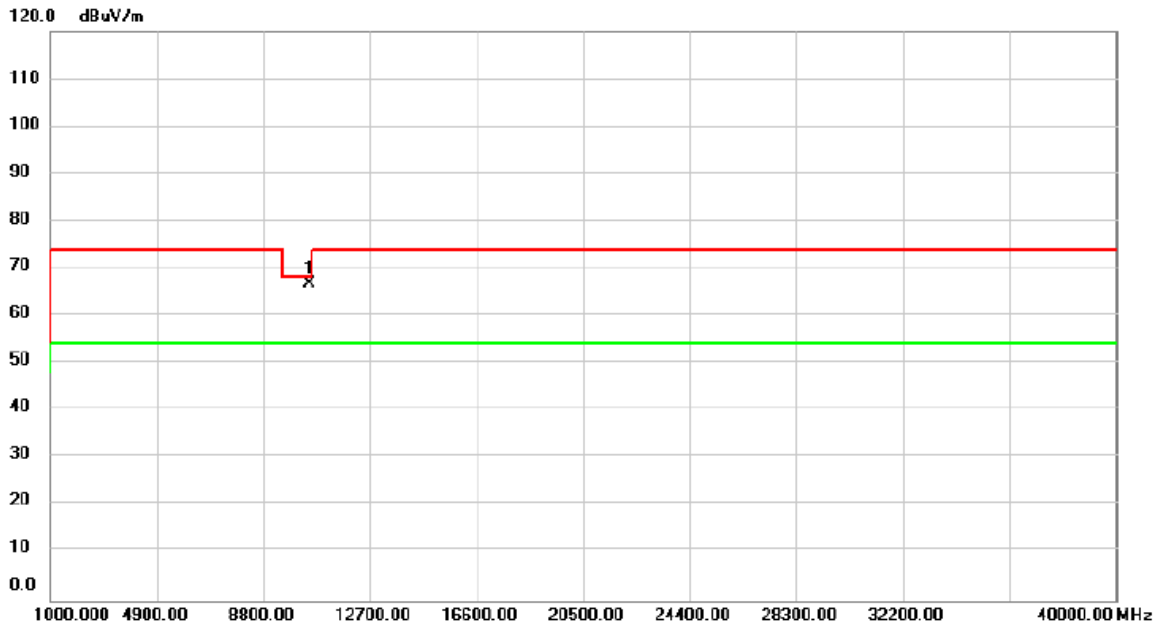

No.	Mk.	Freq. MHz	Reading Level dBuV	Correct Factor dB	Measure- ment dBuV/m	Limit dBuV/m	Over dB	Detector	Comment
1	*	10480.00	62.78	3.84	66.62	68.20	-1.58	peak	

Test Mode	UNII-1_TX N (HT20) Mode 5240MHz	Polarization	Horizontal
-----------	---------------------------------	--------------	------------

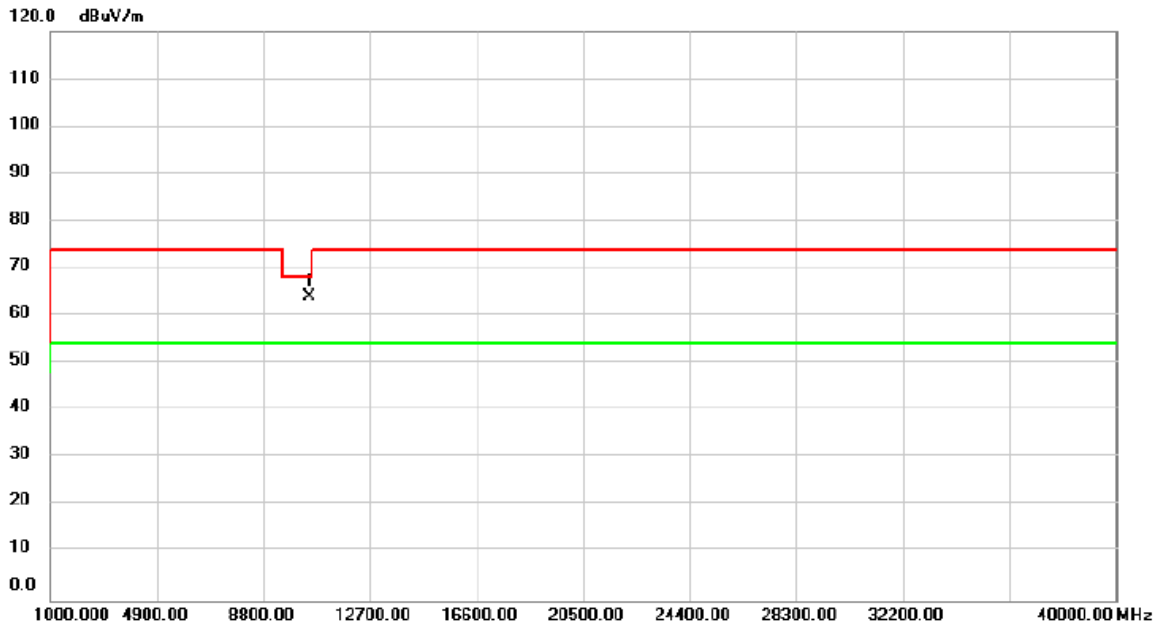

No.	Mk.	Freq. MHz	Reading Level dBuV	Correct Factor dB	Measure- ment dBuV/m	Limit dBuV/m	Over dB	Detector	Comment
1	*	10480.00	60.15	3.84	63.99	68.20	-4.21	peak	

Test Mode	UNII-1_TX N (HT40) Mode 5190MHz	Polarization	Vertical
-----------	---------------------------------	--------------	----------

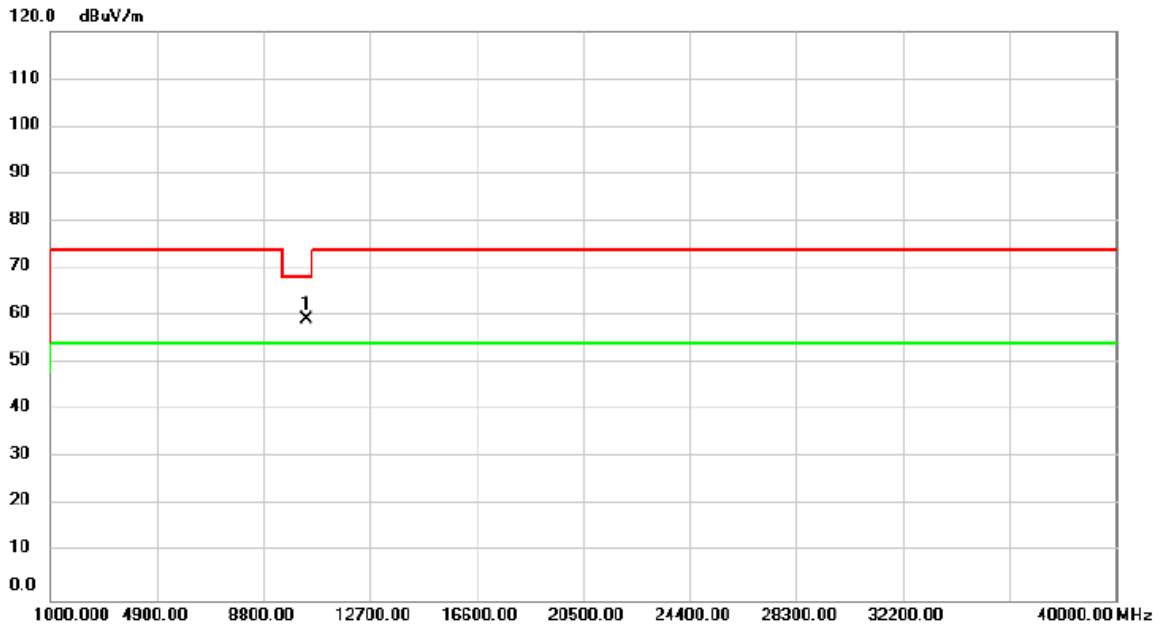

No.	Mk.	Freq. MHz	Reading Level dBuV	Correct Factor dB	Measure- ment dBuV/m	Limit dBuV/m	Over dB	Detector	Comment
1	*	10380.00	55.55	3.71	59.26	68.20	-8.94	peak	

Test Mode	UNII-1_TX N (HT40) Mode 5190MHz	Polarization	Horizontal
-----------	---------------------------------	--------------	------------

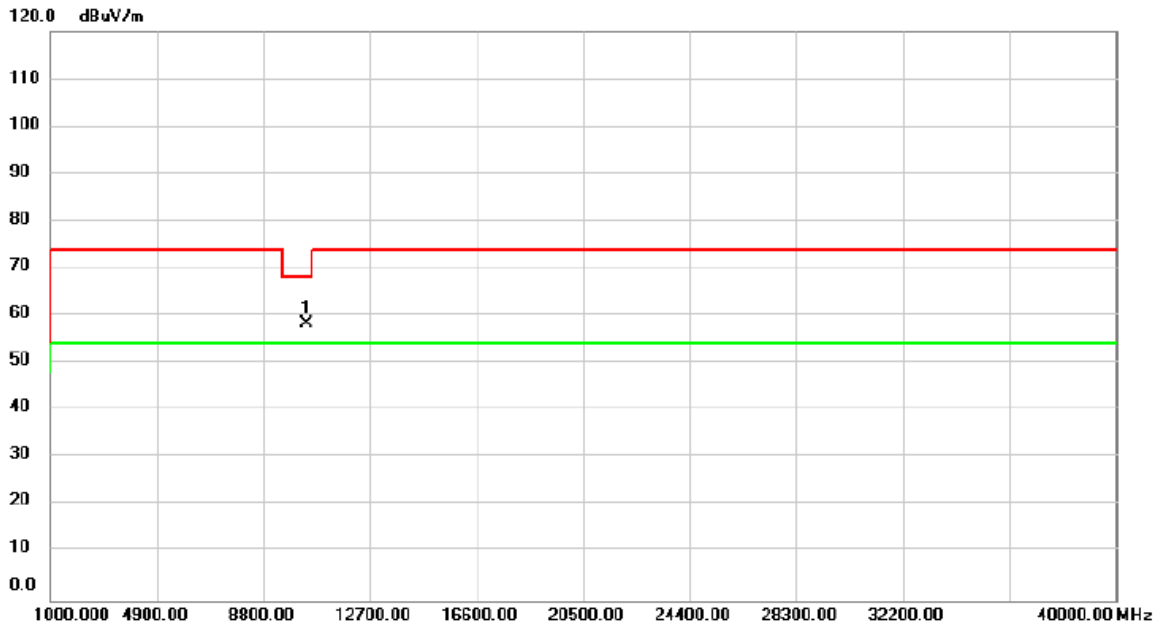

No.	Mk.	Freq. MHz	Reading Level dBuV	Correct Factor dB	Measure- ment dBuV/m	Limit dBuV/m	Over dB	Detector	Comment
1	*	10380.00	54.54	3.71	58.25	68.20	-9.95	peak	

Test Mode	UNII-1_TX N (HT40) Mode 5230MHz	Polarization	Vertical
-----------	---------------------------------	--------------	----------

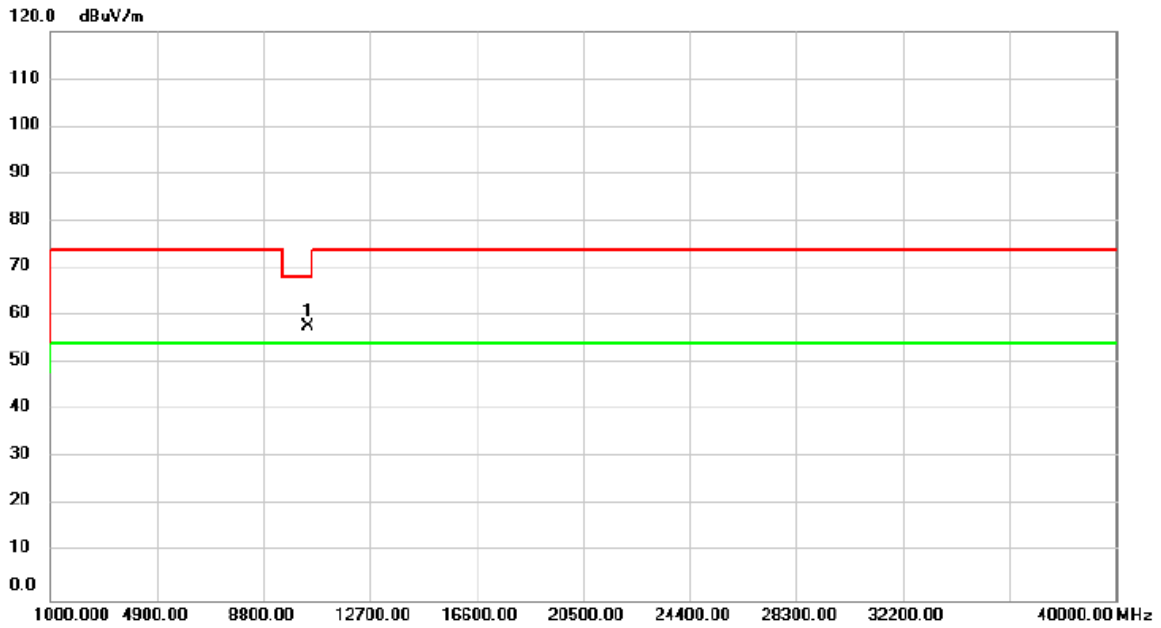

No.	Mk.	Freq. MHz	Reading Level dBuV	Correct Factor dB	Measure- ment dBuV/m	Limit dBuV/m	Over dB	Detector	Comment
1	*	10460.00	53.85	3.82	57.67	68.20	-10.53	peak	

Test Mode	UNII-1_TX N (HT40) Mode 5230MHz	Polarization	Horizontal
-----------	---------------------------------	--------------	------------

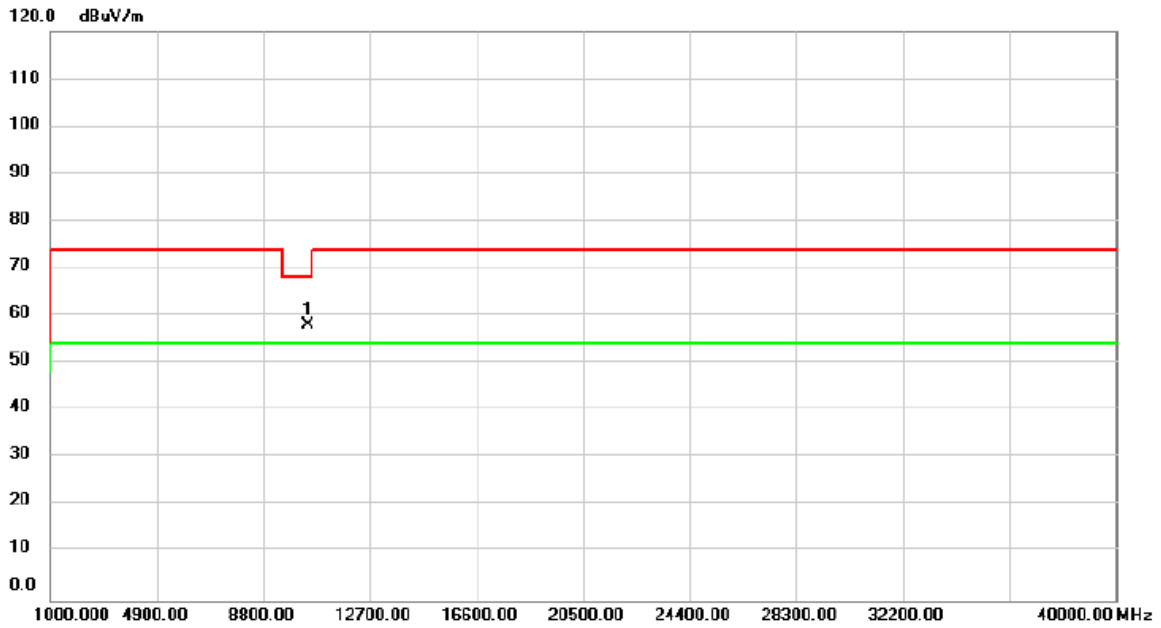

No.	Mk.	Freq. MHz	Reading Level dBuV	Correct Factor dB	Measure- ment dBuV/m	Limit dBuV/m	Over dB	Detector	Comment
1	*	10460.00	54.31	3.82	58.13	68.20	-10.07	peak	

Test Mode	UNII-1_TX AC (VHT80) Mode 5210MHz	Polarization	Vertical
-----------	-----------------------------------	--------------	----------

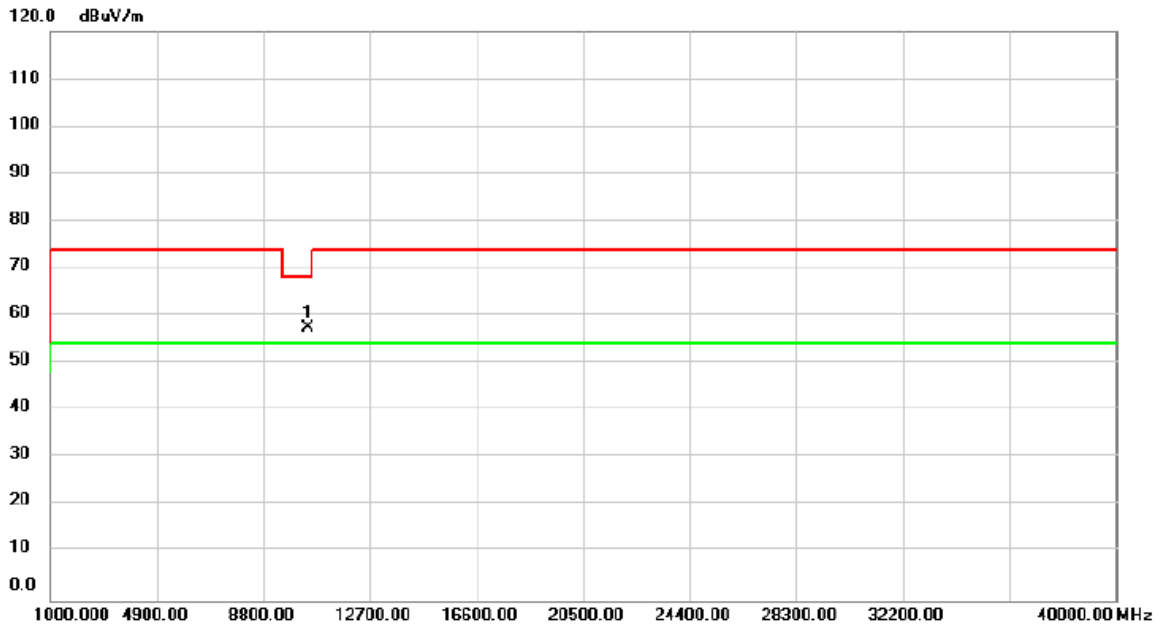

No.	Mk.	Freq. MHz	Reading Level dBuV	Correct Factor dB	Measure- ment dBuV/m	Limit dBuV/m	Over dB	Detector	Comment
1	*	10420.00	53.62	3.76	57.38	68.20	-10.82	peak	

Test Mode	UNII-1_TX AC (VHT80) Mode 5210MHz	Polarization	Horizontal
-----------	-----------------------------------	--------------	------------

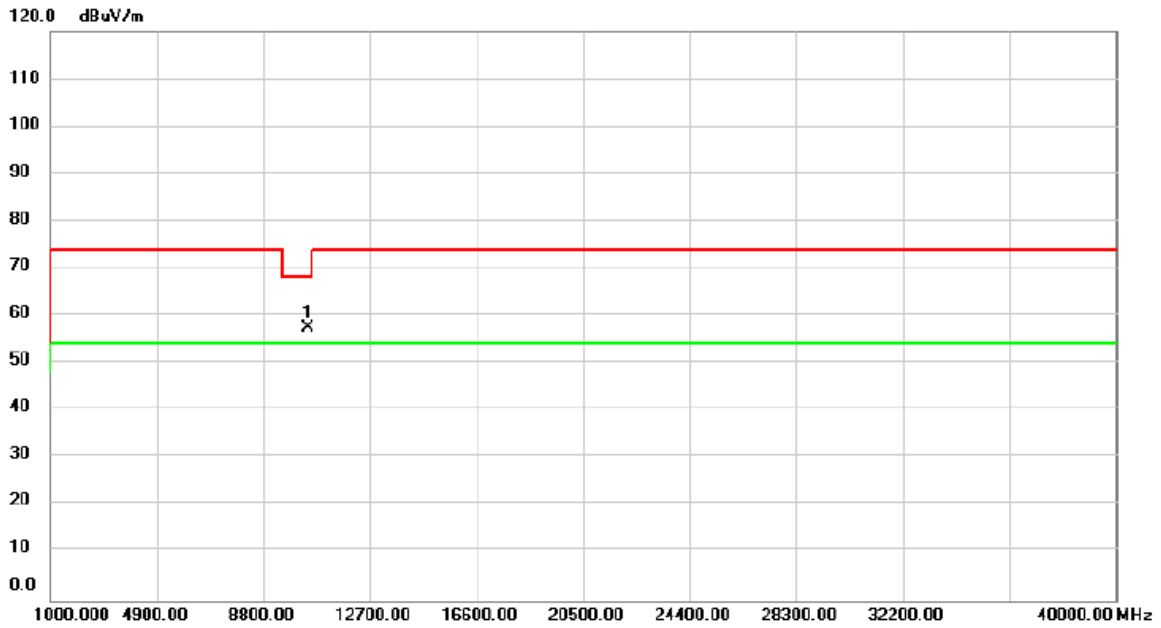

No.	Mk.	Freq. MHz	Reading Level dBuV	Correct Factor dB	Measure- ment dBuV/m	Limit dBuV/m	Over dB	Detector	Comment
1	*	10420.00	53.74	3.76	57.50	68.20	-10.70	peak	

Test Mode	UNII-3_TX A Mode 5745MHz	Polarization	Vertical
-----------	--------------------------	--------------	----------

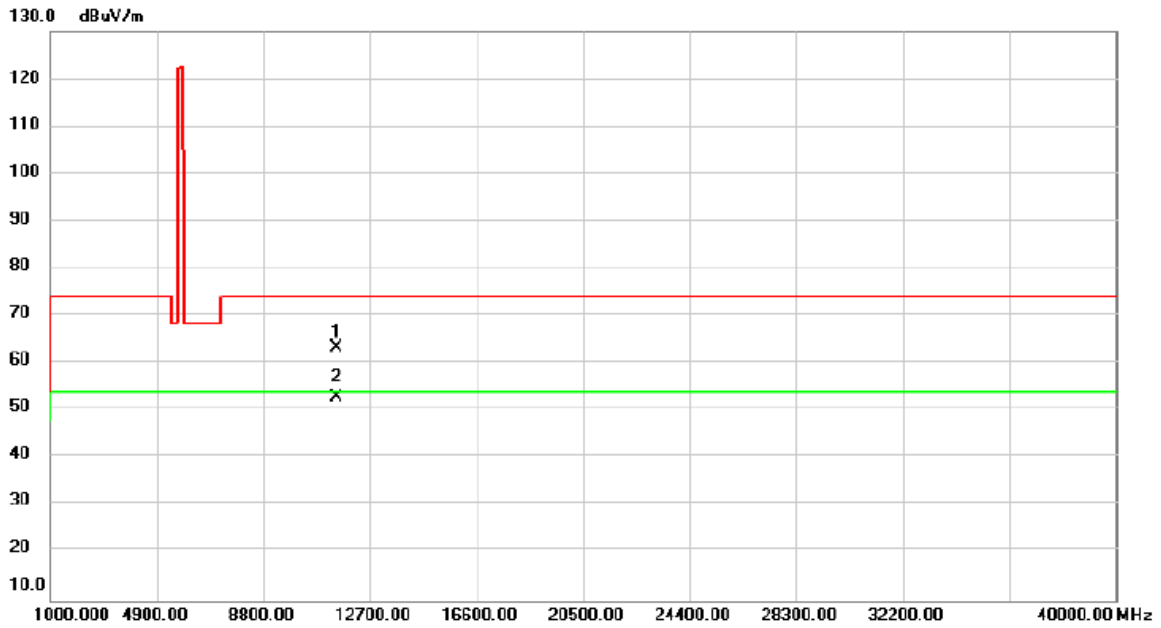

No.	Mk.	Freq. MHz	Reading Level dBuV	Correct Factor dB	Measure- ment dBuV/m	Limit dBuV/m	Over dB	Detector	Comment
1		11490.00	58.11	5.11	63.22	74.00	-10.78	peak	
2	*	11490.00	47.72	5.11	52.83	54.00	-1.17	AVG	

Test Mode	UNII-3_TX A Mode 5745MHz	Polarization	Horizontal
-----------	--------------------------	--------------	------------

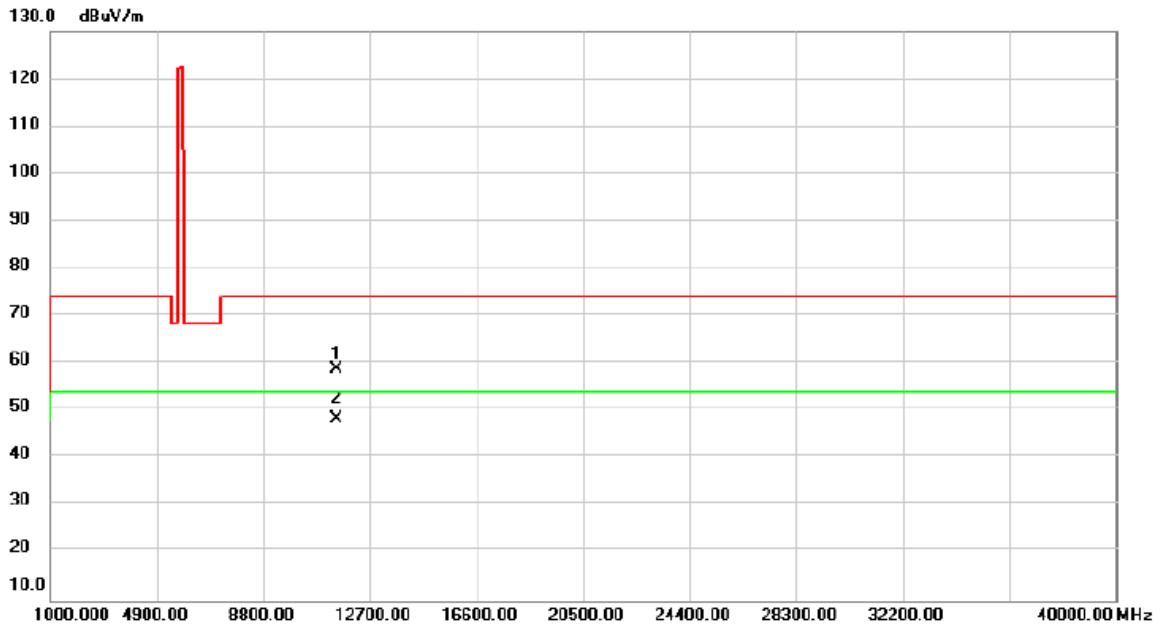

No.	Mk.	Freq. MHz	Reading Level dBuV	Correct Factor dB	Measure- ment dBuV/m	Limit dBuV/m	Over dB	Detector	Comment
1		11490.00	53.77	5.11	58.88	74.00	-15.12	peak	
2	*	11490.00	43.03	5.11	48.14	54.00	-5.86	AVG	

Test Mode	UNII-3_TX A Mode 5785MHz	Polarization	Vertical
-----------	--------------------------	--------------	----------

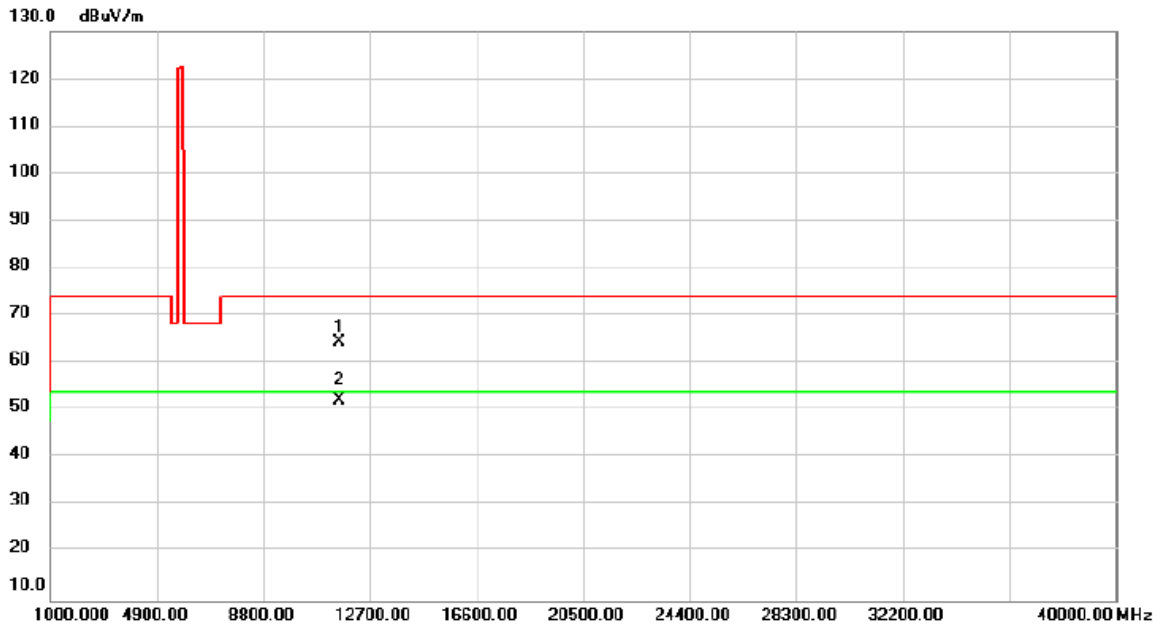

No.	Mk.	Freq. MHz	Reading Level dBuV	Correct Factor dB	Measure- ment dBuV/m	Limit dBuV/m	Over dB	Detector	Comment
1		11570.00	59.63	4.78	64.41	74.00	-9.59	peak	
2	*	11570.00	47.29	4.78	52.07	54.00	-1.93	AVG	

Test Mode	UNII-3_TX A Mode 5785MHz	Polarization	Horizontal
-----------	--------------------------	--------------	------------

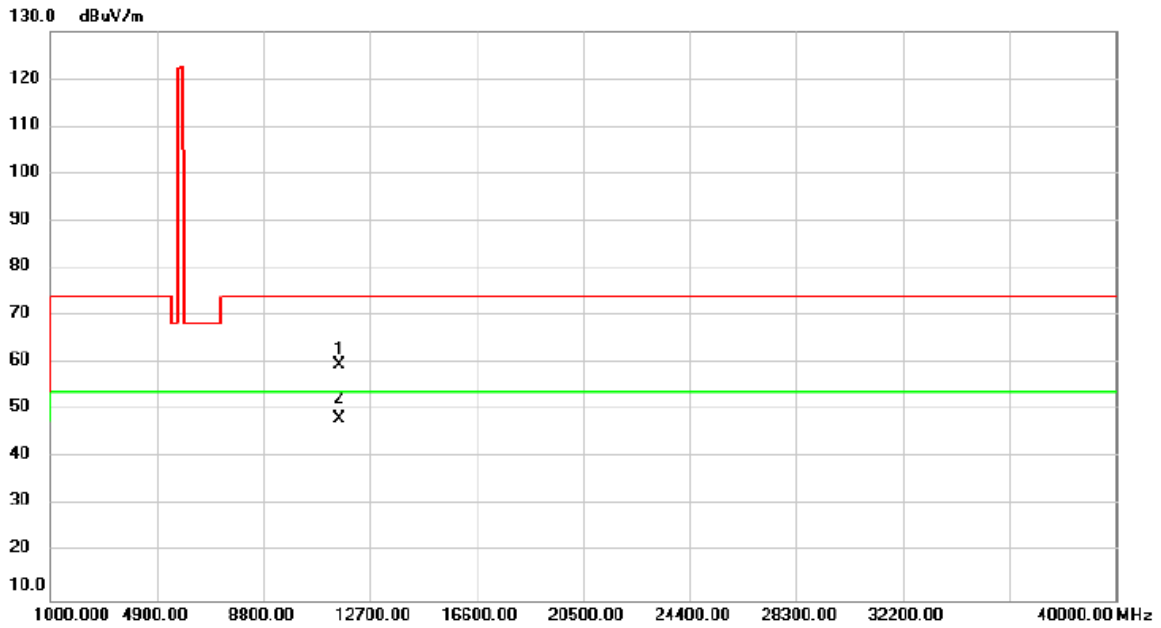

No.	Mk.	Freq. MHz	Reading Level dBuV	Correct Factor dB	Measure- ment dBuV/m	Limit dBuV/m	Over dB	Detector	Comment
1		11570.00	54.83	4.78	59.61	74.00	-14.39	peak	
2	*	11570.00	43.51	4.78	48.29	54.00	-5.71	AVG	

Test Mode	UNII-3_TX A Mode 5825MHz	Polarization	Vertical
-----------	--------------------------	--------------	----------

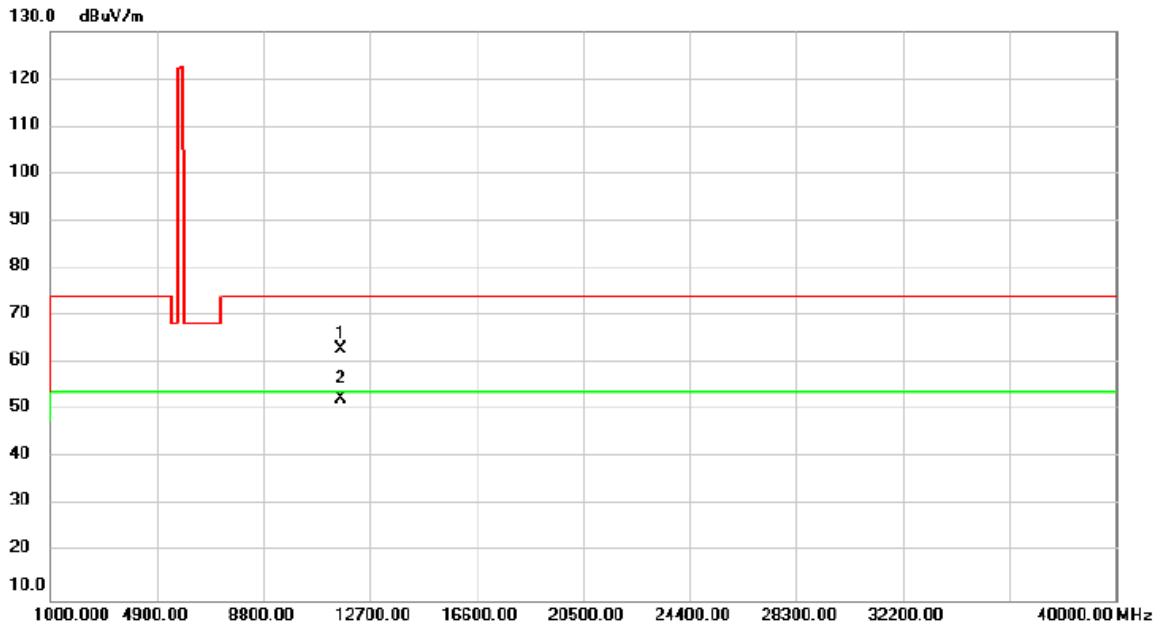

No.	Mk.	Freq. MHz	Reading Level dBuV	Correct Factor dB	Measure- ment dBuV/m	Limit dBuV/m	Over dB	Detector	Comment
1		11650.00	58.46	4.40	62.86	74.00	-11.14	peak	
2	*	11650.00	48.15	4.40	52.55	54.00	-1.45	AVG	

Test Mode	UNII-3_TX A Mode 5825MHz	Polarization	Horizontal
-----------	--------------------------	--------------	------------

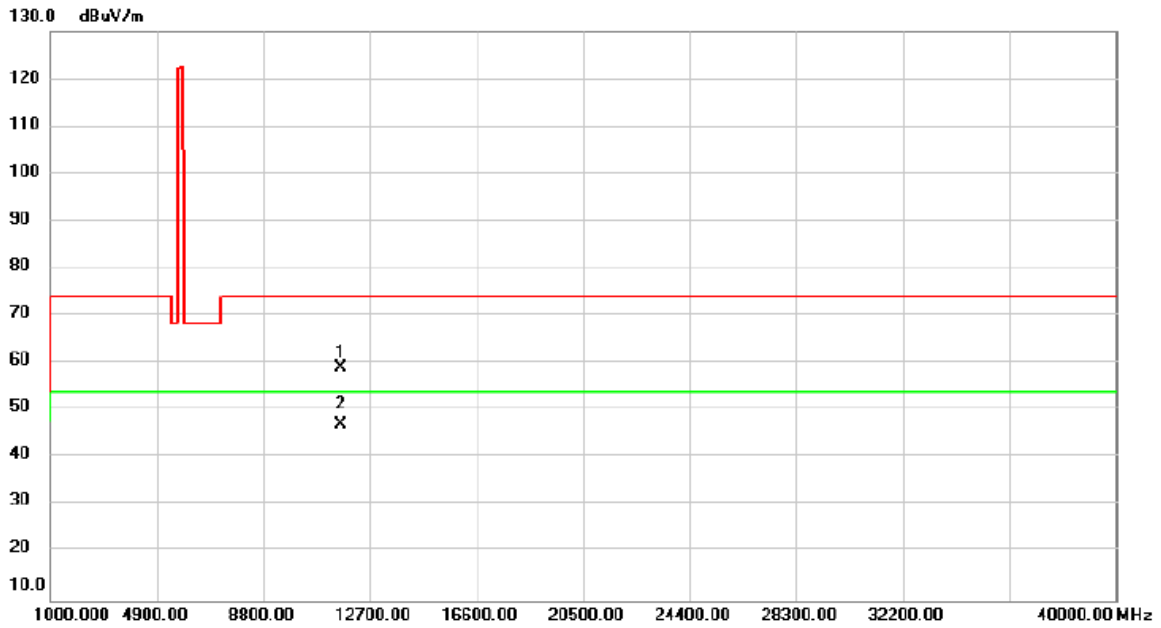

No.	Mk.	Freq. MHz	Reading Level dBuV	Correct Factor dB	Measure- ment dBuV/m	Limit dBuV/m	Over dB	Detector	Comment
1		11650.00	54.52	4.40	58.92	74.00	-15.08	peak	
2	*	11650.00	42.59	4.40	46.99	54.00	-7.01	AVG	

Test Mode	UNII-3_TX N (HT20) Mode 5745MHz	Polarization	Vertical
-----------	---------------------------------	--------------	----------

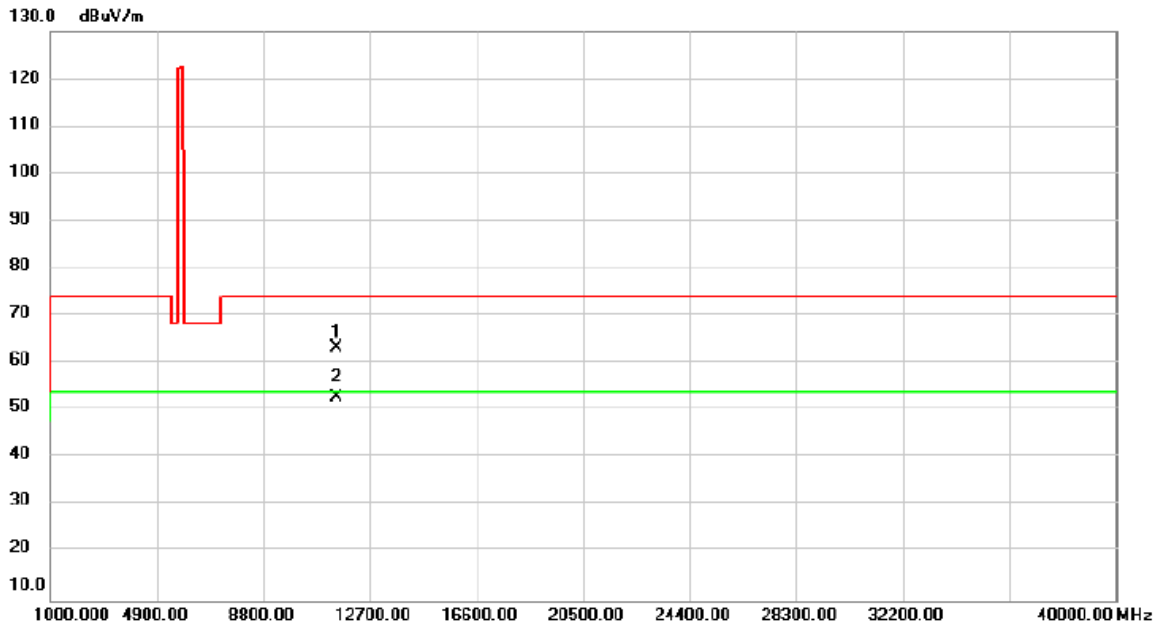

No.	Mk.	Freq. MHz	Reading Level dBuV	Correct Factor dB	Measure- ment dBuV/m	Limit dBuV/m	Over dB	Detector	Comment
1		11490.00	58.24	5.11	63.35	74.00	-10.65	peak	
2	*	11490.00	47.68	5.11	52.79	54.00	-1.21	AVG	

Test Mode	UNII-3_TX N (HT20) Mode 5745MHz	Polarization	Horizontal
-----------	---------------------------------	--------------	------------

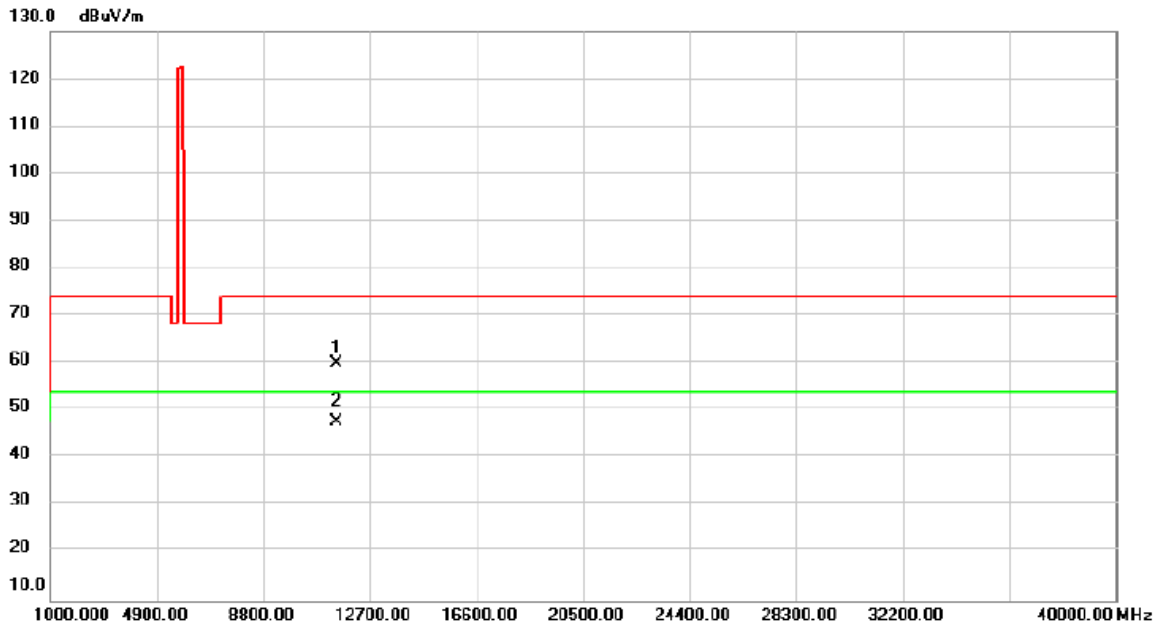

No.	Mk.	Freq. MHz	Reading Level dBuV	Correct Factor dB	Measure- ment dBuV/m	Limit dBuV/m	Over dB	Detector	Comment
1		11490.00	54.80	5.11	59.91	74.00	-14.09	peak	
2	*	11490.00	42.59	5.11	47.70	54.00	-6.30	AVG	

Test Mode	UNII-3_TX N (HT20) Mode 5785MHz	Polarization	Vertical
-----------	---------------------------------	--------------	----------

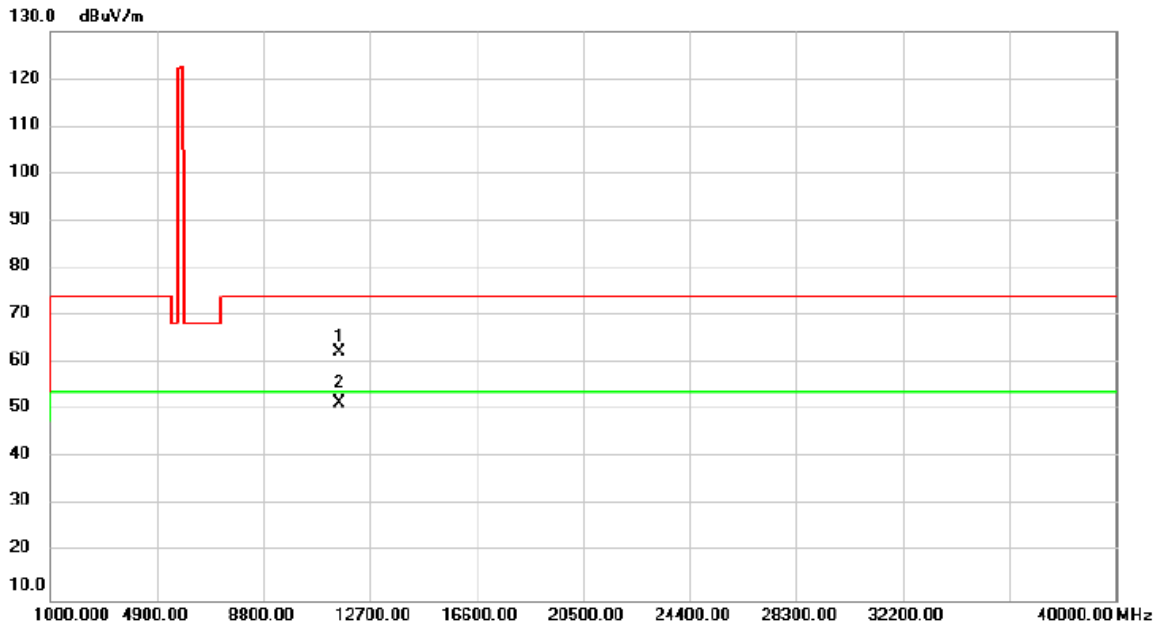

No.	Mk.	Freq. MHz	Reading Level dBuV	Correct Factor dB	Measure- ment dBuV/m	Limit dBuV/m	Over dB	Detector	Comment
1		11570.00	57.52	4.78	62.30	74.00	-11.70	peak	
2	*	11570.00	46.63	4.78	51.41	54.00	-2.59	AVG	

Test Mode	UNII-3_TX N (HT20) Mode 5785MHz	Polarization	Horizontal
-----------	---------------------------------	--------------	------------

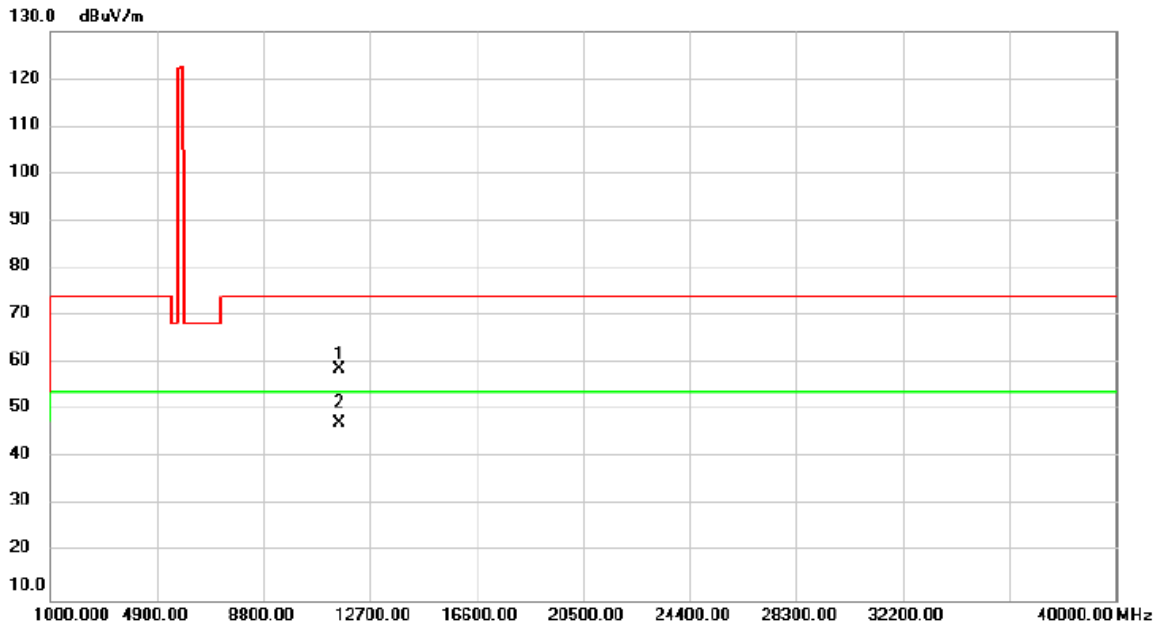

No.	Mk.	Freq. MHz	Reading Level dBuV	Correct Factor dB	Measure- ment dBuV/m	Limit dBuV/m	Over dB	Detector	Comment
1		11570.00	54.04	4.78	58.82	74.00	-15.18	peak	
2	*	11570.00	42.70	4.78	47.48	54.00	-6.52	AVG	

Test Mode	UNII-3_TX N (HT20) Mode 5825MHz	Polarization	Vertical
-----------	---------------------------------	--------------	----------

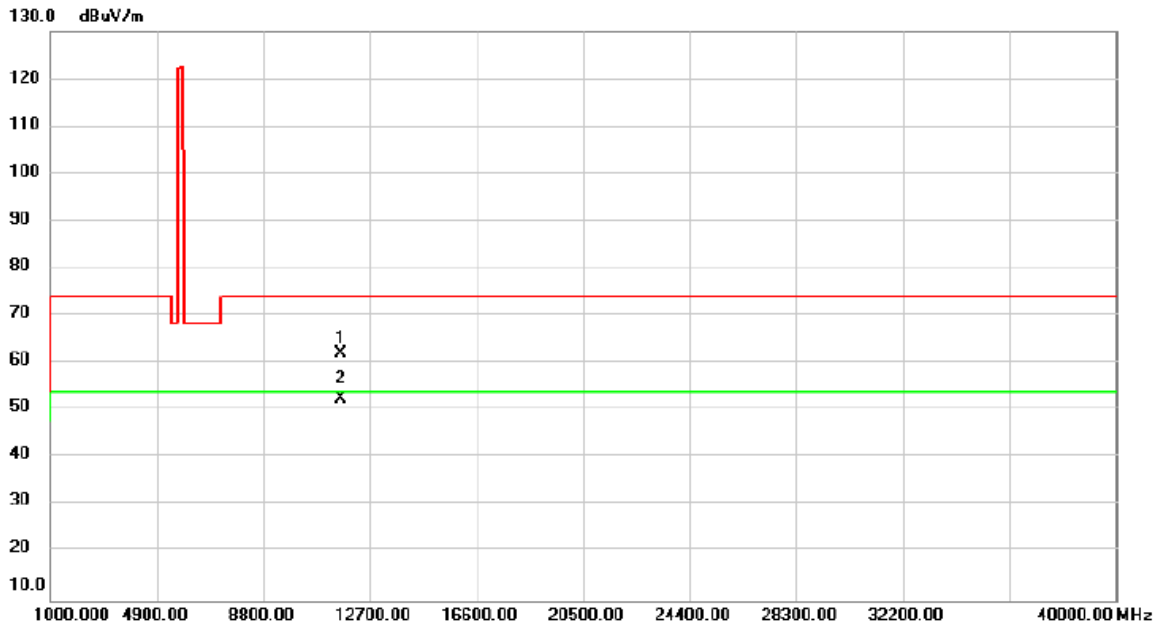

No.	Mk.	Freq. MHz	Reading Level dBuV	Correct Factor dB	Measure- ment dBuV/m	Limit dBuV/m	Over dB	Detector	Comment
1		11650.00	57.66	4.40	62.06	74.00	-11.94	peak	
2	*	11650.00	48.10	4.40	52.50	54.00	-1.50	AVG	

Test Mode	UNII-3_TX N (HT20) Mode 5825MHz	Polarization	Horizontal
-----------	---------------------------------	--------------	------------

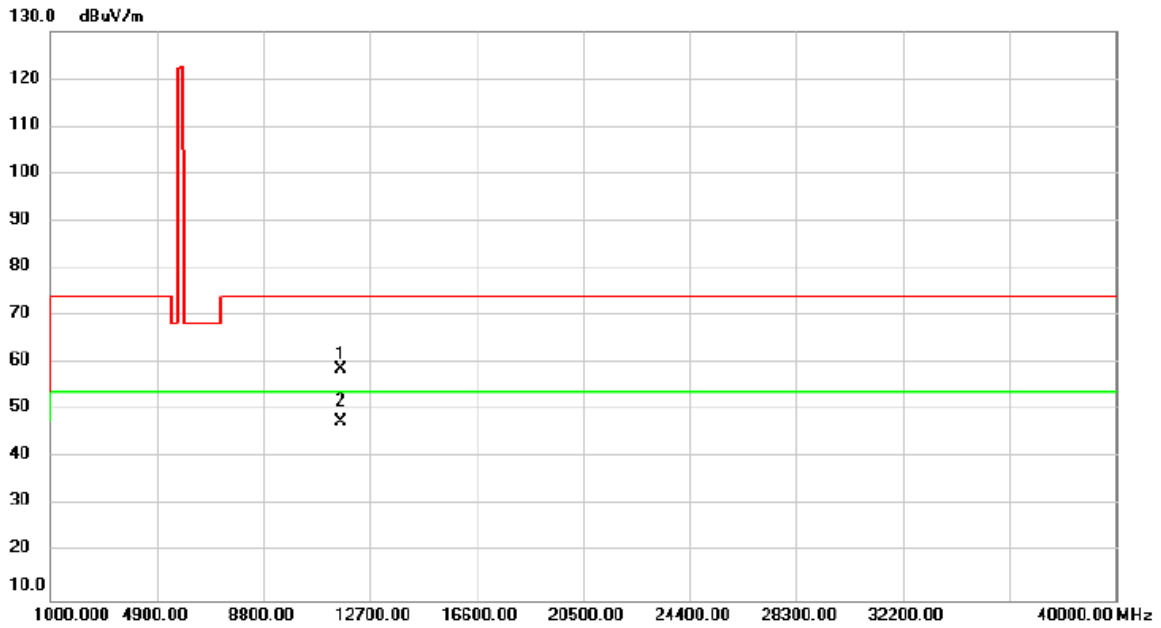

No.	Mk.	Freq. MHz	Reading Level dBuV	Correct Factor dB	Measure- ment dBuV/m	Limit dBuV/m	Over dB	Detector	Comment
1		11650.00	54.46	4.40	58.86	74.00	-15.14	peak	
2	*	11650.00	43.13	4.40	47.53	54.00	-6.47	AVG	

Test Mode	UNII-3_TX N (HT40) Mode 5755MHz	Polarization	Vertical
-----------	---------------------------------	--------------	----------

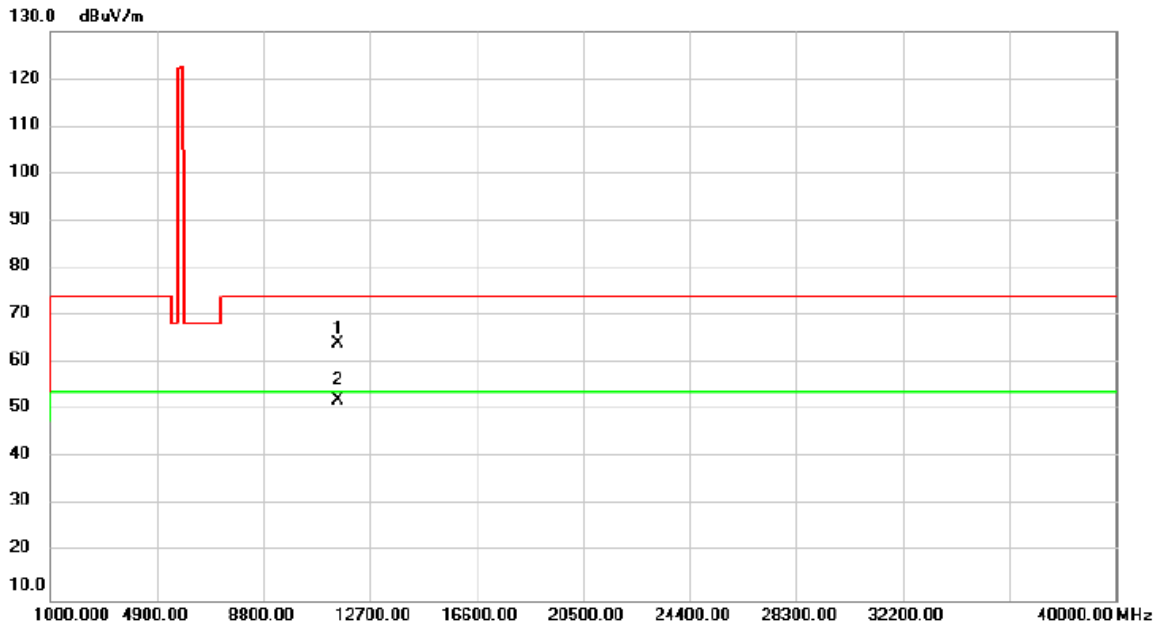

No.	Mk.	Freq. MHz	Reading Level dBuV	Correct Factor dB	Measure- ment dBuV/m	Limit dBuV/m	Over dB	Detector	Comment
1		11510.00	58.96	5.07	64.03	74.00	-9.97	peak	
2	*	11510.00	46.99	5.07	52.06	54.00	-1.94	AVG	

Test Mode	UNII-3_TX N (HT40) Mode 5755MHz	Polarization	Horizontal
-----------	---------------------------------	--------------	------------

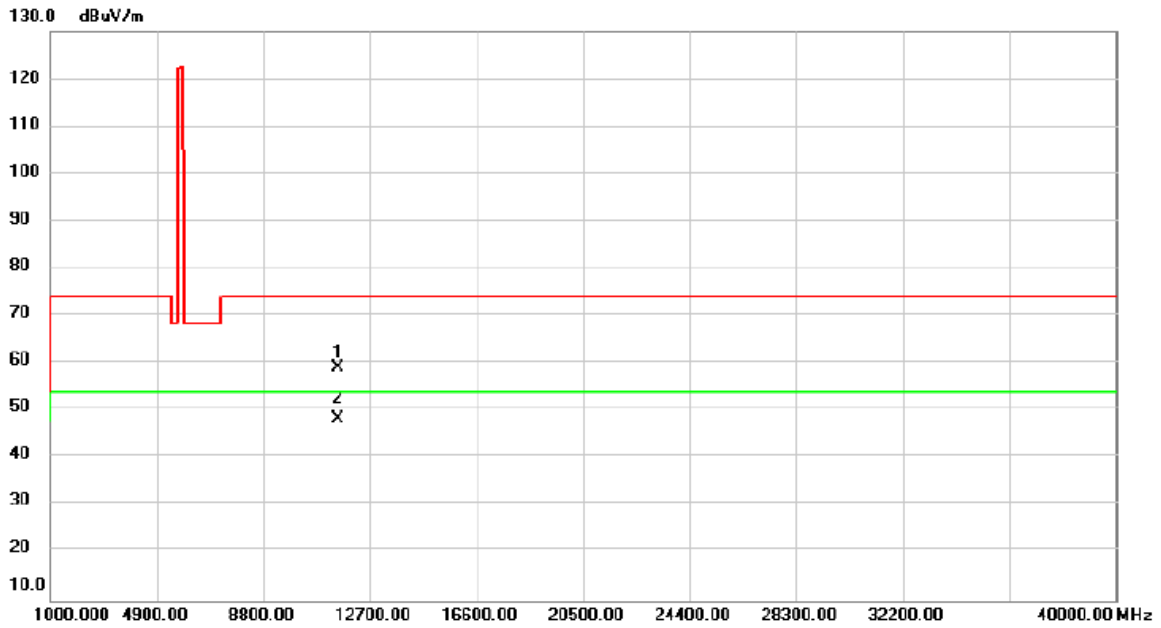

No.	Mk.	Freq. MHz	Reading Level dBuV	Correct Factor dB	Measure- ment dBuV/m	Limit dBuV/m	Over dB	Detector	Comment
1		11510.00	54.02	5.07	59.09	74.00	-14.91	peak	
2	*	11510.00	43.05	5.07	48.12	54.00	-5.88	AVG	

Test Mode	UNII-3_TX N (HT40) Mode 5795MHz	Polarization	Vertical
-----------	---------------------------------	--------------	----------

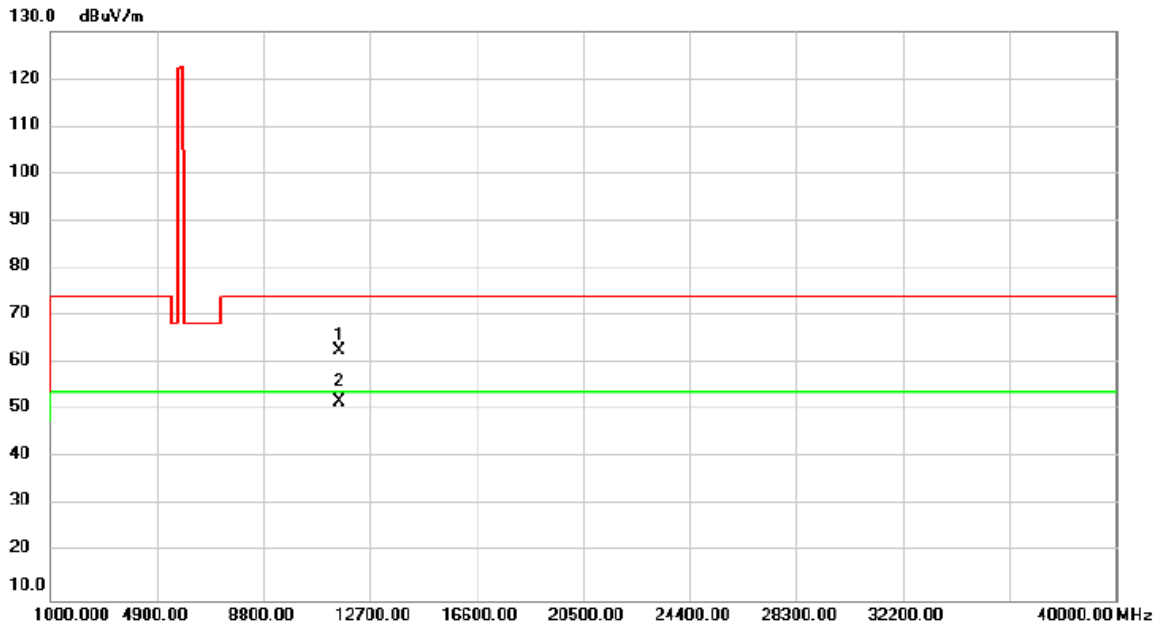

No.	Mk.	Freq. MHz	Reading Level dBuV	Correct Factor dB	Measure- ment dBuV/m	Limit dBuV/m	Over dB	Detector	Comment
1		11590.00	57.84	4.69	62.53	74.00	-11.47	peak	
2	*	11590.00	47.12	4.69	51.81	54.00	-2.19	AVG	

Test Mode	UNII-3_TX N (HT40) Mode 5795MHz	Polarization	Horizontal
-----------	---------------------------------	--------------	------------

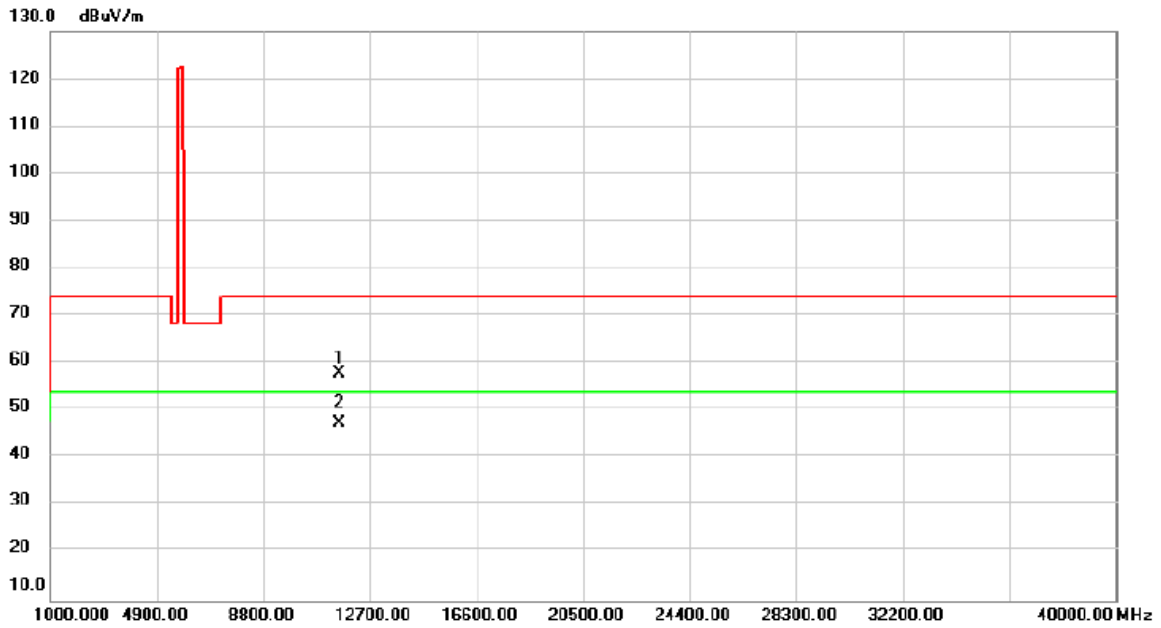

No.	Mk.	Freq. MHz	Reading Level dBuV	Correct Factor dB	Measure- ment dBuV/m	Limit dBuV/m	Over dB	Detector	Comment
1		11590.00	53.12	4.69	57.81	74.00	-16.19	peak	
2	*	11590.00	42.75	4.69	47.44	54.00	-6.56	AVG	

Test Mode	UNII-3_TX AC (VHT80) Mode 5775MHz	Polarization	Vertical
-----------	-----------------------------------	--------------	----------

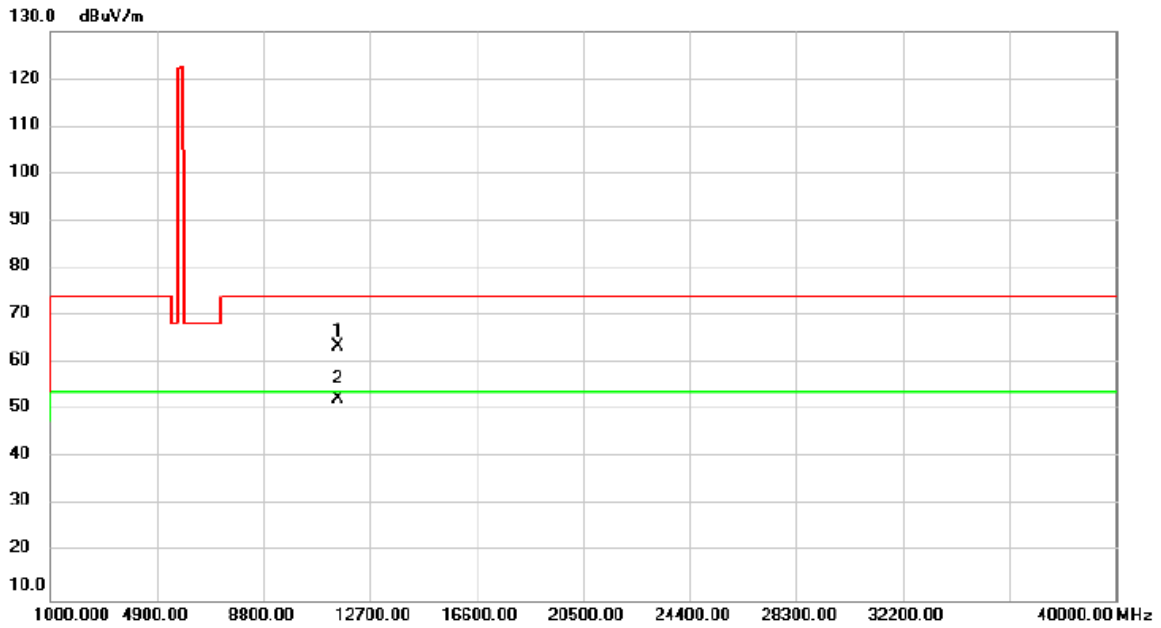

No.	Mk.	Freq. MHz	Reading Level dBuV	Correct Factor dB	Measure- ment dBuV/m	Limit dBuV/m	Over dB	Detector	Comment
1		11550.00	58.77	4.88	63.65	74.00	-10.35	peak	
2	*	11550.00	47.66	4.88	52.54	54.00	-1.46	AVG	

Test Mode	UNII-3_TX AC (VHT80) Mode 5775MHz	Polarization	Horizontal
-----------	-----------------------------------	--------------	------------

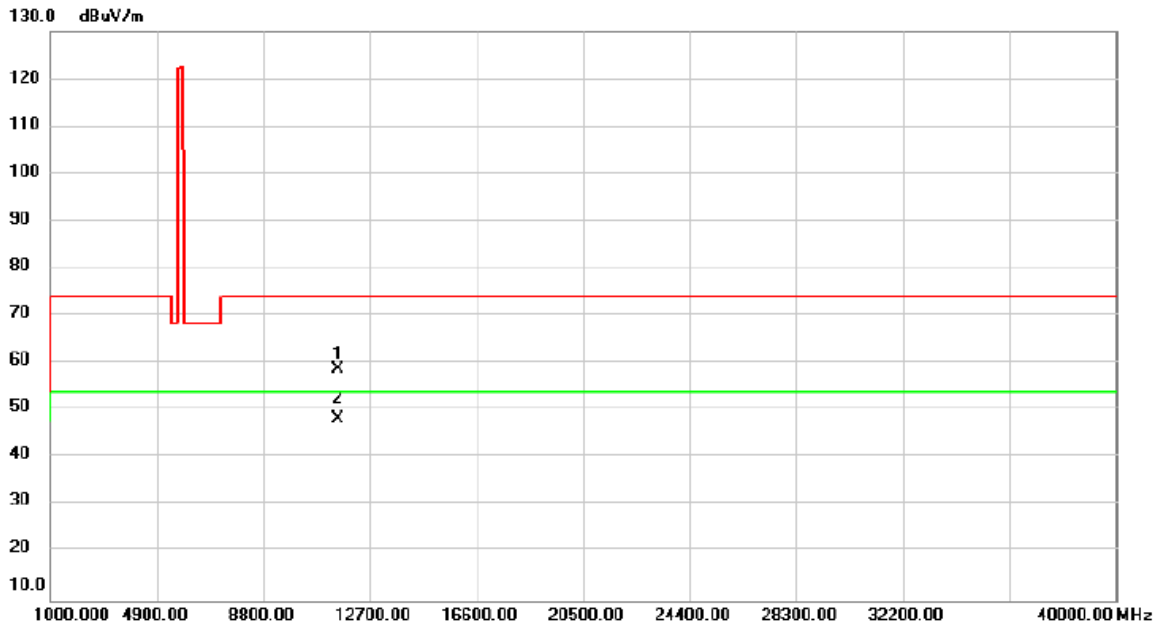

No.	Mk.	Freq. MHz	Reading Level dBuV	Correct Factor dB	Measure- ment dBuV/m	Limit dBuV/m	Over dB	Detector	Comment
1		11550.00	53.90	4.88	58.78	74.00	-15.22	peak	
2	*	11550.00	43.40	4.88	48.28	54.00	-5.72	AVG	

APPENDIX E BANDWIDTH

CONTINUE ON NEXT PAGE

Test Mode UNII-1_ IEEE 802.11a

Frequency (MHz)	26dB Bandwidth (MHz)	99% Occupied Bandwidth (MHz)
5180	19.81	17.70
5200	19.81	17.70
5240	19.91	17.70

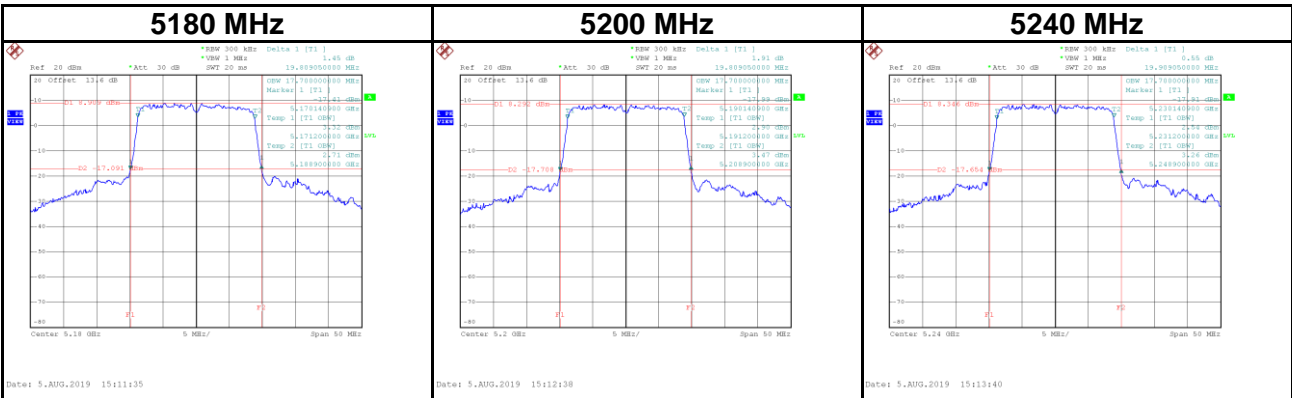

Test Mode UNII-1_ IEEE 802.11n (HT20)

Frequency (MHz)	26dB Bandwidth (MHz)	99% Occupied Bandwidth (MHz)
5180	19.80	17.70
5200	19.80	17.70
5240	18.85	17.70

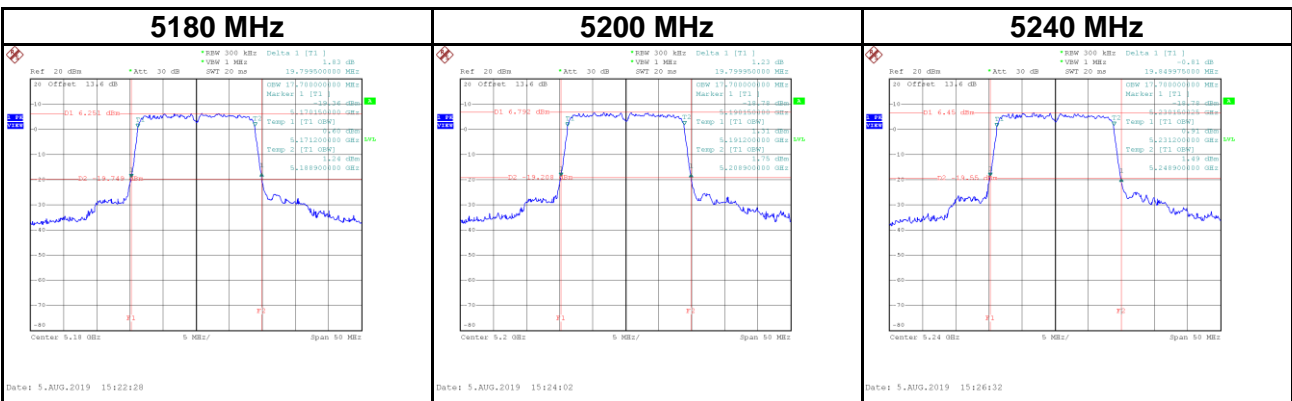

Test Mode	UNII-1_ IEEE 802.11n (HT40)
------------------	------------------------------------

Frequency (MHz)	26dB Bandwidth (MHz)	99% Occupied Bandwidth (MHz)
5190	43.01	36.60
5230	43.10	36.60

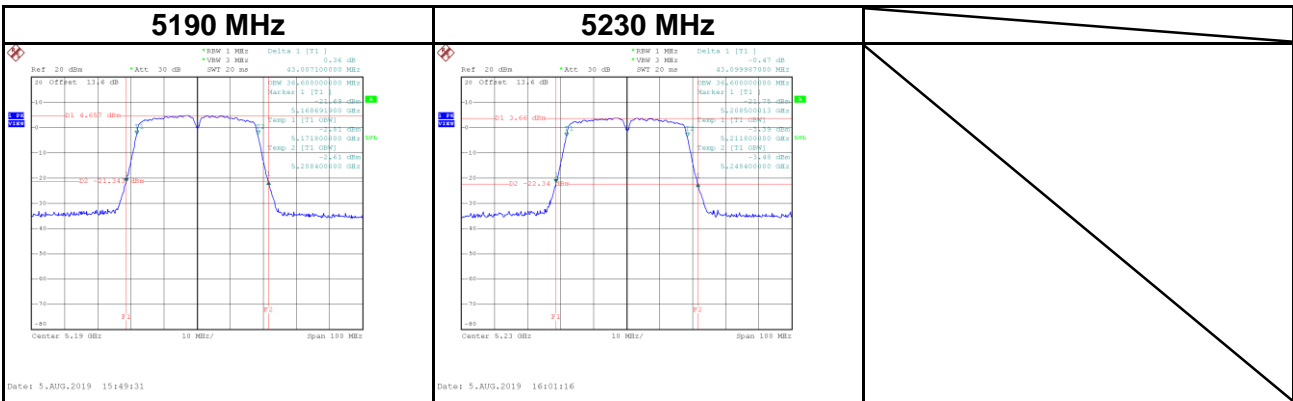

Test Mode	UNII-1_ IEEE 802.11ac (VHT80)
------------------	--------------------------------------

Frequency (MHz)	26dB Bandwidth (MHz)	99% Occupied Bandwidth (MHz)
5210	82.79	76.40

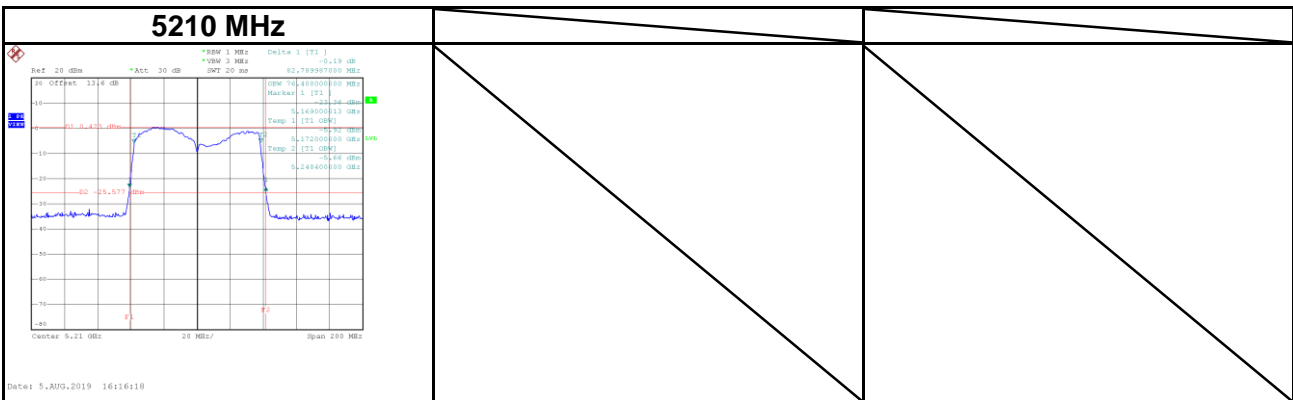

Test Mode UNII-3_ IEEE 802.11a

Frequency (MHz)	6dB Bandwidth (MHz)	99% Occupied Bandwidth (MHz)
5745	17.75	17.70
5785	17.65	17.60
5825	17.65	17.60

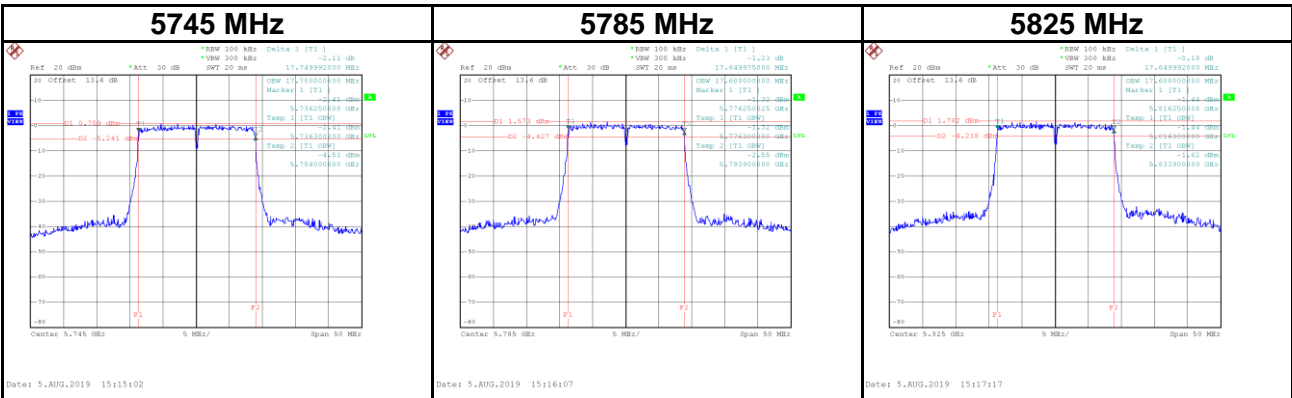

Test Mode UNII-3_ IEEE 802.11n (HT20)

Frequency (MHz)	6dB Bandwidth (MHz)	99% Occupied Bandwidth (MHz)
5745	17.75	17.60
5785	17.65	17.60
5825	17.69	17.60

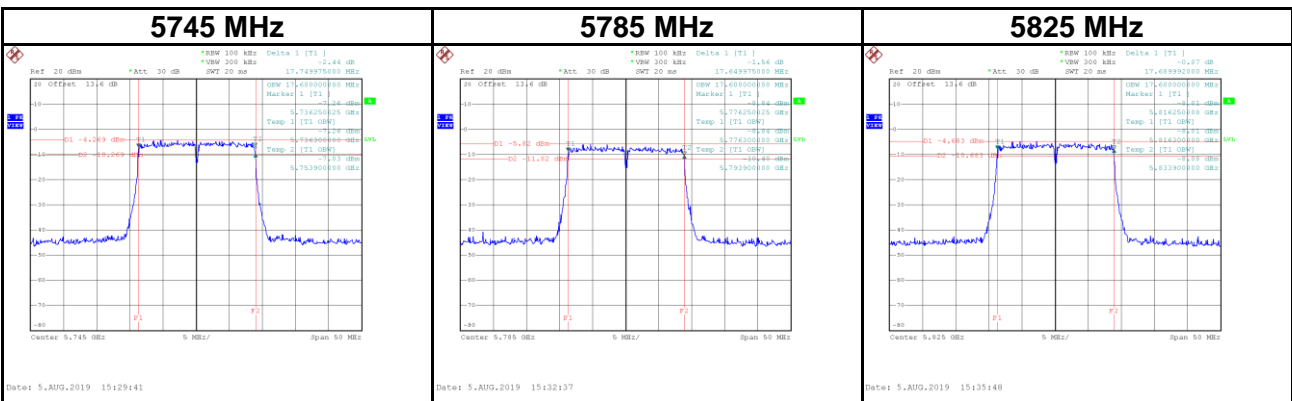

Test Mode UNII-3_ IEEE 802.11n (HT40)

Frequency (MHz)	6dB Bandwidth (MHz)	99% Occupied Bandwidth (MHz)
5755	36.80	36.40
5795	36.50	36.20

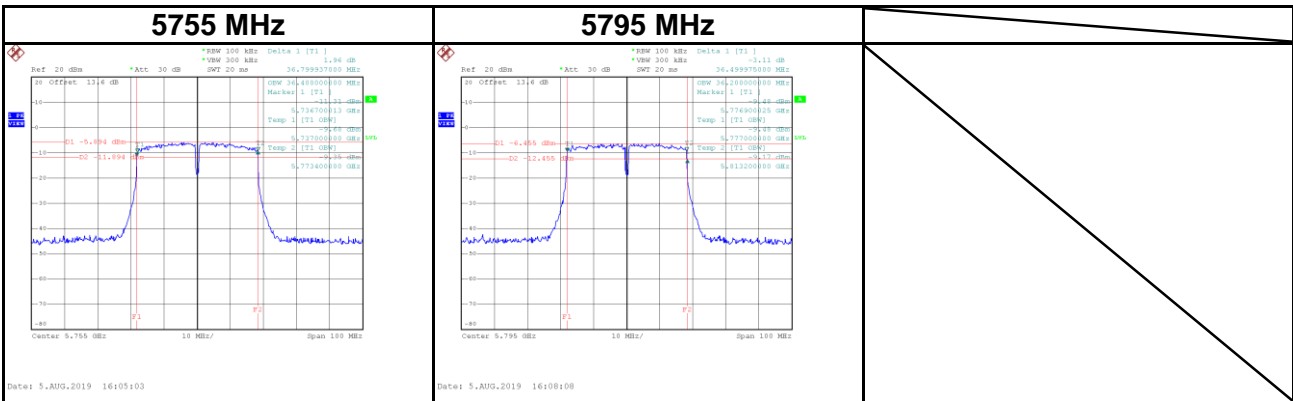

Test Mode UNII-3_ IEEE 802.11ac (VHT80)

Frequency (MHz)	6dB Bandwidth (MHz)	99% Occupied Bandwidth (MHz)
5775	76.80	75.60

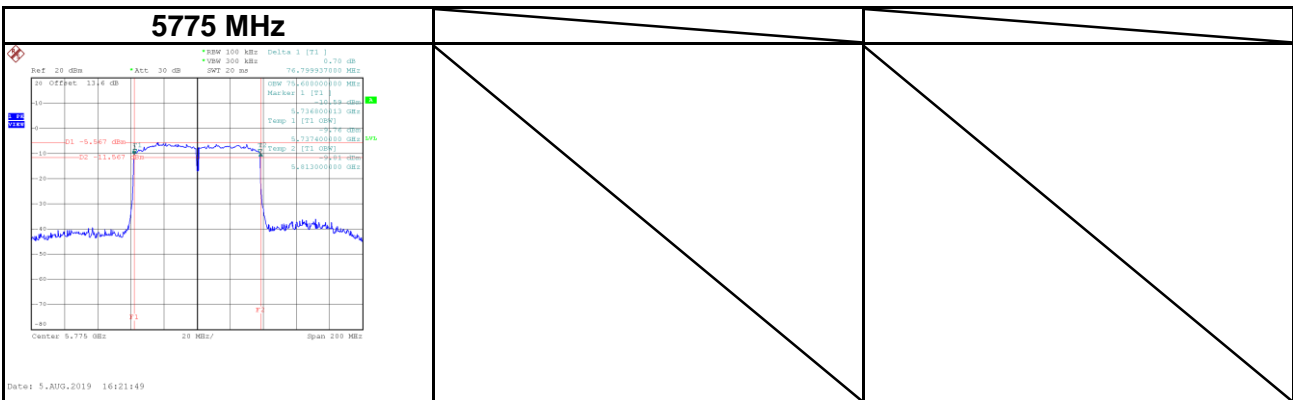

APPENDIX F CONDUCTED OUTPUT POWER**CONTINUE ON NEXT PAGE**

Test Mode	UNII-1_IEEE 802.11a_ANT 1
-----------	---------------------------

Frequency (MHz)	Conducted Power (dBm)	Conducted Power (W)	Max. Limit (dBm)	Max. Limit (W)	Result
5180	18.13	0.0650	30.00	1.0000	Complies
5200	17.94	0.0622	30.00	1.0000	Complies
5240	18.62	0.0728	30.00	1.0000	Complies

Test Mode	UNII-1_IIEEE 802.11n (HT20)_ANT 1
-----------	-----------------------------------

Frequency (MHz)	Conducted Power (dBm)	Conducted Power (W)	Max. Limit (dBm)	Max. Limit (W)	Result
5180	17.01	0.0502	30.00	1.0000	Complies
5200	16.61	0.0458	30.00	1.0000	Complies
5240	17.38	0.0547	30.00	1.0000	Complies

Test Mode	UNII-1_IIEEE 802.11n (HT20)_ANT 2
-----------	-----------------------------------

Frequency (MHz)	Conducted Power (dBm)	Conducted Power (W)	Max. Limit (dBm)	Max. Limit (W)	Result
5180	16.99	0.0500	30.00	1.0000	Complies
5200	16.50	0.0447	30.00	1.0000	Complies
5240	17.21	0.0526	30.00	1.0000	Complies

Test Mode	UNII-1_IIEEE 802.11n (HT20)_Total
-----------	-----------------------------------

Frequency (MHz)	Conducted Power (dBm)	Conducted Power (W)	Max. Limit (dBm)	Max. Limit (W)	Result
5180	20.01	0.1002	30.00	1.0000	Complies
5200	19.57	0.0905	30.00	1.0000	Complies
5240	20.31	0.1073	30.00	1.0000	Complies

Test Mode	UNII-1_IIEEE 802.11ac (VHT20)_ANT 1
-----------	-------------------------------------

Frequency (MHz)	Conducted Power (dBm)	Conducted Power (W)	Max. Limit (dBm)	Max. Limit (W)	Result
5180	16.81	0.0480	30.00	1.0000	Complies
5200	16.51	0.0448	30.00	1.0000	Complies
5240	17.01	0.0502	30.00	1.0000	Complies

Test Mode	UNII-1_IIEEE 802.11ac (VHT20)_ANT 2
-----------	-------------------------------------

Frequency (MHz)	Conducted Power (dBm)	Conducted Power (W)	Max. Limit (dBm)	Max. Limit (W)	Result
5180	16.87	0.0486	30.00	1.0000	Complies
5200	16.41	0.0438	30.00	1.0000	Complies
5240	16.99	0.0500	30.00	1.0000	Complies

Test Mode	UNII-1_IIEEE 802.11ac (VHT20)_Total
-----------	-------------------------------------

Frequency (MHz)	Conducted Power (dBm)	Conducted Power (W)	Max. Limit (dBm)	Max. Limit (W)	Result
5180	19.85	0.0966	30.00	1.0000	Complies
5200	19.47	0.0885	30.00	1.0000	Complies
5240	20.01	0.1002	30.00	1.0000	Complies

Test Mode	UNII-1_IIEEE 802.11n (HT40)_ANT 1
-----------	-----------------------------------

Frequency (MHz)	Conducted Power (dBm)	Conducted Power (W)	Max. Limit (dBm)	Max. Limit (W)	Result
5190	11.41	0.0138	30.00	1.0000	Complies
5230	10.62	0.0115	30.00	1.0000	Complies

Test Mode	UNII-1_IIEEE 802.11n (HT40)_ANT 2
-----------	-----------------------------------

Frequency (MHz)	Conducted Power (dBm)	Conducted Power (W)	Max. Limit (dBm)	Max. Limit (W)	Result
5190	11.32	0.0136	30.00	1.0000	Complies
5230	10.17	0.0104	30.00	1.0000	Complies

Test Mode	UNII-1_IIEEE 802.11n (HT40)_Total
-----------	-----------------------------------

Frequency (MHz)	Conducted Power (dBm)	Conducted Power (W)	Max. Limit (dBm)	Max. Limit (W)	Result
5190	14.38	0.0274	30.00	1.0000	Complies
5230	13.41	0.0219	30.00	1.0000	Complies

Test Mode	UNII-1_IIEEE 802.11ac (VHT40)_ANT 1
-----------	-------------------------------------

Frequency (MHz)	Conducted Power (dBm)	Conducted Power (W)	Max. Limit (dBm)	Max. Limit (W)	Result
5190	11.29	0.0135	30.00	1.0000	Complies
5230	9.74	0.0094	30.00	1.0000	Complies

Test Mode	UNII-1_IIEEE 802.11ac (VHT40)_ANT 2
-----------	-------------------------------------

Frequency (MHz)	Conducted Power (dBm)	Conducted Power (W)	Max. Limit (dBm)	Max. Limit (W)	Result
5190	11.21	0.0132	30.00	1.0000	Complies
5230	9.52	0.0090	30.00	1.0000	Complies

Test Mode	UNII-1_IIEEE 802.11ac (VHT40)_Total
-----------	-------------------------------------

Frequency (MHz)	Conducted Power (dBm)	Conducted Power (W)	Max. Limit (dBm)	Max. Limit (W)	Result
5190	14.26	0.0267	30.00	1.0000	Complies
5230	12.64	0.0184	30.00	1.0000	Complies

Test Mode	UNII-1_IIEEE 802.11ac (VHT80)_ANT 1
-----------	-------------------------------------

Frequency (MHz)	Conducted Power (dBm)	Conducted Power (W)	Max. Limit (dBm)	Max. Limit (W)	Result
5210	8.72	0.0074	30.00	1.0000	Complies

Test Mode	UNII-1_IIEEE 802.11ac (VHT80)_ANT 2
-----------	-------------------------------------

Frequency (MHz)	Conducted Power (dBm)	Conducted Power (W)	Max. Limit (dBm)	Max. Limit (W)	Result
5210	9.05	0.0080	30.00	1.0000	Complies

Test Mode	UNII-1_IIEEE 802.11ac (VHT80)_Total
-----------	-------------------------------------

Frequency (MHz)	Conducted Power (dBm)	Conducted Power (W)	Max. Limit (dBm)	Max. Limit (W)	Result
5210	11.90	0.0155	30.00	1.0000	Complies

Test Mode	UNII-3_IEEE 802.11a_ANT 1
-----------	---------------------------

Frequency (MHz)	Conducted Power (dBm)	Conducted Power (W)	Max. Limit (dBm)	Max. Limit (W)	Result
5745	15.17	0.0329	30.00	1.0000	Complies
5785	15.91	0.0390	30.00	1.0000	Complies
5825	16.01	0.0399	30.00	1.0000	Complies

Test Mode	UNII-3_IIEEE 802.11n (HT20)_ANT 1
-----------	-----------------------------------

Frequency (MHz)	Conducted Power (dBm)	Conducted Power (W)	Max. Limit (dBm)	Max. Limit (W)	Result
5745	10.21	0.0105	30.00	1.0000	Complies
5785	9.81	0.0096	30.00	1.0000	Complies
5825	9.14	0.0082	30.00	1.0000	Complies

Test Mode	UNII-3_IIEEE 802.11n (HT20)_ANT 2
-----------	-----------------------------------

Frequency (MHz)	Conducted Power (dBm)	Conducted Power (W)	Max. Limit (dBm)	Max. Limit (W)	Result
5745	10.49	0.0112	30.00	1.0000	Complies
5785	9.94	0.0099	30.00	1.0000	Complies
5825	9.38	0.0087	30.00	1.0000	Complies

Test Mode	UNII-3_IIEEE 802.11n (HT20)_Total
-----------	-----------------------------------

Frequency (MHz)	Conducted Power (dBm)	Conducted Power (W)	Max. Limit (dBm)	Max. Limit (W)	Result
5745	13.36	0.0217	30.00	1.0000	Complies
5785	12.89	0.0194	30.00	1.0000	Complies
5825	12.27	0.0169	30.00	1.0000	Complies

Test Mode	UNII-3_IIEEE 802.11ac (VHT20)_ANT 1
-----------	-------------------------------------

Frequency (MHz)	Conducted Power (dBm)	Conducted Power (W)	Max. Limit (dBm)	Max. Limit (W)	Result
5745	10.45	0.0111	30.00	1.0000	Complies
5785	9.52	0.0090	30.00	1.0000	Complies
5825	8.91	0.0078	30.00	1.0000	Complies

Test Mode	UNII-3_IIEEE 802.11ac (VHT20)_ANT 2
-----------	-------------------------------------

Frequency (MHz)	Conducted Power (dBm)	Conducted Power (W)	Max. Limit (dBm)	Max. Limit (W)	Result
5745	10.15	0.0104	30.00	1.0000	Complies
5785	9.77	0.0095	30.00	1.0000	Complies
5825	9.51	0.0089	30.00	1.0000	Complies

Test Mode	UNII-3_IIEEE 802.11ac (VHT20)_Total
-----------	-------------------------------------

Frequency (MHz)	Conducted Power (dBm)	Conducted Power (W)	Max. Limit (dBm)	Max. Limit (W)	Result
5745	13.31	0.0214	30.00	1.0000	Complies
5785	12.66	0.0184	30.00	1.0000	Complies
5825	12.23	0.0167	30.00	1.0000	Complies

Test Mode	UNII-3_ IEEE 802.11n (HT40)_ANT 1
-----------	-----------------------------------

Frequency (MHz)	Conducted Power (dBm)	Conducted Power (W)	Max. Limit (dBm)	Max. Limit (W)	Result
5755	11.33	0.0136	30.00	1.0000	Complies
5795	11.99	0.0158	30.00	1.0000	Complies

Test Mode	UNII-3_ IEEE 802.11n (HT40)_ANT 2
-----------	-----------------------------------

Frequency (MHz)	Conducted Power (dBm)	Conducted Power (W)	Max. Limit (dBm)	Max. Limit (W)	Result
5755	11.38	0.0137	30.00	1.0000	Complies
5795	12.35	0.0172	30.00	1.0000	Complies

Test Mode	UNII-3_ IEEE 802.11n (HT40)_Total
-----------	-----------------------------------

Frequency (MHz)	Conducted Power (dBm)	Conducted Power (W)	Max. Limit (dBm)	Max. Limit (W)	Result
5755	14.37	0.0273	30.00	1.0000	Complies
5795	15.18	0.0330	30.00	1.0000	Complies

Test Mode	UNII-3_IIEEE 802.11ac (VHT40)_ANT 1
-----------	-------------------------------------

Frequency (MHz)	Conducted Power (dBm)	Conducted Power (W)	Max. Limit (dBm)	Max. Limit (W)	Result
5755	10.87	0.0122	30.00	1.0000	Complies
5795	11.48	0.0141	30.00	1.0000	Complies

Test Mode	UNII-3_IIEEE 802.11ac (VHT40)_ANT 2
-----------	-------------------------------------

Frequency (MHz)	Conducted Power (dBm)	Conducted Power (W)	Max. Limit (dBm)	Max. Limit (W)	Result
5755	11.71	0.0148	30.00	1.0000	Complies
5795	12.44	0.0175	30.00	1.0000	Complies

Test Mode	UNII-3_IIEEE 802.11ac (VHT40)_Total
-----------	-------------------------------------

Frequency (MHz)	Conducted Power (dBm)	Conducted Power (W)	Max. Limit (dBm)	Max. Limit (W)	Result
5755	14.32	0.0270	30.00	1.0000	Complies
5795	15.00	0.0316	30.00	1.0000	Complies

Test Mode	UNII-3_IIEEE 802.11ac (VHT80)_ANT 1				
-----------	-------------------------------------	--	--	--	--

Frequency (MHz)	Conducted Power (dBm)	Conducted Power (W)	Max. Limit (dBm)	Max. Limit (W)	Result
5775	13.98	0.0250	30.00	1.0000	Complies

Test Mode	UNII-3_IIEEE 802.11ac (VHT80)_ANT 2				
-----------	-------------------------------------	--	--	--	--

Frequency (MHz)	Conducted Power (dBm)	Conducted Power (W)	Max. Limit (dBm)	Max. Limit (W)	Result
5775	14.07	0.0255	30.00	1.0000	Complies

Test Mode	UNII-3_IIEEE 802.11ac (VHT80)_Total				
-----------	-------------------------------------	--	--	--	--

Frequency (MHz)	Conducted Power (dBm)	Conducted Power (W)	Max. Limit (dBm)	Max. Limit (W)	Result
5775	17.04	0.0505	30.00	1.0000	Complies

APPENDIX G POWER SPECTRAL DENSITY**CONTINUE ON NEXT PAGE**

Test Mode UNII-1_ IEEE 802.11a_ANT 1

Frequency (MHz)	Power Density (dBm/MHz)	Duty Factor (dB)	Power Density+ Duty Factor (dBm/MHz)	Limit (dBm/MHz)	Result
5180	5.63	0	5.63	17.00	Complies
5200	5.15	0	5.15	17.00	Complies
5240	5.27	0	5.27	17.00	Complies

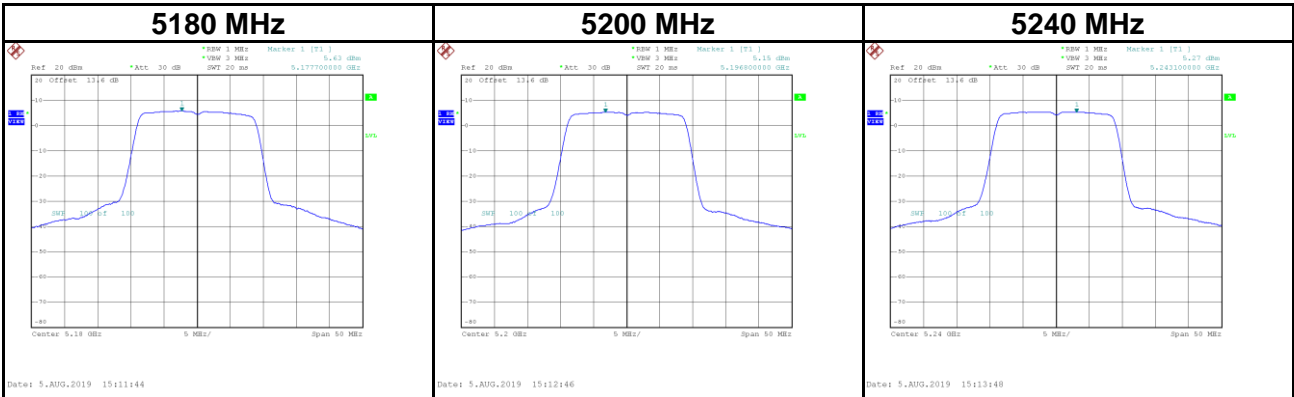

Test Mode UNII-1_ IEEE 802.11n (HT20)_ANT 1

Frequency (MHz)	Power Density (dBm/MHz)	Duty Factor (dB)	Power Density+ Duty Factor (dBm/MHz)	Limit (dBm/MHz)	Result
5180	3.41	0	3.41	14.67	Complies
5200	3.48	0	3.48	14.67	Complies
5240	3.28	0	3.28	14.67	Complies

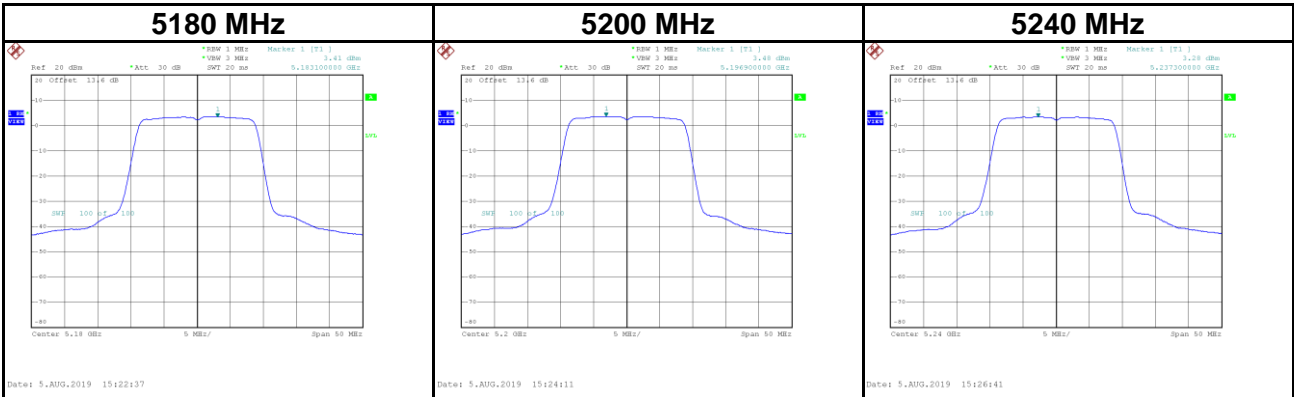

Test Mode UNII-1_ IEEE 802.11n (HT20)_ANT 2

Frequency (MHz)	Power Density (dBm/MHz)	Duty Factor (dB)	Power Density+ Duty Factor (dBm/MHz)	Limit (dBm/MHz)	Result
5180	5.32	0	5.32	14.67	Complies
5200	5.84	0	5.84	14.67	Complies
5240	5.38	0	5.38	14.67	Complies

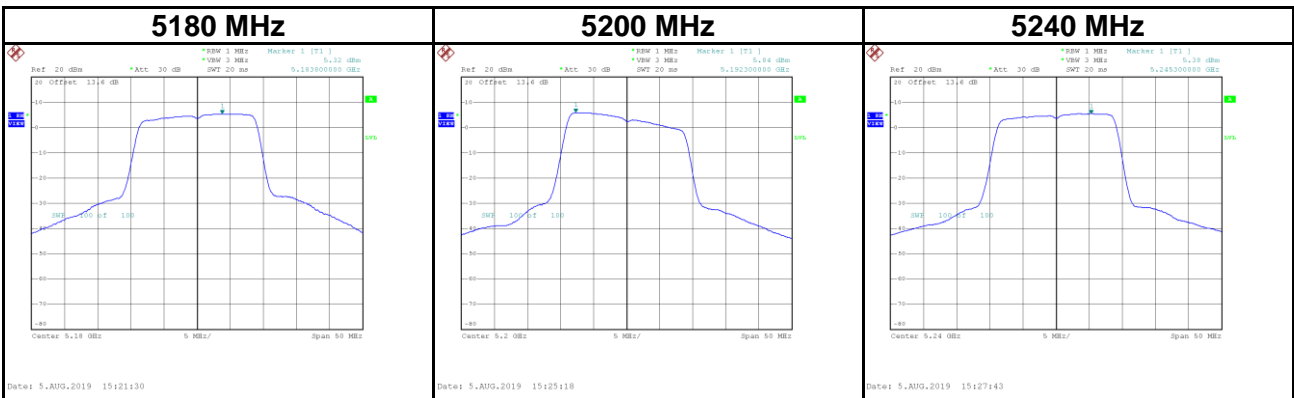

Test Mode	UNII-1_ IEEE 802.11n (HT20)_Total
-----------	-----------------------------------

Frequency (MHz)	Power Density (dBm/MHz)	Duty Factor (dB)	Power Density+ Duty Factor (dBm/MHz)	Limit (dBm/MHz)	Result
5180	7.48	0	7.48	14.67	Complies
5200	7.83	0	7.83	14.67	Complies
5240	7.47	0	7.47	14.67	Complies

Test Mode UNII-1_ IEEE 802.11n (HT40)_ANT 1

Frequency (MHz)	Power Density (dBm/MHz)	Duty Factor (dB)	Power Density+ Duty Factor (dBm/MHz)	Limit (dBm/MHz)	Result
5190	-4.39	0	-4.39	14.67	Complies
5230	-5.51	0	-5.51	14.67	Complies

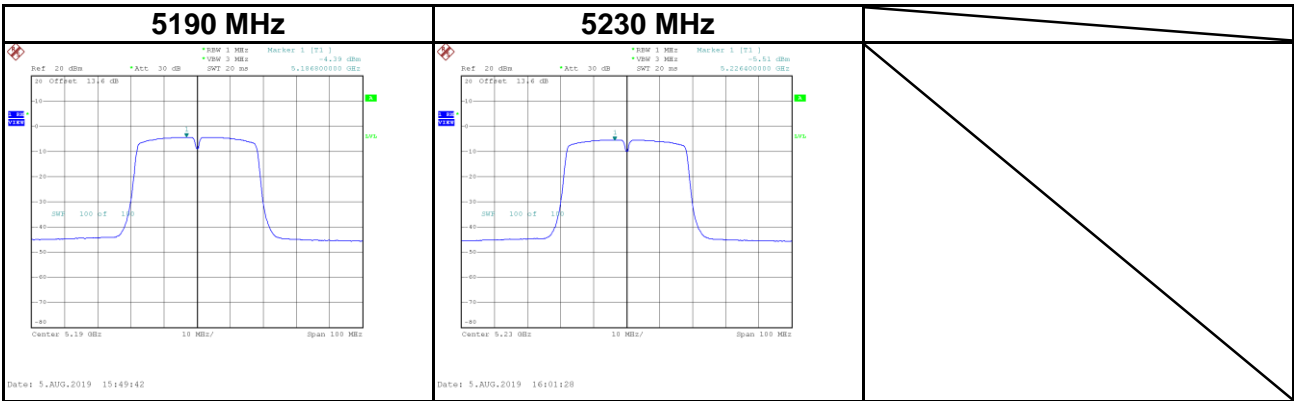

Test Mode UNII-1_ IEEE 802.11n (HT40)_ANT 2

Frequency (MHz)	Power Density (dBm/MHz)	Duty Factor (dB)	Power Density+ Duty Factor (dBm/MHz)	Limit (dBm/MHz)	Result
5190	-3.16	0	-3.16	14.67	Complies
5230	-4.37	0	-4.37	14.67	Complies

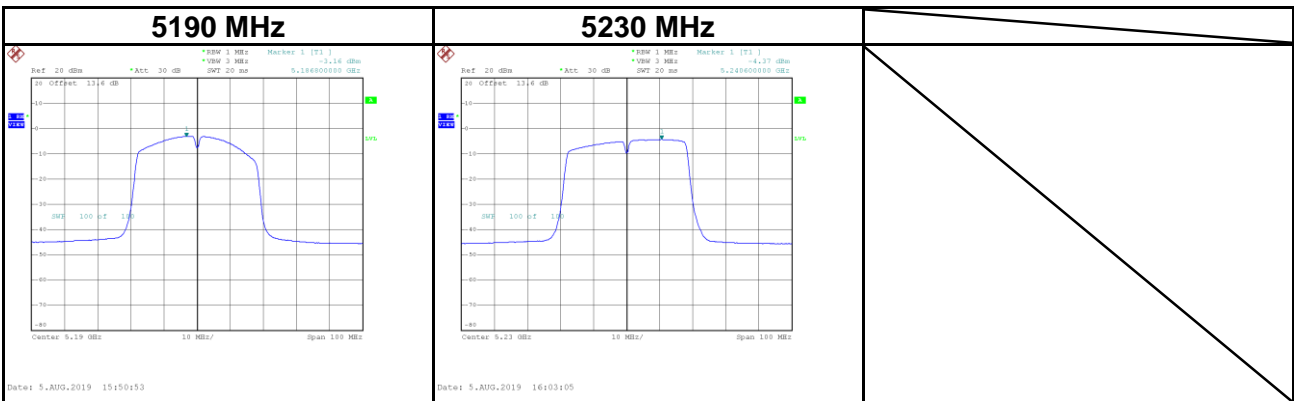

Test Mode UNII-1_ IEEE 802.11n (HT40)_Total

Frequency (MHz)	Power Density (dBm/MHz)	Duty Factor (dB)	Power Density+ Duty Factor (dBm/MHz)	Limit (dBm/MHz)	Result
5190	-0.72	0	-0.72	14.67	Complies
5230	-1.89	0	-1.89	14.67	Complies

Test Mode UNII-1_ IEEE 802.11ac (VHT80)_ANT 1

Frequency (MHz)	Power Density (dBm/MHz)	Duty Factor (dB)	Power Density+ Duty Factor (dBm/MHz)	Limit (dBm/MHz)	Result
5210	-8.53	0	-8.53	14.67	Complies

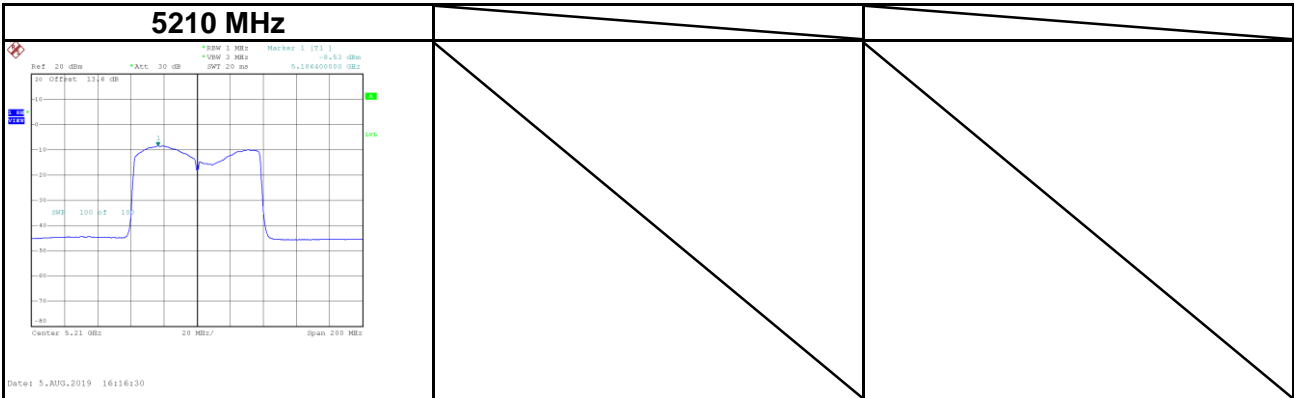

Test Mode UNII-1_ IEEE 802.11ac (VHT80)_ANT 2

Frequency (MHz)	Power Density (dBm/MHz)	Duty Factor (dB)	Power Density+ Duty Factor (dBm/MHz)	Limit (dBm/MHz)	Result
5210	-8.44	0	-8.44	14.67	Complies

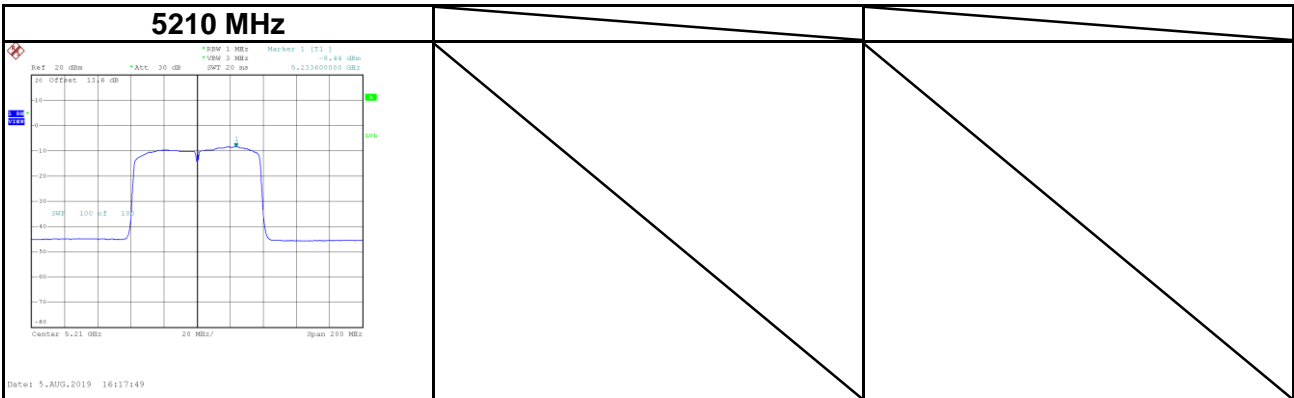

Test Mode UNII-1_ IEEE 802.11ac (VHT80)_Total

Frequency (MHz)	Power Density (dBm/MHz)	Duty Factor (dB)	Power Density+ Duty Factor (dBm/MHz)	Limit (dBm/MHz)	Result
5210	-5.47	0	-5.47	14.67	Complies

Test Mode UNII-3_ IEEE 802.11a_ANT 1

Frequency (MHz)	Power Density (dBm/500 kHz)	Duty Factor (dB)	Power Density+ Duty Factor (dBm/500 kHz)	Limit (dBm/500 kHz)	Result
5745	0.45	0	0.45	30.00	Complies
5785	0.88	0	0.88	30.00	Complies
5825	1.10	0	1.10	30.00	Complies

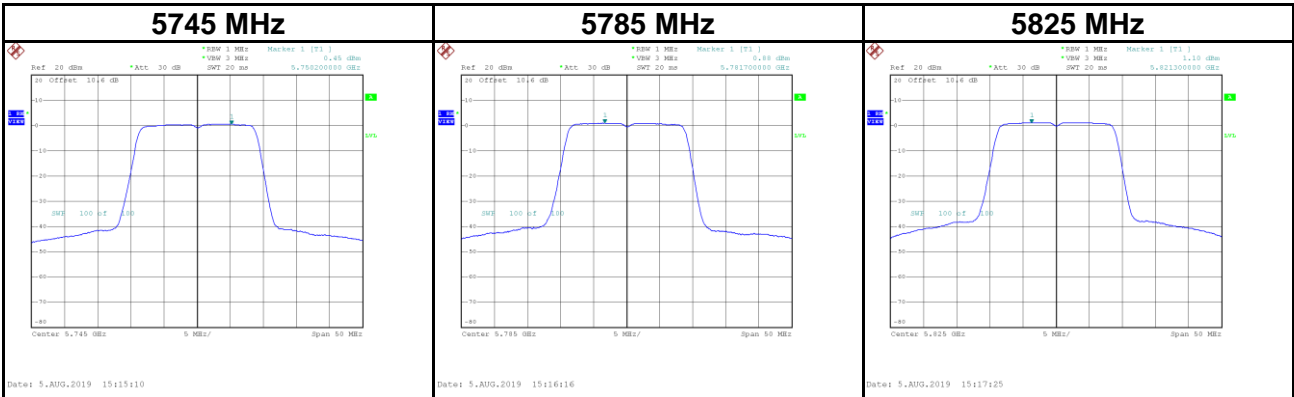

Test Mode UNII-3_IEEE 802.11n (HT20)_ANT 1

Frequency (MHz)	Power Density (dBm/500 kHz)	Duty Factor (dB)	Power Density+ Duty Factor (dBm/500 kHz)	Limit (dBm/500 kHz)	Result
5745	-4.82	0	-4.82	27.67	Complies
5785	-6.71	0	-6.71	27.67	Complies
5825	-5.50	0	-5.50	27.67	Complies

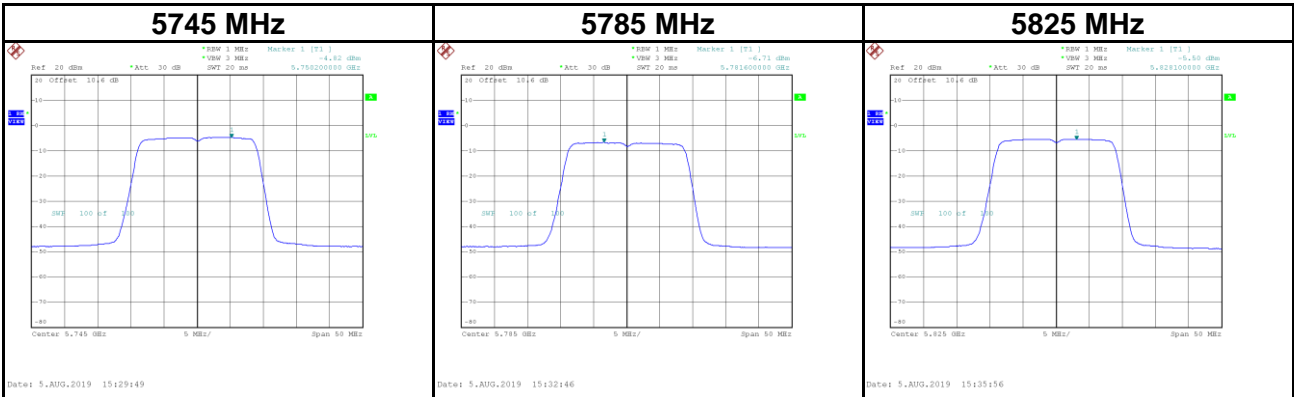

Test Mode UNII-3_IEEE 802.11n (HT20)_ANT 2

Frequency (MHz)	Power Density (dBm/500 kHz)	Duty Factor (dB)	Power Density+ Duty Factor (dBm/500 kHz)	Limit (dBm/500 kHz)	Result
5745	-4.41	0	-4.41	27.67	Complies
5785	-2.99	0	-2.99	27.67	Complies
5825	-4.41	0	-4.41	27.67	Complies

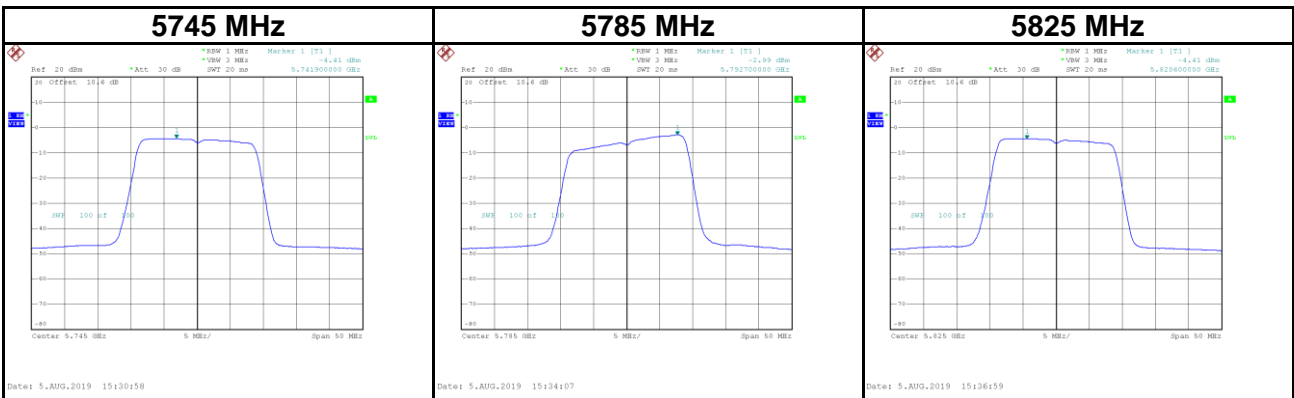

Test Mode	UNII-3_ IEEE 802.11n (HT20)_Total
-----------	-----------------------------------

Frequency (MHz)	Power Density (dBm/500 kHz)	Duty Factor (dB)	Power Density+ Duty Factor (dBm/500 kHz)	Limit (dBm/500 kHz)	Result
5745	-1.60	0	-1.60	27.67	Complies
5785	-1.45	0	-1.45	27.67	Complies
5825	-1.91	0	-1.91	27.67	Complies

Test Mode UNII-3_ IEEE 802.11n (HT40)_ANT 1

Frequency (MHz)	Power Density (dBm/500 kHz)	Duty Factor (dB)	Power Density+ Duty Factor (dBm/500 kHz)	Limit (dBm/500 kHz)	Result
5755	-6.01	0	-6.01	27.67	Complies
5795	-6.51	0	-6.51	27.67	Complies

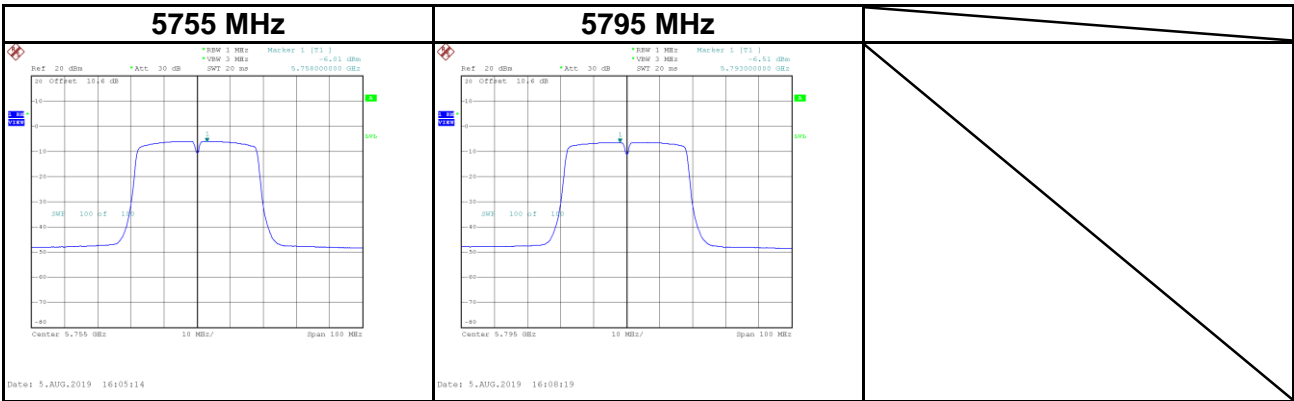

Test Mode UNII-3_ IEEE 802.11n (HT40)_ANT 2

Frequency (MHz)	Power Density (dBm/500 kHz)	Duty Factor (dB)	Power Density+ Duty Factor (dBm/500 kHz)	Limit (dBm/500 kHz)	Result
5755	-5.36	0	-5.36	27.67	Complies
5795	-4.68	0	-4.68	27.67	Complies

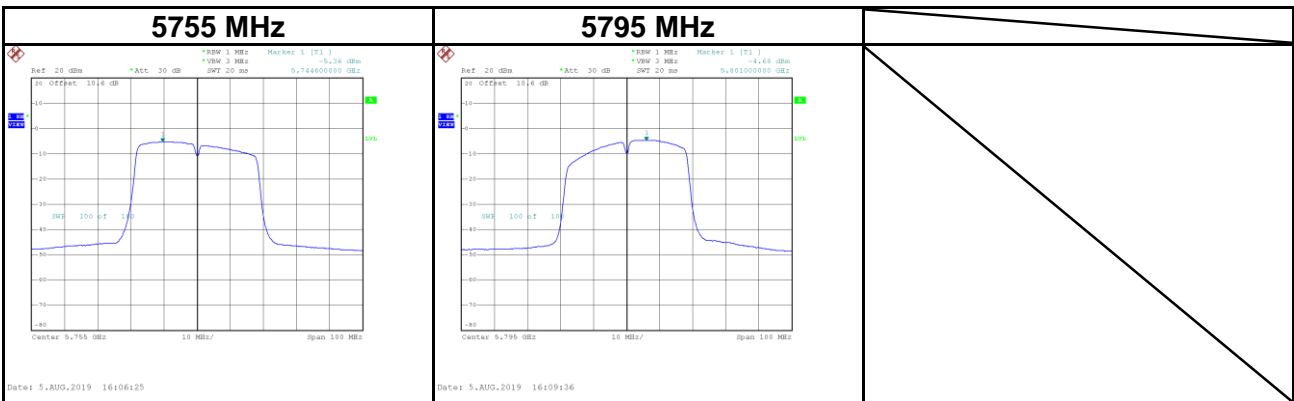

Test Mode UNII-3_ IEEE 802.11n (HT40)_Total

Frequency (MHz)	Power Density (dBm/500 kHz)	Duty Factor (dB)	Power Density+ Duty Factor (dBm/500 kHz)	Limit (dBm/500 kHz)	Result
5755	-2.66	0	-2.66	27.67	Complies
5795	-2.49	0	-2.49	27.67	Complies

Test Mode UNII-3_ IEEE 802.11ac (VHT80)_ANT 1

Frequency (MHz)	Power Density (dBm/500 kHz)	Duty Factor (dB)	Power Density+ Duty Factor (dBm/500 kHz)	Limit (dBm/500 kHz)	Result
5775	-6.23	0	-6.23	27.67	Complies

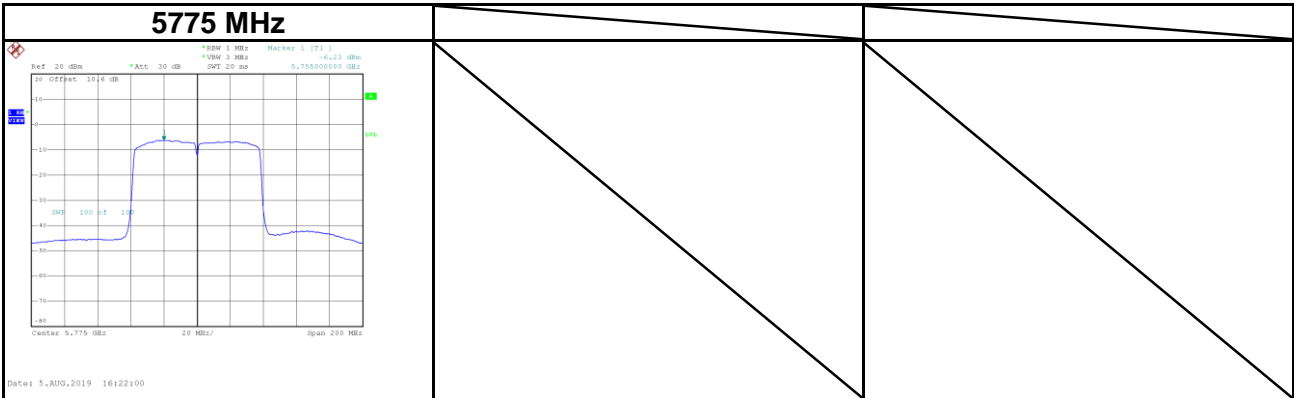

Test Mode UNII-3_ IEEE 802.11ac (VHT80)_ANT 2

Frequency (MHz)	Power Density (dBm/500 kHz)	Duty Factor (dB)	Power Density+ Duty Factor (dBm/500 kHz)	Limit (dBm/500 kHz)	Result
5775	-4.34	0	-4.34	27.67	Complies

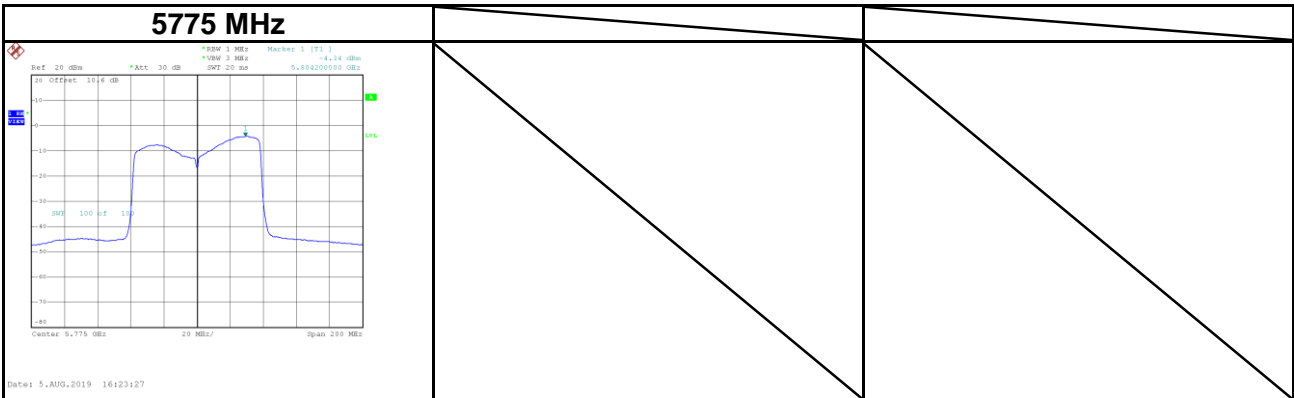

Test Mode UNII-3_ IEEE 802.11ac (VHT80)_Total

Frequency (MHz)	Power Density (dBm/500 kHz)	Duty Factor (dB)	Power Density+ Duty Factor (dBm/500 kHz)	Limit (dBm/500 kHz)	Result
5775	-2.17	0	-2.17	27.67	Complies

APPENDIX H FREQUENCY STABILITY

CONTINUE ON NEXT PAGE

Test Mode	UNII-1
-----------	--------

Voltage vs. Frequency Stability

Operating Frequency	5180
Voltage (V)	Measurement Frequency (MHz)
132	5180.0480
120	5180.0476
108	5180.0472
Maximum Deviation (MHz)	0.0480
Maximum Deviation (ppm)	9.2664

Temperature vs. Frequency Stability

Operating Frequency	5180
Temperature (°C)	Measurement Frequency (MHz)
0	5180.0464
10	5180.0460
20	5180.0464
30	5180.0464
40	5180.0464
Maximum Deviation (MHz)	0.0464
Maximum Deviation (ppm)	8.9575

Test Mode	UNII-3
-----------	--------

Voltage vs. Frequency Stability

Operating Frequency	5745
Voltage (V)	Measurement Frequency (MHz)
132	5745.0496
120	5745.0500
108	5745.0500
Maximum Deviation (MHz)	0.0500
Maximum Deviation (ppm)	8.7032

Temperature vs. Frequency Stability

Operating Frequency	5745
Temperature (°C)	Measurement Frequency (MHz)
0	5745.0496
10	5745.0496
20	5745.0496
30	5745.0500
40	5745.0500
Maximum Deviation (MHz)	0.0500
Maximum Deviation (ppm)	8.7032

End of Test Report