

# FCC Radio Test Report

## FCC ID: T58MW5230R

This report concerns (check one):  Original Grant  Class II Change

**Project No.** : 1505C274  
**Equipment** : 3G/4G Wireless N 300Mbps Router  
**Model Name** : MW5230  
**Applicant** : NETIS SYSTEMS CO., LTD  
**Address** : 4F&5F R&D Building, Oriental Cyberport, High-Tech Industrial Park, Nanshan, Shenzhen, China.

**Date of Receipt** : May 27, 2015  
**Date of Test** : May 27, 2015 ~ Jun. 25, 2015  
**Issued Date** : Jun. 25, 2015  
**Tested by** : BTL Inc.

**Testing Engineer** : David Mao  
(David Mao)

**Technical Manager** : Leo Hung  
(Leo Hung)

**Authorized Signatory** : Steven Lu  
(Steven Lu)

# **B T L I N C .**

No.3, Jinshagang 1st Road, Shixia, Dalang Town, Dongguan,  
Guangdong, China.

TEL: +86-769-8318-3000 FAX: +86-769-8319-6000

### **Declaration**

**BTL** represents to the client that testing is done in accordance with standard procedures as applicable and that test instruments used has been calibrated with the standards traceable to National Measurement Laboratory (**NML**) of **R.O.C**, or National Institute of Standards and Technology (**NIST**) of **U.S.A**.

**BTL's** reports apply only to the specific samples tested under conditions. It is manufacture's responsibility to ensure that additional production units of this model are manufactured with the identical electrical and mechanical components. **BTL** shall have no liability for any declarations, inferences or generalizations drawn by the client or others from **BTL** issued reports.

**BTL's** report must not be used by the client to claim product certification, approval, or endorsement by NVLAP, NIST, or any agency of the Federal Government.

This report is the confidential property of the client. As a mutual protection to the clients, the public and **BTL-self**, extracts from the test report shall not be reproduced except in full with **BTL's** authorized written approval.

**BTL's** laboratory quality assurance procedures are in compliance with the **ISO Guide 17025** requirements, and accredited by the conformity assessment authorities listed in this test report.

### **Limitation**

For the use of the authority's logo is limited unless the Test Standard(s)/Scope(s)/Item(s) mentioned in this test report is (are) included in the conformity assessment authorities acceptance respective.

<b>Table of Contents</b>	<b>Page</b>
<b>1 . CERTIFICATION</b>	<b>6</b>
<b>2 . SUMMARY OF TEST RESULTS</b>	<b>7</b>
2.1 TEST FACILITY	8
2.2 MEASUREMENT UNCERTAINTY	8
<b>3 . GENERAL INFORMATION</b>	<b>9</b>
3.1 GENERAL DESCRIPTION OF EUT	9
3.2 DESCRIPTION OF TEST MODES	11
3.3 TABLE OF PARAMETERS OF TEXT SOFTWARE SETTING	12
3.4 BLOCK DIAGRAM SHOWING THE CONFIGURATION OF SYSTEM TESTED	13
3.5 DESCRIPTION OF SUPPORT UNITS	13
<b>4 . EMC EMISSION TEST</b>	<b>14</b>
4.1 CONDUCTED EMISSION MEASUREMENT	14
4.1.1 POWER LINE CONDUCTED EMISSION LIMITS	14
4.1.2 TEST PROCEDURE	14
4.1.3 DEVIATION FROM TEST STANDARD	14
4.1.4 TEST SETUP	15
4.1.5 EUT OPERATING CONDITIONS	15
4.1.6 EUT TEST CONDITIONS	15
4.1.7 TEST RESULTS	15
4.2 RADIATED EMISSION MEASUREMENT	16
4.2.1 RADIATED EMISSION LIMITS	16
4.2.2 TEST PROCEDURE	17
4.2.3 DEVIATION FROM TEST STANDARD	17
4.2.4 TEST SETUP	18
4.2.5 EUT OPERATING CONDITIONS	19
4.2.6 EUT TEST CONDITIONS	19
4.2.7 TEST RESULTS (9KHZ TO 30MHZ)	19
4.2.8 TEST RESULTS (BETWEEN 30MHZ TO 1000 MHZ)	19
4.2.9 TEST RESULTS (ABOVE 1000 MHZ)	19
<b>5 . BANDWIDTH TEST</b>	<b>20</b>
5.1 APPLIED PROCEDURES	20
5.1.1 TEST PROCEDURE	20
5.1.2 DEVIATION FROM STANDARD	20
5.1.3 TEST SETUP	20
5.1.4 EUT OPERATION CONDITIONS	20
5.1.5 EUT TEST CONDITIONS	20
5.1.6 TEST RESULTS	20

<b>Table of Contents</b>	<b>Page</b>
<b>6 . MAXIMUM PEAK CONDUCTED OUTPUT POWER TEST</b>	<b>21</b>
<b>6.1 APPLIED PROCEDURES / LIMIT</b>	<b>21</b>
6.1.1 TEST PROCEDURE	21
6.1.2 DEVIATION FROM STANDARD	21
6.1.3 TEST SETUP	21
6.1.4 EUT OPERATION CONDITIONS	21
6.1.5 EUT TEST CONDITIONS	21
6.1.6 TEST RESULTS	21
<b>7 . ANTENNA CONDUCTED SPURIOUS EMISSION</b>	<b>22</b>
<b>7.1 APPLIED PROCEDURES / LIMIT</b>	<b>22</b>
7.1.1 TEST PROCEDURE	22
7.1.2 DEVIATION FROM STANDARD	22
7.1.3 TEST SETUP	22
7.1.4 EUT OPERATION CONDITIONS	22
7.1.5 EUT TEST CONDITIONS	22
7.1.6 TEST RESULTS	22
<b>8 . POWER SPECTRAL DENSITY TEST</b>	<b>23</b>
<b>8.1 APPLIED PROCEDURES / LIMIT</b>	<b>23</b>
8.1.1 TEST PROCEDURE	23
8.1.2 DEVIATION FROM STANDARD	23
8.1.3 TEST SETUP	23
8.1.4 EUT OPERATION CONDITIONS	23
8.1.5 EUT TEST CONDITIONS	23
8.1.6 TEST RESULTS	23
<b>9 . MEASUREMENT INSTRUMENTS LIST</b>	<b>24</b>
<b>10 . EUT TEST PHOTO</b>	<b>27</b>
<b>ATTACHMENT A - CONDUCTED EMISSION</b>	<b>31</b>
<b>ATTACHMENT B - RADIATED EMISSION (9KHZ TO 30MHZ)</b>	<b>34</b>
<b>ATTACHMENT C - RADIATED EMISSION (30MHZ TO 1000MHZ)</b>	<b>36</b>
<b>ATTACHMENT D - RADIATED EMISSION (ABOVE 1000MHZ)</b>	<b>43</b>
<b>ATTACHMENT E - BANDWIDTH</b>	<b>92</b>
<b>ATTACHMENT F – MAXIMUM PEAK CONDUCTED OUTPUT POWER</b>	<b>101</b>
<b>ATTACHMENT G - ANTENNA CONDUCTED SPURIOUS EMISSION</b>	<b>105</b>
<b>ATTACHMENT H - POWER SPECTRAL DENSITY</b>	<b>190</b>

### REPORT ISSUED HISTORY

Issued No.	Description	Issued Date
BTL-FCCP-1-1505C274	Original Issue.	Jun. 25, 2015

## 1. CERTIFICATION

Equipment : 3G/4G Wireless N 300Mbps Router  
Brand Name : netis  
Model Name : MW5230  
Applicant : NETIS SYSTEMS CO., LTD  
Manufacturer : Shenzhen Netcore Industrial Ltd.  
Address : 4F&5F R&D Building, Oriental Cyberport, High-Tech Industrial Park, Nanshan, Shenzhen, China.  
Factory : Dongguan City Netcore Network Technology Co.,Ltd.  
Address : No.10-1,Sankeng Road,Qinghutou,Tangxia Town,Don guan City  
Date of Test : May 27, 2015 ~ Jun. 25, 2015  
Test Sample : ENGINEERING SAMPLE  
Standard(s) : FCC Part15, Subpart C: 2014 (15.247) / ANSI C63.4-2009

The above equipment has been tested and found compliance with the requirement of the relative standards by BTL Inc.

The test data, data evaluation, and equipment configuration contained in our test report (Ref No. BTL-FCCP-1-1505C274) were obtained utilizing the test procedures, test instruments, test sites that has been accredited by the Authority of TAF according to the ISO-17025 quality assessment standard and technical standard(s).

## 2. SUMMARY OF TEST RESULTS

Test procedures according to the technical standard(s):

<b>Applied Standard(s): FCC Part15 (15.247) , Subpart C: 2014</b>				
<b>Standard(s)</b>	<b>Section</b>	<b>Test Item</b>	<b>Judgment</b>	<b>Remark</b>
	<b>FCC</b>			
15.207		Conducted Emission	PASS	
15.247(d)		Antenna conducted Spurious Emission	PASS	
15.247(a)(2)		6dB Bandwidth	PASS	
15.247(b)(3)		Peak Output Power	PASS	
15.247(e)		Power Spectral Density	PASS	
15.203		Antenna Requirement	PASS	
15.209/15.205		Transmitter Radiated Emissions	PASS	

**NOTE:**

- (1) "N/A" denotes test is not applicable in this test report.
- (2) The test follows FCC KDB Publication No. 558074 D01 DTS Meas Guidance v03r03 (Measurement Guidelines of DTS)

## 2.1 TEST FACILITY

The test facilities used to collect the test data in this report is at the location of No.3, Jinshagang 1st Road, Shixia, Dalang Town, Dongguan, Guangdong, China.

BTL's test firm number for FCC: 319330

## 2.2 MEASUREMENT UNCERTAINTY

Where relevant, the following measurement uncertainty levels have been estimated for tests performed on the EUT as specified in CISPR 16-4-2.

The BTL measurement uncertainty is less than the CISPR 16-4-2  $U_{\text{CISPR}}$  requirement.

The reported uncertainty of measurement  $y \pm U$ , where expanded uncertainty  $U$  is based on a standard uncertainty multiplied by a coverage factor of  $k=2$ , providing a level of confidence of approximately 95 %.

### A. Conducted Measurement :

Test Site	Method	Measurement Frequency Range	U, (dB)	NOTE
DG-C02	CISPR	150 KHz ~ 30MHz	1.94	

### B. Radiated Measurement :

Test Site	Method	Measurement Frequency Range	Ant. H / V	U, (dB)	NOTE
DG-CB03	CISPR	9KHz~30MHz	V	3.79	
		9KHz~30MHz	H	3.57	
		30MHz ~ 200MHz	V	3.82	
		30MHz ~ 200MHz	H	3.60	
		200MHz ~ 1,000MHz	V	3.86	
		200MHz ~ 1,000MHz	H	3.94	
		1GHz~18GHz	V	3.12	
		1GHz~18GHz	H	3.68	
		18GHz~40GHz	V	4.15	
		18GHz~40GHz	H	4.14	

Note: Unless specifically mentioned, the uncertainty of measurement has not been taken into account to declare the compliance or non-compliance to the specification.



### 3. GENERAL INFORMATION

#### 3.1 GENERAL DESCRIPTION OF EUT

Equipment	3G/4G Wireless N 300Mbps Router	
Brand Name	netis	
Model Name	MW5230	
Model Difference	N/A	
Product Description	Operation Frequency	2412~2462 MHz
	Modulation Technology	802.11b:DSSS 802.11g:OFDM 802.11n:OFDM
	Bit Rate of Transmitter	802.11b: 11/5.5/2/1 Mbps 802.11g: 54/48/36/24/18/12/9/6 Mbps 802.11n up to 300 Mbps
	Output Power (Max.)	802.11b: 16.61dBm 802.11g: 23.72dBm 802.11n(20MHz): 23.49dBm 802.11n(40MHz): 22.71dBm
Hardware version	V1	
Software version	V1	
Power Source	DC voltage supplied from AC/DC Adapter. Manufacturer/ Model: DongGuan tenpao Power CO.,LTD/ NT12V1AUL	
Power Rating	I/P: 100-240V~ 0.3A 50/60Hz O/P: DC 12V 1A	

**Note:**

1. For a more detailed features description, please refer to the manufacturer's specifications or the user's manual.

2. Channel List:

CH01 – CH11 for 802.11b, 802.11g, 802.11n(20MHz) CH03 – CH09 for 802.11n(40MHz)							
Channel	Frequency (MHz)	Channel	Frequency (MHz)	Channel	Frequency (MHz)	Channel	Frequency (MHz)
01	2412	04	2427	07	2442	10	2457
02	2417	05	2432	08	2447	11	2462
03	2422	06	2437	09	2452		

3. Table for Filed Antenna

Ant.	Brand	Model Name	Antenna Type	Connector	Gain (dBi)	Note
1	<i>RF link</i>	RF21C00806A	Dipole	N/A	4.73	TX/RX
2	<i>RF link</i>	RF21C00806A	Dipole	N/A	4.73	TX/RX
6	<i>RF link</i>	RF21C00806A	Dipole	N/A	4.73	RX

Note:

(1) The EUT incorporates a MIMO function. Physically, the EUT provides two completed transmitters and three receivers (2T3R), all transmit signals are completely uncorrelated, then, **Direction gain =  $G_{ANT}$** , that is Directional gain=4.73.

4.

Operating Mode TX Mode	1TX	2TX
	802.11b	V (ANT 1)
802.11g	V (ANT 1)	-
802.11n(20MHz)	-	V (ANT 1 + ANT 2)
802.11n(40MHz)	-	V (ANT 1 + ANT 2)

### 3.2 DESCRIPTION OF TEST MODES

To investigate the maximum EMI emission characteristics generated from EUT, the test system was pre-scanning tested based on the consideration of following EUT operation mode or test configuration mode which possibly have effect on EMI emission level. Each of these EUT operation mode(s) or test configuration mode(s) mentioned above was evaluated respectively.

Pretest Mode	Description
Mode 1	TX B MODE CHANNEL 01/06/11
Mode 2	TX G MODE CHANNEL 01/06/11
Mode 3	TX N-20MHZ MODE CHANNEL 01/06/11
Mode 4	TX N-40MHZ MODE CHANNEL 03/06/09
Mode 5	TX MODE

The EUT system operated these modes were found to be the worst case during the pre-scanning test as following:

For Conducted Test	
Final Test Mode	Description
Mode 5	TX MODE

For Radiated Test	
Final Test Mode	Description
Mode 1	TX B MODE CHANNEL 01/06/11
Mode 2	TX G MODE CHANNEL 01/06/11
Mode 3	TX N-20MHZ MODE CHANNEL 01/06/11
Mode 4	TX N-40MHZ MODE CHANNEL 03/06/09

Note:

- (1) The measurements are performed at the high, middle, low available channels.
- (2) 802.11b mode: DBPSK (1Mbps)  
 802.11g mode: OFDM (6Mbps)  
 802.11n HT20 mode : BPSK (13Mbps)  
 802.11n HT40 mode : BPSK (27Mbps)  
 For radiated emission tests, the highest output powers were set for final test.
- (3) For radiated below 1G test, the 802.11b is found to be the worst case and recorded.
- (4) The EUT was programmed to be in continuously transmitting mode and the transmit duty cycle is not less than 98%.

### 3.3 TABLE OF PARAMETERS OF TEXT SOFTWARE SETTING

During testing, channel & power controlling software provided by the customer was used to control the operating channel as well as the output power level. The RF output power selection is for the setting of RF output power expected by the customer and is going to be fixed on the firmware of the final end product power parameters of WLAN

Test software version	Release_3.0		
Frequency (MHz)	2412	2437	2462
802.11b	23	23	23
802.11g	36	38	38
802.11n (20MHz)	26	26	26
Frequency	2422	2437	2452
802.11n (40MHz)	28	28	28

### 3.4 BLOCK DIAGRAM SHOWING THE CONFIGURATION OF SYSTEM TESTED

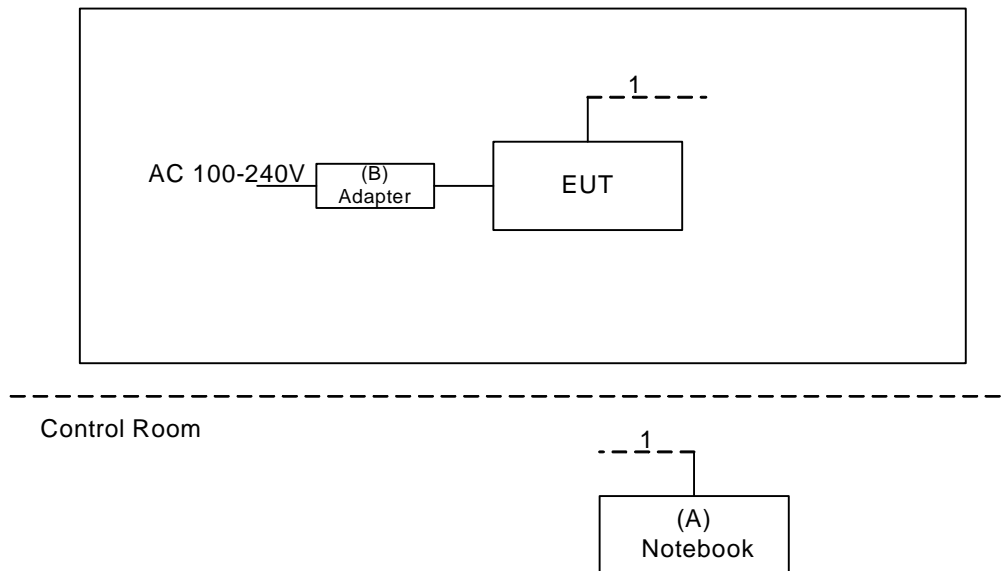

### 3.5 DESCRIPTION OF SUPPORT UNITS

The EUT has been tested as an independent unit together with other necessary accessories or support units. The following support units or accessories were used to form a representative test configuration during the tests.

Item	Equipment	Mfr/Brand	Model/Type No.	FCC ID	Series No.	Note
A	Notebook	HP	HP NB 331	DOC	N/A	
B	Adapter	tenpao	NT12V1AUL	N/A	N/A	

Item	Shielded Type	Ferrite Core	Length	Note
1	NO	NO	10m	RJ45 Cable

## 4. EMC EMISSION TEST

### 4.1 CONDUCTED EMISSION MEASUREMENT

#### 4.1.1 POWER LINE CONDUCTED EMISSION LIMITS (FREQUENCY RANGE 150KHZ-30MHZ)

Frequency of Emission (MHz)	Conducted Limit (dB $\mu$ V)	
	Quasi-peak	Average
0.15 -0.5	66 to 56*	56 to 46*
0.50 -5.0	56	46
5.0 -30.0	60	50

Note:

- (1) The limit of " \* " decreases with the logarithm of the frequency
- (2) The test result calculated as following:  
 Measurement Value = Reading Level + Correct Factor  
 Correct Factor = Insertion Loss + Cable Loss + Attenuator Factor(if use)  
 Margin Level = Measurement Value - Limit Value

The following table is the setting of the receiver

Receiver Parameters	Setting
Attenuation	10 dB
Start Frequency	0.15 MHz
Stop Frequency	30 MHz
IF Bandwidth	9 KHz

#### 4.1.2 TEST PROCEDURE

- a. The EUT was placed 0.8 meters from the horizontal ground plane with EUT being connected to the power mains through a line impedance stabilization network (LISN). All other support equipments powered from additional LISN(s). The LISN provide 50 Ohm/ 50uH of coupling impedance for the measuring instrument.
- b. Interconnecting cables that hang closer than 40 cm to the ground plane shall be folded back and forth in the center forming a bundle 30 to 40 cm long.
- c. I/O cables that are not connected to a peripheral shall be bundled in the center. The end of the cable may be terminated, if required, using the correct terminating impedance. The overall length shall not exceed 1 m.
- d. LISN at least 80 cm from nearest part of EUT chassis.
- e. For the actual test configuration, please refer to the related Item –EUT Test Photos.

#### 4.1.3 DEVIATION FROM TEST STANDARD

No deviation

#### 4.1.4 TEST SETUP

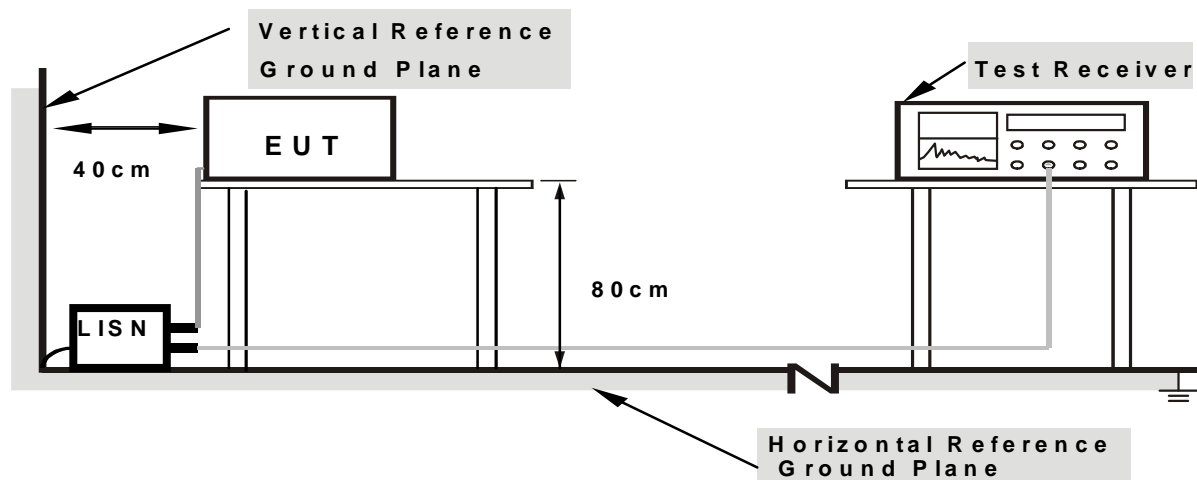

- Note:**
1. Support units were connected to second LISN.
  2. Both of LISNs (AMN) are 80 cm from EUT and at least 80 cm from other units and other metal planes

#### 4.1.5 EUT OPERATING CONDITIONS

The EUT was configured for testing in a typical fashion (as a customer would normally use it). The EUT has been programmed to continuously transmit during test. This operating condition was tested and used to collect the included data.  
EUT connected to notebook via RJ45 cable.

#### 4.1.6 EUT TEST CONDITIONS

Temperature: 24°C    Relative Humidity: 60%    Test Voltage: AC 120V/60Hz

#### 4.1.7 TEST RESULTS

Please refer to the Attachment A.

## 4.2 RADIATED EMISSION MEASUREMENT

### 4.2.1 RADIATED EMISSION LIMITS

20dB in any 100 KHz bandwidth outside the operating frequency band. In case the emission fall within the restricted band specified on 15.205(a), then the 15.209(a) limit in the table below has to be followed.

#### LIMITS OF RADIATED EMISSION MEASUREMENT (9KHz-1000MHz)

Frequency (MHz)	Field Strength (microvolts/meter)	Measurement Distance (meters)
0.009~0.490	2400/F(KHz)	300
0.490~1.705	24000/F(KHz)	30
1.705~30.0	30	30
30~88	100	3
88~216	150	3
216~960	200	3
960~1000	500	3

#### LIMITS OF RADIATED EMISSION MEASUREMENT (Above 1000MHz)

Frequency (MHz)	(dBuV/m) (at 3 meters)	
	PEAK	AVERAGE
Above 1000	74	54

#### Notes:

- (1) The limit for radiated test was performed according to FCC PART 15C.
- (2) The tighter limit applies at the band edges.
- (3) Emission level (dBuV/m)=20log Emission level (uV/m).
- (4) The test result calculated as following:  
 Measurement Value = Reading Level + Correct Factor  
 Correct Factor = Antenna Factor + Cable Loss - Amplifier Gain(if use)  
 Margin Level = Measurement Value - Limit Value

Spectrum Parameter	Setting
Attenuation	Auto
Start Frequency	1000 MHz
Stop Frequency	10th carrier harmonic
RBW / VBW (Emission in restricted band)	RBW 1MHz VBW 3MHz peak detector for Pk value RMS detector for AV value



Receiver Parameter	Setting
Attenuation	Auto
Start ~ Stop Frequency	9KHz~90KHz for PK/AVG detector
Start ~ Stop Frequency	90KHz~110KHz for QP detector
Start ~ Stop Frequency	110KHz~490KHz for PK/AVG detector
Start ~ Stop Frequency	490KHz~30MHz for QP detector
Start ~ Stop Frequency	30MHz~1000MHz for QP detector

#### 4.2.2 TEST PROCEDURE

- a. The EUT was placed on the top of a rotating table 0.8 meters above the ground at a 3 meter semi-anechoic chamber. The table was rotated 360 degrees to determine the position of the highest radiation.
- b. For the radiated emission test above 1GHz:  
Place the measurement antenna away from each area of the EUT determined to be a source of emissions at the specified measurement distance, while keeping the measurement antenna aimed at the source of emissions at each frequency of significant emissions, with polarization oriented for maximum response. The measurement antenna may have to be higher or lower than the EUT, depending on the radiation pattern of the emission and staying aimed at the emission source for receiving the maximum signal. The final measurement antenna elevation shall be that which maximizes the emissions. The measurement antenna elevation for maximum emissions shall be restricted to a range of heights of from 1 m to 4 m above the ground or reference ground plane.
- c. The initial step in collecting conducted emission data is a spectrum analyzer peak detector mode pre-scanning the measurement frequency range. Significant peaks are then marked and then Quasi Peak detector mode re-measured.
- d. If the Peak Mode measured value compliance with and lower than Quasi Peak Mode Limit, the EUT shall be deemed to meet QP Limits and then no additional QP Mode measurement performed.
- e. For the actual test configuration, please refer to the related Item –EUT Test Photos.

#### 4.2.3 DEVIATION FROM TEST STANDARD

No deviation

#### 4.2.4 TEST SETUP

(A) Radiated Emission Test Set-Up Frequency Below 1 GHz

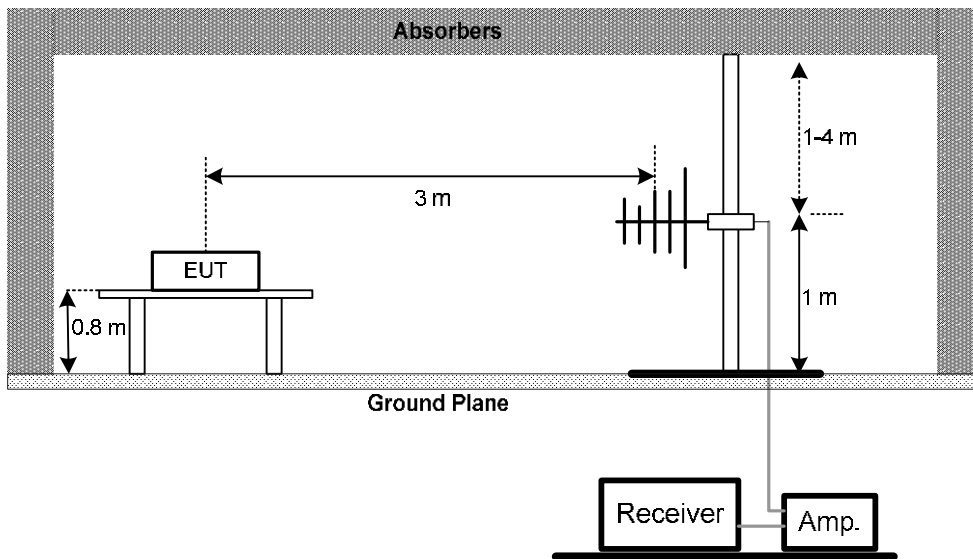

(B) Radiated Emission Test Set-Up Frequency Above 1 GHz

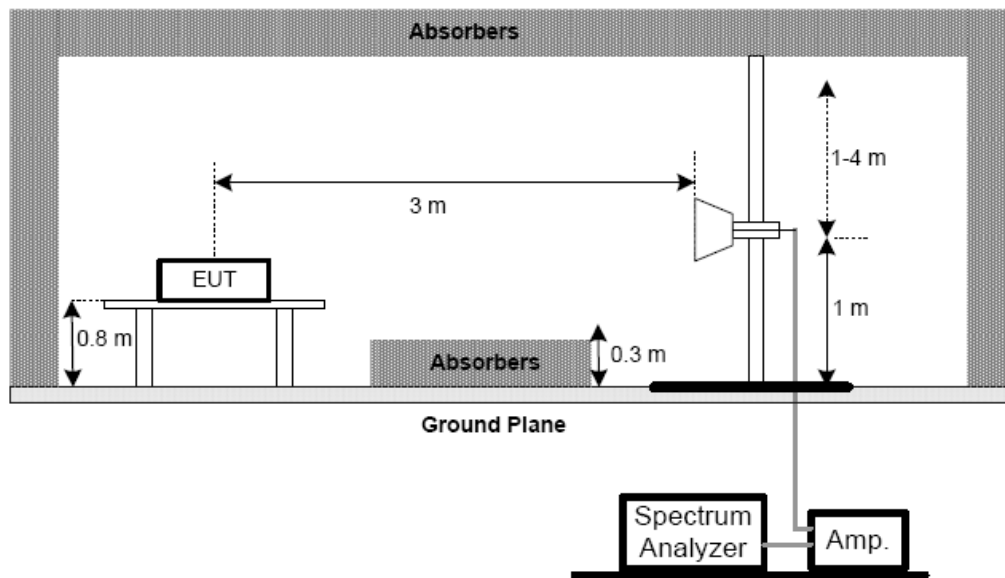

(C) For radiated emissions below 30MHz

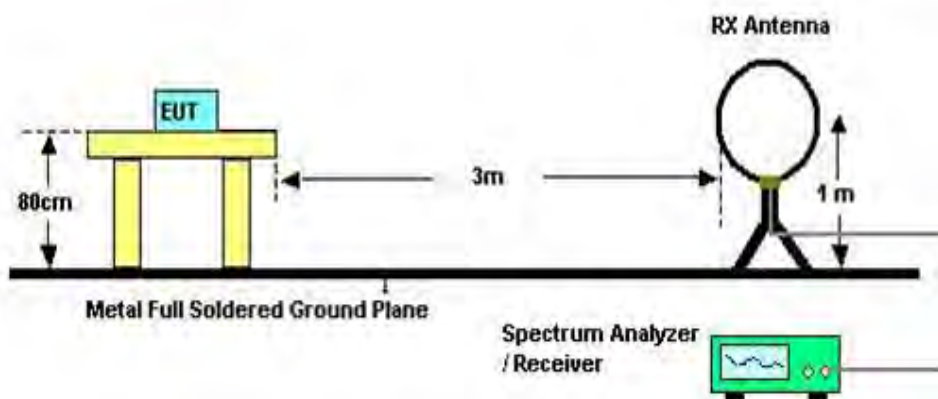

#### 4.2.5 EUT OPERATING CONDITIONS

The EUT tested system was configured as the statements of 4.1.5 **Unless** otherwise a special operating condition is specified in the follows during the testing.

#### 4.2.6 EUT TEST CONDITIONS

Temperature: 28°C    Relative Humidity: 60%    Test Voltage: AC 120V/60Hz

#### 4.2.7 TEST RESULTS (9KHZ TO 30MHZ)

Please refer to the Attachment B

Remark:

- (1) The amplitude of spurious emissions which are attenuated by more than 20 dB below the permissible value has no need to be reported.
- (2) Distance extrapolation factor =  $40 \log(\text{specific distance} / \text{test distance})$  (dB).
- (3) Limit line = specific limits (dBuV) + distance extrapolation factor.

#### 4.2.8 TEST RESULTS (BETWEEN 30MHZ TO 1000 MHZ)

Please refer to the Attachment C.

#### 4.2.9 TEST RESULTS (ABOVE 1000 MHZ)

Please refer to the Attachment D.

Remark:

- (1) No limit: This is fundamental signal, the judgment is not applicable. For fundamental signal judgment was referred to Peak output test.

## 5. BANDWIDTH TEST

### 5.1 APPLIED PROCEDURES

FCC Part15 (15.247) , Subpart C			
Section	Test Item	Frequency Range (MHz)	Result
15.247(a)(2)	Bandwidth	2400-2483.5	PASS

#### 5.1.1 TEST PROCEDURE

- a. The EUT was directly connected to the spectrum analyzer and antenna output port as show in the block diagram below,
- b. Spectrum Setting: RBW= 100KHz, VBW=300KHz, Sweep time = 2.5 ms.

#### 5.1.2 DEVIATION FROM STANDARD

No deviation.

#### 5.1.3 TEST SETUP



#### 5.1.4 EUT OPERATION CONDITIONS

The EUT tested system was configured as the statements of 4.1.5 Unless otherwise a special operating condition is specified in the follows during the testing.

#### 5.1.5 EUT TEST CONDITIONS

Temperature: 25°C    Relative Humidity: 60%    Test Voltage: AC 120V/60Hz

#### 5.1.6 TEST RESULTS

Please refer to the Attachment E.

## 6. MAXIMUM PEAK CONDUCTED OUTPUT POWER TEST

### 6.1 APPLIED PROCEDURES / LIMIT

FCC Part15 (15.247) , Subpart C				
Section	Test Item	Limit	Frequency Range (MHz)	Result
15.247(b)(3)	Maximum Output Power	1 Watt or 30dBm	2400-2483.5	PASS

#### 6.1.1 TEST PROCEDURE

- a. The EUT was directly connected to the power meter and antenna output port as show in the block diagram below,
- b. The maximum peak conducted output power was performed in accordance with method 9.1.2 of FCC KDB 558074 D01 DTS Meas Guidance v03r03.

#### 6.1.2 DEVIATION FROM STANDARD

No deviation.

#### 6.1.3 TEST SETUP

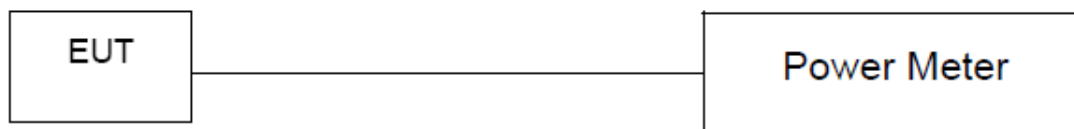

#### 6.1.4 EUT OPERATION CONDITIONS

The EUT tested system was configured as the statements of 4.1.5 Unless otherwise a special operating condition is specified in the follows during the testing. Transmit output power was measured while the host equipment supply voltage was varied from 85 % to 115 % of the nominal rated supply voltage. No change in transmit output power was observed.

#### 6.1.5 EUT TEST CONDITIONS

Temperature: 25°C    Relative Humidity: 60%    Test Voltage: AC 120V/60Hz

#### 6.1.6 TEST RESULTS

Please refer to the Attachment F.

## **7. ANTENNA CONDUCTED SPURIOUS EMISSION**

### **7.1 APPLIED PROCEDURES / LIMIT**

In any 100 kHz bandwidth outside the frequency band in which the spread spectrum or digitally modulated intentional radiator is operating, the radio frequency power that is produced by the intentional radiator shall be at least 20 dB below that in the 100 kHz bandwidth within the band that contains the highest level of the desired power, based on either an RF conducted measurement, provided the transmitter demonstrates compliance with the peak conducted power limits.

#### **7.1.1 TEST PROCEDURE**

- a. The EUT was directly connected to the spectrum analyzer and antenna output port as show in the block diagram below,
- b. Spectrum Setting: RBW= 100KHz, VBW=300KHz, Sweep time = Auto.
- c. sweep points=40001  
sweep points > span/RBW

#### **7.1.2 DEVIATION FROM STANDARD**

No deviation.

#### **7.1.3 TEST SETUP**

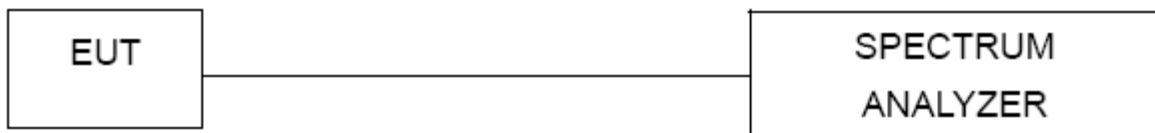

#### **7.1.4 EUT OPERATION CONDITIONS**

The EUT tested system was configured as the statements of 4.1.5 Unless otherwise a special operating condition is specified in the follows during the testing.

#### **7.1.5 EUT TEST CONDITIONS**

Temperature: 25°C    Relative Humidity: 60%    Test Voltage: AC 120V/60Hz

#### **7.1.6 TEST RESULTS**

Please refer to the Attachment G.

## 8. POWER SPECTRAL DENSITY TEST

### 8.1 APPLIED PROCEDURES / LIMIT

FCC Part15 (15.247) , Subpart C				
Section	Test Item	Limit	Frequency Range (MHz)	Result
15.247(e)	Power Spectral Density	8 dBm (in any 3KHz)	2400-2483.5	PASS

#### 8.1.1 TEST PROCEDURE

- a. The EUT was directly connected to the spectrum analyzer and antenna output port as show in the block diagram below,
- b. Spectrum Setting: RBW=3KHz, VBW=10KHz, Sweep time = Auto.

#### 8.1.2 DEVIATION FROM STANDARD

No deviation.

#### 8.1.3 TEST SETUP

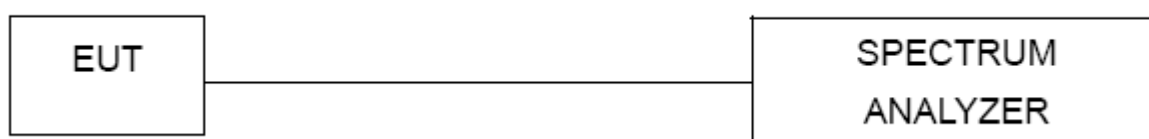

#### 8.1.4 EUT OPERATION CONDITIONS

The EUT tested system was configured as the statements of 4.1.5 Unless otherwise a special operating condition is specified in the follows during the testing.

#### 8.1.5 EUT TEST CONDITIONS

Temperature: 25°C    Relative Humidity: 60%    Test Voltage: AC 120V/60Hz

#### 8.1.6 TEST RESULTS

Please refer to the Attachment H.

## 9. MEASUREMENT INSTRUMENTS LIST

Conducted Emission Measurement					
Item	Kind of Equipment	Manufacturer	Type No.	Serial No.	Calibrated until
1	LISN	EMCO	3816/2	00052765	Mar. 28, 2016
2	LISN	R&S	ENV216	101447	Mar. 28, 2016
3	Test Cable	emci	RG223(9KHz-30MHz)	C_17	Mar. 13, 2016
4	EMI TEST RECEIVER	R&S	ESCS30	833364/017	Mar. 28, 2016
5	50Ω Terminator	SHX	TF2-3G-A	08122902	Mar. 28, 2016
6	Measurement Software	Farad	EZ-EMC Ver.NB-03A1-01	N/A	N/A

Radiated Emission Measurement					
Item	Kind of Equipment	Manufacturer	Type No.	Serial No.	Calibrated until
1	Antenna	Schwarzbeck	VULB9160	9160-3232	Mar. 28, 2016
2	Amplifier	HP	8447D	2944A09673	Nov. 17, 2015
3	Receiver	AGILENT	N9038A	MY52130039	Sep. 30, 2015
4	Test Cable	emci	LMR-400(30MHz-1GHz)	C-01	Jul. 01, 2015
5	Controller	CT	SC100	N/A	N/A
6	Measurement Software	Farad	EZ-EMC Ver.NB-03A1-01	N/A	N/A
7	Antenna	ETS	3115	00075789	Mar. 28, 2016
8	Amplifier	Agilent	8449B	3008A02274	Nov. 02, 2015
9	Receiver	AGILENT	N9038A	MY52130039	Sep. 30, 2015
10	Test Cable	emci	EMC104-SM-SM-10000(1GHz-26.5GHz)	C-68	Jul. 01, 2015
11	Controller	CT	SC100	N/A	N/A
12	Broad-Band Horn Antenna	Schwarzbeck	BBHA 9170	9170319	Mar. 28, 2016
13	Microwave Pre-amplifier With Adaptor	EMC INSTRUMENT	EMC2654045	980039 & HA01	Mar. 28, 2016
14	Active Loop Antenna	R&S	HFH2-Z2	830749/020	Aug. 16, 2015



6dB Bandwidth Measurement					
Item	Kind of Equipment	Manufacturer	Type No.	Serial No.	Calibrated until
1	Spectrum Analyzer	R&S	FSP 40	100185	Nov. 02, 2015
2	Rf coaxial cables	N/A	SMA-1.5 (30MHz-40GHz)	N/A	Oct. 22, 2015
3	Test Cable	N/A	CL-CB12-001 (30MHz-40GHz)	N/A	Oct. 22, 2015

Peak Output Power Measurement					
Item	Kind of Equipment	Manufacturer	Type No.	Serial No.	Calibrated until
1	power Meter	ANRITSU	ML2495A	1128009	Mar. 28, 2016
2	Pulse Power Sensor	ANRITSU	MA 2411B	1027500	Mar. 28, 2016
3	Rf coaxial cables	N/A	SMA-1.5 (30MHz-40GHz)	N/A	Oct. 22, 2015
4	Test Cable	N/A	CL-CB12-001 (30MHz-40GHz)	N/A	Oct. 22, 2015

Antenna Conducted Spurious Emission Measurement					
Item	Kind of Equipment	Manufacturer	Type No.	Serial No.	Calibrated until
1	Spectrum Analyzer	R&S	FSP 40	100185	Nov. 02, 2015
2	Rf coaxial cables	N/A	SMA-1.5 (30MHz-40GHz)	N/A	Oct. 22, 2015
3	Test Cable	N/A	CL-CB12-001 (30MHz-40GHz)	N/A	Oct. 22, 2015
4	EXA Spectrum Analyzer	Agilent	N9010A	MY50520044	Mar. 28, 2016

Power Spectral Density Measurement					
Item	Kind of Equipment	Manufacturer	Type No.	Serial No.	Calibrated until
1	Spectrum Analyzer	R&S	FSP 40	100185	Nov. 02, 2015
2	Rf coaxial cables	N/A	SMA-1.5 (30MHz-40GHz)	N/A	Oct. 22, 2015
3	Test Cable	N/A	CL-CB12-001 (30MHz-40GHz)	N/A	Oct. 22, 2015

Remark: "N/A" denotes no model name, serial no. or calibration specified.

All calibration period of equipment list is one year.

The Rf coaxial cable is soldered on the PCB board in order to perform conducted tests and this Rf coaxial cable is listed in the equipment list.

**Rf coaxial cable**



## 10. EUT TEST PHOTO

### Conducted Measurement Photos



## Radiated Measurement Photos

9KHz to 30MHz



## Radiated Measurement Photos

30MHz to 1000MHz

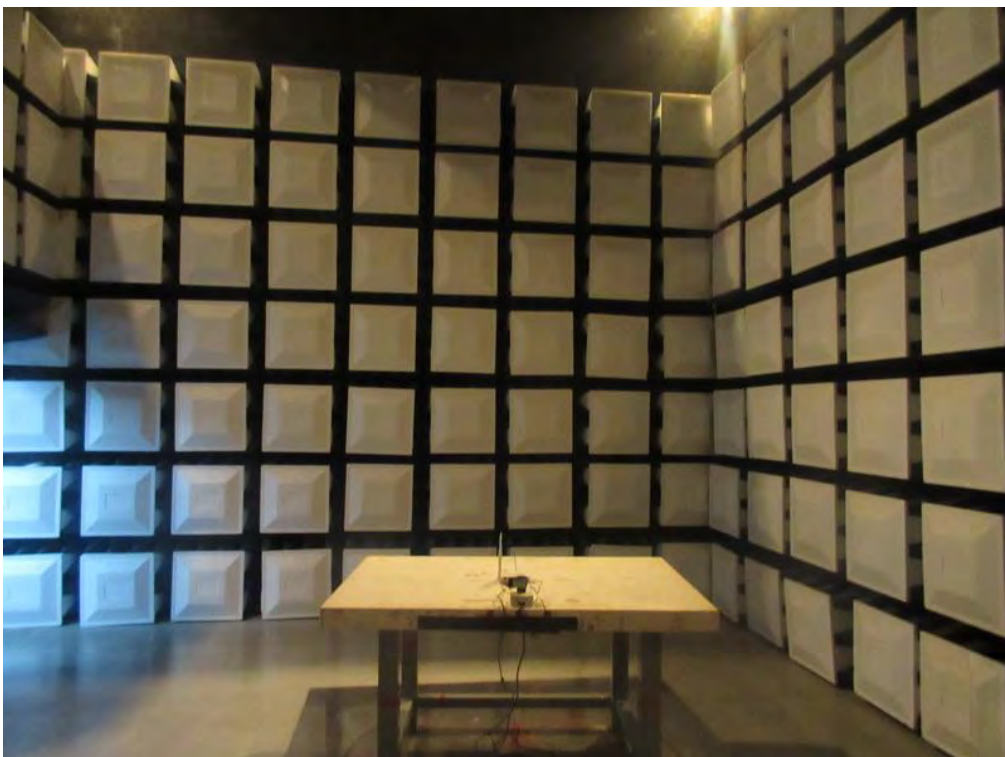

## Radiated Measurement Photos

Above 1000MHz

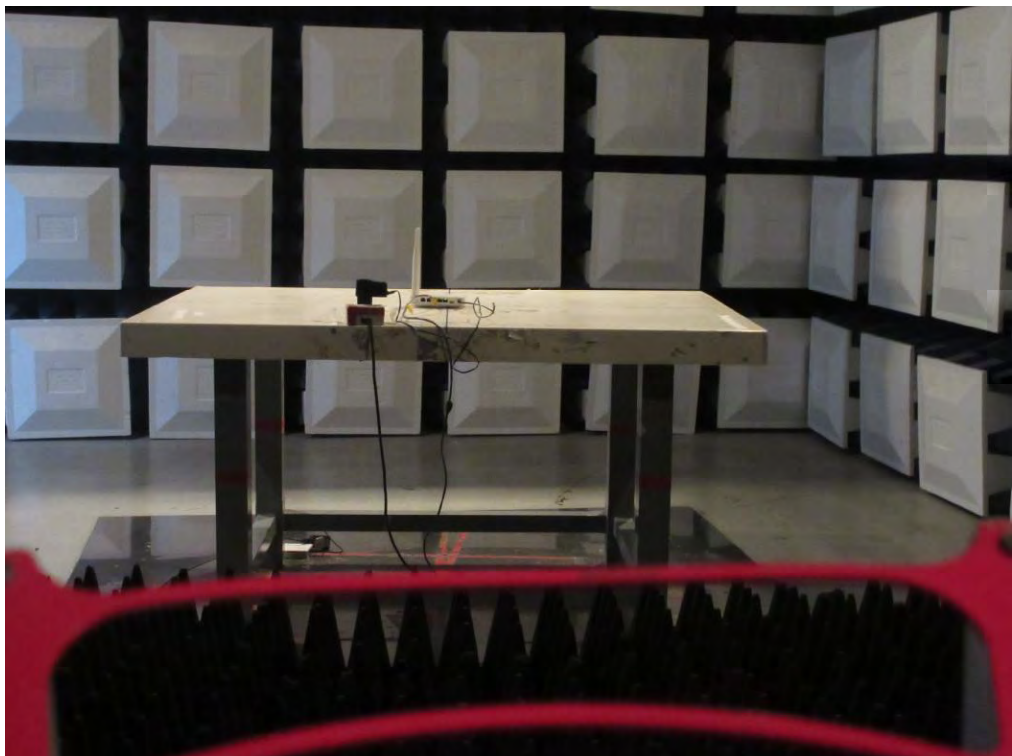
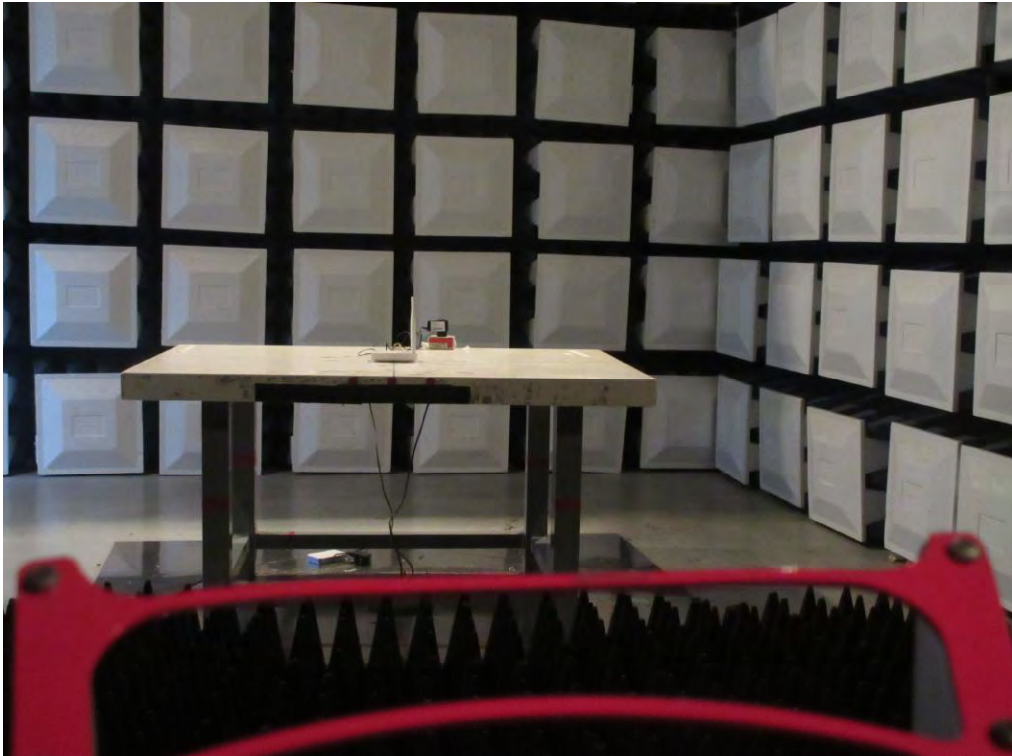

## ATTACHMENT A - CONDUCTED EMISSION

Test Mode : TX MODE

### Line

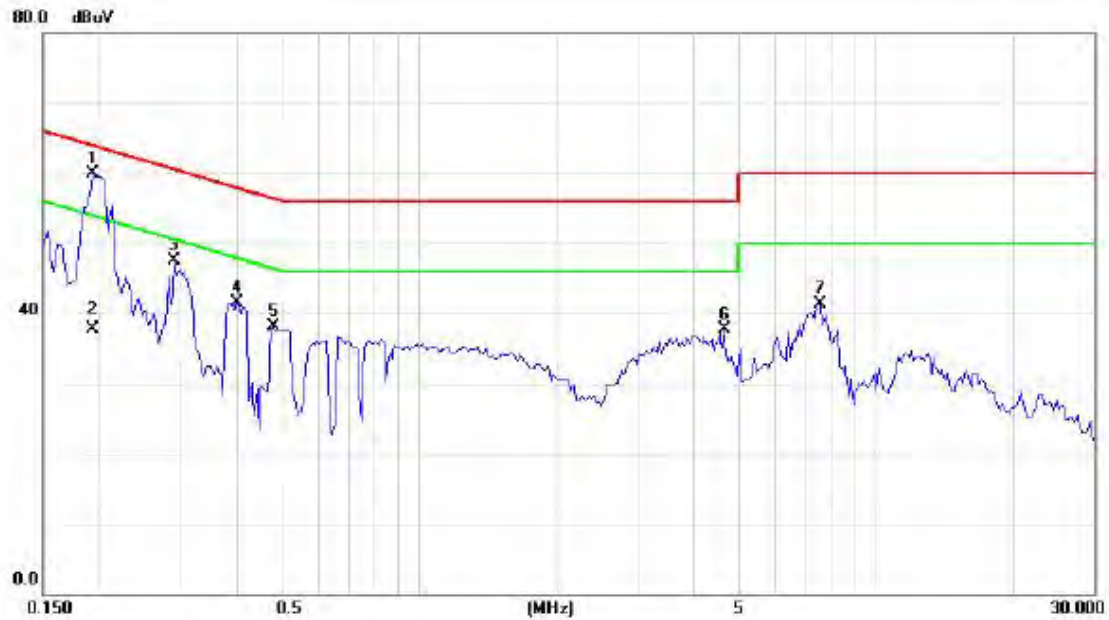

No.	Mk.	Freq. MHz	Reading Level dBuV	Correct Factor dB	Measure- ment dBuV	Limit dBuV	Margin dB	Detector	Comment
1	*	0.1930	50.25	9.69	59.94	63.91	-3.97	peak	
2		0.1930	28.10	9.69	37.79	53.91	-16.12	AVG	
3		0.2906	37.70	9.73	47.43	60.51	-13.08	peak	
4		0.4000	31.69	9.79	41.48	57.85	-16.37	peak	
5		0.4781	28.33	9.80	38.13	56.37	-18.24	peak	
6		4.6483	28.74	9.06	37.80	56.00	-18.20	peak	
7		7.5273	31.61	9.74	41.35	60.00	-18.65	peak	



Test Mode : TX MODE

### Neutral

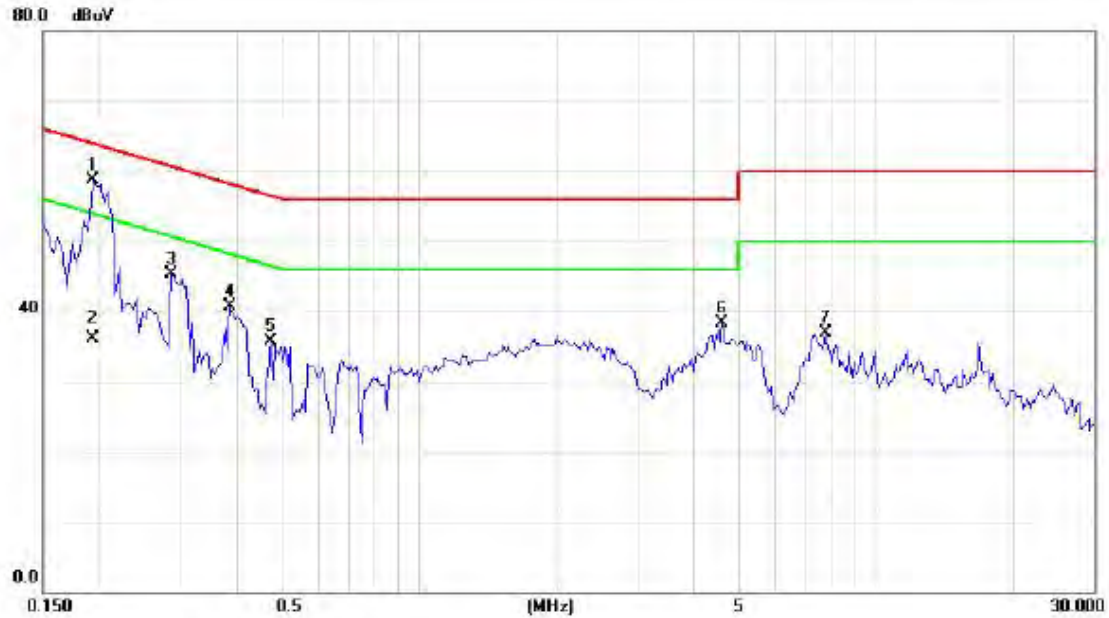

No.	Mk.	Freq. MHz	Reading Level dBuV	Correct Factor dB	Measure- ment dBuV	Limit dBuV	Margin dB	Detector	Comment
1	*	0.1930	49.13	9.59	58.72	63.91	-5.19	peak	
2		0.1930	26.50	9.59	36.09	53.91	-17.82	AVG	
3		0.2867	35.67	9.61	45.28	60.62	-15.34	peak	
4		0.3844	31.07	9.61	40.68	58.18	-17.50	peak	
5		0.4742	26.13	9.62	35.75	56.44	-20.69	peak	
6		4.6016	28.52	9.84	38.36	56.00	-17.64	peak	
7		7.7383	27.04	9.88	36.92	60.00	-23.08	peak	

**ATTACHMENT B - RADIATED EMISSION (9KHZ TO 30MHZ)**

Test Mode:	TX Mode 2412MHz
------------	-----------------

Frequency (MHz)	Ant 0°/90°	Read level dBuV/m	Factor (dB)	Measured(FS) (dBuV/m)	Limit (dBuV/m)	Margin (dB)	Note
0.0096	0°	13.41	24.96	38.37	128.00	-89.62	AVG
0.0096	0°	14.28	24.96	39.24	148.00	-108.75	PEAK
0.0225	0°	6.73	24.14	30.87	120.56	-89.69	AVG
0.0225	0°	8.12	24.14	32.26	140.56	-108.30	PEAK
0.0316	0°	3.17	23.57	26.74	117.61	-90.88	AVG
0.0316	0°	5.58	23.57	29.15	137.61	-108.47	PEAK
0.0421	0°	1.16	22.90	24.06	115.12	-91.06	AVG
0.0421	0°	2.53	22.90	25.43	135.12	-109.69	PEAK
0.4993	0°	19.36	19.80	39.16	73.64	-34.48	QP
1.7133	0°	23.71	19.53	43.24	69.54	-26.30	QP

Frequency (MHz)	Ant 0°/90°	Read level dBuV/m	Factor (dB)	Measured(FS) (dBuV/m)	Limit (dBuV/m)	Margin (dB)	Note
0.0097	90°	13.18	24.30	37.48	127.89	-90.41	AVG
0.0097	90°	14.83	24.30	39.13	147.89	-108.76	PEAK
0.0271	90°	7.24	23.85	31.09	118.94	-87.85	AVG
0.0271	90°	8.96	23.85	32.81	138.94	-106.13	PEAK
0.0399	90°	5.21	23.04	28.25	115.58	-87.34	AVG
0.0399	90°	6.15	23.04	29.19	135.58	-106.40	PEAK
0.0466	90°	1.50	22.62	24.12	114.24	-90.12	AVG
0.0466	90°	2.83	22.62	25.45	134.24	-108.79	PEAK
0.4934	90°	22.87	19.82	42.69	73.74	-31.05	QP
1.7174	90°	24.54	19.53	44.07	69.54	-25.47	QP

**ATTACHMENT C - RADIATED EMISSION (30MHZ TO 1000MHZ)**

Test Mode: TX B MODE CHANNEL 01

Vertical

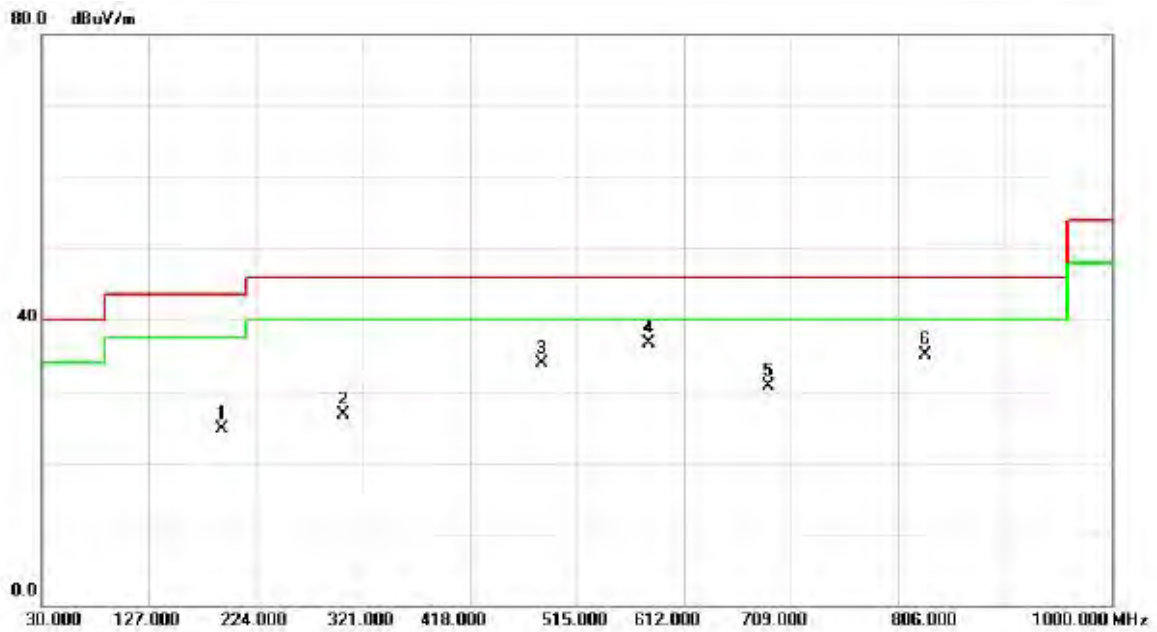

No.	Mk.	Freq. MHz	Reading Level dBuV	Correct Factor dB	Measure- ment dBuV/m	Limit dBuV/m	Margin dB	Detector	Comment
1		192.9600	39.29	-14.54	24.75	43.50	-18.75	peak	
2		303.5400	37.78	-11.05	26.73	46.00	-19.27	peak	
3		482.9900	43.85	-9.87	33.98	46.00	-12.02	peak	
4	*	579.9900	44.53	-7.92	36.61	46.00	-9.39	peak	
5		688.6300	35.65	-4.98	30.67	46.00	-15.33	peak	
6		831.2200	38.14	-3.05	35.09	46.00	-10.91	peak	

Test Mode: TX B MODE CHANNEL 01

Horizontal

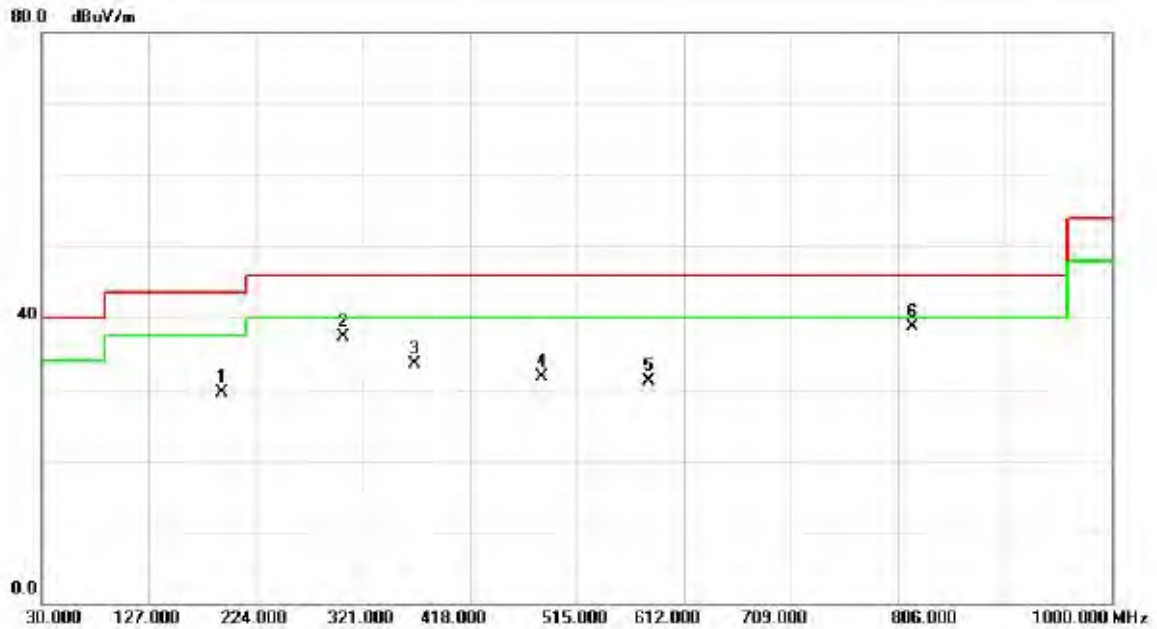

No.	Mk.	Freq. MHz	Reading Level dBuV	Correct Factor dB	Measure- ment dBuV/m	Limit dBuV/m	Margin dB	Detector	Comment
1		192.9600	44.08	-14.54	29.54	43.50	-13.96	peak	
2		303.5400	48.38	-11.05	37.33	46.00	-8.67	peak	
3		368.5300	44.50	-10.95	33.55	46.00	-12.45	peak	
4		482.9900	41.51	-9.87	31.64	46.00	-14.36	peak	
5		579.9900	39.11	-7.92	31.19	46.00	-14.81	peak	
6	*	819.5800	41.78	-2.99	38.79	46.00	-7.21	peak	

Test Mode: TX B MODE CHANNEL 06

Vertical

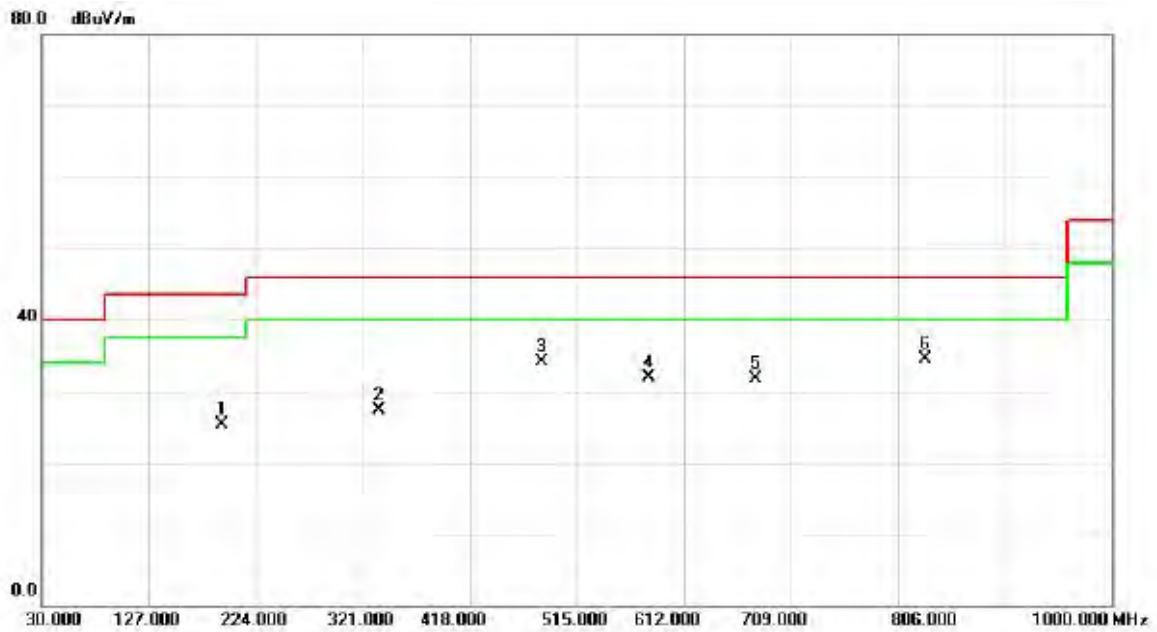

No.	Mk.	Freq. MHz	Reading Level dBuV	Correct Factor dB	Measure- ment dBuV/m	Limit dBuV/m	Margin dB	Detector	Comment
1		192.9600	39.85	-14.54	25.31	43.50	-18.19	peak	
2		335.5500	38.87	-11.56	27.31	46.00	-18.69	peak	
3		482.9900	43.96	-9.87	34.09	46.00	-11.91	peak	
4		579.9900	39.84	-7.92	31.92	46.00	-14.08	peak	
5		676.9900	36.84	-5.04	31.80	46.00	-14.20	peak	
6	*	831.2200	37.62	-3.05	34.57	46.00	-11.43	peak	

Test Mode: TX B MODE CHANNEL 06

### Horizontal

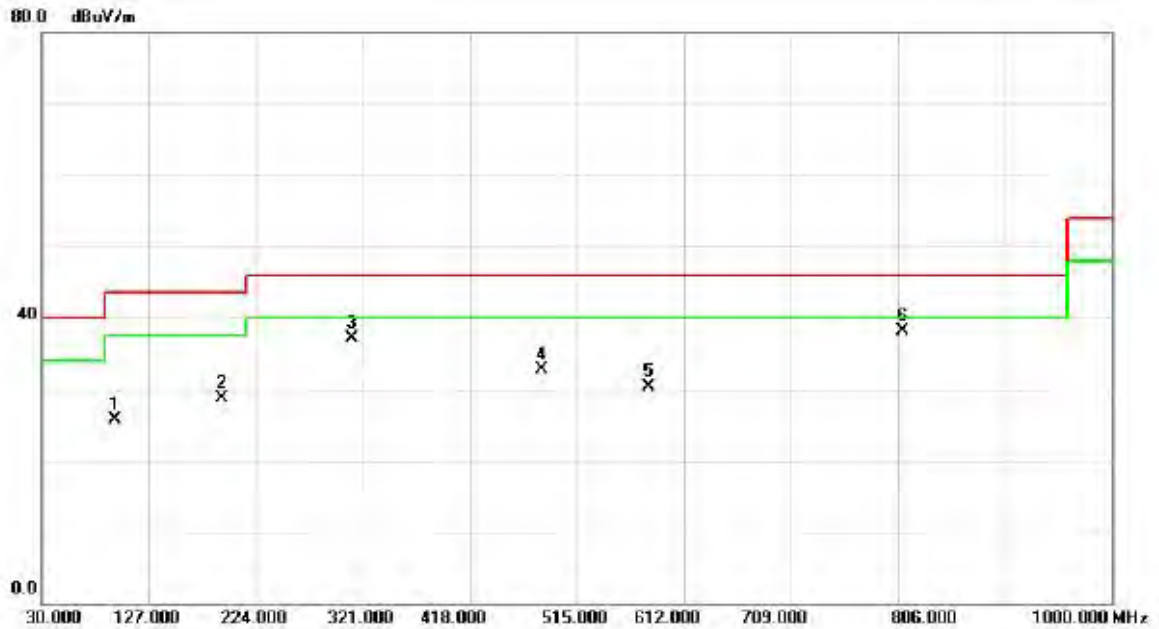

No.	Mk.	Freq. MHz	Reading Level dBuV	Correct Factor dB	Measure- ment dBuV/m	Limit dBuV/m	Margin dB	Detector	Comment
1		96.9300	42.50	-16.84	25.66	43.50	-17.84	peak	
2		192.9600	43.32	-14.54	28.78	43.50	-14.72	peak	
3		311.3000	48.24	-11.17	37.07	46.00	-8.93	peak	
4		482.9900	42.48	-9.87	32.61	46.00	-13.39	peak	
5		579.9900	38.28	-7.92	30.36	46.00	-15.64	peak	
6	*	810.8500	41.12	-2.95	38.17	46.00	-7.83	peak	



Test Mode: TX B MODE CHANNEL 11

Vertical

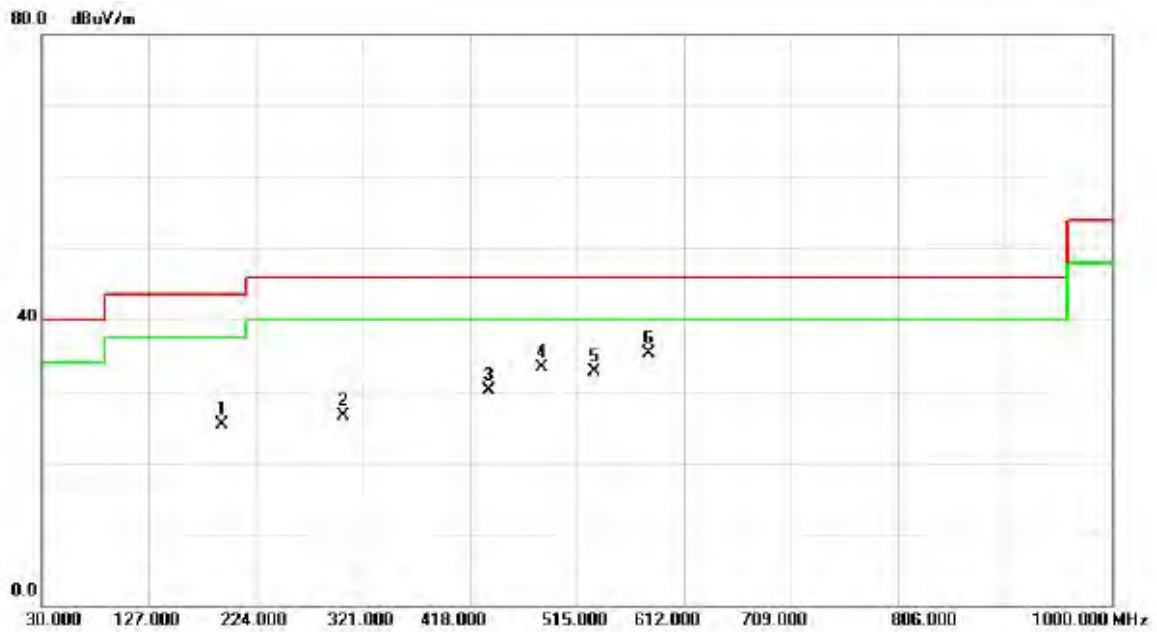

No.	Mk.	Freq. MHz	Reading Level dBuV	Correct Factor dB	Measure- ment dBuV/m	Limit dBuV/m	Margin dB	Detector	Comment
1		192.9600	39.76	-14.54	25.22	43.50	-18.28	peak	
2		303.5400	37.46	-11.05	26.41	46.00	-19.59	peak	
3		435.4600	38.92	-8.88	30.04	46.00	-15.96	peak	
4		482.9900	43.18	-9.87	33.31	46.00	-12.69	peak	
5		531.4900	41.55	-8.89	32.66	46.00	-13.34	peak	
6	*	579.9900	43.29	-7.92	35.37	46.00	-10.63	peak	

Test Mode: TX B MODE CHANNEL 11

Horizontal

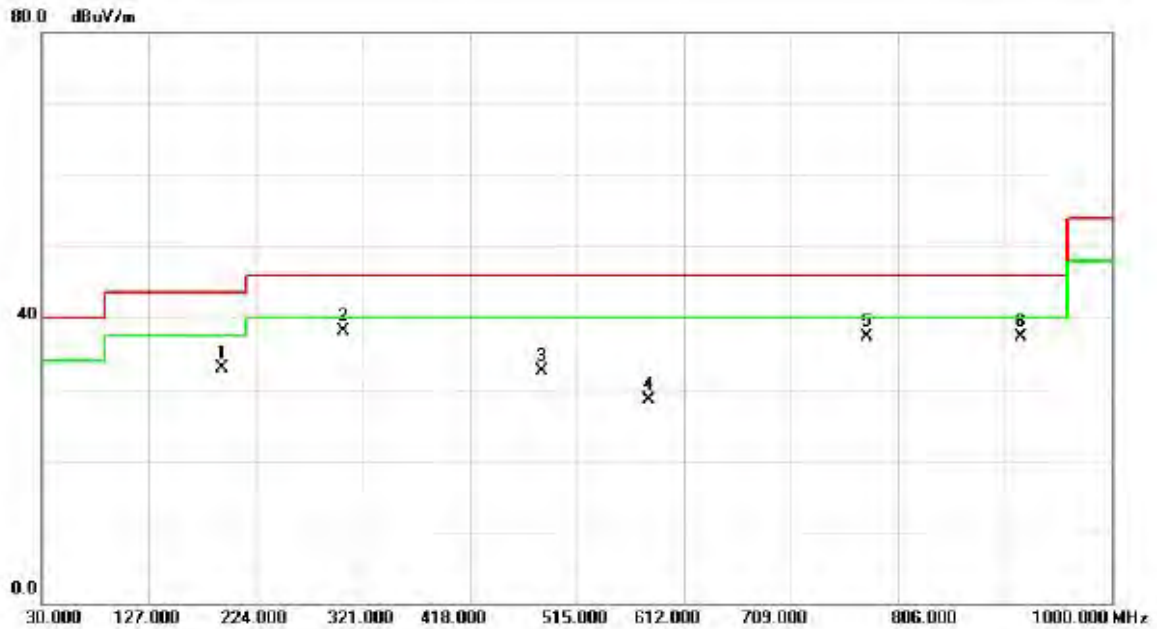

No.	Mk.	Freq. MHz	Reading Level dBuV	Correct Factor dB	Measure- ment dBuV/m	Limit dBuV/m	Margin dB	Detector	Comment
1		192.9600	47.37	-14.54	32.83	43.50	-10.67	peak	
2	*	303.5400	49.14	-11.05	38.09	46.00	-7.91	peak	
3		482.9900	42.43	-9.87	32.56	46.00	-13.44	peak	
4		579.9900	36.34	-7.92	28.42	46.00	-17.58	peak	
5		777.8700	41.03	-3.66	37.37	46.00	-8.63	peak	
6		917.5500	38.47	-1.07	37.40	46.00	-8.60	peak	

**ATTACHMENT D - RADIATED EMISSION (ABOVE 1000MHZ)**

Orthogonal Axis :	X
Test Mode :	TX B MODE 2412MHz

### Vertical

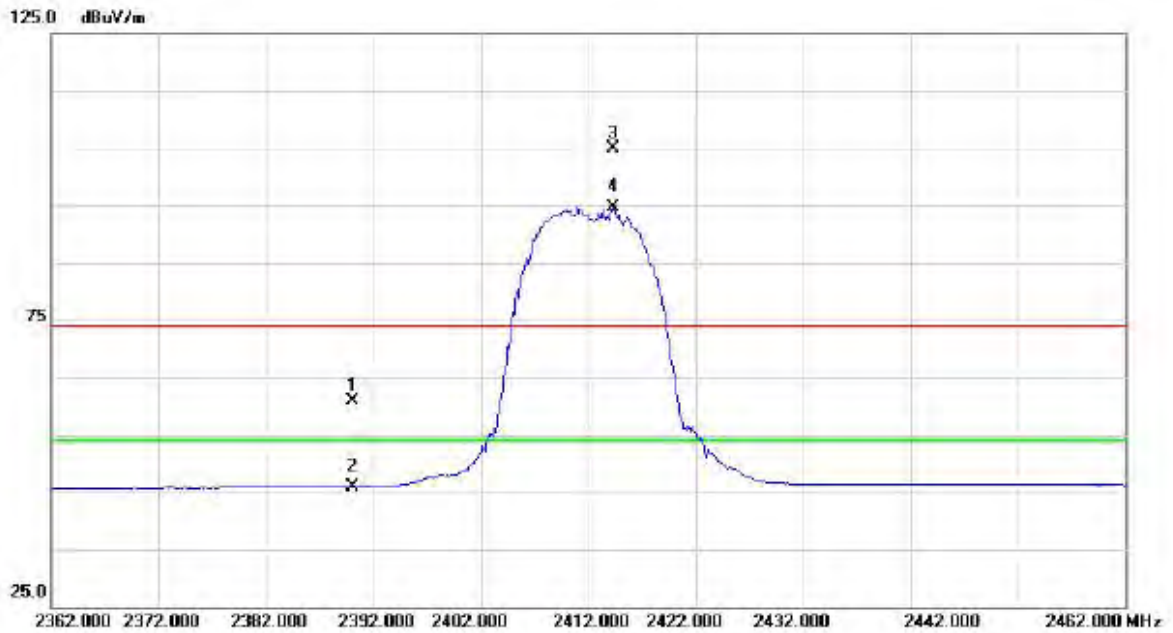

No.	Mk.	Freq. MHz	Reading Level dBuV	Correct Factor dB	Measure- ment dBuV/m	Limit dBuV/m	Margin dB	Detector	Comment
1		2390.000	28.88	31.88	60.76	74.00	-13.24	peak	
2		2390.000	14.08	31.88	45.96	54.00	-8.04	AVG	
3	X	2414.300	73.08	31.91	104.99	74.00	30.99	peak	NO LIMIT
4	*	2414.300	62.75	31.91	94.66	54.00	40.66	AVG	NO LIMIT

Orthogonal Axis :	X
Test Mode :	TX B MODE 2412MHz

### Vertical

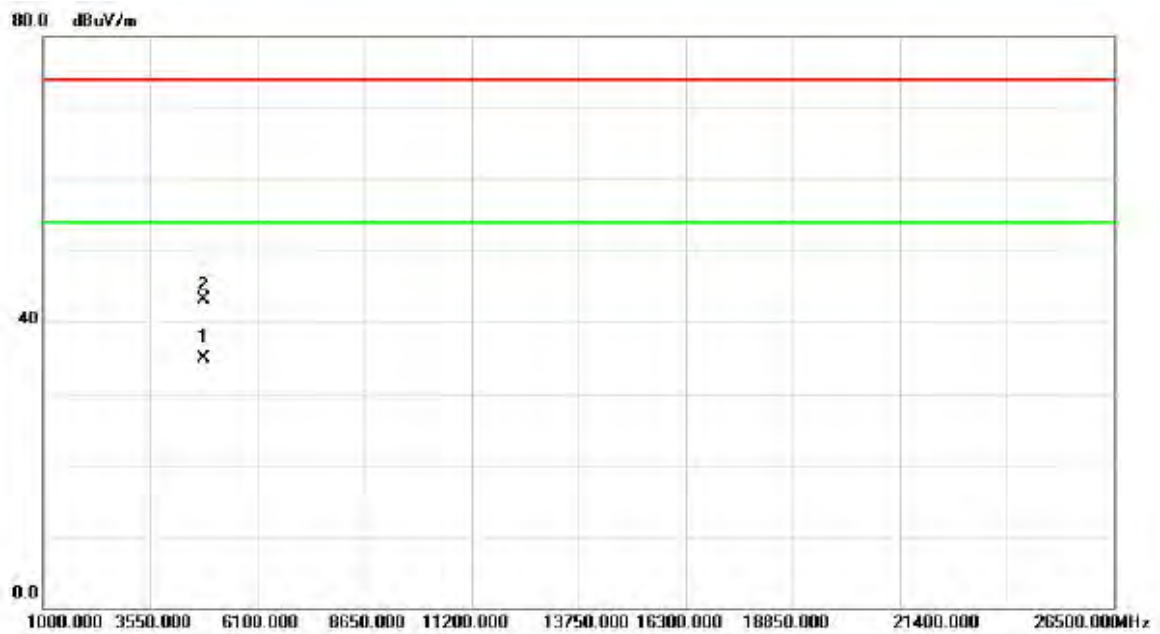

No.	Mk.	Freq. MHz	Reading Level dBuV	Correct Factor dB	Measure- ment dBuV/m	Limit dBuV/m	Margin dB	Detector	Comment
1	*	4823.900	37.19	-2.32	34.87	54.00	-19.13	AVG	
2		4824.000	45.48	-2.32	43.16	74.00	-30.84	peak	

Orthogonal Axis :	X
Test Mode :	TX B MODE 2412MHz

### Horizontal

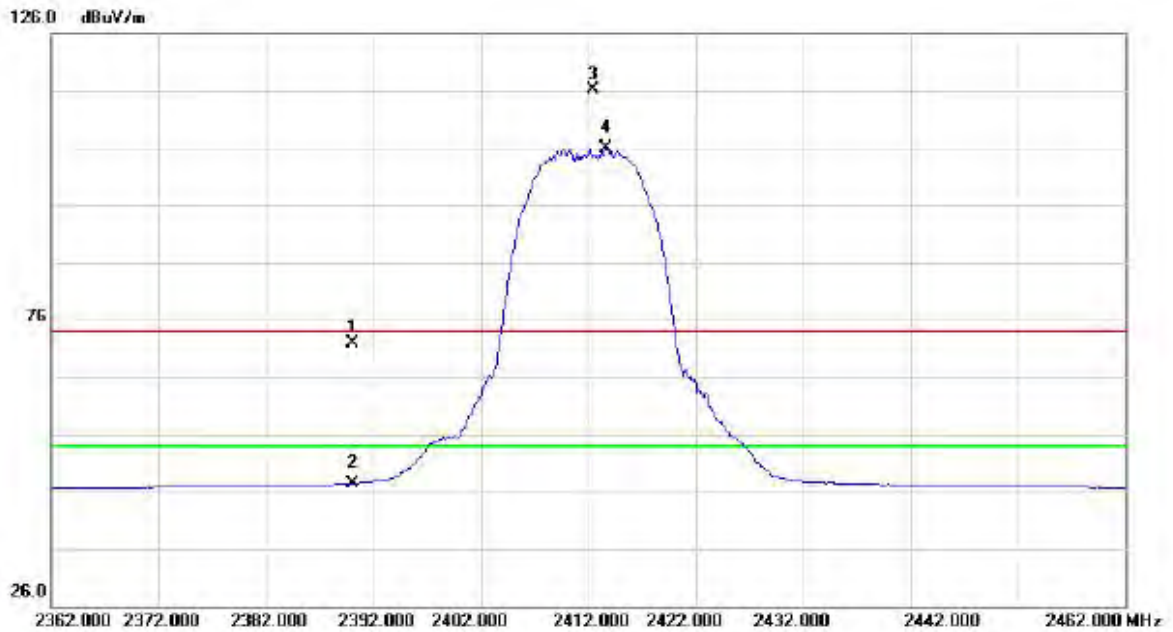

No.	Mk.	Freq. MHz	Reading Level dBuV	Correct Factor dB	Measure- ment dBuV/m	Limit dBuV/m	Margin dB	Detector	Comment
1		2390.000	40.01	31.88	71.89	74.00	-2.11	peak	
2		2390.000	15.56	31.88	47.44	54.00	-6.56	AVG	
3	X	2412.500	84.25	31.91	116.16	74.00	42.16	peak	NO LIMIT
4	*	2413.700	73.94	31.91	105.85	54.00	51.85	AVG	NO LIMIT

Orthogonal Axis :	X
Test Mode :	TX B MODE 2412MHz

### Horizontal

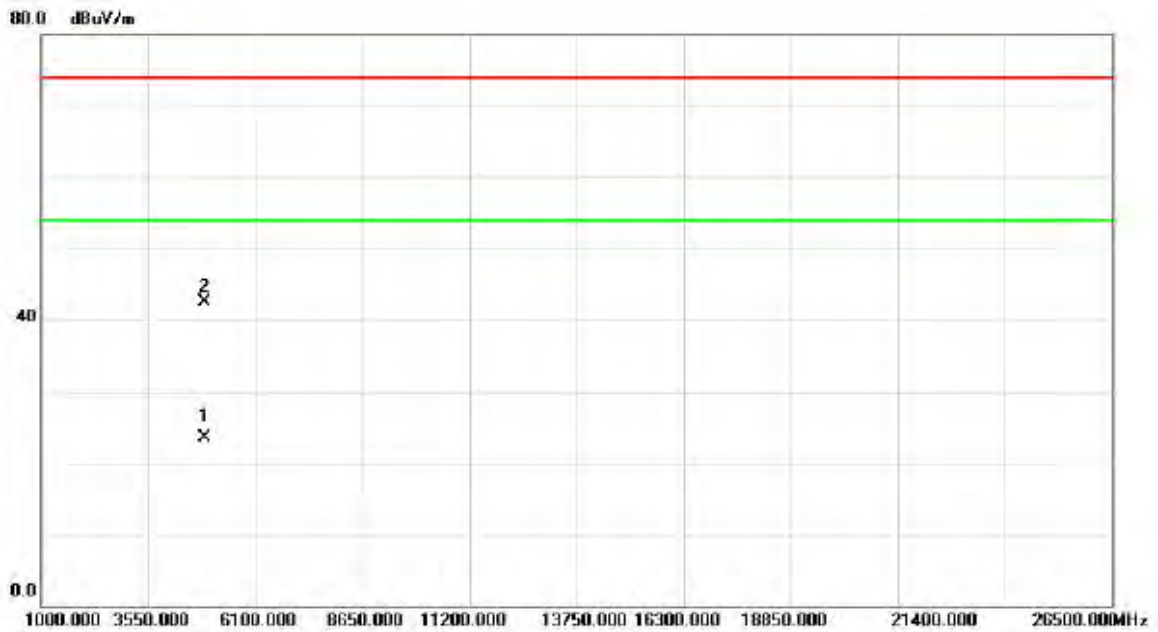

No.	Mk.	Freq. MHz	Reading Level dBuV	Correct Factor dB	Measure- ment dBuV/m	Limit dBuV/m	Margin dB	Detector	Comment
1	*	4897.400	25.71	-2.20	23.51	54.00	-30.49	AVG	
2		4900.100	44.64	-2.21	42.43	74.00	-31.57	peak	

Orthogonal Axis :	X
Test Mode :	TX B MODE 2437MHz

### Vertical

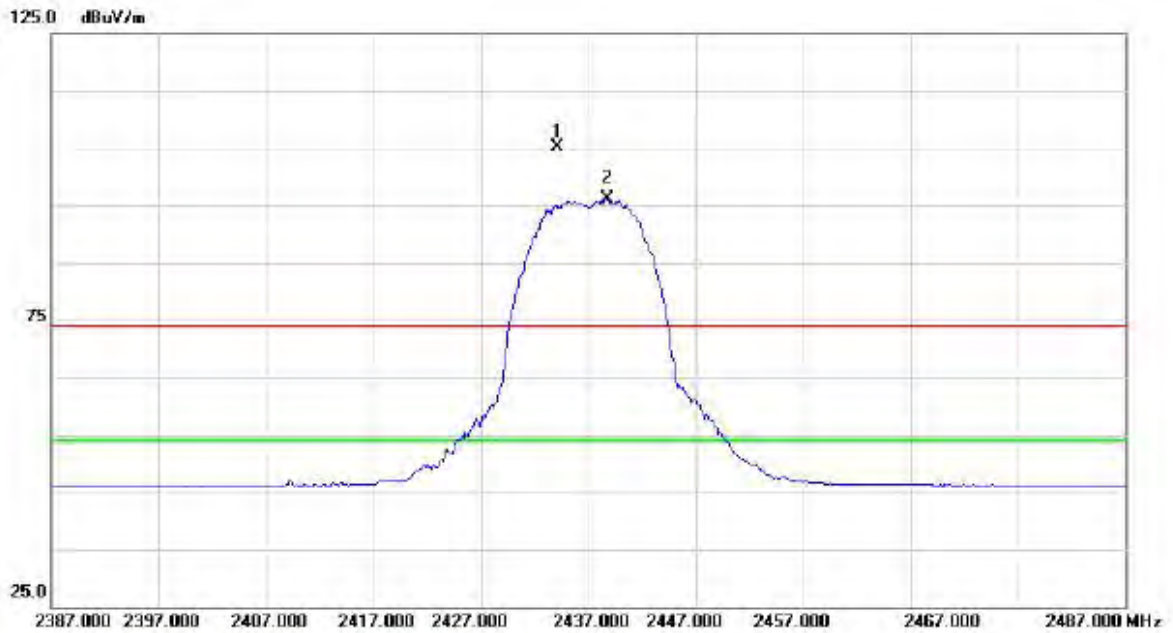

No.	Mk.	Freq.	Reading Level	Correct Factor	Measurement	Limit	Margin		
		MHz	dBuV	dB	dBuV/m	dBuV/m	dB	Detector	Comment
1	X	2434.200	73.30	31.94	105.24	74.00	31.24	peak	NO LIMIT
2	*	2438.800	64.30	31.94	96.24	54.00	42.24	AVG	NO LIMIT



Orthogonal Axis :	X
Test Mode :	TX B MODE 2437MHz

### Vertical

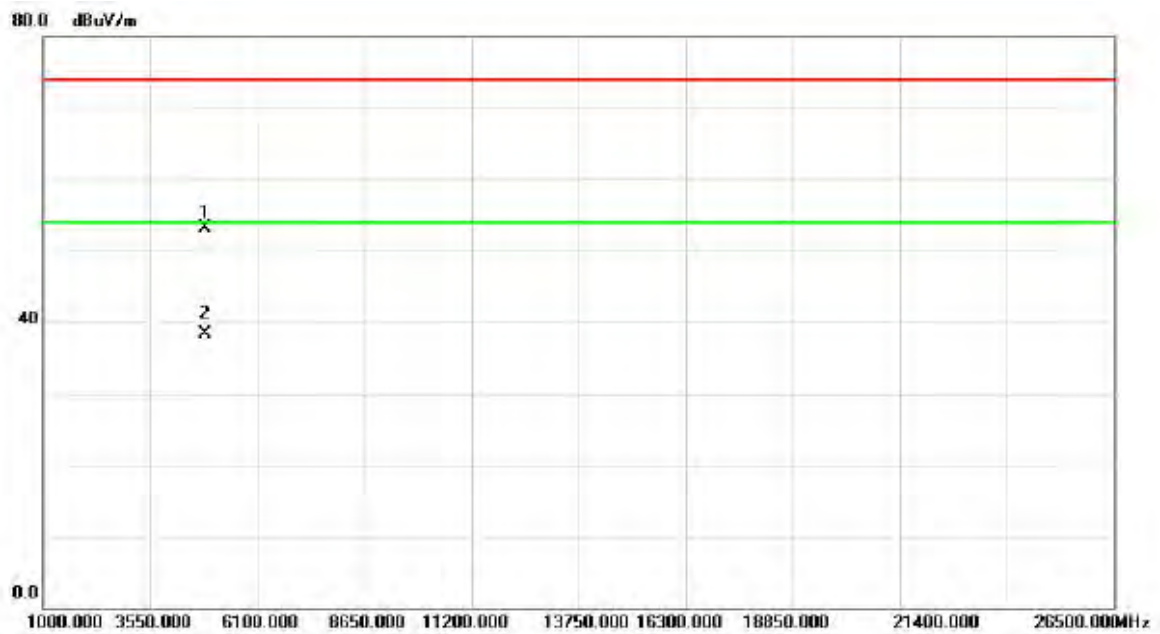

No.	Mk.	Freq. MHz	Reading Level dBuV	Correct Factor dB	Measure- ment dBuV/m	Limit dBuV/m	Margin dB	Detector	Comment
1		4870.900	55.27	-2.25	53.02	74.00	-20.98	peak	
2	*	4874.900	40.48	-2.24	38.24	54.00	-15.76	AVG	

Orthogonal Axis :	X
Test Mode :	TX B MODE 2437MHz

### Horizontal

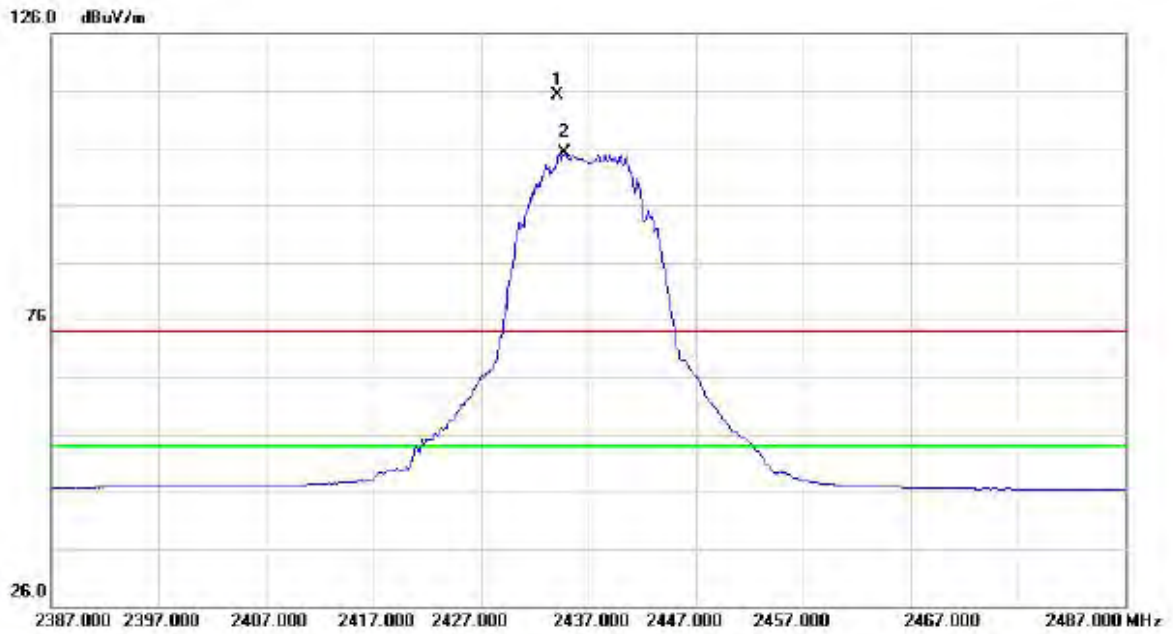

No.	Mk.	Freq. MHz	Reading Level dBuV	Correct Factor dB	Measure- ment dBuV/m	Limit dBuV/m	Margin dB	Detector	Comment
1	X	2434.200	83.24	31.94	115.18	74.00	41.18	peak	NO LIMIT
2	*	2434.800	73.17	31.94	105.11	54.00	51.11	AVG	NO LIMIT

Orthogonal Axis :	X
Test Mode :	TX B MODE 2437MHz

### Horizontal

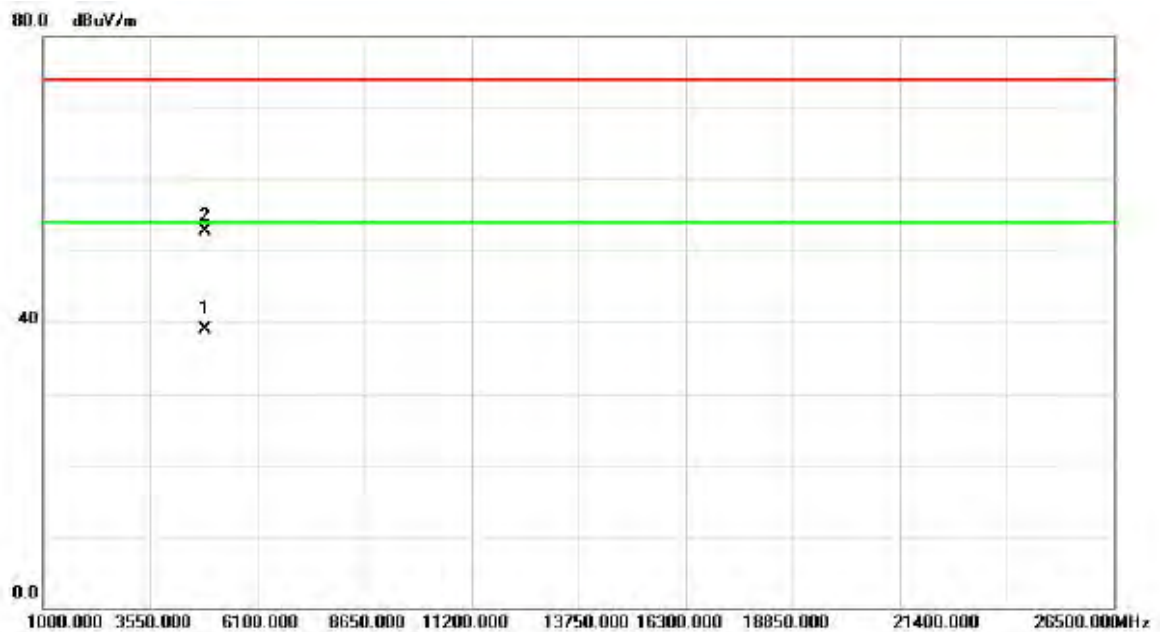

No.	Mk.	Freq. MHz	Reading Level dBuV	Correct Factor dB	Measure- ment dBuV/m	Limit dBuV/m	Margin dB	Detector	Comment
1	*	4874.200	41.23	-2.24	38.99	54.00	-15.01	AVG	
2		4875.900	54.87	-2.24	52.63	74.00	-21.37	peak	

Orthogonal Axis :	X
Test Mode :	TX B MODE 2462MHz

### Vertical

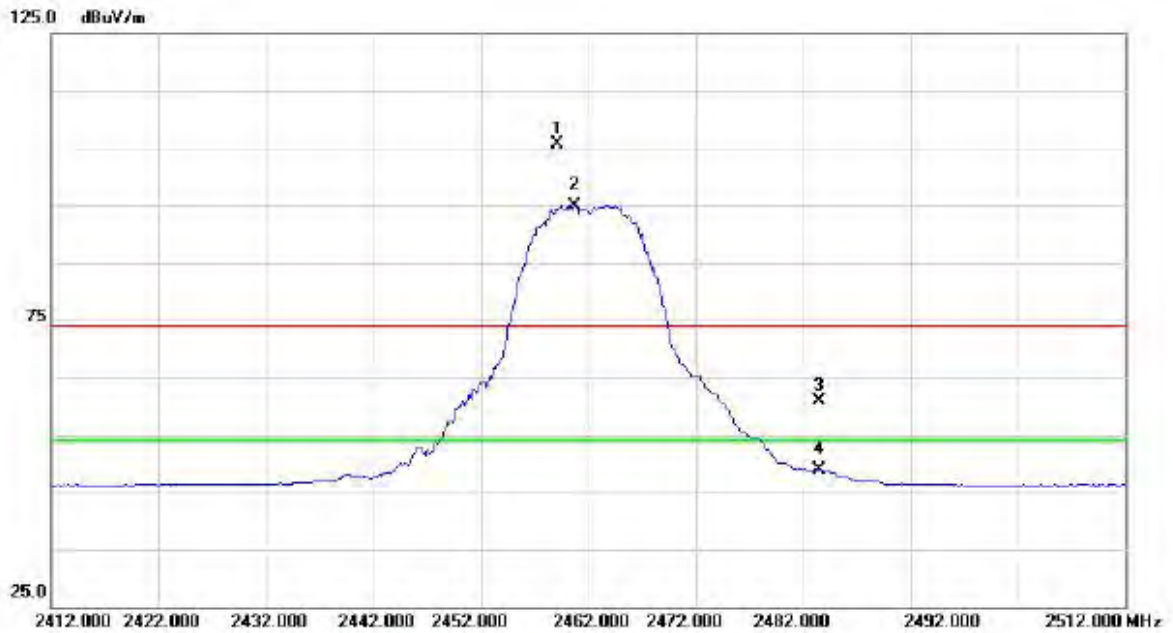

No.	Mk.	Freq. MHz	Reading Level dBuV	Correct Factor dB	Measure- ment dBuV/m	Limit dBuV/m	Margin dB	Detector	Comment
1	X	2459.200	73.64	31.98	105.62	74.00	31.62	peak	NO LIMIT
2	*	2460.700	62.98	31.98	94.96	54.00	40.96	AVG	NO LIMIT
3		2483.500	28.76	32.01	60.77	74.00	-13.23	peak	
4		2483.500	16.94	32.01	48.95	54.00	-5.05	AVG	

Orthogonal Axis :	X
Test Mode :	TX B MODE 2462MHz

### Vertical

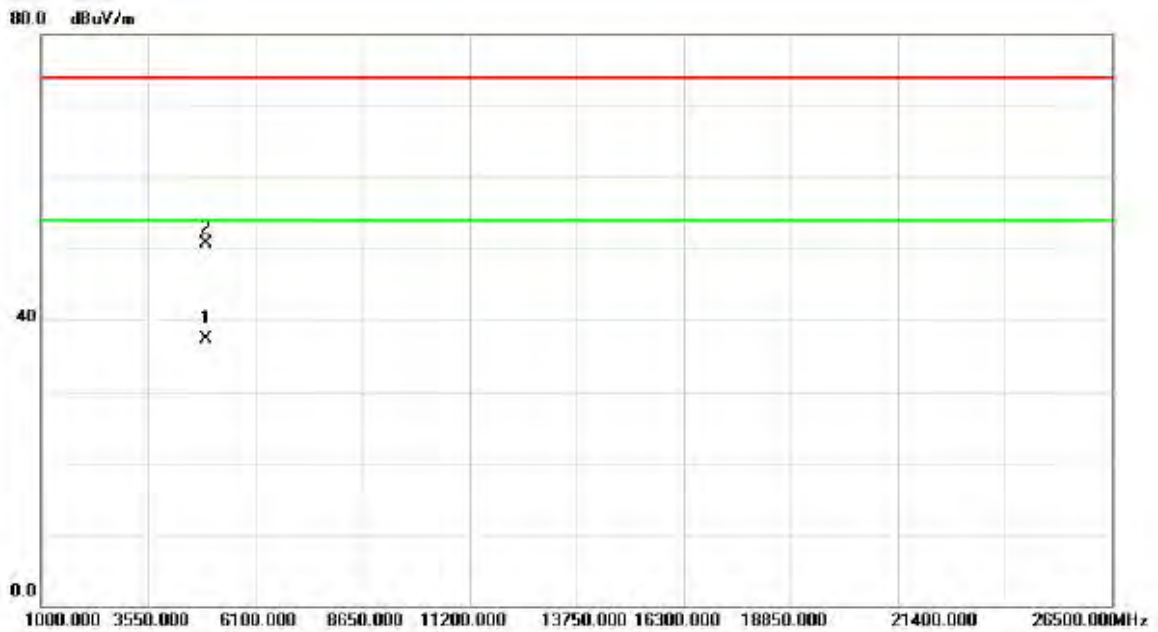

No.	Mk.	Freq. MHz	Reading Level dBuV	Correct Factor dB	Measure- ment dBuV/m	Limit dBuV/m	Margin dB	Detector	Comment
1	*	4918.400	39.46	-2.18	37.28	54.00	-16.72	AVG	
2		4923.900	52.83	-2.17	50.66	74.00	-23.34	peak	

Orthogonal Axis :	X
Test Mode :	TX B MODE 2462MHz

### Horizontal

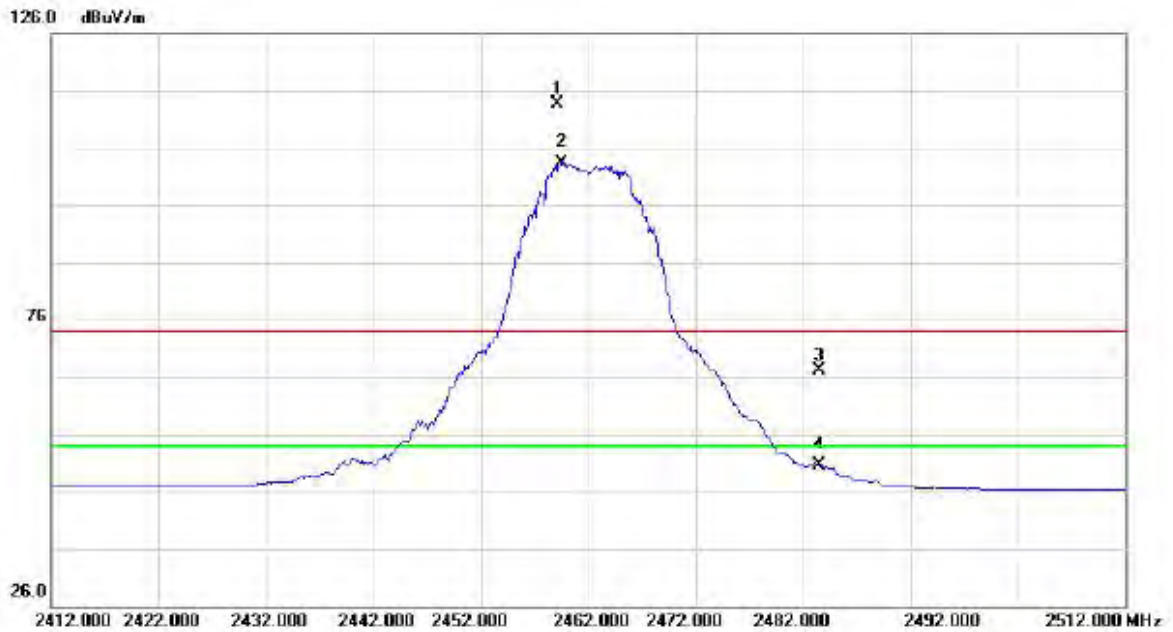

No.	Mk.	Freq. MHz	Reading Level dBuV	Correct Factor dB	Measure- ment dBuV/m	Limit dBuV/m	Margin dB	Detector	Comment
1	X	2459.100	81.69	31.98	113.67	74.00	39.67	peak	NO LIMIT
2	*	2459.600	71.32	31.98	103.30	54.00	49.30	AVG	NO LIMIT
3		2483.500	35.01	32.01	67.02	74.00	-6.98	peak	
4		2483.500	18.58	32.01	50.59	54.00	-3.41	AVG	

Orthogonal Axis :	X
Test Mode :	TX B MODE 2462MHz

### Horizontal

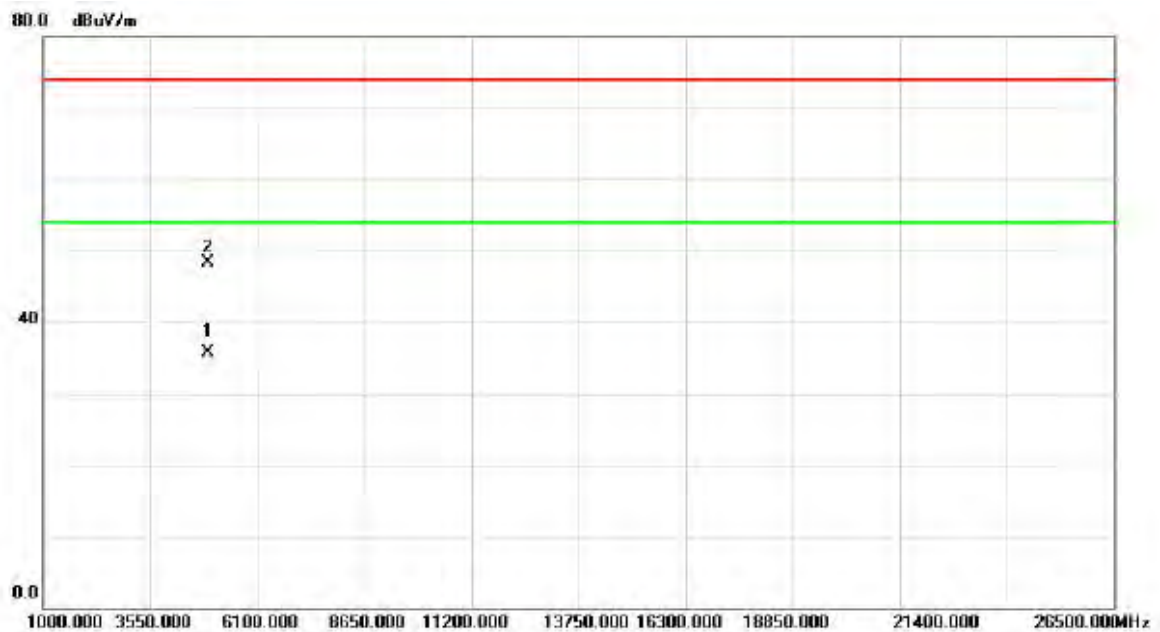

No.	Mk.	Freq. MHz	Reading Level dBuV	Correct Factor dB	Measure- ment dBuV/m	Limit dBuV/m	Margin dB	Detector	Comment
1	*	4924.800	37.96	-2.17	35.79	54.00	-18.21	AVG	
2		4923.800	50.49	-2.17	48.32	74.00	-25.68	peak	

Orthogonal Axis :	X
Test Mode :	TX G MODE 2412MHz

### Vertical

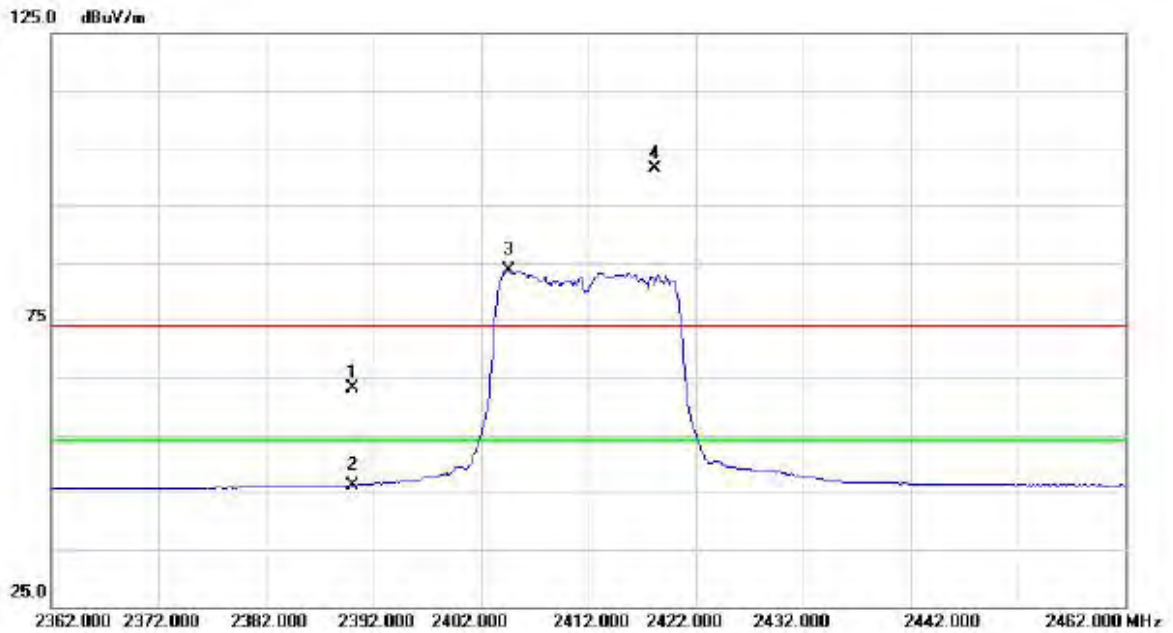

No.	Mk.	Freq. MHz	Reading Level dBuV	Correct Factor dB	Measure- ment dBuV/m	Limit dBuV/m	Margin dB	Detector	Comment
1		2390.000	31.20	31.88	63.08	74.00	-10.92	peak	
2		2390.000	14.35	31.88	46.23	54.00	-7.77	AVG	
3	*	2404.600	51.73	31.89	83.62	54.00	29.62	AVG	NO LIMIT
4	X	2418.200	69.35	31.91	101.26	74.00	27.26	peak	NO LIMIT



Orthogonal Axis :	X
Test Mode :	TX G MODE 2412MHz

### Vertical

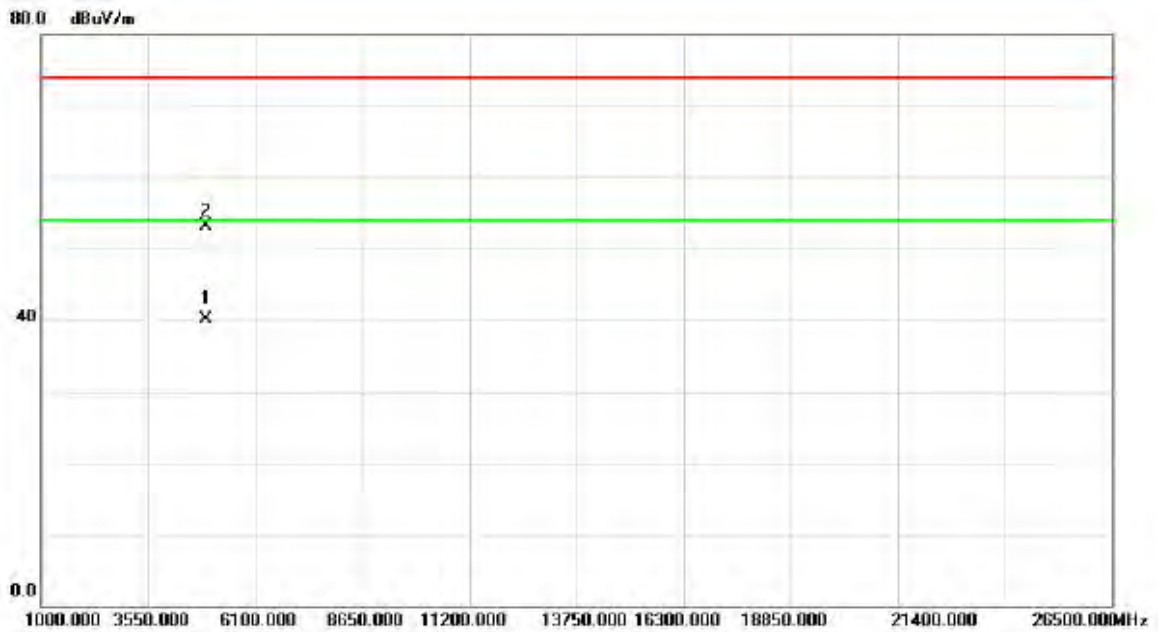

No.	Mk.	Freq. MHz	Reading Level dBuV	Correct Factor dB	Measure- ment dBuV/m	Limit dBuV/m	Margin dB	Detector	Comment
1	*	4919.000	42.28	-2.18	40.10	54.00	-13.90	AVG	
2		4923.900	55.30	-2.17	53.13	74.00	-20.87	peak	

Orthogonal Axis :	X
Test Mode :	TX G MODE 2412MHz

### Horizontal

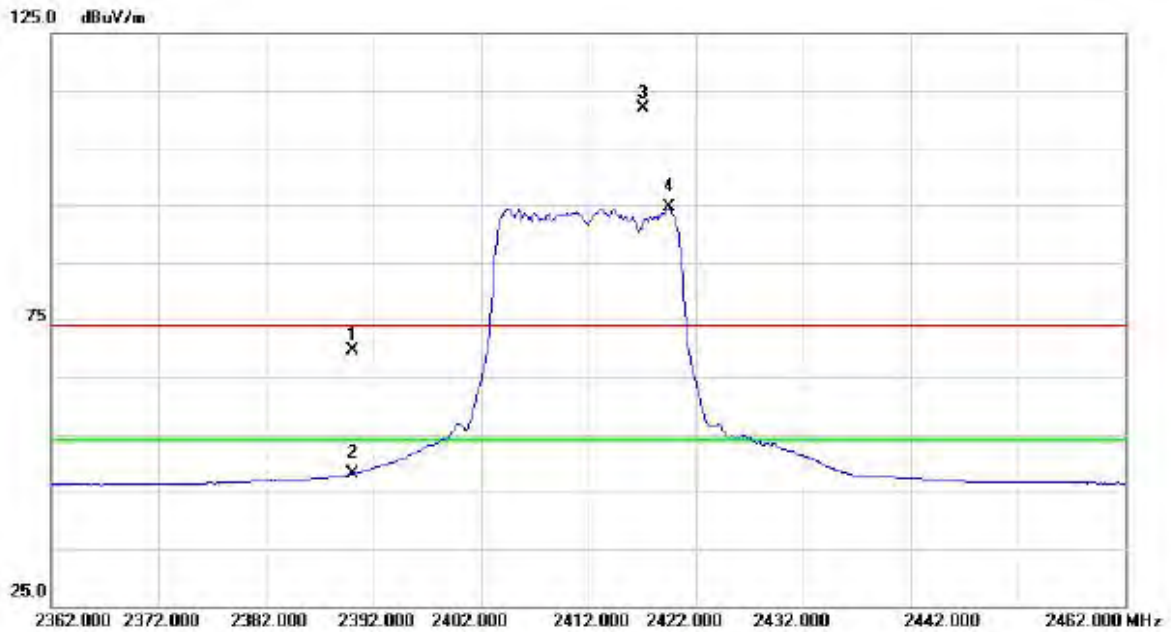

No.	Mk.	Freq. MHz	Reading Level dBuV	Correct Factor dB	Measure- ment dBuV/m	Limit dBuV/m	Margin dB	Detector	Comment
1		2390.000	37.71	31.88	69.59	74.00	-4.41	peak	
2		2390.000	16.24	31.88	48.12	54.00	-5.88	AVG	
3	X	2417.200	79.95	31.91	111.86	74.00	37.86	peak	NO LIMIT
4	*	2419.500	62.63	31.92	94.55	54.00	40.55	AVG	NO LIMIT

Orthogonal Axis :	X
Test Mode :	TX G MODE 2412MHz

### Horizontal

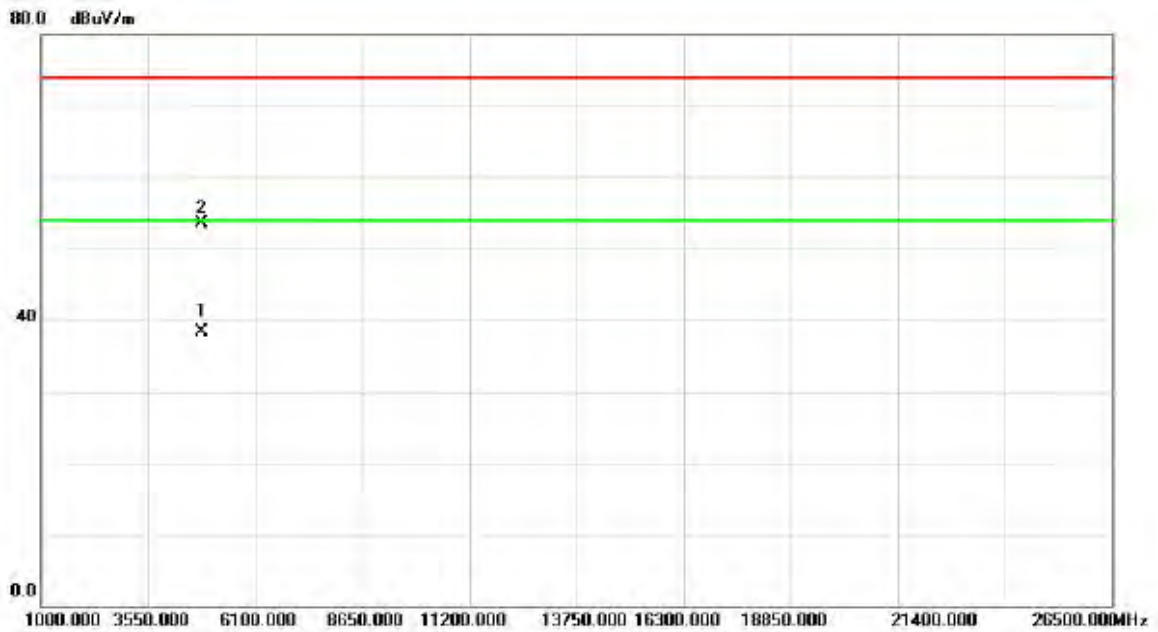

No.	Mk.	Freq. MHz	Reading Level dBuV	Correct Factor dB	Measure- ment dBuV/m	Limit dBuV/m	Margin dB	Detector	Comment
1	*	4822.700	40.70	-2.32	38.38	54.00	-15.62	AVG	
2		4823.900	55.87	-2.32	53.55	74.00	-20.45	peak	

Orthogonal Axis :	X
Test Mode :	TX G MODE 2437MHz

**Vertical**

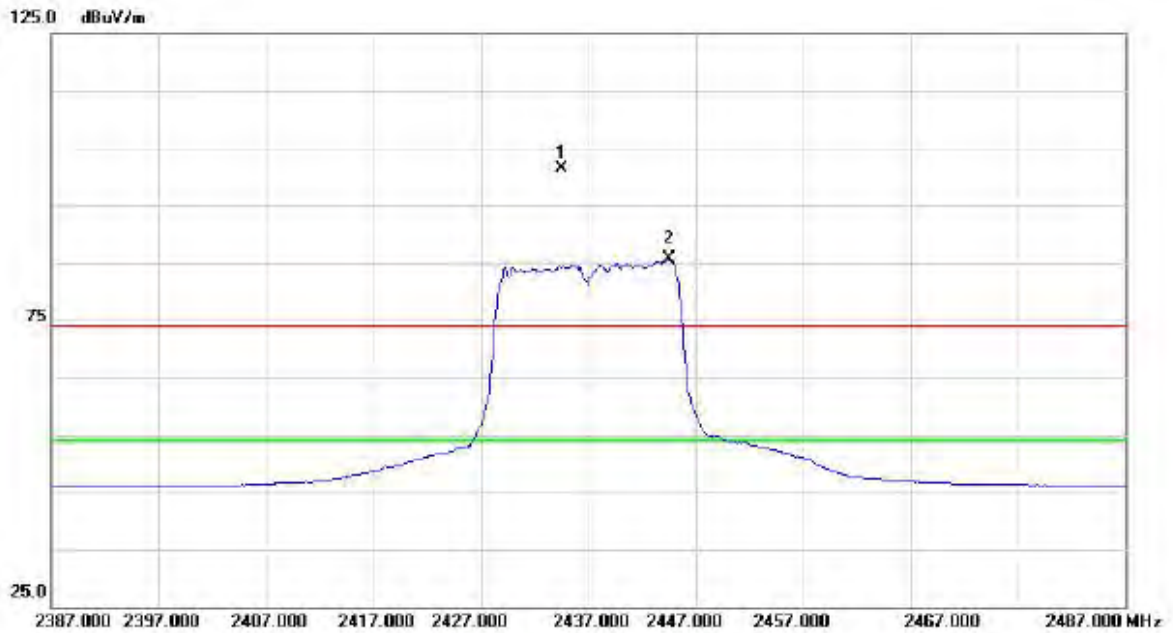

No.	Mk.	Freq.	Reading Level	Correct Factor	Measurement	Limit	Margin		
		MHz	dBuV	dB	dBuV/m	dBuV/m	dB	Detector	Comment
1	X	2434.500	69.42	31.94	101.36	74.00	27.36	peak	NO LIMIT
2	*	2444.500	53.78	31.96	85.74	54.00	31.74	AVG	NO LIMIT

Orthogonal Axis :	X
Test Mode :	TX G MODE 2437MHz

### Vertical

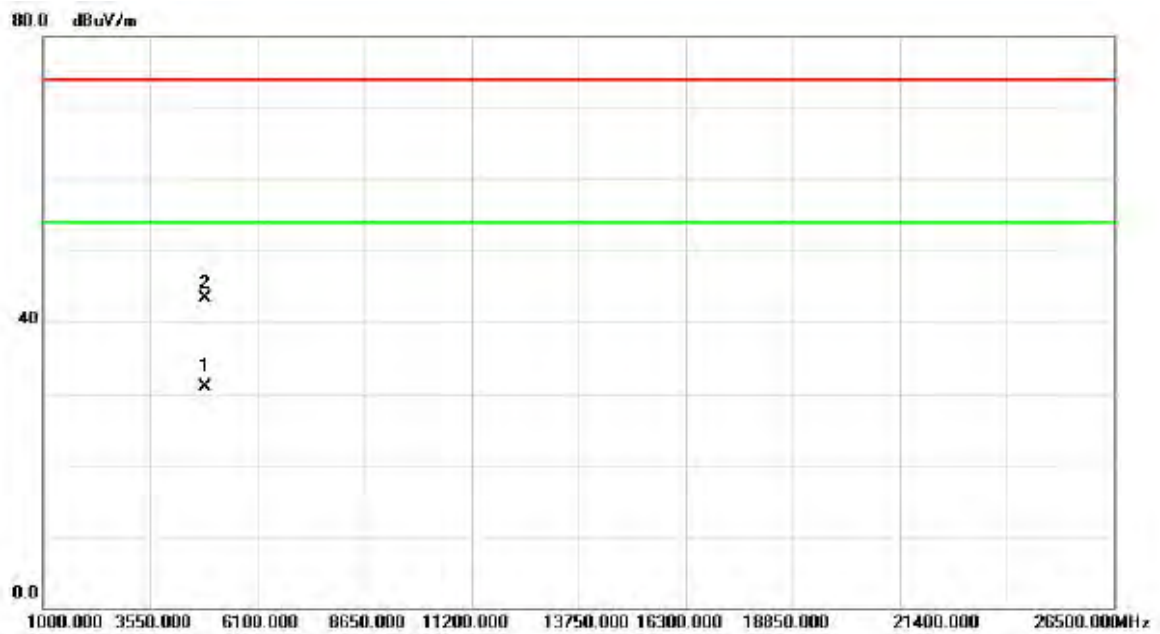

No.	Mk.	Freq. MHz	Reading Level dBuV	Correct Factor dB	Measure- ment dBuV/m	Limit dBuV/m	Margin dB	Detector	Comment
1	*	4871.300	33.23	-2.25	30.98	54.00	-23.02	AVG	
2		4872.000	45.60	-2.24	43.36	74.00	-30.64	peak	

Orthogonal Axis :	X
Test Mode :	TX G MODE 2437MHz

### Horizontal

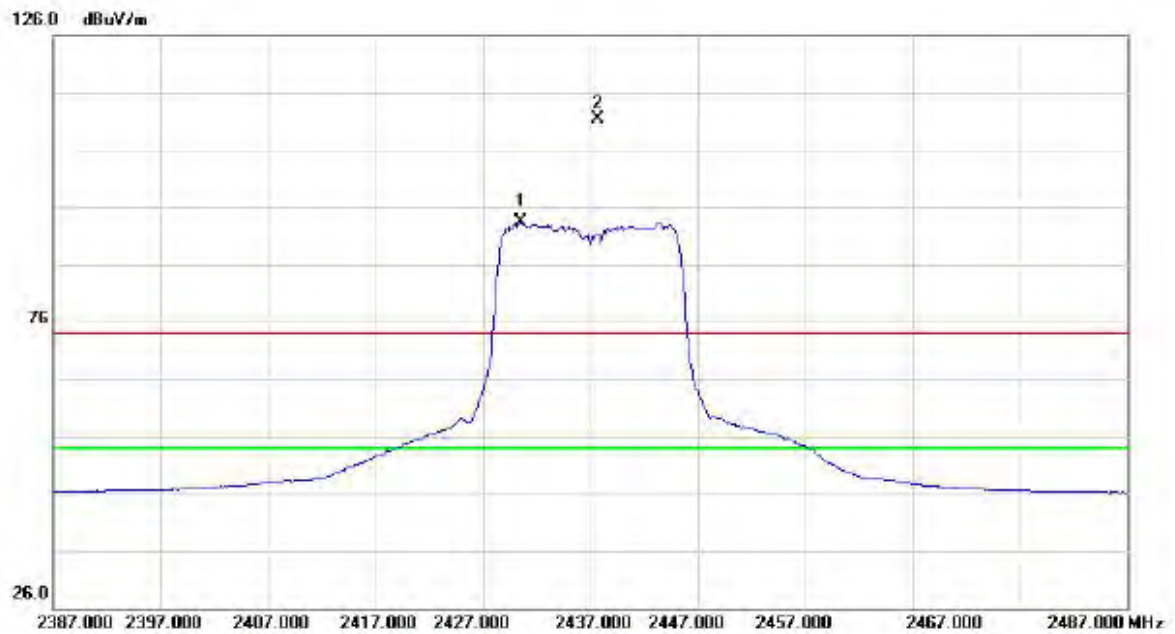

No.	Mk.	Freq. MHz	Reading Level dBuV	Correct Factor dB	Measure- ment dBuV/m	Limit dBuV/m	Margin dB	Detector	Comment
1	*	2430.500	61.45	31.93	93.38	54.00	39.38	AVG	NO LIMIT
2	X	2437.700	79.40	31.94	111.34	74.00	37.34	peak	NO LIMIT

Orthogonal Axis :	X
Test Mode :	TX G MODE 2437MHz

### Horizontal

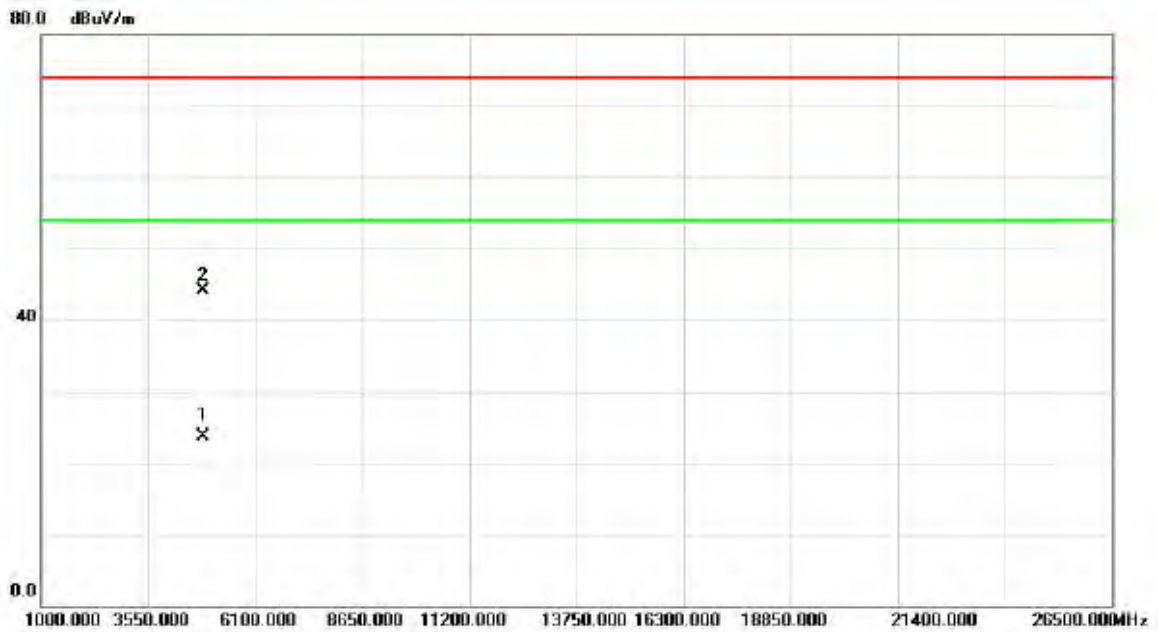

No.	Mk.	Freq. MHz	Reading Level dBuV	Correct Factor dB	Measure- ment dBuV/m	Limit dBuV/m	Margin dB	Detector	Comment
1		4870.800	25.86	-2.25	23.61	54.00	-30.39	AVG	
2	*	4873.800	46.29	-2.24	44.05	74.00	-29.95	peak	

Orthogonal Axis :	X
Test Mode :	TX G MODE 2462MHz

**Vertical**

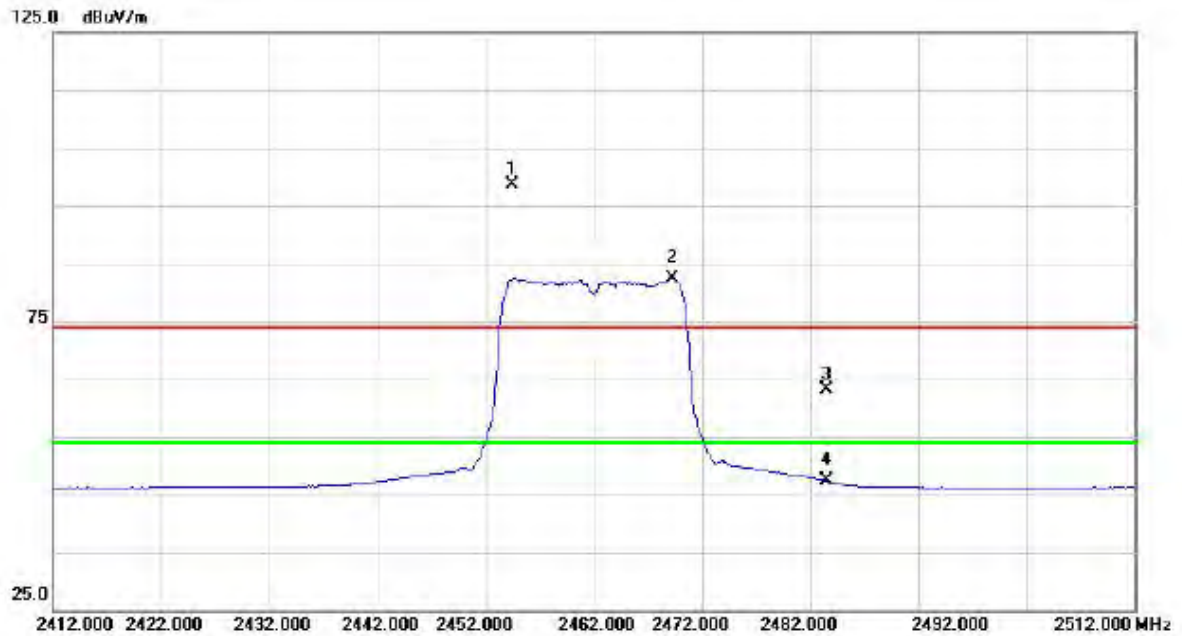

No.	Mk.	Freq. MHz	Reading Level dBuV	Correct Factor dB	Measure- ment dBuV/m	Limit dBuV/m	Margin dB	Detector	Comment
1	X	2454.500	66.78	31.96	98.74	74.00	24.74	peak	NO LIMIT
2	*	2469.300	50.50	31.99	82.49	54.00	28.49	AVG	NO LIMIT
3		2483.500	31.04	32.01	63.05	74.00	-10.95	peak	
4		2483.500	15.30	32.01	47.31	54.00	-6.69	AVG	



Orthogonal Axis :	X
Test Mode :	TX G MODE 2462MHz

### Vertical

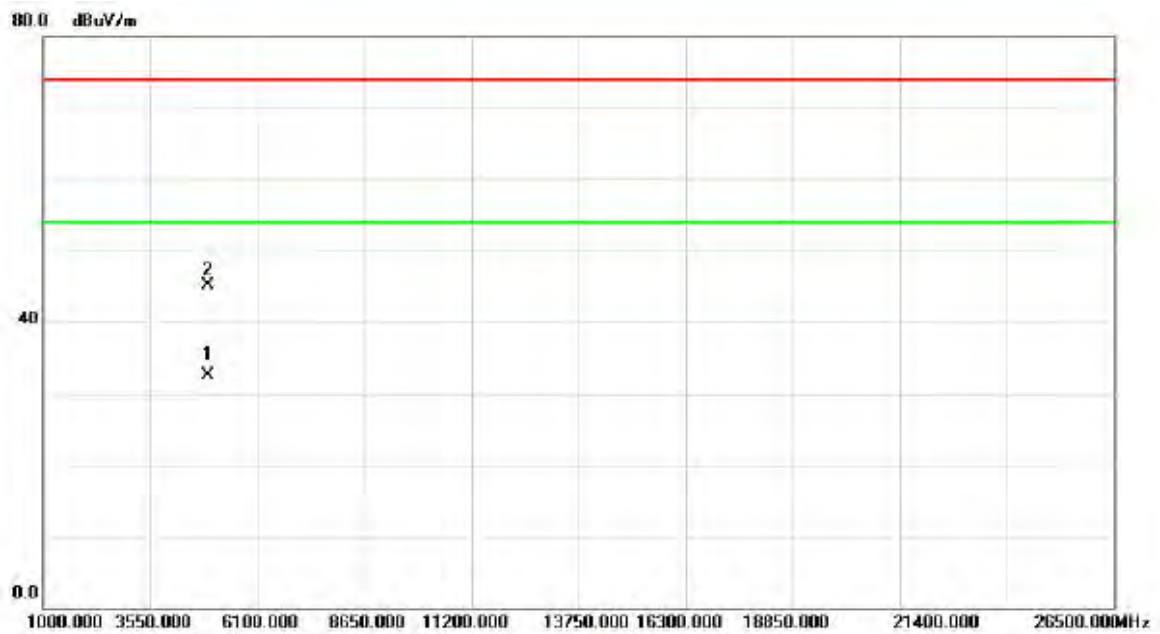

No.	Mk.	Freq. MHz	Reading Level dBuV	Correct Factor dB	Measure- ment dBuV/m	Limit dBuV/m	Margin dB	Detector	Comment
1	*	4924.800	34.65	-2.17	32.48	54.00	-21.52	AVG	
2		4923.300	47.30	-2.17	45.13	74.00	-28.87	peak	

Orthogonal Axis :	X
Test Mode :	TX G MODE 2462MHz

### Horizontal

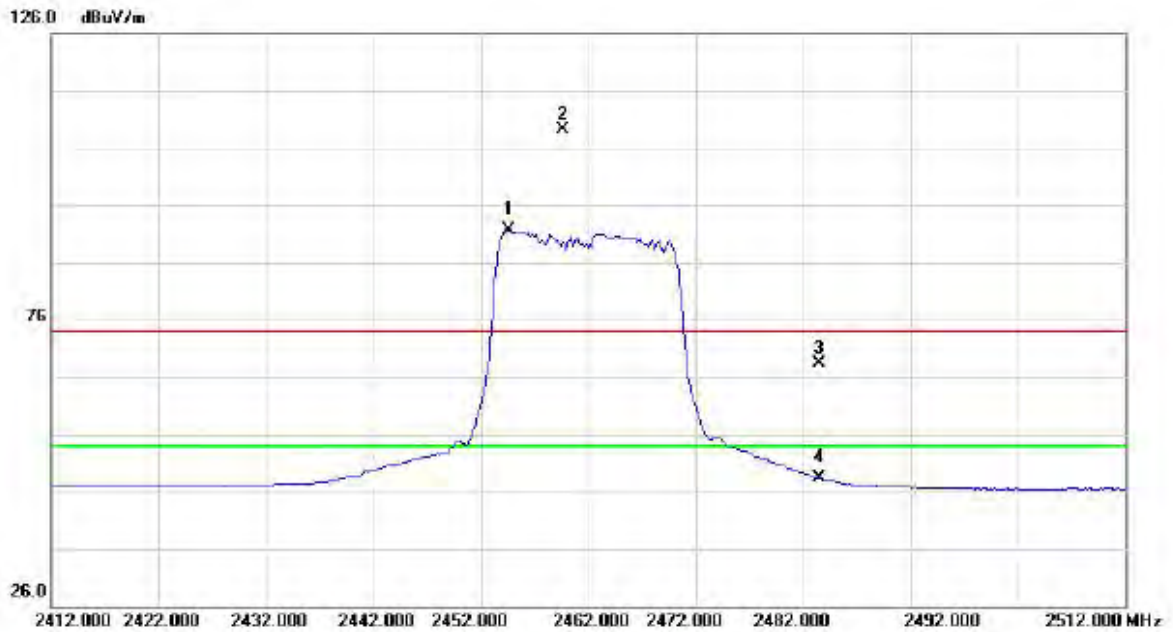

No.	Mk.	Freq. MHz	Reading Level dBuV	Correct Factor dB	Measure- ment dBuV/m	Limit dBuV/m	Margin dB	Detector	Comment
1	*	2454.600	59.63	31.96	91.59	54.00	37.59	AVG	NO LIMIT
2	X	2459.700	77.22	31.98	109.20	74.00	35.20	peak	NO LIMIT
3		2483.500	36.47	32.01	68.48	74.00	-5.52	peak	
4		2483.500	16.38	32.01	48.39	54.00	-5.61	AVG	

Orthogonal Axis :	X
Test Mode :	TX G MODE 2462MHz

### Horizontal

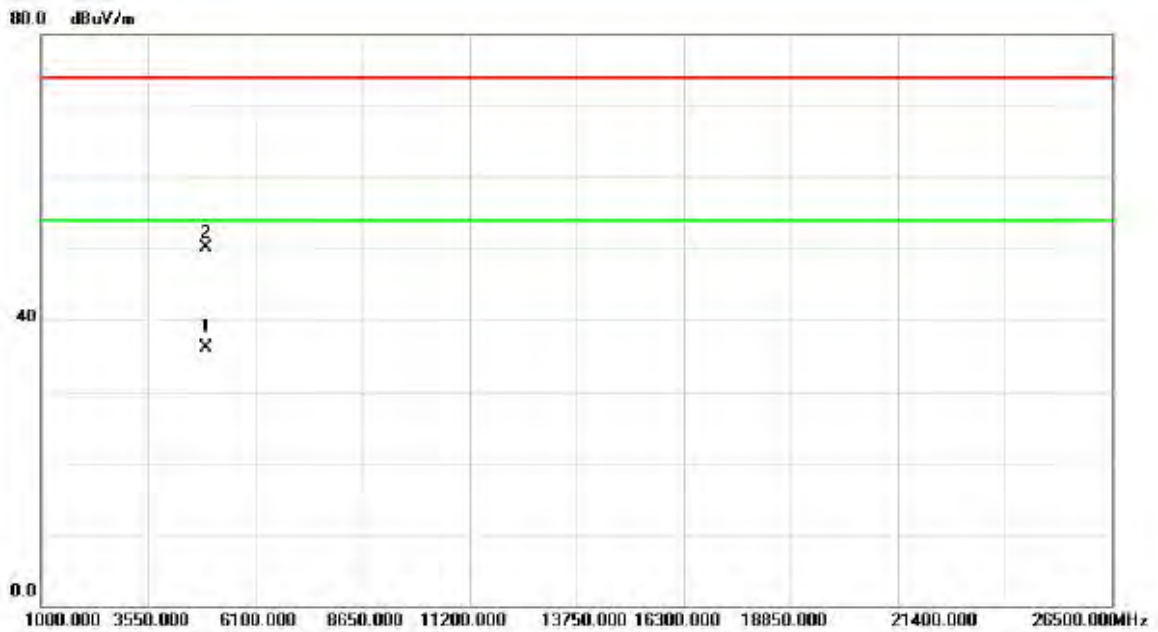

No.	Mk.	Freq. MHz	Reading Level dBuV	Correct Factor dB	Measure- ment dBuV/m	Limit dBuV/m	Margin dB	Detector	Comment
1	*	4925.200	38.20	-2.17	36.03	54.00	-17.97	AVG	
2		4926.300	52.28	-2.17	50.11	74.00	-23.89	peak	

Orthogonal Axis :	X
Test Mode :	TX N-20M MODE 2412MHz

### Vertical

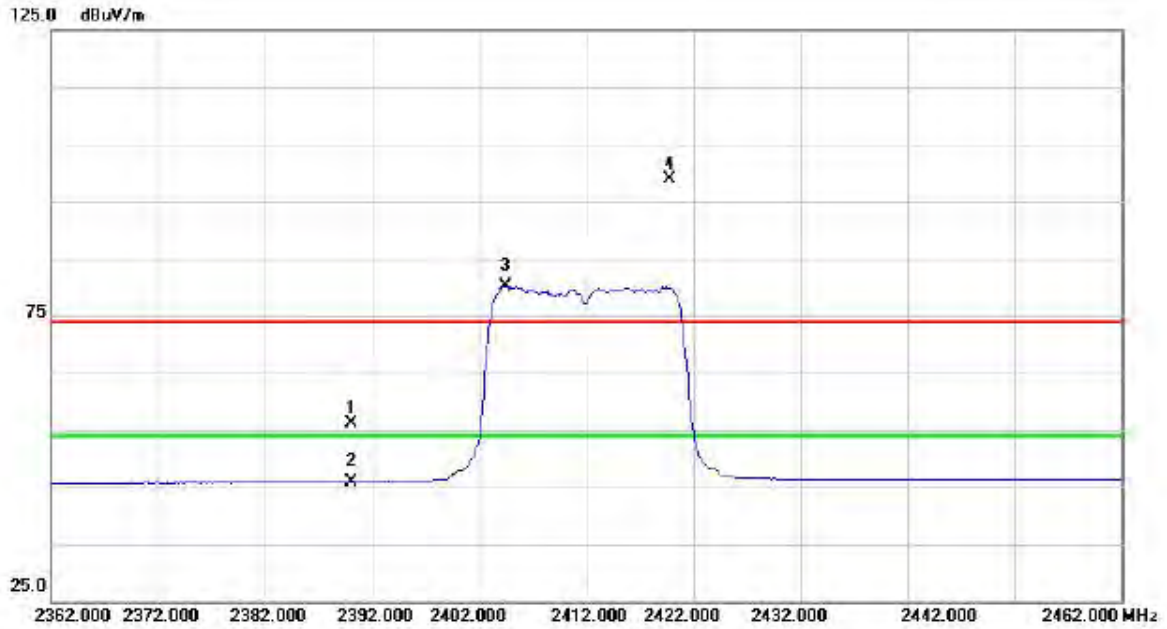

No.	Mk.	Freq. MHz	Reading Level dBuV	Correct Factor dB	Measure- ment dBuV/m	Limit dBuV/m	Margin dB	Detector	Comment
1		2390.000	24.31	31.88	56.19	74.00	-17.81	peak	
2		2390.000	14.05	31.88	45.93	54.00	-8.07	AVG	
3	*	2404.500	48.33	31.89	80.22	54.00	26.22	AVG	NO LIMIT
4	X	2419.800	67.06	31.92	98.98	74.00	24.98	peak	NO LIMIT

Orthogonal Axis :	X
Test Mode :	TX N-20M MODE 2412MHz

### Vertical

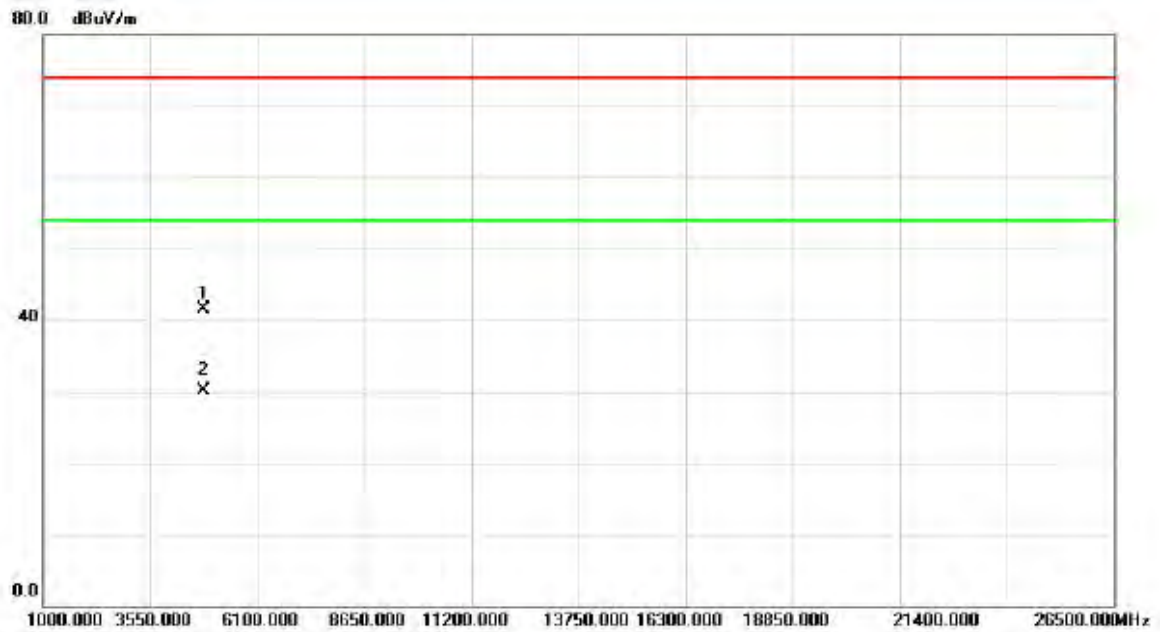

No.	Mk.	Freq. MHz	Reading Level dBuV	Correct Factor dB	Measure- ment dBuV/m	Limit dBuV/m	Margin dB	Detector	Comment
1		4826.300	43.73	-2.32	41.41	74.00	-32.59	peak	
2	*	4831.500	32.50	-2.31	30.19	54.00	-23.81	AVG	

Orthogonal Axis :	X
Test Mode :	TX N-20M MODE 2412MHz

### Horizontal

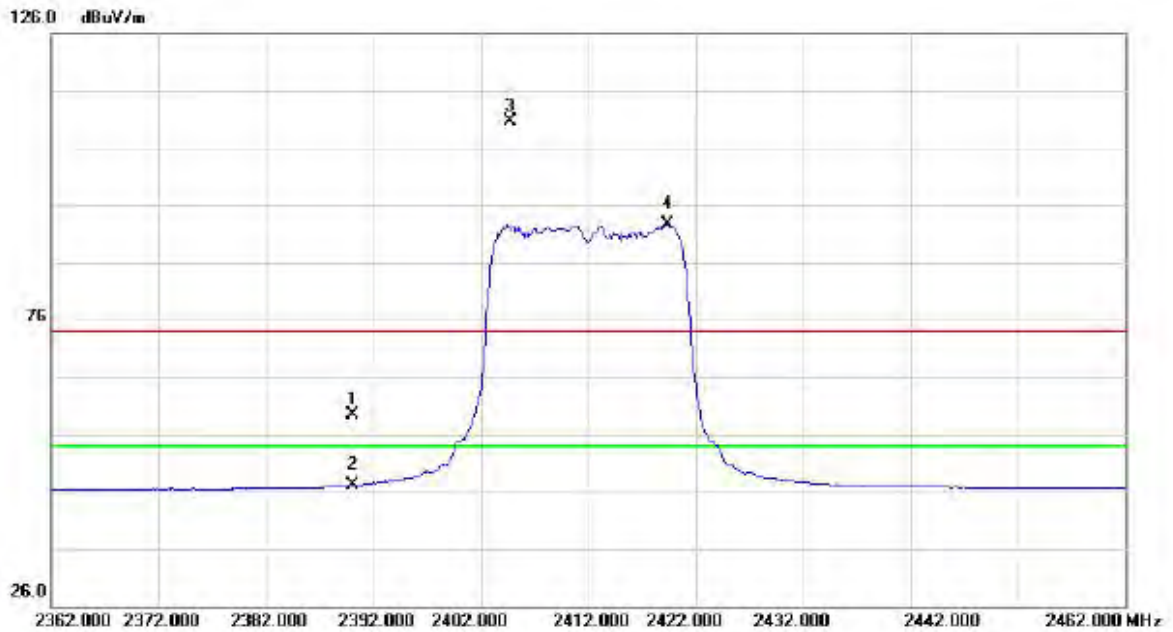

No.	Mk.	Freq. MHz	Reading Level dBuV	Correct Factor dB	Measure- ment dBuV/m	Limit dBuV/m	Margin dB	Detector	Comment
1		2390.000	27.52	31.88	59.40	74.00	-14.60	peak	
2		2390.000	15.16	31.88	47.04	54.00	-6.96	AVG	
3	X	2404.700	78.71	31.89	110.60	74.00	36.60	peak	NO LIMIT
4	*	2419.400	60.67	31.92	92.59	54.00	38.59	AVG	NO LIMIT

Orthogonal Axis :	X
Test Mode :	TX N-20M MODE 2412MHz

### Horizontal

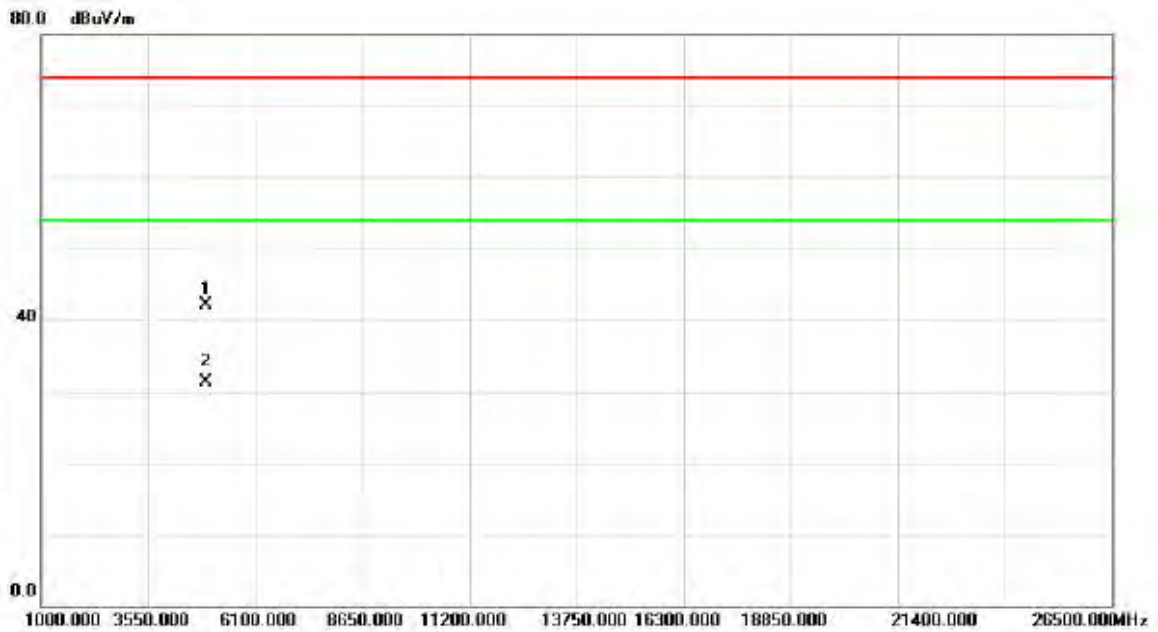

No.	Mk.	Freq. MHz	Reading Level dBuV	Correct Factor dB	Measure- ment dBuV/m	Limit dBuV/m	Margin dB	Detector	Comment
1		4924.900	44.22	-2.17	42.05	74.00	-31.95	peak	
2	*	4925.400	33.48	-2.17	31.31	54.00	-22.69	AVG	

Orthogonal Axis :	X
Test Mode :	TX N-20M MODE 2437MHz

### Vertical

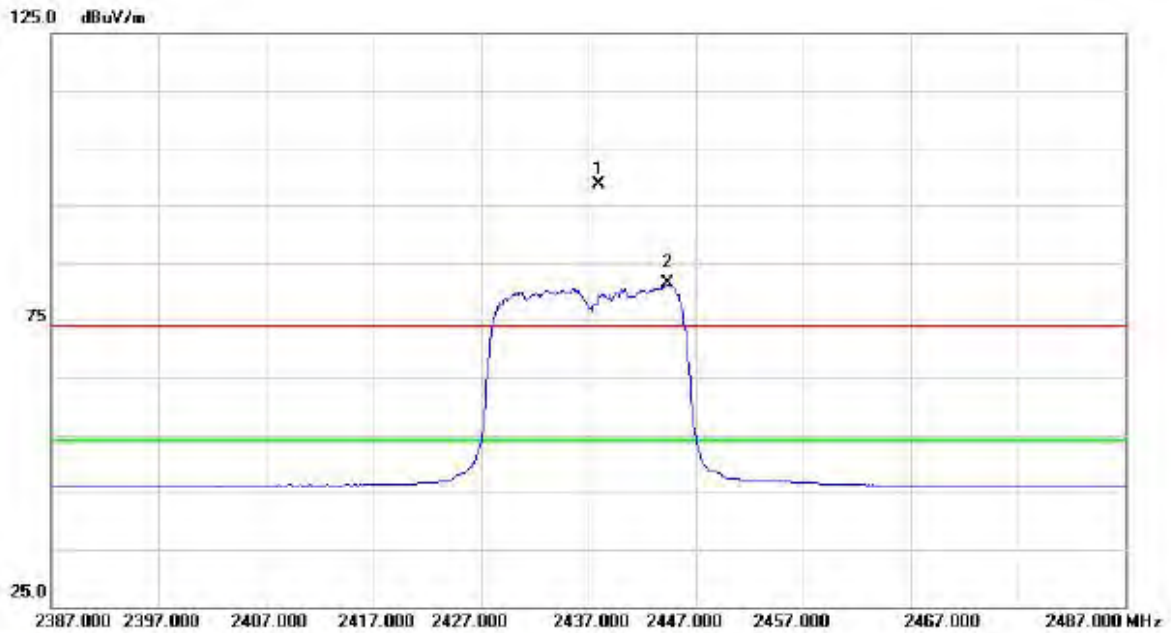

No.	Mk.	Freq. MHz	Reading Level dBuV	Correct Factor dB	Measure- ment dBuV/m	Limit dBuV/m	Margin dB	Detector	Comment
1	X	2438.000	66.64	31.94	98.58	74.00	24.58	peak	NO LIMIT
2	*	2444.400	49.30	31.96	81.26	54.00	27.26	AVG	NO LIMIT



Orthogonal Axis :	X
Test Mode :	TX N-20M MODE 2437MHz

### Vertical

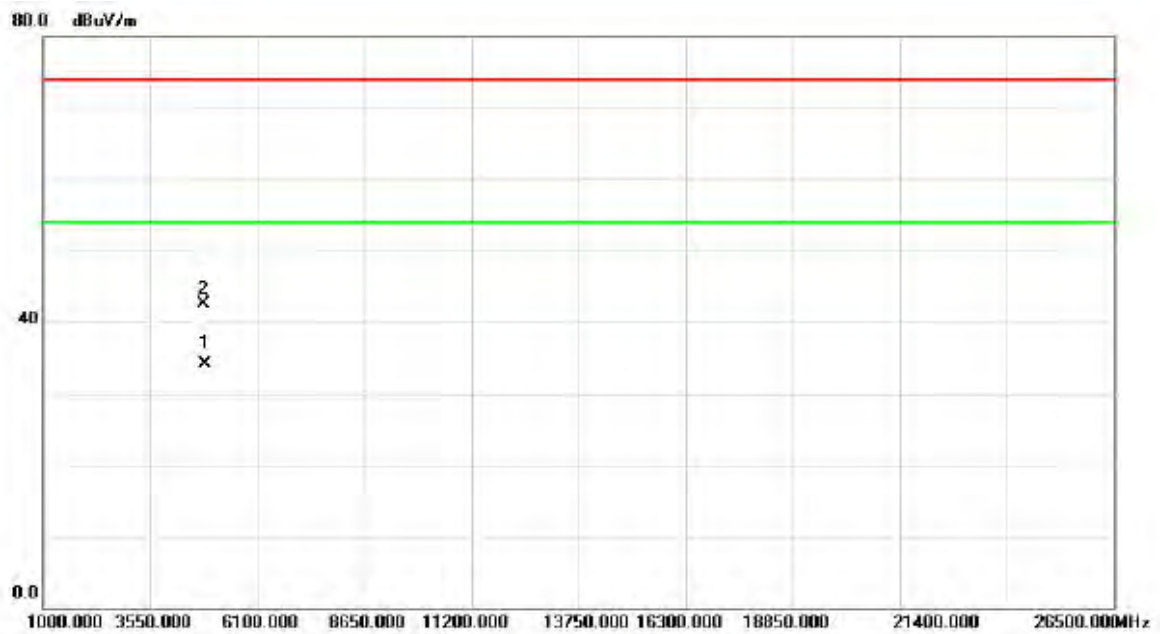

No.	Mk.	Freq. MHz	Reading Level dBuV	Correct Factor dB	Measure- ment dBuV/m	Limit dBuV/m	Margin dB	Detector	Comment
1	*	4874.100	36.31	-2.24	34.07	54.00	-19.93	AVG	
2		4825.200	44.76	-2.32	42.44	74.00	-31.56	peak	

Orthogonal Axis :	X
Test Mode :	TX N-20M MODE 2437MHz

### Horizontal

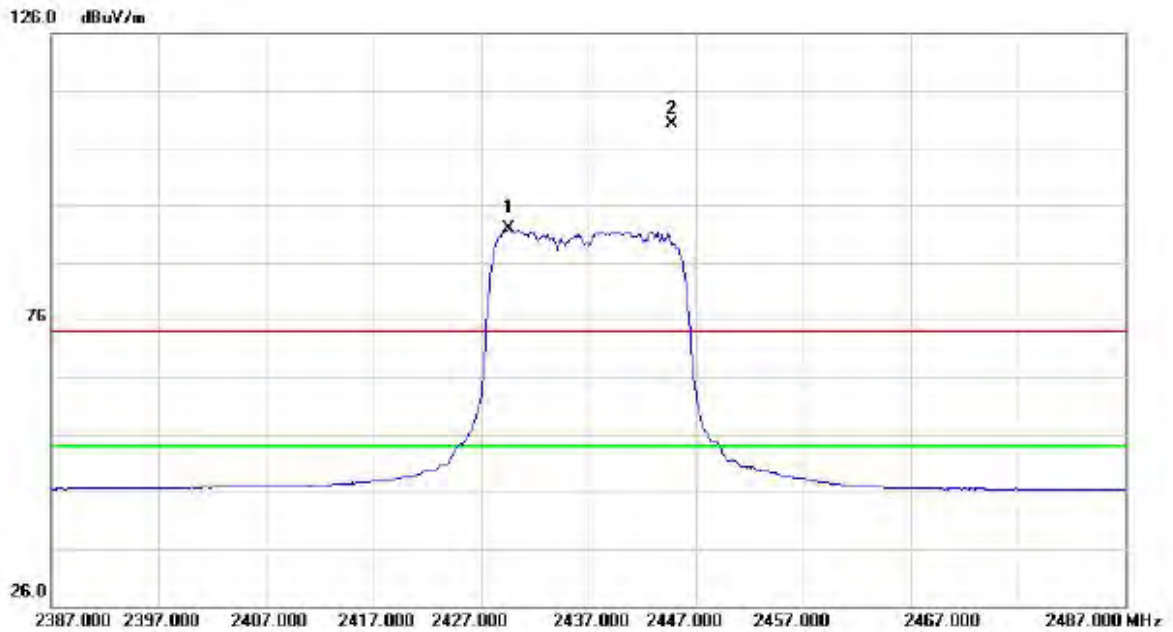

No.	Mk.	Freq. MHz	Reading Level dBuV	Correct Factor dB	Measure- ment dBuV/m	Limit dBuV/m	Margin dB	Detector	Comment
1	*	2429.600	59.84	31.93	91.77	54.00	37.77	AVG	NO LIMIT
2	X	2444.800	78.29	31.96	110.25	74.00	36.25	peak	NO LIMIT

Orthogonal Axis :	X
Test Mode :	TX N-20M MODE 2437MHz

### Horizontal

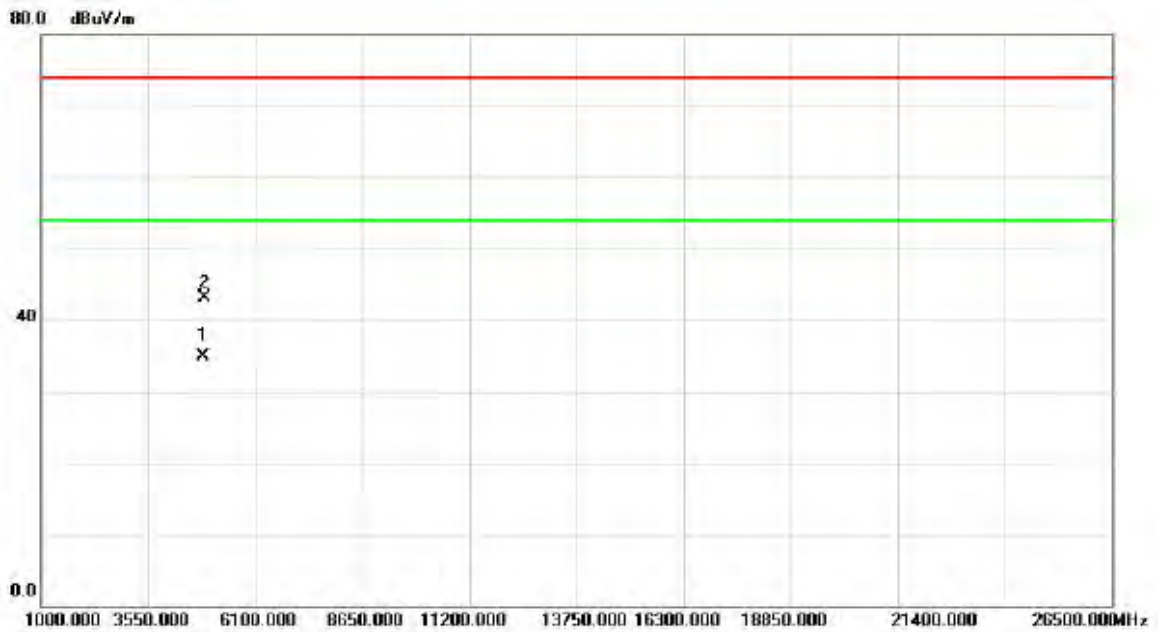

No.	Mk.	Freq. MHz	Reading Level dBuV	Correct Factor dB	Measure- ment dBuV/m	Limit dBuV/m	Margin dB	Detector	Comment
1	*	4867.200	37.09	-2.25	34.84	54.00	-19.16	AVG	
2		4885.200	45.32	-2.22	43.10	74.00	-30.90	peak	

Orthogonal Axis :	X
Test Mode :	TX N-20M MODE 2462MHz

### Vertical

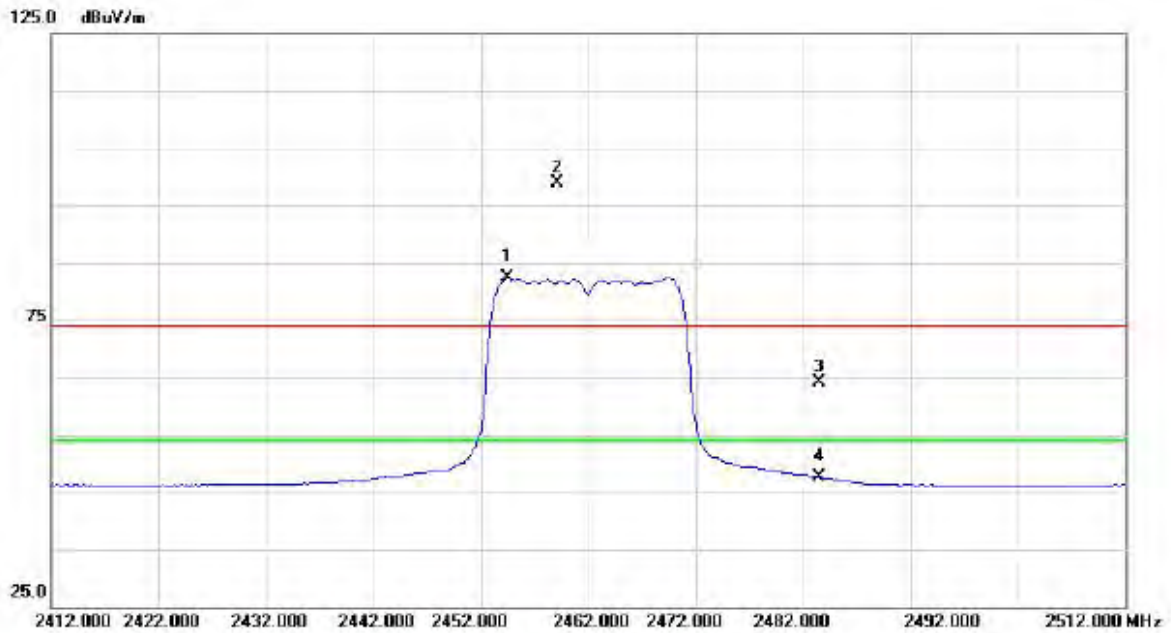

No.	Mk.	Freq. MHz	Reading Level dBuV	Correct Factor dB	Measure- ment dBuV/m	Limit dBuV/m	Margin dB	Detector	Comment
1	*	2454.500	50.45	31.96	82.41	54.00	28.41	AVG	NO LIMIT
2	X	2459.100	66.89	31.98	98.87	74.00	24.87	peak	NO LIMIT
3		2483.500	32.14	32.01	64.15	74.00	-9.85	peak	
4		2483.500	15.54	32.01	47.55	54.00	-6.45	AVG	

Orthogonal Axis :	X
Test Mode :	TX N-20M MODE 2462MHz

### Vertical

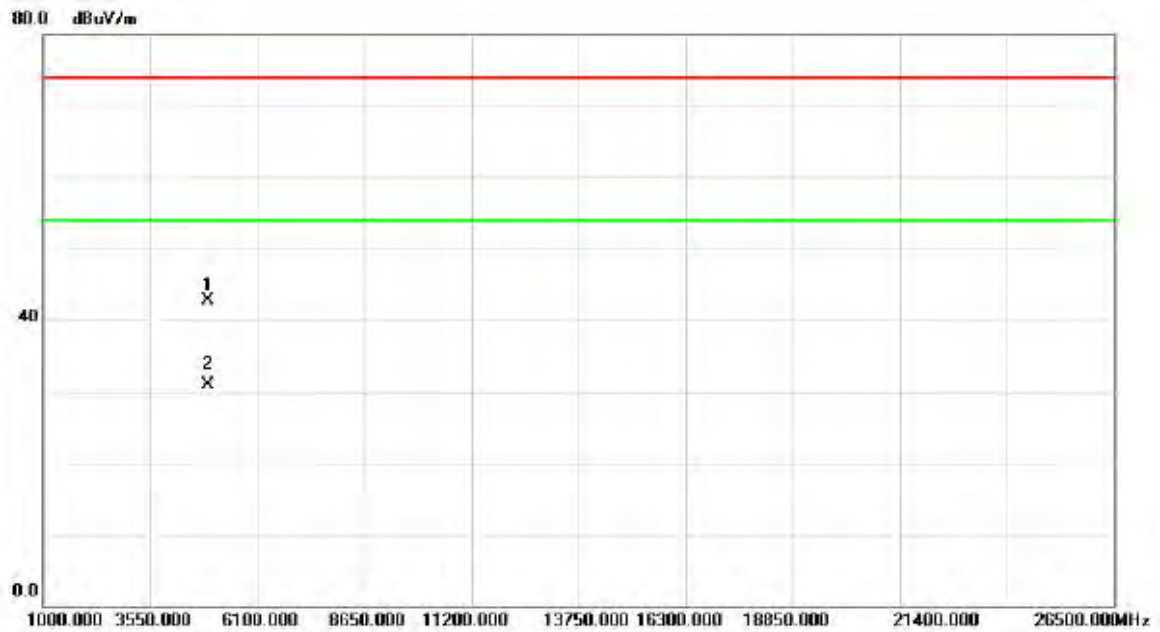

No.	Mk.	Freq. MHz	Reading Level dBuV	Correct Factor dB	Measure- ment dBuV/m	Limit dBuV/m	Margin dB	Detector	Comment
1		4919.400	44.87	-2.18	42.69	74.00	-31.31	peak	
2	*	4920.000	33.00	-2.18	30.82	54.00	-23.18	AVG	

Orthogonal Axis :	X
Test Mode :	TX N-20M MODE 2462MHz

### Horizontal

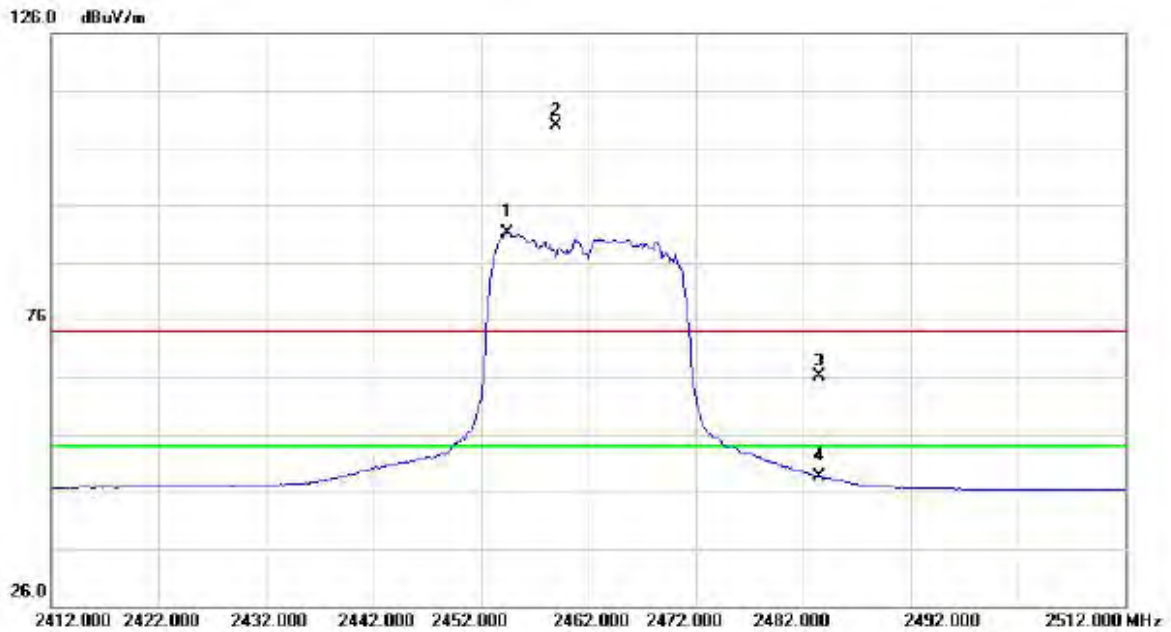

No.	Mk.	Freq. MHz	Reading Level dBuV	Correct Factor dB	Measure- ment dBuV/m	Limit dBuV/m	Margin dB	Detector	Comment
1	*	2454.500	59.15	31.96	91.11	54.00	37.11	AVG	NO LIMIT
2	X	2459.000	77.83	31.98	109.81	74.00	35.81	peak	NO LIMIT
3		2483.500	34.07	32.01	66.08	74.00	-7.92	peak	
4		2483.500	16.66	32.01	48.67	54.00	-5.33	AVG	

Orthogonal Axis :	X
Test Mode :	TX N-20M MODE 2462MHz

### Horizontal

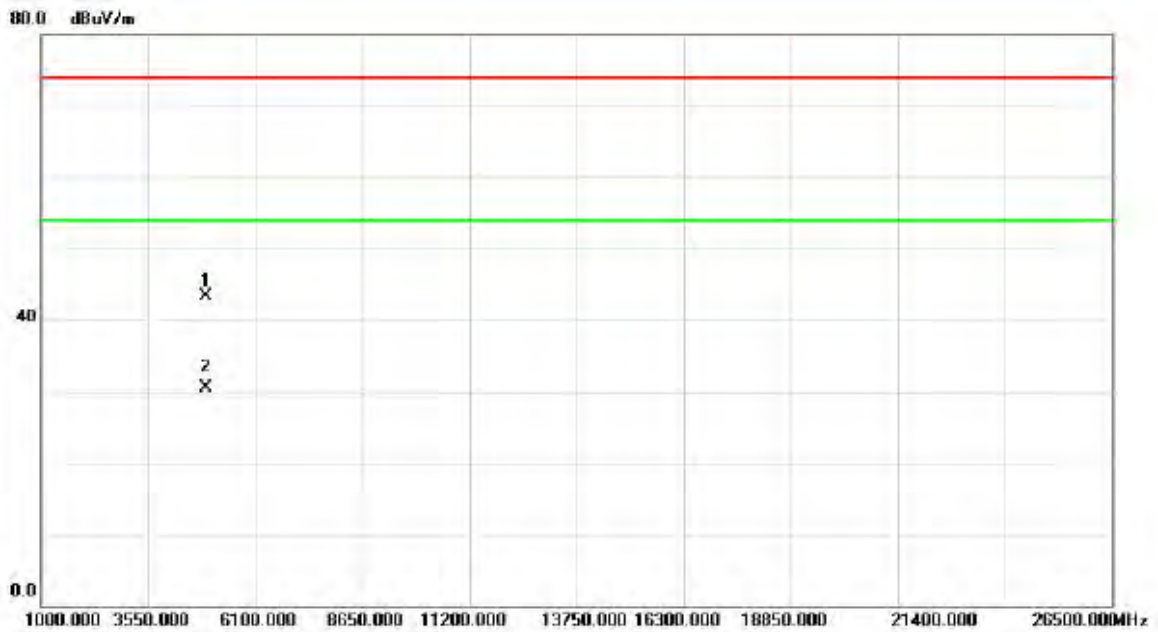

No.	Mk.	Freq. MHz	Reading Level dBuV	Correct Factor dB	Measure- ment dBuV/m	Limit dBuV/m	Margin dB	Detector	Comment
1		4926.900	45.54	-2.17	43.37	74.00	-30.63	peak	
2	*	4924.400	32.61	-2.17	30.44	54.00	-23.56	AVG	

Orthogonal Axis :	X
Test Mode :	TX N-40M MODE 2422MHz

**Vertical**

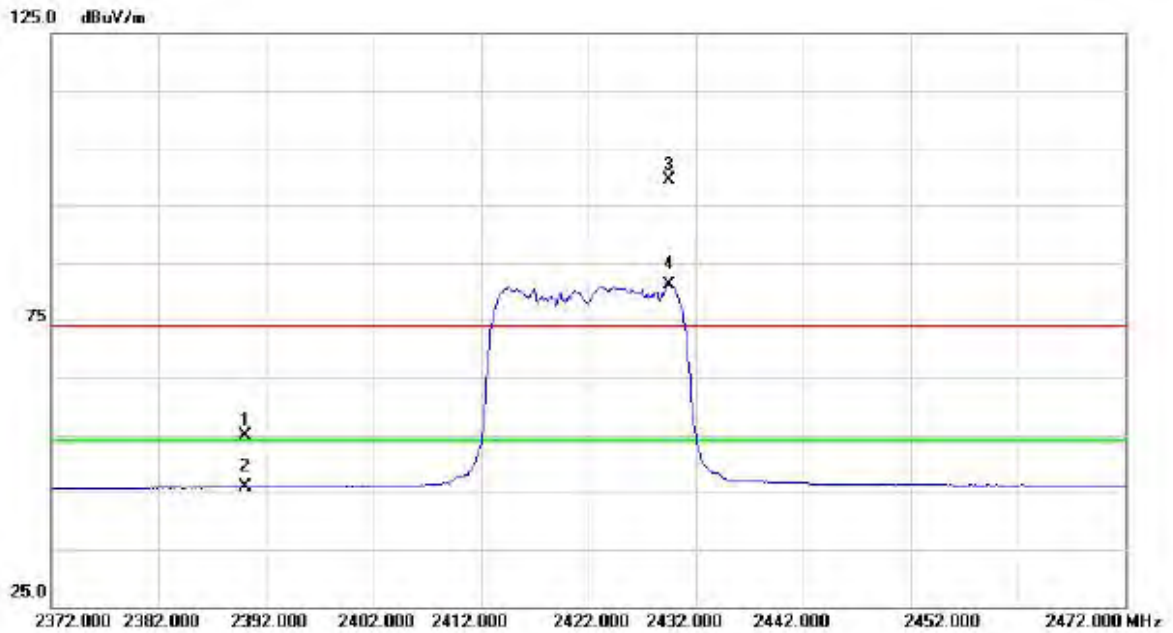

No.	Mk.	Freq. MHz	Reading Level dBuV	Correct Factor dB	Measure- ment dBuV/m	Limit dBuV/m	Margin dB	Detector	Comment
1		2390.000	23.12	31.88	55.00	74.00	-19.00	peak	
2		2390.000	13.93	31.88	45.81	54.00	-8.19	AVG	
3	X	2429.500	67.41	31.93	99.34	74.00	25.34	peak	NO LIMIT
4	*	2429.500	49.26	31.93	81.19	54.00	27.19	AVG	NO LIMIT



Orthogonal Axis :	X
Test Mode :	TX N-40M MODE 2422MHz

### Vertical

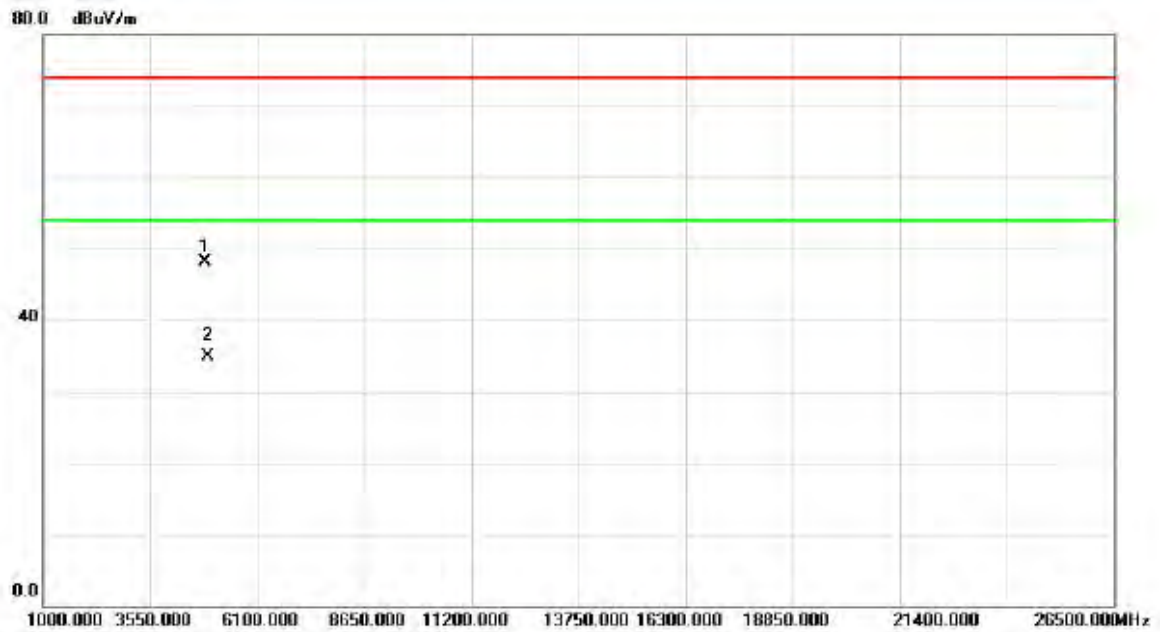

No.	Mk.	Freq. MHz	Reading Level dBuV	Correct Factor dB	Measure- ment dBuV/m	Limit dBuV/m	Margin dB	Detector	Comment
1		4847.000	50.35	-2.28	48.07	74.00	-25.93	peak	
2	*	4919.100	37.12	-2.18	34.94	54.00	-19.06	AVG	

Orthogonal Axis :	X
Test Mode :	TX N-40M MODE 2422MHz

### Horizontal

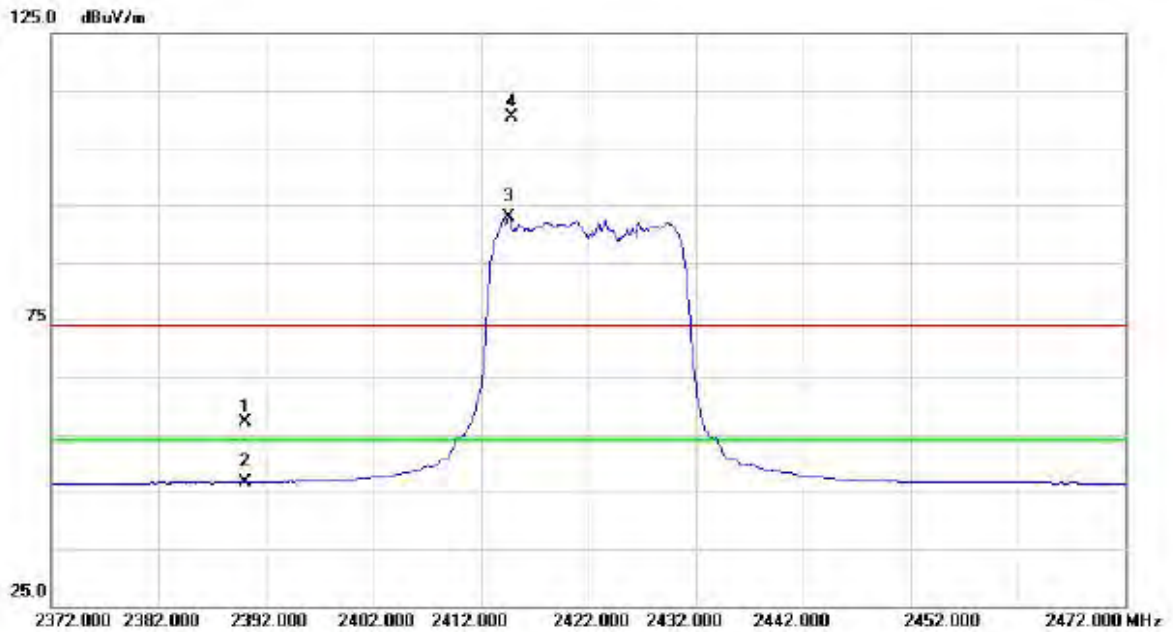

No.	Mk.	Freq. MHz	Reading Level dBuV	Correct Factor dB	Measure- ment dBuV/m	Limit dBuV/m	Margin dB	Detector	Comment
1		2390.000	25.22	31.88	57.10	74.00	-16.90	peak	
2		2390.000	14.69	31.88	46.57	54.00	-7.43	AVG	
3	*	2414.600	61.03	31.91	92.94	54.00	38.94	AVG	NO LIMIT
4	X	2414.800	78.35	31.91	110.26	74.00	36.26	peak	NO LIMIT

Orthogonal Axis :	X
Test Mode :	TX N-40M MODE 2422MHz

### Horizontal

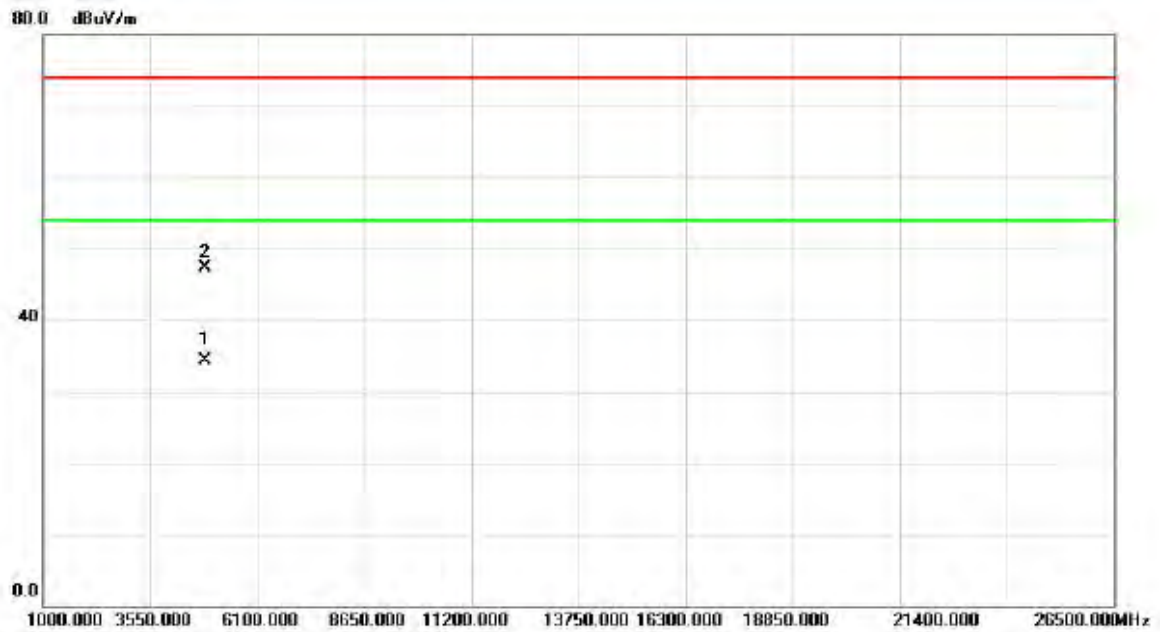

No.	Mk.	Freq. MHz	Reading Level dBuV	Correct Factor dB	Measure- ment dBuV/m	Limit dBuV/m	Margin dB	Detector	Comment
1	*	4844.500	36.54	-2.29	34.25	54.00	-19.75	AVG	
2		4849.500	49.60	-2.28	47.32	74.00	-26.68	peak	

Orthogonal Axis :	X
Test Mode :	TX N-40M MODE 2437MHz

**Vertical**

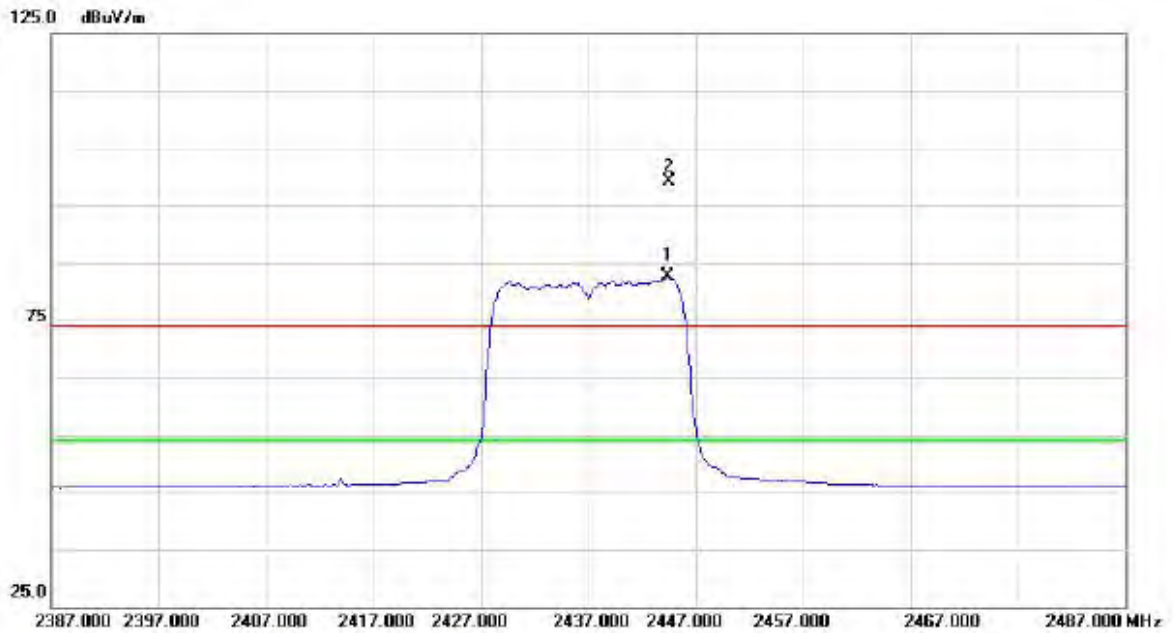

No.	Mk.	Freq.	Reading Level	Correct Factor	Measurement	Limit	Margin		
		MHz	dBuV	dB	dBuV/m	dBuV/m	dB	Detector	Comment
1	*	2444.400	50.75	31.96	82.71	54.00	28.71	AVG	NO LIMIT
2	X	2444.500	67.24	31.96	99.20	74.00	25.20	peak	NO LIMIT

Orthogonal Axis :	X
Test Mode :	TX N-40M MODE 2437MHz

### Vertical

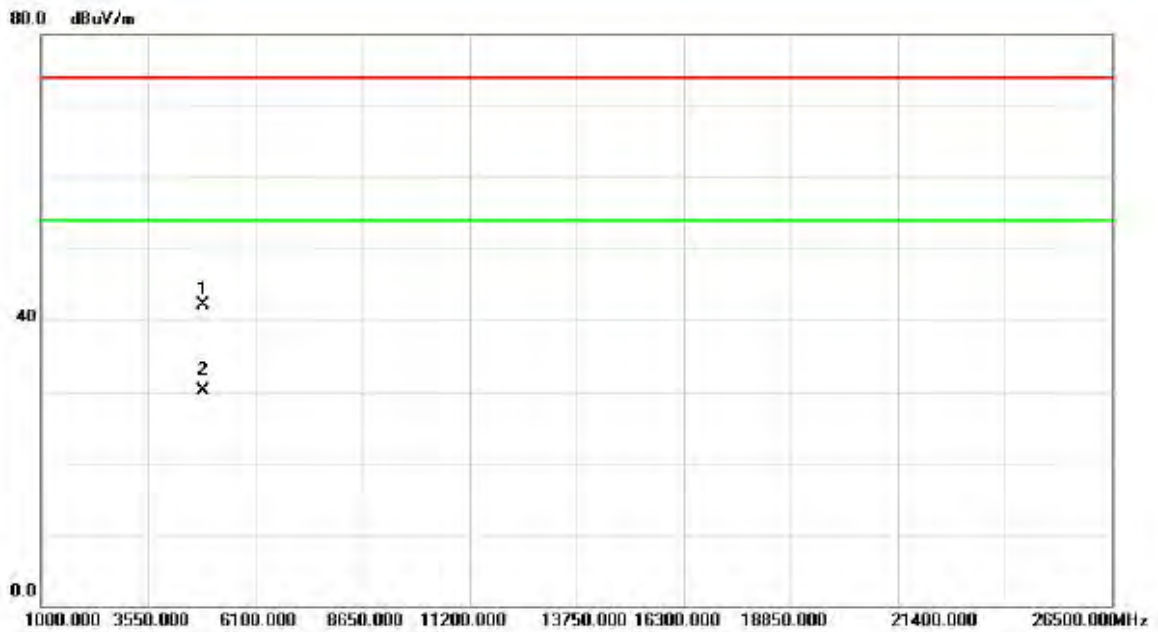

No.	Mk.	Freq. MHz	Reading Level dBuV	Correct Factor dB	Measure- ment dBuV/m	Limit dBuV/m	Margin dB	Detector	Comment
1		4869.200	44.38	-2.25	42.13	74.00	-31.87	peak	
2	*	4872.700	32.31	-2.24	30.07	54.00	-23.93	AVG	

Orthogonal Axis :	X
Test Mode :	TX N-40M MODE 2437MHz

### Horizontal

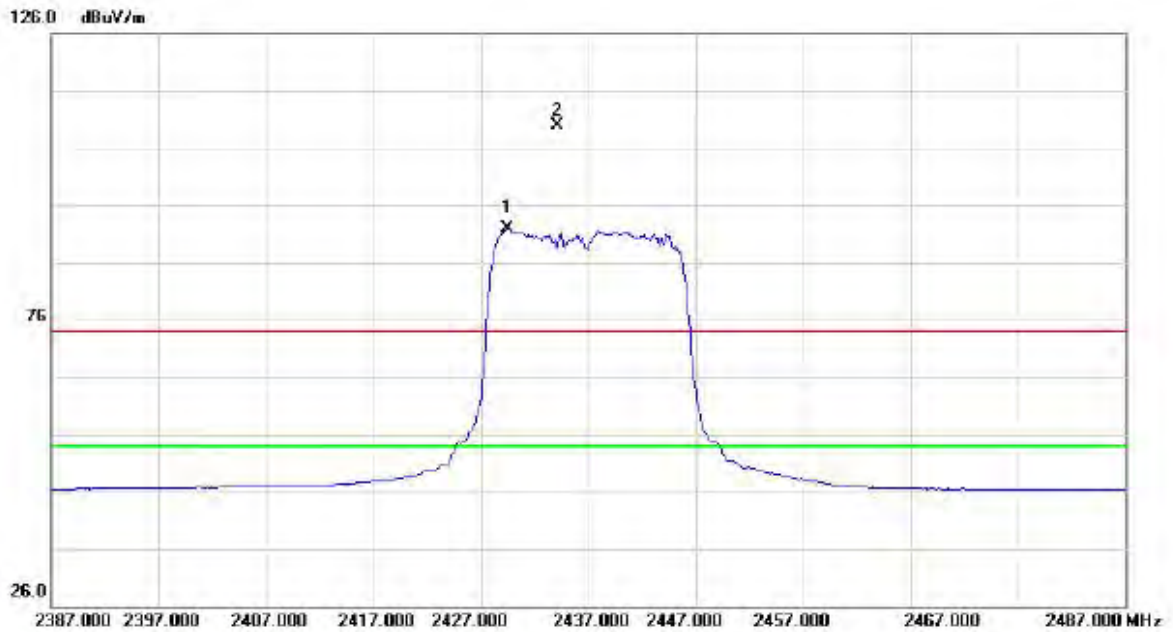

No.	Mk.	Freq. MHz	Reading Level dBuV	Correct Factor dB	Measure- ment dBuV/m	Limit dBuV/m	Margin dB	Detector	Comment
1	*	2429.500	59.88	31.93	91.81	54.00	37.81	AVG	NO LIMIT
2	X	2434.100	77.99	31.94	109.93	74.00	35.93	peak	NO LIMIT

Orthogonal Axis :	X
Test Mode :	TX N-40M MODE 2437MHz

### Horizontal

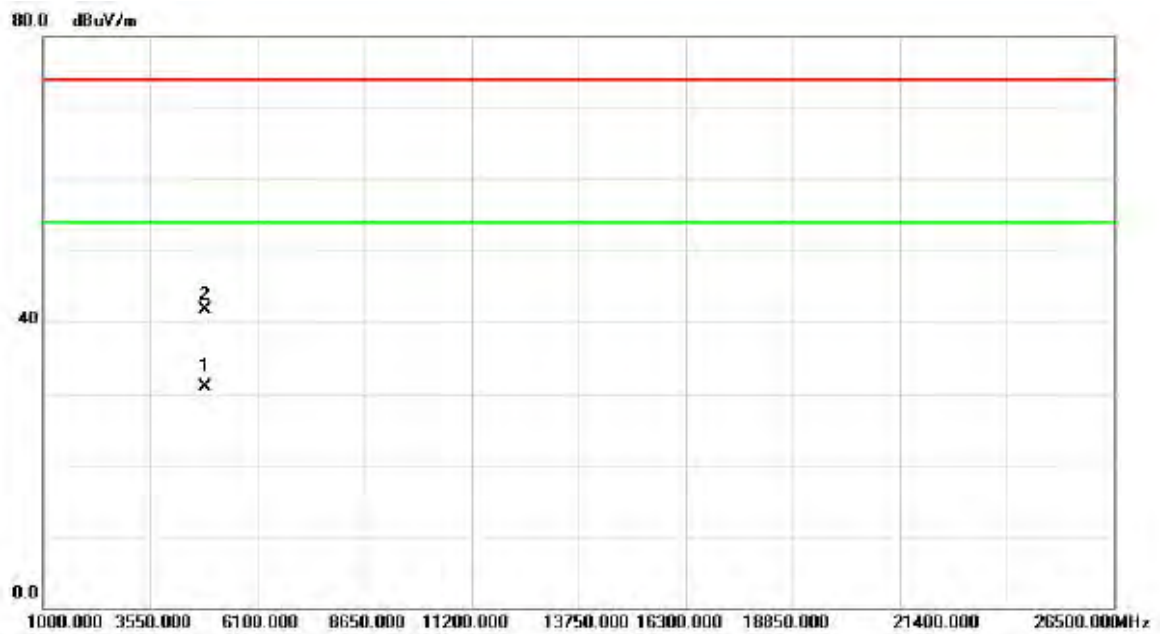

No.	Mk.	Freq. MHz	Reading Level dBuV	Correct Factor dB	Measure- ment dBuV/m	Limit dBuV/m	Margin dB	Detector	Comment
1	*	4875.200	33.08	-2.24	30.84	54.00	-23.16	AVG	
2		4846.100	44.01	-2.29	41.72	74.00	-32.28	peak	

Orthogonal Axis :	X
Test Mode :	TX N-40M MODE 2452MHz

**Vertical**

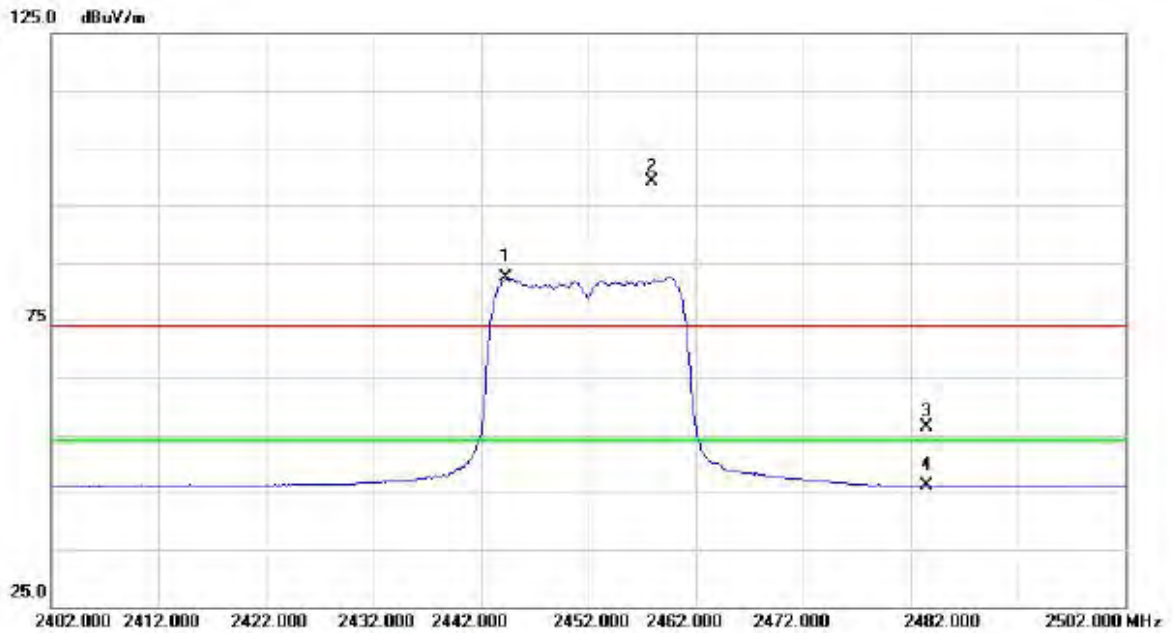

No.	Mk.	Freq. MHz	Reading Level dBuV	Correct Factor dB	Measure- ment dBuV/m	Limit dBuV/m	Margin dB	Detector	Comment
1	*	2444.300	50.38	31.96	82.34	54.00	28.34	AVG	NO LIMIT
2	X	2457.900	67.14	31.98	99.12	74.00	25.12	peak	NO LIMIT
3		2483.500	24.27	32.01	56.28	74.00	-17.72	peak	
4		2483.500	14.13	32.01	46.14	54.00	-7.86	AVG	



Orthogonal Axis :	X
Test Mode :	TX N-40M MODE 2452MHz

### Vertical

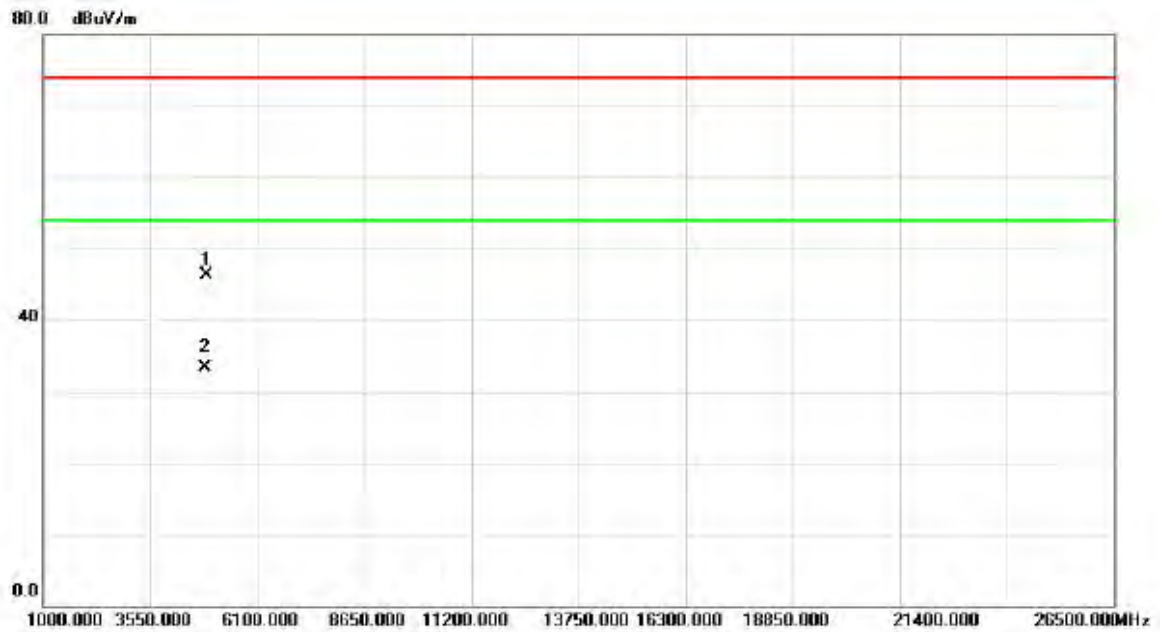

No.	Mk.	Freq. MHz	Reading Level dBuV	Correct Factor dB	Measure- ment dBuV/m	Limit dBuV/m	Margin dB	Detector	Comment
1		4906.200	48.45	-2.20	46.25	74.00	-27.75	peak	
2	*	4867.600	35.51	-2.25	33.26	54.00	-20.74	AVG	

Orthogonal Axis :	X
Test Mode :	TX N-40M MODE 2452MHz

### Horizontal

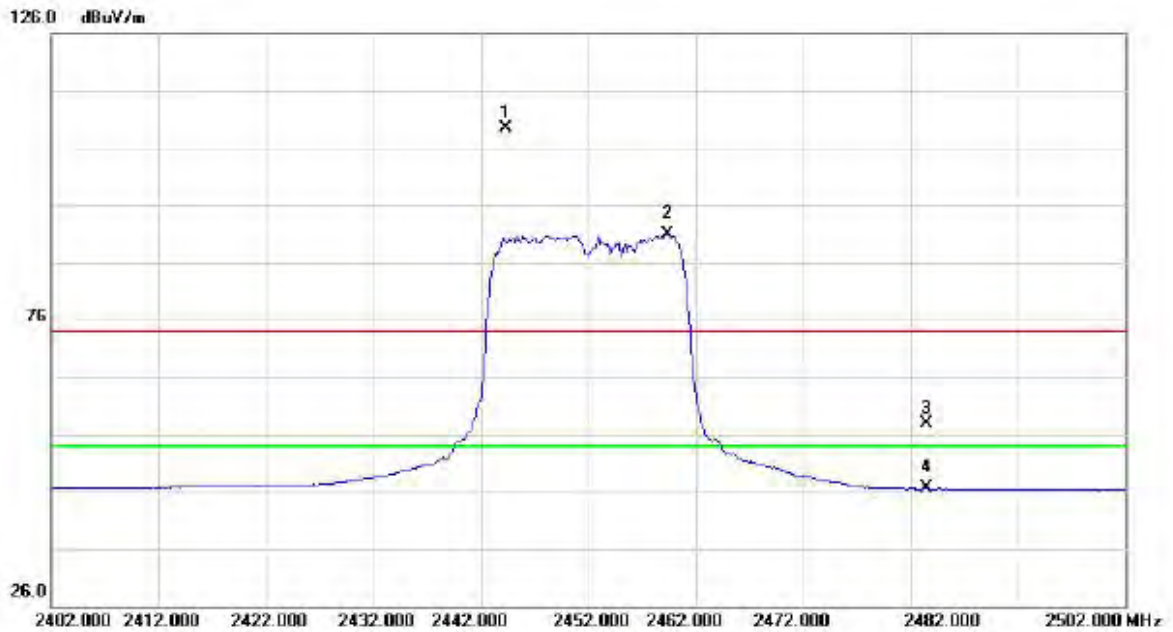

No.	Mk.	Freq. MHz	Reading Level dBuV	Correct Factor dB	Measure- ment dBuV/m	Limit dBuV/m	Margin dB	Detector	Comment
1	X	2444.300	77.50	31.96	109.46	74.00	35.46	peak	NO LIMIT
2	*	2459.400	58.96	31.98	90.94	54.00	36.94	AVG	NO LIMIT
3		2483.500	25.97	32.01	57.98	74.00	-16.02	peak	
4		2483.500	14.51	32.01	46.52	54.00	-7.48	AVG	

Orthogonal Axis :	X
Test Mode :	TX N-40M MODE 2452MHz

### Horizontal

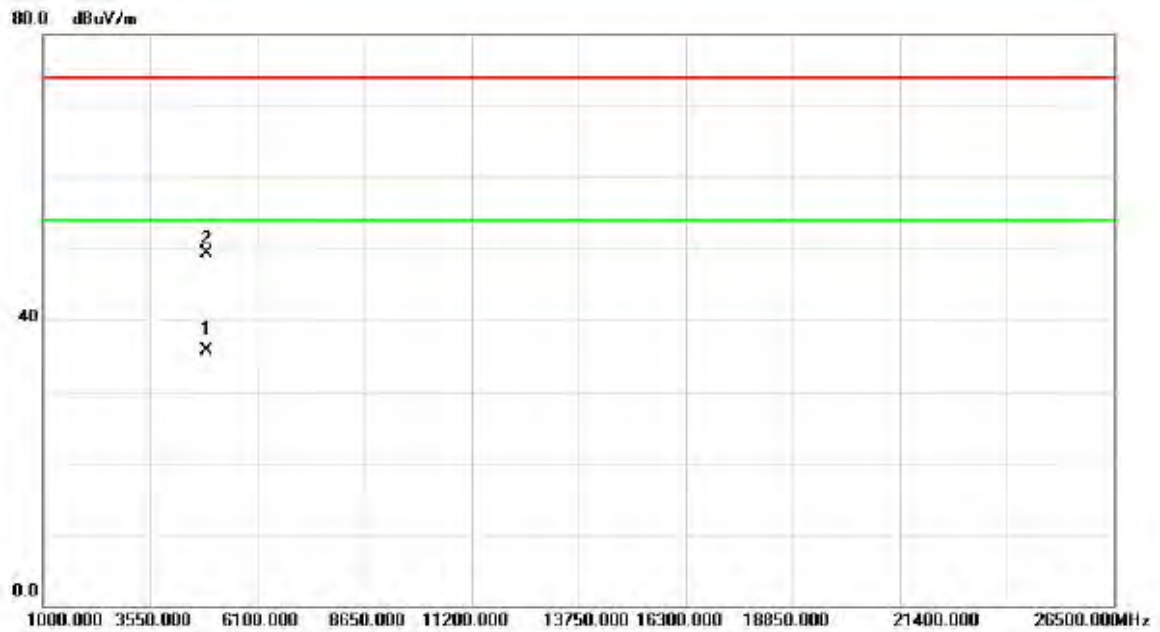

No.	Mk.	Freq. MHz	Reading Level dBuV	Correct Factor dB	Measure- ment dBuV/m	Limit dBuV/m	Margin dB	Detector	Comment
1	*	4896.900	37.97	-2.20	35.77	54.00	-18.23	AVG	
2		4897.400	51.53	-2.20	49.33	74.00	-24.67	peak	

## ATTACHMENT E - BANDWIDTH

**Test Mode : TX B Mode\_CH01/06/11**

Frequency (MHz)	6dB Bandwidth (MHz)	99% Occupied BW (MHz)	Min. Limit (kHz)	Test Result
2412	10.09	15.04	500	Complies
2437	10.12	15.08	500	Complies
2462	10.14	15.04	500	Complies

**TX CH01**

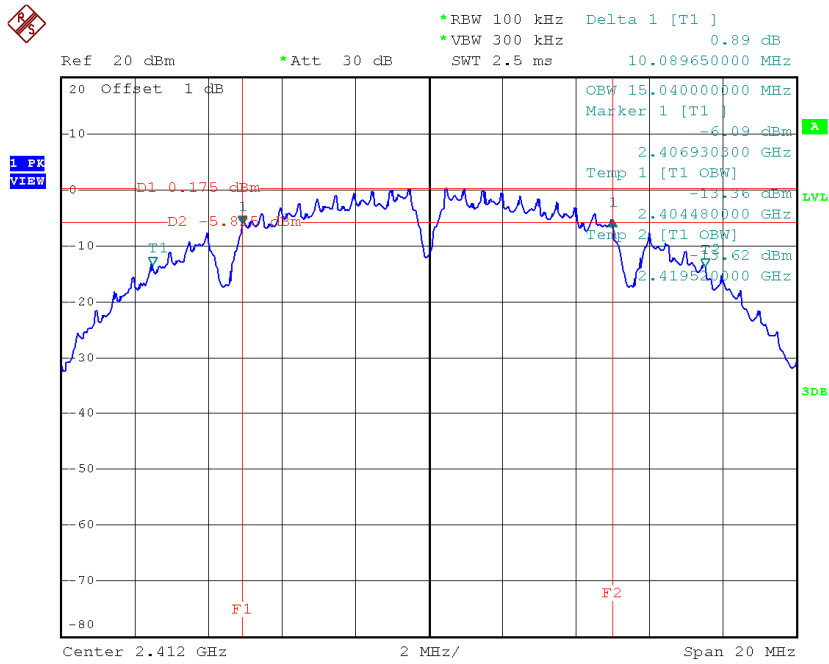

Date: 6.JUN.2015 20:27:38

### TX CH06

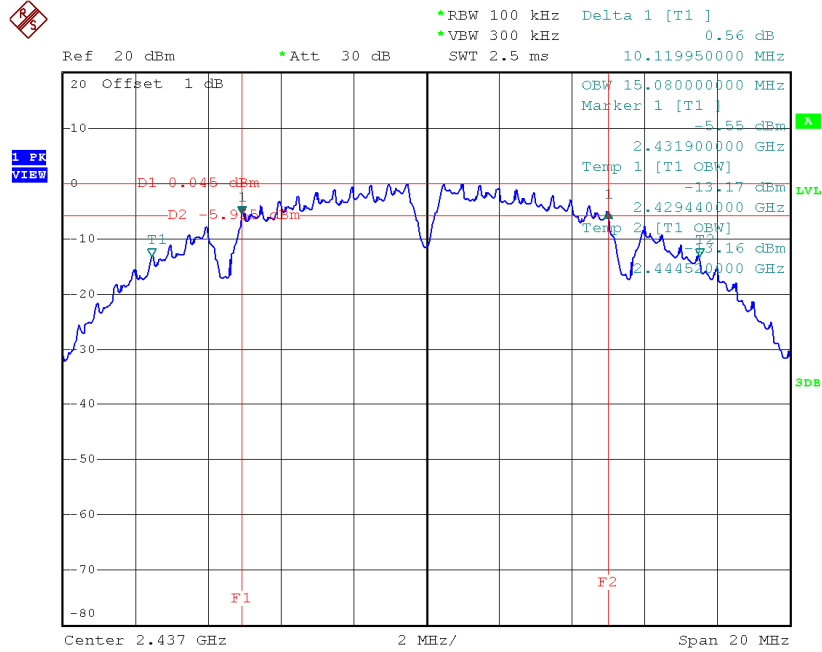

Date: 6.JUN.2015 20:31:12

### TX CH11

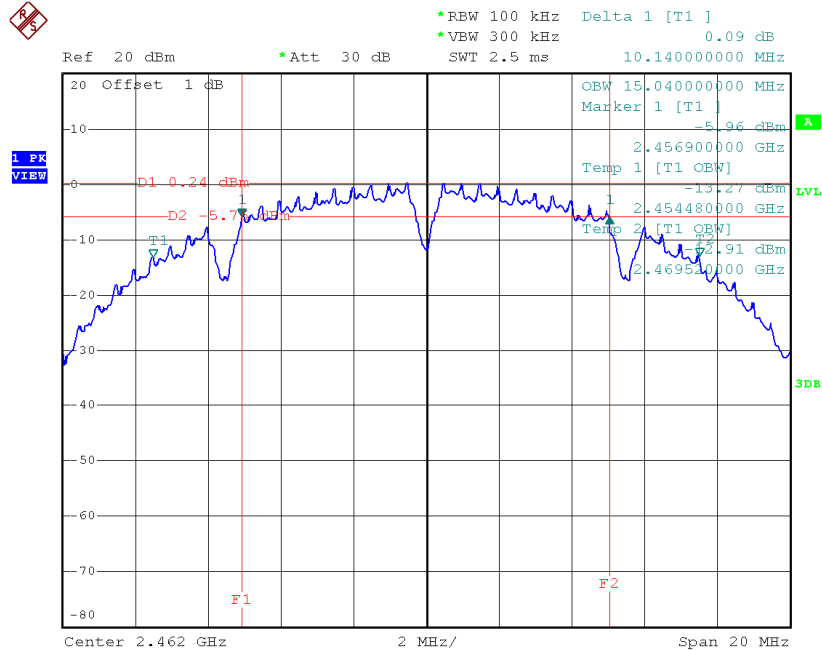

Date: 6.JUN.2015 20:32:25

**Test Mode: TX G Mode\_CH01/06/11**

Frequency (MHz)	6dB Bandwidth (MHz)	99% Occupied BW (MHz)	Min. Limit (kHz)	Test Result
2412	16.62	16.56	500	Complies
2437	16.62	16.56	500	Complies
2462	16.62	16.52	500	Complies

**TX CH01**

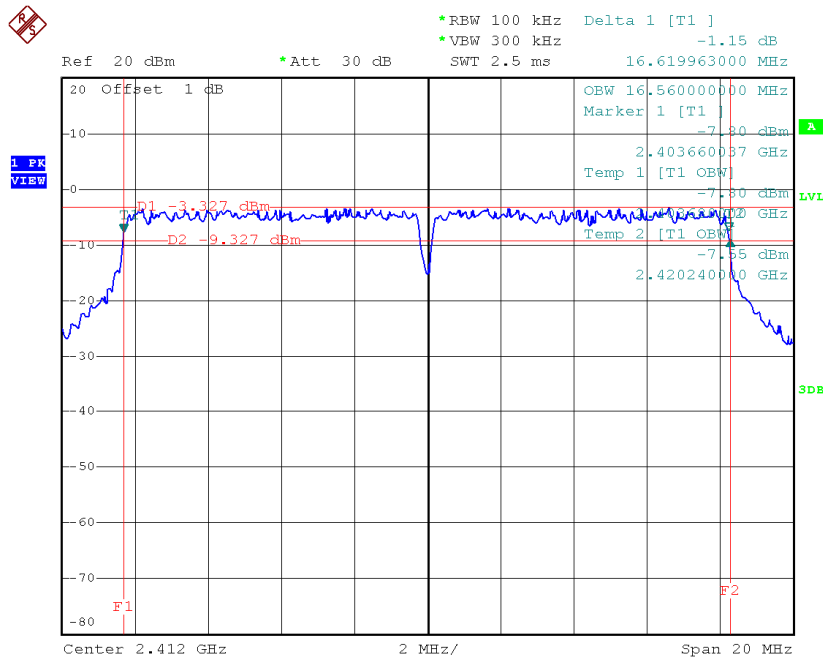

Date: 6.JUN.2015 20:33:54

### TX CH06

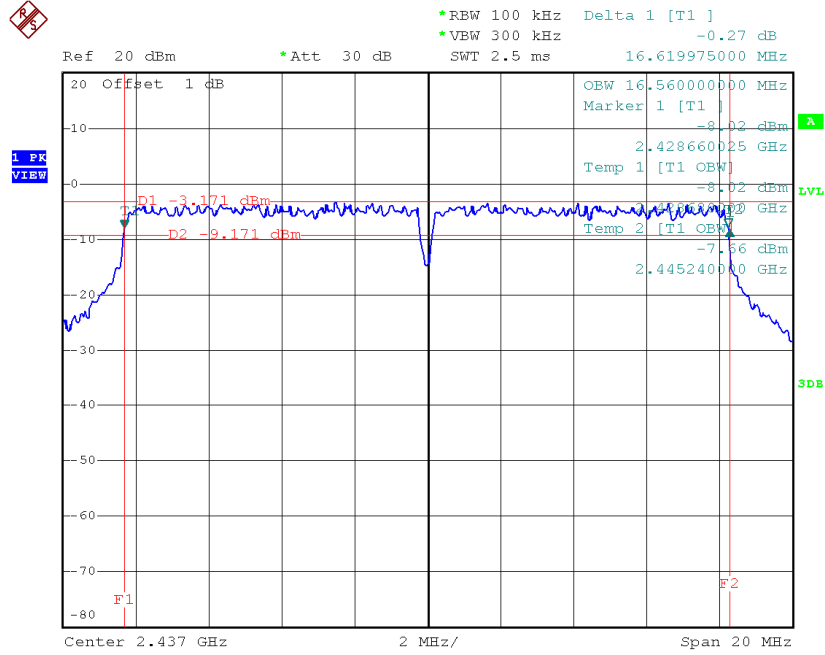

Date: 6.JUN.2015 20:35:01

### TX CH11

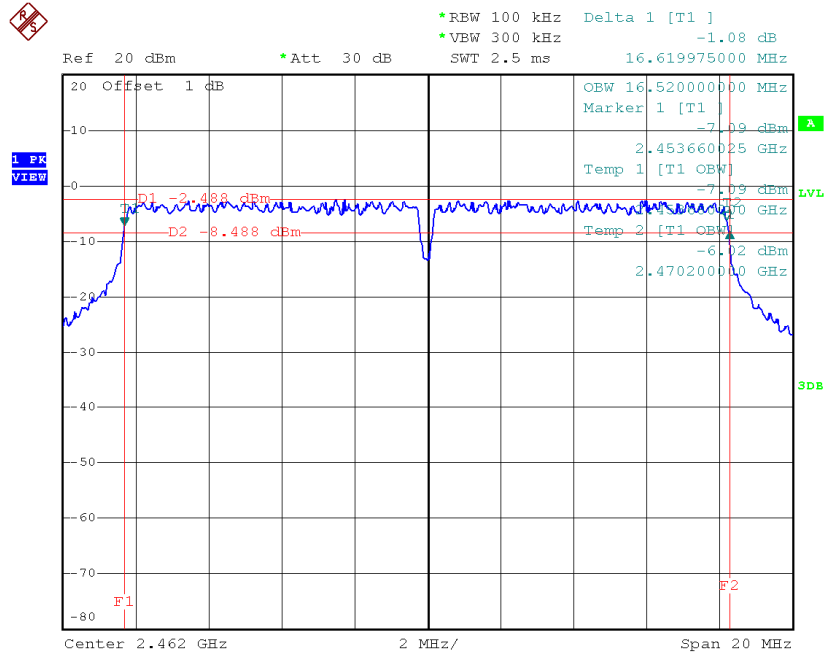

Date: 6.JUN.2015 20:36:00



**Test Mode : TX N-20MHz Mode\_CH01/06/11**

Frequency (MHz)	6dB Bandwidth (MHz)	99% Occupied BW (MHz)	Min. Limit (kHz)	Test Result
2412	17.86	17.72	500	Complies
2437	17.85	17.72	500	Complies
2462	17.89	17.72	500	Complies

**TX CH01**

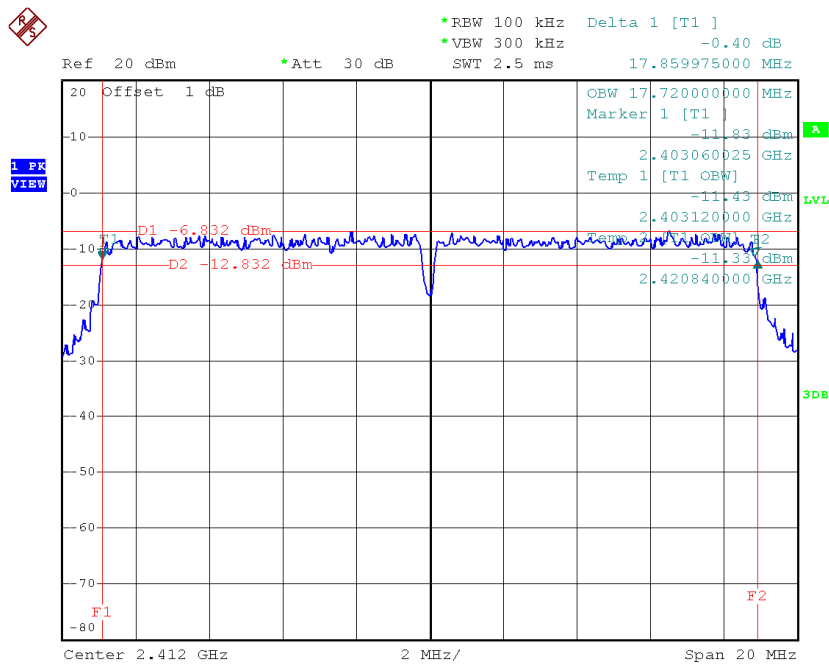

Date: 6.JUN.2015 20:37:33

### TX CH06

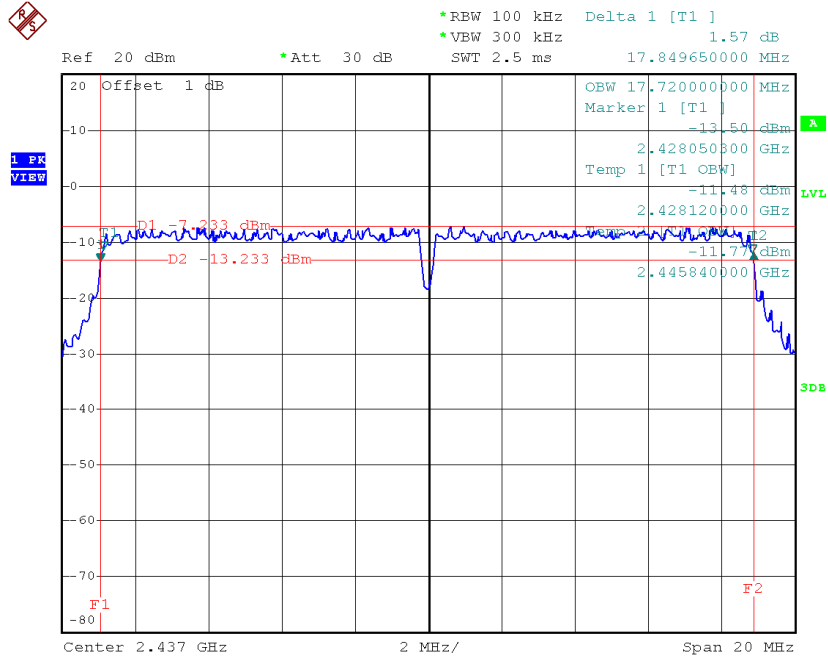

Date: 6.JUN.2015 20:38:38

### TX CH11

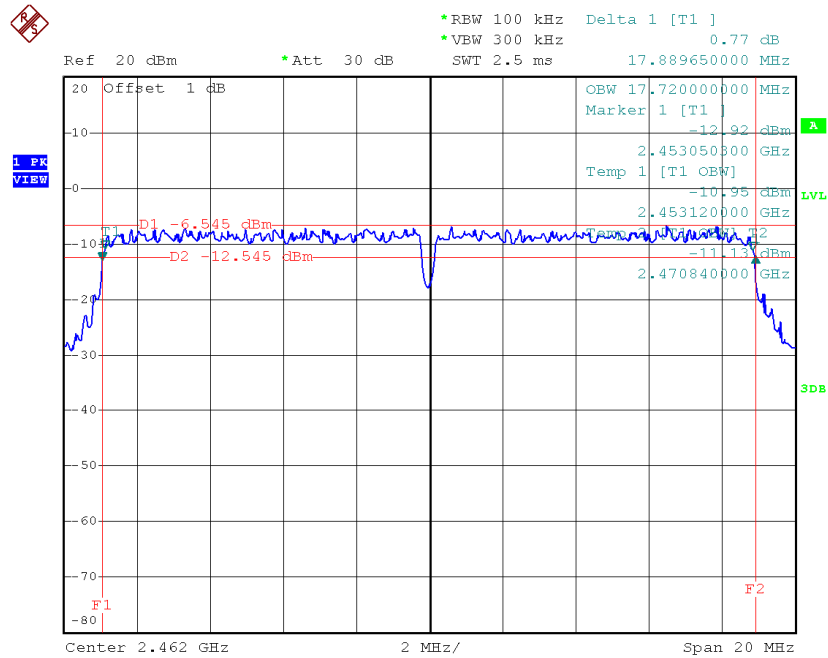

Date: 6.JUN.2015 20:39:37

**Test Mode : TX N-40MHz Mode\_CH03/06/09**

Frequency (MHz)	6dB Bandwidth (MHz)	99% Occupied BW (MHz)	Min. Limit (kHz)	Test Result
2422	36.63	36.16	500	Complies
2437	36.60	36.16	500	Complies
2452	36.65	36.16	500	Complies

**TX CH03**

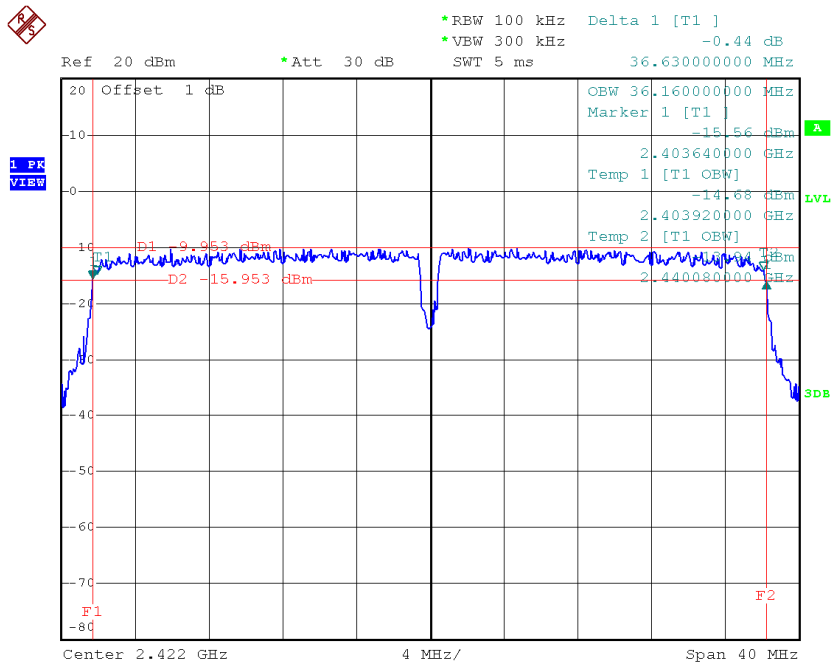

Date: 6.JUN.2015 20:41:24

### TX CH06

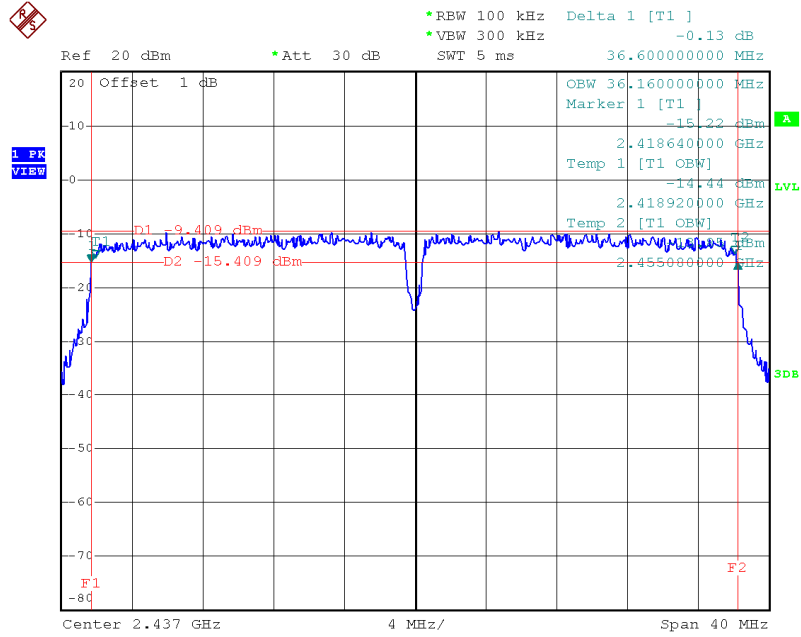

Date: 6.JUN.2015 20:46:01

### TX CH09

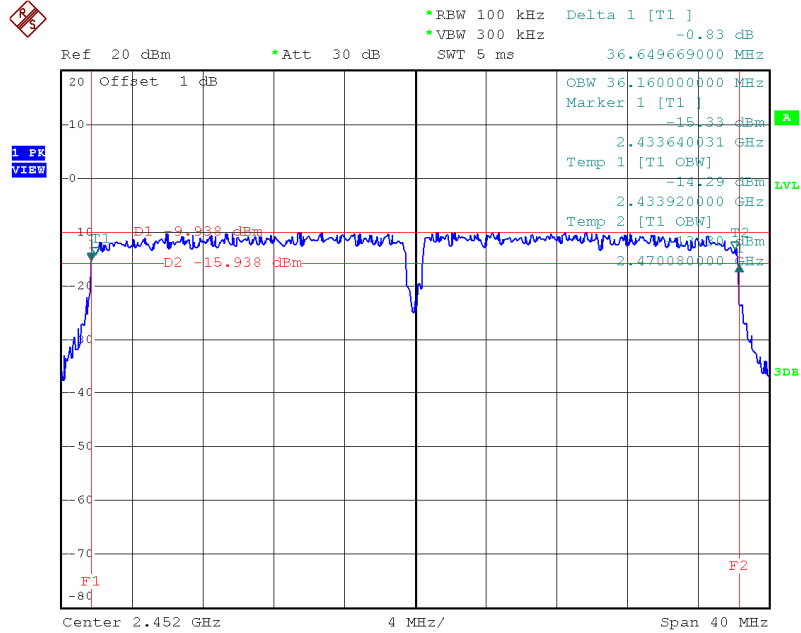

Date: 6.JUN.2015 20:47:31

**ATTACHMENT F – MAXIMUM PEAK CONDUCTED OUTPUT  
POWER**

**Test Mode :TX B Mode\_CH01/06/11\_ANT 1**

Frequency (MHz)	Conducted Power (dBm)	Conducted Power (W)	Max. Limit (dBm)	Max. Limit (W)	Result
2412	16.61	0.05	30.00	1.00	Complies
2437	16.50	0.04	30.00	1.00	Complies
2462	16.33	0.04	30.00	1.00	Complies

**Test Mode :TX G Mode\_CH01/06/11\_ANT 1**

Frequency (MHz)	Conducted Power (dBm)	Conducted Power (W)	Max. Limit (dBm)	Max. Limit (W)	Result
2412	23.55	0.23	30.00	1.00	Complies
2437	23.72	0.24	30.00	1.00	Complies
2462	23.48	0.22	30.00	1.00	Complies

**Test Mode :TX N20 Mode\_CH01/06/11\_ANT 1**

Frequency (MHz)	Conducted Power (dBm)	Conducted Power (W)	Max. Limit (dBm)	Max. Limit (W)	Result
2412	20.44	0.11	30.00	1.00	Complies
2437	20.66	0.12	30.00	1.00	Complies
2462	20.53	0.11	30.00	1.00	Complies

**Test Mode :TX N20 Mode\_CH01/06/11\_ANT 2**

Frequency (MHz)	Conducted Power (dBm)	Conducted Power (W)	Max. Limit (dBm)	Max. Limit (W)	Result
2412	20.44	0.11	30.00	1.00	Complies
2437	20.30	0.11	30.00	1.00	Complies
2462	20.08	0.10	30.00	1.00	Complies

**Test Mode :TX N20 Mode\_CH01/06/11\_Total**

Frequency (MHz)	Conducted Power (dBm)	Conducted Power (W)	Max. Limit (dBm)	Max. Limit (W)	Result
2412	23.45	0.22	30.00	1.00	Complies
2437	23.49	0.22	30.00	1.00	Complies
2462	23.32	0.21	30.00	1.00	Complies

**Test Mode :TX N40 Mode\_CH03/06/09\_ANT 1**

Frequency (MHz)	Conducted Power (dBm)	Conducted Power (W)	Max. Limit (dBm)	Max. Limit (W)	Result
2422	19.74	0.09	30.00	1.00	Complies
2437	19.78	0.10	30.00	1.00	Complies
2452	19.57	0.09	30.00	1.00	Complies

**Test Mode :TX N40 Mode\_CH03/06/09\_ANT 2**

Frequency (MHz)	Conducted Power (dBm)	Conducted Power (W)	Max. Limit (dBm)	Max. Limit (W)	Result
2422	19.66	0.09	30.00	1.00	Complies
2437	19.52	0.09	30.00	1.00	Complies
2452	19.27	0.08	30.00	1.00	Complies

**Test Mode :TX N40 Mode\_CH03/06/09\_Total**

Frequency (MHz)	Conducted Power (dBm)	Conducted Power (W)	Max. Limit (dBm)	Max. Limit (W)	Result
2422	22.71	0.19	30.00	1.00	Complies
2437	22.66	0.18	30.00	1.00	Complies
2452	22.43	0.18	30.00	1.00	Complies



**ATTACHMENT G - ANTENNA CONDUCTED SPURIOUS  
EMISSION**

Test Mode :	TX B Mode_ANT 1
-------------	-----------------

### TX B mode CH01

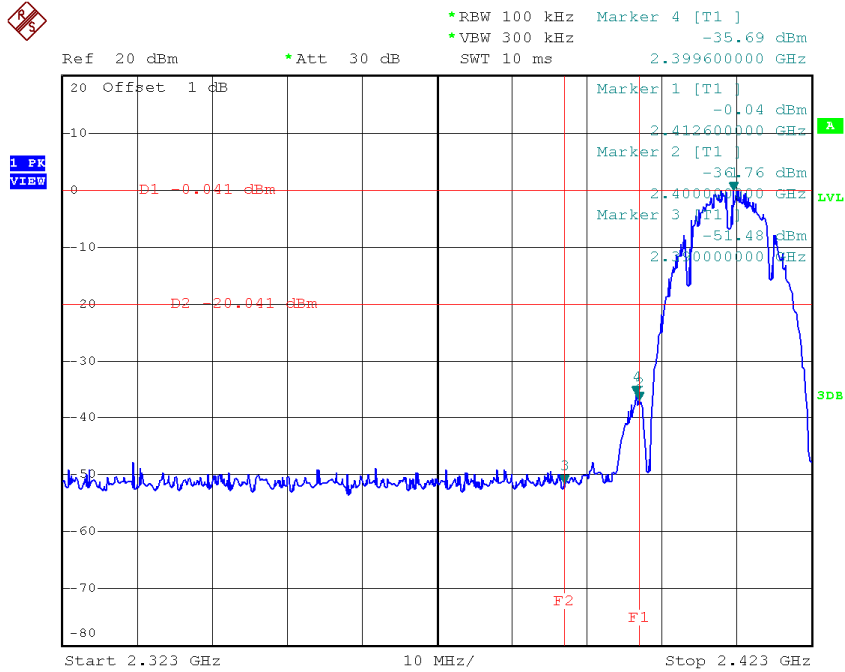

Date: 6.JUN.2015 20:28:00

### TX B mode CH11

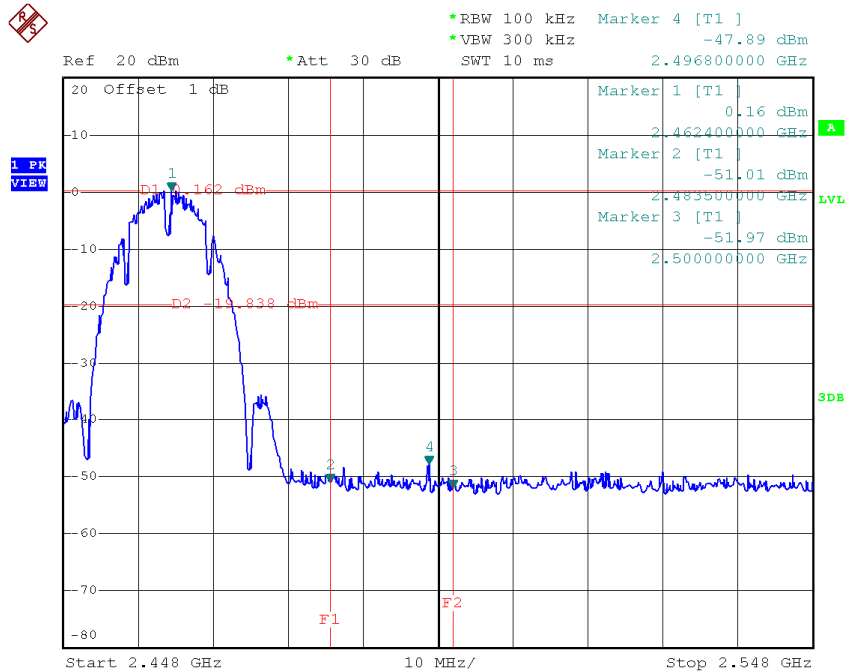

Date: 6.JUN.2015 20:32:47

### TX B mode CH01 (10 Harmonic of the frequency)

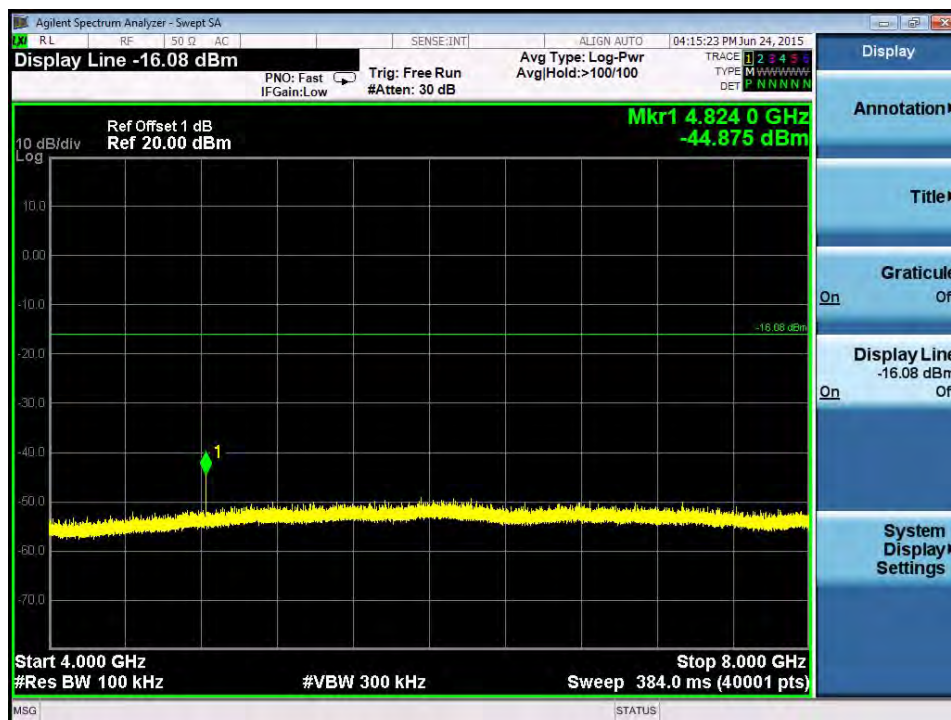
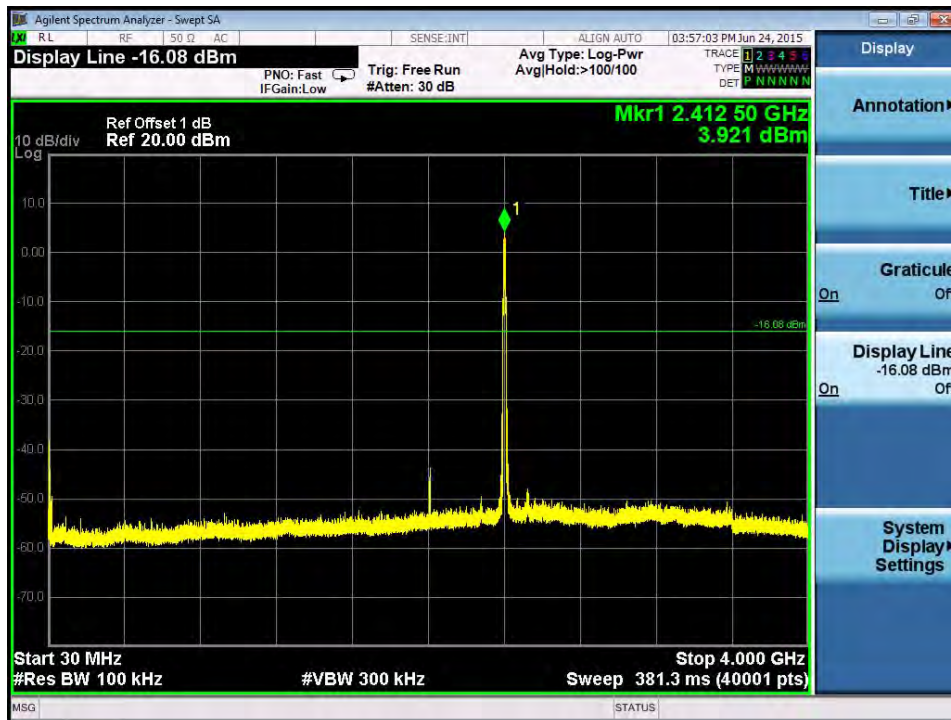

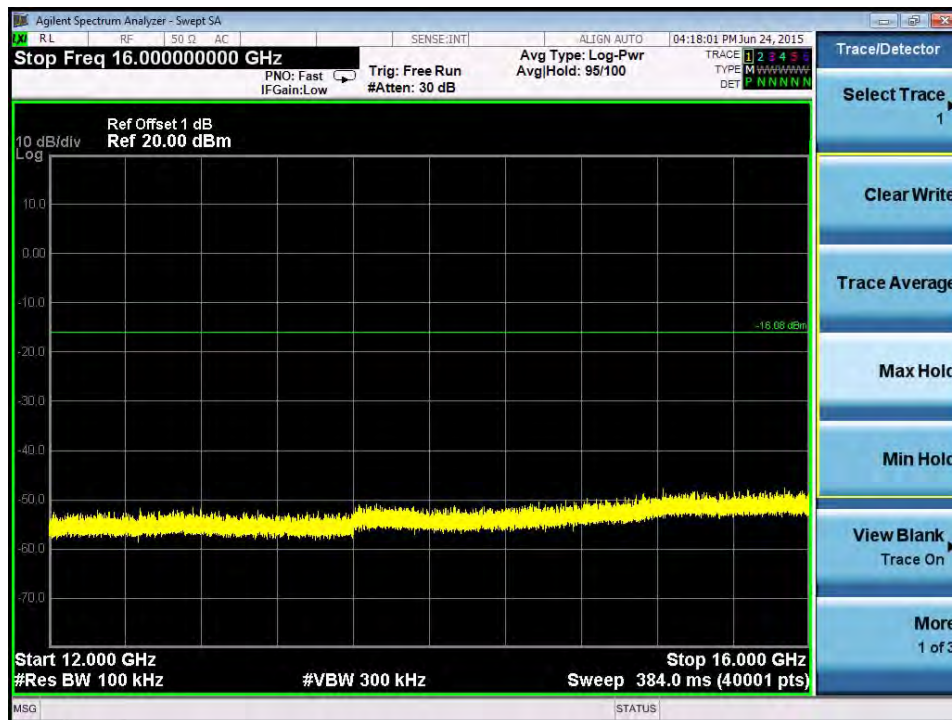
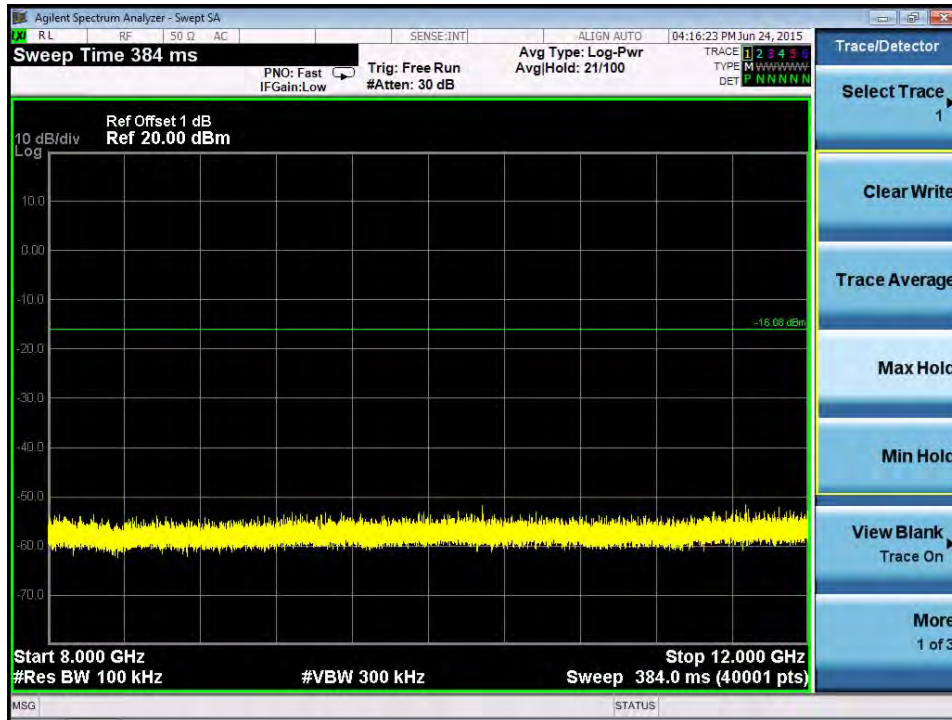

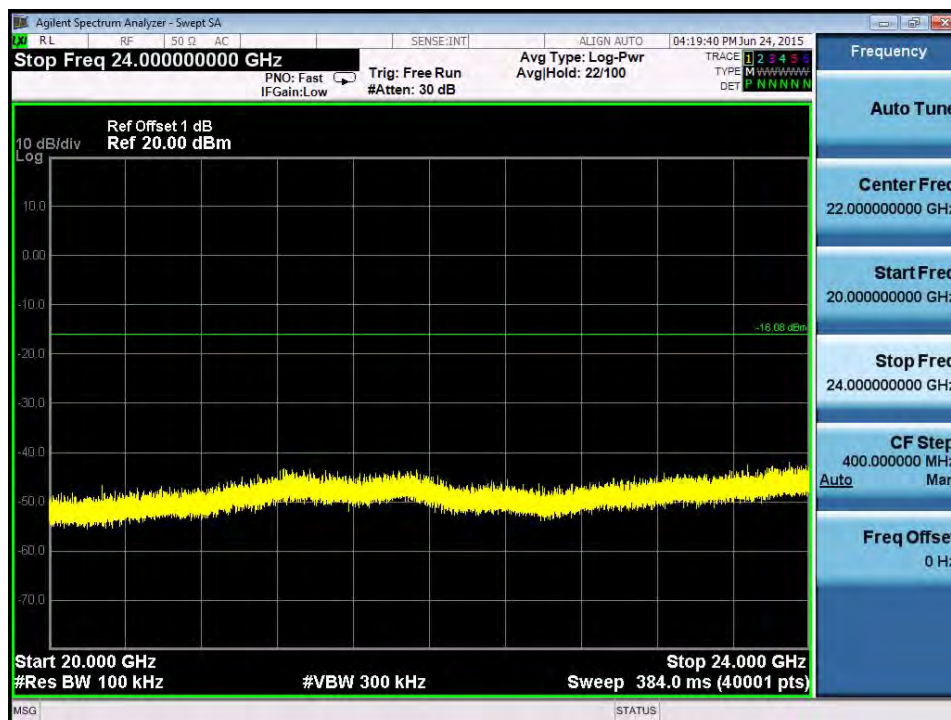
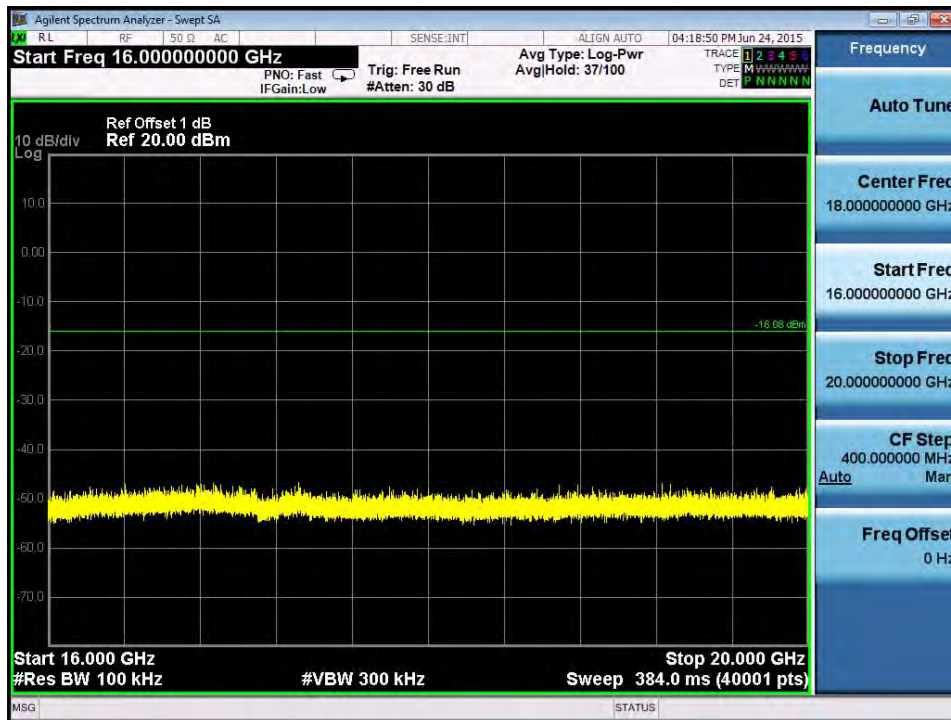

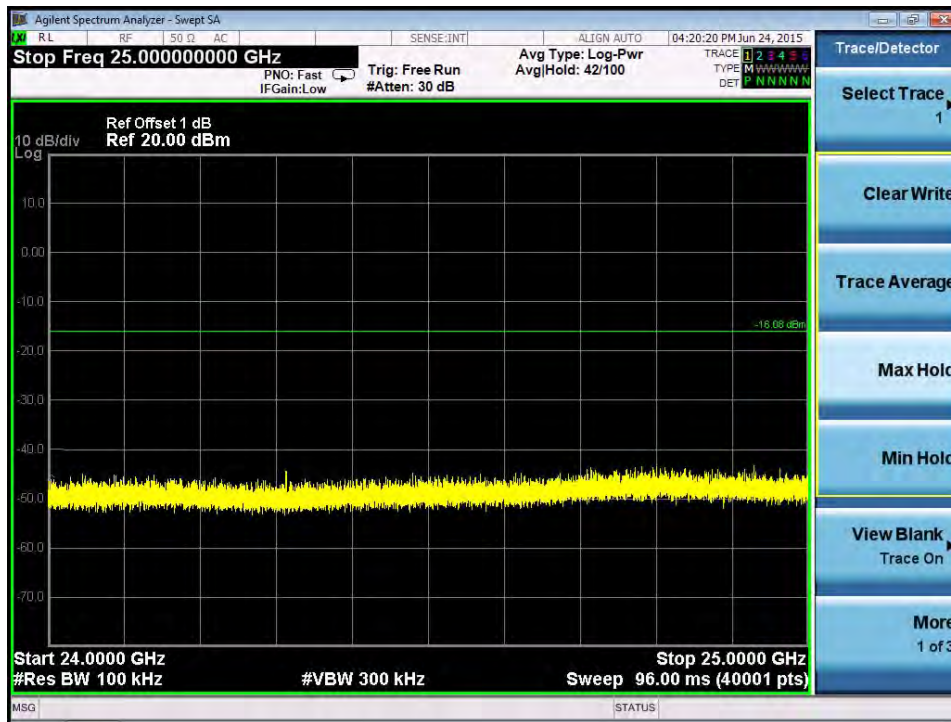

### TX B mode CH06 (10 Harmonic of the frequency)

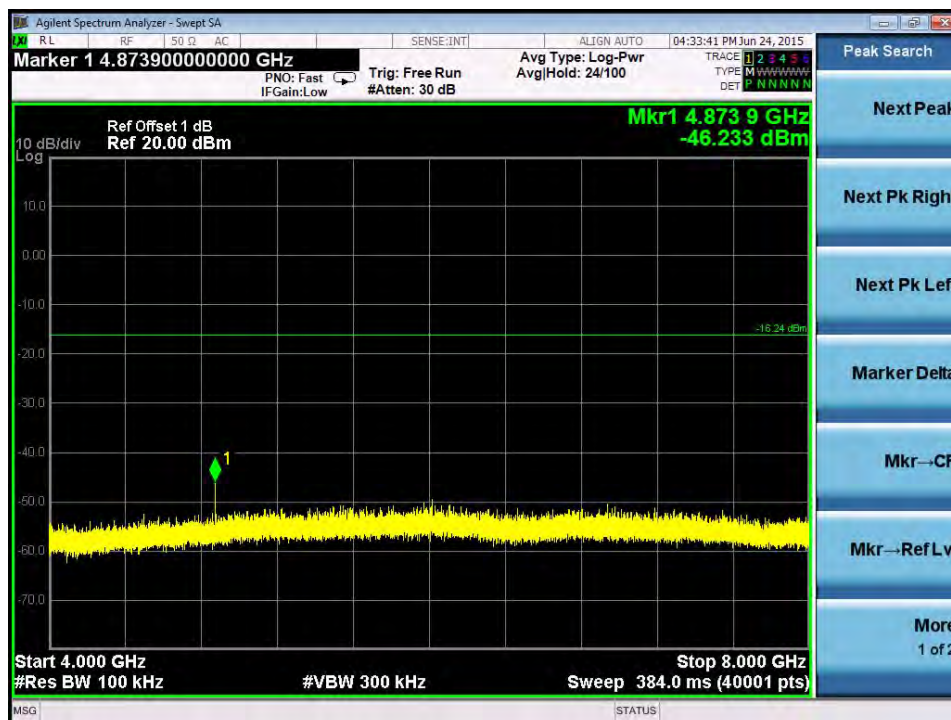
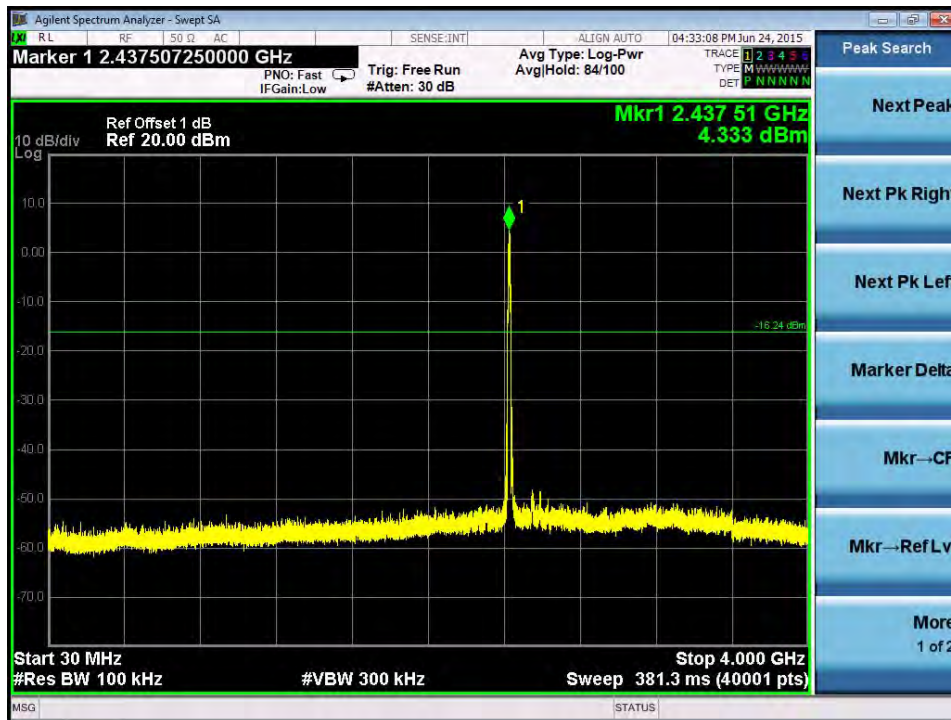



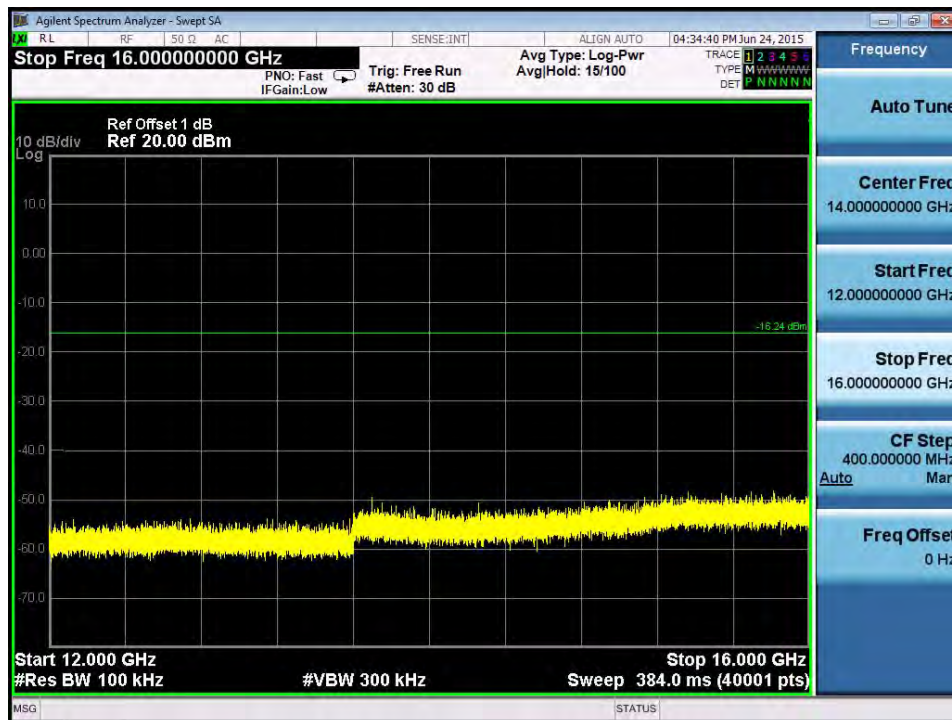
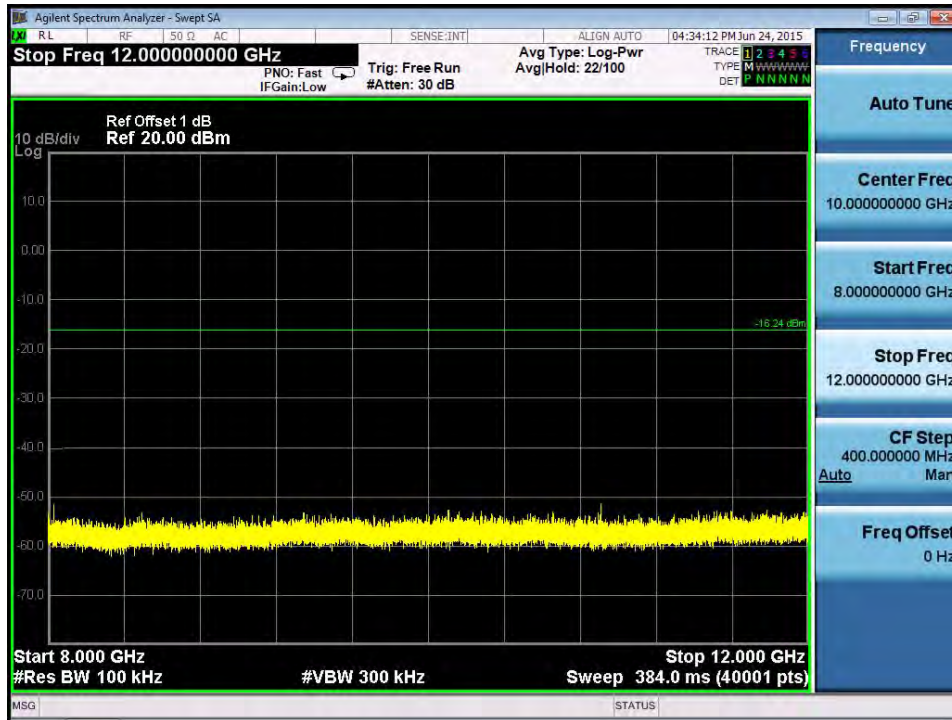

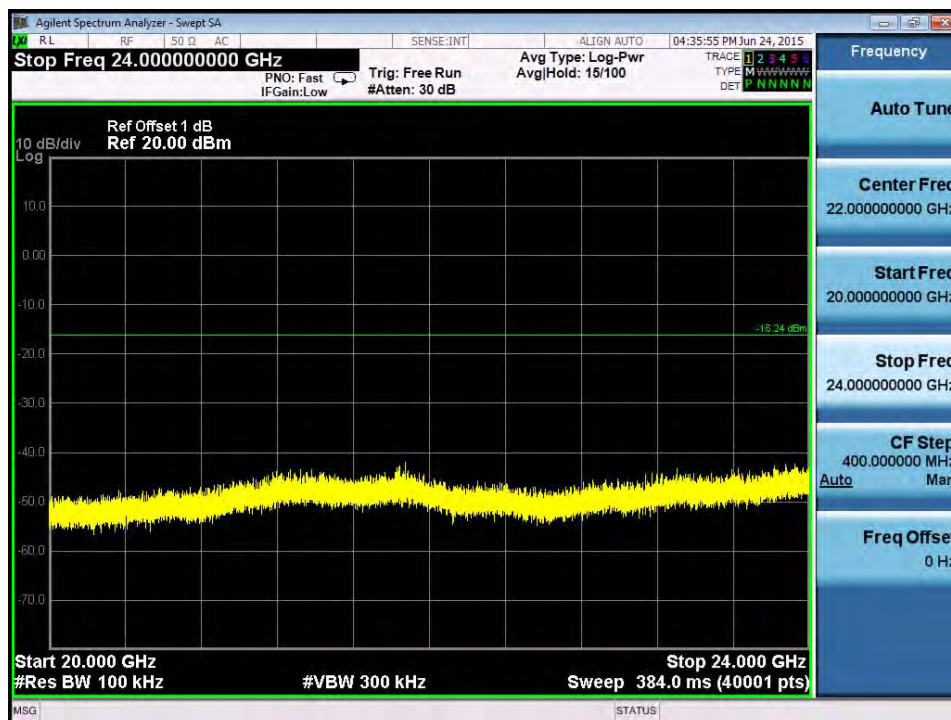
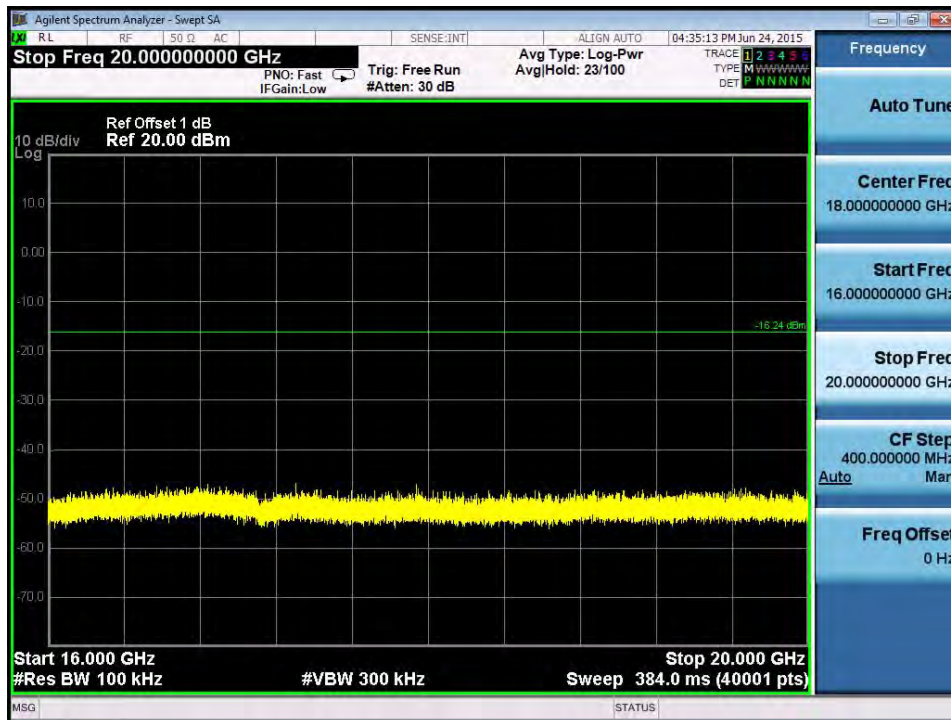

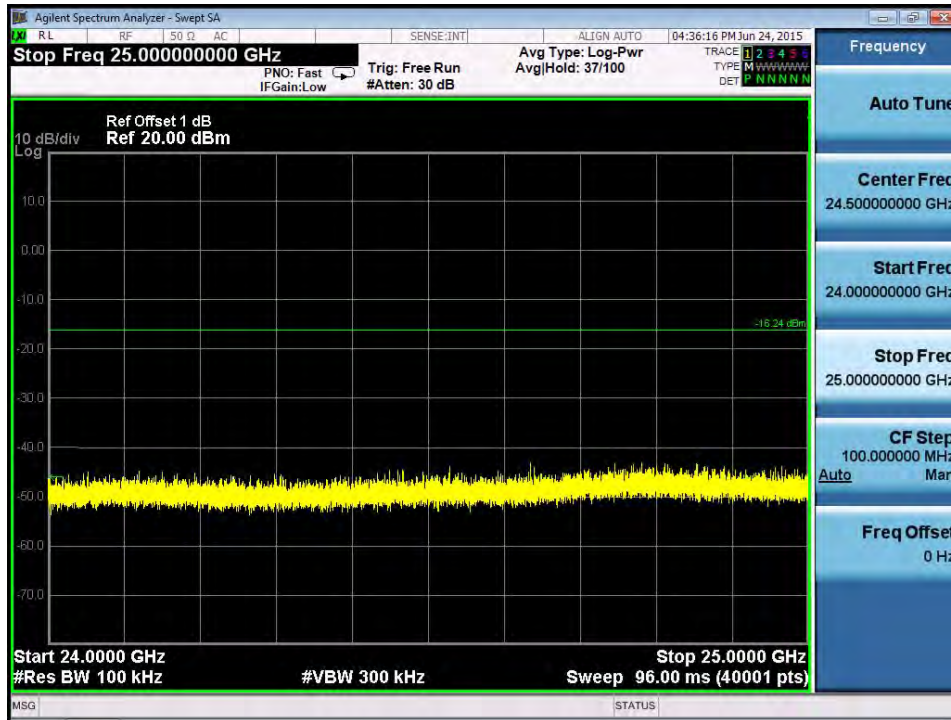

### TX B mode CH11 (10 Harmonic of the frequency)

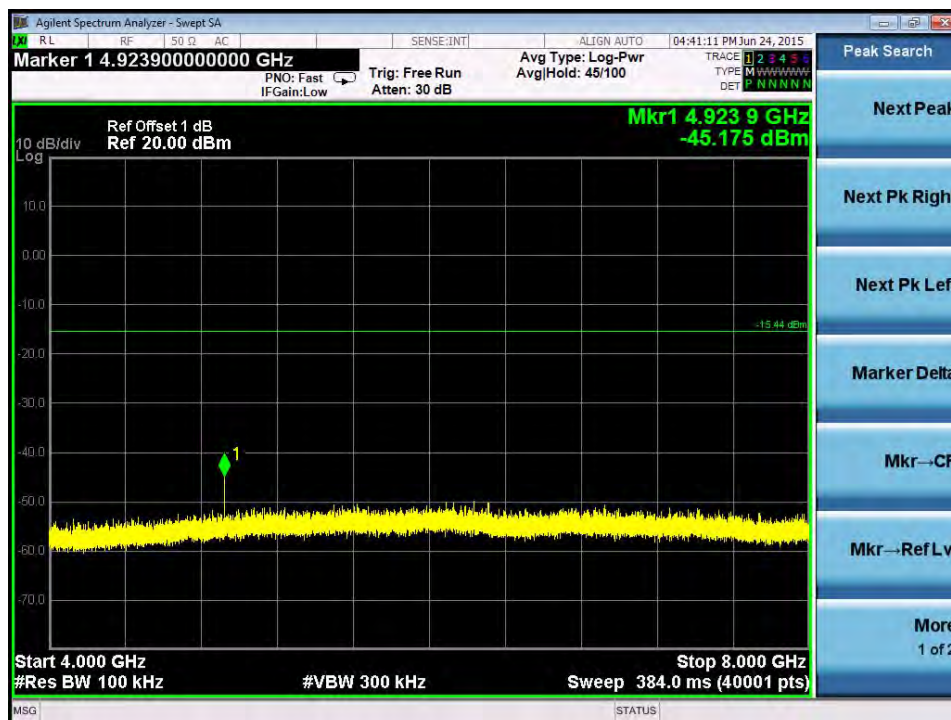
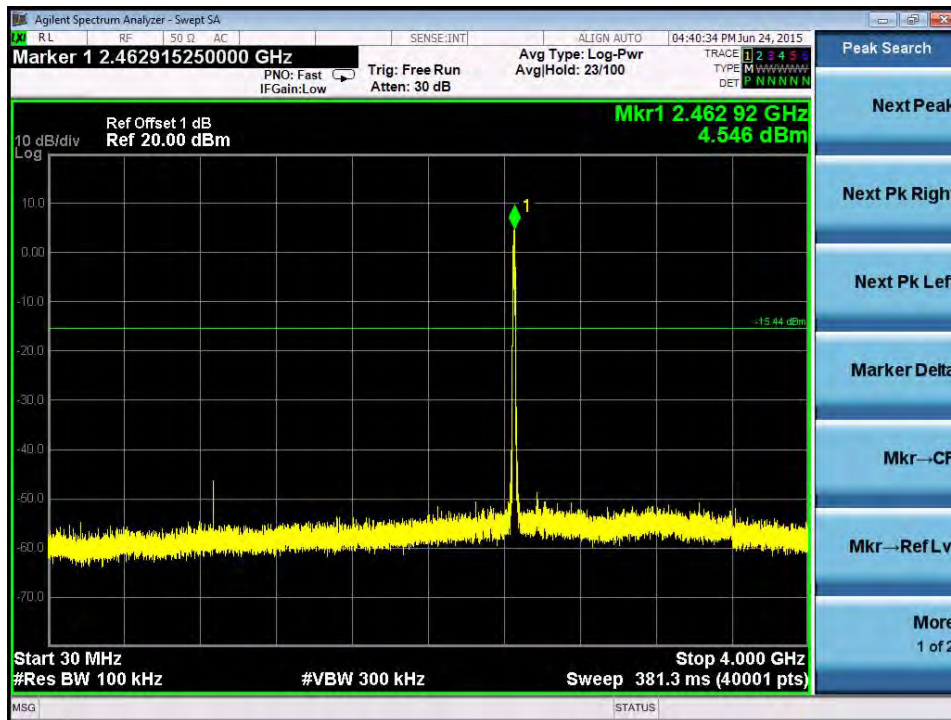

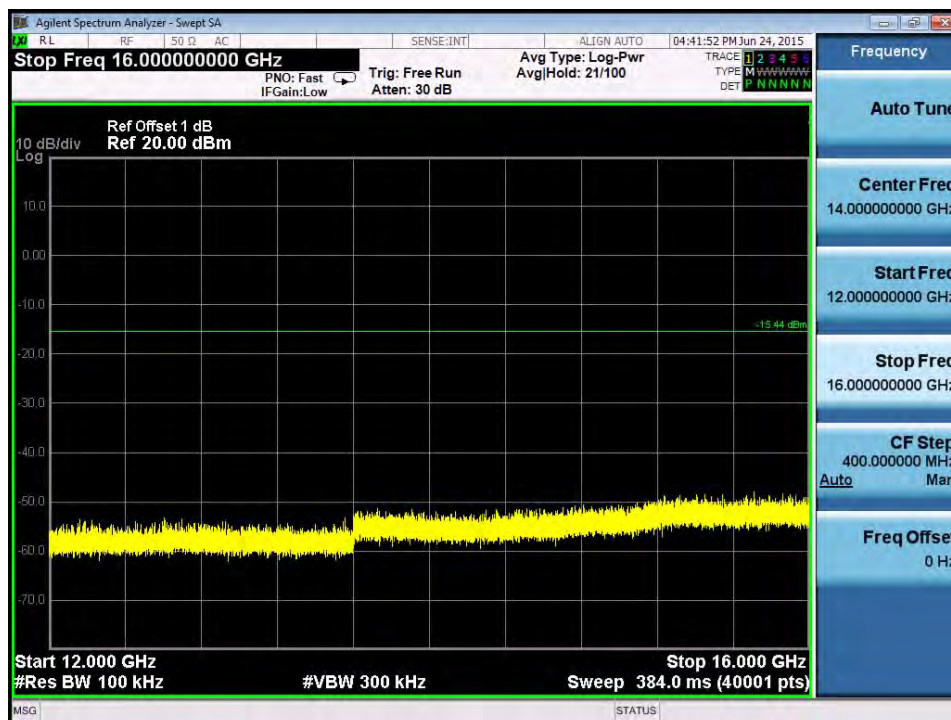
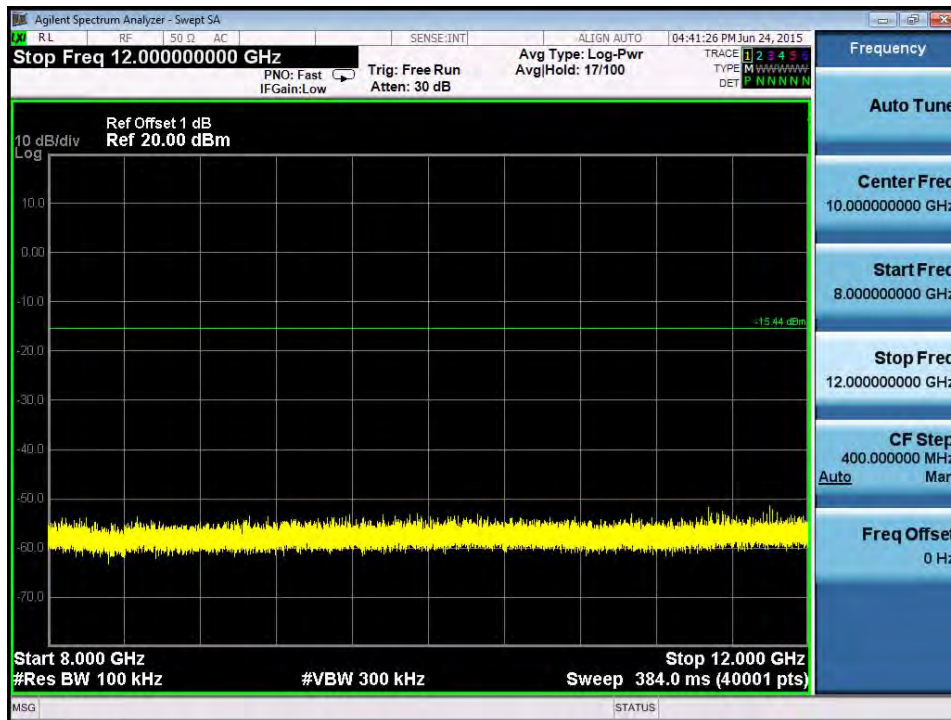

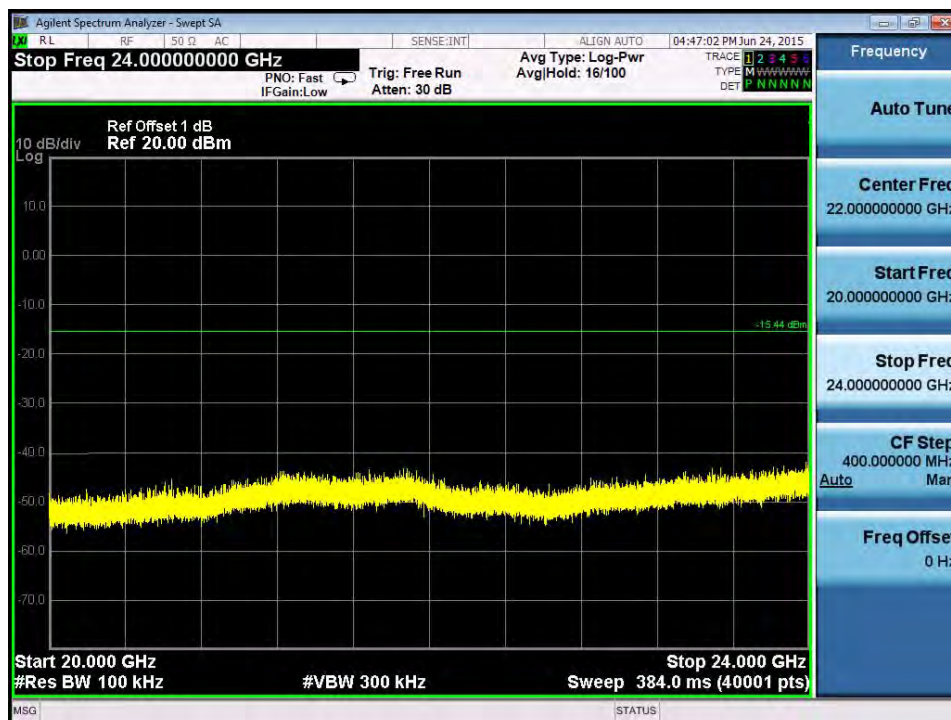
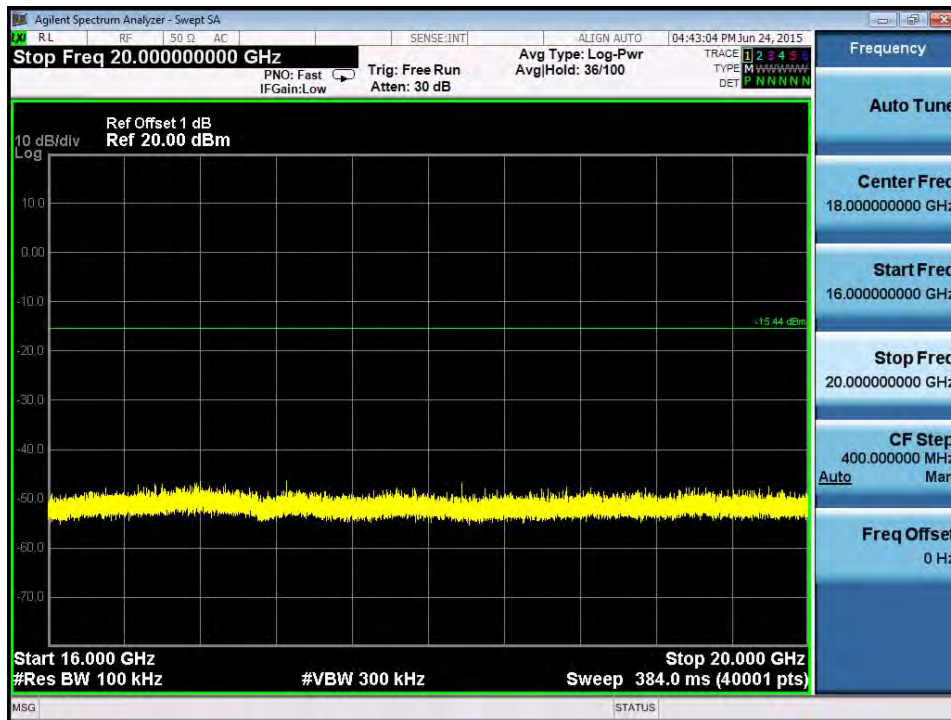



Test Mode :	TX G Mode_ANT 1
-------------	-----------------



### TX G mode CH01

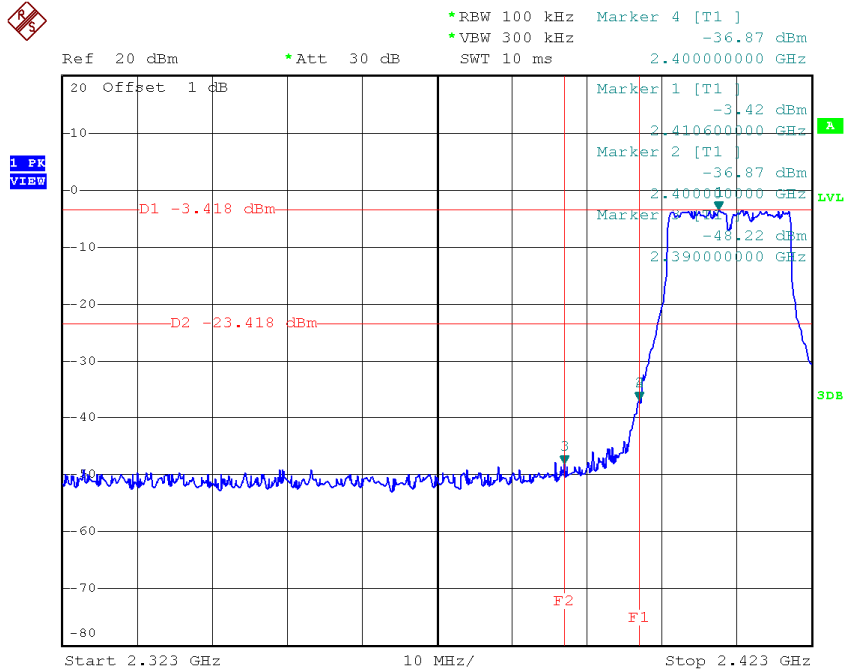

Date: 6.JUN.2015 20:34:15

### TX G mode CH11

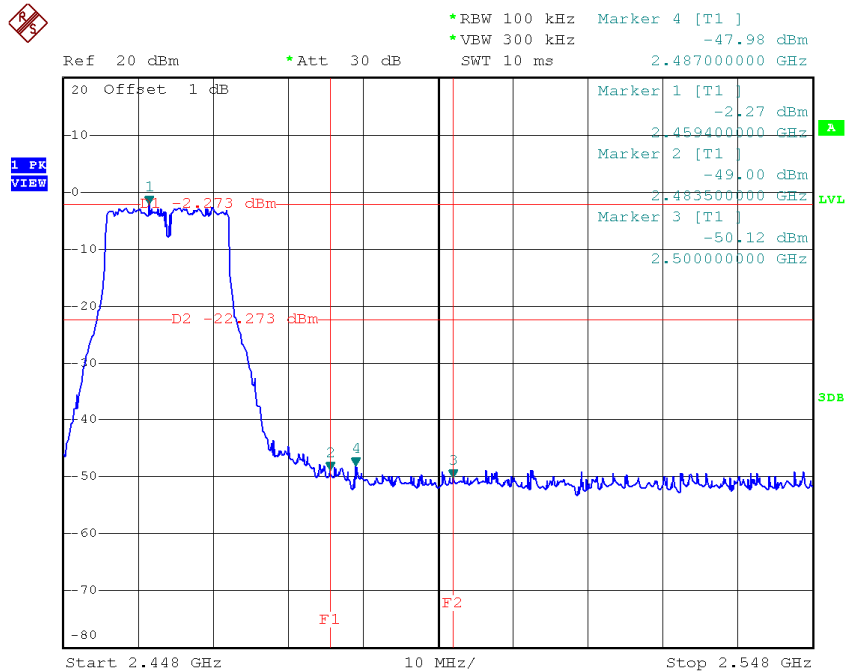

Date: 6.JUN.2015 20:36:21

### TX G mode CH01 (10 Harmonic of the frequency)

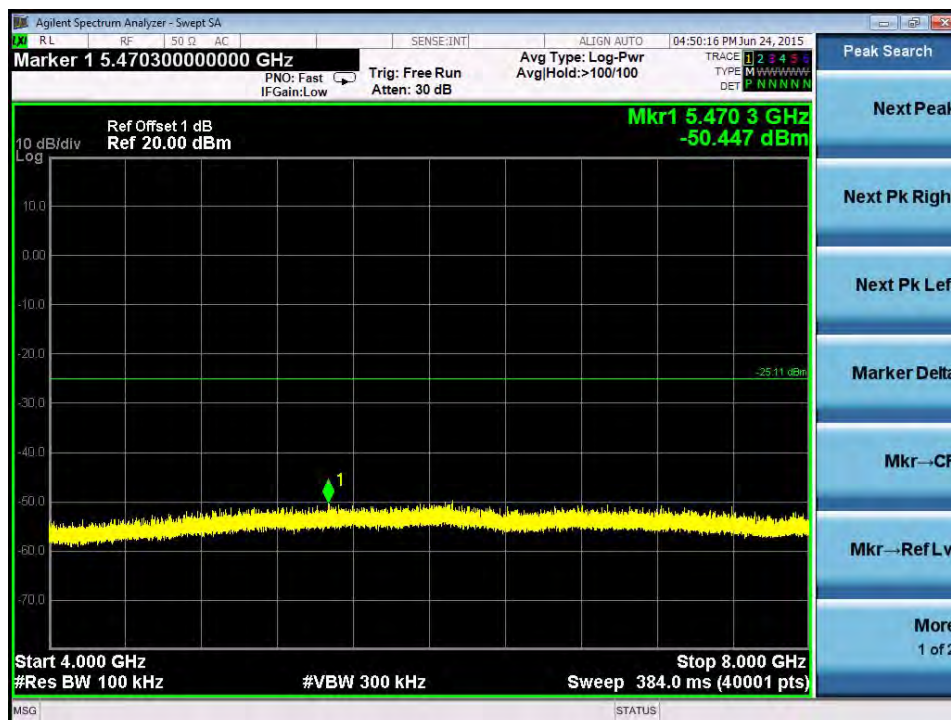
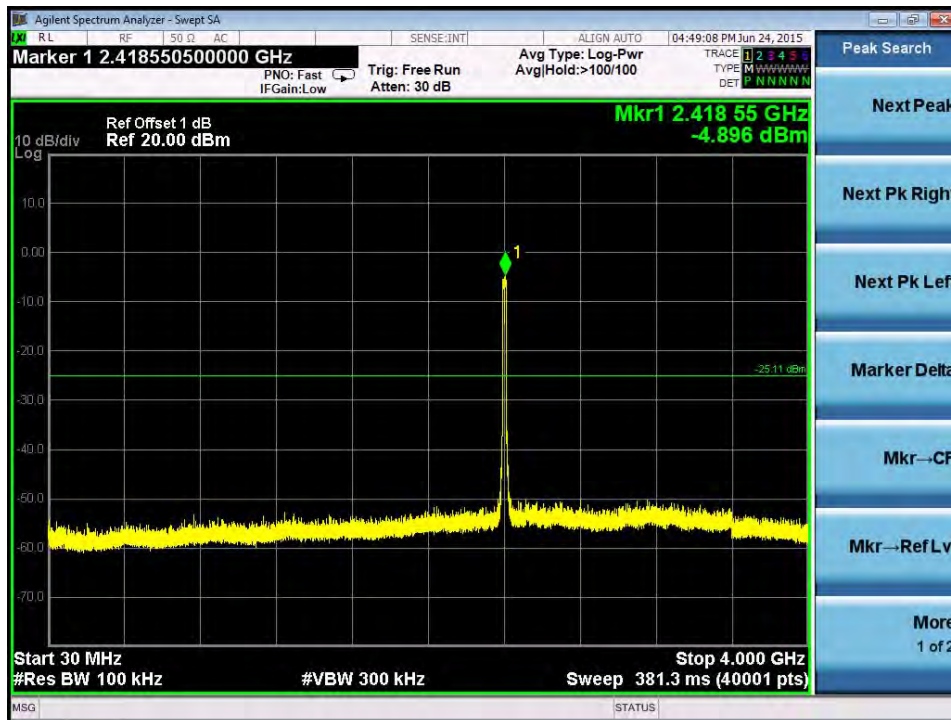

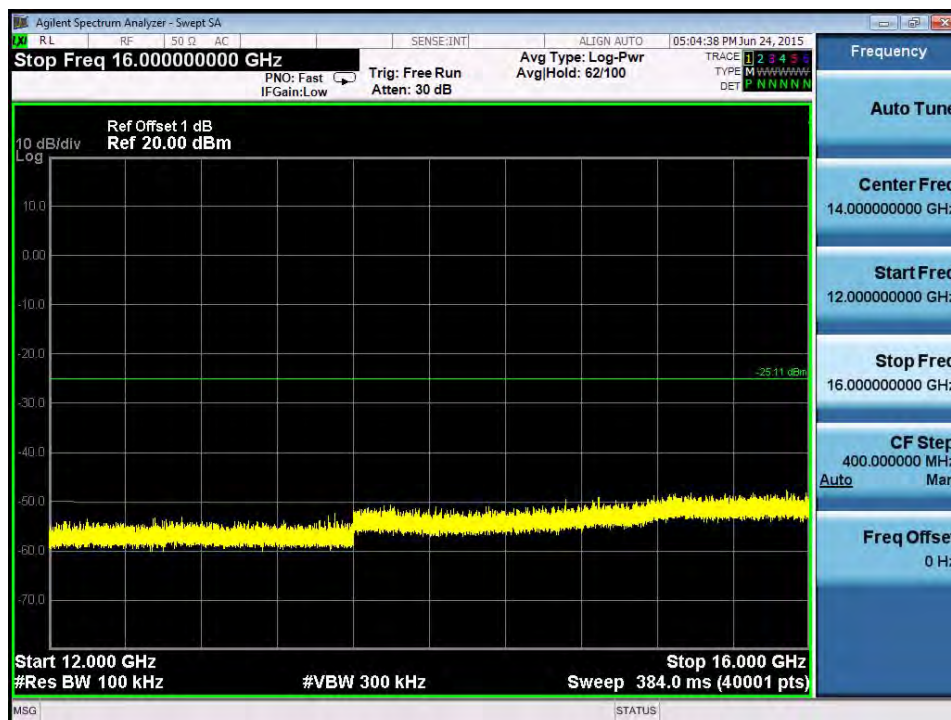
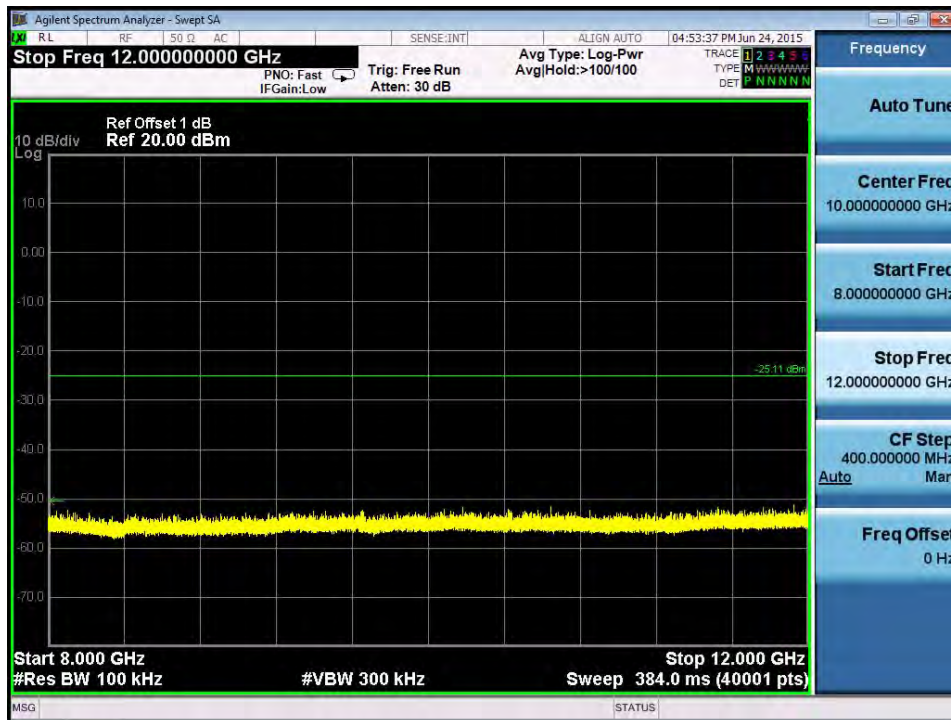

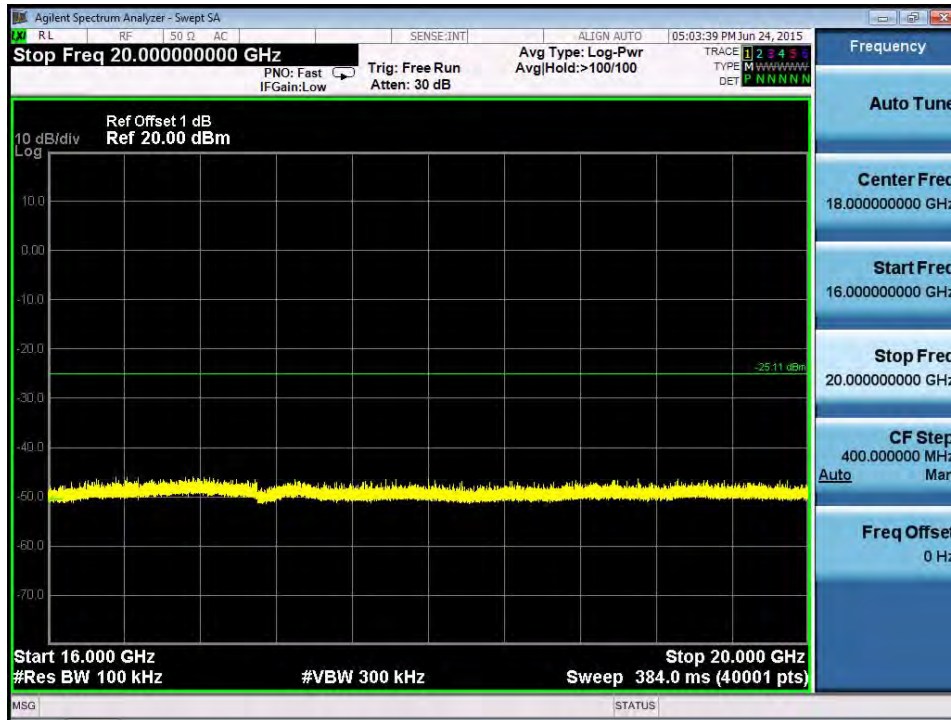

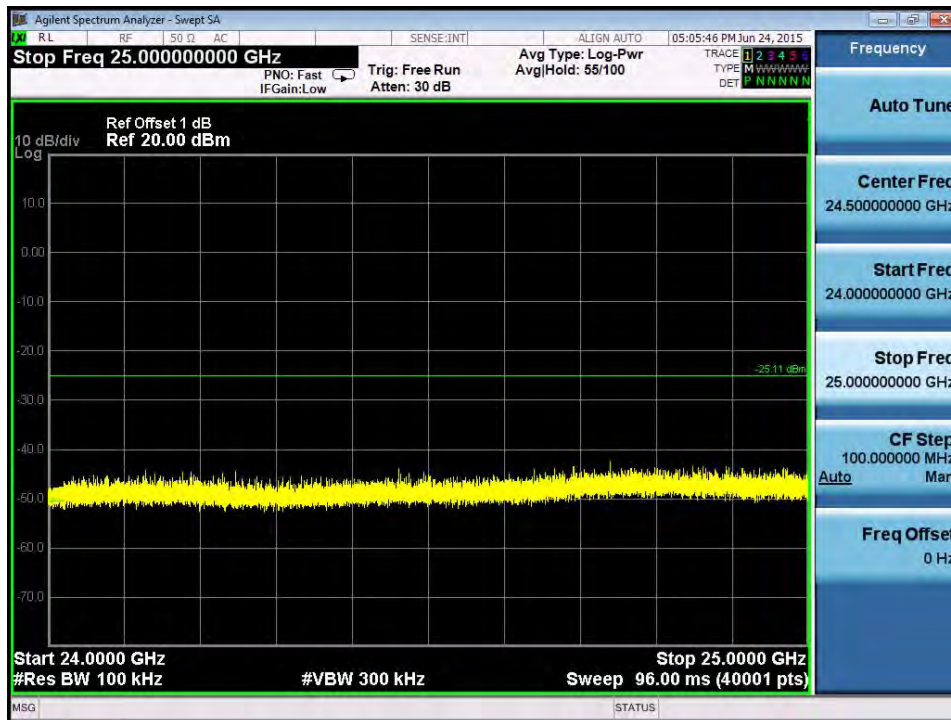

### TX G mode CH06 (10 Harmonic of the frequency)

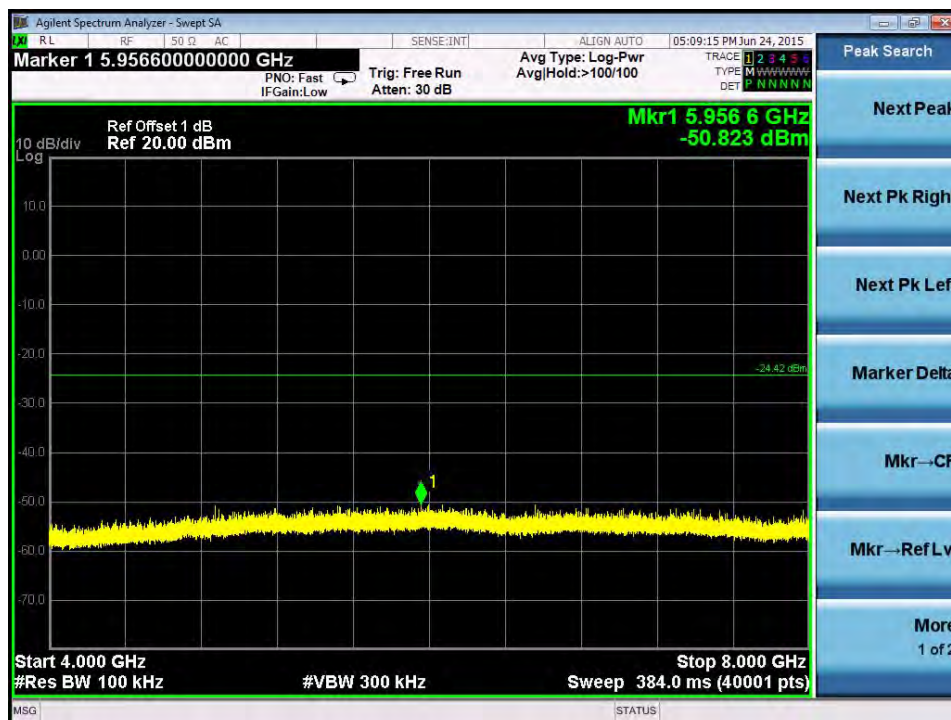
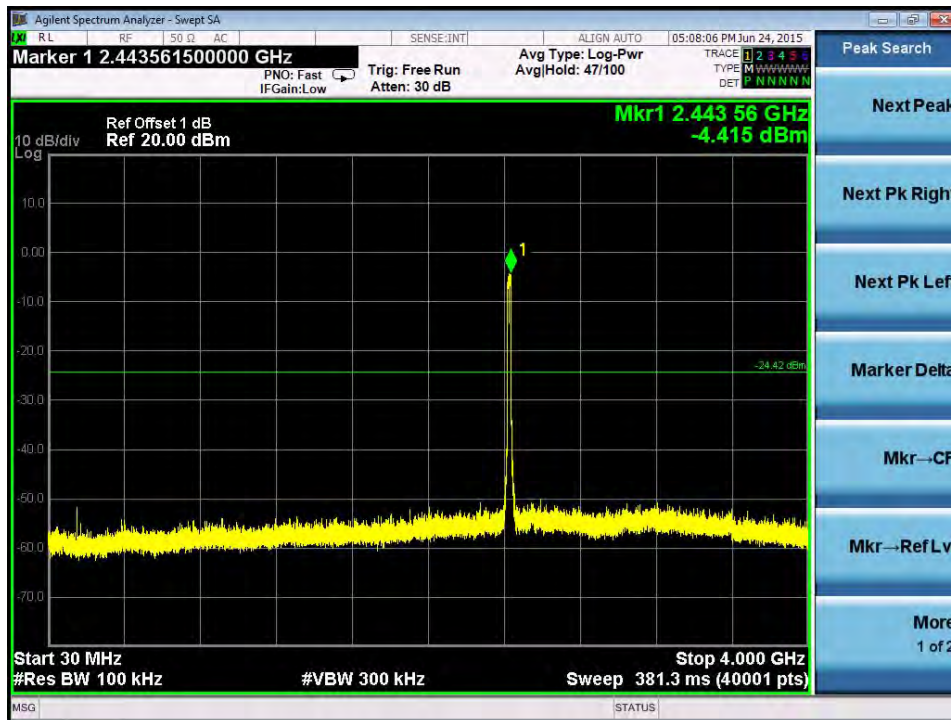

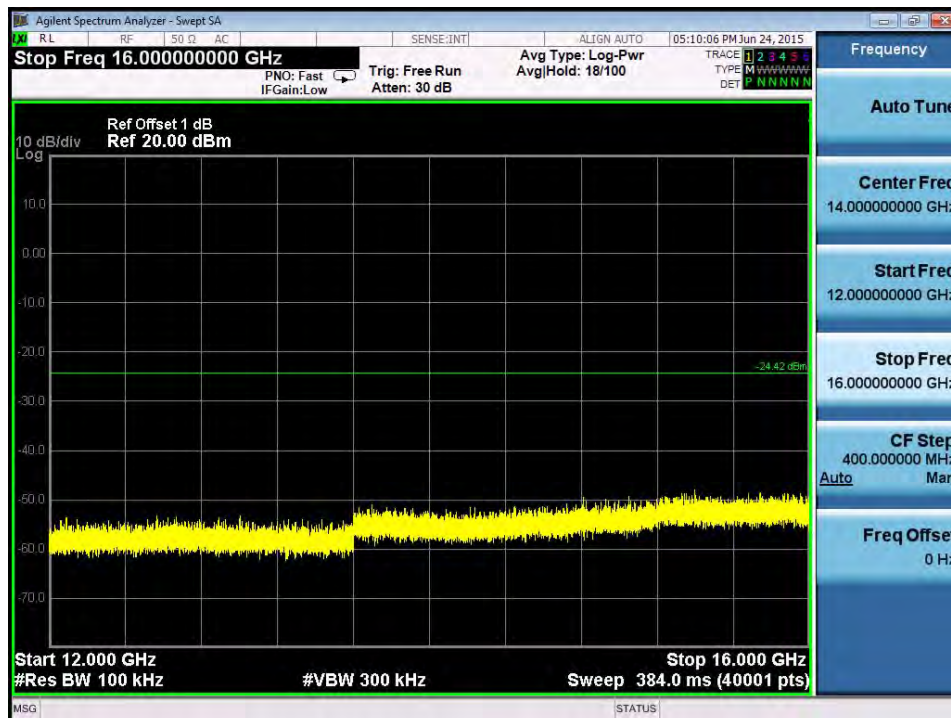
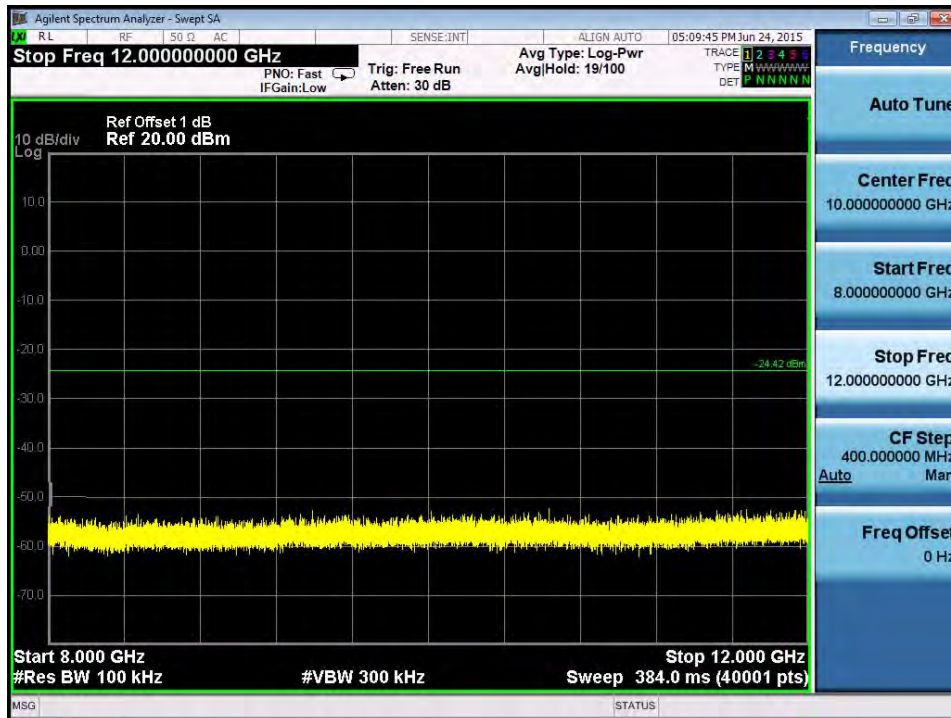

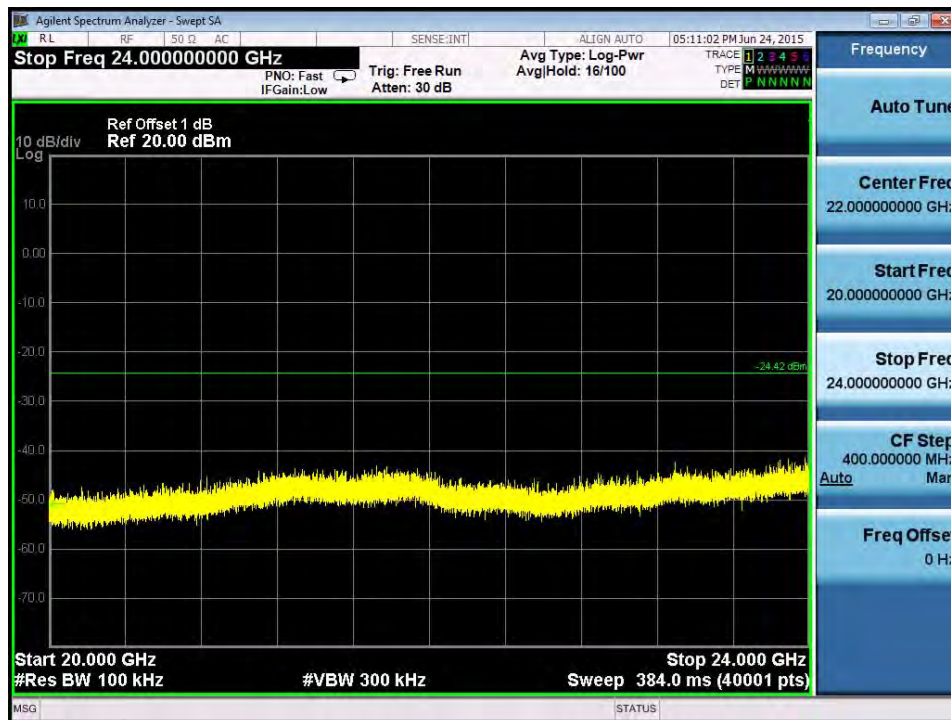
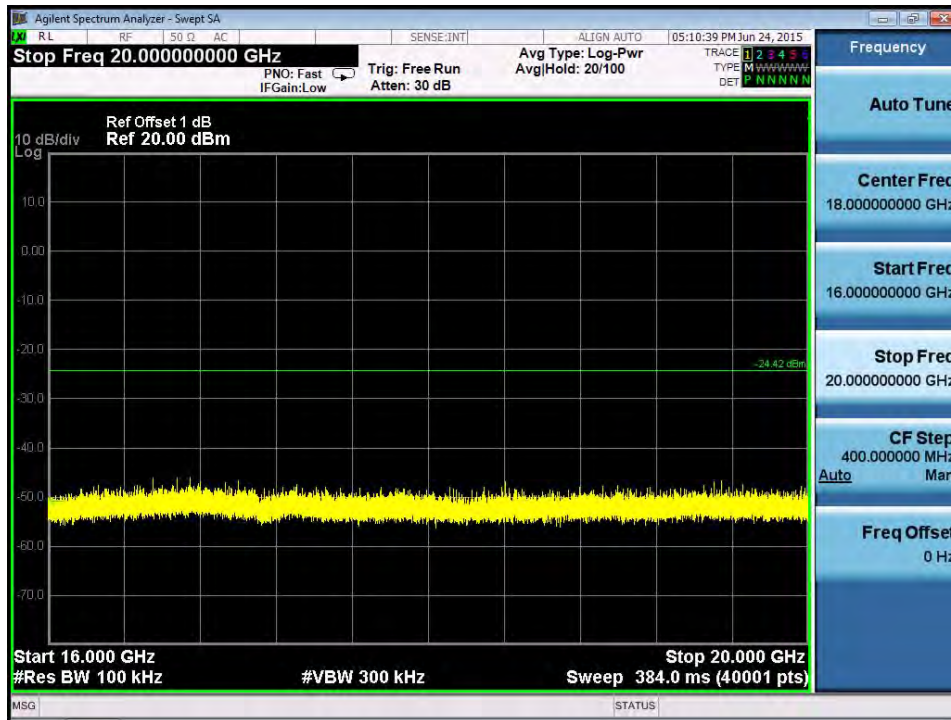



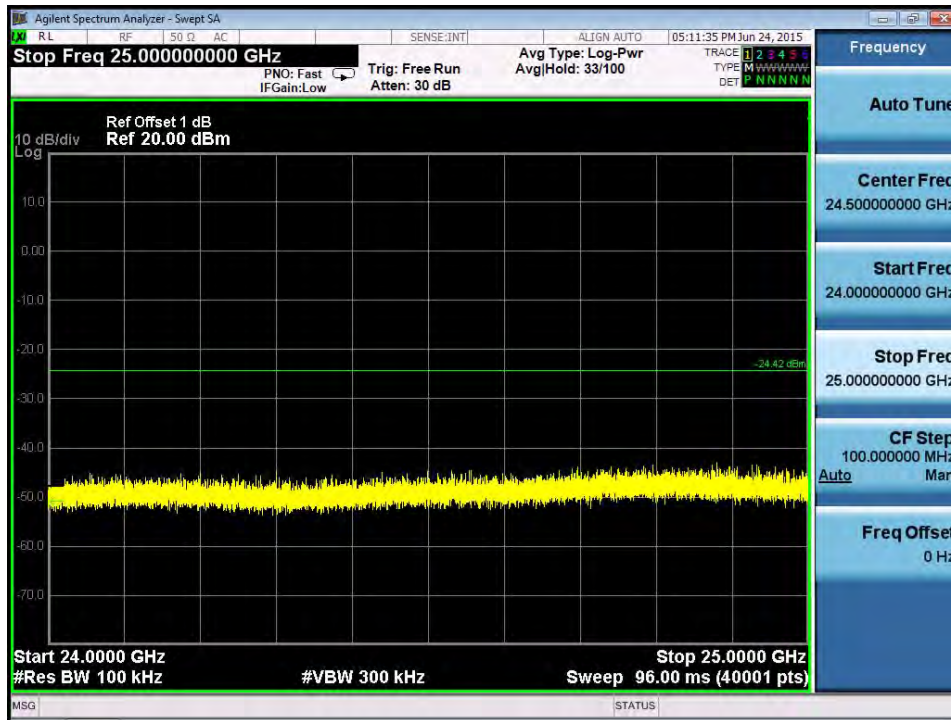

### TX G mode CH11 (10 Harmonic of the frequency)

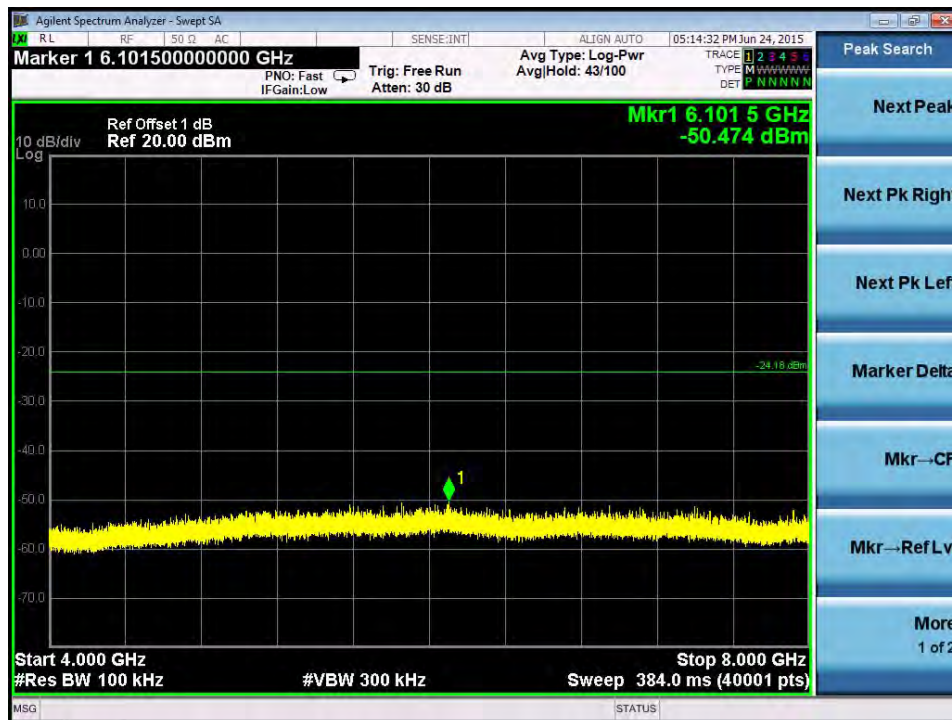
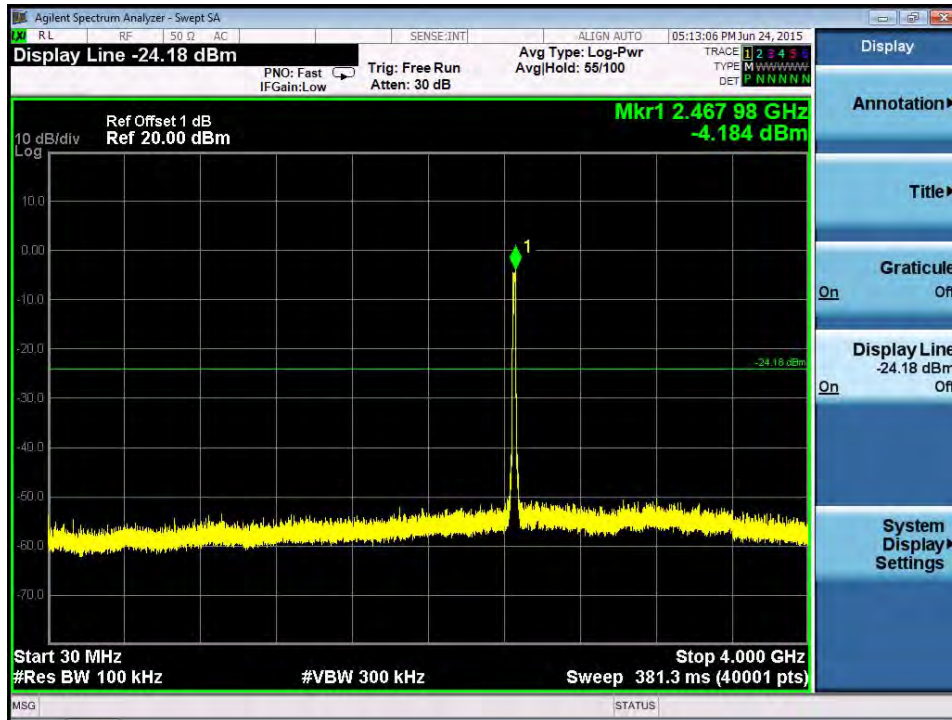

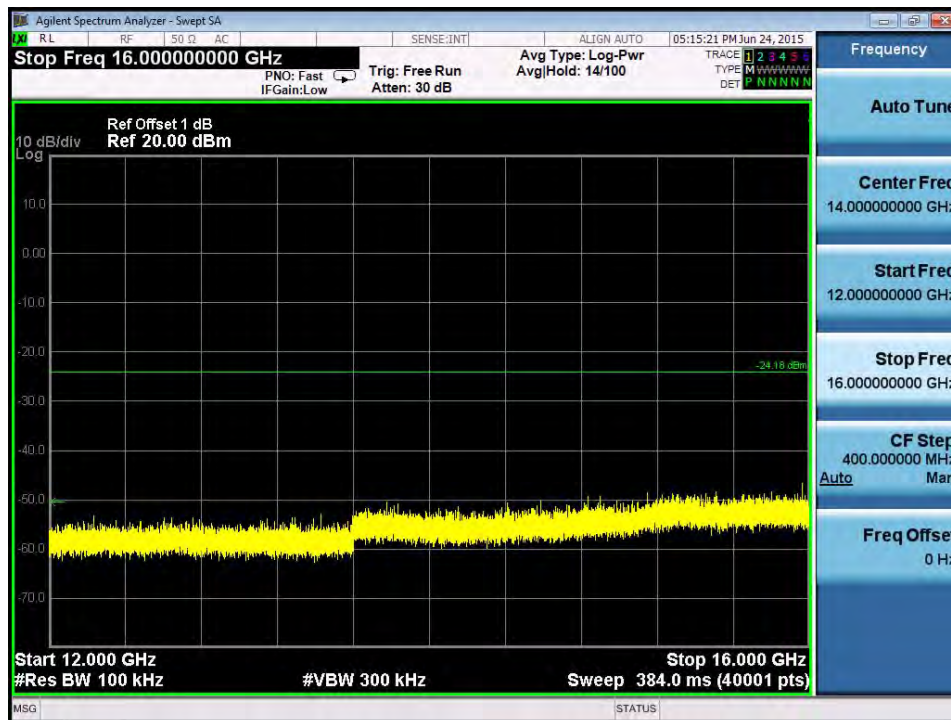
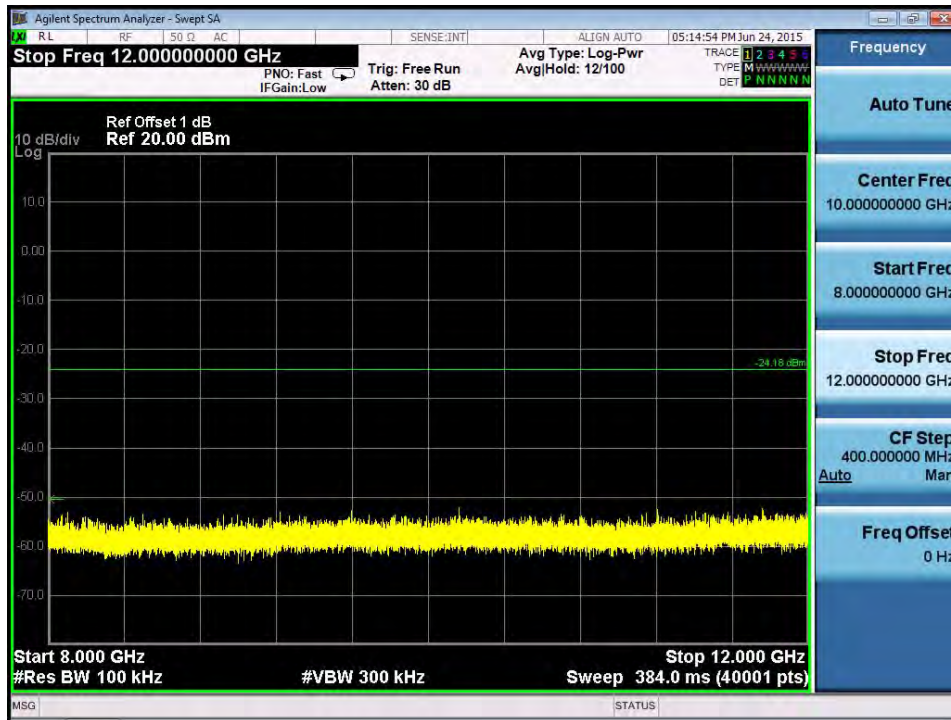

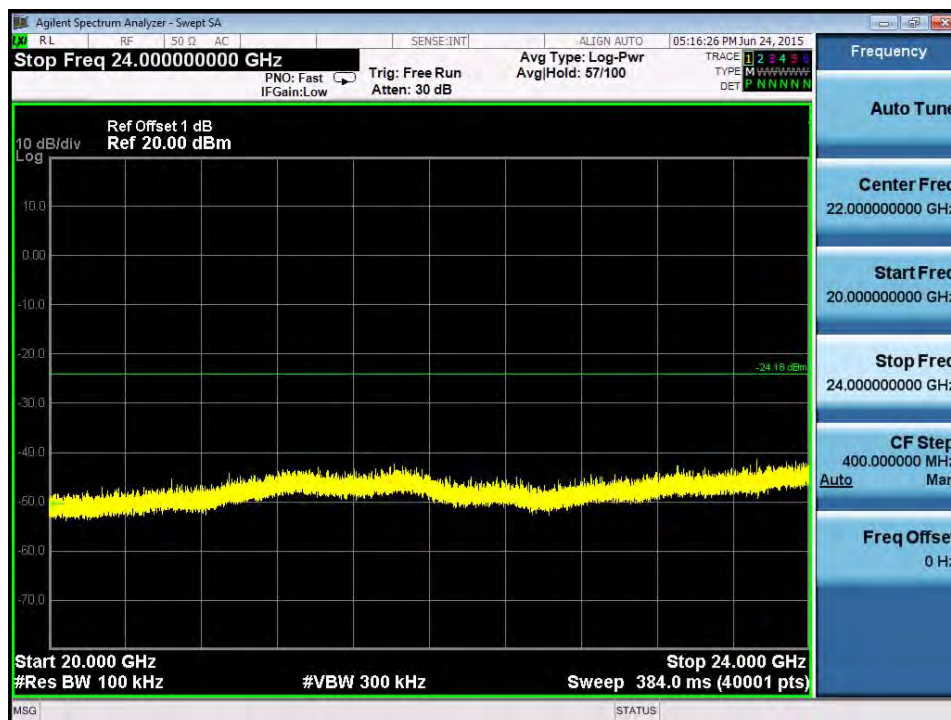
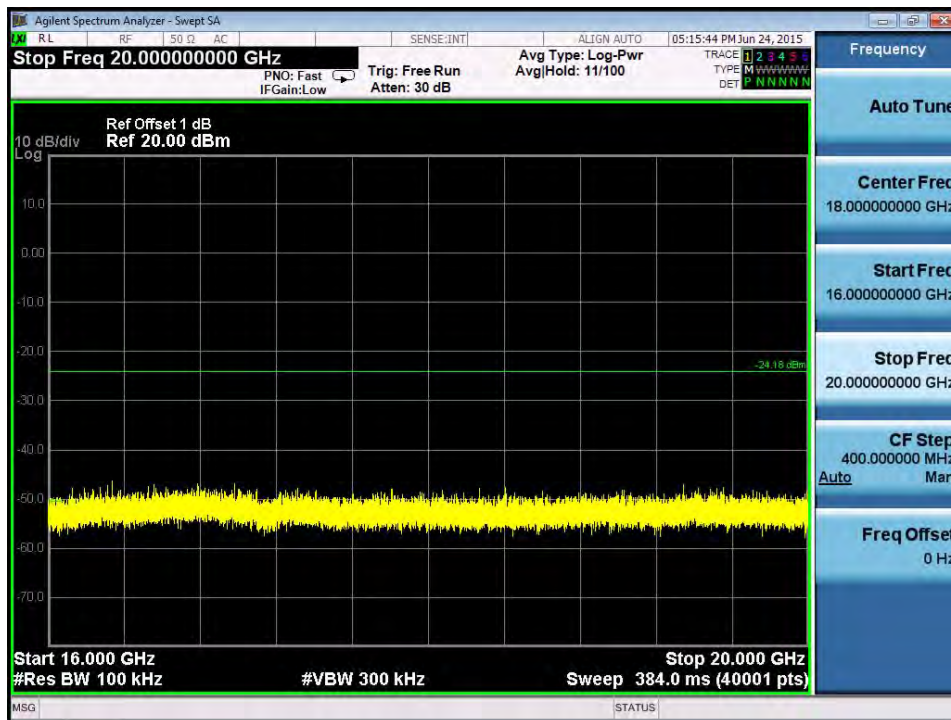

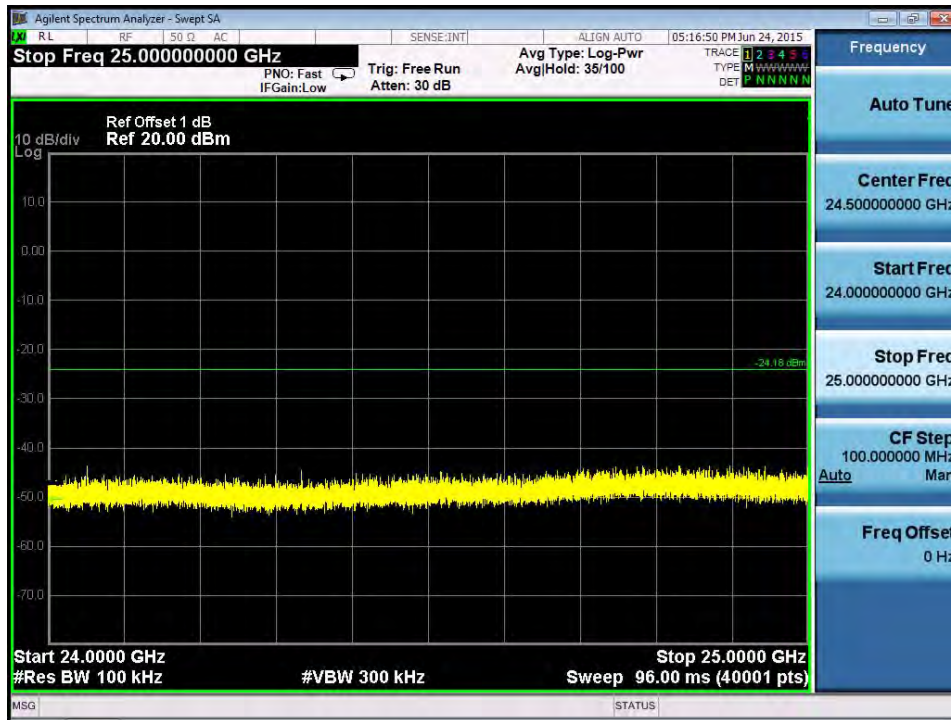

Test Mode :	TX N-20M Mode_ANT 1
-------------	---------------------

### TX HT20 mode CH01

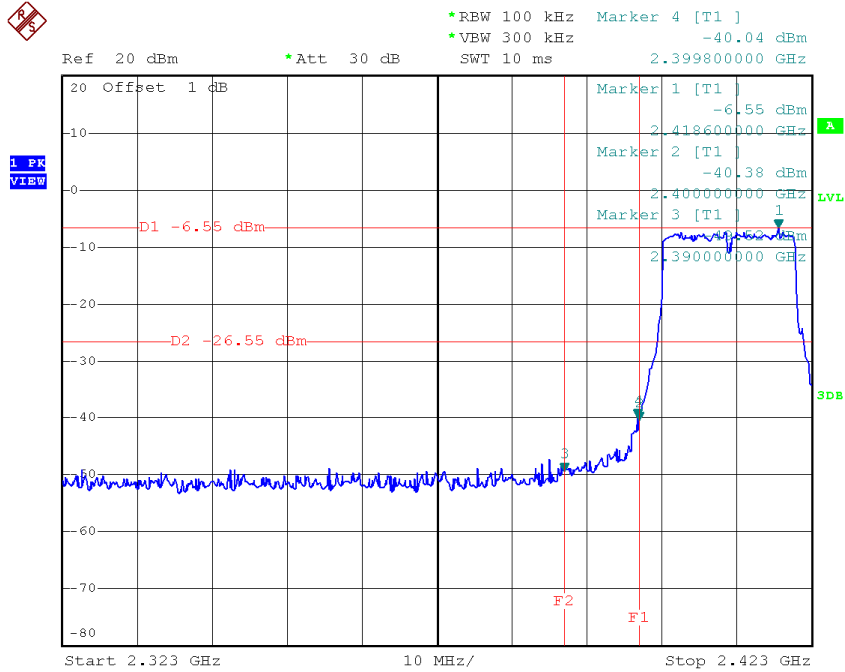

Date: 6.JUN.2015 20:37:55

### TX HT20 mode CH11

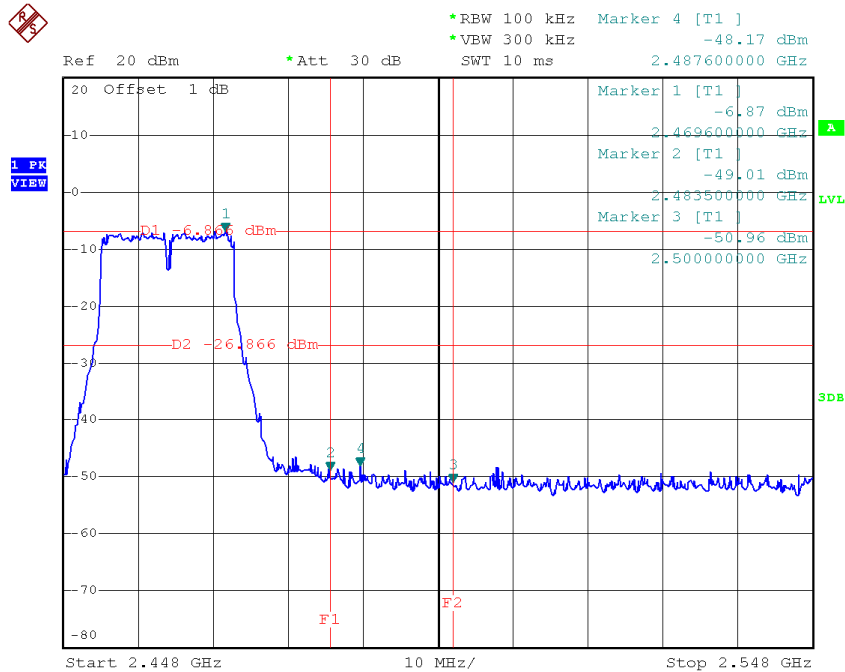

Date: 6.JUN.2015 20:39:59