

**FCC 47 CFR PART 15 SUBPART E AND ANSI C63.10:2013
TEST REPORT**

For

AC1200 Wireless Dual Band VDSL2 Gigabit VoIP IAD

Model: DL4480V

Trade Name: netis

Issued for

NETIS SYSTEMS CO., LTD

**4F & 5F, R&D Building, Oriental Cyberport, High-Tech Industrial Park,
Nanshan, Shenzhen, China**

Issued by

**Compliance Certification Services Inc.
Hsinchu Lab.**

**NO. 989-1 Wen Shan Rd., Shang Shan Village,
Qionglin Township, Hsinchu County 30741, Taiwan (R.O.C.)**

TEL: +886-3-5921698

FAX: +886-3-5921108

**<http://www.ccsrf.com>
E-Mail: service@ccsrf.com**

Issued Date: August 02, 2016



Note: This report shall not be reproduced except in full, without the written approval of Compliance Certification Services Inc. This document may be altered or revised by Compliance Certification Services Inc. personnel only, and shall be noted in the revision section of the document. The client should not use it to claim product endorsement by TAF or any government agencies. The test results of this report relate only to the tested sample identified in this report.

Revision History

Rev.	Issue Date	Revisions	Effect Page	Revised By
00	08/02/2016	Initial Issue	All Page 114	Dola Hsieh

TABLE OF CONTENTS

TITLE	PAGE NO.
1. TEST REPORT CERTIFICATION.....	4
2. EUT DESCRIPTION.....	5
3. DESCRIPTION OF TEST MODES.....	7
4. TEST METHODOLOGY.....	9
5. FACILITIES AND ACCREDITATION.....	9
5.1 FACILITIES.....	9
5.2 ACCREDITATIONS	9
5.3 MEASUREMENT UNCERTAINTY.....	10
6. SETUP OF EQUIPMENT UNDER TEST	11
7. FCC PART 15.407 REQUIREMENTS.....	13
7.1 DUTY CYCLE MEASUREMENT	13
7.2 6dB BANDWIDTH.....	14
7.3 MAXIMUM CONDUCTED OUTPUT POWER.....	27
7.4 PEAK POWER SPECTRAL DENSITY	32
7.5 RADIATED EMISSION	61
7.6 CONDUCTED EMISSION.....	103
7.7 FREQUENCY STABILITY.....	108
8. APPENDIX II SETUP PHOTOS.....	111

1. TEST REPORT CERTIFICATION

Applicant : NETIS SYSTEMS CO., LTD
Address : 4F & 5F, R&D Building, Oriental Cyberport, High-Tech Industrial Park, Nanshan, Shenzhen, China
Equipment Under Test : AC1200 Wireless Dual Band VDSL2 Gigabit VoIP IAD
Model : DL4480V
Trade Name : netis
Tested Date : May 04 ~ July 06, 2016

APPLICABLE STANDARD	
Standard	Test Result
FCC Part 15 Subpart E AND ANSI C63.10:2013	PASS

WE HEREBY CERTIFY THAT: The above equipment has been tested by Compliance Certification Services Inc., and found compliance with the requirements set forth in the technical standards mentioned above. The results of testing in this report apply only to the product/system, which was tested. Other similar equipment will not necessarily produce the same results due to production tolerance and measurement uncertainties.

Approved by:



Sb. Lu
Sr. Engineer

Reviewed by:



Gundan Lin
Sr. Engineer

2. EUT DESCRIPTION

Product Name	AC1200 Wireless Dual Band VDSL2 Gigabit VoIP IAD
Model Number	DL4480V
Identify Number	T160504D02
Received Date	May 04, 2016
Frequency Range	UNII Band 1: IEEE 802.11a, 802.11ac VHT20 Mode: 5180 MHz ~ 5240 MHz IEEE 802.11ac VHT40 Mode: 5190 MHz ~ 5230 MHz IEEE 802.11ac VHT80 Mode: 5210 MHz UNII Band 3: IEEE 802.11a, 802.11ac VHT20 Mode: 5745 MHz ~ 5825 MHz IEEE 802.11ac VHT40 Mode: 5755 MHz ~ 5795 MHz IEEE 802.11ac VHT80 Mode: 5775 MHz
Transmit Power	UNII Band 1: IEEE 802.11a Mode: 23.20 dBm (0.2089 W) IEEE 802.11ac VHT20 NSS1/MCS0 Mode: 25.11 dBm (0.3243 W) IEEE 802.11ac VHT40 NSS1/MCS0 Mode: 24.82 dBm (0.3034 W) IEEE 802.11ac VHT80 NSS1/MCS0 Mode: 22.96 dBm (0.1977 W) UNII Band 3: IEEE 802.11a Mode: 23.87 dBm (0.2438 W) IEEE 802.11ac VHT20 NSS1/MCS0 Mode: 24.01 dBm (0.2518 W) IEEE 802.11ac VHT40 NSS1/MCS0 Mode: 23.10 dBm (0.2042 W) IEEE 802.11ac VHT80 NSS1/MCS0 Mode: 23.36 dBm (0.2168 W)
Channel Spacing	IEEE 802.11a, 802.11ac VHT20 Mode: 20MHz IEEE 802.11ac VHT40 Mode: 40MHz IEEE 802.11ac VHT80 Mode: 80MHz

Channel Number	IEEE 802.11a, 802.11ac VHT20 Mode: 5150MHz ~ 5250MHz: 4 Channels 5725MHz ~ 5850MHz: 5 Channels IEEE 802.11ac VHT40 Mode: 5150MHz ~ 5250MHz: 2 Channels 5725MHz ~ 5850MHz: 2 Channels IEEE 802.11ac VHT80 Mode: 5150MHz ~ 5250MHz: 1 Channels 5725MHz ~ 5850MHz: 1 Channels
Transmit Data Rate	IEEE 802.11a Mode: up to 54 Mbps IEEE 802.11ac VHT20 Mode (800ns GI): up to 156.00 Mbps IEEE 802.11ac VHT20 Mode (400ns GI): up to 173.40 Mbps IEEE 802.11ac VHT40 Mode (800ns GI): up to 360.00 Mbps IEEE 802.11ac VHT40 Mode (400ns GI): up to 400.00 Mbps IEEE 802.11ac VHT80 Mode (800ns GI): up to 780.00 Mbps IEEE 802.11ac VHT80 Mode (400ns GI): up to 866.60 Mbps
Type of Modulation	IEEE 802.11a Mode: OFDM (64QAM, 16QAM, QPSK, BPSK) IEEE 802.11ac VHT20/40/80 Mode: OFDM (256QAM, 64QAM, 16QAM, QPSK, BPSK)
Antenna Type	Chip Antenna × 2 : Ant. 1 (Chain A), Antenna Gain: 2 dBi Ant. 2 (Chain B), Antenna Gain: 2 dBi
Power Rating	12Vdc
Test Voltage	120Vac, 60Hz
DC Power Cable Type	Non-shielded cable, 1.5 m (Non-detachable)
I/O Port	USB Port × 2, RJ-11 Port × 3, RJ-45 Port × 5, Power Port × 1

Power Adapter:

No.	Manufacturer	Model No.	Power Input	Power Output
1	Ktec	KSASB0241200200 HU	100-240Vac, 50/60Hz, 0.6A	12Vdc, 2.0A

Remark:

1. The sample selected for test was engineering sample that approximated to production product and was provided by manufacturer.
2. For more details, please refer to the User's manual of the EUT.
3. This submittal(s) (test report) is intended for FCC ID: T58DL4480VR filing to comply with Section 15.207, 15.209 and 15.407 of the FCC Part 15, Subpart E Rules.

3. DESCRIPTION OF TEST MODES

The EUT (AC1200 Wireless Dual Band VDSL2 Gigabit VoIP IAD) is an 802.11ac transceiver.

For IEEE 802.11a, IEEE 802.11ac VHT20/VHT40/VHT80 Mode (2TX / 2RX):
Ant.1 (Chain A) and Ant.2 (Chain B) transmit/receive.

Conducted Emission / Radiated Emission Test (Below 1 GHz)

1. The following test modes were scanned during the preliminary test:

No.	Pre-Test Mode
1	TX Mode

2. After the preliminary scan, the following test mode was found to produce the highest emission level.

Final Test Mode		
Emission	Radiated Emission	Mode 1
	Radiated Emission	Mode 1

Remark: Then, the above highest emission mode of the configuration of the EUT and cable was chosen for all final test items.

Conducted / Radiated Emission Test (Above 1 GHz)

IEEE 802.11a, 802.11ac VHT20 Mode

The EUT had been tested under operating condition.

There are three channels have been tested as following:

UNII Band	Channel	Frequency (MHz)
Band 1	Low	5180
	Middle	5200
	High	5240
Band 3	Low	5745
	Middle	5785
	High	5825

IEEE 802.11a Mode: 1Mbps data rate (worst case) was chosen for full testing.

IEEE 802.11ac VHT20 NSS1/MCS0 Mode: 6.5Mbps data rate (worst case) was chosen for full testing.

IEEE 802.11ac VHT40 Mode:

The EUT had been tested under operating condition.

There are two or three channels have been tested as following:

UNII Band	Channel	Frequency (MHz)
Band 1	Low	5190
	High	5230
Band 3	Low	5755
	High	5795

IEEE 802.11ac VHT40 NSS1/MCS0 Mode: 13.5Mbps data rate (worst case) was chosen for full testing.

IEEE 802.11ac VHT80 Mode

The EUT had been tested under operating condition.

There are one channels have been tested as following:

UNII Band	Channel	Frequency (MHz)
Band 1	Low	5210
Band 3	Low	5775

IEEE 802.11ac VHT80 NSS1/MCS0 Mode: 29.3 Mbps data rate (worst case) was chosen for full testing.

4. TEST METHODOLOGY

The tests documented in this report were performed in accordance with ANSI C63.10:2013 and FCC CFR 47, 15.207, 15.209, 15. 407 and FCC 16-24.

5. FACILITIES AND ACCREDITATION

5.1 FACILITIES

All measurement facilities used to collect the measurement data are located at

No.989-1, Wenshan Rd., Shangshan Village,
Qionglin Township, Hsinchu County 30741, Taiwan (R.O.C.)

The sites are constructed in conformance with the requirements of ANSI C63.10:2013 and CISPR 22. All receiving equipment conforms to CISPR 16-1-1, CISPR 16-1-2, CISPR 16-1-3, CISPR 16-1-4, CISPR 16-1-5.

5.2 ACCREDITATIONS

Our laboratories are accredited and approved by the following approval agencies according to ISO/IEC 17025.

Taiwan	TAF
---------------	-----

The measuring facility of laboratories has been authorized or registered by the following approval agencies.

Canada	INDUSTRY CANADA
Japan	VCCI
Taiwan	BSMI
USA	FCC MRA

Copies of granted accreditation certificates are available for downloading from our web site, <http://www.ccsrf.com>

Remark: FCC Designation Number TW1027.

5.3 MEASUREMENT UNCERTAINTY

The following table is for the measurement uncertainty, which is calculated as per the document CISPR 16-4-2.

PARAMETER	UNCERTAINTY
Semi Anechoic Chamber (966 Chamber_C) / Radiated Emission, 30 to 1000 MHz	+/- 3.97
Semi Anechoic Chamber (966 Chamber_C) / Radiated Emission, 1 to 18GHz	+/- 3.58
Semi Anechoic Chamber (966 Chamber_C) / Radiated Emission, 18 to 26 GHz	+/- 3.59
Semi Anechoic Chamber (966 Chamber_C) / Radiated Emission, 26 to 40 GHz	+/- 3.81
Conducted Emission (Mains Terminals), 9kHz to 30MHz	+/- 2.48

This uncertainty represents an expanded uncertainty expressed at approximately the 95% confidence level using a coverage factor of k=2.

Consistent with industry standard (e.g. CISPR 22, clause 11, Measurement Uncertainty) determining compliance with the limits shall be base on the results of the compliance measurement. Consequently the measure emissions being less than the maximum allowed emission result in this be a compliant test or passing test.

The acceptable measurement uncertainty value without requiring revision of the compliance statement is base on conducted and radiated emissions being less than U_{CISPR} which is 3.6dB and 5.2dB respectively. CCS values (called U_{Lab} in CISPR 16-4-2) is less than U_{CISPR} as shown in the table above. Therefore, MU need not be considered for compliance.

6. SETUP OF EQUIPMENT UNDER TEST

SUPPORT EQUIPMENT

No.	Product	Manufacturer	Model No.	Serial No.
1	Notebook PC	HP	ProBook 4421s	CNF03242PJ

No.	Signal Cable Description
1	Non-shielded RJ-45 cable, 12m × 1

SETUP DIAGRAM FOR TESTS

EUT & peripherals setup diagram is shown in appendix setup photos.

EUT OPERATING CONDITION

1. EUT & peripherals setup diagram is shown in appendix setup photos.

2. TX Mode:

⇒ **Data Rate:** 1Mbps Bandwidth 20 (IEEE 802.11a Mode)

6.5Mbps Bandwidth 20 (IEEE 802.11ac VHT20 NSS1/MCS0 Mode)

13.5Mbps Bandwidth 40 (IEEE 802.11ac VHT40 NSS1/MCS0 Mode)

29.3 Mbps Bandwidth 80 (IEEE 802.11ac VHT80 NSS1/MCS0 Mode)

⇒ **Power control**

IEEE 802.11a Mode

UNII Band	Channel	Frequency (MHz)	Chain	Power Set
Band 1	Low	5180	A/B	56/56
	Middle	5200	A/B	53/55
	High	5240	A/B	53/55
Band 3	Low	5745	A/B	63/59
	Middle	5785	A/B	59/55
	High	5825	A/B	62/60

IEEE 802.11ac VHT20 NSS1/MCS0 Mode

UNII Band	Channel	Frequency (MHz)	Chain	Power Set
Band 1	Low	5180	A/B	59/59
	Middle	5200	A/B	61/63
	High	5240	A/B	58/60
Band 3	Low	5745	A/B	63/58
	Middle	5785	A/B	63/60
	High	5825	A/B	63/60

IEEE 802.11ac VHT40 NSS1/MCS0 Mode

UNII Band	Channel	Frequency (MHz)	Chain	Power Set
Band 1	Low	5190	A/B	55/56
	High	5230	A/B	60/62
Band 3	Low	5755	A/B	63/59
	High	5795	A/B	63/59

IEEE 802.11ac VHT80 NSS1/MCS0 Mode

UNII Band	Channel	Frequency (MHz)	Chain	Power Set
Band 1	Low	5210	A/B	53/55
Band 3	Low	5775	A/B	63/60

3. All of the functions are under run.
4. Start test.

7. FCC PART 15.407 REQUIREMENTS

7.1 DUTY CYCLE MEASUREMENT

Product Name	AC1200 Wireless Dual Band VDSL2 Gigabit VoIP IAD	Test By	Crystal Wu
Test Model	DL4480V	Test Date	2016/06/22
Test Mode	TX Mode	Temp. & Humidity	26°C, 57%

Mode	TX on (ms)	TX on + off (ms)	Duty Cycle (%)	Duty Factor (dB)	1/T Minimum VBW (kHz)
IEEE 802.11a	1.000	1.000	100.00%	0.00	0.010
IEEE 802.11ac VHT20	1.000	1.000	100.00%	0.00	0.010
IEEE 802.11ac VHT40	1.000	1.000	100.00%	0.00	0.010
IEEE 802.11ac VHT80	1.000	1.000	100.00%	0.00	0.010

7.2 6dB BANDWIDTH

LIMITS

According to § 15.407 (e), within the 5.725-5.85 GHz band, the minimum 6 dB bandwidth of U-NII devices shall be at least 500 kHz.

TEST EQUIPMENT

Name of Equipment	Manufacturer	Model	Serial Number	Calibration Due
EXA Signal Analyzer	Agilent	N9010A	MY52220817	03/15/2017
Test S/W	N/A			

Remark: Each piece of equipment is scheduled for calibration once a year.

TEST SETUP

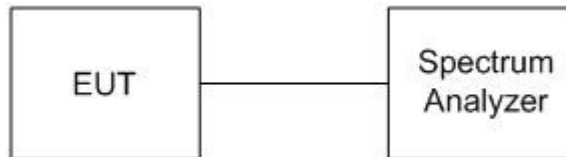

TEST PROCEDURE

1. Place the EUT on the table and set it in the transmitting mode.
2. Remove the antenna from the EUT and then connect a low loss RF cable from the antenna port to the spectrum analyzer.
3. Set the spectrum analyzer as RBW = 100kHz, VBW = 300kHz, Sweep = auto.
4. Mark the peak frequency and -6dB (upper and lower) frequency.
5. Repeat until all the rest channels are investigated.

TEST RESULTS

Product Name	AC1200 Wireless Dual Band VDSL2 Gigabit VoIP IAD	Test By	Crystal Wu
Test Model	DL4480V	Test Date	2016/06/24
Test Mode	TX Mode	Temp. & Humidity	20°C, 63%

IEEE 802.11a Mode (2TX)

U-NII Band	Channel	Channel Frequency (MHz)	6dB Bandwidth (MHz)		Minimum Limit (kHz)
			Chain A	Chain B	
Band 3	Low	5745	16.52	16.49	500
	Middle	5785	16.50	16.50	500
	High	5825	16.48	16.50	500

IEEE 802.11ac VHT20 NSS1/MCS0 Mode (2TX)

U-NII Band	Channel	Channel Frequency (MHz)	6dB Bandwidth (MHz)		Minimum Limit (kHz)
			Chain A	Chain B	
Band 3	Low	5745	17.71	17.74	500
	Middle	5785	17.71	17.76	500
	High	5825	17.73	17.77	500

IEEE 802.11ac VHT40 NSS1/MCS0 Mode (2TX)

U-NII Band	Channel	Channel Frequency (MHz)	6dB Bandwidth (MHz)		Minimum Limit (kHz)
			Chain A	Chain B	
Band 3	Low	5755	36.47	36.51	500
	High	5795	36.45	36.52	500

IEEE 802.11ac VHT80 NSS1/MCS0 Mode (2TX)

U-NII Band	Channel	Channel Frequency (MHz)	6dB Bandwidth (MHz)		Minimum Limit (kHz)
			Chain A	Chain B	
Band 3	Low	5775	75.52	76.29	500

6dB BANDWIDTH

CH Low (IEEE 802.11a Mode / Band 3 / Chain A)

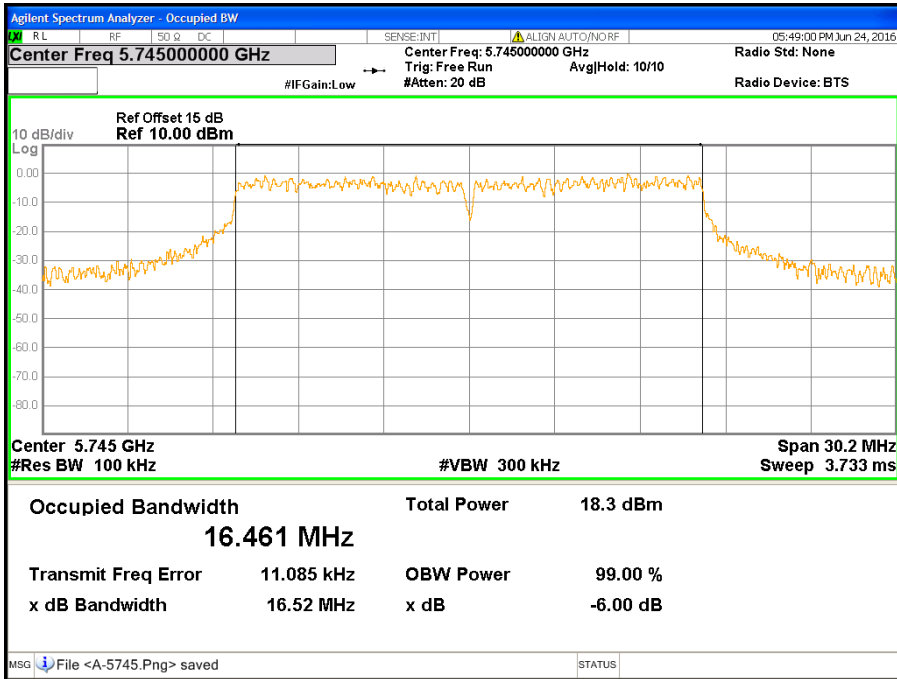

CH Middle (IEEE 802.11a Mode / Band 3 / Chain A)

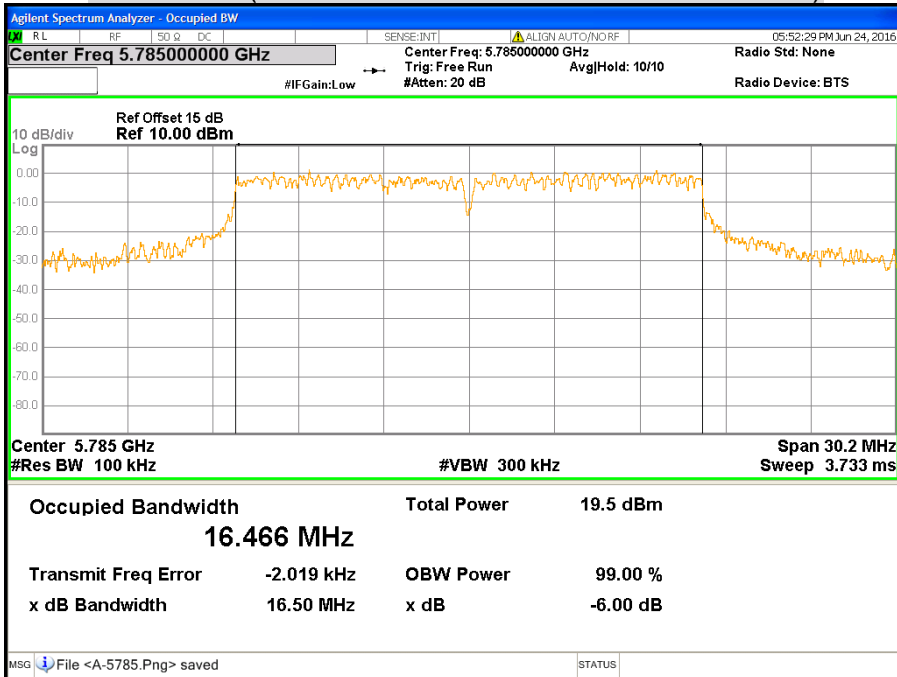

CH High (IEEE 802.11a Mode / Band 3 / Chain A)

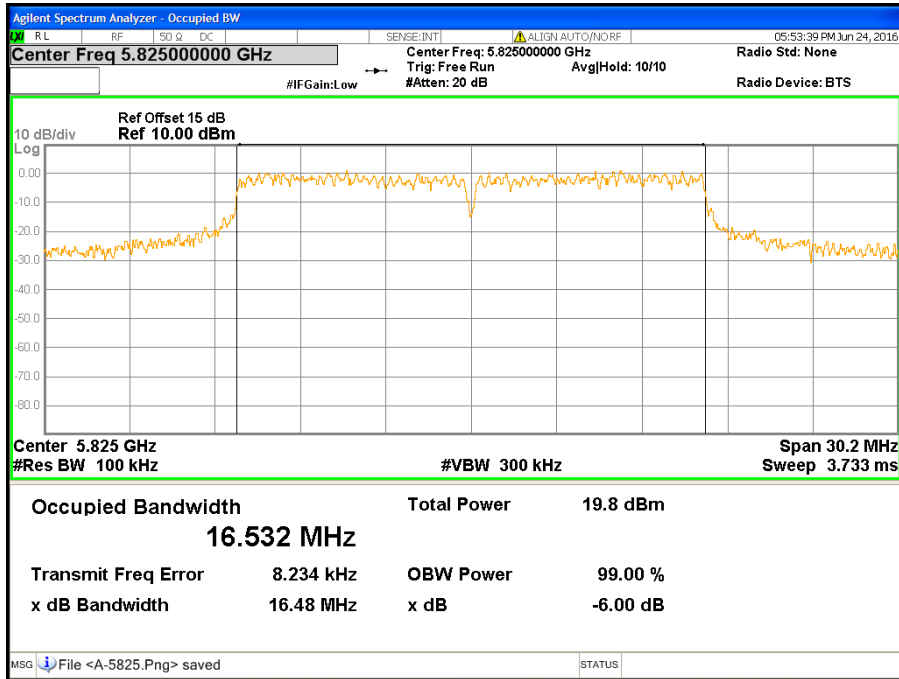

CH Low (IEEE 802.11a Mode / Band 3 / Chain B)

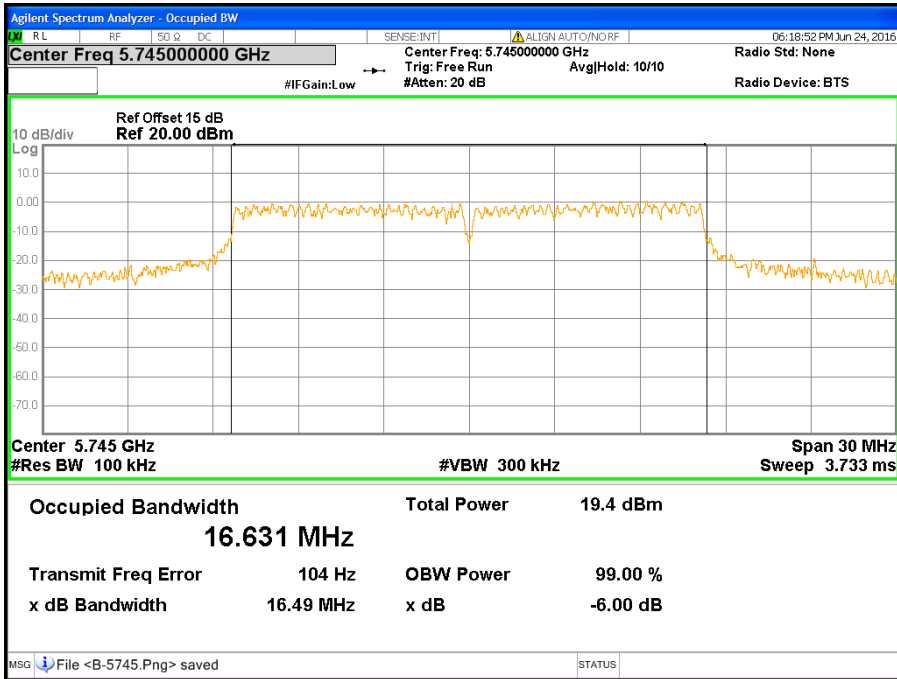

CH Middle (IEEE 802.11a Mode / Band 3 / Chain B)

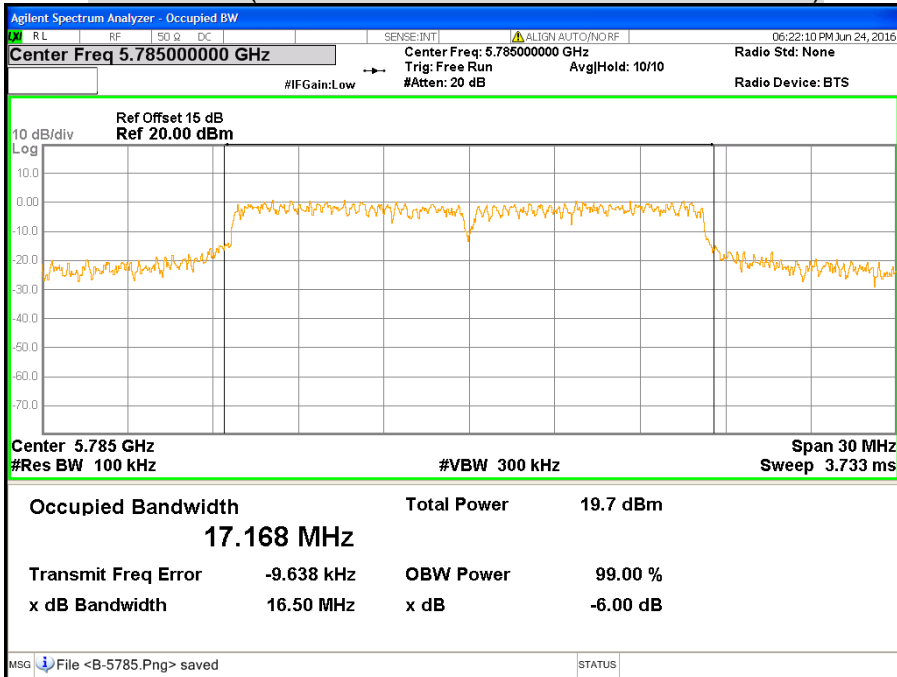

CH High (IEEE 802.11a Mode / Band 3 / Chain B)

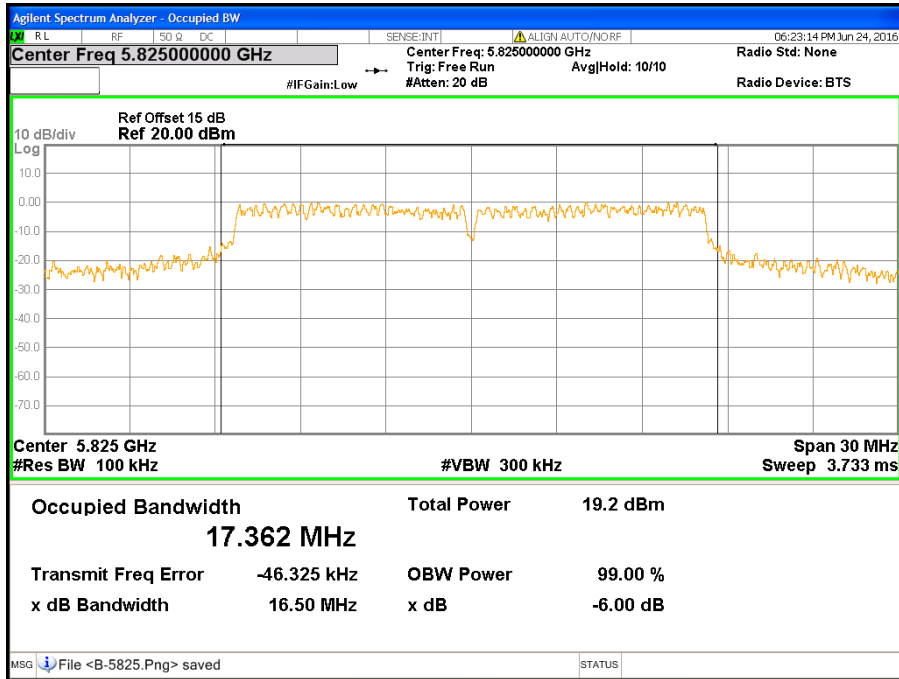

CH Low (IEEE 802.11ac VHT20 NSS1/MCS0 Mode / Band 3 / Chain A)

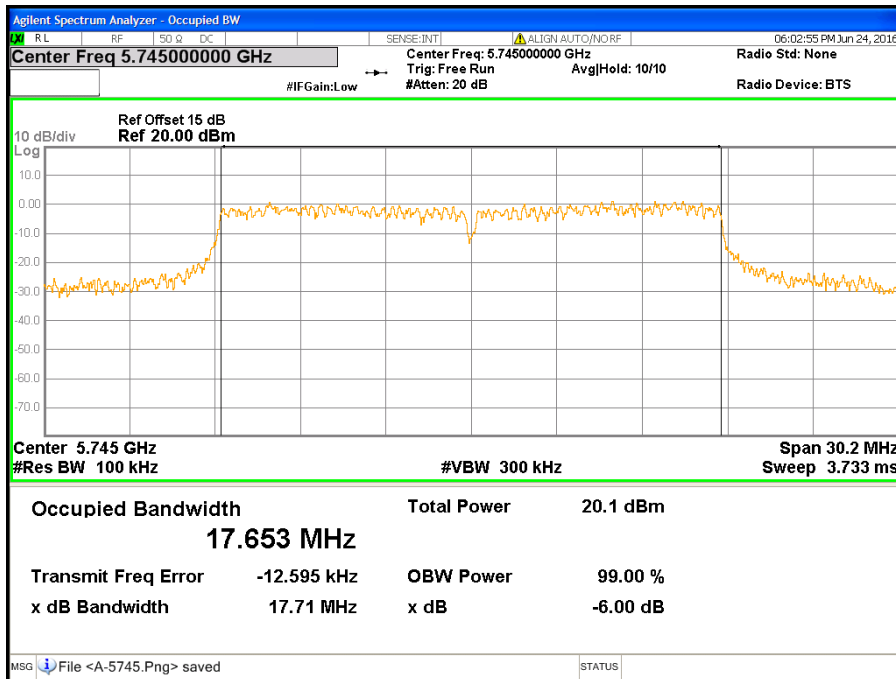

CH Middle (IEEE 802.11ac VHT20 NSS1/MCS0 Mode / Band 3 / Chain A)

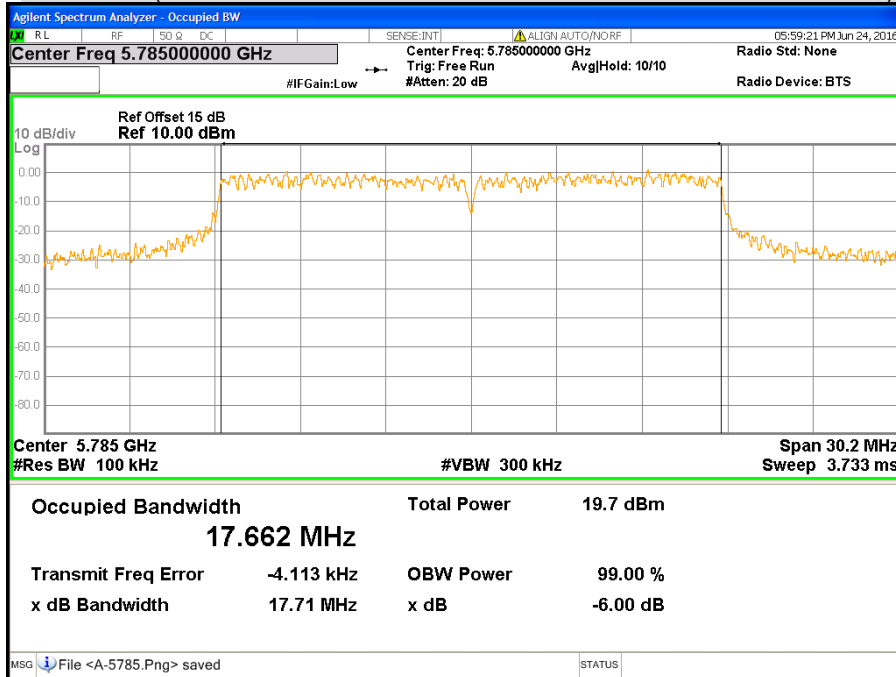

CH High (IEEE 802.11ac VHT20 NSS1/MCS0 Mode / Band 3 / Chain A)

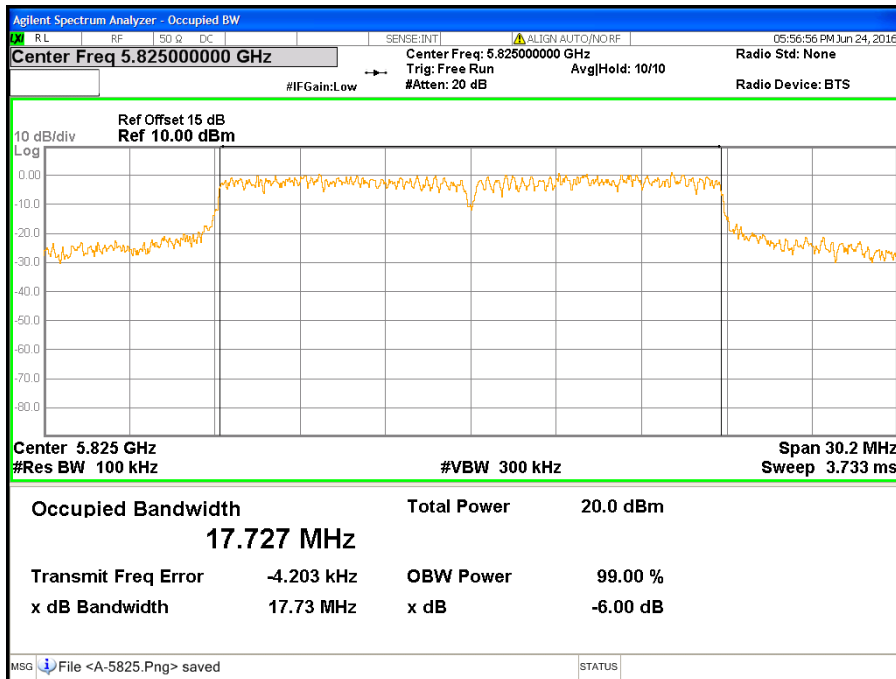

CH Low (IEEE 802.11ac VHT20 NSS1/MCS0 Mode / Band 3 / Chain B)

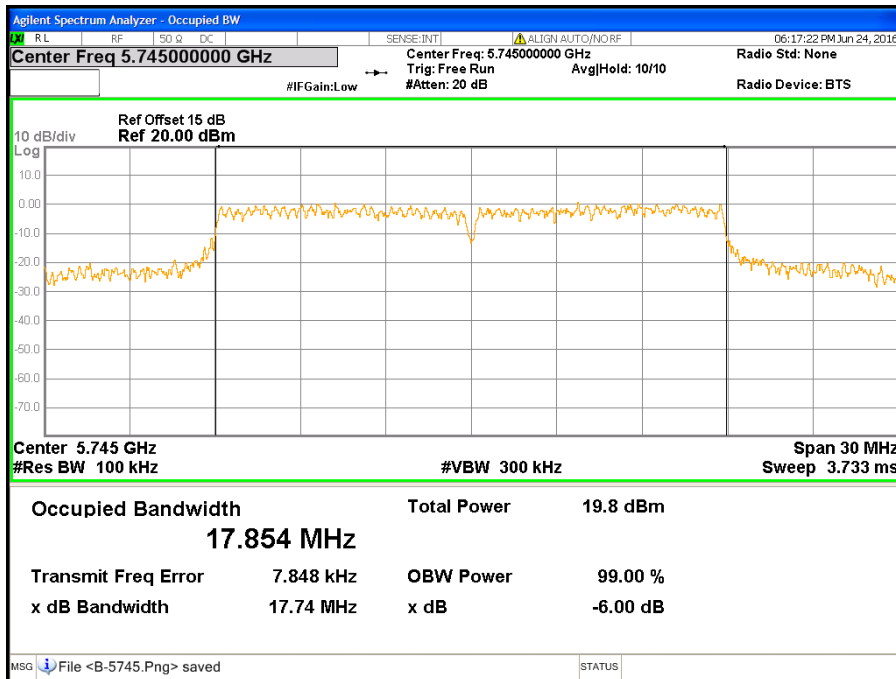

CH Middle (IEEE 802.11ac VHT20 NSS1/MCS0 Mode / Band 3 / Chain B)

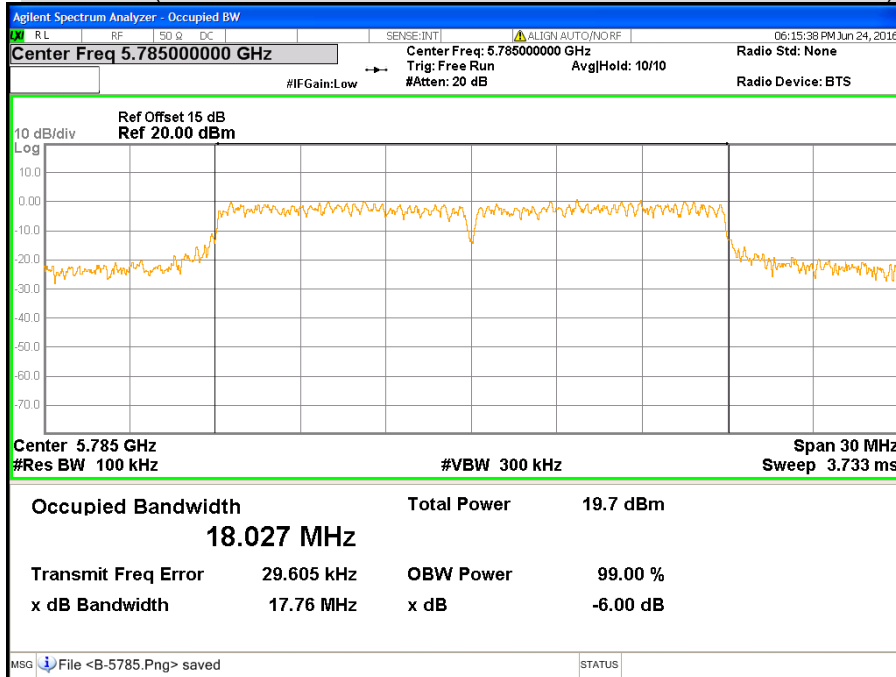

CH High (IEEE 802.11ac VHT20 NSS1/MCS0 Mode / Band 3 / Chain B)

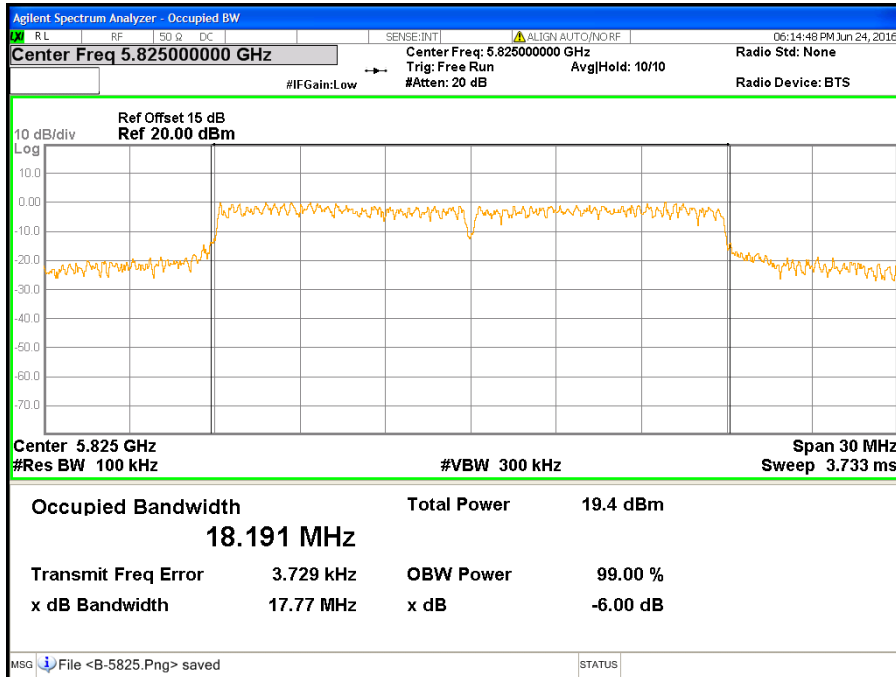

CH Low (IEEE 802.11ac VHT40 NSS1/MCS0 Mode / Band 3 / Chain A)

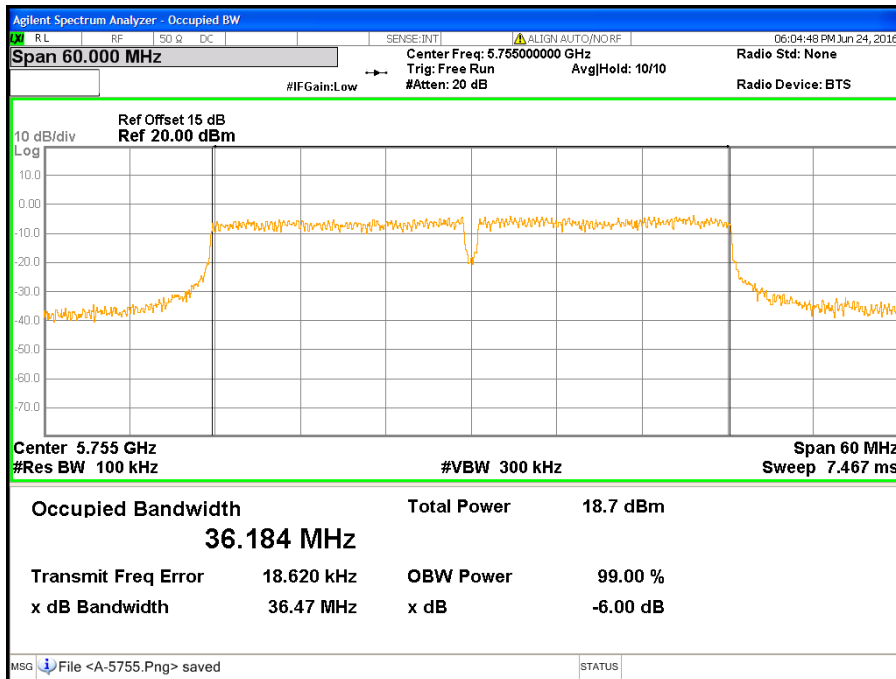

CH High (IEEE 802.11ac VHT40 NSS1/MCS0 Mode / Band 3 / Chain A)

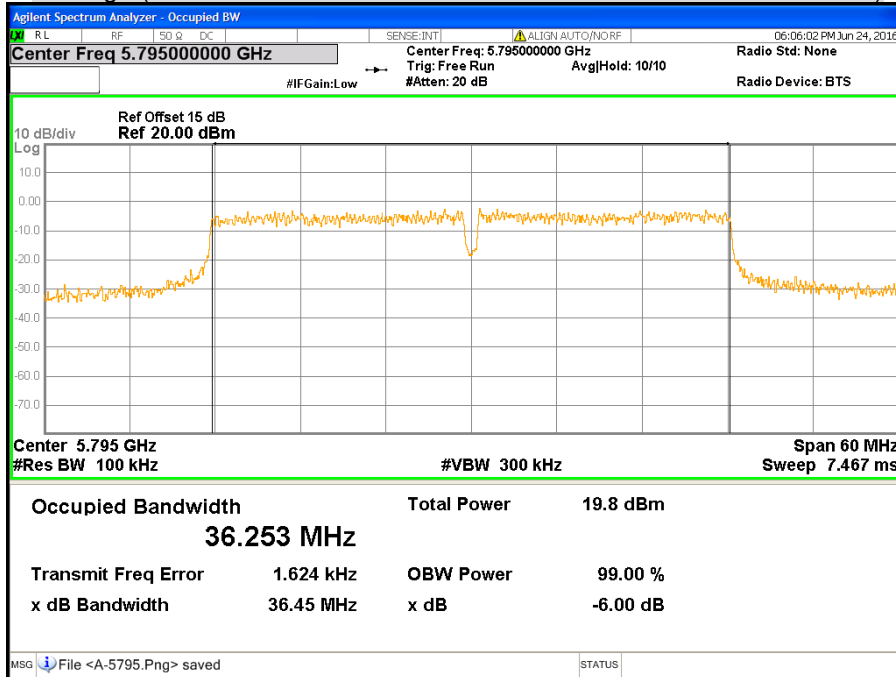

CH Low (IEEE 802.11ac VHT40 NSS1/MCS0 Mode / Band 3 / Chain B)

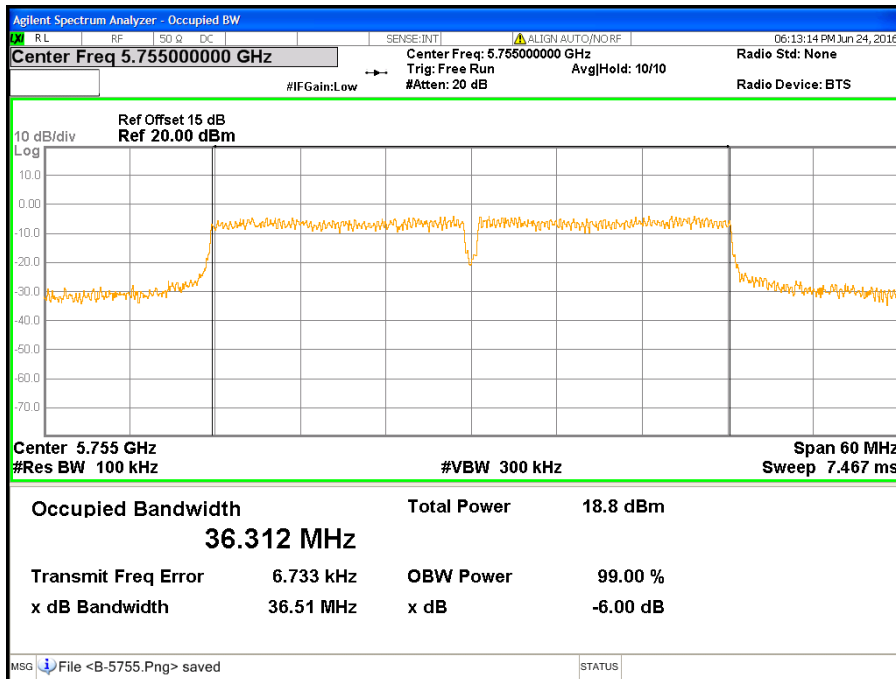

CH High (IEEE 802.11ac VHT40 NSS1/MCS0 Mode / Band 3 / Chain B)

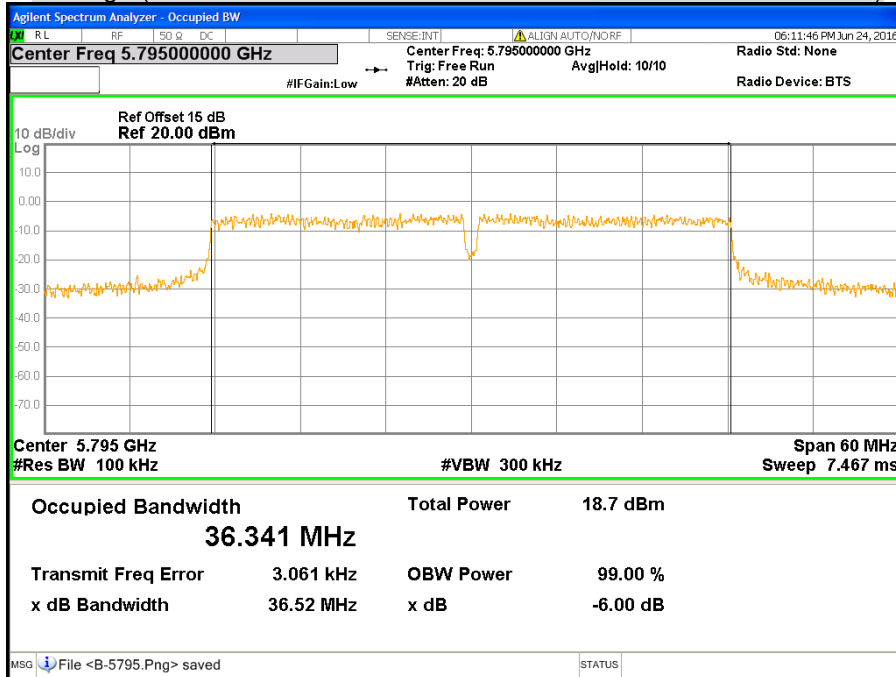

CH Low (IEEE 802.11ac VHT80 NSS1/MCS0 Mode / Band 3 / Chain A)

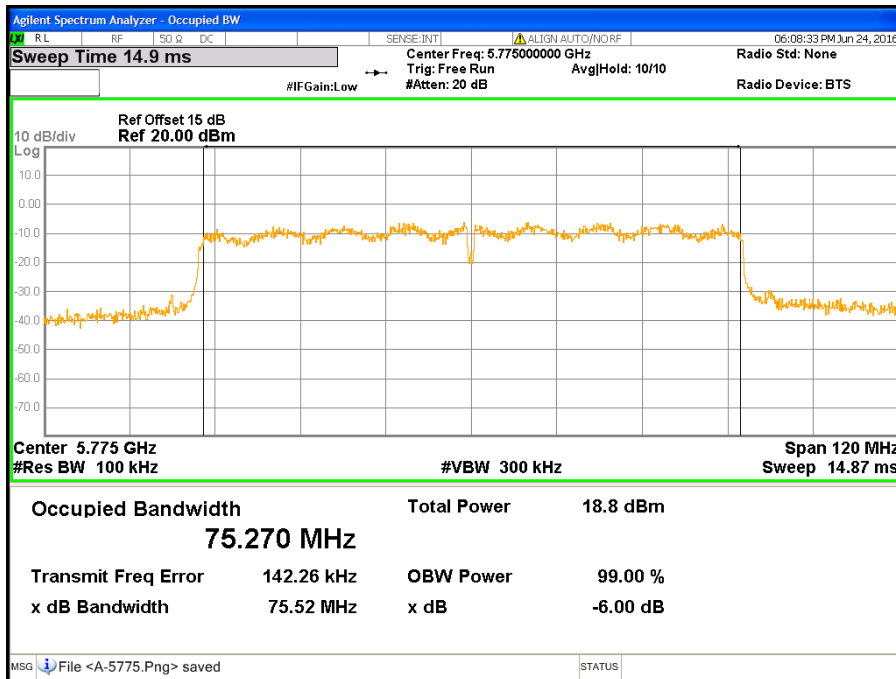

CH Low (IEEE 802.11ac VHT80 NSS1/MCS0 Mode / Band 3 / Chain B)

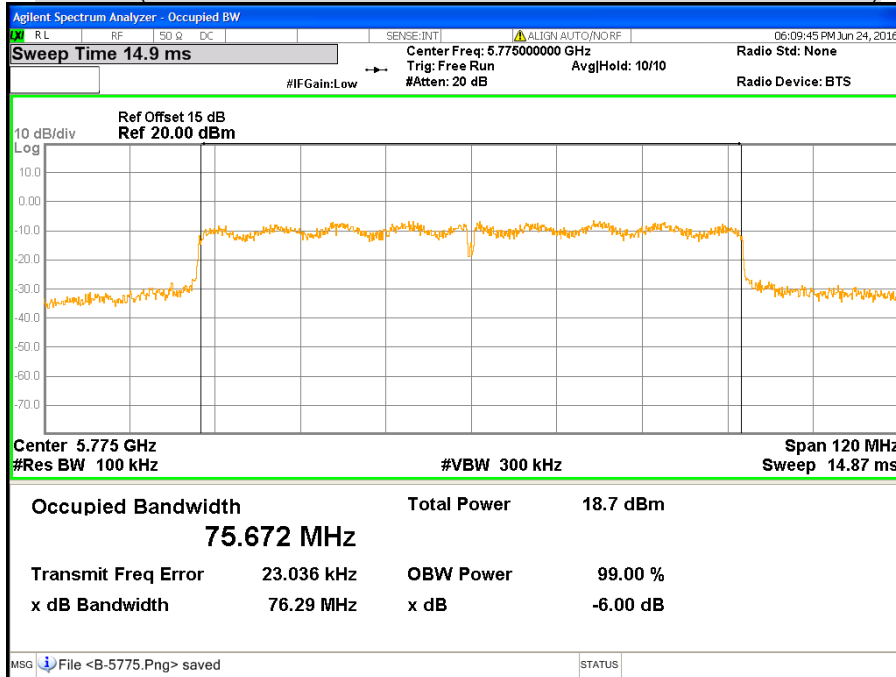

7.3 MAXIMUM CONDUCTED OUTPUT POWER

LIMITS

§ 15.407(a)

(1) For the band 5.15-5.25 GHz,

- (I) For an outdoor access point operating in the band 5.15-5.25 GHz, the maximum conducted output power over the frequency band of operation shall not exceed 1W provided the maximum antenna gain does not exceed 6 dBi. In addition, the maximum power spectral density shall not exceed 17 dBm in any 1 megahertz band. If transmitting antennas of directional gain greater than 6 dBi are used, both the maximum conducted output power and the maximum power spectral density shall be reduced by the amount in dB that the directional gain of the antenna exceeds 6 dBi. The maximum e.i.r.p. at any elevation angle above 30 degrees as measured from the horizon must not exceed 125 mW (21 dBm).
- (II) For an indoor access point operating in the band 5.15-5.25 GHz, the maximum conducted output power over the frequency band of operation shall not exceed 1W provided the maximum antenna gain does not exceed 6 dBi. In addition, the maximum power spectral density shall not exceed 17dBm in any 1 megahertz band. If transmitting antennas of directional gain greater than 6dBi are used, both the maximum conducted output power and the maximum power spectral density shall be reduced by the amount in dB that the directional gain of the antenna exceeds 6dBi.
- (III) For fixed point-to-point access points operating in the band 5.15-5.25 GHz, the maximum conducted output power over the frequency band of operation shall not exceed 1 W. Fixed point-to-point U-NII devices may employ antennas with directional gain up to 23 dBi without any corresponding reduction in the maximum conducted output power or maximum power spectral density. For fixed point-to-point transmitters that employ a directional antenna gain greater than 23 dBi, a 1 dB reduction in maximum conducted output power and maximum power spectral density is required for each 1 dB of antenna gain in excess of 23 dBi. Fixed, point-to-point operations exclude the use of point-to-multipoint systems, omnidirectional applications, and multiple collocated transmitters transmitting the same information. The operator of the U-NII device, or if the equipment is professionally installed, the installer, is responsible for ensuring that systems employing high gain directional antennas are used exclusively for fixed, point-to-point operations.

- (IV) For mobile and portable client devices in the 5.15-5.25 GHz band, the maximum conducted output power over the frequency band of operation shall not exceed 250 mW provided the maximum antenna gain does not exceed 6 dBi. In addition, the maximum power spectral density shall not exceed 11 dBm in any 1 megahertz band. If transmitting antennas of directional gain greater than 6 dBi are used, both the maximum conducted output power and the maximum power spectral density shall be reduced by the amount in dB that the directional gain of the antenna exceeds 6 dBi.
- (2) For the 5.25-5.35 GHz and 5.47-5.725 GHz bands, the maximum conducted output power over the frequency bands of operation shall not exceed the lesser of 250 mW or $11 \text{ dBm} + 10 \log B$, where B is the 26 dB emission bandwidth in megahertz. In addition, the maximum power spectral density shall not exceed 11 dBm in any 1 megahertz band. If transmitting antennas of directional gain greater than 6 dBi are used, both the maximum conducted output power and the maximum power spectral density shall be reduced by the amount in dB that the directional gain of the antenna exceeds 6 dBi.
- (3) For the band 5.725-5.85 GHz, the maximum conducted output power over the frequency band of operation shall not exceed 1 W. In addition, the maximum power spectral density shall not exceed 30 dBm in any 500-kHz band. If transmitting antennas of directional gain greater than 6 dBi are used, both the maximum conducted output power and the maximum power spectral density shall be reduced by the amount in dB that the directional gain of the antenna exceeds 6 dBi. However, fixed point-to-point U-NII devices operating in this band may employ transmitting antennas with directional gain greater than 6 dBi without any corresponding reduction in transmitter conducted power. Fixed, point-to-point operations exclude the use of point-to-multipoint systems, omnidirectional applications, and multiple collocated transmitters transmitting the same information. The operator of the U-NII device, or if the equipment is professionally installed, the installer, is responsible for ensuring that systems employing high gain directional antennas are used exclusively for fixed, point-to-point operations.

§ KDB 662911:

If all antennas have the same gain, G_{ANT} , Directional gain = G_{ANT} + Array Gain, where Array Gain is as follows.

Array Gain = 0 dB (i.e., no array gain) for $N_{ANT} \leq 4$;

Array Gain = 0 dB (i.e., no array gain) for channel widths ≥ 40 MHz for any N_{ANT} ;

Array Gain = $5 \log(N_{ANT}/N_{SS})$ dB or 3 dB, whichever is less for 20-MHz channel widths with $N_{ANT} \geq 5$.

If antenna gains are not equal, the user may use either of the following methods to calculate directional gain, provided that each transmit antenna is driven by only one spatial stream:

Directional gain may be calculated by using the formulas applicable to equal gain antennas with G_{ANT} set equal to the gain of the antenna having the highest gain; or,

$$DirectionalGain = 10 \cdot \log \left[\frac{\sum_{j=1}^{N_{SS}} \left\{ \sum_{k=1}^{N_{ANT}} g_{j,k} \right\}^2}{N_{ANT}} \right]$$

TEST EQUIPMENT

Name of Equipment	Manufacturer	Model	Serial Number	Calibration Due
Power Meter	Anritsu	ML2495A	1149001	12/08/2016
Power Sensor	Anritsu	MA2411B	1126148	12/08/2016
Test S/W	N/A			

Remark: Each piece of equipment is scheduled for calibration once a year.

TEST SETUP

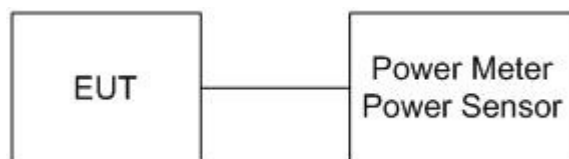

TEST PROCEDURE

The transmitter output is connected to the power meter. The power meter is set to the power detection.

TEST RESULTS

Product Name	AC1200 Wireless Dual Band VDSL2 Gigabit VoIP IAD	Test By	Crystal Wu
Test Model	DL4480V	Test Date	2016/06/24
Test Mode	TX Mode	Temp. & Humidity	20°C, 63%

IEEE 802.11a Mode (2TX)

UNII Band	Channel	Channel Frequency (MHz)	Conducted Output Power						Result
			Chain A	Chain B	Total		Limit		
			(dBm)	(dBm)	(dBm)	(W)	(dBm)	(W)	
Band 1	Low	5180	20.28	19.84	23.08	0.2032	30	1.000	PASS
	Middle	5200	19.65	19.75	22.71	0.1866	30	1.000	PASS
	High	5240	20.05	20.32	23.20	0.2089	30	1.000	PASS
Band 3	Low	5745	20.88	20.83	23.87	0.2438	30	1.000	PASS
	Middle	5785	20.56	20.66	23.62	0.2301	30	1.000	PASS
	High	5825	20.61	20.58	23.61	0.2296	30	1.000	PASS

Remark:

1. At final test to get the worst-case emission at 1Mbps.
2. The cable assembly insertion loss of 15 dB (including 14 dB pad and 1 dB cable) was entered as an offset in the power meter to allow for direct reading of power.
3. Total output power = Chain A + Chain B.
4. The maximum antenna gain is 2 dBi which is less than 6dBi, the limit should be 30 dBm.

IEEE 802.11ac VHT20 NSS1/MCS0 Mode (2TX)

UNII Band	Channel	Channel Frequency (MHz)	Conducted Output Power						Result
			Chain A	Chain B	Total		Limit		
			(dBm)	(dBm)	(dBm)	(W)	(dBm)	(W)	
Band 1	Low	5180	21.16	21.48	24.33	0.2710	30	1.000	PASS
	Middle	5200	22.02	22.17	25.11	0.3243	30	1.000	PASS
	High	5240	21.66	21.65	24.67	0.2931	30	1.000	PASS
Band 3	Low	5745	20.01	20.43	23.24	0.2109	30	1.000	PASS
	Middle	5785	21.06	20.93	24.01	0.2518	30	1.000	PASS
	High	5825	20.96	20.66	23.82	0.2410	30	1.000	PASS

Remark:

1. At final test to get the worst-case emission at 6.5Mbps.
2. The cable assembly insertion loss of 15 dB (including 14 dB pad and 1 dB cable) was entered as an offset in the power meter to allow for direct reading of power.
3. Total output power = Chain A + Chain B.
4. The maximum antenna gain is 2 dBi which is less than 6dBi, the limit should be 30 dBm.

IEEE 802.11ac VHT40 NSS1/MCS0 Mode (2TX)

UNII Band	Channel	Channel Frequency (MHz)	Conducted Output Power						Result
			Chain A	Chain B	Total		Limit		
			(dBm)	(dBm)	(dBm)	(W)	(dBm)	(W)	
Band 1	Low	5190	20.83	20.75	23.80	0.2399	30	1.000	PASS
	High	5230	21.72	21.89	24.82	0.3034	30	1.000	PASS
Band 3	Low	5755	19.89	20.21	23.06	0.2023	30	1.000	PASS
	High	5795	20.24	19.94	23.10	0.2042	30	1.000	PASS

Remark:

1. At final test to get the worst-case emission at 13.5Mbps.
2. The cable assembly insertion loss of 15 dB (including 14 dB pad and 1 dB cable) was entered as an offset in the power meter to allow for direct reading of power.
3. Total output power = Chain A + Chain B.
4. The maximum antenna gain is 2 dBi which is less than 6dBi, the limit should be 30 dBm.

IEEE 802.11ac VHT80 NSS1/MCS0 Mode (2TX)

UNII Band	Channel	Channel Frequency (MHz)	Conducted Output Power						Result
			Chain A	Chain B	Total		Limit		
			(dBm)	(dBm)	(dBm)	(W)	(dBm)	(W)	
Band 1	Low	5210	19.94	19.96	22.96	0.1977	30	1.000	PASS
Band 3	Low	5775	20.27	20.42	23.36	0.2168	30	1.000	PASS

Remark:

1. At final test to get the worst-case emission at 29.3 Mbps.
2. The cable assembly insertion loss of 15 dB (including 14 dB pad and 1 dB cable) was entered as an offset in the power meter to allow for direct reading of power.
3. Total output power = Chain A + Chain B.
4. The maximum antenna gain is 2 dBi which is less than 6dBi, the limit should be 30 dBm.

7.4 PEAK POWER SPECTRAL DENSITY

LIMITS

§ 15.407 (a)

(1) For the band 5.15-5.25 GHz

- (I) For an outdoor access point operating in the band 5.15-5.25 GHz, the maximum conducted output power over the frequency band of operation shall not exceed 1 W provided the maximum antenna gain does not exceed 6 dBi. In addition, the maximum power spectral density shall not exceed 17 dBm in any 1 megahertz band. If transmitting antennas of directional gain greater than 6 dBi are used, both the maximum conducted output power and the maximum power spectral density shall be reduced by the amount in dB that the directional gain of the antenna exceeds 6dBi. The maximum e.i.r.p. at any elevation angle above 30 degrees as measured from the horizon must not exceed 125 mW (21 dBm).
- (II) For an indoor access point operating in the band 5.15-5.25 GHz, the maximum conducted output power over the frequency band of operation shall not exceed 1 W provided the maximum antenna gain does not exceed 6 dBi. In addition, the maximum power spectral density shall not exceed 17 dBm in any 1 megahertz band. If transmitting antennas of directional gain greater than 6 dBi are used, both the maximum conducted output power and the maximum power spectral density shall be reduced by the amount in dB that the directional gain of the antenna exceeds 6dBi.
- (III) For mobile and portable client devices in the 5.15-5.25 GHz band, the maximum conducted output power over the frequency band of operation shall not exceed 250 mW provided the maximum antenna gain does not exceed 6 dBi. In addition, the maximum power spectral density shall not exceed 11 dBm in any 1 megahertz band. If transmitting antennas of directional gain greater than 6 dBi are used, both the maximum conducted output power and the maximum power spectral density shall be reduced by the amount in dB that the directional gain of the antenna exceeds 6dBi.

- (2) For the 5.25-5.35 GHz and 5.47-5.725 GHz bands, the maximum conducted output power over the frequency bands of operation shall not exceed the lesser of 250 mW or 11 dBm $10 \log B$, where B is the 26 dB emission bandwidth in megahertz. In addition, the maximum power spectral density shall not exceed 11 dBm in any 1 megahertz band. If transmitting antennas of directional gain greater than 6 dBi are used, both the maximum conducted output power and the maximum power spectral density shall be reduced by the amount in dB that the directional gain of the antenna exceeds 6 dBi.
- (3) For the band 5.725-5.85 GHz, the maximum conducted output power over the frequency band of operation shall not exceed 1 W. In addition, the maximum power spectral density shall not exceed 30 dBm in any 500-kHz band. If transmitting antennas of directional gain greater than 6 dBi are used, both the maximum conducted output power and the maximum power spectral density shall be reduced by the amount in dB that the directional gain of the antenna exceeds 6 dBi. However, fixed point-to-point U-NII devices operating in this band may employ transmitting antennas with directional gain greater than 6 dBi without any corresponding reduction in transmitter conducted power. Fixed, point-to-point operations exclude the use of point-to-multipoint systems, omnidirectional applications, and multiple collocated transmitters transmitting the same information. The operator of the U-NII device, or if the equipment is professionally installed, the installer, is responsible for ensuring that systems employing high gain directional antennas are used exclusively for fixed, point-to-point operations.

§ KDB 662911:

If all antennas have the same gain, G_{ANT} , Directional gain = $G_{ANT} + \text{Array Gain}$, where Array Gain is as follows.

$$\text{Array Gain} = 10 \log(N_{ANT}/N_{SS}) \text{ dB.}$$

If antenna gains are not equal, the user may use either of the following methods to calculate directional gain, provided that each transmit antenna is driven by only one spatial stream:

Directional gain may be calculated by using the formulas applicable to equal gain antennas with G_{ANT} set equal to the gain of the antenna having the highest gain; or,

$$\text{Directional Gain} = 10 \cdot \log \left[\frac{\sum_{j=1}^{N_{SS}} \left\{ \sum_{k=1}^{N_{ANT}} g_{j,k} \right\}^2}{N_{ANT}} \right]$$

TEST EQUIPMENT

Name of Equipment	Manufacturer	Model	Serial Number	Calibration Due
EXA Signal Analyzer	Agilent	N9010A	MY52220817	03/15/2017
Test S/W	N/A			

Remark: Each piece of equipment is scheduled for calibration once a year.

TEST SETUP



TEST PROCEDURE

1. Place the EUT on the table and set it in transmitting mode.
Remove the antenna from the EUT and then connect a low loss RF cable from the antenna port to the spectrum analyzer.
2. Set the spectrum analyzer as RBW = 1MHz, VBW = 3MHz, Span = Sweep= AUTO
3. Record the max. reading.
4. Repeat the above procedure until the measurements for all frequencies are completed.

TEST RESULTS

Product Name	AC1200 Wireless Dual Band VDSL2 Gigabit VoIP IAD	Test By	Crystal Wu
Test Model	DL4480V	Test Date	2016/06/28
Test Mode	TX Mode	Temp. & Humidity	20°C, 63%

IEEE 802.11a Mode

U-NII Band	Channel	Channel Frequency (MHz)	Peak Power Spectral Density (dBm/MHz)				Result
			Chain A	Chain B	Total	Limit	
Band 1	Low	5180	8.907	9.083	12.01	17	PASS
	Middle	5200	7.918	8.751	11.36	17	PASS
	High	5240	8.594	9.085	11.86	17	PASS

Remark:

1. At final test to get the worst-case emission at 1Mbps.
2. The cable assembly insertion loss of 15 dB (including 14 dB pad and 1 dB cable) was entered as an offset in the spectrum analyzer to allow for direct reading of power.
3. Total output power = Chain A + Chain B.
4. The directional gain is 5.01 dBi which is less than 6dBi, the limit should be 17 dBm.

U-NII Band	Channel	Channel Frequency (MHz)	Peak Power Spectral Density (dBm/500kHz)				Result
			Chain A	Chain B	Total	Limit	
Band 3	Low	5745	8.544	8.672	11.62	30	PASS
	Middle	5785	8.877	9.317	12.11	30	PASS
	High	5825	9.103	8.814	11.97	30	PASS

Remark:

1. At final test to get the worst-case emission at 1Mbps.
2. The cable assembly insertion loss of 15 dB (including 14 dB pad and 1 dB cable) was entered as an offset in the spectrum analyzer to allow for direct reading of power.
3. Total output power = Chain A + Chain B.
4. The directional gain is 5.01 dBi which is less than 6dBi, the limit should be 30 dBm.

IEEE 802.11ac VHT20 NSS1/MCS0 Mode (2TX)

U-NII Band	Channel	Channel Frequency (MHz)	Peak Power Spectral Density (dBm/MHz)				Result
			Chain A	Chain B	Total	Limit	
Band 1	Low	5180	10.231	10.593	13.43	17	PASS
	Middle	5200	10.745	10.474	13.62	17	PASS
	High	5240	9.873	10.144	13.02	17	PASS

Remark:

1. At final test to get the worst-case emission at 6.5Mbps.
2. The cable assembly insertion loss of 15 dB (including 14 dB pad and 1 dB cable) was entered as an offset in the spectrum analyzer to allow for direct reading of power.
3. Total power spectral density = Chain A + Chain B.
4. The directional gain is 5.01 dBi which is less than 6dBi, the limit should be 17 dBm.

U-NII Band	Channel	Channel Frequency (MHz)	Peak Power Spectral Density (dBm/500kHz)				Result
			Chain A	Chain B	Total	Limit	
Band 3	Low	5745	8.065	8.379	11.24	30	PASS
	Middle	5785	8.888	8.885	11.90	30	PASS
	High	5825	8.800	8.417	11.62	30	PASS

Remark:

1. At final test to get the worst-case emission at 6.5Mbps.
2. The cable assembly insertion loss of 15 dB (including 14 dB pad and 1 dB cable) was entered as an offset in the spectrum analyzer to allow for direct reading of power.
3. Total power spectral density = Chain A + Chain B.
4. The directional gain is 5.01 dBi which is less than 6dBi, the limit should be 30 dBm.

IEEE 802.11ac VHT40 NSS1/MCS0 Mode (2TX)

U-NII Band	Channel	Channel Frequency (MHz)	Peak Power Spectral Density (dBm/MHz)				Result
			Chain A	Chain B	Total	Limit	
Band 1	Low	5190	6.465	6.441	9.46	17	PASS
	High	5230	7.215	7.398	10.32	17	PASS

Remark:

1. At final test to get the worst-case emission at 13.5Mbps.
2. The cable assembly insertion loss of 15 dB (including 14 dB pad and 1 dB cable) was entered as an offset in the spectrum analyzer to allow for direct reading of power.
3. Total power spectral density = Chain A + Chain B.
4. The directional gain is 5.01 dBi which is less than 6dBi, the limit should be 17 dBm.

U-NII Band	Channel	Channel Frequency (MHz)	Peak Power Spectral Density (dBm/500kHz)				Result
			Chain A	Chain B	Total	Limit	
Band 3	Low	5755	5.239	5.100	8.18	30	PASS
	High	5795	6.499	5.640	9.10	30	PASS

Remark:

1. At final test to get the worst-case emission at 13.5Mbps.
2. The cable assembly insertion loss of 15 dB (including 14 dB pad and 1 dB cable) was entered as an offset in the spectrum analyzer to allow for direct reading of power.
3. Total power spectral density = Chain A + Chain B.
4. The directional gain is 5.01 dBi which is less than 6dBi, the limit should be 30 dBm.

IEEE 802.11ac VHT80 NSS1/MCS0 Mode (2TX)

U-NII Band	Channel	Channel Frequency (MHz)	Peak Power Spectral Density (dBm/MHz)				Result
			Chain A	Chain B	Total	Limit	
Band 1	Low	5210	5.497	5.281	8.40	17	PASS

Remark:

1. At final test to get the worst-case emission at 29.3 Mbps.
2. The cable assembly insertion loss of 15 dB (including 14 dB pad and 1 dB cable) was entered as an offset in the spectrum analyzer to allow for direct reading of power.
3. Total power spectral density = Chain A + Chain B.
4. The directional gain is 5.01 dBi which is less than 6dBi, the limit should be 17 dBm.

U-NII Band	Channel	Channel Frequency (MHz)	Peak Power Spectral Density (dBm/500kHz)				Result
			Chain A	Chain B	Total	Limit	
Band 3	Low	5775	4.040	3.969	7.01	30	PASS

Remark:

1. At final test to get the worst-case emission at 29.3 Mbps.
2. The cable assembly insertion loss of 15 dB (including 14 dB pad and 1 dB cable) was entered as an offset in the spectrum analyzer to allow for direct reading of power.
3. Total power spectral density = Chain A + Chain B.
4. The directional gain is 5.01 dBi which is less than 6dBi, the limit should be 30 dBm.

POWER SPECTRAL DENSITY

CH Low (IEEE 802.11a Mode / Band 1 / Chain A)

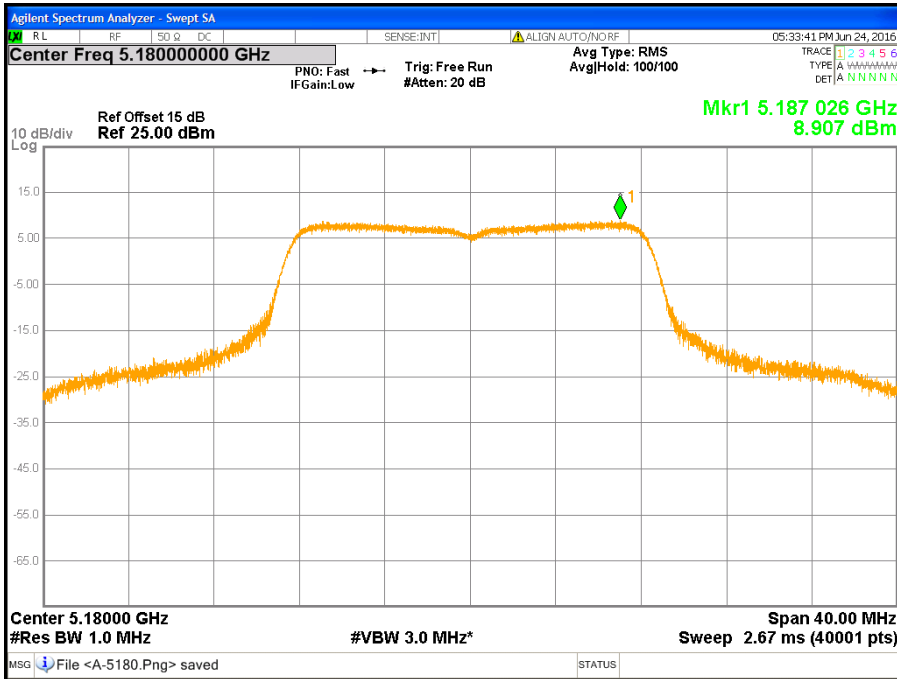

CH Middle (IEEE 802.11a Mode / Band 1 / Chain A)

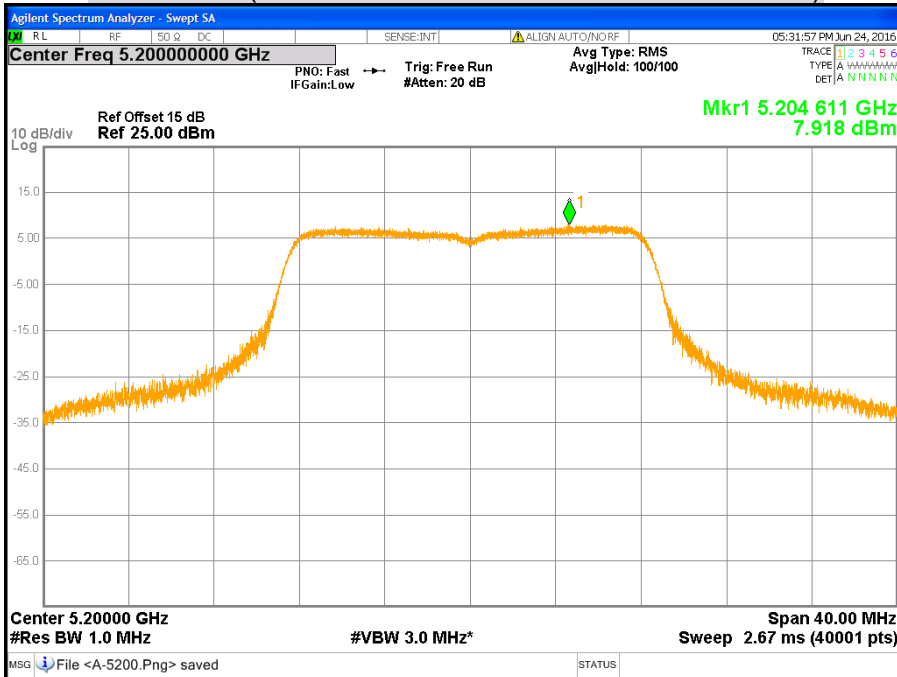

CH High (IEEE 802.11a Mode / Band 1 / Chain A)

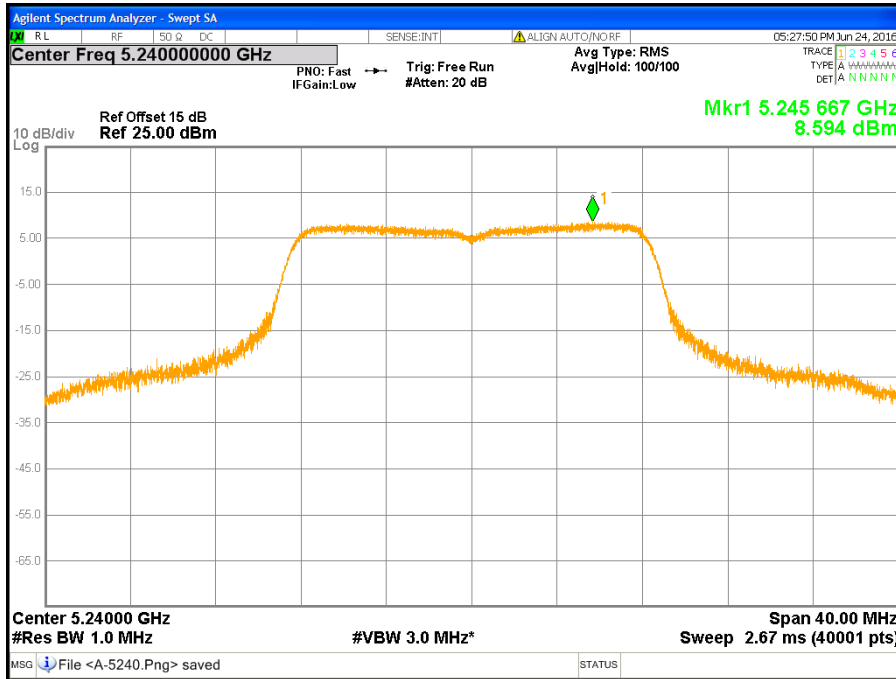

CH Low (IEEE 802.11a Mode / Band 1 / Chain B)

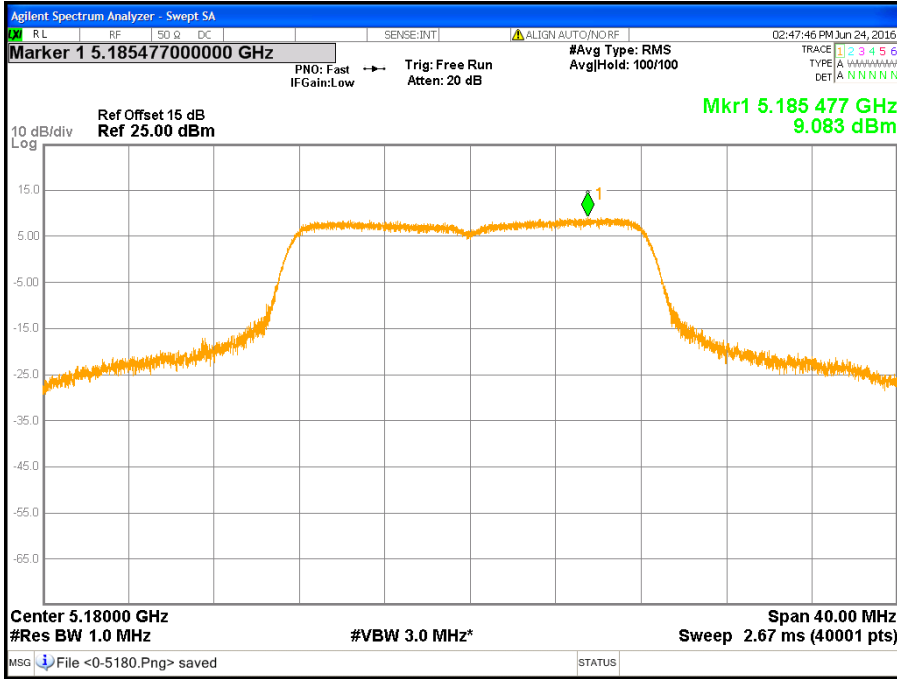

CH Middle (IEEE 802.11a Mode / Band 1 / Chain B)

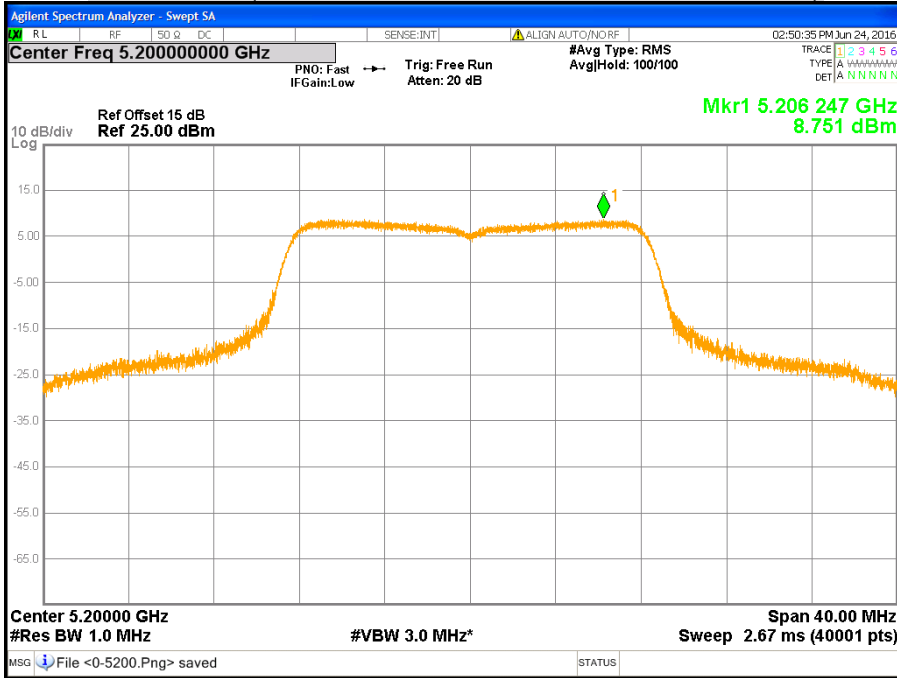

CH High (IEEE 802.11a Mode / Band 1 / Chain B)

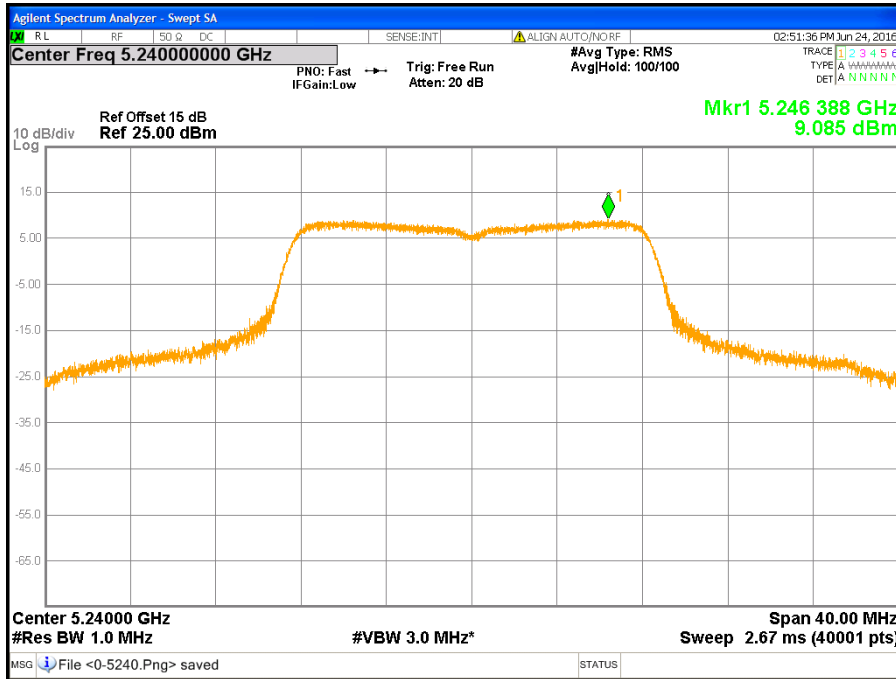

CH Low (IEEE 802.11a Mode / Band 3 / Chain A)

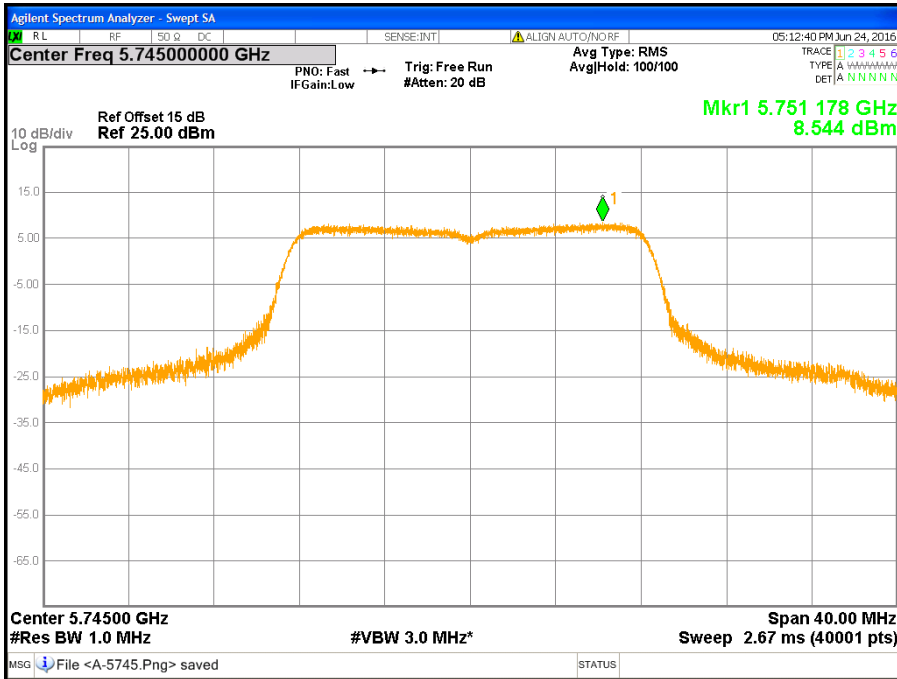

CH Middle (IEEE 802.11a Mode / Band 3 / Chain A)

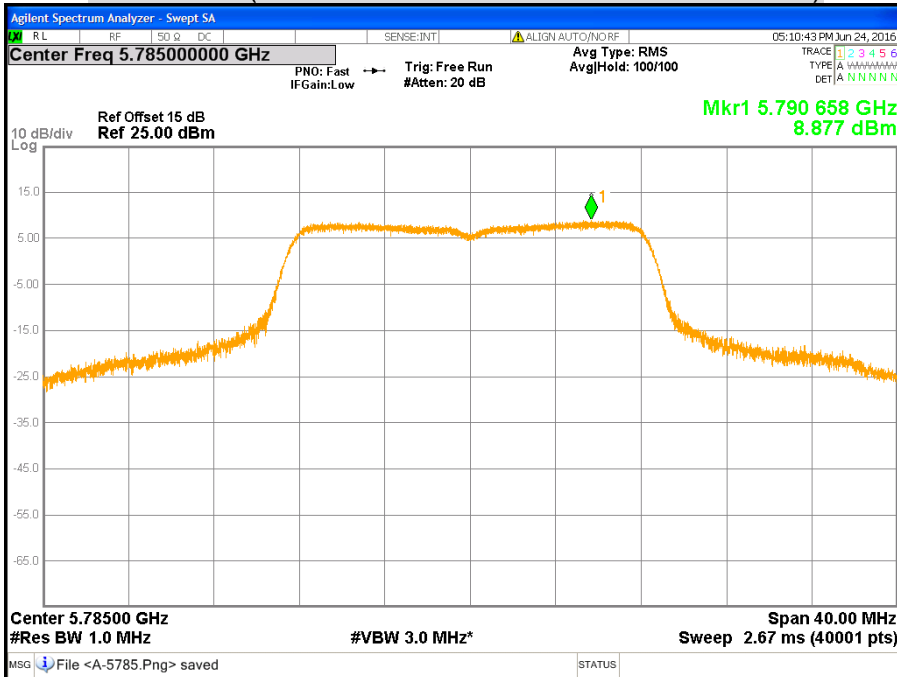

CH High (IEEE 802.11a Mode / Band 3 / Chain A)

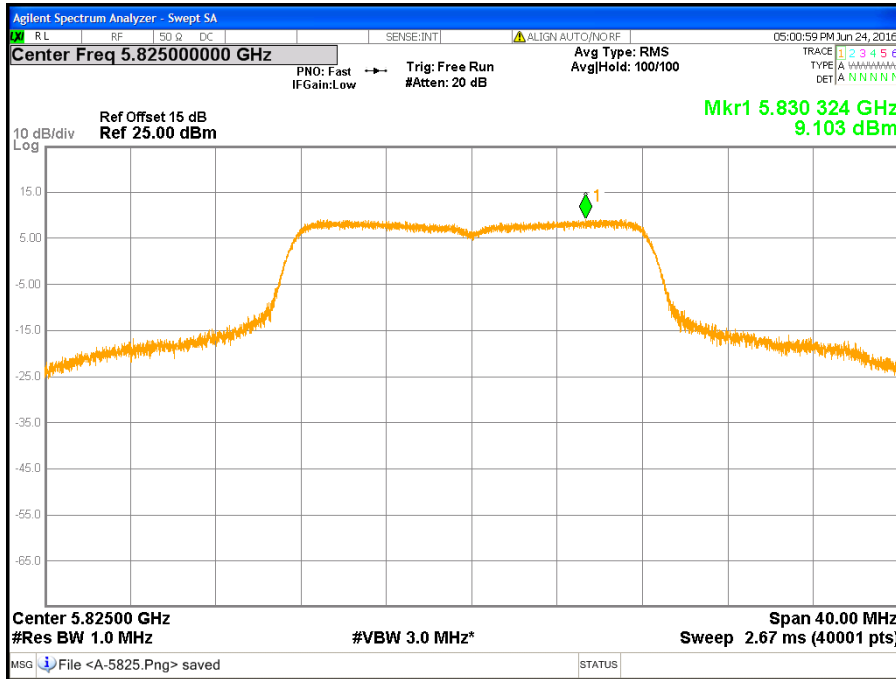

CH Low (IEEE 802.11a Mode / Band 3 / Chain B)

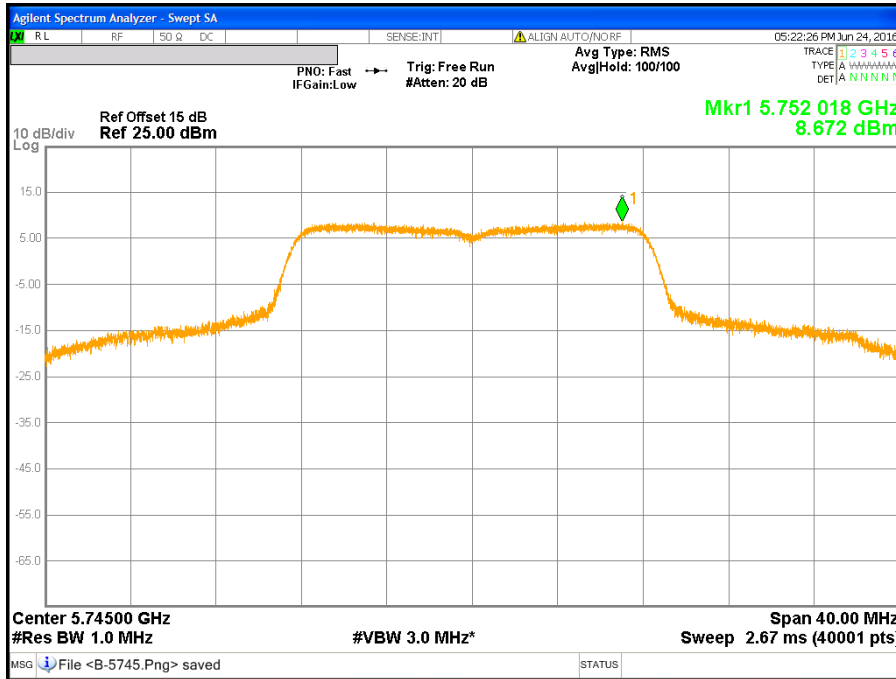

CH Middle (IEEE 802.11a Mode / Band 3 / Chain B)

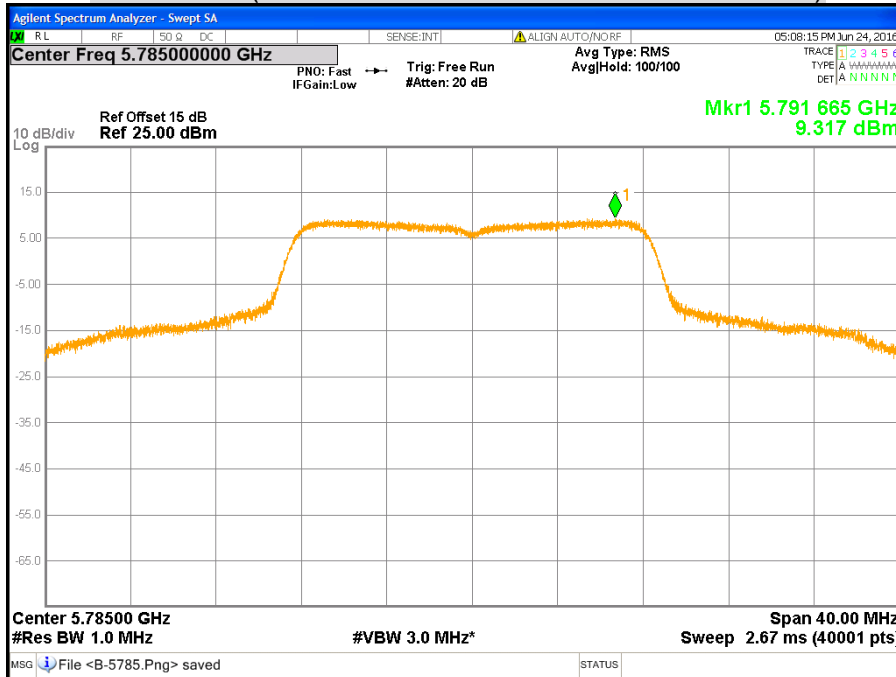

CH High (IEEE 802.11a Mode / Band 3 / Chain B)

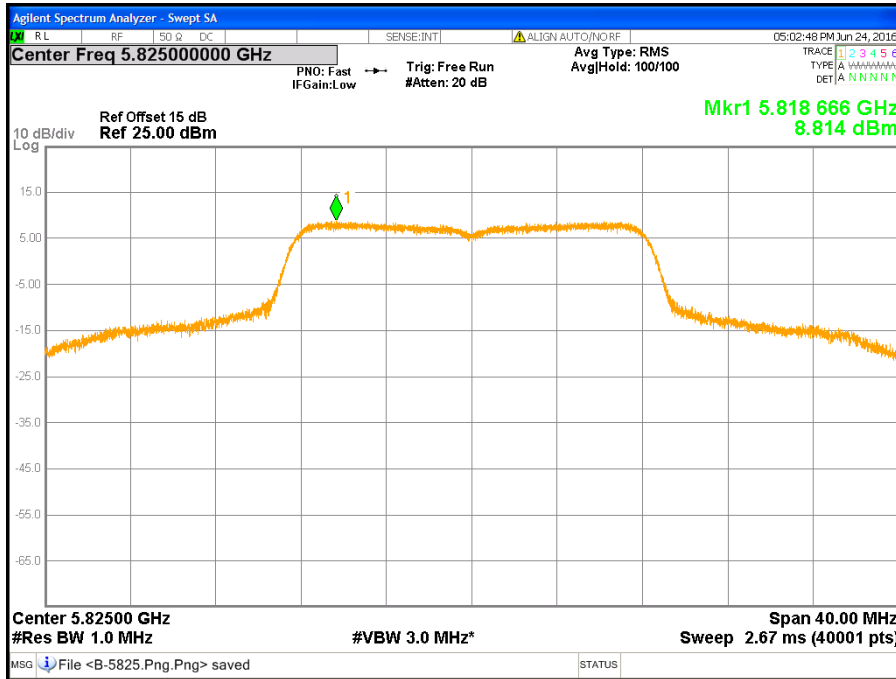

CH Low (IEEE 802.11ac VHT20 NSS1/MCS0 Mode / Band 1 / Chain A)

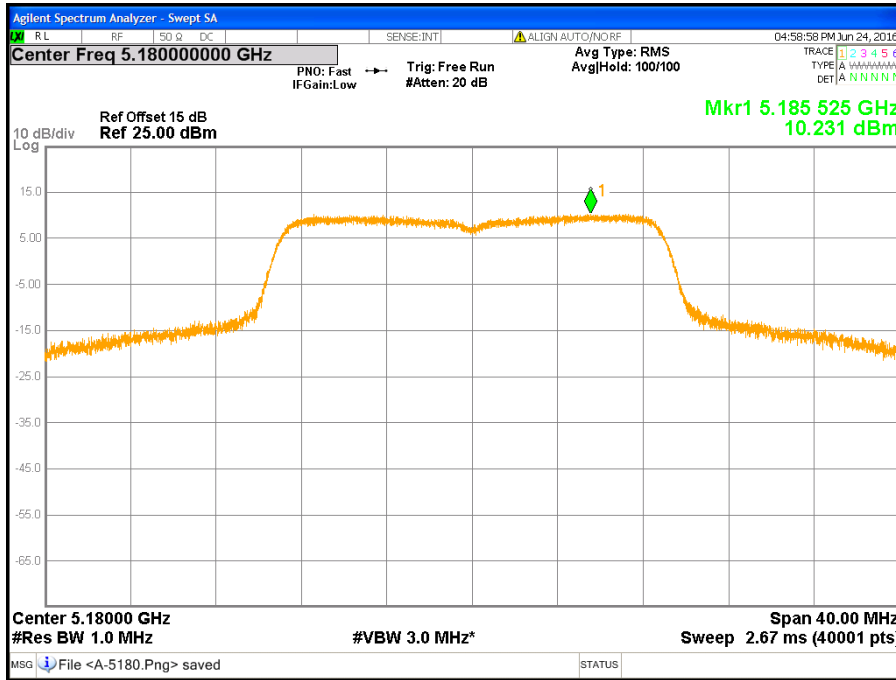

CH Middle (IEEE 802.11ac VHT20 NSS1/MCS0 Mode / Band 1 / Chain A)

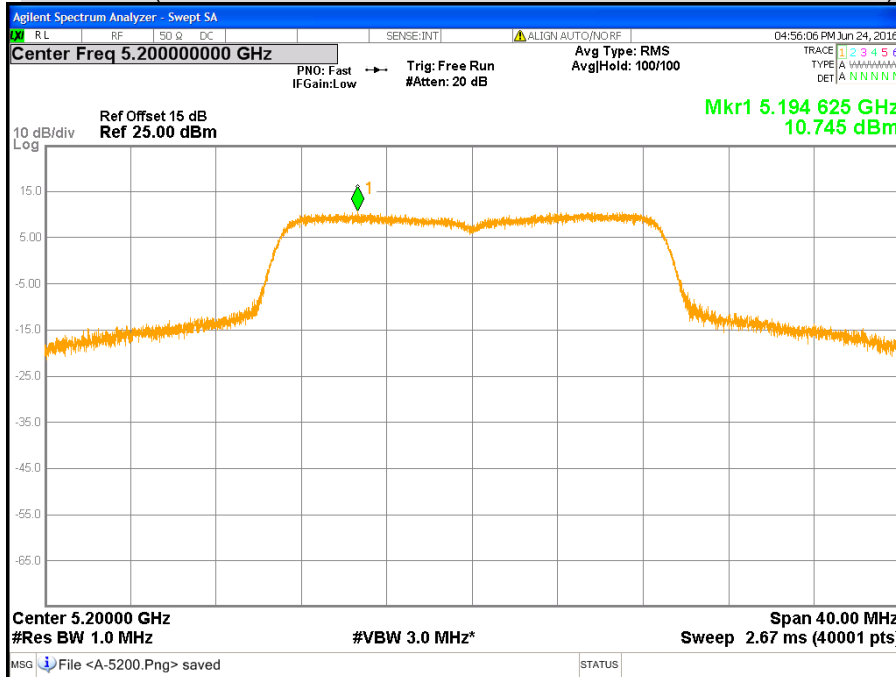

CH High (IEEE 802.11ac VHT20 NSS1/MCS0Mode / Band 1 / Chain A)

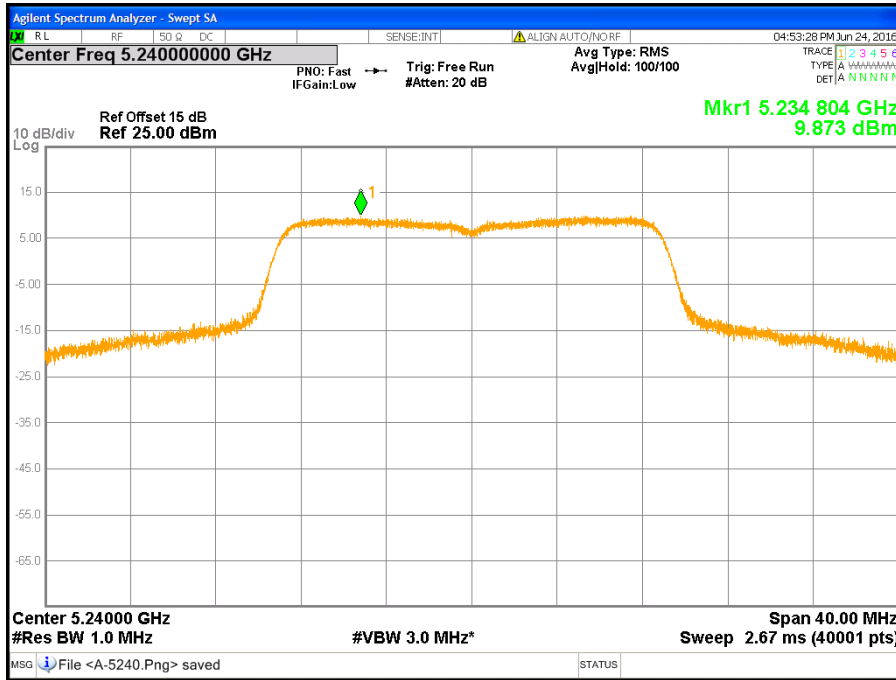

CH Low (IEEE 802.11ac VHT20 NSS1/MCS0 Mode / Band 1 / Chain B)

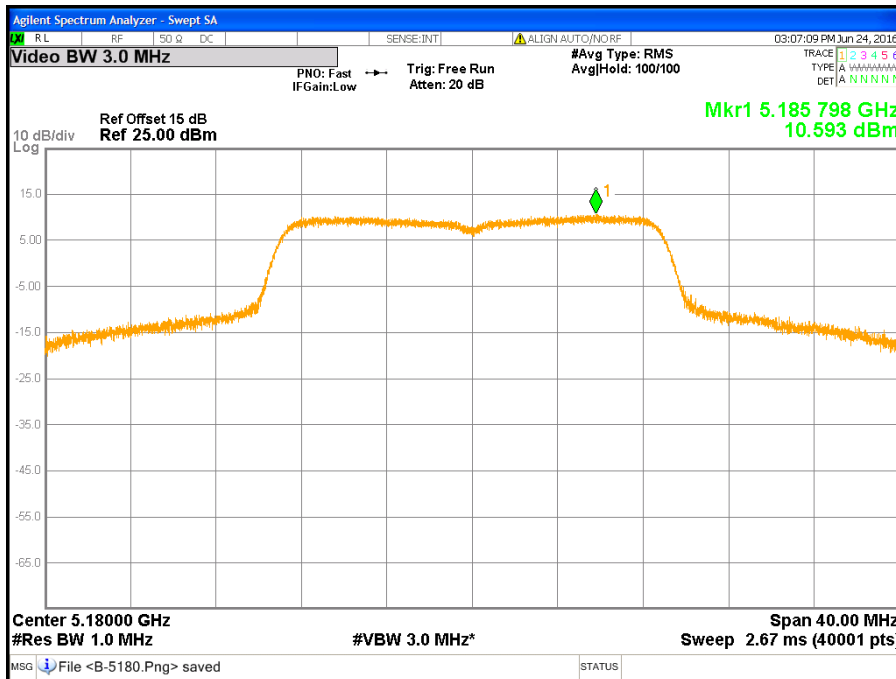

CH Middle (IEEE 802.11ac VHT20 NSS1/MCS0 Mode / Band 1 / Chain B)

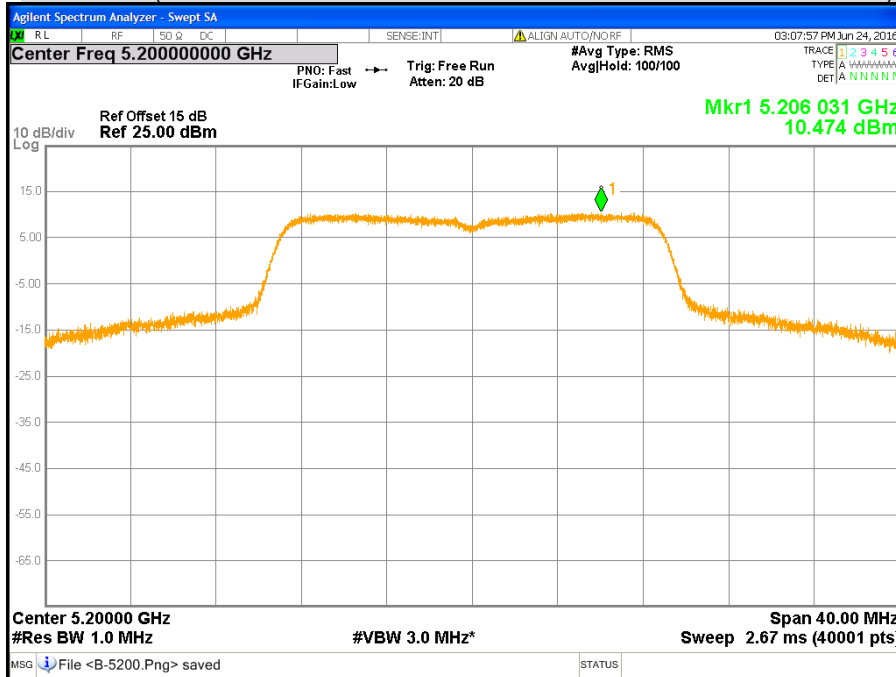

CH High (IEEE 802.11ac VHT20 NSS1/MCS0 Mode / Band 1 / Chain B)

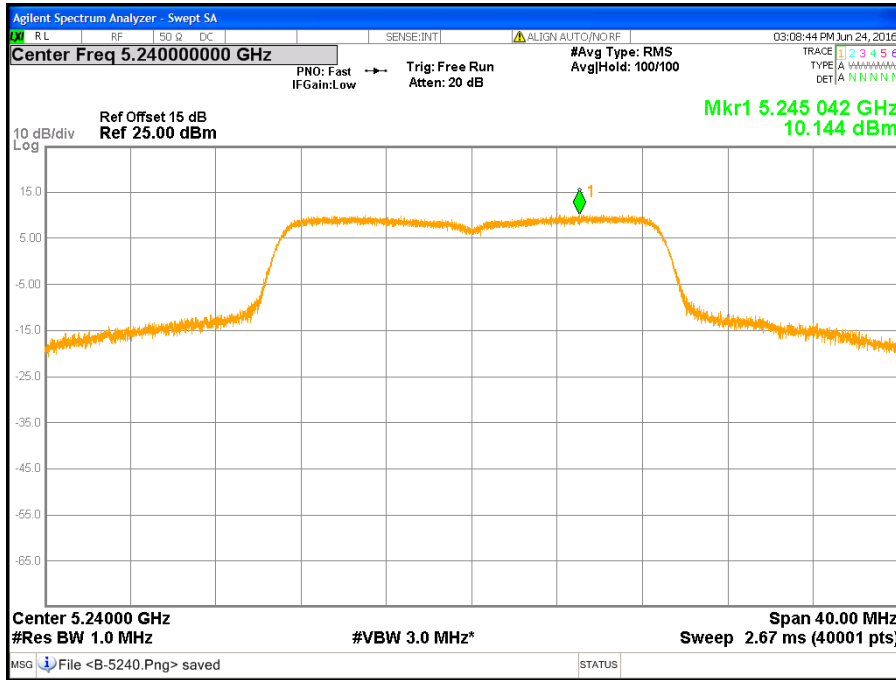

CH Low (IEEE 802.11ac VHT20 NSS1/MCS0 Mode / Band 3 / Chain A)

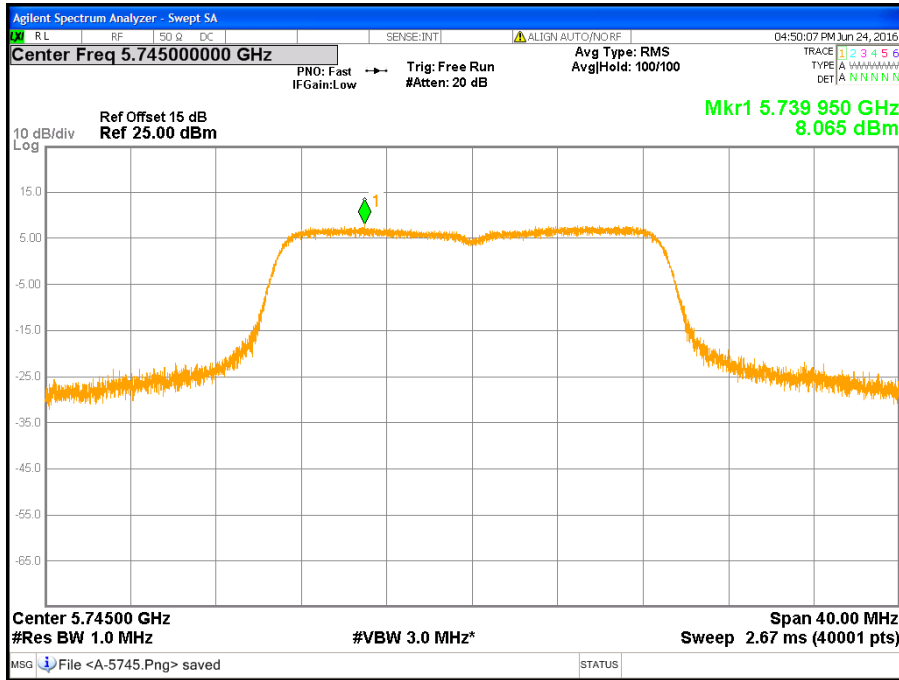

CH Middle (IEEE 802.11ac VHT20 NSS1/MCS0 Mode / Band 3 / Chain A)

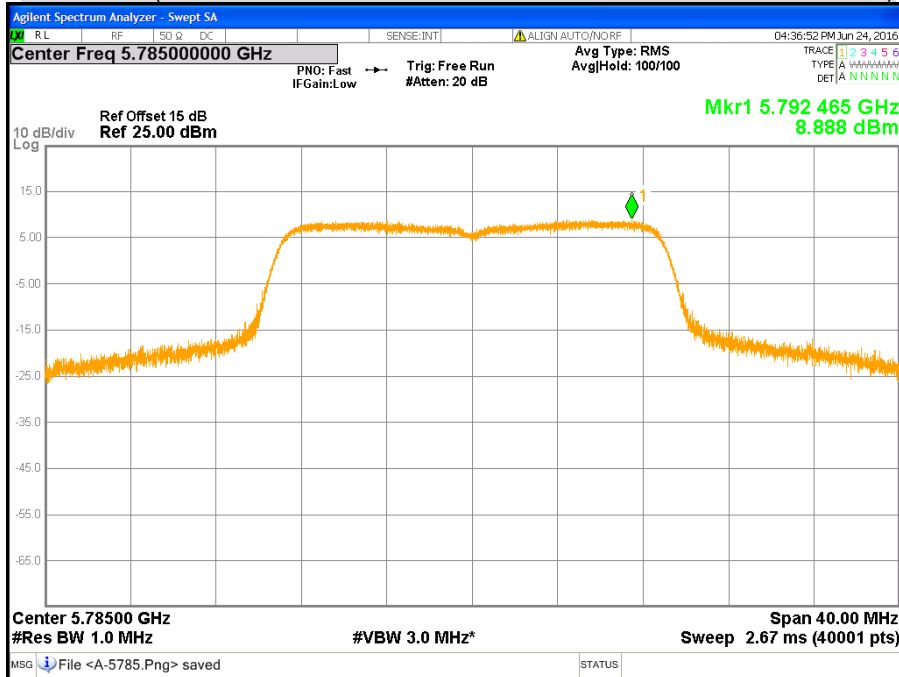

CH High (IEEE 802.11ac VHT20 NSS1/MCS0 Mode / Band 3 / Chain A)

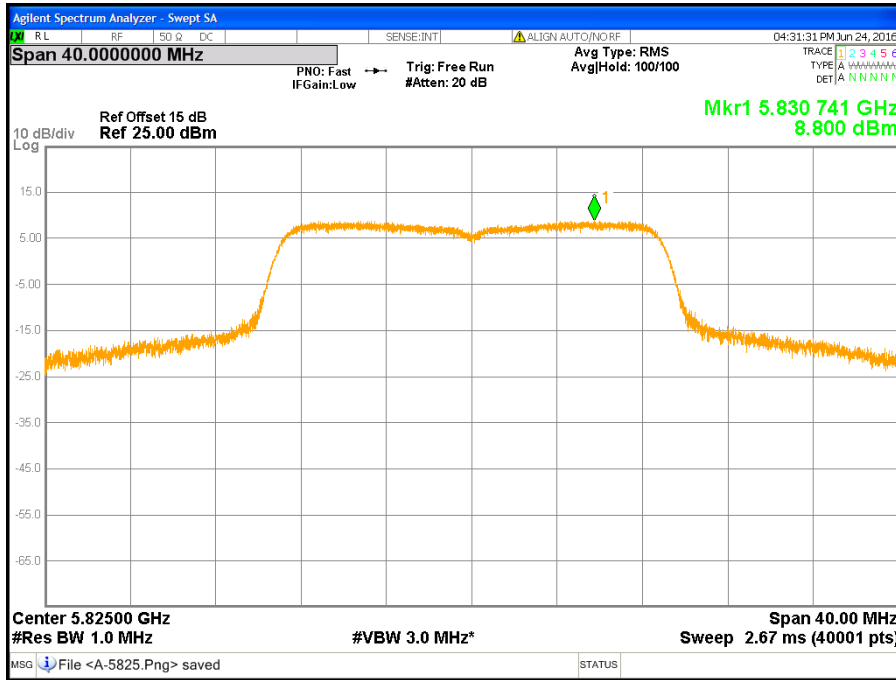

CH Low (IEEE 802.11ac VHT20 NSS1/MCS0 Mode / Band 3 / Chain B)

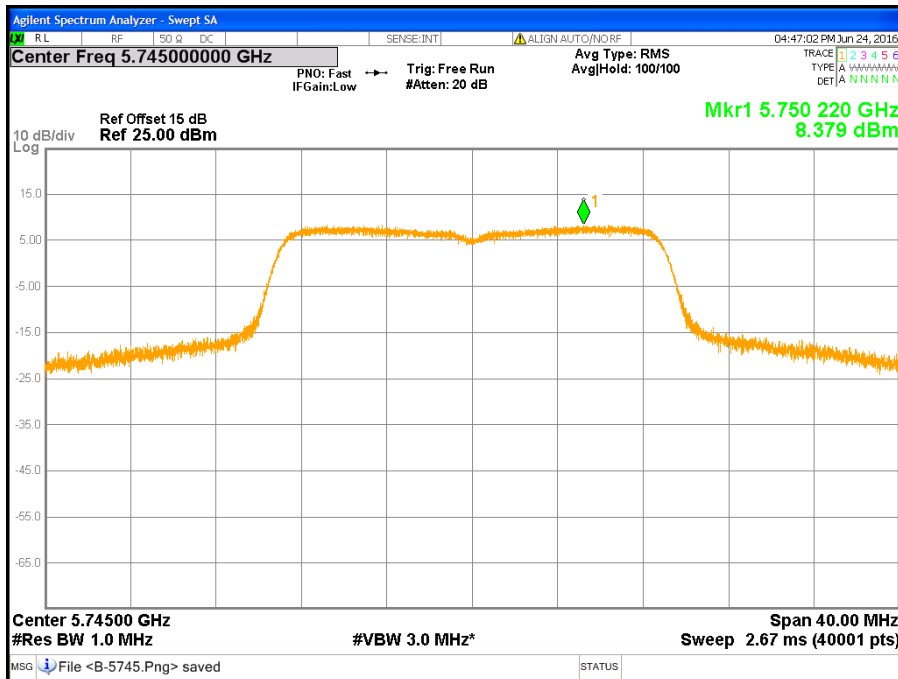

CH Middle (IEEE 802.11ac VHT20 NSS1/MCS0 Mode / Band 3 / Chain B)

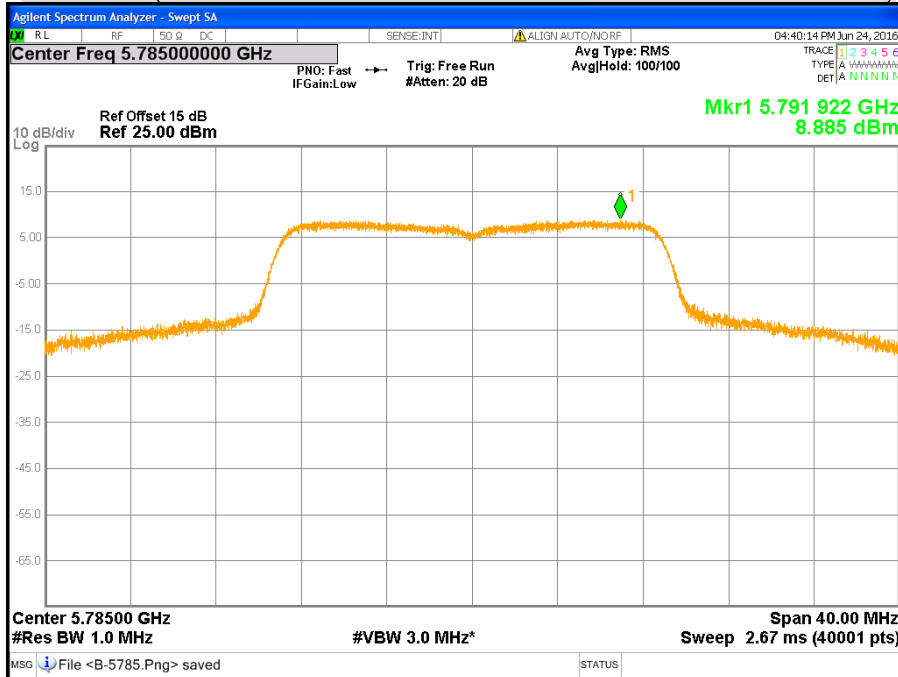

CH High (IEEE 802.11ac VHT20 NSS1/MCS0 Mode / Band 3 / Chain B)

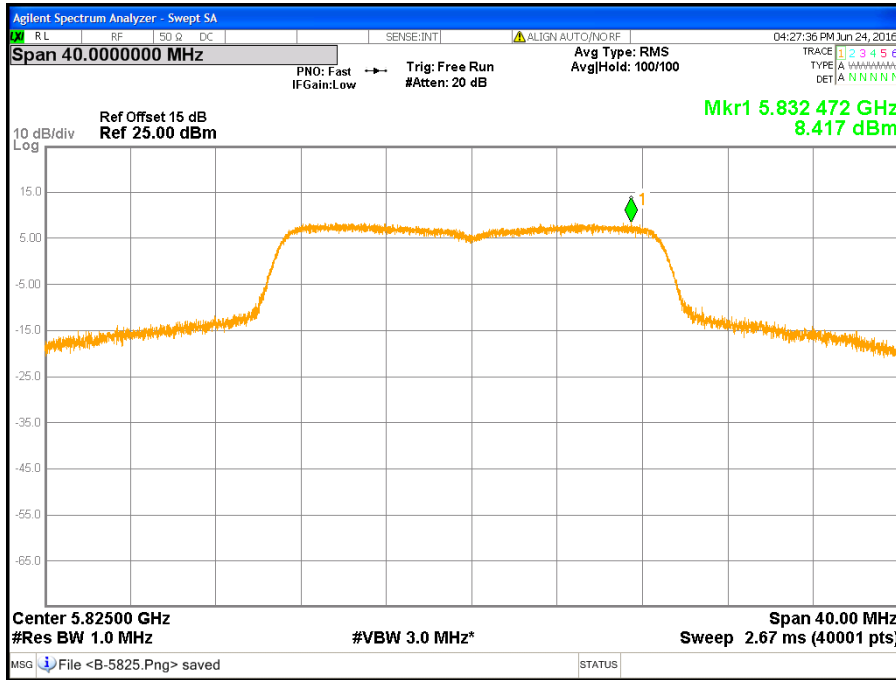

CH Low (IEEE 802.11ac VHT40 NSS1/MCS0 Mode / Band 1 / Chain A)

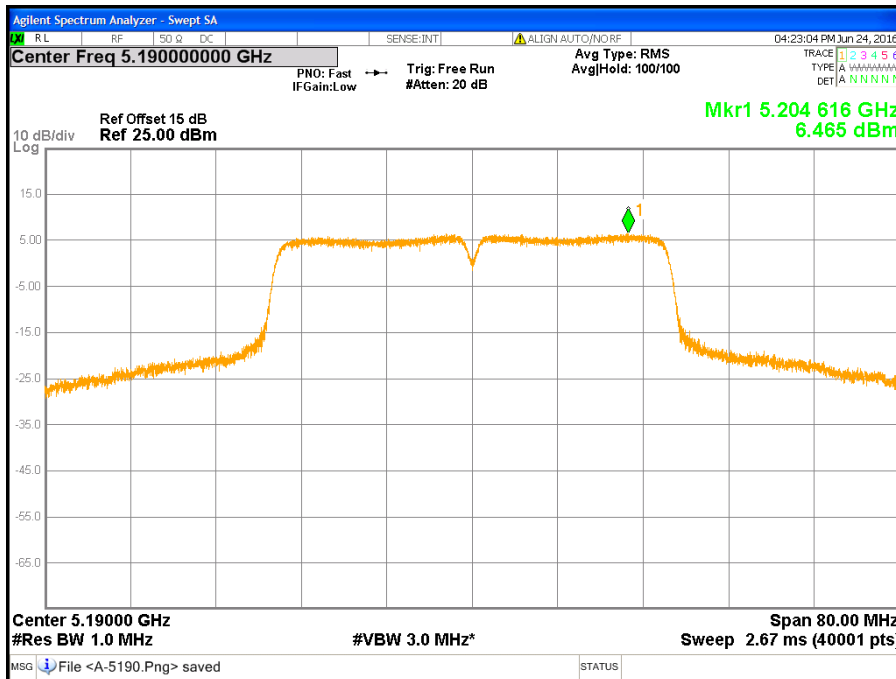

CH High (IEEE 802.11ac VHT40 NSS1/MCS0 Mode / Band 1 / Chain A)

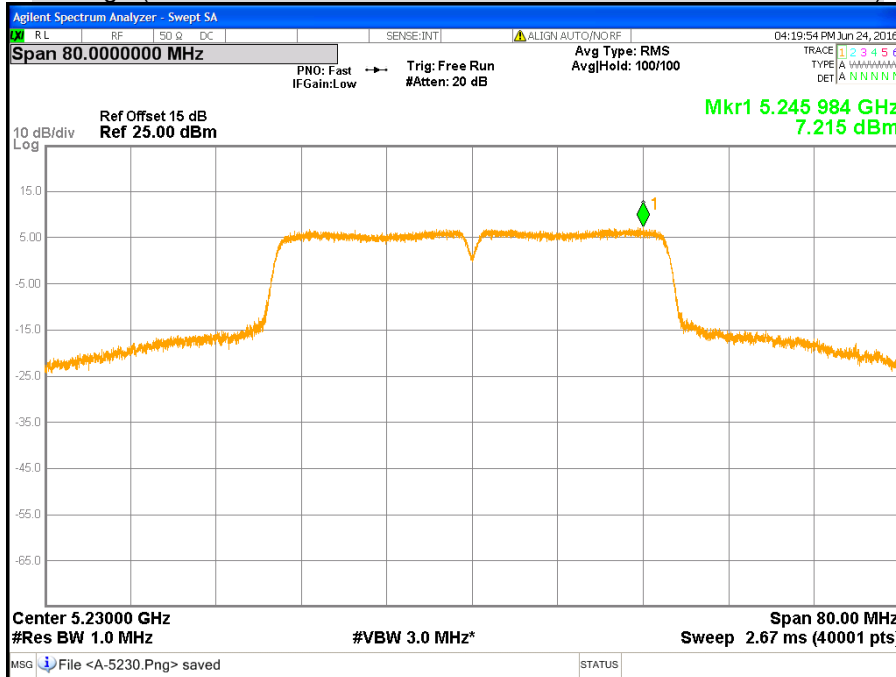

CH Low (IEEE 802.11ac VHT40 NSS1/MCS0 Mode / Band 1 / Chain B)

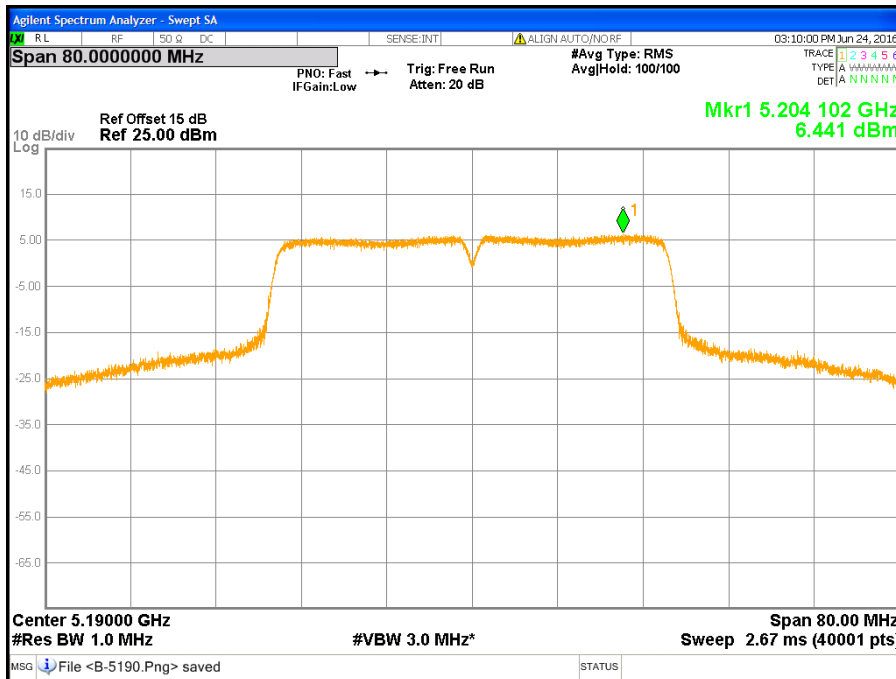

CH High (IEEE 802.11ac VHT40 NSS1/MCS0 Mode / Band 1 / Chain B)

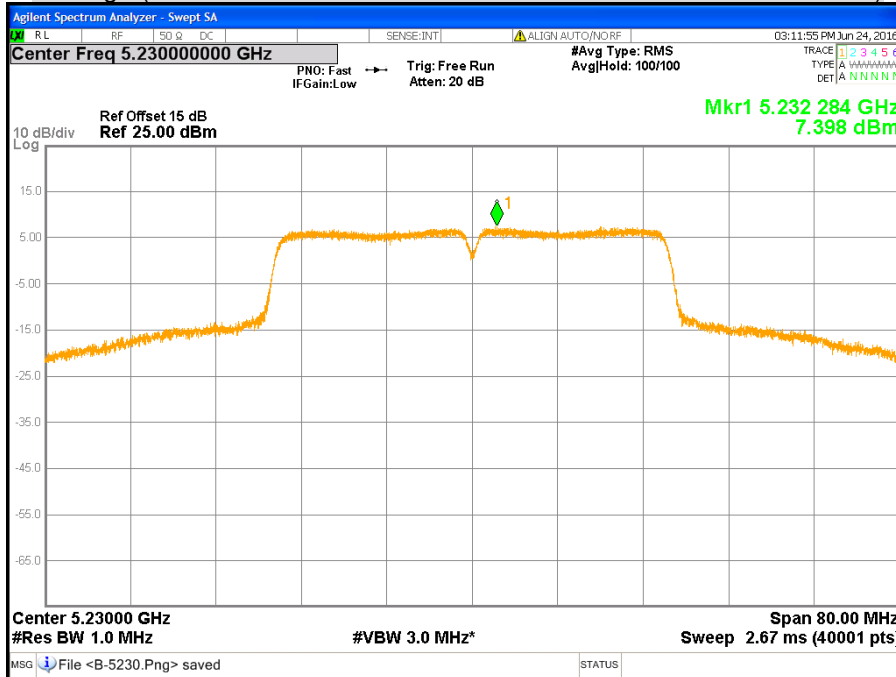

CH Low (IEEE 802.11ac VHT40 NSS1/MCS0 Mode / Band 3 / Chain A)

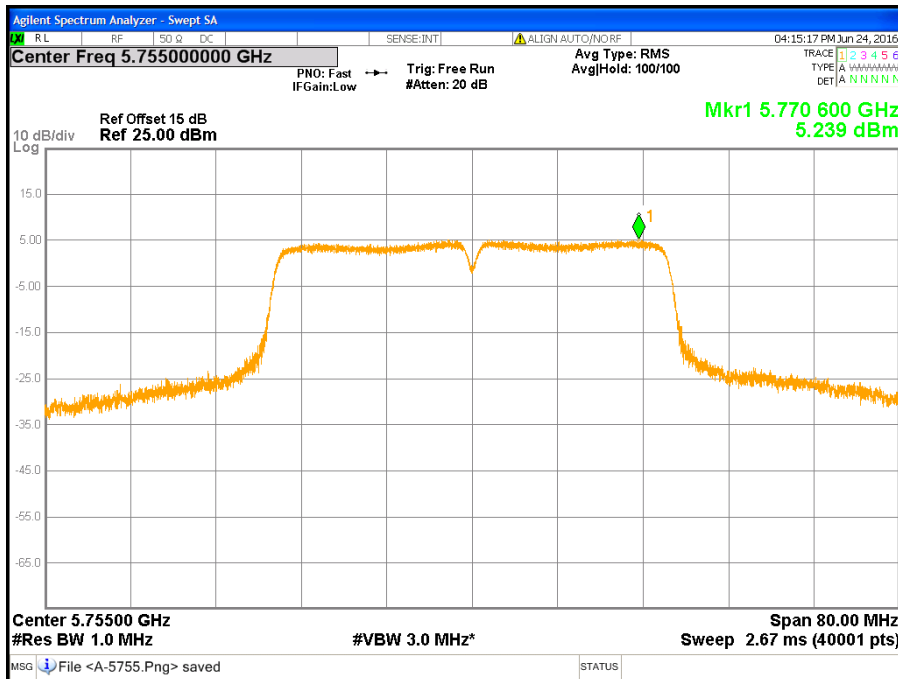

CH High (IEEE 802.11ac VHT40 NSS1/MCS0 Mode / Band 3 / Chain A)

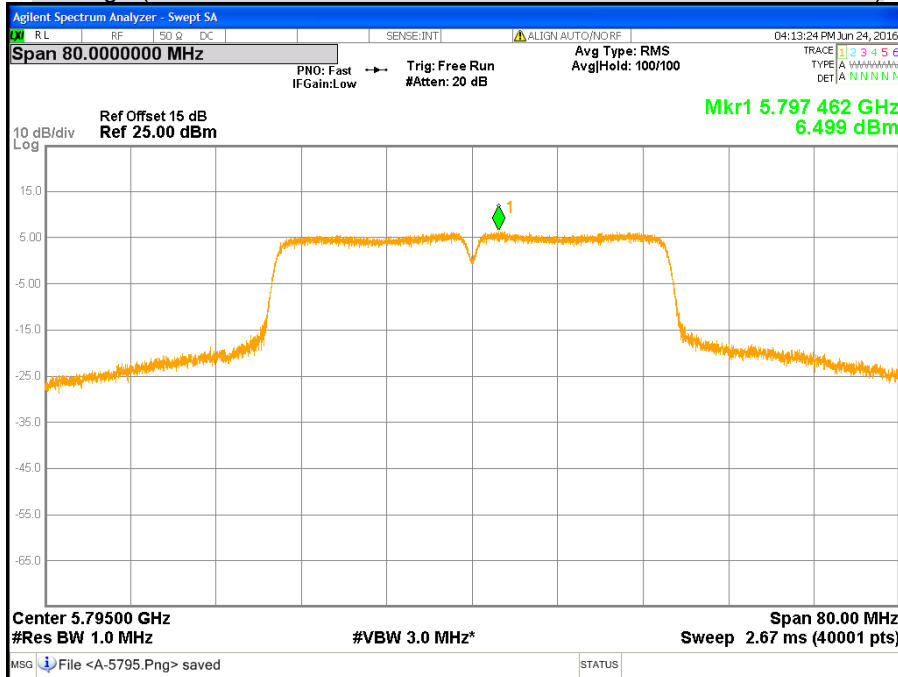

CH Low (IEEE 802.11ac VHT40 NSS1/MCS0 Mode / Band 3 / Chain B)

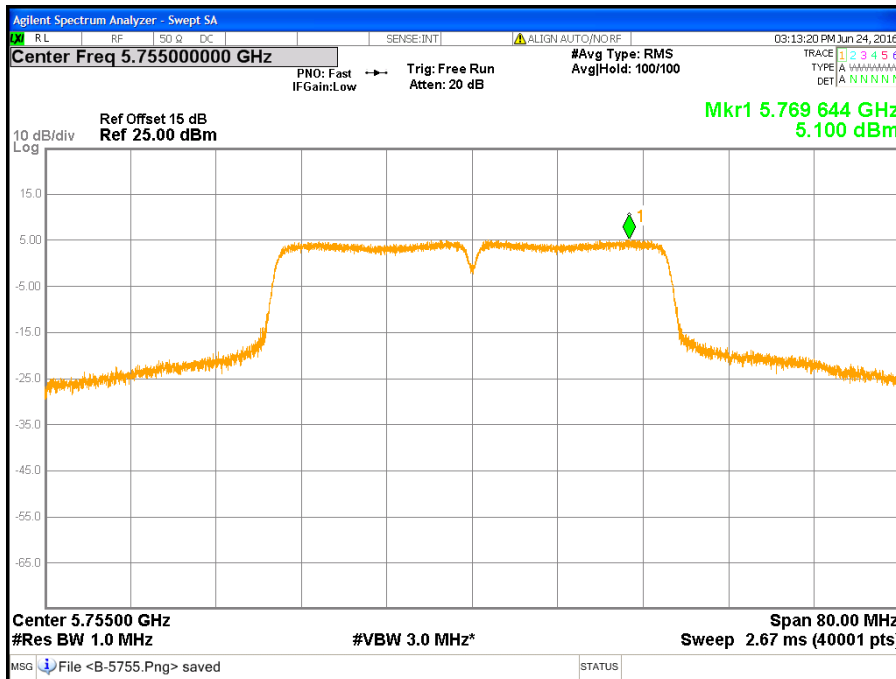

CH High (IEEE 802.11ac VHT40 NSS1/MCS0 Mode / Band 3 / Chain B)

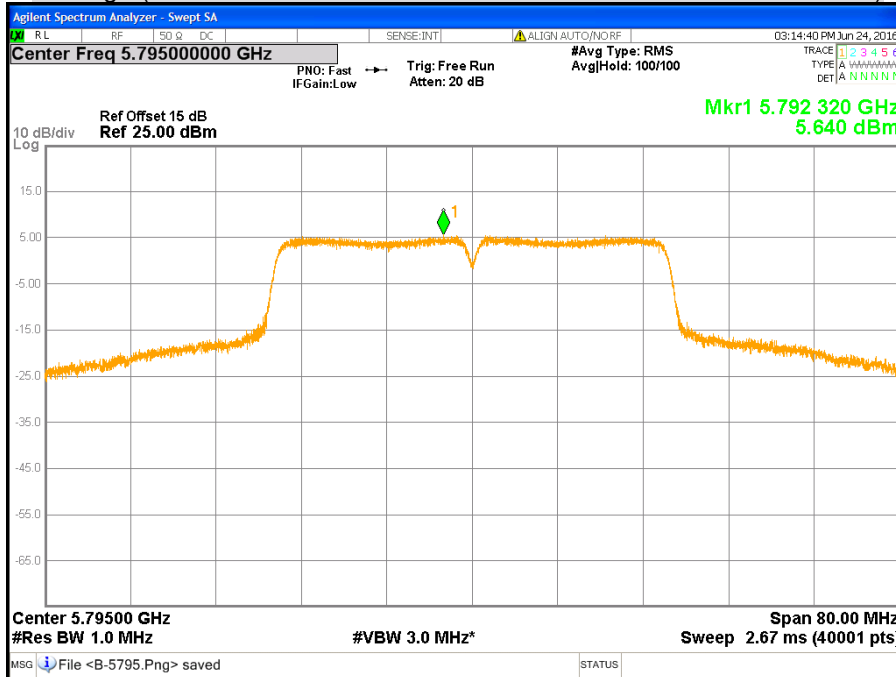

CH Low (IEEE 802.11ac VHT80 NSS1/MCS0 Mode / Band 1 / Chain A)

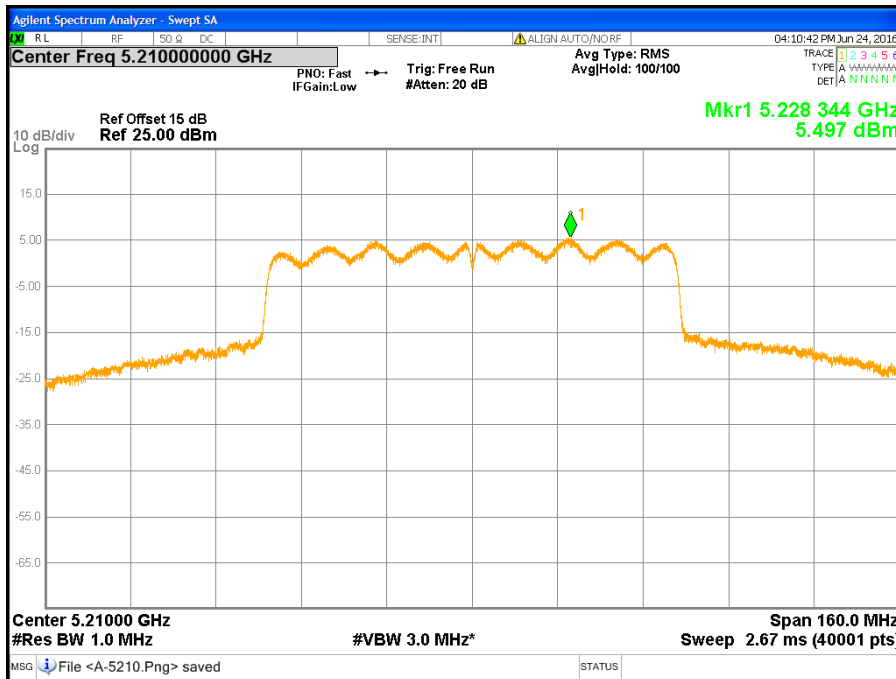

CH Low (IEEE 802.11ac VHT80 NSS1/MCS0 Mode / Band 1 / Chain B)

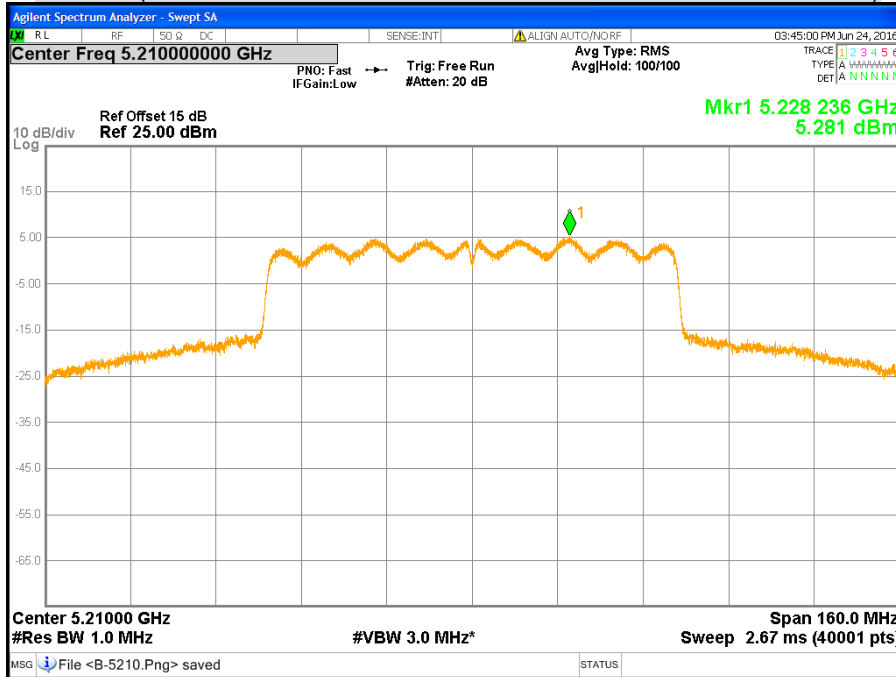

CH Low (IEEE 802.11ac VHT80 NSS1/MCS0 Mode / Band 3 / Chain A)

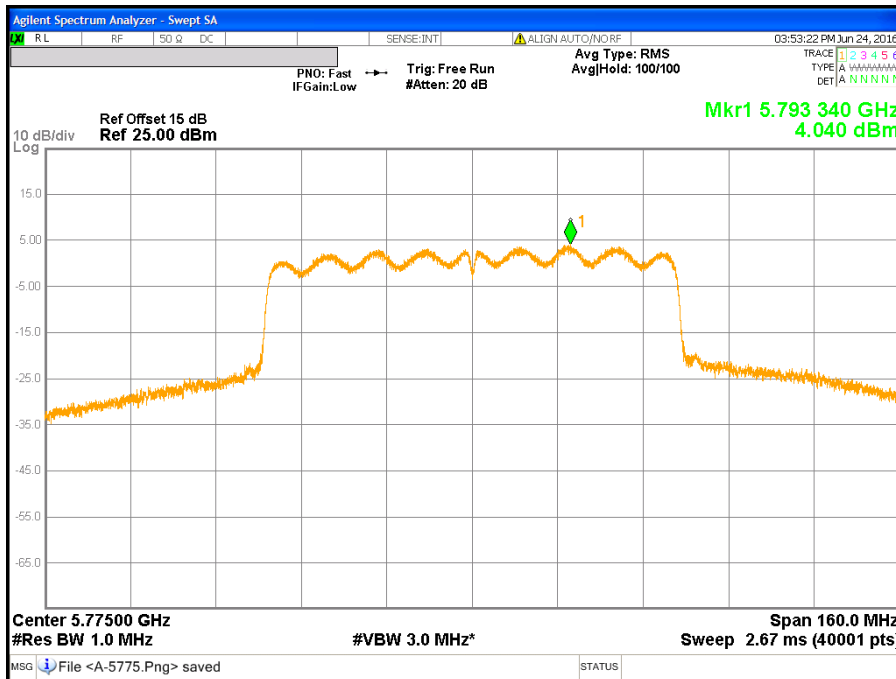

CH Low (IEEE 802.11ac VHT80 NSS1/MCS0 Mode / Band 3 / Chain B)

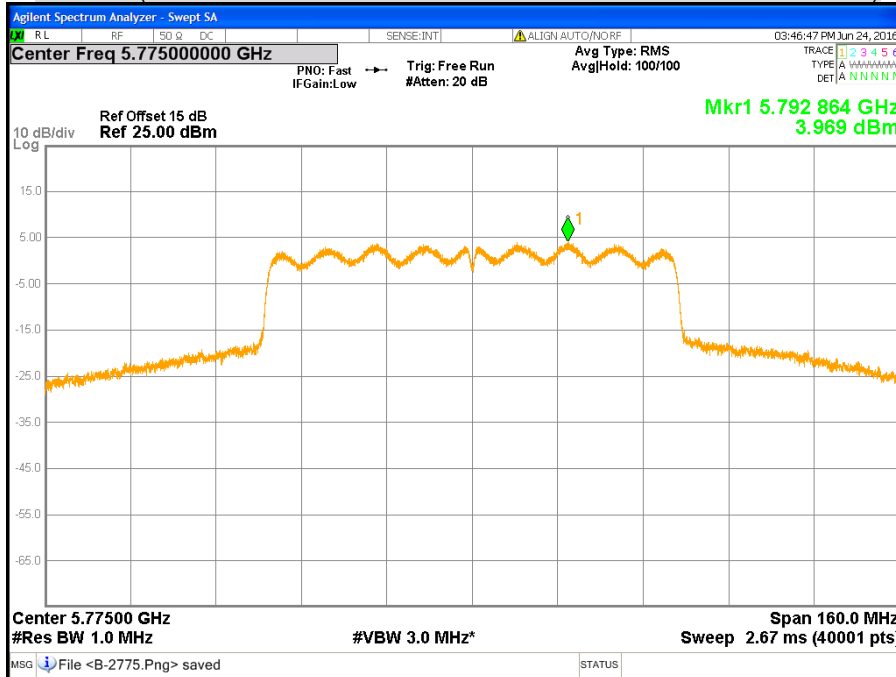

7.5 RADIATED EMISSION

LIMITS

(1) According to § 15.205 (a) Except as shown in paragraph (d) of this section, only spurious emissions are permitted in any of the frequency bands listed below:

MHz	MHz	MHz	GHz
0.090 - 0.110	16.42 - 16.423	399.9 - 410	4.5 - 5.15
¹ 0.495 - 0.505	16.69475 - 16.69525	608 - 614	5.35 - 5.46
2.1735 - 2.1905	16.80425 - 16.80475	960 - 1240	7.25 - 7.75
4.125 - 4.128	25.5 - 25.67	1300 - 1427	8.025 - 8.5
4.17725 - 4.17775	37.5 - 38.25	1435 - 1626.5	9.0 - 9.2
4.20725 - 4.20775	73 - 74.6	1645.5 - 1646.5	9.3 - 9.5
6.215 - 6.218	74.8 - 75.2	1660 - 1710	10.6 - 12.7
6.26775 - 6.26825	108 - 121.94	1718.8 - 1722.2	13.25 - 13.4
6.31175 - 6.31225	123 - 138	2200 - 2300	14.47 - 14.5
8.291 - 8.294	149.9 - 150.05	2310 - 2390	15.35 - 16.2
8.362 - 8.366	156.52475 - 156.52525	2483.5 - 2500	17.7 - 21.4
8.37625 - 8.38675	156.7 - 156.9	2655 - 2900	22.01 - 23.12
8.41425 - 8.41475	162.0125 - 167.17	3260 - 3267	23.6 - 24.0
12.29 - 12.293	167.72 - 173.2	3332 - 3339	31.2 - 31.8
12.51975 - 12.52025	240 - 285	3345.8 - 3338	36.43 - 36.5
12.57675 - 12.57725	322 - 335.4	3600 - 4400	(²)
13.36 - 13.41			

Remark:

1. ¹ Until February 1, 1999, this restricted band shall be 0.490-0.510 MHz.

2. ² Above 38.6

(2) According to § 15.205 (b) Except as provided in paragraphs (d) and (e) of this section, the field strength of emissions appearing within these frequency bands shall not exceed the limits shown in §15.209. At frequencies equal to or less than 1000 MHz, compliance with the limits in §15.209 shall be demonstrated using measurement instrumentation employing a CISPR quasi-peak detector. Above 1000 MHz, compliance with the emission limits in §15.209 shall be demonstrated based on the average value of the measured emissions. The provisions in §15.35 apply to these measurements.

(3) According to § 15.209 (a) Except as provided elsewhere in this Subpart, the emissions from an intentional radiator shall not exceed the field strength levels specified in the following table:

Frequency (MHz)	Field Strength (microvolts/meter)	Measurement Distance (meters)
0.009 – 0.490	2400/F(KHz)	300
0.490 – 1.705	24000/F(KHz)	30
1.705 – 30.0	30	30
30 - 88	100 **	3
88 - 216	150 **	3
216 - 960	200 **	3
Above 960	500	3

Remark: **Except as provided in paragraph (g), fundamental emissions from intentional radiators operating under this Section shall not be located in the frequency bands 54-72 MHz, 76-88 MHz, 174-216 MHz or 470-806 MHz. However, operation within these frequency bands is permitted under other sections of this Part, e.g., Sections 15.231 and 15.241.

(4) According to § 15.209 (b) In the emission table above, the tighter limit applies at the band edges.

(5) According to FCC 16-24, for transmitters operating in the 5.725-5.85 GHz band, all out-of-band emissions be limited to a level of -27 dBm/MHz at 75 MHz beyond the band edge, increasing linearly to 10 dBm/MHz at 25 MHz beyond the band edge, and from 25 MHz beyond the band edge, increasing linearly to a level of 17 dBm/MHz at the band edge. The OOB limits in the 5 MHz closest to the band edge by allowing emissions to increase linearly to a maximum level of 27 dBm/MHz.

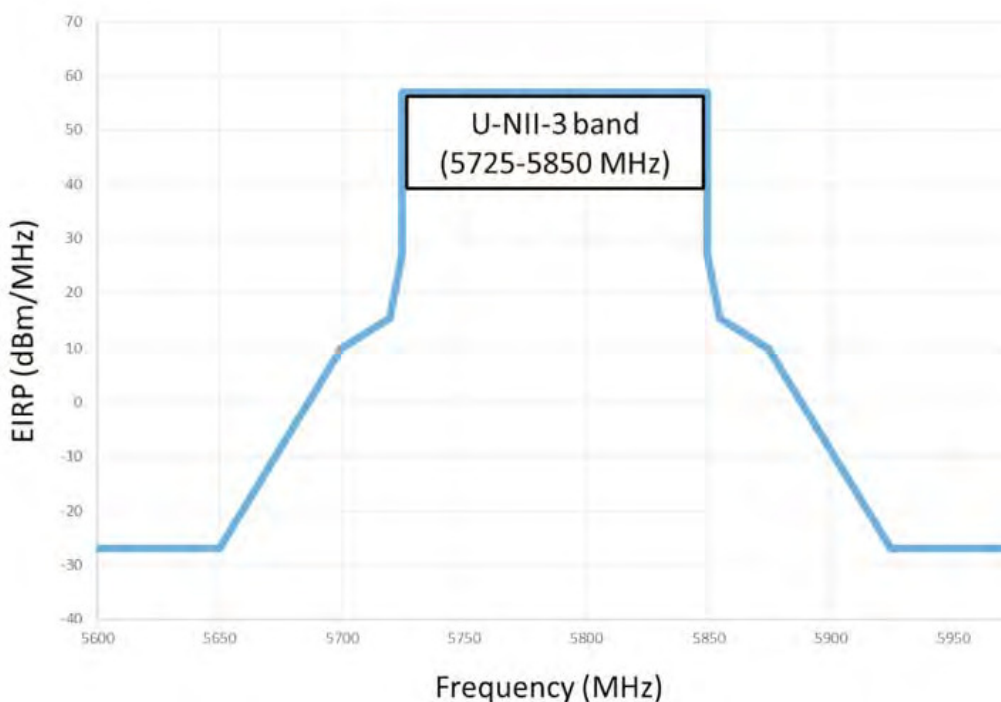

TEST EQUIPMENT

Radiated Emission / 966Chamber_C

Name of Equipment	Manufacture	Model	Serial Number	Calibration Due
Spectrum Analyzer	Agilent	E4446A	MY48250064	04/21/2017
EMI Test Receiver	Rohde & Schwarz	ESCI	101387	10/06/2016
Bi-log Antenna	TESEQ	CBL 6112D	35404	08/04/2016
Broad-Band Horn Antenna	Schwarzbeck	BBHA 9120 D	9120D-778	08/09/2016
Pre-Amplifier	EMCI	EMC001625	980243	04/11/2017
Pre-Amplifier	COM-POWER	PAM-118A	551043	04/11/2017
Double Ridged Guide Horn Antenna	ETS • LINDGREN	3117	00078732	07/14/2016
Horn Antenna	COM-POWER	AH-840	03077	12/08/2016
Loop Antenna	COM-POWER	AL-130	121060	05/23/2017
Test S/W	E3.815206a			

Remark: Each piece of equipment is scheduled for calibration once a year.

TEST SETUP

The diagram below shows the test setup that is utilized to make the measurements for emission below 1GHz.

9kHz ~ 30MHz

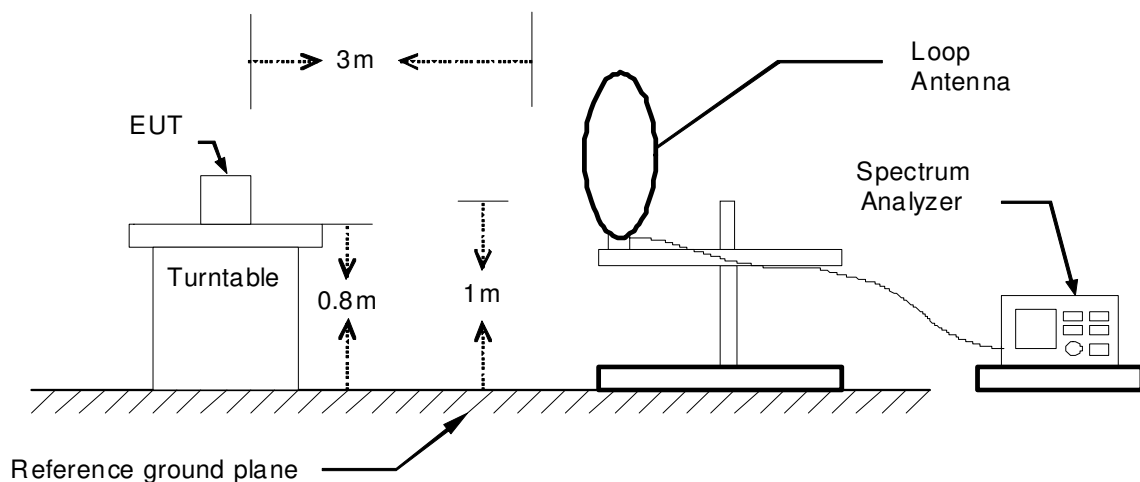

30MHz ~ 1GHz

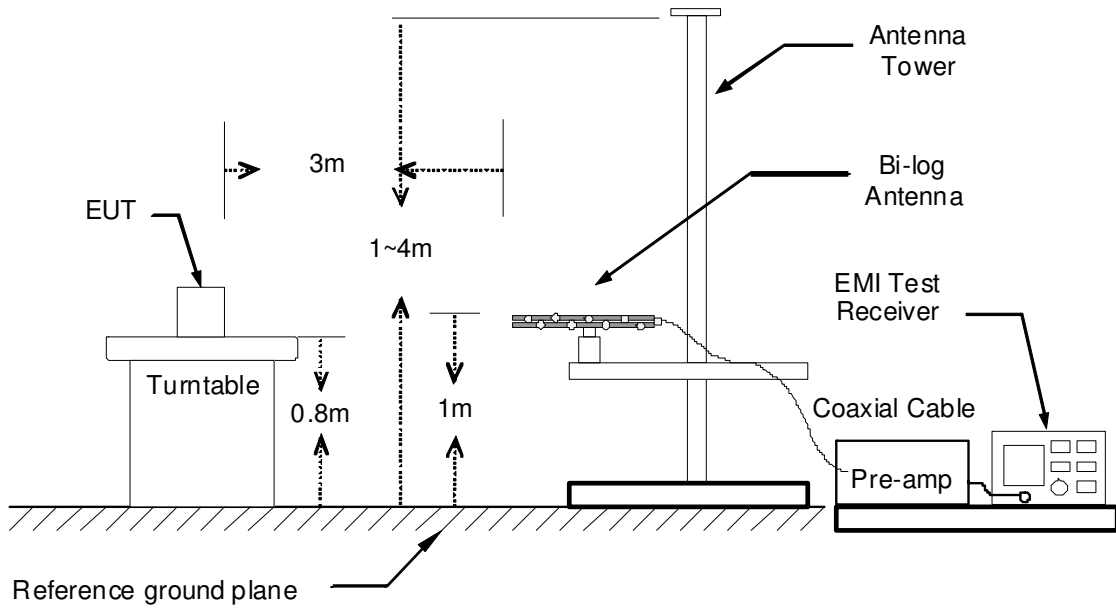

The diagram below shows the test setup that is utilized to make the measurements for emission above 1GHz.

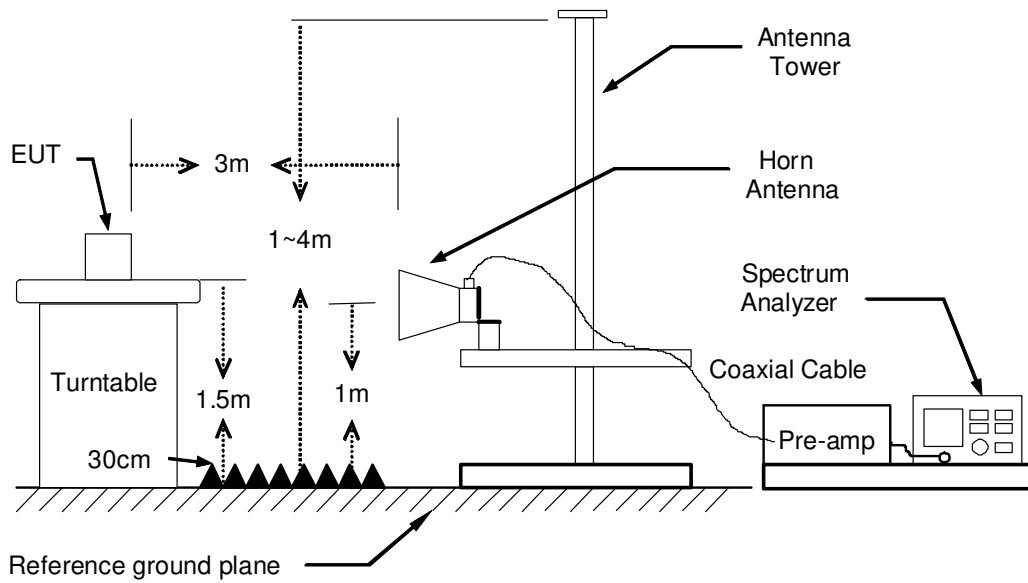

TEST PROCEDURE

1. The EUT was placed on the top of a rotating table 0.8 and 1.5 meters above the ground. The table was rotated 360 degrees to determine the position of the highest radiation.
2. While measuring the radiated emission below 1GHz, the EUT was set 3 meters away from the interference-receiving antenna, which was mounted on the top of a variable-height antenna tower. While measuring the radiated emission above 1GHz, the EUT was set 3 meters away from the interference-receiving antenna.
3. The antenna is a broadband antenna, and its height is varied from one meter to four meters above the ground to determine the maximum value of the field strength. Both horizontal and vertical polarization of the antenna are set to make the measurement.
4. For each suspected emission, the EUT was arranged to its worst case and then the antenna was tuned to heights from 1 meter to 4 meters and the table was turned from 0 degrees to 360 degrees to find the maximum reading.
5. The test-receiver system was set to Peak Detect Function and Specified Bandwidth with Maximum Hold Mode.
6. If the emission level of the EUT in peak mode was 10 dB lower than the limit specified, then testing could be stopped and the peak values of the EUT would be reported. Otherwise the emissions that did not have 10 dB margin would be re-tested one by one using peak, quasi-peak or average method as specified and then reported in a data sheet.

Remark:

1. *The resolution bandwidth and video bandwidth of test receiver/spectrum analyzer is 120 KHz for Peak detection (PK) and Quasi-peak detection (QP) at frequency below 1GHz.*
2. *The resolution bandwidth and video bandwidth of test receiver/spectrum analyzer is 1 MHz for Peak detection and frequency above 1GHz.*
3. *The resolution bandwidth of test receiver/spectrum analyzer is 1 MHz and the video bandwidth is 10 Hz for Average detection (AV) at frequency above 1GHz.*

TEST RESULTS

Below 1 GHz (9kHz ~ 30MHz)

No emission found between lowest internal used/generated frequency to 30MHz.

Below 1 GHz (30MHz ~ 1GHz)

Product Name	AC1200 Wireless Dual Band VDSL2 Gigabit VoIP IAD	Test By	Audi Chang
Test Model	DL4480V	Test Date	2016/06/25
Test Mode	UNII Band 1 / Mode 1	Temp. & Humidity	20°C, 53%

966Chamber_C at 3Meter / Horizontal

Freq. MHz	Reading dBuV	C.F. dB/m	Result dBuV/m	Limit dBuV/m	Margin dB	Azimuth deg	Height cm	Remark
80.44	60.14	-23.23	36.91	40.00	-3.09	90	200	Peak
153.19	57.52	-19.55	37.97	43.50	-5.53	99	200	Peak
196.84	54.66	-20.35	34.31	43.50	-9.19	221	100	Peak
514.03	46.73	-11.47	35.26	46.00	-10.74	76	200	Peak
700.27	41.95	-9.42	32.53	46.00	-13.47	186	100	Peak
749.74	40.38	-8.75	31.63	46.00	-14.37	221	100	Peak

966Chamber_C at 3Meter / Vertical

Freq. MHz	Reading dBuV	C.F. dB/m	Result dBuV/m	Limit dBuV/m	Margin dB	Azimuth deg	Height cm	Remark
42.61	56.20	-18.71	37.49	40.00	-2.51	137	100	QP
58.13	56.90	-24.11	32.79	40.00	-7.21	340	100	QP
80.44	59.60	-23.23	36.37	40.00	-3.63	137	100	QP
154.16	58.34	-19.61	38.73	43.50	-4.77	152	100	Peak
515.97	46.58	-11.44	35.14	46.00	-10.86	206	100	Peak
937.92	38.01	-6.98	31.03	46.00	-14.97	197	100	Peak

Remark:

1. Quasi-peak test would be performed if the peak result were greater than the quasi-peak limit.
2. Correction Factor (dB/m) = Antenna Factor (dB/m) + Cable Loss (dB) – PreAmp.Gain (dB)
3. Result (dBuV/m) = Reading (dBuV) + Correction Factor (dB/m)
4. Margin (dB) = Remark result (dBuV/m) - Quasi-peak limit (dBuV/m).

Product Name	AC1200 Wireless Dual Band VDSL2 Gigabit VoIP IAD	Test By	Audi Chang
Test Model	DL4480V	Test Date	2016/06/25
Test Mode	UNII Band 3 / Mode 1	Temp. & Humidity	20°C, 53%

966Chamber_C at 3Meter / Horizontal

Freq. MHz	Reading dBuV	C.F. dB/m	Result dBuV/m	Limit dBuV/m	Margin dB	Azimuth deg	Height cm	Remark
81.41	58.89	-23.10	35.79	40.00	-4.21	259	200	Peak
152.22	58.55	-19.49	39.06	43.50	-4.44	105	200	Peak
197.81	52.82	-20.31	32.51	43.50	-10.99	229	100	Peak
375.32	45.90	-14.01	31.89	46.00	-14.11	178	100	Peak
511.12	46.80	-11.52	35.28	46.00	-10.72	67	200	Peak
700.27	41.83	-9.42	32.41	46.00	-13.59	225	100	Peak

966Chamber_C at 3Meter / Vertical

Freq. MHz	Reading dBuV	C.F. dB/m	Result dBuV/m	Limit dBuV/m	Margin dB	Azimuth deg	Height cm	Remark
42.61	56.70	-18.71	37.99	40.00	-2.01	197	100	QP
58.13	57.26	-24.11	33.15	40.00	-6.85	359	100	QP
81.41	59.80	-23.10	36.70	40.00	-3.30	142	100	QP
152.22	57.63	-19.49	38.14	43.50	-5.36	183	100	Peak
524.70	46.84	-11.30	35.54	46.00	-10.46	108	100	Peak
937.92	36.53	-6.98	29.55	46.00	-16.45	215	100	Peak

Remark:

1. Quasi-peak test would be performed if the peak result were greater than the quasi-peak limit.
2. Correction Factor (dB/m) = Antenna Factor (dB/m) + Cable Loss (dB) – PreAmp.Gain (dB)
3. Result (dBuV/m) = Reading (dBuV) + Correction Factor (dB/m)
4. Margin (dB) = Remark result (dBuV/m) - Quasi-peak limit (dBuV/m).

Above 1GHz

Product Name	AC1200 Wireless Dual Band VDSL2 Gigabit VoIP IAD	Test By	Crystal Wu
Test Model	DL4480V	Test Date	2016/06/22
Test Mode	UNII Band 1 / IEEE 802.11a Mode TX / CH Low	Temp. & Humidity	20°C, 53%

966Chamber_C at 3Meter / Horizontal

Freq. MHz	Reading dBuV	C.F. dB/m	Result dBuV/m	Limit dBuV/m	Margin dB	Azimuth deg	Height cm	Remark
1500.00	43.56	-3.69	39.87	74.00	-34.13	122	100	Peak
5000.00	46.39	6.65	53.04	54.00	-0.96	298	200	Average
5000.00	48.89	6.65	55.54	74.00	-18.46	298	200	Peak
5345.00	42.57	7.90	50.47	74.00	-23.53	344	200	Peak
10368.00	38.55	5.93	44.48	54.00	-9.52	172	200	Average
10368.00	51.27	5.93	57.20	74.00	-16.80	172	200	Peak
15528.00	41.03	10.10	51.13	54.00	-2.87	238	200	Average
15528.00	60.54	10.10	70.64	74.00	-3.36	238	200	Peak

966Chamber_C at 3Meter / Vertical

Freq. MHz	Reading dBuV	C.F. dB/m	Result dBuV/m	Limit dBuV/m	Margin dB	Azimuth deg	Height cm	Remark
1500.00	45.03	-3.69	41.34	74.00	-32.66	217	100	Peak
5000.00	45.42	6.65	52.07	74.00	-21.93	46	200	Peak
5350.00	43.64	7.92	51.56	74.00	-22.44	129	200	Peak
10356.00	38.91	5.90	44.81	54.00	-9.19	189	200	Average
10356.00	52.28	5.90	58.18	74.00	-15.82	189	200	Peak
15540.00	42.40	10.10	52.50	54.00	-1.50	159	200	Average
15540.00	62.70	10.10	72.80	74.00	-1.20	159	200	Peak

Remark:

1. Measuring frequencies from 1 GHz to the 10th harmonic of highest fundamental frequency.
2. Average test would be performed if the peak result were greater than the average limit.
3. Measurements above show only up to 6 maximum emissions noted, or would be lesser, with "N/A" remark, if no specific emissions from the EUT are recorded (ie: margin>20dB from the applicable limit) and considered that's already beyond the background noise floor.
4. Result = Reading + Correction Factor
 Margin = Result - Limit
 Remark Peak = Result(PK) - Limit(PK)
 Remark AVG = Result(AV) - Limit(AV)

Product Name	AC1200 Wireless Dual Band VDSL2 Gigabit VoIP IAD	Test By	Crystal Wu
Test Model	DL4480V	Test Date	2016/06/22
Test Mode	UNII Band 1 / IEEE 802.11a Mode TX / CH Middle	Temp. & Humidity	20°C, 53%

966Chamber_C at 3Meter / Horizontal

Freq. MHz	Reading dBuV	C.F. dB/m	Result dBuV/m	Limit dBuV/m	Margin dB	Azimuth deg	Height cm	Remark
1500.00	45.15	-3.69	41.46	74.00	-32.54	120	100	Peak
5000.00	46.06	6.65	52.71	54.00	-1.29	305	200	Average
5000.00	48.37	6.65	55.02	74.00	-18.98	305	200	Peak
5150.00	39.65	7.19	46.84	54.00	-7.16	17	200	Average
5150.00	50.72	7.19	57.91	74.00	-16.09	17	200	Peak
5350.00	41.83	7.92	49.75	74.00	-24.25	356	200	Peak
10404.00	38.27	6.01	44.28	54.00	-9.72	199	200	Average
10404.00	50.54	6.01	56.55	74.00	-17.45	199	200	Peak
15612.00	39.90	10.10	50.00	54.00	-4.00	203	200	Average
15612.00	58.92	10.10	69.02	74.00	-4.98	203	200	Peak

966Chamber_C at 3Meter / Vertical

Freq. MHz	Reading dBuV	C.F. dB/m	Result dBuV/m	Limit dBuV/m	Margin dB	Azimuth deg	Height cm	Remark
1500.00	46.54	-3.69	42.85	74.00	-31.15	210	100	Peak
1755.00	44.20	-3.01	41.19	74.00	-32.81	336	150	Peak
5000.00	44.59	6.65	51.24	74.00	-22.76	44	200	Peak
5150.00	40.58	7.19	47.77	54.00	-6.23	63	150	Average
5150.00	54.05	7.19	61.24	74.00	-12.76	63	150	Peak
5350.00	42.58	7.92	50.50	74.00	-23.50	91	200	Peak
10404.00	38.13	6.01	44.14	54.00	-9.86	205	200	Average
10404.00	51.13	6.01	57.14	74.00	-16.86	205	200	Peak
15600.00	41.52	10.10	51.62	54.00	-2.38	144	200	Average
15600.00	60.08	10.10	70.18	74.00	-3.82	144	200	Peak

Remark:

1. Measuring frequencies from 1 GHz to the 10th harmonic of highest fundamental frequency.
2. Average test would be performed if the peak result were greater than the average limit.
3. Measurements above show only up to 6 maximum emissions noted, or would be lesser, with "N/A" remark, if no specific emissions from the EUT are recorded (ie: margin>20dB from the applicable limit) and considered that's already beyond the background noise floor.
4. Result = Reading + Correction Factor
 Margin = Result - Limit
 Remark Peak = Result(PK) - Limit(PK)
 Remark AVG = Result(AV) - Limit(AV)

Product Name	AC1200 Wireless Dual Band VDSL2 Gigabit VoIP IAD	Test By	Crystal Wu
Test Model	DL4480V	Test Date	2016/06/22
Test Mode	UNII Band 1 / IEEE 802.11a Mode TX / CH High	Temp. & Humidity	20°C, 53%

966Chamber_C at 3Meter / Horizontal

Freq. MHz	Reading dBuV	C.F. dB/m	Result dBuV/m	Limit dBuV/m	Margin dB	Azimuth deg	Height cm	Remark
1500.00	44.85	-3.69	41.16	74.00	-32.84	159	100	Peak
5000.00	46.10	6.65	52.75	54.00	-1.25	301	200	Average
5000.00	48.15	6.65	54.80	74.00	-19.20	301	200	Peak
5150.00	43.26	7.19	50.45	74.00	-23.55	136	200	Peak
5350.00	41.22	7.92	49.14	74.00	-24.86	171	100	Peak
10476.00	39.92	6.17	46.09	54.00	-7.91	192	200	Average
10476.00	50.58	6.17	56.75	74.00	-17.25	192	200	Peak
15720.00	41.88	10.10	51.98	54.00	-2.02	243	100	Average
15720.00	59.10	10.10	69.20	74.00	-4.80	243	100	Peak

966Chamber_C at 3Meter / Vertical

Freq. MHz	Reading dBuV	C.F. dB/m	Result dBuV/m	Limit dBuV/m	Margin dB	Azimuth deg	Height cm	Remark
1500.00	44.94	-3.69	41.25	74.00	-32.75	224	100	Peak
5000.00	45.32	6.65	51.97	54.00	-2.03	37	150	Average
5000.00	46.12	6.65	52.77	74.00	-21.23	37	150	Peak
5150.00	43.70	7.19	50.89	74.00	-23.11	141	200	Peak
5350.00	42.18	7.92	50.10	74.00	-23.90	81	200	Peak
10488.00	38.74	6.19	44.93	54.00	-9.07	178	200	Average
10488.00	48.57	6.19	54.76	74.00	-19.24	178	200	Peak
15708.00	42.18	10.10	52.28	54.00	-1.72	154	200	Average
15708.00	58.41	10.10	68.51	74.00	-5.49	154	200	Peak

Remark:

1. Measuring frequencies from 1 GHz to the 10th harmonic of highest fundamental frequency.
2. Average test would be performed if the peak result were greater than the average limit.
3. Measurements above show only up to 6 maximum emissions noted, or would be lesser, with "N/A" remark, if no specific emissions from the EUT are recorded (ie: margin>20dB from the applicable limit) and considered that's already beyond the background noise floor.
4. Result = Reading + Correction Factor
 Margin = Result - Limit
 Remark Peak = Result(PK) - Limit(PK)
 Remark AVG = Result(AV) - Limit(AV)

Product Name	AC1200 Wireless Dual Band VDSL2 Gigabit VoIP IAD	Test By	Crystal Wu
Test Model	DL4480V	Test Date	2016/06/22
Test Mode	UNII Band 1 / IEEE 802.11ac VHT20 NSS1/MCS0 Mode TX / CH Low	Temp. & Humidity	20°C, 53%

966Chamber_C at 3Meter / Horizontal

Freq. MHz	Reading dBuV	C.F. dB/m	Result dBuV/m	Limit dBuV/m	Margin dB	Azimuth deg	Height cm	Remark
1500.00	46.51	-3.69	42.82	74.00	-31.18	167	150	Peak
5000.00	46.50	6.65	53.15	54.00	-0.85	300	200	Average
5000.00	48.21	6.65	54.86	74.00	-19.14	300	200	Peak
5350.00	41.83	7.92	49.75	74.00	-24.25	360	150	Peak
7068.00	41.67	8.31	49.98	74.00	-24.02	130	200	Peak
8448.00	41.52	8.36	49.88	74.00	-24.12	46	100	Peak
10356.00	35.31	10.73	46.04	54.00	-7.96	188	200	Average
10356.00	45.75	10.73	56.48	74.00	-17.52	188	200	Peak

966Chamber_C at 3Meter / Vertical

Freq. MHz	Reading dBuV	C.F. dB/m	Result dBuV/m	Limit dBuV/m	Margin dB	Azimuth deg	Height cm	Remark
1500.00	44.16	-3.69	40.47	74.00	-33.53	221	100	Peak
5000.00	44.66	6.65	51.31	74.00	-22.69	63	200	Peak
5350.00	43.81	7.92	51.73	74.00	-22.27	133	200	Peak
6996.00	41.88	8.26	50.14	74.00	-23.86	239	100	Peak
9264.00	41.34	9.80	51.14	74.00	-22.86	231	200	Peak
10356.00	35.24	10.73	45.97	54.00	-8.03	179	100	Average
10356.00	45.63	10.73	56.36	74.00	-17.64	179	100	Peak

Remark:

1. Measuring frequencies from 1 GHz to the 10th harmonic of highest fundamental frequency.
2. Average test would be performed if the peak result were greater than the average limit.
3. Measurements above show only up to 6 maximum emissions noted, or would be lesser, with "N/A" remark, if no specific emissions from the EUT are recorded (ie: margin>20dB from the applicable limit) and considered that's already beyond the background noise floor.
4. Result = Reading + Correction Factor
 Margin = Result - Limit
 Remark Peak = Result(PK) - Limit(PK)
 Remark AVG = Result(AV) - Limit(AV)

Product Name	AC1200 Wireless Dual Band VDSL2 Gigabit VoIP IAD	Test By	Crystal Wu
Test Model	DL4480V	Test Date	2016/06/22
Test Mode	UNII Band 1 / IEEE 802.11ac VHT20 NSS1/MCS0 Mode TX / CH Middle	Temp. & Humidity	20°C, 53%

966Chamber_C at 3Meter / Horizontal

Freq. MHz	Reading dBuV	C.F. dB/m	Result dBuV/m	Limit dBuV/m	Margin dB	Azimuth deg	Height cm	Remark
1500.00	45.25	-3.69	41.56	74.00	-32.44	161	150	Peak
5000.00	46.20	6.65	52.85	54.00	-1.15	308	200	Average
5000.00	48.75	6.65	55.40	74.00	-18.60	308	200	Peak
5350.00	40.72	7.92	48.64	74.00	-25.36	236	150	Peak
6984.00	41.37	8.26	49.63	74.00	-24.37	231	200	Peak
8544.00	42.10	8.54	50.64	74.00	-23.36	239	100	Peak
10404.00	36.35	10.69	47.04	54.00	-6.96	177	200	Average
10404.00	46.93	10.69	57.62	74.00	-16.38	177	200	Peak

966Chamber_C at 3Meter / Vertical

Freq. MHz	Reading dBuV	C.F. dB/m	Result dBuV/m	Limit dBuV/m	Margin dB	Azimuth deg	Height cm	Remark
1500.00	45.37	-3.69	41.68	74.00	-32.32	218	100	Peak
5000.00	44.75	6.65	51.40	74.00	-22.60	10	100	Peak
5150.00	43.77	7.19	50.96	54.00	-3.04	41	200	Average
5150.00	55.91	7.19	63.10	74.00	-10.90	41	200	Peak
5345.00	42.96	7.90	50.86	74.00	-23.14	7	150	Peak
7104.00	41.11	8.33	49.44	74.00	-24.56	324	100	Peak
8544.00	41.15	8.54	49.69	74.00	-24.31	292	100	Peak
10404.00	34.56	10.69	45.25	54.00	-8.75	178	100	Average
10404.00	44.05	10.69	54.74	74.00	-19.26	178	100	Peak

Remark:

1. Measuring frequencies from 1 GHz to the 10th harmonic of highest fundamental frequency.
2. Average test would be performed if the peak result were greater than the average limit.
3. Measurements above show only up to 6 maximum emissions noted, or would be lesser, with "N/A" remark, if no specific emissions from the EUT are recorded (ie: margin>20dB from the applicable limit) and considered that's already beyond the background noise floor.
4. Result = Reading + Correction Factor
 Margin = Result - Limit
 Remark Peak = Result(PK) - Limit(PK)
 Remark AVG = Result(AV) - Limit(AV)

Product Name	AC1200 Wireless Dual Band VDSL2 Gigabit VoIP IAD	Test By	Crystal Wu
Test Model	DL4480V	Test Date	2016/06/22
Test Mode	UNII Band 1 / IEEE 802.11ac VHT20 NSS1/MCS0 Mode TX / CH High	Temp. & Humidity	20°C, 53%

966Chamber_C at 3Meter / Horizontal

Freq. MHz	Reading dBuV	C.F. dB/m	Result dBuV/m	Limit dBuV/m	Margin dB	Azimuth deg	Height cm	Remark
1500.00	46.94	-3.69	43.25	74.00	-30.75	158	150	Peak
5000.00	46.70	6.65	53.35	54.00	-0.65	308	200	Average
5000.00	46.70	6.65	53.35	74.00	-20.65	308	200	Peak
5150.00	46.45	7.19	53.64	74.00	-20.36	0	100	Peak
5345.00	41.74	7.90	49.64	74.00	-24.36	45	200	Peak
7032.00	41.54	8.28	49.82	74.00	-24.18	0	100	Peak
10488.00	34.28	10.62	44.90	54.00	-9.10	240	200	Average
10488.00	46.01	10.62	56.63	74.00	-17.37	240	200	Peak
15720.00	37.08	16.73	53.81	54.00	-0.19	135	200	Average
15720.00	53.71	16.73	70.44	74.00	-3.56	135	200	Peak

966Chamber_C at 3Meter / Vertical

Freq. MHz	Reading dBuV	C.F. dB/m	Result dBuV/m	Limit dBuV/m	Margin dB	Azimuth deg	Height cm	Remark
1500.00	46.00	-3.69	42.31	74.00	-31.69	219	100	Peak
5000.00	46.10	6.65	52.75	54.00	-1.25	48	200	Average
5000.00	47.14	6.65	53.79	74.00	-20.21	48	200	Peak
5350.00	43.88	7.92	51.80	74.00	-22.20	103	200	Peak
7572.00	40.80	8.44	49.24	74.00	-24.76	31	100	Peak
10476.00	32.88	10.63	43.51	54.00	-10.49	151	100	Average
10476.00	44.70	10.63	55.33	74.00	-18.67	151	100	Peak
15720.00	37.10	16.73	53.83	54.00	-0.17	168	200	Average
15720.00	50.64	16.73	67.37	74.00	-6.63	168	200	Peak

Remark:

1. Measuring frequencies from 1 GHz to the 10th harmonic of highest fundamental frequency.
2. Average test would be performed if the peak result were greater than the average limit.
3. Measurements above show only up to 6 maximum emissions noted, or would be lesser, with "N/A" remark, if no specific emissions from the EUT are recorded (ie: margin>20dB from the applicable limit) and considered that's already beyond the background noise floor.
4. Result = Reading + Correction Factor
 Margin = Result - Limit
 Remark Peak = Result(PK) - Limit(PK)
 Remark AVG = Result(AV) - Limit(AV)

Product Name	AC1200 Wireless Dual Band VDSL2 Gigabit VoIP IAD	Test By	Crystal Wu
Test Model	DL4480V	Test Date	2016/06/22
Test Mode	UNII Band 1 / IEEE 802.11ac VHT40 NSS1/MCS0 Mode TX / CH Low	Temp. & Humidity	20°C, 53%

966Chamber_C at 3Meter / Horizontal

Freq. MHz	Reading dBuV	C.F. dB/m	Result dBuV/m	Limit dBuV/m	Margin dB	Azimuth deg	Height cm	Remark
1500.00	50.96	-3.28	47.68	74.00	-26.32	163	150	Peak
2980.00	49.31	1.57	50.88	74.00	-23.12	270	300	Peak
4460.00	48.35	4.80	53.15	74.00	-20.85	111	200	Peak
5365.00	46.22	7.39	53.61	74.00	-20.39	3	300	Peak
7740.00	41.56	8.02	49.58	74.00	-24.42	207	200	Peak
9372.00	41.69	10.05	51.74	74.00	-22.26	112	200	Peak
10392.00	33.30	10.70	44.00	54.00	-10.00	237	200	Average
10392.00	43.86	10.70	54.56	74.00	-19.44	237	200	Peak

966Chamber_C at 3Meter / Vertical

Freq. MHz	Reading dBuV	C.F. dB/m	Result dBuV/m	Limit dBuV/m	Margin dB	Azimuth deg	Height cm	Remark
1580.00	49.79	-3.06	46.73	74.00	-27.27	28	100	Peak
2900.00	49.40	1.30	50.70	74.00	-23.30	309	100	Peak
3935.00	48.87	3.39	52.26	74.00	-21.74	283	300	Peak
5395.00	46.10	7.45	53.55	74.00	-20.45	91	150	Peak
6948.00	41.33	8.25	49.58	74.00	-24.42	295	100	Peak
9336.00	41.09	9.96	51.05	74.00	-22.95	34	100	Peak
10368.00	33.96	10.72	44.68	54.00	-9.32	175	100	Average
10368.00	43.33	10.72	54.05	74.00	-19.95	175	100	Peak

Remark:

1. Measuring frequencies from 1 GHz to the 10th harmonic of highest fundamental frequency.
2. Average test would be performed if the peak result were greater than the average limit.
3. Measurements above show only up to 6 maximum emissions noted, or would be lesser, with " N/A " remark, if no specific emissions from the EUT are recorded (ie: margin>20dB from the applicable limit) and considered that's already beyond the background noise floor.
4. Result = Reading + Correction Factor
 Margin = Result – Limit
 Remark Peak = Result(PK) – Limit(PK)
 Remark AVG = Result(AV) – Limit(AV)

Product Name	AC1200 Wireless Dual Band VDSL2 Gigabit VoIP IAD	Test By	Crystal Wu
Test Model	DL4480V	Test Date	2016/06/22
Test Mode	UNII Band 1 / IEEE 802.11ac VHT40 NSS1/MCS0 Mode TX / CH High	Temp. & Humidity	20°C, 53%

966Chamber_C at 3Meter / Horizontal

Freq. MHz	Reading dBuV	C.F. dB/m	Result dBuV/m	Limit dBuV/m	Margin dB	Azimuth deg	Height cm	Remark
1500.00	51.49	-3.28	48.21	74.00	-25.79	169	100	Peak
4090.00	49.20	3.83	53.03	74.00	-20.97	17	300	Peak
5150.00	39.67	6.95	46.62	54.00	-7.38	143	150	Average
5150.00	50.77	6.95	57.72	74.00	-16.28	143	150	Peak
5350.00	38.61	7.36	45.97	54.00	-8.03	359	200	Average
5350.00	46.85	7.36	54.21	74.00	-19.79	359	200	Peak
7728.00	42.28	8.05	50.33	74.00	-23.67	229	200	Peak
10464.00	33.12	10.64	43.76	54.00	-10.24	238	200	Average
10464.00	44.48	10.64	55.12	74.00	-18.88	238	200	Peak
15684.00	34.63	16.66	51.29	54.00	-2.71	228	100	Average
15684.00	50.48	16.66	67.14	74.00	-6.86	228	100	Peak

966Chamber_C at 3Meter / Vertical

Freq. MHz	Reading dBuV	C.F. dB/m	Result dBuV/m	Limit dBuV/m	Margin dB	Azimuth deg	Height cm	Remark
2590.00	49.87	0.26	50.13	74.00	-23.87	306	400	Peak
4065.00	48.86	3.76	52.62	74.00	-21.38	69	250	Peak
5150.00	40.67	6.95	47.62	54.00	-6.38	73	150	Average
5150.00	53.49	6.95	60.44	74.00	-13.56	73	150	Peak
5350.00	38.72	7.36	46.08	54.00	-7.92	153	100	Average
5350.00	46.96	7.36	54.32	74.00	-19.68	153	100	Peak
8712.00	40.98	8.78	49.76	74.00	-24.24	136	200	Peak
10464.00	42.07	10.64	52.71	74.00	-21.29	189	100	Peak
15696.00	36.28	16.69	52.97	54.00	-1.03	177	200	Average
15696.00	48.04	16.69	64.73	74.00	-9.27	177	200	Peak

Remark:

1. Measuring frequencies from 1 GHz to the 10th harmonic of highest fundamental frequency.
2. Average test would be performed if the peak result were greater than the average limit.
3. Measurements above show only up to 6 maximum emissions noted, or would be lesser, with "N/A" remark, if no specific emissions from the EUT are recorded (ie: margin>20dB from the applicable limit) and considered that's already beyond the background noise floor.
4. Result = Reading + Correction Factor
 Margin = Result - Limit
 Remark Peak = Result(PK) - Limit(PK)
 Remark AVG = Result(AV) - Limit(AV)

Product Name	AC1200 Wireless Dual Band VDSL2 Gigabit VoIP IAD	Test By	Crystal Wu
Test Model	DL4480V	Test Date	2016/06/22
Test Mode	UNII Band 1 / IEEE 802.11ac VHT80 NSS1/MCS0 Mode TX / CH Low	Temp. & Humidity	20°C, 53%

966Chamber_C at 3Meter / Horizontal

Freq. MHz	Reading dBuV	C.F. dB/m	Result dBuV/m	Limit dBuV/m	Margin dB	Azimuth deg	Height cm	Remark
1500.00	46.22	-3.69	42.53	74.00	-31.47	163	100	Peak
5350.00	41.06	7.92	48.98	54.00	-5.02	229	200	Average
5350.00	52.74	7.92	60.66	74.00	-13.34	229	200	Peak
7776.00	41.82	7.93	49.75	74.00	-24.25	233	200	Peak
10416.00	42.28	10.68	52.96	74.00	-21.04	171	200	Peak
15660.00	32.88	16.62	49.50	54.00	-4.50	248	200	Average
15660.00	44.40	16.62	61.02	74.00	-12.98	248	200	Peak

966Chamber_C at 3Meter / Vertical

Freq. MHz	Reading dBuV	C.F. dB/m	Result dBuV/m	Limit dBuV/m	Margin dB	Azimuth deg	Height cm	Remark
1500.00	46.49	-3.69	42.80	74.00	-31.20	160	150	Peak
5350.00	41.98	7.92	49.90	54.00	-4.10	235	200	Average
5350.00	54.62	7.92	62.54	74.00	-11.46	235	200	Peak
6996.00	42.29	8.26	50.55	74.00	-23.45	206	100	Peak
8544.00	41.73	8.54	50.27	74.00	-23.73	302	200	Peak
10116.00	41.66	10.93	52.59	74.00	-21.41	5	200	Peak

Remark:

1. Measuring frequencies from 1 GHz to the 10th harmonic of highest fundamental frequency.
2. Average test would be performed if the peak result were greater than the average limit.
3. Measurements above show only up to 6 maximum emissions noted, or would be lesser, with "N/A" remark, if no specific emissions from the EUT are recorded (ie: margin>20dB from the applicable limit) and considered that's already beyond the background noise floor.
4. Result = Reading + Correction Factor
 Margin = Result - Limit
 Remark Peak = Result(PK) - Limit(PK)
 Remark AVG = Result(AV) - Limit(AV)

Product Name	AC1200 Wireless Dual Band VDSL2 Gigabit VoIP IAD	Test By	Audi Chang
Test Model	DL4480V	Test Date	2016/06/23
Test Mode	UNII Band 3 / IEEE 802.11a Mode TX / CH Low	Temp. & Humidity	20°C, 53%

966Chamber_C at 3Meter / Horizontal

Freq. MHz	Reading dBuV	C.F. dB/m	Result dBuV/m	Limit dBuV/m	Margin dB	Azimuth deg	Height cm	Remark
1500.00	51.86	-3.69	48.17	74.00	-25.83	148	100	Peak
3110.00	51.02	1.20	52.22	74.00	-21.78	93	100	Peak
5465.00	38.95	8.33	47.28	54.00	-6.72	259	100	Average
5465.00	47.14	8.33	55.47	74.00	-18.53	259	100	Peak
7032.00	41.85	8.28	50.13	74.00	-23.87	59	200	Peak
9336.00	42.02	9.96	51.98	74.00	-22.02	121	200	Peak
10248.00	42.34	10.82	53.16	74.00	-20.84	357	100	Peak

966Chamber_C at 3Meter / Vertical

Freq. MHz	Reading dBuV	C.F. dB/m	Result dBuV/m	Limit dBuV/m	Margin dB	Azimuth deg	Height cm	Remark
2550.00	50.71	-0.34	50.37	74.00	-23.63	257	100	Peak
3115.00	50.63	1.21	51.84	74.00	-22.16	214	200	Peak
5465.00	38.21	8.33	46.54	54.00	-7.46	156	200	Average
5465.00	46.78	8.33	55.11	74.00	-18.89	156	200	Peak
6348.00	40.64	8.46	49.10	74.00	-24.90	157	200	Peak
9240.00	42.02	9.74	51.76	74.00	-22.24	168	200	Peak
10104.00	42.11	10.94	53.05	74.00	-20.95	275	200	Peak

Remark:

1. Measuring frequencies from 1 GHz to the 10th harmonic of highest fundamental frequency.
2. Average test would be performed if the peak result were greater than the average limit.
3. Measurements above show only up to 6 maximum emissions noted, or would be lesser, with "N/A" remark, if no specific emissions from the EUT are recorded (ie: margin>20dB from the applicable limit) and considered that's already beyond the background noise floor.
4. $Result = Reading + Correction\ Factor$
 $Margin = Result - Limit$
 $Remark\ Peak = Result(PK) - Limit(PK)$
 $Remark\ AVG = Result(AV) - Limit(AV)$

Product Name	AC1200 Wireless Dual Band VDSL2 Gigabit VoIP IAD	Test By	Audi Chang
Test Model	DL4480V	Test Date	2016/06/23
Test Mode	UNII Band 3 / IEEE 802.11a Mode TX / CH Middle	Temp. & Humidity	20°C, 53%

966Chamber_C at 3Meter / Horizontal

Freq. MHz	Reading dBuV	C.F. dB/m	Result dBuV/m	Limit dBuV/m	Margin dB	Azimuth deg	Height cm	Remark
2295.00	50.40	-1.25	49.15	74.00	-24.85	206	100	Peak
3130.00	50.15	1.25	51.40	74.00	-22.60	187	100	Peak
5455.00	39.25	8.30	47.55	54.00	-6.45	142	100	Average
5455.00	49.25	8.30	57.55	74.00	-16.45	142	100	Peak
9336.00	40.90	9.96	50.86	74.00	-23.14	340	200	Peak
11568.00	34.45	12.58	47.03	54.00	-6.97	199	200	Average
11568.00	46.07	12.58	58.65	74.00	-15.35	199	200	Peak
17364.00	34.04	18.88	52.92	54.00	-1.08	93	200	Average
17364.00	47.36	18.88	66.24	74.00	-7.76	93	200	Peak

966Chamber_C at 3Meter / Vertical

Freq. MHz	Reading dBuV	C.F. dB/m	Result dBuV/m	Limit dBuV/m	Margin dB	Azimuth deg	Height cm	Remark
2565.00	50.15	-0.30	49.85	74.00	-24.15	120	200	Peak
3125.00	50.95	1.24	52.19	74.00	-21.81	97	100	Peak
5400.00	38.56	8.10	46.66	54.00	-7.34	97	200	Average
5400.00	49.34	8.10	57.44	74.00	-16.56	97	200	Peak
8532.00	41.91	8.53	50.44	74.00	-23.56	257	100	Peak
11568.00	30.42	12.58	43.00	54.00	-11.00	9	100	Average
11568.00	43.03	12.58	55.61	74.00	-18.39	9	100	Peak
17340.00	28.56	18.91	47.47	54.00	-6.53	359	100	Average
17340.00	42.41	18.91	61.32	74.00	-12.68	359	100	Peak

Remark:

1. Measuring frequencies from 1 GHz to the 10th harmonic of highest fundamental frequency.
2. Average test would be performed if the peak result were greater than the average limit.
3. Measurements above show only up to 6 maximum emissions noted, or would be lesser, with "N/A" remark, if no specific emissions from the EUT are recorded (ie: margin>20dB from the applicable limit) and considered that's already beyond the background noise floor.
4. Result = Reading + Correction Factor
 Margin = Result - Limit
 Remark Peak = Result(PK) - Limit(PK)
 Remark AVG = Result(AV) - Limit(AV)

Product Name	AC1200 Wireless Dual Band VDSL2 Gigabit VoIP IAD	Test By	Audi Chang
Test Model	DL4480V	Test Date	2016/06/23
Test Mode	UNII Band 3 / IEEE 802.11a Mode TX / CH High	Temp. & Humidity	20°C, 53%

966Chamber_C at 3Meter / Horizontal

Freq. MHz	Reading dBuV	C.F. dB/m	Result dBuV/m	Limit dBuV/m	Margin dB	Azimuth deg	Height cm	Remark
2575.00	49.86	-0.27	49.59	74.00	-24.41	82	200	Peak
3095.00	50.52	1.16	51.68	74.00	-22.32	161	100	Peak
5455.00	37.37	8.30	45.67	54.00	-8.33	138	200	Average
5455.00	47.37	8.30	55.67	74.00	-18.33	138	200	Peak
9552.00	40.96	10.41	51.37	74.00	-22.63	63	200	Peak
11640.00	35.06	12.70	47.76	54.00	-6.24	151	200	Average
11640.00	48.15	12.70	60.85	74.00	-13.15	151	200	Peak
17472.00	32.07	18.74	50.81	54.00	-3.19	232	200	Average
17472.00	49.27	18.74	68.01	74.00	-5.99	232	200	Peak

966Chamber_C at 3Meter / Vertical

Freq. MHz	Reading dBuV	C.F. dB/m	Result dBuV/m	Limit dBuV/m	Margin dB	Azimuth deg	Height cm	Remark
2175.00	51.46	-1.70	49.76	74.00	-24.24	85	200	Peak
3150.00	51.60	1.31	52.91	74.00	-21.09	117	200	Peak
5465.00	37.33	8.33	45.66	54.00	-8.34	163	100	Average
5465.00	47.34	8.33	55.67	74.00	-18.33	163	100	Peak
9372.00	40.92	10.05	50.97	74.00	-23.03	201	100	Peak
11652.00	33.44	12.72	46.16	54.00	-7.84	184	200	Average
11652.00	44.54	12.72	57.26	74.00	-16.74	184	200	Peak
17472.00	33.63	18.74	52.37	54.00	-1.63	158	100	Average
17472.00	46.41	18.74	65.15	74.00	-8.85	158	100	Peak

Remark:

1. Measuring frequencies from 1 GHz to the 10th harmonic of highest fundamental frequency.
2. Average test would be performed if the peak result were greater than the average limit.
3. Measurements above show only up to 6 maximum emissions noted, or would be lesser, with " N/A " remark, if no specific emissions from the EUT are recorded (ie: margin>20dB from the applicable limit) and considered that's already beyond the background noise floor.
4. Result = Reading + Correction Factor
 Margin = Result – Limit
 Remark Peak = Result(PK) – Limit(PK)
 Remark AVG = Result(AV) – Limit(AV)

Product Name	AC1200 Wireless Dual Band VDSL2 Gigabit VoIP IAD	Test By	Audi Chang
Test Model	DL4480V	Test Date	2016/06/23
Test Mode	UNII Band 3 / IEEE 802.11ac VHT20 NSS1/MCS0 Mode TX / CH Low	Temp. & Humidity	20°C, 53%

966Chamber_C at 3Meter / Horizontal

Freq. MHz	Reading dBuV	C.F. dB/m	Result dBuV/m	Limit dBuV/m	Margin dB	Azimuth deg	Height cm	Remark
1500.00	52.55	-3.69	48.86	74.00	-25.14	149	100	Peak
3085.00	50.56	1.13	51.69	74.00	-22.31	261	100	Peak
5465.00	38.35	8.33	46.68	54.00	-7.32	65	100	Average
5465.00	47.36	8.33	55.69	74.00	-18.31	65	100	Peak
8556.00	42.20	8.56	50.76	74.00	-23.24	244	100	Peak
11496.00	33.35	12.46	45.81	54.00	-8.19	193	200	Average
11496.00	45.26	12.46	57.72	74.00	-16.28	193	200	Peak
17232.00	31.82	19.05	50.87	54.00	-3.13	92	200	Average
17232.00	45.10	19.05	64.15	74.00	-9.85	92	200	Peak

966Chamber_C at 3Meter / Vertical

Freq. MHz	Reading dBuV	C.F. dB/m	Result dBuV/m	Limit dBuV/m	Margin dB	Azimuth deg	Height cm	Remark
2395.00	49.53	-0.87	48.66	74.00	-25.34	281	100	Peak
3155.00	50.63	1.32	51.95	74.00	-22.05	234	200	Peak
5460.00	38.29	8.32	46.61	54.00	-7.39	197	200	Average
5460.00	48.29	8.32	56.61	74.00	-17.39	197	200	Peak
9348.00	40.79	9.99	50.78	74.00	-23.22	212	200	Peak
11496.00	32.22	12.46	44.68	54.00	-9.32	197	200	Average
11496.00	43.32	12.46	55.78	74.00	-18.22	197	200	Peak
17232.00	28.73	19.05	47.78	54.00	-6.22	137	200	Average
17232.00	42.32	19.05	61.37	74.00	-12.63	137	200	Peak

Remark:

1. Measuring frequencies from 1 GHz to the 10th harmonic of highest fundamental frequency.
2. Average test would be performed if the peak result were greater than the average limit.
3. Measurements above show only up to 6 maximum emissions noted, or would be lesser, with " N/A " remark, if no specific emissions from the EUT are recorded (ie: margin>20dB from the applicable limit) and considered that's already beyond the background noise floor.
4. Result = Reading + Correction Factor
 Margin = Result - Limit
 Remark Peak = Result(PK) - Limit(PK)
 Remark AVG = Result(AV) - Limit(AV)

Product Name	AC1200 Wireless Dual Band VDSL2 Gigabit VoIP IAD	Test By	Audi Chang
Test Model	DL4480V	Test Date	2016/06/23
Test Mode	UNII Band 3 / IEEE 802.11ac VHT20 NSS1/MCS0 Mode TX / CH Middle	Temp. & Humidity	20°C, 53%

966Chamber_C at 3Meter / Horizontal

Freq. MHz	Reading dBuV	C.F. dB/m	Result dBuV/m	Limit dBuV/m	Margin dB	Azimuth deg	Height cm	Remark
1500.00	50.76	-3.69	47.07	74.00	-26.93	162	100	Peak
3100.00	50.53	1.17	51.70	74.00	-22.30	208	200	Peak
5460.00	38.90	8.32	47.22	54.00	-6.78	305	100	Average
5460.00	47.90	8.32	56.22	74.00	-17.78	305	100	Peak
8460.00	41.81	8.39	50.20	74.00	-23.80	38	100	Peak
11568.00	37.50	12.58	50.08	54.00	-3.92	185	200	Average
11568.00	50.94	12.58	63.52	74.00	-10.48	185	200	Peak
17352.00	35.06	18.90	53.96	54.00	-0.04	224	200	Average
17352.00	49.79	18.90	68.69	74.00	-5.31	224	200	Peak

966Chamber_C at 3Meter / Vertical

Freq. MHz	Reading dBuV	C.F. dB/m	Result dBuV/m	Limit dBuV/m	Margin dB	Azimuth deg	Height cm	Remark
1500.00	51.19	-3.69	47.50	74.00	-26.50	182	100	Peak
3225.00	50.34	1.52	51.86	74.00	-22.14	302	100	Peak
5470.00	38.26	8.35	46.61	54.00	-7.39	92	100	Average
5470.00	48.27	8.35	56.62	74.00	-17.38	92	100	Peak
8532.00	41.70	8.53	50.23	74.00	-23.77	296	200	Peak
11568.00	36.72	12.58	49.30	54.00	-4.70	177	100	Average
11568.00	49.75	12.58	62.33	74.00	-11.67	177	100	Peak
17364.00	29.90	18.88	48.78	54.00	-5.22	207	100	Average
17364.00	44.37	18.88	63.25	74.00	-10.75	207	100	Peak

Remark:

1. Measuring frequencies from 1 GHz to the 10th harmonic of highest fundamental frequency.
2. Average test would be performed if the peak result were greater than the average limit.
3. Measurements above show only up to 6 maximum emissions noted, or would be lesser, with "N/A" remark, if no specific emissions from the EUT are recorded (ie: margin>20dB from the applicable limit) and considered that's already beyond the background noise floor.
4. Result = Reading + Correction Factor
 Margin = Result - Limit
 Remark Peak = Result(PK) - Limit(PK)
 Remark AVG = Result(AV) - Limit(AV)

Product Name	AC1200 Wireless Dual Band VDSL2 Gigabit VoIP IAD	Test By	Audi Chang
Test Model	DL4480V	Test Date	2016/06/23
Test Mode	UNII Band 3 / IEEE 802.11ac VHT20 NSS1/MCS0 Mode TX / CH High	Temp. & Humidity	20°C, 53%

966Chamber_C at 3Meter / Horizontal

Freq. MHz	Reading dBuV	C.F. dB/m	Result dBuV/m	Limit dBuV/m	Margin dB	Azimuth deg	Height cm	Remark
2215.00	50.72	-1.55	49.17	74.00	-24.83	200	100	Peak
3190.00	50.50	1.42	51.92	74.00	-22.08	141	200	Peak
5465.00	38.54	8.33	46.87	54.00	-7.13	183	100	Average
5465.00	49.21	8.33	57.54	74.00	-16.46	183	100	Peak
10020.00	40.60	11.01	51.61	74.00	-22.39	76	200	Peak
11640.00	38.24	12.70	50.94	54.00	-3.06	176	200	Average
11640.00	50.94	12.70	63.64	74.00	-10.36	176	200	Peak
17472.00	34.32	18.74	53.06	54.00	-0.94	223	200	Average
17472.00	49.27	18.74	68.01	74.00	-5.99	223	200	Peak

966Chamber_C at 3Meter / Vertical

Freq. MHz	Reading dBuV	C.F. dB/m	Result dBuV/m	Limit dBuV/m	Margin dB	Azimuth deg	Height cm	Remark
2165.00	51.17	-1.73	49.44	74.00	-24.56	269	100	Peak
3270.00	50.15	1.65	51.80	74.00	-22.20	173	100	Peak
5460.00	38.97	8.32	47.29	54.00	-6.71	266	200	Average
5460.00	47.97	8.32	56.29	74.00	-17.71	266	200	Peak
10164.00	41.67	10.89	52.56	74.00	-21.44	206	100	Peak
11652.00	38.23	12.72	50.95	54.00	-3.05	180	100	Average
11652.00	48.07	12.72	60.79	74.00	-13.21	180	100	Peak
17460.00	31.84	18.75	50.59	54.00	-3.41	133	200	Average
17460.00	45.25	18.75	64.00	74.00	-10.00	133	200	Peak

Remark:

1. Measuring frequencies from 1 GHz to the 10th harmonic of highest fundamental frequency.
2. Average test would be performed if the peak result were greater than the average limit.
3. Measurements above show only up to 6 maximum emissions noted, or would be lesser, with "N/A" remark, if no specific emissions from the EUT are recorded (ie: margin>20dB from the applicable limit) and considered that's already beyond the background noise floor.

4. Result = Reading + Correction Factor
 Margin = Result – Limit
 Remark Peak = Result(PK) – Limit(PK)
 Remark AVG = Result(AV) – Limit(AV)

Product Name	AC1200 Wireless Dual Band VDSL2 Gigabit VoIP IAD	Test By	Audi Chang
Test Model	DL4480V	Test Date	2016/06/23
Test Mode	UNII Band 3 / IEEE 802.11ac VHT40 NSS1/MCS0 Mode TX / CH Low	Temp. & Humidity	20°C, 53%

966Chamber_C at 3Meter / Horizontal

Freq. MHz	Reading dBuV	C.F. dB/m	Result dBuV/m	Limit dBuV/m	Margin dB	Azimuth deg	Height cm	Remark
2290.00	50.36	-1.27	49.09	74.00	-24.91	0	200	Peak
3090.00	50.79	1.14	51.93	74.00	-22.07	3	100	Peak
5465.00	38.31	8.33	46.64	54.00	-7.36	62	200	Average
5465.00	47.32	8.33	55.65	74.00	-18.35	62	200	Peak
8544.00	42.30	8.54	50.84	74.00	-23.16	355	200	Peak
11508.00	35.46	12.47	47.93	54.00	-6.07	197	200	Average
11508.00	45.83	12.47	58.30	74.00	-15.70	197	200	Peak
17256.00	31.79	19.02	50.81	54.00	-3.19	251	200	Average
17256.00	44.78	19.02	63.80	74.00	-10.20	251	200	Peak

966Chamber_C at 3Meter / Vertical

Freq. MHz	Reading dBuV	C.F. dB/m	Result dBuV/m	Limit dBuV/m	Margin dB	Azimuth deg	Height cm	Remark
2735.00	49.74	0.16	49.90	74.00	-24.10	85	100	Peak
3110.00	51.29	1.20	52.49	74.00	-21.51	176	200	Peak
5465.00	38.12	8.33	46.45	54.00	-7.55	299	200	Average
5465.00	48.13	8.33	56.46	74.00	-17.54	299	200	Peak
9348.00	41.29	9.99	51.28	74.00	-22.72	79	100	Peak
11508.00	34.70	12.47	47.17	54.00	-6.83	173	100	Average
11508.00	44.37	12.47	56.84	74.00	-17.16	173	100	Peak
17280.00	30.34	18.99	49.33	54.00	-4.67	137	200	Average
17280.00	42.58	18.99	61.57	74.00	-12.43	137	200	Peak

Remark:

1. Measuring frequencies from 1 GHz to the 10th harmonic of highest fundamental frequency.
2. Average test would be performed if the peak result were greater than the average limit.
3. Measurements above show only up to 6 maximum emissions noted, or would be lesser, with "N/A" remark, if no specific emissions from the EUT are recorded (ie: margin>20dB from the applicable limit) and considered that's already beyond the background noise floor.
4. Result = Reading + Correction Factor
 Margin = Result - Limit
 Remark Peak = Result(PK) - Limit(PK)
 Remark AVG = Result(AV) - Limit(AV)

Product Name	AC1200 Wireless Dual Band VDSL2 Gigabit VoIP IAD	Test By	Audi Chang
Test Model	DL4480V	Test Date	2016/06/23
Test Mode	UNII Band 3 / IEEE 802.11ac VHT40 NSS1/MCS0 Mode TX / CH High	Temp. & Humidity	20°C, 53%

966Chamber_C at 3Meter / Horizontal

Freq. MHz	Reading dBuV	C.F. dB/m	Result dBuV/m	Limit dBuV/m	Margin dB	Azimuth deg	Height cm	Remark
2170.00	50.68	-1.71	48.97	74.00	-25.03	41	200	Peak
3020.00	50.68	0.95	51.63	74.00	-22.37	294	200	Peak
5390.00	37.71	8.06	45.77	54.00	-8.23	330	200	Average
5390.00	49.72	8.06	57.78	74.00	-16.22	330	200	Peak
8532.00	41.16	8.53	49.69	74.00	-24.31	208	100	Peak
11580.00	36.72	12.60	49.32	54.00	-4.68	204	200	Average
11580.00	46.25	12.60	58.85	74.00	-15.15	204	200	Peak
17376.00	30.39	18.86	49.25	54.00	-4.75	92	200	Average
17376.00	43.35	18.86	62.21	74.00	-11.79	92	200	Peak

966Chamber_C at 3Meter / Vertical

Freq. MHz	Reading dBuV	C.F. dB/m	Result dBuV/m	Limit dBuV/m	Margin dB	Azimuth deg	Height cm	Remark
2250.00	49.99	-1.41	48.58	74.00	-25.42	261	200	Peak
3115.00	50.30	1.21	51.51	74.00	-22.49	197	100	Peak
5465.00	38.42	8.33	46.75	54.00	-7.25	97	200	Average
5465.00	47.43	8.33	55.76	74.00	-18.24	97	200	Peak
9312.00	40.99	9.91	50.90	74.00	-23.10	58	100	Peak
11592.00	34.06	12.62	46.68	54.00	-7.32	171	100	Average
11592.00	45.10	12.62	57.72	74.00	-16.28	171	100	Peak
17316.00	29.37	18.94	48.31	54.00	-5.69	163	200	Average
17316.00	41.60	18.94	60.54	74.00	-13.46	163	200	Peak

Remark:

1. Measuring frequencies from 1 GHz to the 10th harmonic of highest fundamental frequency.
2. Average test would be performed if the peak result were greater than the average limit.
3. Measurements above show only up to 6 maximum emissions noted, or would be lesser, with "N/A" remark, if no specific emissions from the EUT are recorded (ie: margin>20dB from the applicable limit) and considered that's already beyond the background noise floor.

4. Result = Reading + Correction Factor
 Margin = Result – Limit
 Remark Peak = Result(PK) – Limit(PK)
 Remark AVG = Result(AV) – Limit(AV)

Product Name	AC1200 Wireless Dual Band VDSL2 Gigabit VoIP IAD	Test By	Audi Chang
Test Model	DL4480V	Test Date	2016/06/23
Test Mode	UNII Band 3 / IEEE 802.11ac VHT80 NSS1/MCS0 Mode TX / CH Low	Temp. & Humidity	20°C, 53%

966Chamber_C at 3Meter / Horizontal

Freq. MHz	Reading dBuV	C.F. dB/m	Result dBuV/m	Limit dBuV/m	Margin dB	Azimuth deg	Height cm	Remark
2645.00	50.23	-0.08	50.15	74.00	-23.85	97	200	Peak
3135.00	50.43	1.27	51.70	74.00	-22.30	145	200	Peak
5460.00	36.85	8.32	45.17	54.00	-8.83	22	200	Average
5460.00	48.48	8.32	56.80	74.00	-17.20	22	200	Peak
8628.00	41.17	8.66	49.83	74.00	-24.17	94	100	Peak
11556.00	34.94	12.56	47.50	54.00	-6.50	233	200	Average
11556.00	44.67	12.56	57.23	74.00	-16.77	233	200	Peak
17304.00	31.49	18.96	50.45	54.00	-3.55	218	200	Average
17304.00	42.31	18.96	61.27	74.00	-12.73	218	200	Peak

966Chamber_C at 3Meter / Vertical

Freq. MHz	Reading dBuV	C.F. dB/m	Result dBuV/m	Limit dBuV/m	Margin dB	Azimuth deg	Height cm	Remark
2280.00	50.23	-1.30	48.93	74.00	-25.07	159	100	Peak
2610.00	49.75	-0.18	49.57	74.00	-24.43	322	200	Peak
5465.00	36.28	8.33	44.61	54.00	-9.39	52	200	Average
5465.00	48.01	8.33	56.34	74.00	-17.66	52	200	Peak
8544.00	42.61	8.54	51.15	74.00	-22.85	265	100	Peak
11556.00	32.88	12.56	45.44	54.00	-8.56	176	100	Average
11556.00	42.24	12.56	54.80	74.00	-19.20	176	100	Peak
17280.00	30.61	18.99	49.60	54.00	-4.40	141	200	Average
17280.00	41.92	18.99	60.91	74.00	-13.09	141	200	Peak

Remark:

1. Measuring frequencies from 1 GHz to the 10th harmonic of highest fundamental frequency.
2. Average test would be performed if the peak result were greater than the average limit.
3. Measurements above show only up to 6 maximum emissions noted, or would be lesser, with " N/A " remark, if no specific emissions from the EUT are recorded (ie: margin>20dB from the applicable limit) and considered that's already beyond the background noise floor.
4. Result = Reading + Correction Factor
 Margin = Result – Limit
 Remark Peak = Result(PK) – Limit(PK)
 Remark AVG = Result(AV) – Limit(AV)

Restricted Band Edges

Detector Mode: Peak

Polarity: Horizontal

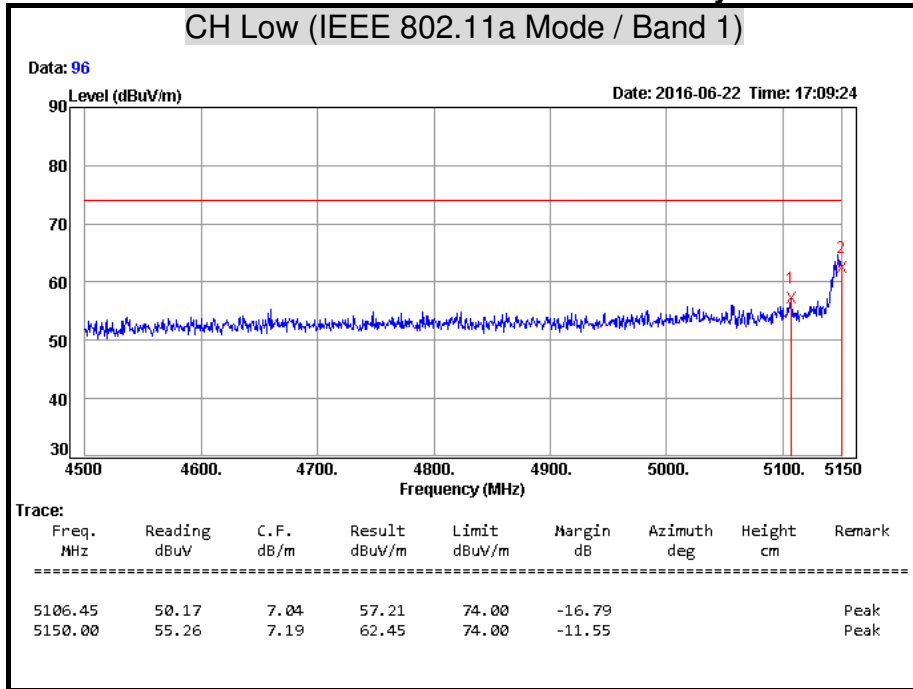

Detector Mode: Average

Polarity: Horizontal

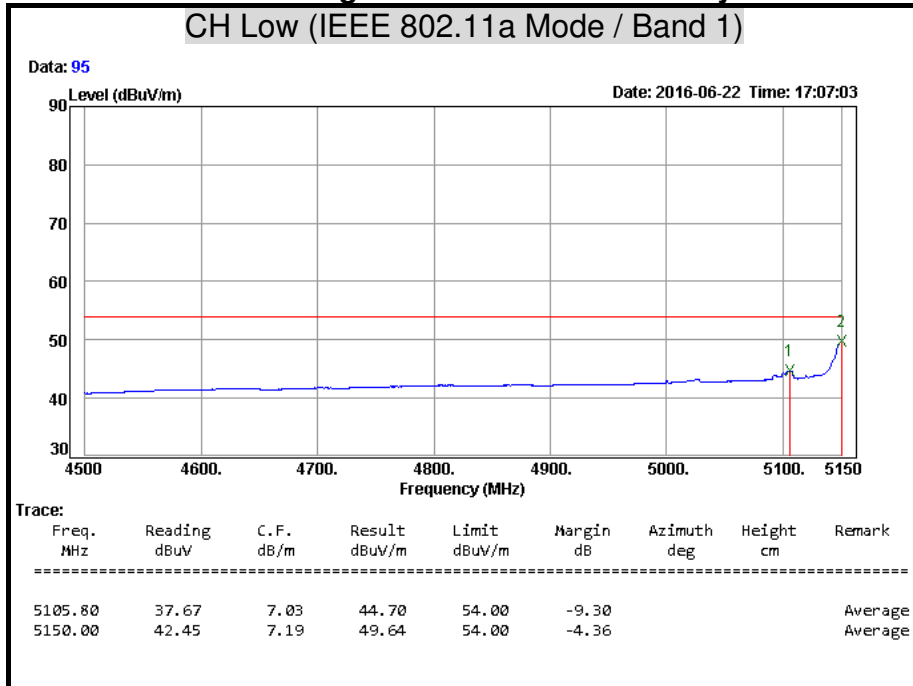

Detector Mode: Peak Polarity: Vertical

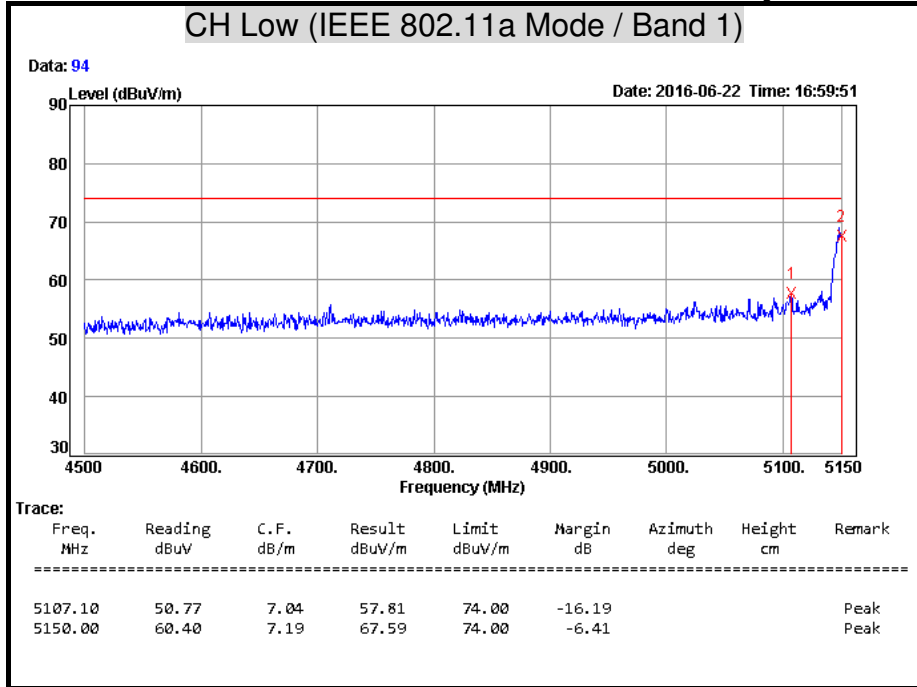

Detector Mode: Average Polarity: Vertical

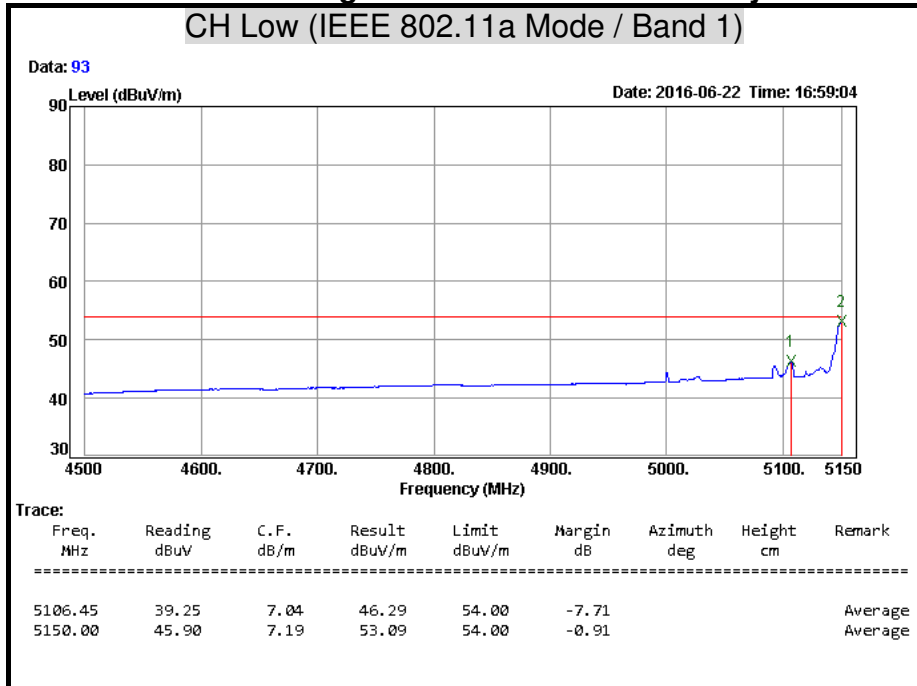

Detector Mode: Peak Polarity: Horizontal

CH Low (IEEE 802.11ac VHT20 NSS1/MCS0 Mode / Band 1)

Data: 92

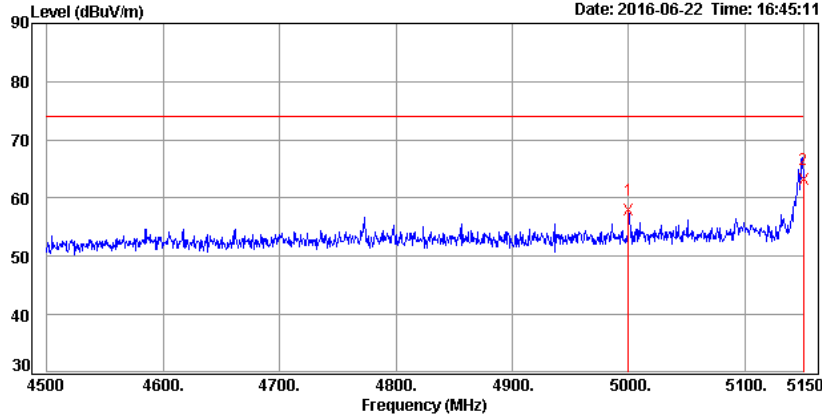

Trace:	Freq. MHz	Reading dBuV	C.F. dB/m	Result dBuV/m	Limit dBuV/m	Margin dB	Azimuth deg	Height cm	Remark
	4999.85	51.36	6.65	58.01	74.00	-15.99			Peak
	5150.00	56.01	7.19	63.20	74.00	-10.80			Peak

Detector Mode: Average Polarity: Horizontal

CH Low (IEEE 802.11ac VHT20 NSS1/MCS0 Mode / Band 1)

Data: 91

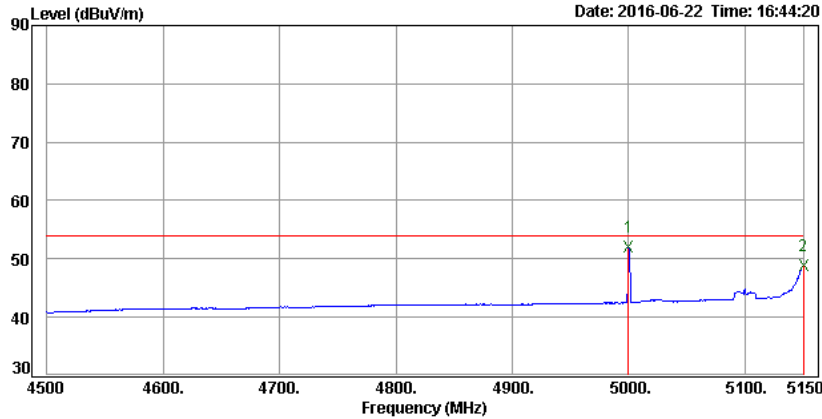

Trace:	Freq. MHz	Reading dBuV	C.F. dB/m	Result dBuV/m	Limit dBuV/m	Margin dB	Azimuth deg	Height cm	Remark
	4999.85	45.33	6.65	51.98	54.00	-2.02			Average
	5150.00	41.74	7.19	48.93	54.00	-5.07			Average

Detector Mode: Peak Polarity: Vertical

CH Low (IEEE 802.11ac VHT20 NSS1/MCS0 Mode / Band 1)

Data: 90

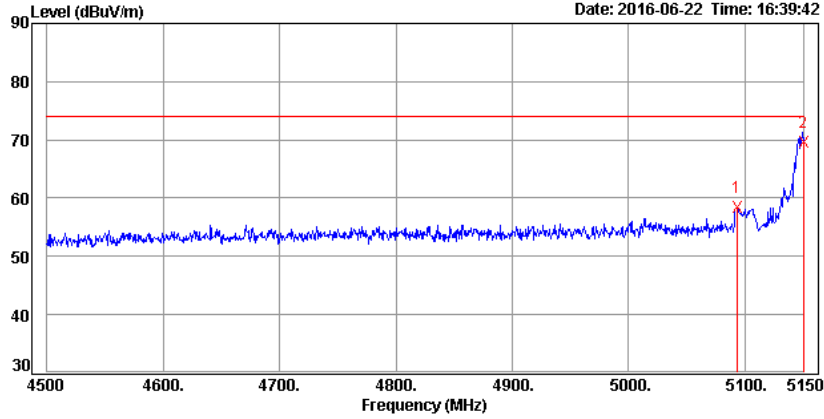

Trace:	Freq. MHz	Reading dBuV	C.F. dB/m	Result dBuV/m	Limit dBuV/m	Margin dB	Azimuth deg	Height cm	Remark
	5092.80	51.41	6.99	58.40	74.00	-15.60			Peak
	5150.00	62.49	7.19	69.68	74.00	-4.32			Peak

Detector Mode: Average Polarity: Vertical

CH Low (IEEE 802.11ac VHT20 NSS1/MCS0 Mode / Band 1)

Data: 89

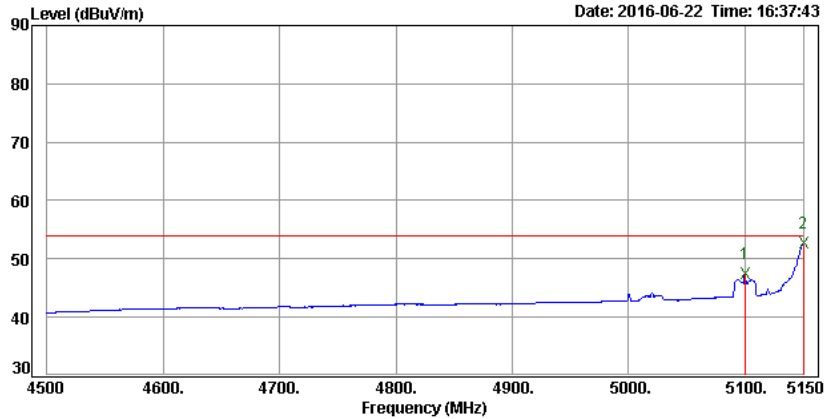

Trace:	Freq. MHz	Reading dBuV	C.F. dB/m	Result dBuV/m	Limit dBuV/m	Margin dB	Azimuth deg	Height cm	Remark
	5099.95	40.46	7.01	47.47	54.00	-6.53			Average
	5150.00	45.50	7.19	52.69	54.00	-1.31			Average

Detector Mode: Peak Polarity: Horizontal

CH Low (IEEE 802.11ac VHT40 NSS1/MCS0 Mode / Band 1)

Data: 88

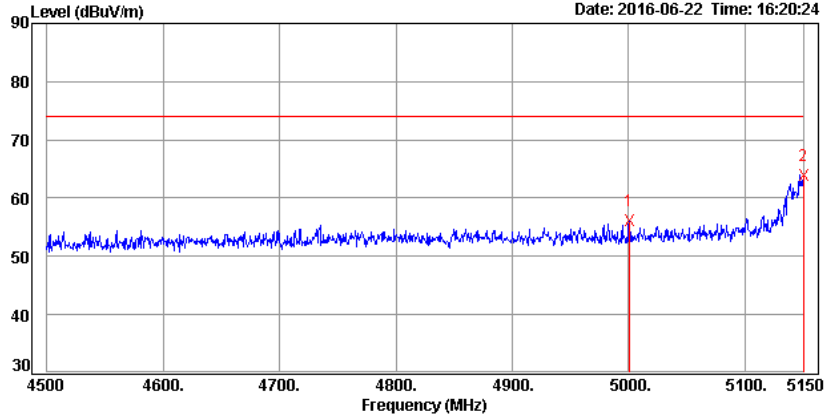

Trace:

Freq. MHz	Reading dBuV	C.F. dB/m	Result dBuV/m	Limit dBuV/m	Margin dB	Azimuth deg	Height cm	Remark
5000.50	49.44	6.65	56.09	74.00	-17.91			Peak
5150.00	56.79	7.19	63.98	74.00	-10.02			Peak

Detector Mode: Average Polarity: Horizontal

CH Low (IEEE 802.11ac VHT40 NSS1/MCS0 Mode / Band 1)

Data: 87

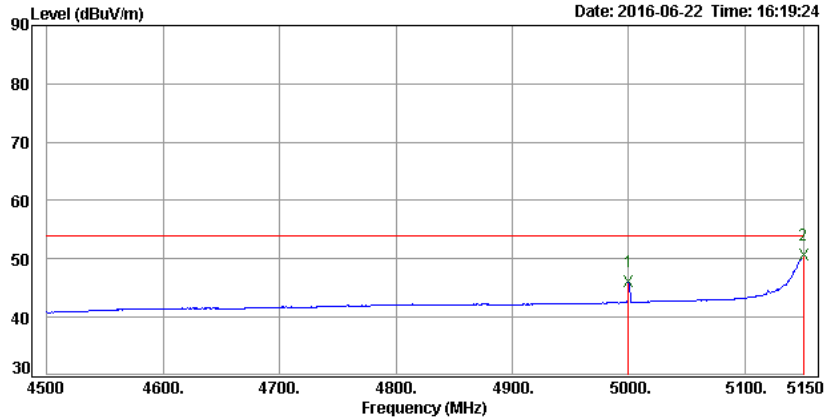

Trace:

Freq. MHz	Reading dBuV	C.F. dB/m	Result dBuV/m	Limit dBuV/m	Margin dB	Azimuth deg	Height cm	Remark
4999.85	39.32	6.65	45.97	54.00	-8.03			Average
5150.00	43.42	7.19	50.61	54.00	-3.39			Average

Detector Mode: Peak Polarity: Vertical

CH Low (IEEE 802.11ac VHT40 NSS1/MCS0 Mode / Band 1)

Data: 86

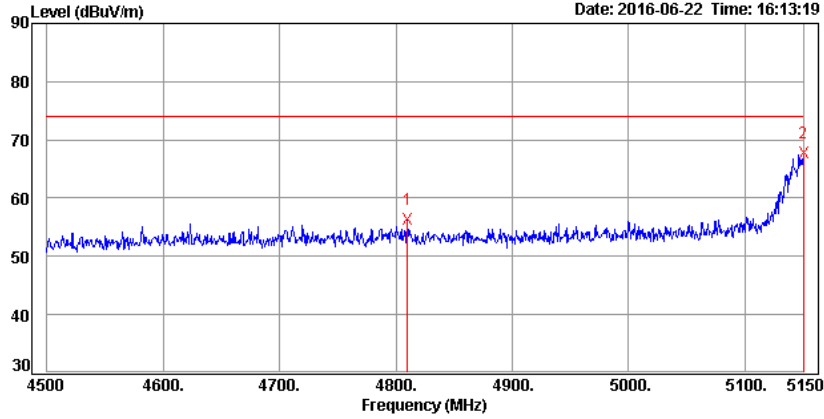

Trace:	Freq. MHz	Reading dBuV	C.F. dB/m	Result dBuV/m	Limit dBuV/m	Margin dB	Azimuth deg	Height cm	Remark
	4810.05	50.40	5.91	56.31	74.00	-17.69			Peak
	5150.00	60.56	7.19	67.75	74.00	-6.25			Peak

Detector Mode: Average Polarity: Vertical

CH Low (IEEE 802.11ac VHT40 NSS1/MCS0 Mode / Band 1)

Data: 85

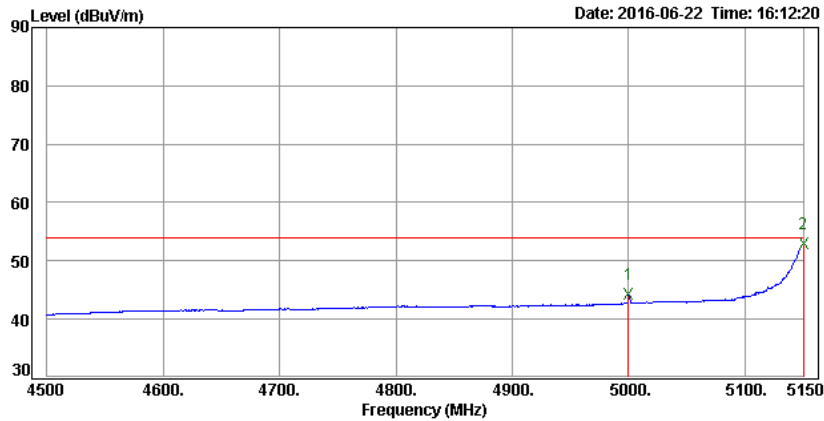

Trace:	Freq. MHz	Reading dBuV	C.F. dB/m	Result dBuV/m	Limit dBuV/m	Margin dB	Azimuth deg	Height cm	Remark
	4999.85	37.60	6.65	44.25	54.00	-9.75			Average
	5150.00	45.73	7.19	52.92	54.00	-1.08			Average

Detector Mode: Peak Polarity: Horizontal

CH Low (IEEE 802.11ac VHT80 NSS1/MCS0 Mode / Band 1)

Data: 84

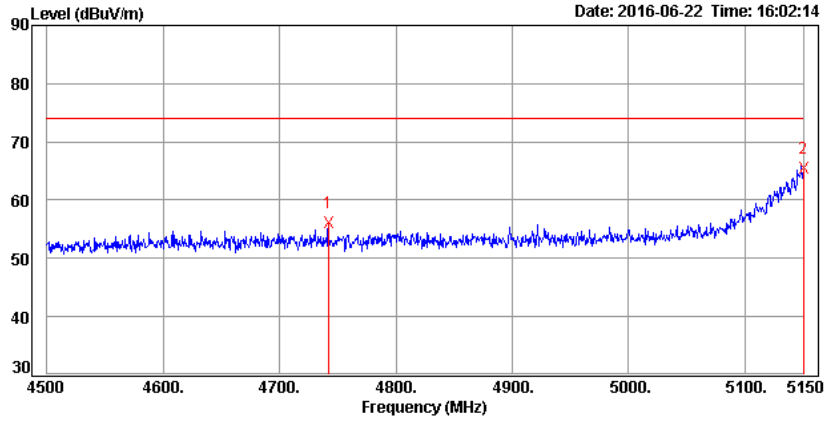

Trace:

Freq. MHz	Reading dBuV	C.F. dB/m	Result dBuV/m	Limit dBuV/m	Margin dB	Azimuth deg	Height cm	Remark
4741.80	50.51	5.64	56.15	74.00	-17.85			Peak
5150.00	58.23	7.19	65.42	74.00	-8.58			Peak

Detector Mode: Average Polarity: Horizontal

CH Low (IEEE 802.11ac VHT80 NSS1/MCS0 Mode / Band 1)

Data: 83

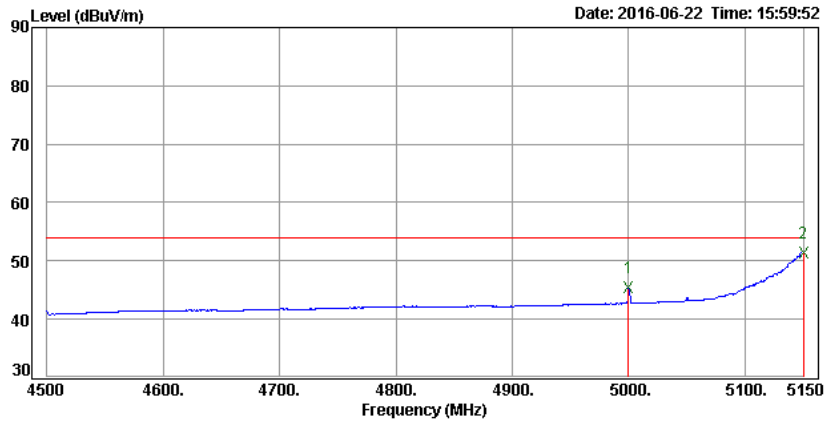

Trace:

Freq. MHz	Reading dBuV	C.F. dB/m	Result dBuV/m	Limit dBuV/m	Margin dB	Azimuth deg	Height cm	Remark
4999.85	38.68	6.65	45.33	54.00	-8.67			Average
5150.00	44.21	7.19	51.40	54.00	-2.60			Average

Detector Mode: Peak Polarity: Vertical

CH Low (IEEE 802.11ac VHT80 NSS1/MCS0 Mode / Band 1)

Data: 82

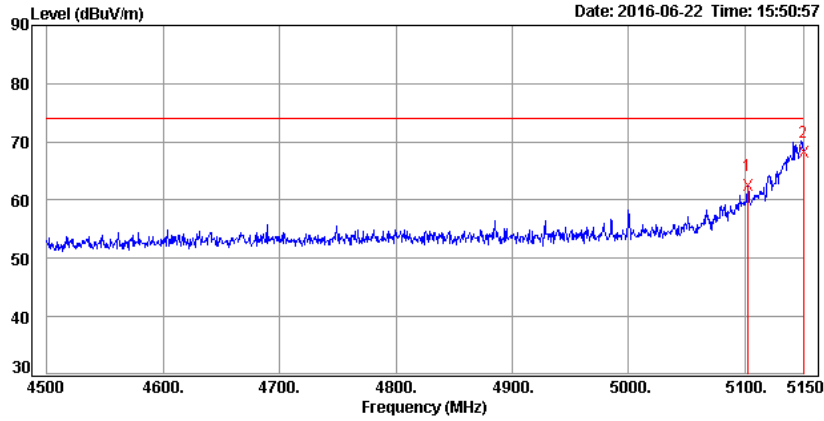

Trace:	Freq. MHz	Reading dBuV	C.F. dB/m	Result dBuV/m	Limit dBuV/m	Margin dB	Azimuth deg	Height cm	Remark
	5101.90	55.39	7.02	62.41	74.00	-11.59			Peak
	5150.00	61.02	7.19	68.21	74.00	-5.79			Peak

Detector Mode: Average Polarity: Vertical

CH Low (IEEE 802.11ac VHT80 NSS1/MCS0 Mode / Band 1)

Data: 81

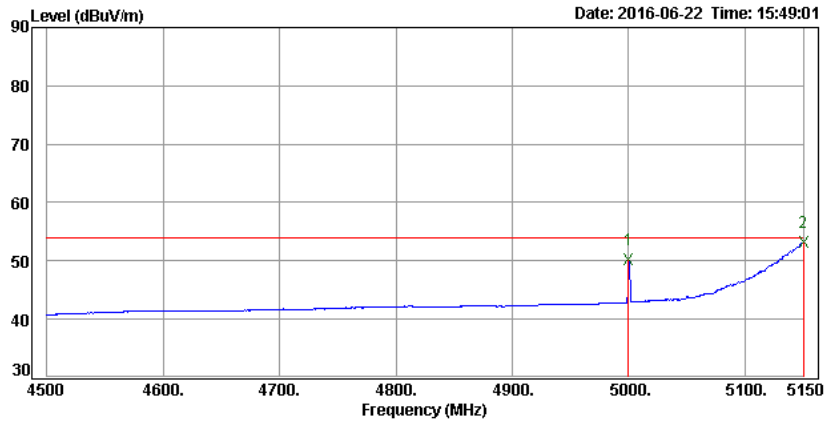

Trace:	Freq. MHz	Reading dBuV	C.F. dB/m	Result dBuV/m	Limit dBuV/m	Margin dB	Azimuth deg	Height cm	Remark
	4999.85	43.64	6.65	50.29	54.00	-3.71			Average
	5150.00	45.97	7.19	53.16	54.00	-0.84			Average

Polarity: Horizontal

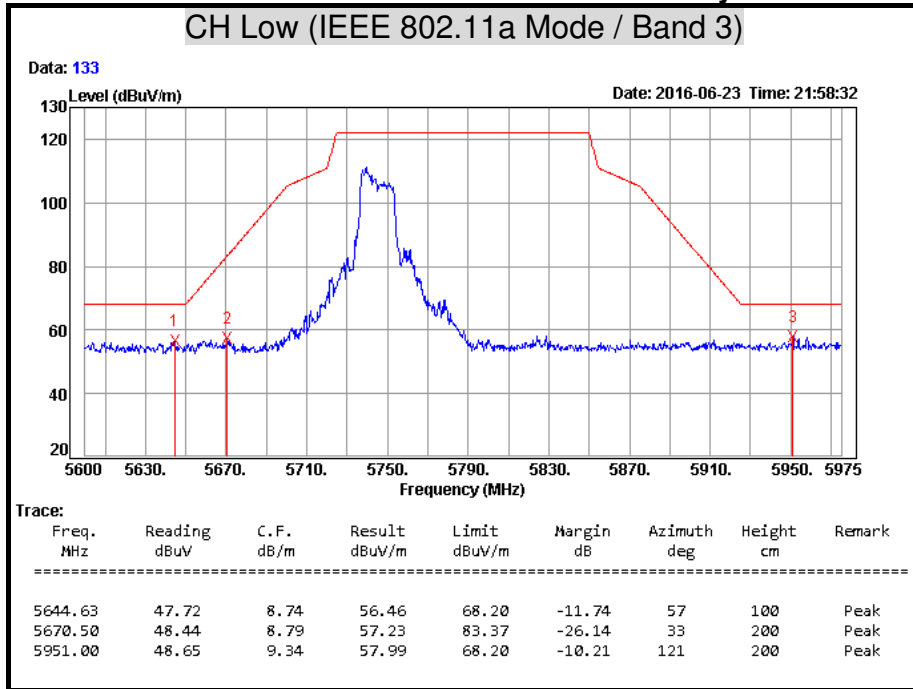

Polarity: Vertical

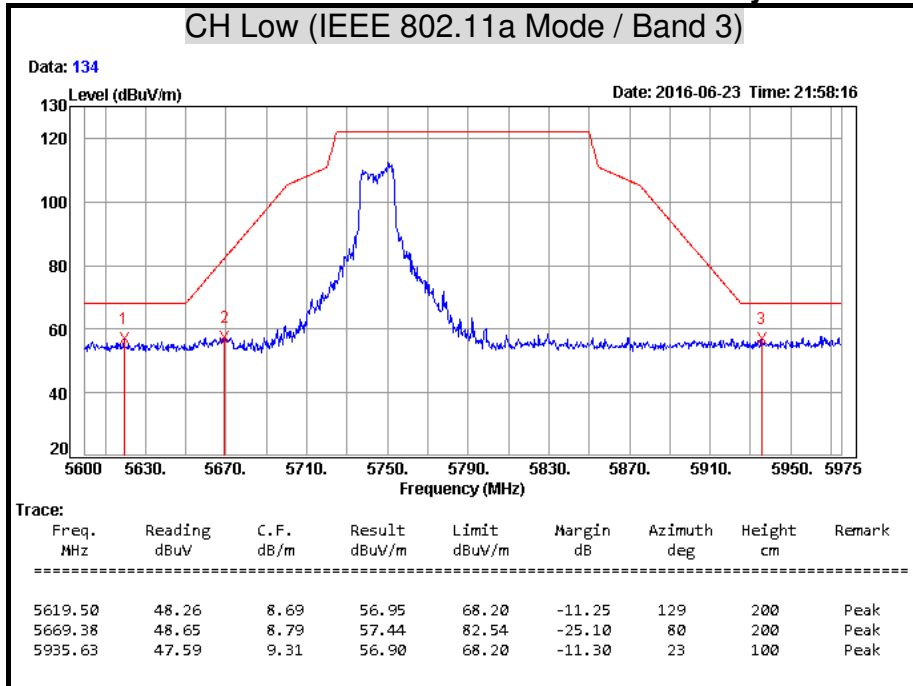

Polarity: Horizontal

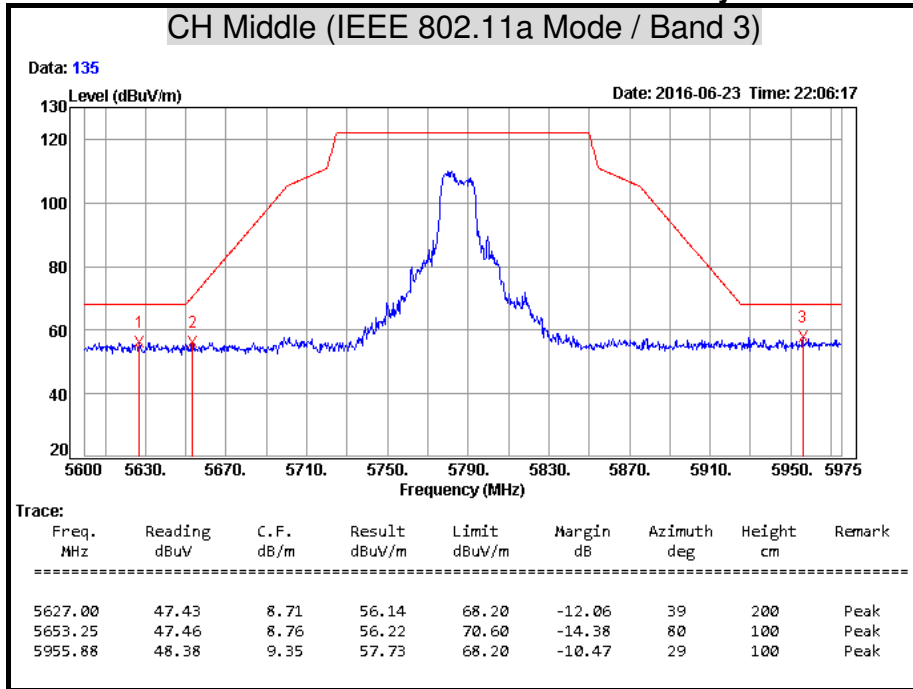

Polarity: Vertical

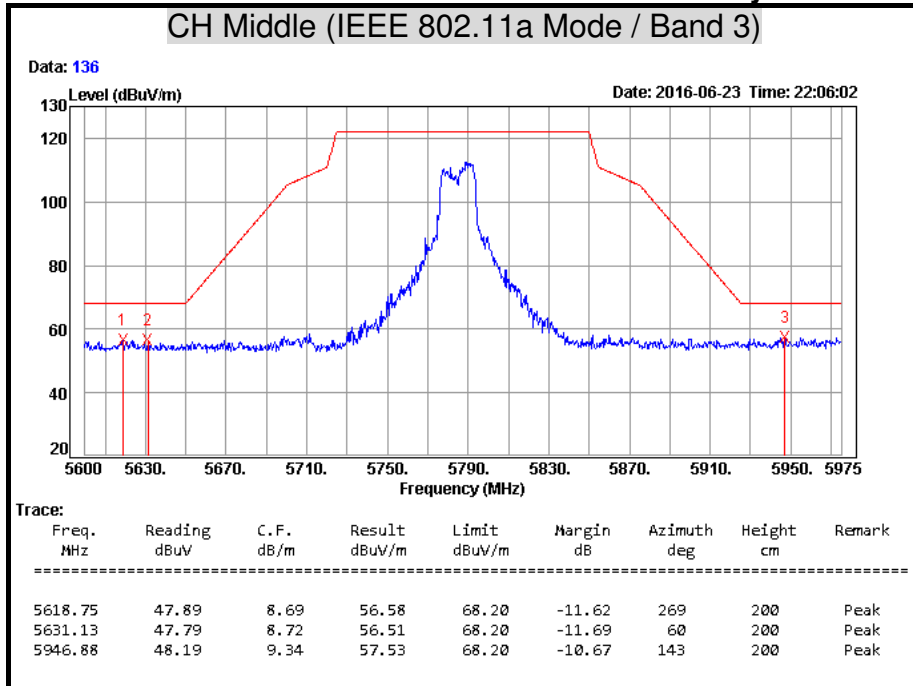

Polarity: Horizontal

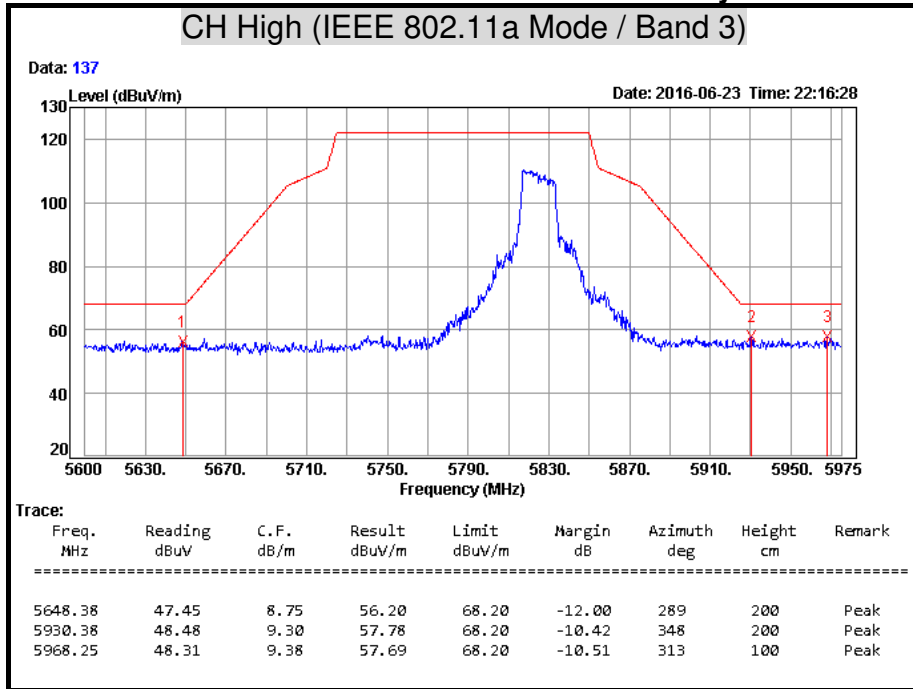

Polarity: Vertical

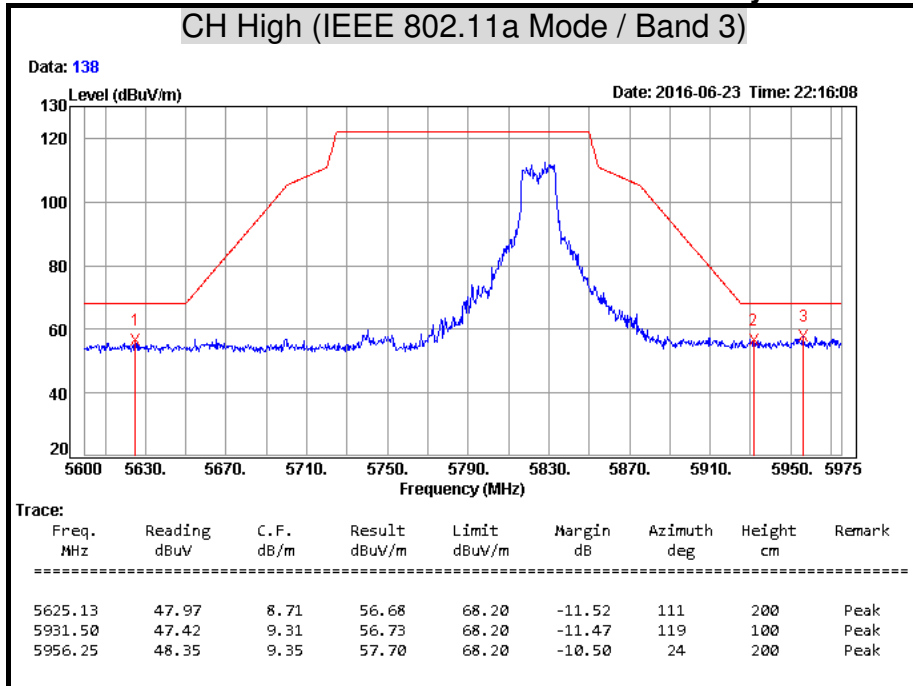

Polarity: Horizontal

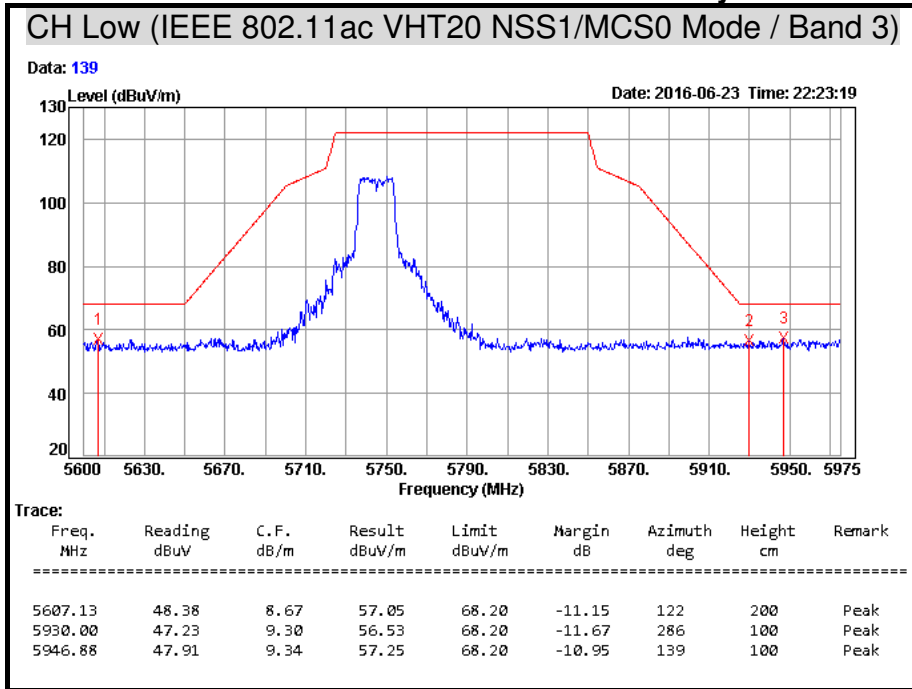

Polarity: Vertical

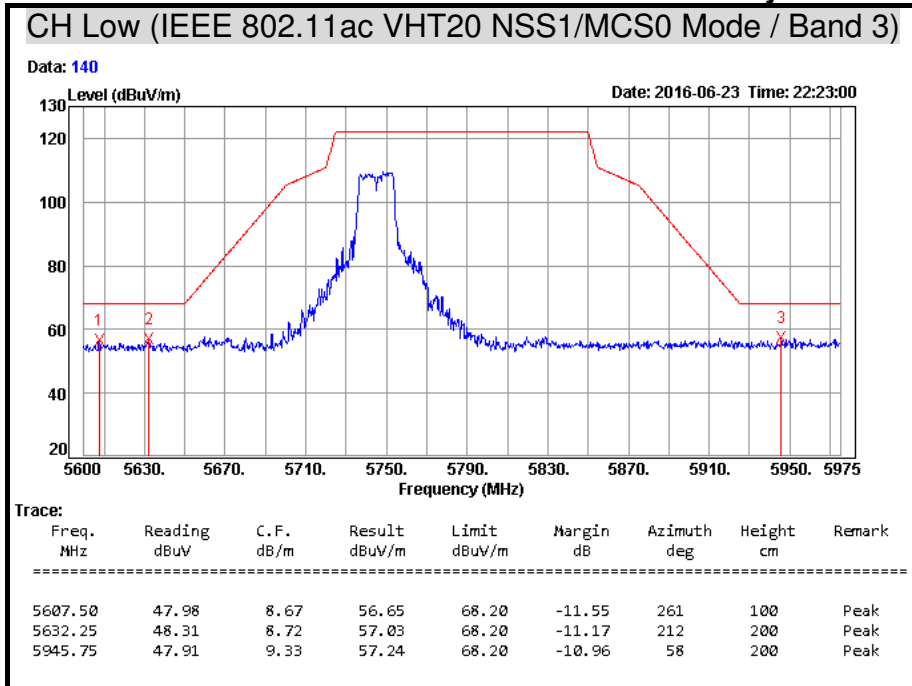

Polarity: Horizontal

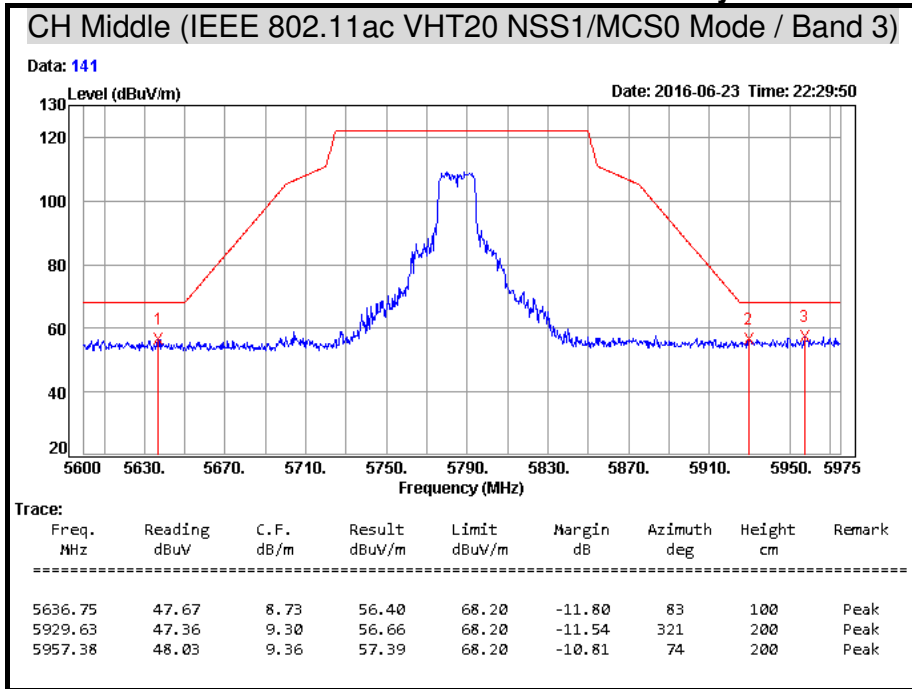

Polarity: Vertical

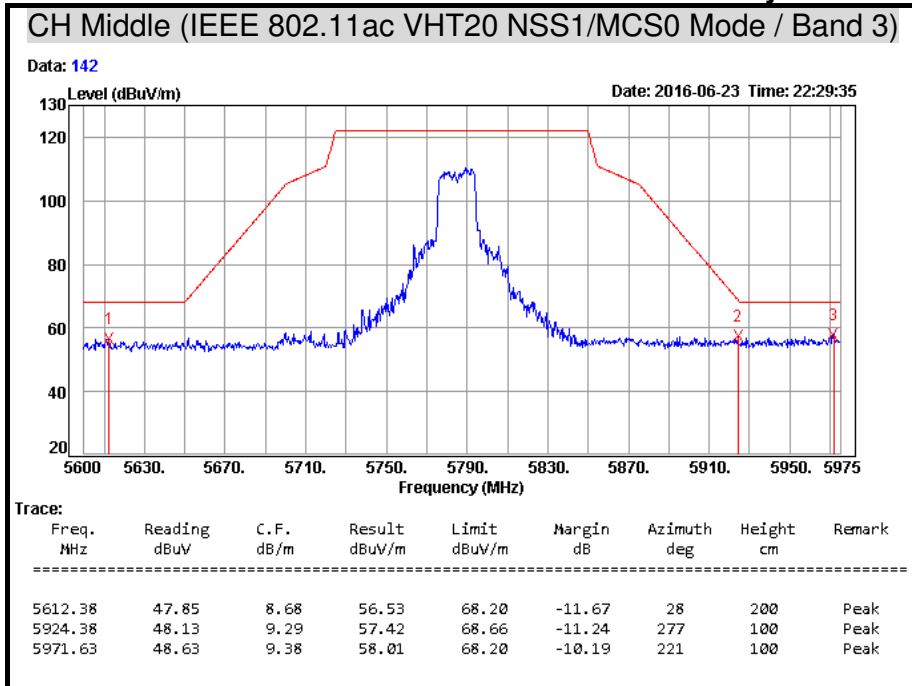

Polarity: Horizontal

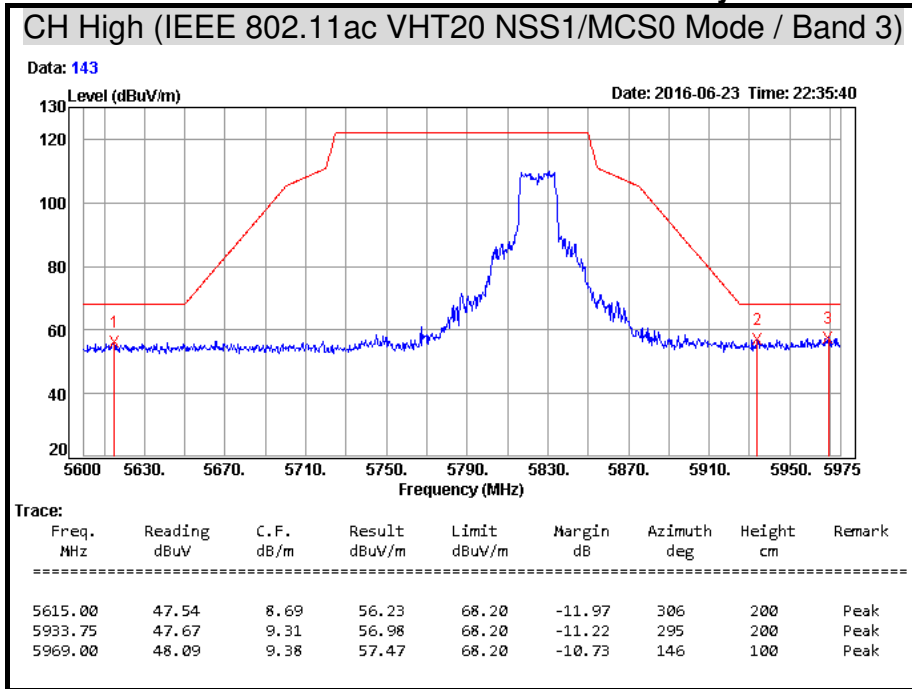

Polarity: Vertical

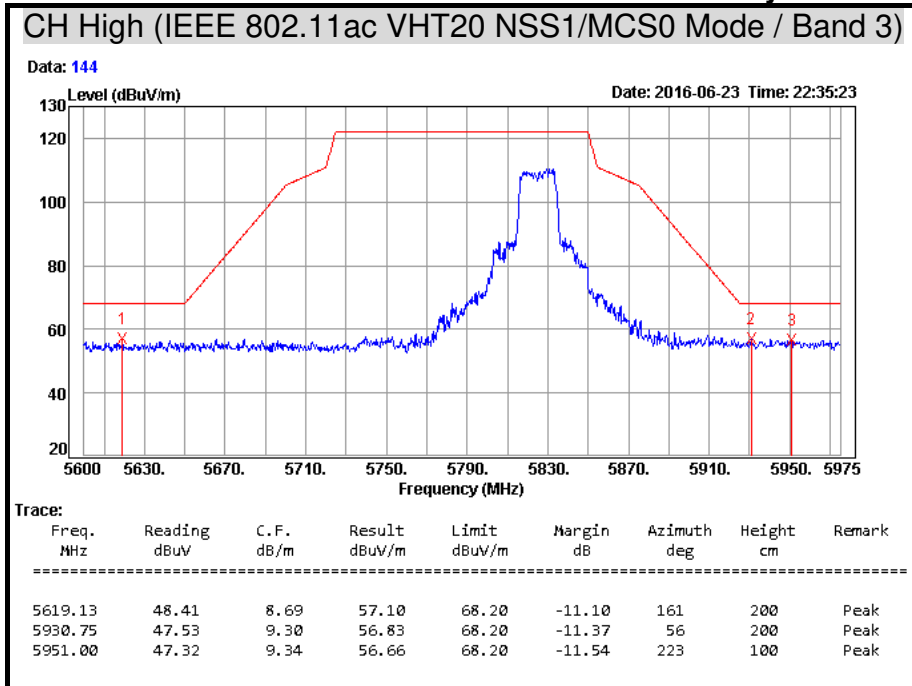

Polarity: Horizontal

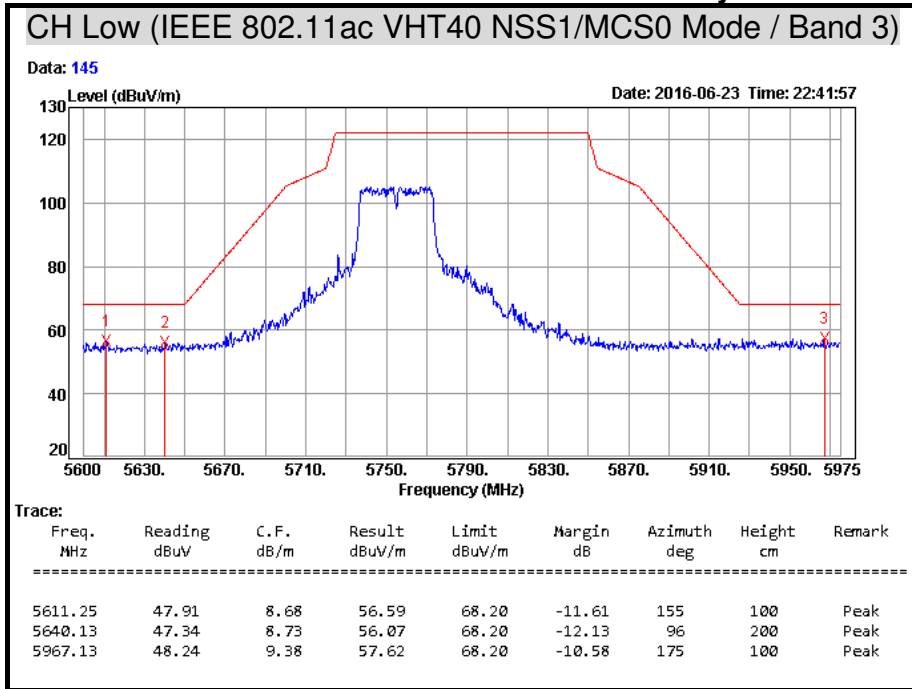

Polarity: Vertical

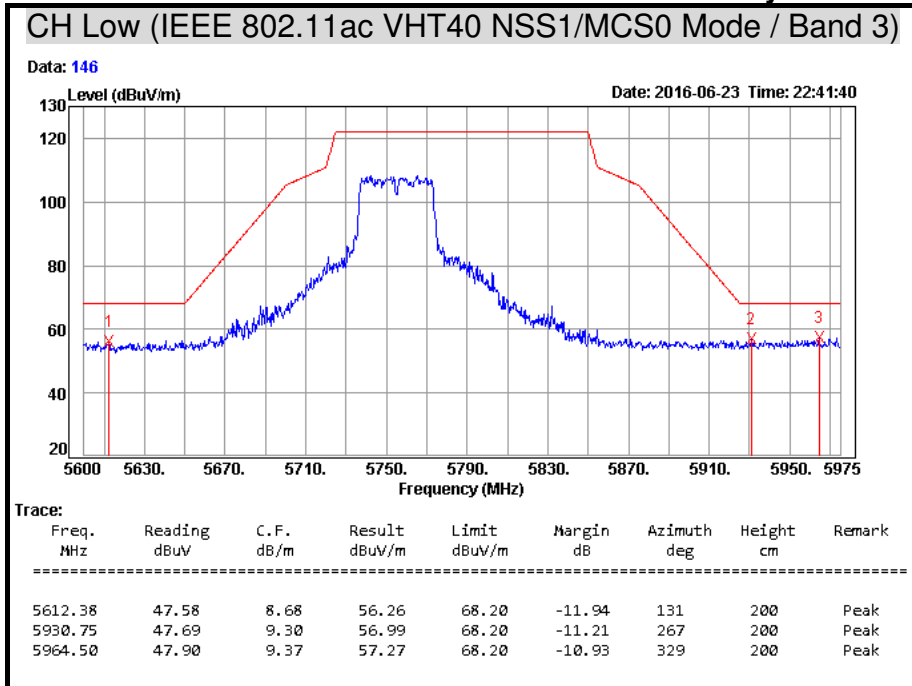

Polarity: Horizontal

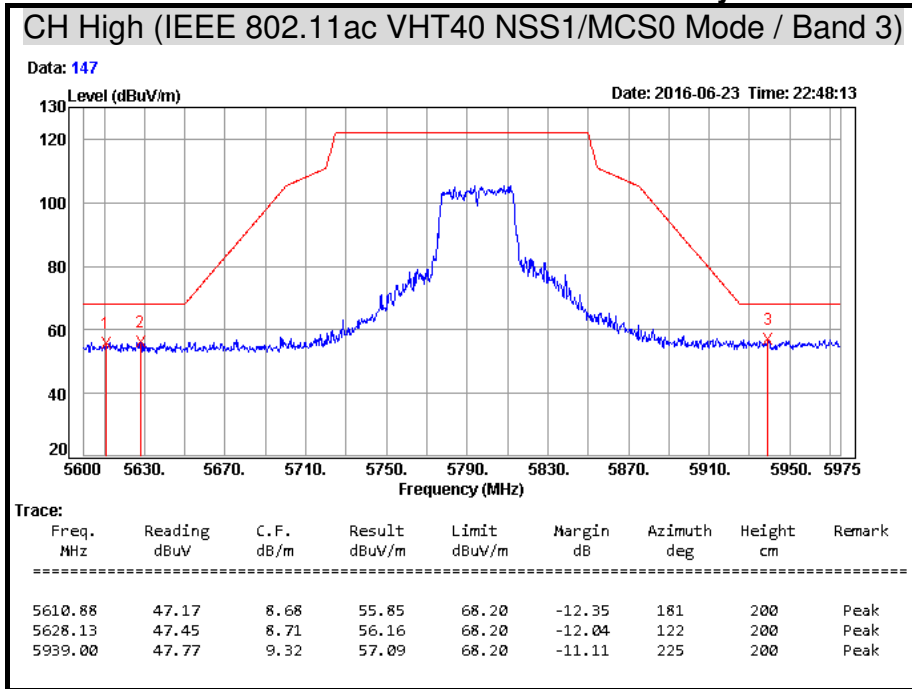

Polarity: Vertical

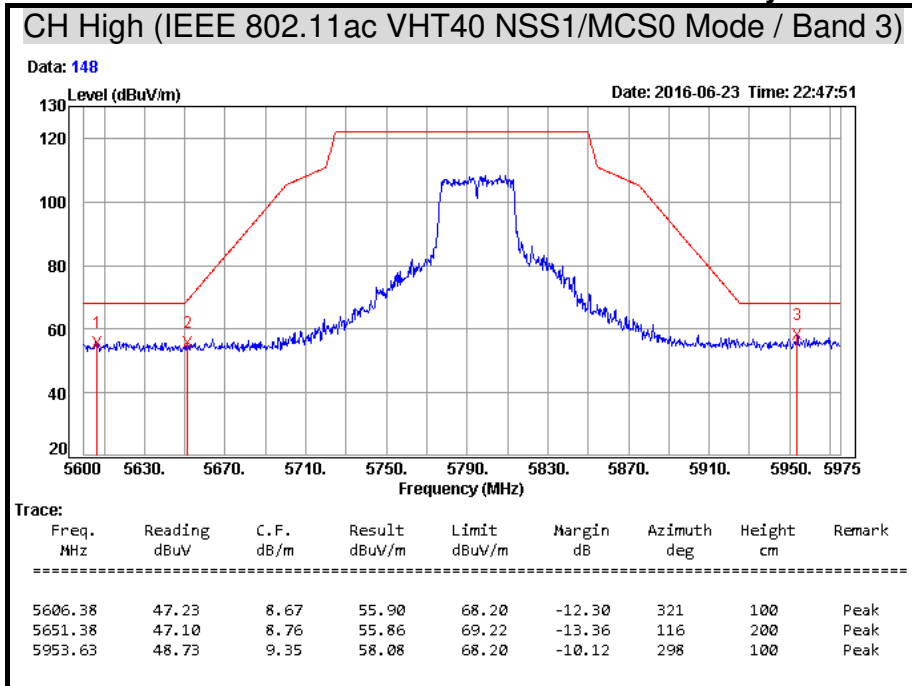

Polarity: Horizontal

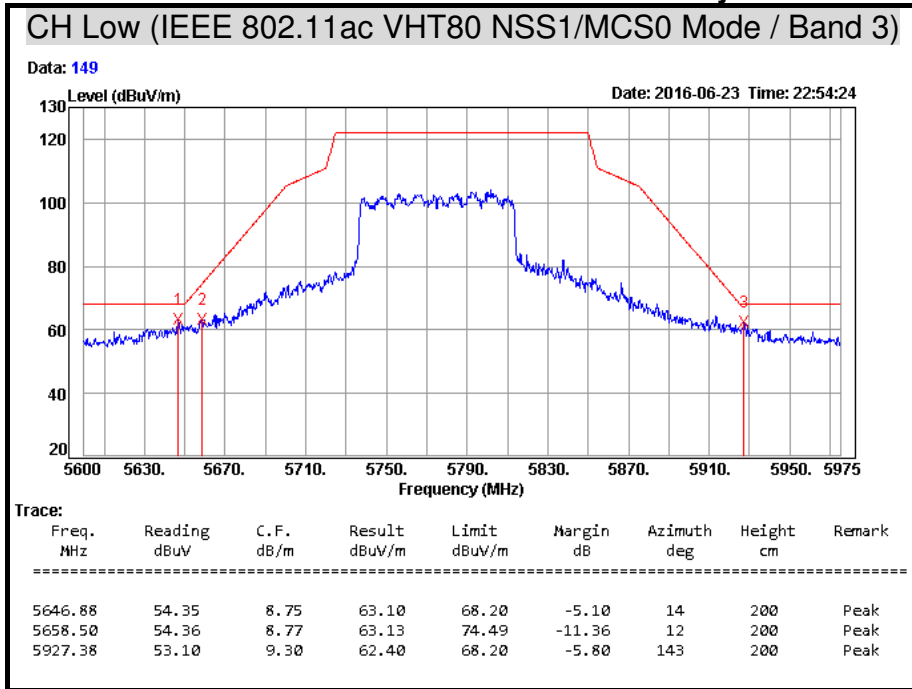

Polarity: Vertical

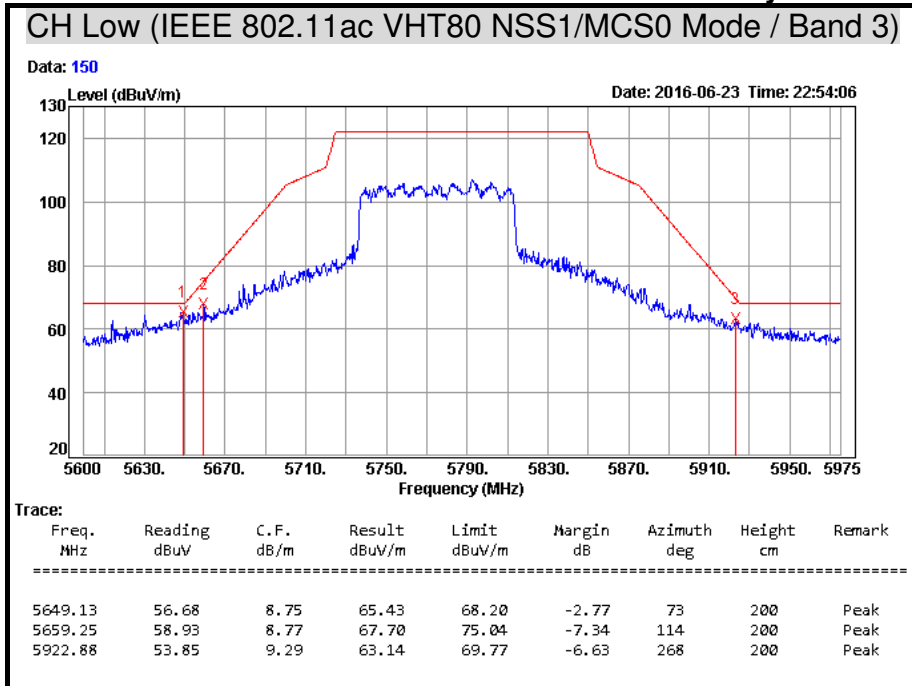

7.6 CONDUCTED EMISSION

LIMITS

§ 15.207 (a) Except as shown in paragraph (b) and (c) this section, for an intentional radiator that is designed to be connected to the public utility (AC) power line, the radio frequency voltage that is conducted back onto the AC power line on any frequency or frequencies within the band 150 kHz to 30 MHz shall not exceed the limits in the following table, as measured using a 50 μH/50 ohms line impedance stabilization network (LISN). Compliance with the provisions of this paragraph shall be based on the measurement of the radio frequency voltage between each power line and ground at the power terminal. The lower limit applies at the boundary between the frequency ranges.

Frequency Range (MHz)	Conducted Limit (dBμv)	
	Quasi-peak	Average
0.15 - 0.50	66 to 56	56 to 46
0.50 - 5.00	56	46
5.00 - 30.0	60	50

TEST EQUIPMENT

Name of Equipment	Manufacturer	Model	Serial Number	Calibration Due
L.I.S.N	Schwarzbeck	NSLK 8127	8127465	08/05/2016
L.I.S.N	Schwarzbeck	NSLK 8127	8127473	03/10/2017
EMI Test Receiver	Rohde & Schwarz	ESHS 30	838550/003	10/31/2016
Pulse Limiter	Rohde & Schwarz	ESH3-Z2	100111	06/27/2017
Test S/W	E3.815206a			

Remark: Each piece of equipment is scheduled for calibration once a year.

TEST SETUP

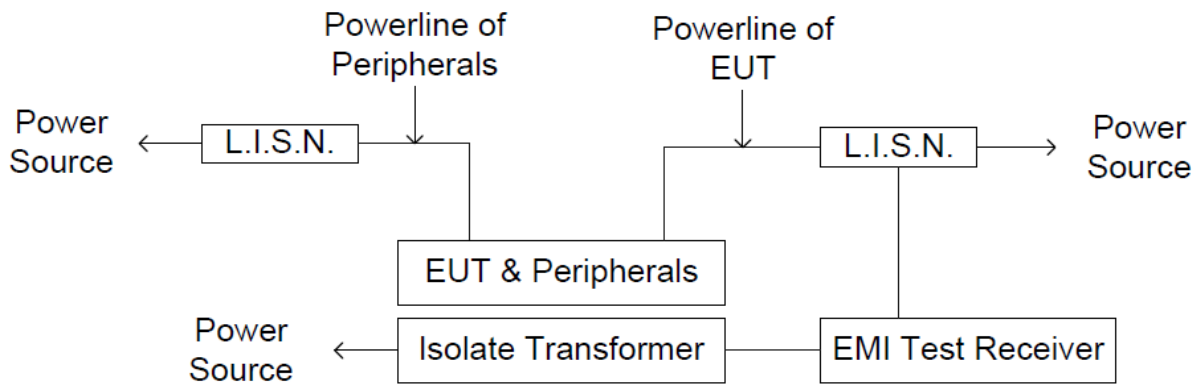
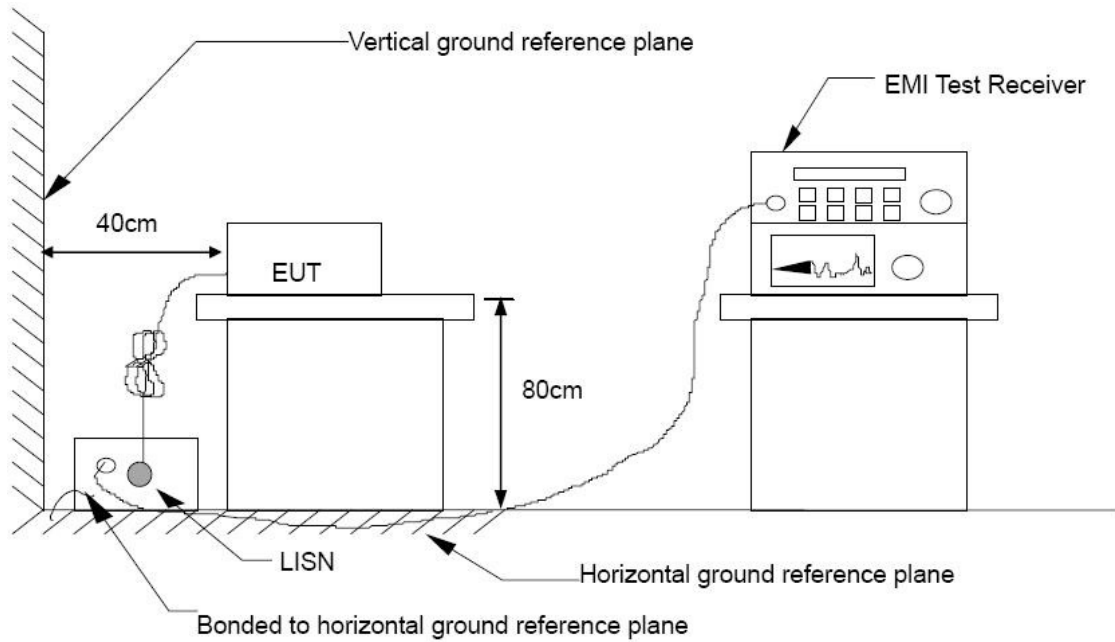

TEST PROCEDURE

The basic test procedure was in accordance with ANSI C63.10:2013.

The test procedure is performed in a 4m × 3m × 2.4m (L×W×H) shielded room.

The EUT along with its peripherals were placed on a 1.0m (W) × 1.5m (L) and 0.8m in height wooden table and the EUT was adjusted to maintain a 0.4 meter space from a vertical reference plane.

The EUT was connected to power mains through a line impedance stabilization network (LISN) which provides 50 ohm coupling impedance for measuring instrument and the chassis ground was bounded to the horizontal ground plane of shielded room. All peripherals were connected to the second LISN and the chassis ground also bounded to the horizontal ground plane of shielded room.

The EUT was located so that the distance between the boundary of the EUT and the closest surface of the LISN is 0.8 m. Where a mains flexible cord was provided by the manufacturer shall be 1 m long, or if in excess of 1 m, the excess cable was folded back and forth as far as possible so as to form a bundle not exceeding 0.4 m in length.

TEST RESULTS

Product Name	AC1200 Wireless Dual Band VDSL2 Gigabit VoIP IAD	Test By	Allen Liu
Test Model	DL4480V	Test Date	2016/06/30
Test Mode	Mode 1	Temp. & Humidity	25°C, 50%

LINE

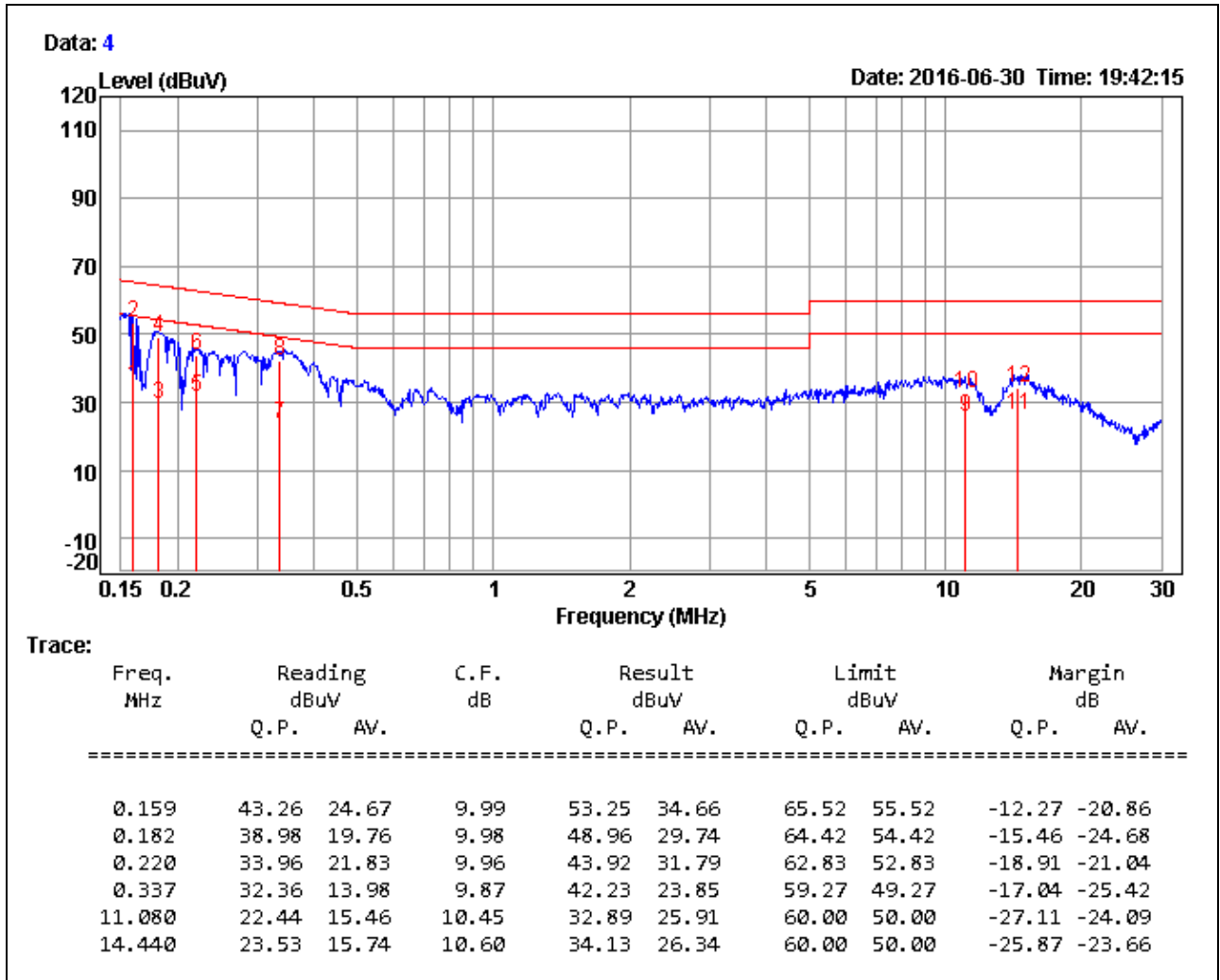

Remark:

1. Correction Factor = Insertion loss + Cable loss
2. Result level = Reading Value + Correction factor
3. Margin value = Result level – Limit value

Product Name	AC1200 Wireless Dual Band VDSL2 Gigabit VoIP IAD	Test By	Allen Liu
Test Model	DL4480V	Test Date	2016/06/30
Test Mode	Mode 1	Temp. & Humidity	25°C, 50%

NEUTRAL

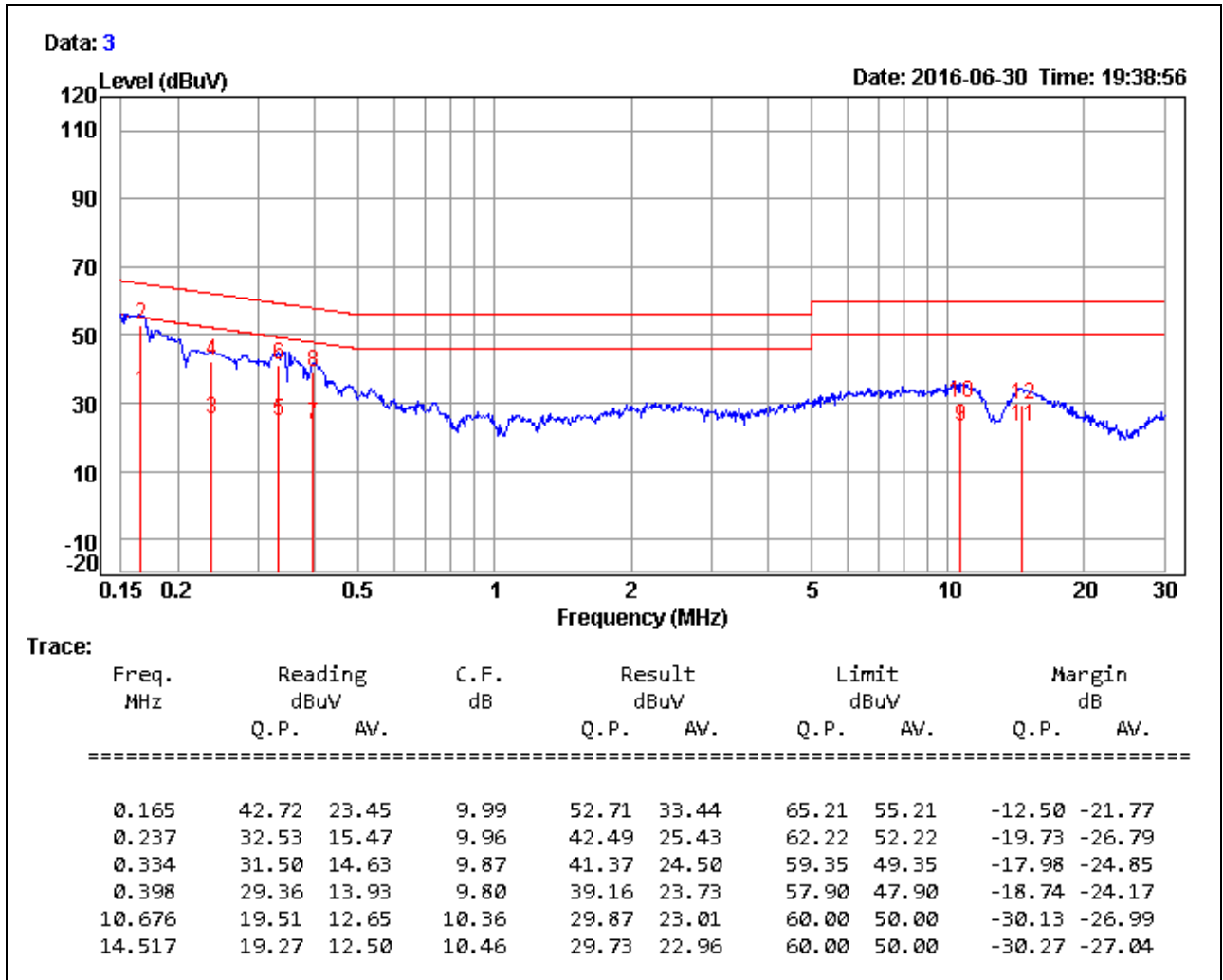

Remark:

1. Correction Factor = Insertion loss + Cable loss
2. Result level = Reading Value + Correction factor
3. Margin value = Result level – Limit value

7.7 FREQUENCY STABILITY

LIMITS

§ 15.407 (g) manufacturers of U-NII devices are responsible for ensuring frequency stability such that an emission is maintained within the band of operation under all conditions of normal operation as specified in the user’s manual.

TEST EQUIPMENT

Name of Equipment	Manufacturer	Model	Serial Number	Calibration Due
Temp. & Humid. Chamber	TERCHY	MHC-120L	960424	09/01/2016
EXA Signal Analyzer	Agilent	N9010A	MY52220817	03/15/2017
Test S/W	N/A			

Remark: Each piece of equipment is scheduled for calibration once a year.

TEST SETUP

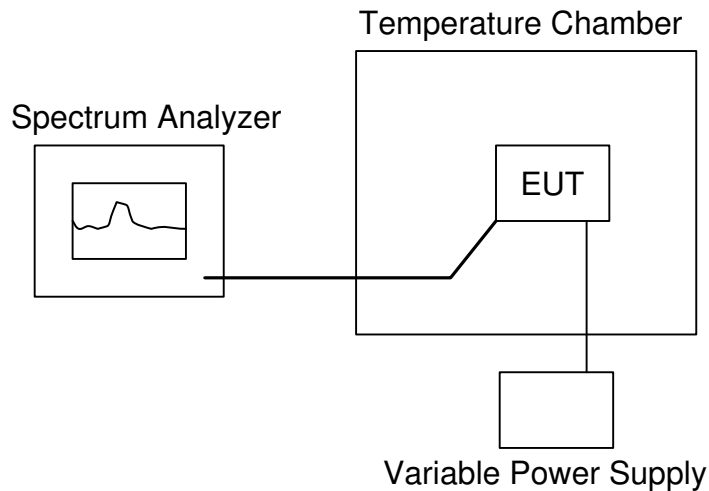

TEST PROCEDURE

1. Place the EUT on the table and set it in the transmitting mode.
2. Remove the antenna from the EUT and then connect a low loss RF cable from the antenna port to the spectrum analyzer.
3. Set the environment into appropriate environment.
4. Set the spectrum analyzer as RBW=1kHz, VBW = RBW, Span = 200kHz, Sweep = auto.
5. Mark the peak frequency and measure the frequency tolerance using frequency counter function.
6. Repeat until all the results are investigated.

TEST RESULTS

Product Name	AC1200 Wireless Dual Band VDSL2 Gigabit VoIP IAD	Test By	Crystal Wu
Test Model	DL4480V	Test Date	2016/06/24
Test Mode	TX Mode	Temp. & Humidity	20°C, 63%

IEEE 802.11a Mode

U-NII Band	Channel	Channel Frequency (MHz)	Measured Frequency (MHz)	Delta Frequency (kHz)	20 ppm Limit (kHz)	Margin (kHz)
Band 1	Low	5180	5179.984955	-15.05	103.60	-88.55
	Middle	5200	5199.984655	-15.34	104.00	-88.66
	High	5240	5239.984310	-15.69	104.80	-89.11
Band 3	Low	5745	5744.983117	-16.88	114.90	-98.02
	Middle	5785	5784.982922	-17.08	115.70	-98.62
	High	5825	5824.983477	-16.52	116.50	-99.98

IEEE 802.11ac VHT20 NSS1/MCS0 Mode

U-NII Band	Channel	Channel Frequency (MHz)	Measured Frequency (MHz)	Delta Frequency (kHz)	20 ppm Limit (kHz)	Margin (kHz)
Band 1	Low	5180	5179.986110	-13.89	103.60	-89.71
	Middle	5200	5199.985262	-14.74	104.00	-89.26
	High	5240	5239.985202	-14.80	104.80	-90.00
Band 3	Low	5745	5744.983485	-16.52	114.90	-98.38
	Middle	5785	5784.983560	-16.44	115.70	-99.26
	High	5825	5824.983470	-16.53	116.50	-99.97

IEEE 802.11ac VHT40 NSS1/MCS0 Mode

U-NII Band	Channel	Channel Frequency (MHz)	Measured Frequency (MHz)	Delta Frequency (kHz)	20 ppm Limit (kHz)	Margin (kHz)
Band 1	Low	5190	5189.985067	-14.93	103.80	-88.87
	High	5230	5229.985457	-14.54	104.60	-90.06
Band 3	Low	5755	5754.983515	-16.49	115.10	-98.61
	High	5795	5794.983552	-16.45	115.90	-99.45

IEEE 802.11ac VHT80 NSS1/MCS0 Mode

U-NII Band	Channel	Channel Frequency (MHz)	Measured Frequency (MHz)	Delta Frequency (kHz)	20 ppm Limit (kHz)	Margin (kHz)
Band 1	Low	5210	5209.981482	-18.52	104.20	-85.68
Band 3	Low	5775	5774.981752	-18.25	115.50	-97.25