



FCC 47 CFR PART 15 SUBPART C

TEST REPORT

For

150Mbps Wireless N ADSL2+ Modem Router

Model: DL4310; DL4310D

Trade Name: netis

Issued to

**NETIS SYSTEMS CO., LTD
4F & 5F, R&D Building, Oriental Cyberport, High-Tech Industrial Park,
Nanshan, Shenzhen, China**

Issued by

**Compliance Certification Services Inc.
No.81-1, Lane 210, Bade 2nd Rd., Lujhu Township,
Taoyuan County 33841, Taiwan, R.O.C.**

TEL: 886-3-324-0332

FAX: 886-3-324-5235

<http://www.ccsrf.com>

service@ccsrf.com



Note: *This report shall not be reproduced except in full, without the written approval of Compliance Certification Services Inc. This document may be altered or revised by Compliance Certification Services Inc. personnel only, and shall be noted in the revision section of the document. The client should not use it to claim product endorsement by TAF, A2LA, NIST or any government agencies. The test results in the report only apply to the tested sample.*



Revision History

Rev.	Issue Date	Revisions	Effect Page	Revised By
00	March 20, 2014	Initial Issue	All	Landy Huang



TABLE OF CONTENTS

1	TEST RESULT CERTIFICATION	4
2	EUT DESCRIPTION	5
3	TEST METHODOLOGY	6
3.1	EUT CONFIGURATION	6
3.2	EUT EXERCISE	6
3.3	GENERAL TEST PROCEDURES	6
3.4	FCC PART 15.205 RESTRICTED BANDS OF OPERATIONS	7
3.5	DESCRIPTION OF TEST MODES.....	8
4	INSTRUMENT CALIBRATION	9
4.1	MEASURING INSTRUMENT CALIBRATION.....	9
4.2	MEASUREMENT EQUIPMENT USED	9
4.3	MEASUREMENT UNCERTAINTY	10
5	FACILITIES AND ACCREDITATIONS	11
5.1	FACILITIES.....	11
5.2	LABORATORY ACCREDITATIONS AND LISTING	11
5.3	TABLE OF ACCREDITATIONS AND LISTINGS.....	12
6	SETUP OF EQUIPMENT UNDER TEST	13
6.1	SETUP CONFIGURATION OF EUT.....	13
6.2	SUPPORT EQUIPMENT	13
7	FCC PART 15 REQUIREMENTS	14
7.1	6DB BANDWIDTH.....	14
7.2	PEAK POWER	22
7.3	AVERAGE POWER.....	24
7.4	BAND EDGES MEASUREMENT	26
7.5	PEAK POWER SPECTRAL DENSITY	48
7.6	SPURIOUS EMISSIONS.....	56
7.7	POWERLINE CONDUCTED EMISSIONS	80
8	APPENDIX I PHOTOGRAPHS OF TEST SETUP	83
9	APPENDIX II: PHOTOGRAPHS OF EUT	87



1 TEST RESULT CERTIFICATION

Applicant: **NETIS SYSTEMS CO., LTD**
4F & 5F, R&D Building, Oriental Cyberport, High-Tech Industrial Park,
Nanshan, Shenzhen, China

Manufacturer: **Shenzhen Netcore Industrial Ltd.**
4F & 5F, R&D Building, Oriental Cyberport, High-Tech Industrial Park,
Nanshan, Shenzhen, China

Equipment Under Test: 150Mbps Wireless N ADSL2+ Modem Router

Trade Name: netis

Model: DL4310; DL4310D

Date of Test: March 12 ~ 17, 2014

APPLICABLE STANDARDS	
STANDARD	TEST RESULT
FCC 47 CFR Part 15 Subpart C	No non-compliance noted

We hereby certify that:

Compliance Certification Services Inc. tested the above equipment in accordance with the requirements set forth in the above standards. The test results show that the equipment tested is capable of demonstrating compliance with the requirements as documented in this report.

The test results of this report relate only to the tested sample identified in this report.

Approved by:

Stan Lin
Section Manager

Reviewed by:

Angel Hu
Section Manager



2 EUT DESCRIPTION

Product	150Mbps Wireless N ADSL2+ Modem Router		
Trade Name	netis		
Model Number	DL4310; DL4310D		
Model Discrepancy	All the model numbers (list on this report) are identical, just for marketing purpose only except Antenna.		
	Model Number	Antenna	
	DL4310	Fixed	
	DL4310D	Detachable	
EUT Power Rating	12VDC, 0.5A		
Power Adapter	Tenpao	Model	NT120050UL
Power Adapter Power Rating	I/P: 100-240VAC, 50/60HZ, 0.2A O/P: 12VDC, 0.5A		
RF Module Manufacturer	Realtek	Model	RTL8188ER-CG
Frequency Range	IEEE 802.11b/g/ IEEE 802.11n HT20 mode: 2412~2462MHz IEEE 802.11n HT40 mode: 2422~2452MHz		
Transmit Power	IEEE 802.11b mode: 15.99 dBm (0.0397W) IEEE 802.11g mode: 22.52 dBm (0.1786W) IEEE 802.11n HT20 mode: 22.41 dBm (0.1742W) IEEE 802.11n HT40 mode: 24.20 dBm (0.2630W)		
Modulation Technique & Transmit Data Rate	IEEE 802.11b mode: DSSS (11, 5.5, 2, 1 Mbps) IEEE 802.11g mode: OFDM (54, 48, 36, 24, 18, 12, 11, 9, 6 Mbps) IEEE 802.11n HT20 mode: OFDM (65, 58.5, 52, 39, 26, 19.5, 13, 6.5 Mbps) IEEE 802.11n HT40 mode: OFDM (135, 121.5, 108, 81, 54, 40.5, 27, 13.5 Mbps)		
Antenna Specification	Dipole Antenna / Gain: 5 dBi		

Remark:

1. The sample selected for test was production product and was provided by manufacturer.
2. This submittal(s) (test report) is intended for FCC ID: **T58DL4310R** filing to comply with Section 15.207, 15.209 and 15.247 of the FCC Part 15, Subpart C Rules.
3. This report is compliance with the 558074 D01 DTS Meas Guidance v03r01 Requirement.



3 TEST METHODOLOGY

The tests documented in this report were performed in accordance with ANSI C63.4: 2009 and FCC CFR 47 Part 15.207, 15.209, 15.247.

3.1 EUT CONFIGURATION

The EUT configuration for testing is installed on RF field strength measurement to meet the Commissions requirement and operating in a manner that intends to maximize its emission characteristics in a continuous normal application.

3.2 EUT EXERCISE

The EUT was operated in the engineering mode to fix the TX frequency that was for the purpose of the measurements.

According to its specifications, the EUT must comply with the requirements of the Section 15.207, 15.209 and 15.247 under the FCC Rules Part 15 Subpart C.

3.3 GENERAL TEST PROCEDURES

Conducted Emissions

The EUT is placed on the turntable, which is 0.8 m above ground plane. According to the requirements in Section 13.1.4.1 of ANSI C63.4 Conducted emissions from the EUT measured in the frequency range between 0.15 MHz and 30MHz using CISPR Quasi-peak and average detector modes.

Radiated Emissions

The EUT is placed on a turn table, which is 0.8 m above ground plane. The turntable shall rotate 360 degrees to determine the position of maximum emission level. EUT is set 3m away from the receiving antenna, which varied from 1m to 4m to find out the highest emission. And also, each emission was to be maximized by changing the polarization of receiving antenna both horizontal and vertical. In order to find out the maximum emissions, exploratory radiated emission measurements were made according to the requirements in Section 13.1.4.1 of ANSI C63.4.



3.4 FCC PART 15.205 RESTRICTED BANDS OF OPERATIONS

(a) Except as shown in paragraph (d) of this section, only spurious emissions are permitted in any of the frequency bands listed below:

MHz	MHz	MHz	GHz
0.090 - 0.110	16.42 - 16.423	399.9 - 410	4.5 - 5.15
¹ 0.495 - 0.505	16.69475 - 16.69525	608 - 614	5.35 - 5.46
2.1735 - 2.1905	16.80425 - 16.80475	960 - 1240	7.25 - 7.75
4.125 - 4.128	25.5 - 25.67	1300 - 1427	8.025 - 8.5
4.17725 - 4.17775	37.5 - 38.25	1435 - 1626.5	9.0 - 9.2
4.20725 - 4.20775	73 - 74.6	1645.5 - 1646.5	9.3 - 9.5
6.215 - 6.218	74.8 - 75.2	1660 - 1710	10.6 - 12.7
6.26775 - 6.26825	108 - 121.94	1718.8 - 1722.2	13.25 - 13.4
6.31175 - 6.31225	123 - 138	2200 - 2300	14.47 - 14.5
8.291 - 8.294	149.9 - 150.05	2310 - 2390	15.35 - 16.2
8.362 - 8.366	156.52475 -	2483.5 - 2500	17.7 - 21.4
8.37625 - 8.38675	156.52525	2655 - 2900	22.01 - 23.12
8.41425 - 8.41475	156.7 - 156.9	3260 - 3267	23.6 - 24.0
12.29 - 12.293	162.0125 - 167.17	3332 - 3339	31.2 - 31.8
12.51975 - 12.52025	167.72 - 173.2	3345.8 - 3358	36.43 - 36.5
12.57675 - 12.57725	240 - 285	3600 - 4400	(²)
13.36 - 13.41	322 - 335.4		

¹ Until February 1, 1999, this restricted band shall be 0.490-0.510 MHz.

² Above 38.6

(b) Except as provided in paragraphs (d) and (e), the field strength of emissions appearing within these frequency bands shall not exceed the limits shown in Section 15.209. At frequencies equal to or less than 1000 MHz, compliance with the limits in Section 15.209 shall be demonstrated using measurement instrumentation employing a CISPR quasi-peak detector. Above 1000 MHz, compliance with the emission limits in Section 15.209 shall be demonstrated based on the average value of the measured emissions. The provisions in Section 15.35 apply to these measurements.



3.5 DESCRIPTION OF TEST MODES

The EUT is a 1Tx1R SISO transmitter.

The EUT (model: DL4310D) had been tested under operating condition and had been reported as worst case on this test report.

Software used to control the EUT for staying in continuous transmitting and receiving mode was programmed.

The worst case data rate is determined as the data rate with highest output power.

After verification, all tests were carried out with the worst case test modes as shown below except radiated spurious emission below 1GHz and power line conducted emissions below 30MHz, which worst case was in normal link mode and receiving radiated spurious emission above 1GHz, which worst case was in CH Mid mode only.

The field strength of spurious emission was measured in the following position: EUT stand-up position (Y axis), lie-down position (X, Z axis). The worst emission was found in lie-down position (X axis) and the worst case was recorded.

IEEE 802.11b mode:

Channel Low (2412MHz), Channel Mid (2437MHz) and Channel High (2462MHz) with 1Mbps data rate was chosen for full testing.

IEEE 802.11g mode:

Channel Low (2412MHz), Channel Mid (2437MHz) and Channel High (2462MHz) with 6Mbps data rate was chosen for full testing.

IEEE 802.11n HT20 mode:

Channel Low (2412MHz), Channel Mid (2437MHz) and Channel High (2462MHz) with 6.5Mbps data rate were chosen for full testing.

IEEE 802.11n HT40 mode:

Channel Low (2422MHz), Channel Mid (2437MHz) and Channel High (2452MHz) with 13.5Mbps data rate were chosen for full testing.



4 INSTRUMENT CALIBRATION

4.1 MEASURING INSTRUMENT CALIBRATION

The measuring equipment, which was utilized in performing the tests documented herein, has been calibrated in accordance with the manufacturer's recommendations for utilizing calibration equipment, which is traceable to recognized national standards.

4.2 MEASUREMENT EQUIPMENT USED

Equipment Used for Emissions Measurement

Conducted Emissions Test Site				
Name of Equipment	Manufacturer	Model	Serial Number	Calibration Due
Spectrum Analyzer	Agilent	E4446A	MY48250064	01/01/2015
Spectrum Analyzer	Agilent	N9010A	MY52220817	02/11/2015
Spectrum Analyzer	R&S	FSL	100837	11/11/2014
Power meter	Anritsu	ML2495A	1033009	09/29/2014
Power Sensor	Anritsu	MA2411B	0917221	09/29/2014

3M Semi Anechoic Chamber				
Name of Equipment	Manufacturer	Model	Serial Number	Calibration Due
Spectrum Analyzer	Agilent	E4446A	MY48250064	01/01/2015
Spectrum Analyzer	R&S	FSL	100837	11/11/2014
Pre-Amplifier	HP	8447D	2944A06530	04/23/2014
Pre-Amplifier	EMEC	EM01M26G	060570	07/25/2014
Pre-Amplifier	MITEQ	AMF-6F-26040 0-40-8P	985646	08/08/2014
Pre-Amplifier	Agilent	8449B	3008A01738	04/23/2014
EMI Test Receiver	SCHAFFNER	SCR 3501	430	04/07/2014
Loop Antenna	EMCO	6502	2356	06/12/2014
Bilog Antenna	TESEQ	CBL 6112D	35378	09/11/2014
Horn Antenna	EMCO	3115	00022250	08/04/2014
Horn Antenna	EMCO	3116	00026370	12/29/2014
Antenna Tower	CCS	CC-A-1F	N/A	N.C.R
Turn Table	CCS	CC-T-1F	N/A	N.C.R
Test S/W	EZ-EMC			

NOTE: 1. The calibration interval of the above test instruments is 12 months and the calibrations are traceable to NML/ROC and NIST/USA.
 2. N.C.R = No Calibration Request.



Powerline Conducted Emissions Test Site #1				
Name of Equipment	Manufacturer	Model	Serial Number	Calibration Due
EMI Test Receiver	R&S	ESCI	101338	01/16/2015
LISN	R&S	ENV216	101549	07/29/2014
LISN	FCC	FCC-LISN-50/ 250-16-2-07	06012	12/02/2014
ISN	TESEQ	ISN-T8	34371	03/05/2015
Test S/W	EZ_EMG			

NOTE: 1. The calibration interval of the above test instruments is 12 months and the calibrations are traceable to NML/ROC and NIST/USA.
2. N.C.R = No Calibration Request.

4.3 MEASUREMENT UNCERTAINTY

Parameter	Uncertainty
Powerline Conducted Emission	±0.8830
3M Chamber / 30~200MHz	±3.5921
3M Chamber / 200~1000MHz	±3.5657
3M Chamber / 1~8GHz	±2.5873
3M Chamber / 8~18GHz	±2.6646
3M Chamber / 18~26GHz	±2.9617
3M Chamber / 26~40GHz	±3.4250

Remark: This uncertainty represents an expanded uncertainty expressed at approximately the 95% confidence level using a coverage factor of $k=2$.



5 FACILITIES AND ACCREDITATIONS

5.1 FACILITIES

All measurement facilities used to collect the measurement data are located at

- No. 163-1, Jhongsheng Rd., Sindien District, Taipei City 23151, Taiwan
Tel: 886-2-2217-0894 / Fax: 886-2-2217-1029

- No 11, Wugong 6th Rd, Wugu District, New Taipei City 24891, Taiwan (R.O.C)
Tel: 886-2-2299-9720 / Fax: 886-2-2298-4045

- No.81-1, Lane 210, Bade 2nd Rd., Lujhu Township, Taoyuan County 33841, Taiwan
Tel: 886-3-324-0332 / Fax: 886-3-324-5235

The sites are constructed in conformance with the requirements of ANSI C63.7, ANSI C63.4 and CISPR Publication 22.

All receiving equipment conforms to CISPR Publication 16-1, "Radio Interference Measuring Apparatus and Measurement Methods."

5.2 LABORATORY ACCREDITATIONS AND LISTING

The test facilities used to perform radiated and conducted emissions tests are accredited by American Association for Laboratory Accreditation Program for the specific scope accreditation under Lab Code: 0824-01 to perform Electromagnetic Interference tests according to FCC Part 15 and CISPR 22 requirements. In addition, the test facilities are listed with Industry Canada, Certification and Engineering Bureau, IC 2324G-1 for 3M Semi Anechoic Chamber A, IC 2324G-2 for 3M Semi Anechoic Chamber B.



5.3 TABLE OF ACCREDITATIONS AND LISTINGS

Country	Agency	Scope of Accreditation	Logo
USA	A2LA	CFR 47, FCC Part15/18, CISPR 22, EN 55022, ICES-003, AS/NZS CISPR 22, VCCI V-3, EN 55011, CISPR 11, IEC/EN 61000-4-2/3/4/5/6/8/11, EN 61000-6-1/2/3/4, EN 55024, CISPR 24, AS/NZS CISPR 24, AS/NZS 61000.6.2, EN 55014-1/-2, ETSI EN 300 386 v1.3.2/v1.3.3, IEC/EN 61000-3-2, AS/NZS 61000.3.2, IEC/EN 61000-3-3, AS/NZS 61000.3.3	
USA	FCC MRA	3 meter Open Area Test Sites to perform FCC Part 15/18 measurements	
Japan	VCCI	3/10 meter Open Area Test Sites and conducted test sites to perform radiated/conducted measurements	
Taiwan	TAF	EN 55014-1, CISPR 14, CNS 13781-1, EN 55013, CISPR 13, CNS 13439, EN 55011, CISPR 11, CNS 13803, PLMN09, IS2045-0, LP0002 FCC Part 27/90, Part 15B/C/D/E, RSS-192/193/210/310 ETSI EN 300 328/ 300 220-1/ 300 220-2/ 301 893/ 301 489-01/ 301 489-03/ 301 489-07 / 301 489-17/ 300 440-1/ 300 440-2 AS/NZS 4268, AS/NZS 4771 CISPR 22, EN 55022, CNS 13438, AS/NZS CISPR 22, VCCI, IEC/EN 61000-4-2/3/4/5/6/8/11, CNS 14676-2/3/4/5/6/8, CNS 14934-2/3, CNS 13783-1, CNS 13439, CNS 13803	
Taiwan	BSMI	CNS 13438, CNS 13783-1, CNS 13439, CNS 14115	SL2-IS-E-0014 / IN-E-0014 /A1-E-0014 /R1-E-0014 /R2-E-0014 /L1-E-0014
Canada	Industry Canada	RSS-Gen Issue 3	

* No part of this report may be used to claim or imply product endorsement by A2LA or any agency of the US Government.



6 SETUP OF EQUIPMENT UNDER TEST

6.1 SETUP CONFIGURATION OF EUT

See test photographs attached in Appendix II for the actual connections between EUT and support equipment.

6.2 SUPPORT EQUIPMENT

For Radiated Emissions(Below 1GHz) and Powerline Conducted Emission							
No.	Device Type	Model	Series No.	FCC ID	Brand	Data Cable	Power Cord
1	Notebook PC (Remote)	1706-A78	LV-L1870 06/09	FCC DoC	IBM	LAN Cable: Unshielded, 10m	AC I/P: Unshielded, 1.8m DC O/P: Unshielded, 1.8m with a core
2	Multi Services Access Node	IES-1000	N/A	N/A	Zyxel	RJ-11 Cable: Unshielded, 10m	Unshielded, 1.8m
3	Notebook PC (Remote)	D400	0932RY	E2K24GBRL	DELL	N/A	AC I/P: Unshielded, 1.8m DC O/P: Unshielded, 1.8m with a core

For Radiated Emissions(Above 1GHz)							
No.	Device Type	Model	Series No.	FCC ID	Brand	Data Cable	Power Cord
1	Notebook PC (Remote)	D400	0932RY	E2K24GBRL	DELL	LAN Cable: Unshielded, 10m	AC I/P: Unshielded, 1.8m DC O/P: Unshielded, 1.8m with a core

For Conducted Emission							
No.	Device Type	Model	Series No.	FCC ID	Brand	Data Cable	Power Cord
1	Notebook PC	D400	0932RY	E2K24GBRL	DELL	LAN Cable: Unshielded, 10m	AC I/P: Unshielded, 1.8m DC O/P: Unshielded, 1.8m with a core

Remark: Grounding was established in accordance with the manufacturer's requirements and conditions for the intended use.



7 FCC PART 15 REQUIREMENTS

7.1 6DB BANDWIDTH

LIMIT

According to §15.247(a)(2), systems using digital modulation techniques may operate in the 902 - 928 MHz, 2400 - 2483.5 MHz, and 5725 - 5850 MHz bands. The minimum 6dB bandwidth shall be at least 500 kHz.

Test Configuration

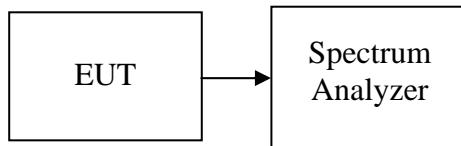

TEST PROCEDURE

1. Place the EUT on the table and set it in the transmitting mode.
2. Remove the antenna from the EUT and then connect a low loss RF cable from the antenna port to the spectrum analyzer.
3. Set the spectrum analyzer as RBW = 100kHz, VBW = 300kHz, Sweep = auto, Span = 30MHz (IEEE 802.11b, IEEE 802.11g, IEEE 802.11n HT20) or Span = 50MHz (IEEE 802.11n HT40).
4. Mark the peak frequency and -6dB (upper and lower) frequency.
5. Repeat until all the rest channels are investigated.

TEST RESULTS

No non-compliance noted



Test Data

Test mode: IEEE 802.11b mode

Channel	Frequency (MHz)	Bandwidth (MHz)	Limit (kHz)	Result
Low	2412	10.05	>500	PASS
Mid	2437	10.05		PASS
High	2462	10.05		PASS

Test mode: IEEE 802.11g mode

Channel	Frequency (MHz)	Bandwidth (MHz)	Limit (kHz)	Result
Low	2412	16.45	>500	PASS
Mid	2437	16.45		PASS
High	2462	16.45		PASS

Test mode: IEEE 802.11n HT20 mode

Channel	Frequency (MHz)	Bandwidth (MHz)	Limit (kHz)	Result
Low	2412	17.75	>500	PASS
Mid	2437	17.75		PASS
High	2462	17.70		PASS

Test mode: IEEE 802.11n HT40 mode

Channel	Frequency (MHz)	Bandwidth (MHz)	Limit (kHz)	Result
Low	2422	35.50	>500	PASS
Mid	2437	36.17		PASS
High	2452	36.33		PASS



Test Plot

IEEE 802.11b mode

6dB Bandwidth (CH Low)

Agilent

R T

Mkr1 10.05 MHz
-0.09 dB

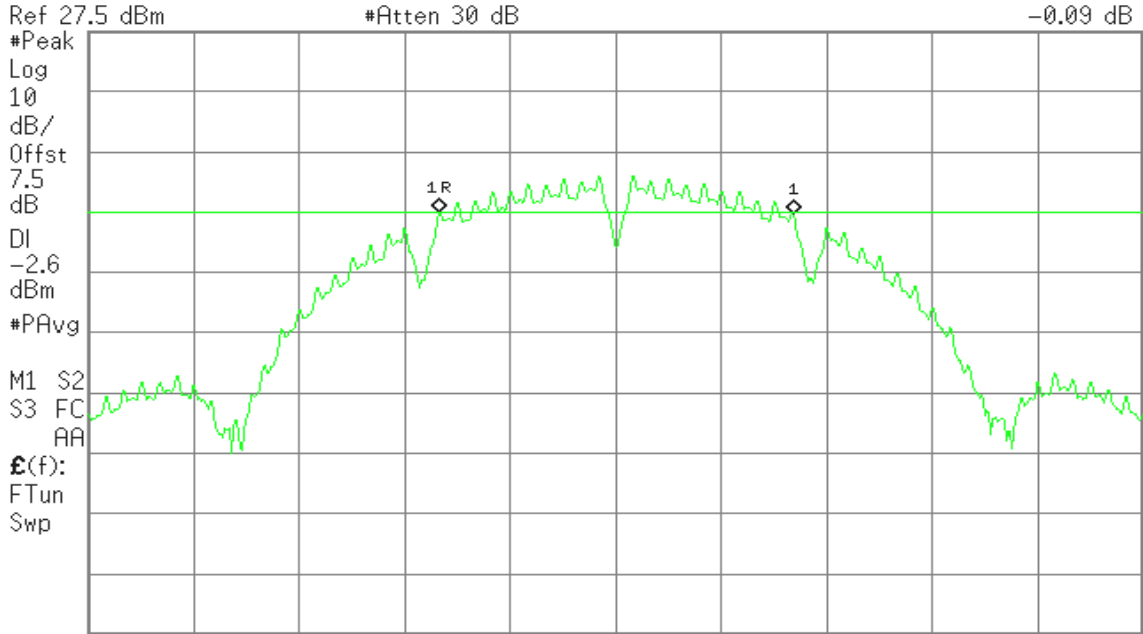

Center 2.412 00 GHz Span 30 MHz
#Res BW 100 kHz #VBW 300 kHz Sweep 2.88 ms (601 pts)

6dB Bandwidth (CH Mid)

Agilent

R T

Mkr1 10.05 MHz
0.33 dB

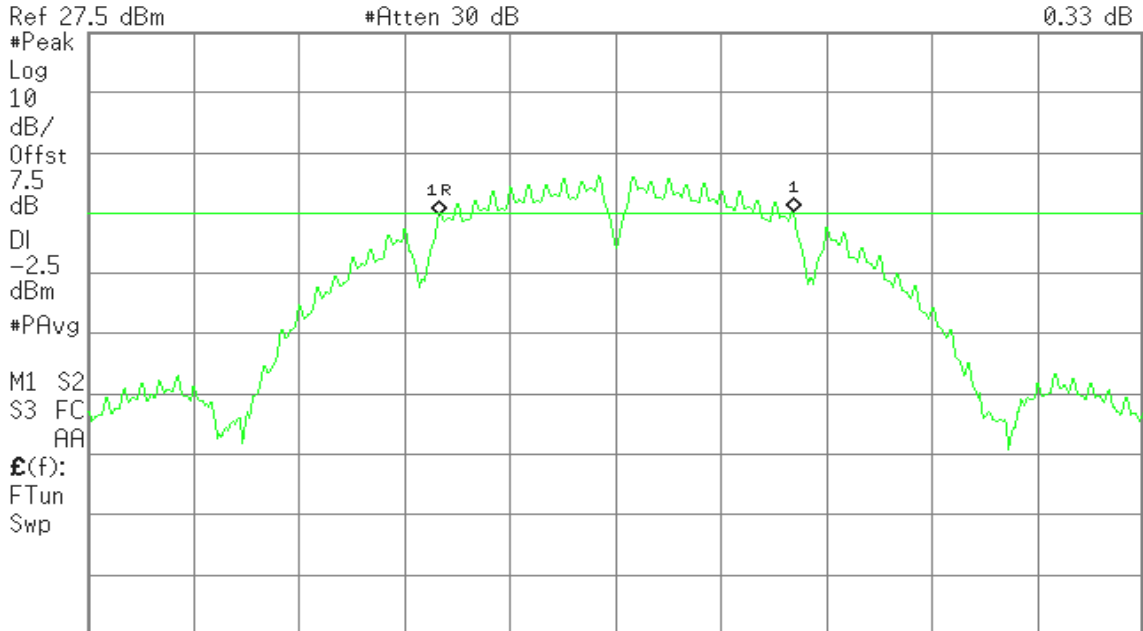

Center 2.437 00 GHz Span 30 MHz
#Res BW 100 kHz #VBW 300 kHz Sweep 2.88 ms (601 pts)



6dB Bandwidth (CH High)

Agilent

R T

Mkr1 10.05 MHz
0.19 dB

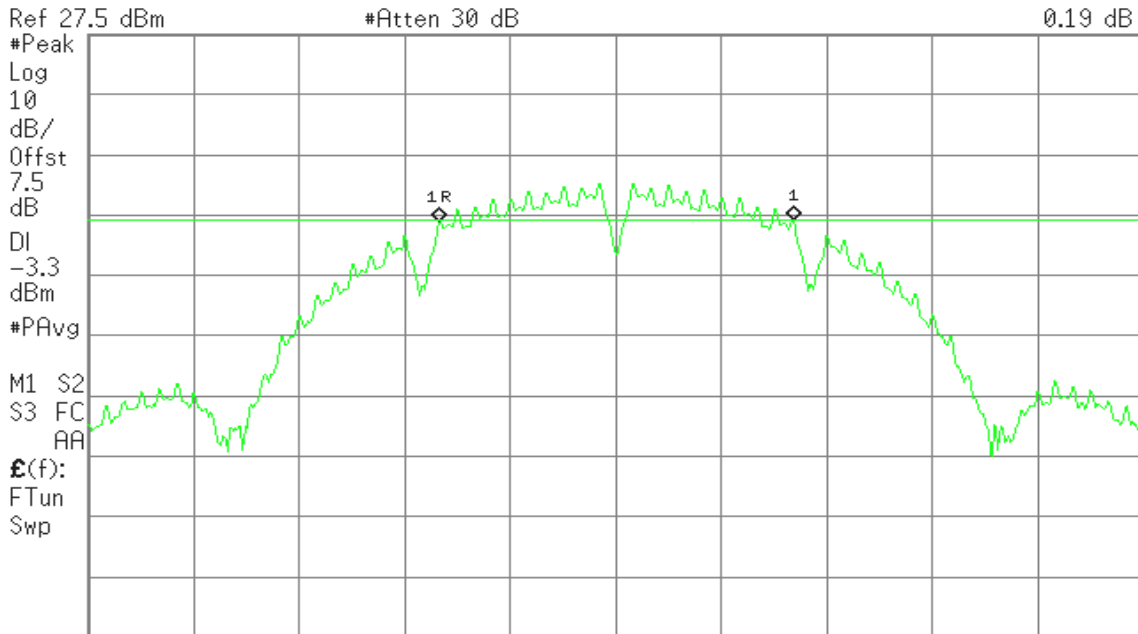

Center 2.462 00 GHz Span 30 MHz
#Res BW 100 kHz #VBW 300 kHz Sweep 2.88 ms (601 pts)

IEEE 802.11g mode

6dB Bandwidth (CH Low)

Agilent

R T

Mkr1 16.45 MHz
0.56 dB

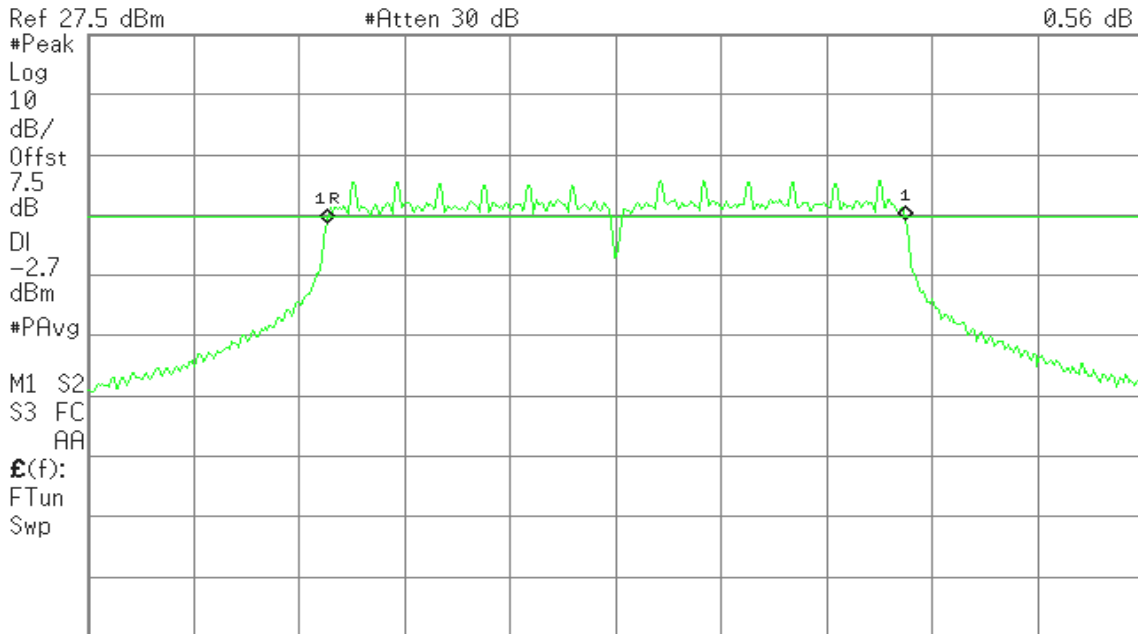

Center 2.412 00 GHz Span 30 MHz
#Res BW 100 kHz #VBW 300 kHz Sweep 2.88 ms (601 pts)



6dB Bandwidth (CH Mid)

Agilent

R T

Mkr1 16.45 MHz
0.41 dB

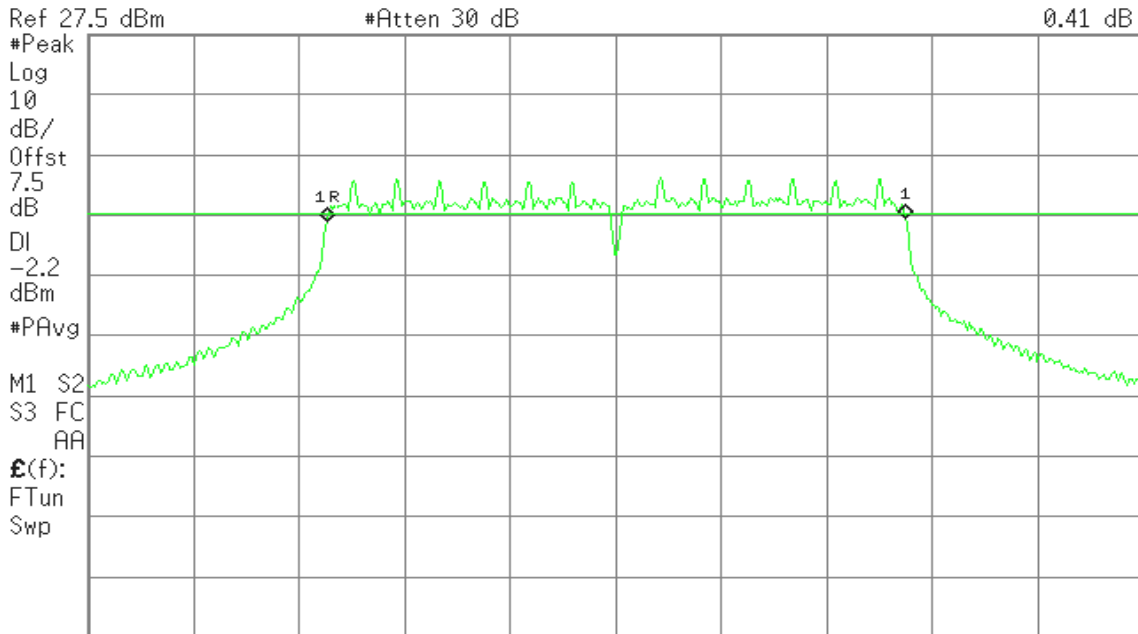

Center 2.437 00 GHz

Span 30 MHz

#Res BW 100 kHz

#VBW 300 kHz

Sweep 2.88 ms (601 pts)

6dB 6dB Bandwidth (CH High)

Agilent

R T

Mkr1 16.45 MHz
0.32 dB

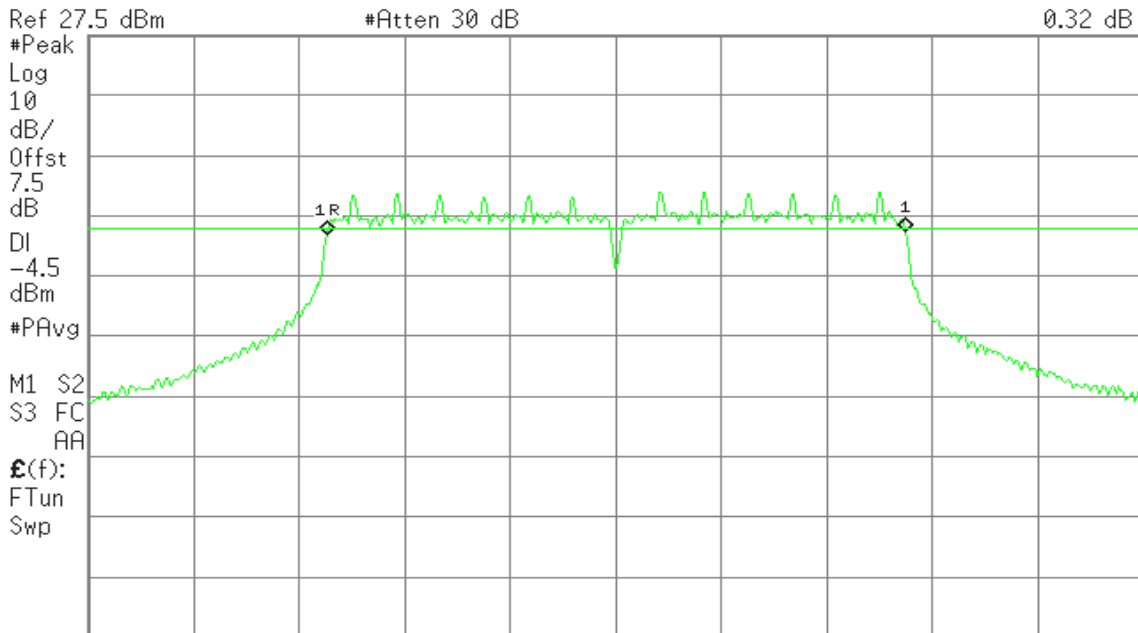

Center 2.462 00 GHz

Span 30 MHz

#Res BW 100 kHz

#VBW 300 kHz

Sweep 2.88 ms (601 pts)



IEEE 802.11n HT20 mode

6dB Bandwidth (CH Low)

Agilent

R T

Mkr1 17.75 MHz
-0.15 dB

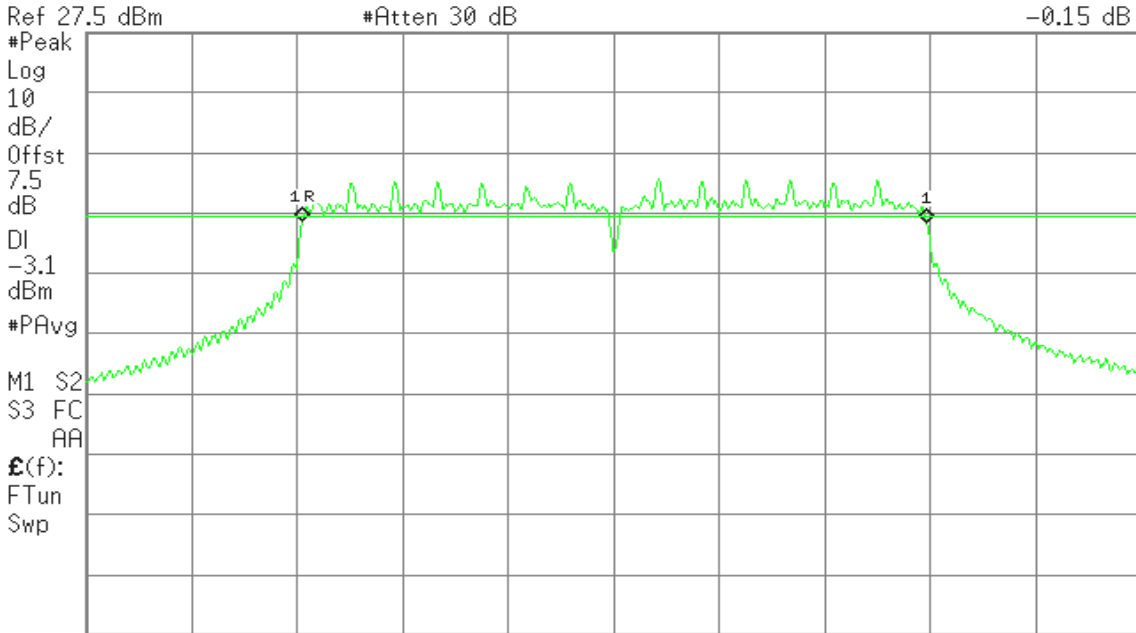

Center 2.412 00 GHz

#Res BW 100 kHz

#VBW 300 kHz

Span 30 MHz

Sweep 2.88 ms (601 pts)

6dB Bandwidth (CH Mid)

Agilent

R T

Mkr1 17.75 MHz
-0.19 dB

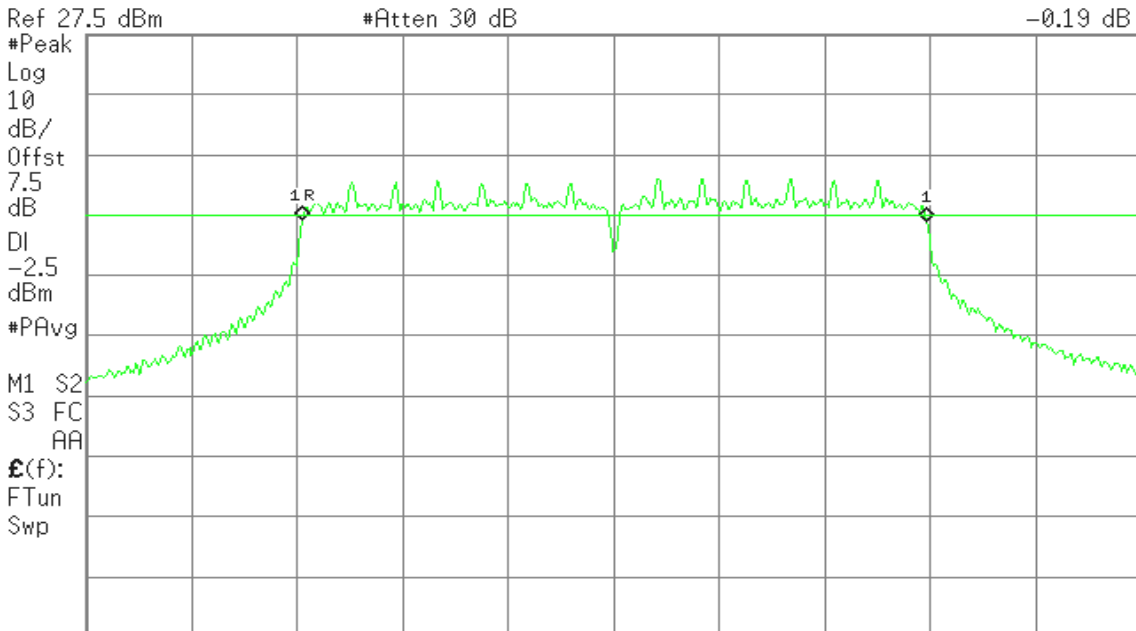

Center 2.437 00 GHz

#Res BW 100 kHz

#VBW 300 kHz

Span 30 MHz

Sweep 2.88 ms (601 pts)



6dB Bandwidth (CH High)

Agilent

R T

Mkr1 17.70 MHz
-0.89 dB

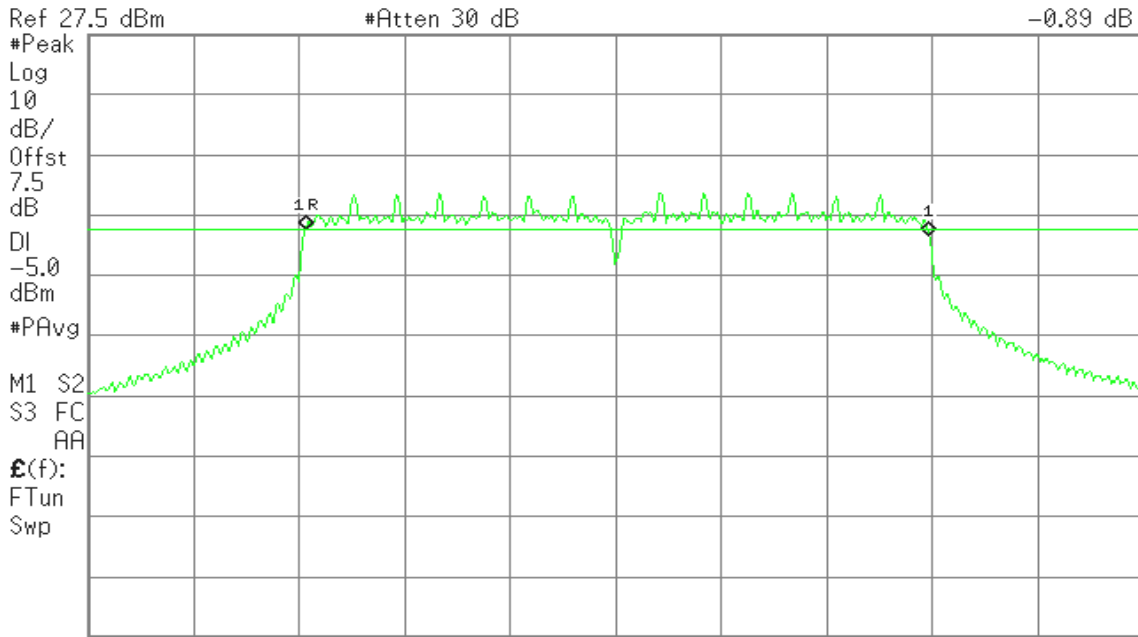

Center 2.462 00 GHz #Res BW 100 kHz #VBW 300 kHz Sweep 2.88 ms (601 pts) Span 30 MHz

IEEE 802.11n HT40 mode

6dB Bandwidth (CH Low)

Agilent

R T

Mkr1 35.50 MHz
-0.69 dB

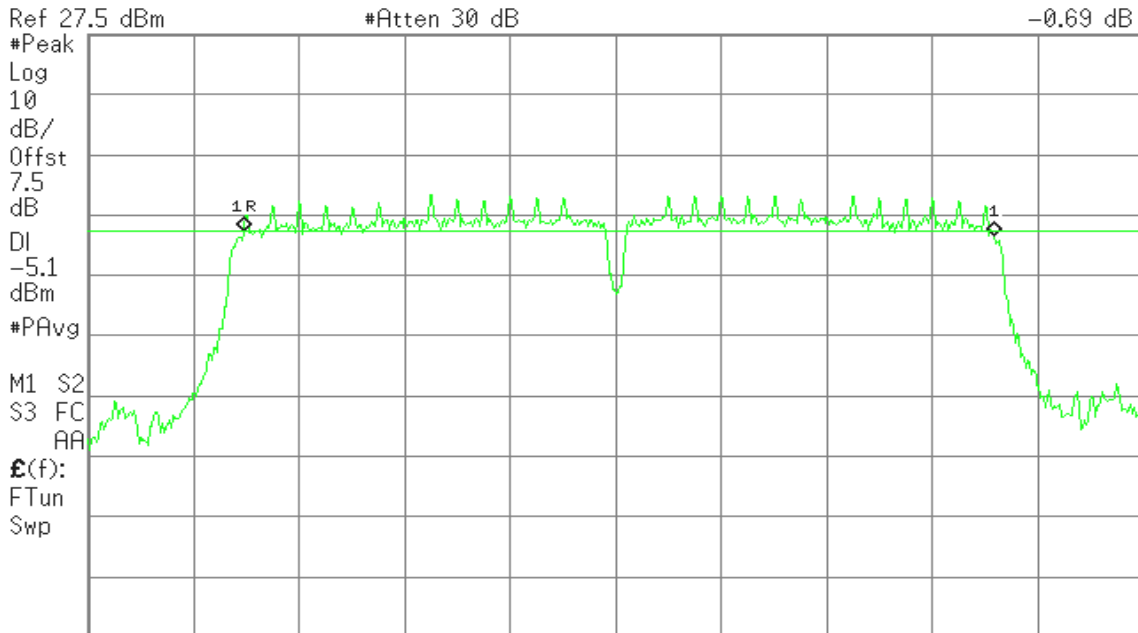

Center 2.422 00 GHz #Res BW 100 kHz #VBW 300 kHz Sweep 4.8 ms (601 pts) Span 50 MHz



6dB Bandwidth (CH Mid)

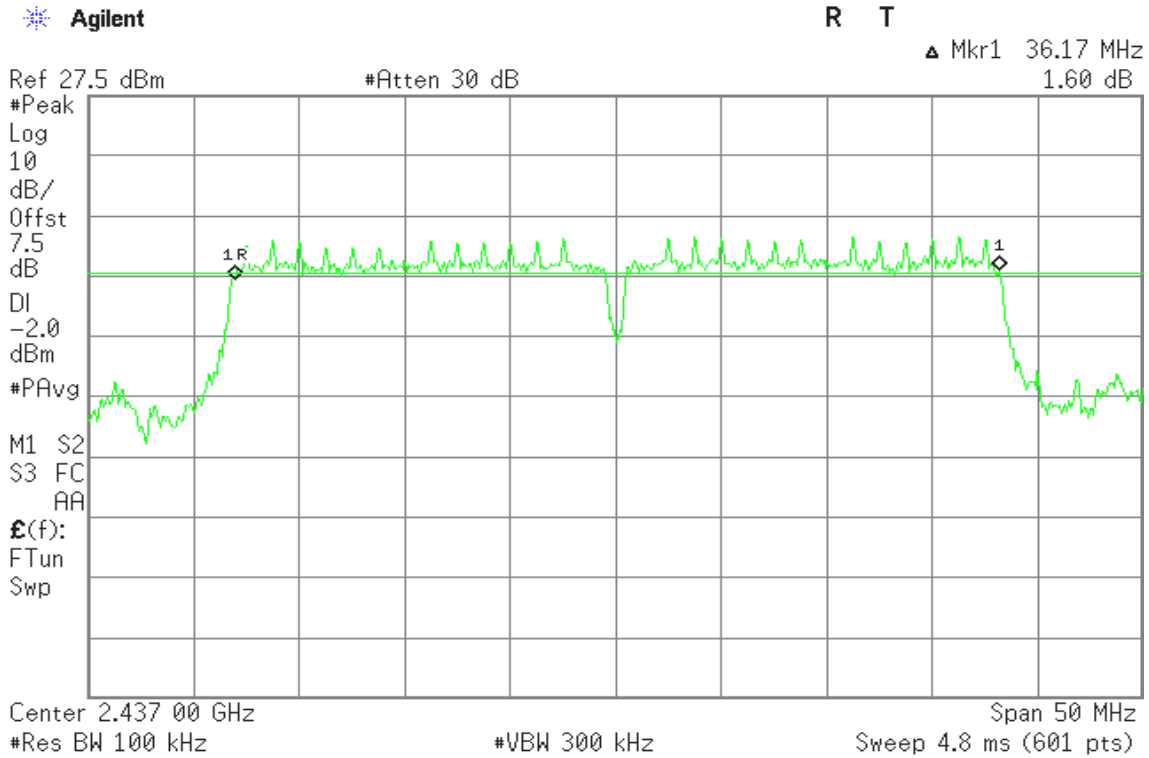

6dB Bandwidth (CH High)

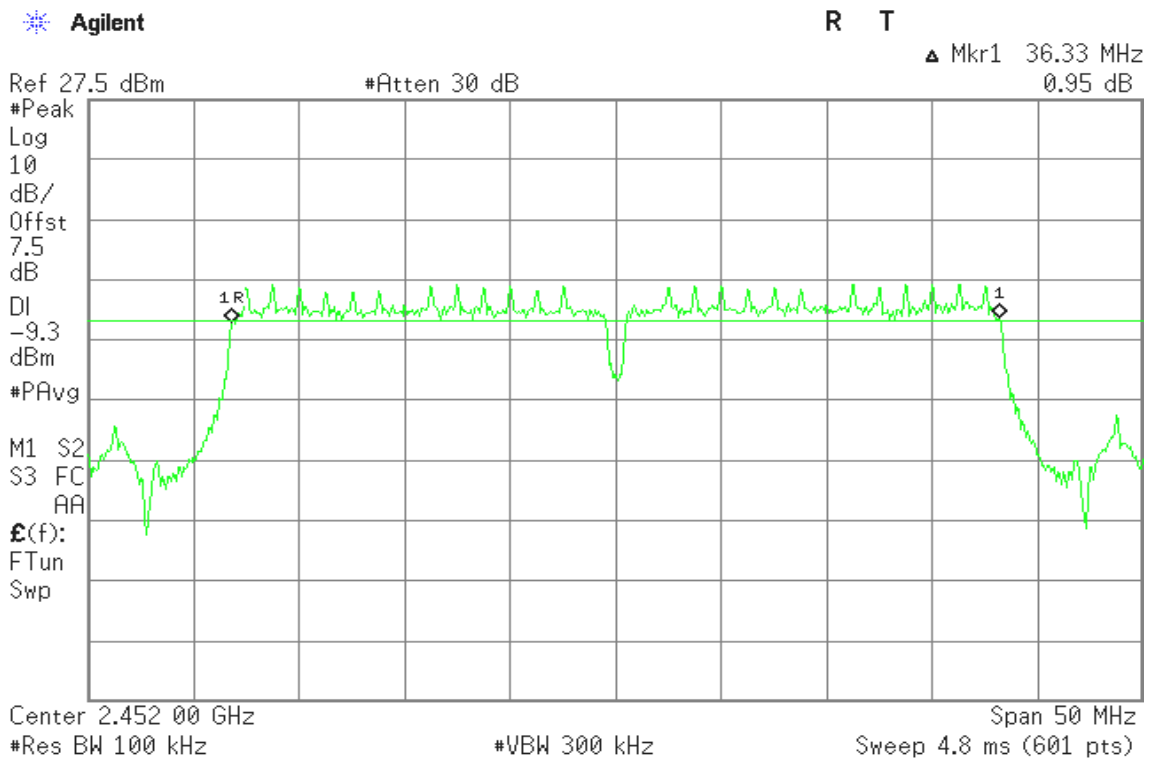



7.2 PEAK POWER

LIMIT

The maximum peak output power of the intentional radiator shall not exceed the following:

1. According to §15.247(b)(3), for systems using digital modulation in the bands of 902-928 MHz, 2400-2483.5 MHz, and 5725-5850 MHz: 1 Watt.
2. According to §15.247(b)(4), the conducted output power limit specified in paragraph (b) of this section is based on the use of antennas with directional gains that do not exceed 6 dBi. Except as shown in paragraph (c) of this section, if transmitting antennas of directional gain greater than 6 dBi are used, the conducted output power from the intentional radiator shall be reduced below the stated values in paragraphs (b)(1), (b)(2), and (b)(3) of this section, as appropriate, by the amount in dB that the directional gain of the antenna exceeds 6 dBi.

Test Configuration

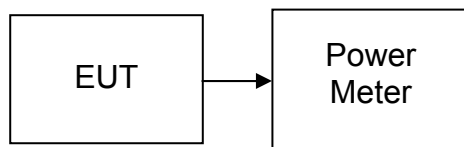

TEST PROCEDURE

Per KDB 558074 v03r01

The transmitter output is connected to the Power Meter. The Power Meter is set to the peak power detection.

TEST RESULTS

No non-compliance noted



Test Data

Test mode: IEEE 802.11b mode

Channel	Frequency (MHz)	Output Power (dBm)	Output Power (W)	Limit (W)	Test Result
Low	2412	15.91	0.0390	1	PASS
Mid	2437	15.99	0.0397		PASS
High	2462	15.05	0.0320		PASS

Test mode: IEEE 802.11g mode

Channel	Frequency (MHz)	Output Power (dBm)	Output Power (W)	Limit (W)	Test Result
Low	2412	22.20	0.1660	1	PASS
Mid	2437	22.52	0.1786		PASS
High	2462	22.42	0.1746		PASS

Test mode: IEEE 802.11n HT20 mode

Channel	Frequency (MHz)	Output Power (dBm)	Output Power (W)	Limit (W)	Test Result
Low	2412	22.01	0.1589	1	PASS
Mid	2437	22.41	0.1742		PASS
High	2462	20.34	0.1081		PASS

Test mode: IEEE 802.11n HT40 mode

Channel	Frequency (MHz)	Output Power (dBm)	Output Power (W)	Limit (W)	Test Result
Low	2422	21.07	0.1279	1	PASS
Mid	2437	24.20	0.2630		PASS
High	2452	17.44	0.0555		PASS



7.3 AVERAGE POWER

LIMIT

None; for reporting purposes only.

Test Configuration

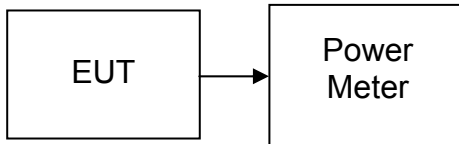

TEST PROCEDURE

Per KDB 558074 v03r01

The transmitter output is connected to the Power Meter. The Power Meter is set to the peak power detection.

TEST RESULTS

No non-compliance noted



Test Data

Test mode: IEEE 802.11b mode

Channel	Frequency (MHz)	Output Power (dBm)	Output Power (W)
Low	2412	12.96	0.0198
Mid	2437	12.96	0.0198
High	2462	12.03	0.0160

Test mode: IEEE 802.11g mode

Channel	Frequency (MHz)	Output Power (dBm)	Output Power (W)
Low	2412	15.01	0.0317
Mid	2437	15.23	0.0333
High	2462	13.31	0.0214

Test mode: IEEE 802.11n HT20 mode

Channel	Frequency (MHz)	Output Power (dBm)	Output Power (W)
Low	2412	14.88	0.0308
Mid	2437	15.22	0.0333
High	2462	13.25	0.0211

Test mode: IEEE 802.11n HT40 mode

Channel	Frequency (MHz)	Output Power (dBm)	Output Power (W)
Low	2422	13.44	0.0221
Mid	2437	17.43	0.0553
High	2452	9.87	0.0097



7.4 BAND EDGES MEASUREMENT

LIMIT

According to §15.247(d), in any 100 kHz bandwidth outside the frequency bands in which the spread spectrum intentional radiator is operating, the radio frequency power that is produced by the intentional radiator shall be at least 20 dB below that in the 100 kHz bandwidth within the band that contains the highest level of the desired power, based on either an RF conducted or a radiated measurement, provided the transmitter demonstrates compliance with the peak conducted power limits. In addition, radiated emissions which fall in the restricted bands, as defined in §15.205(a), must also comply with the radiated emission limits specified in 15.209(a) (see Section 15.205(c)).

Test Configuration

For Radiated

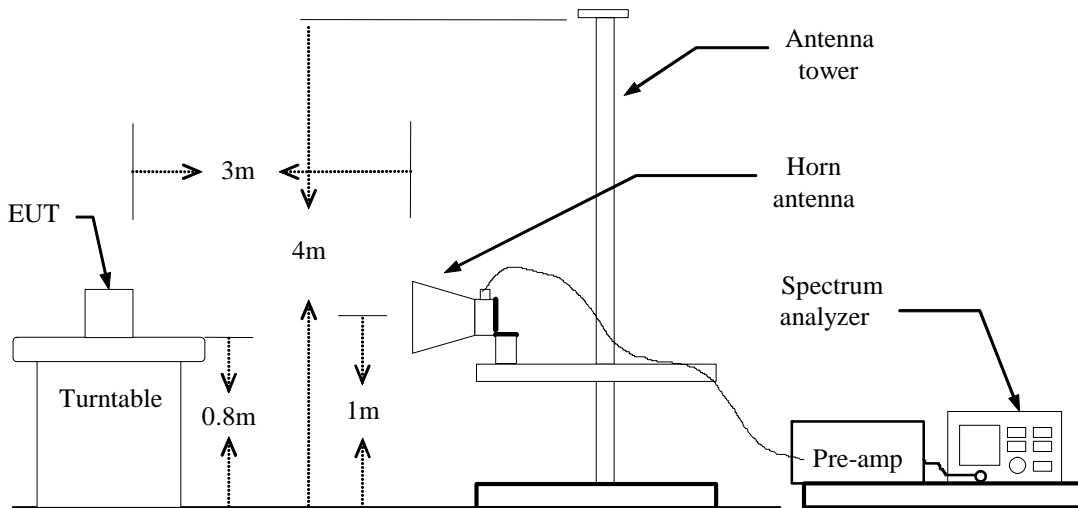

For Conducted

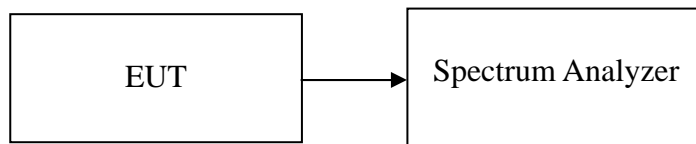



TEST PROCEDURE

For Radiated

1. The EUT is placed on a turntable, which is 0.8m above the ground plane.
2. The turntable shall be rotated for 360 degrees to determine the position of maximum emission level.
3. EUT is set 3m away from the receiving antenna, which is varied from 1m to 4m to find out the highest emission.
4. Set the spectrum analyzer in the following setting in order to capture the lower and upper band-edges of the emission:
 - (a) PEAK: RBW=1MHz / VBW=3MHz / Sweep=AUTO
 - (b) AVERAGE: RBW=1MHz / VBW=300Hz / Sweep=AUTO
5. Repeat the procedures until all the PEAK and AVERAGE versus POLARIZATION are measured.

For Conducted

Conducted RF measurements of the transmitter output were made to confirm that the EUT antenna port conducted emissions meet the specified limit and to identify any spurious signals that require further investigation or measurements on the radiated emissions site.

The transmitter output is connected to the spectrum analyzer. The resolution bandwidth is set to 100 kHz. The video bandwidth is set to 100 kHz.

TEST RESULTS

Refer to attach spectrum analyzer data chart.



TEST DATA

Band Edges (IEEE 802.11b mode / CH Low)

Detector mode: Peak

Polarity: Vertical

Agilent

R L

Mkr1 2.390 00 GHz
51.88 dBµV/m

Ref 123 dBµV/m

#Atten 20 dB

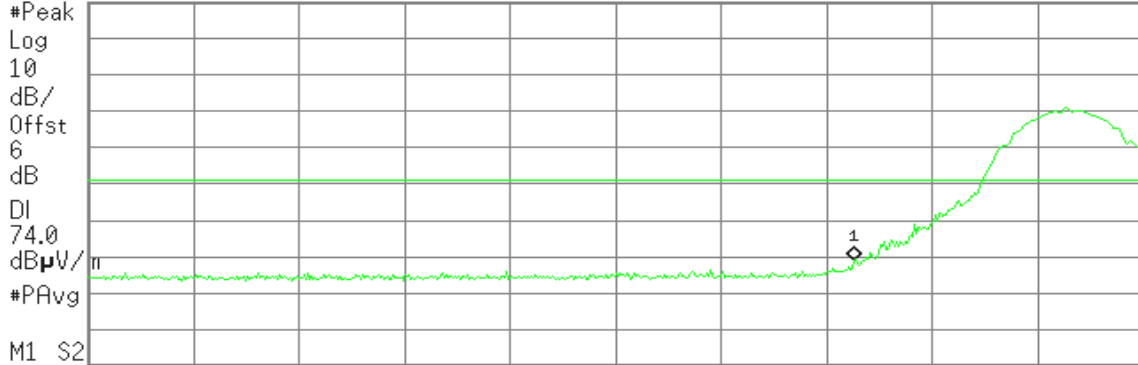

Start 2.310 00 GHz

Stop 2.420 00 GHz

#Res BW 1 MHz

#VBW 3 MHz

#Sweep 100 ms (601 pts)

Marker	Trace	Type	X Axis	Amplitude
1	(1)	Freq	2.390 00 GHz	51.88 dBµV/m

Detector mode: Average

Polarity: Vertical

Agilent

R L

Mkr1 2.390 00 GHz
38.98 dBµV/m

Ref 123 dBµV/m

#Atten 20 dB



Start 2.310 00 GHz

Stop 2.420 00 GHz

#Res BW 1 MHz

#VBW 300 Hz

Sweep 285.9 ms (601 pts)

Marker	Trace	Type	X Axis	Amplitude
1	(1)	Freq	2.390 00 GHz	38.98 dBµV/m



Detector mode: Peak

Polarity: Horizontal

Agilent

R T

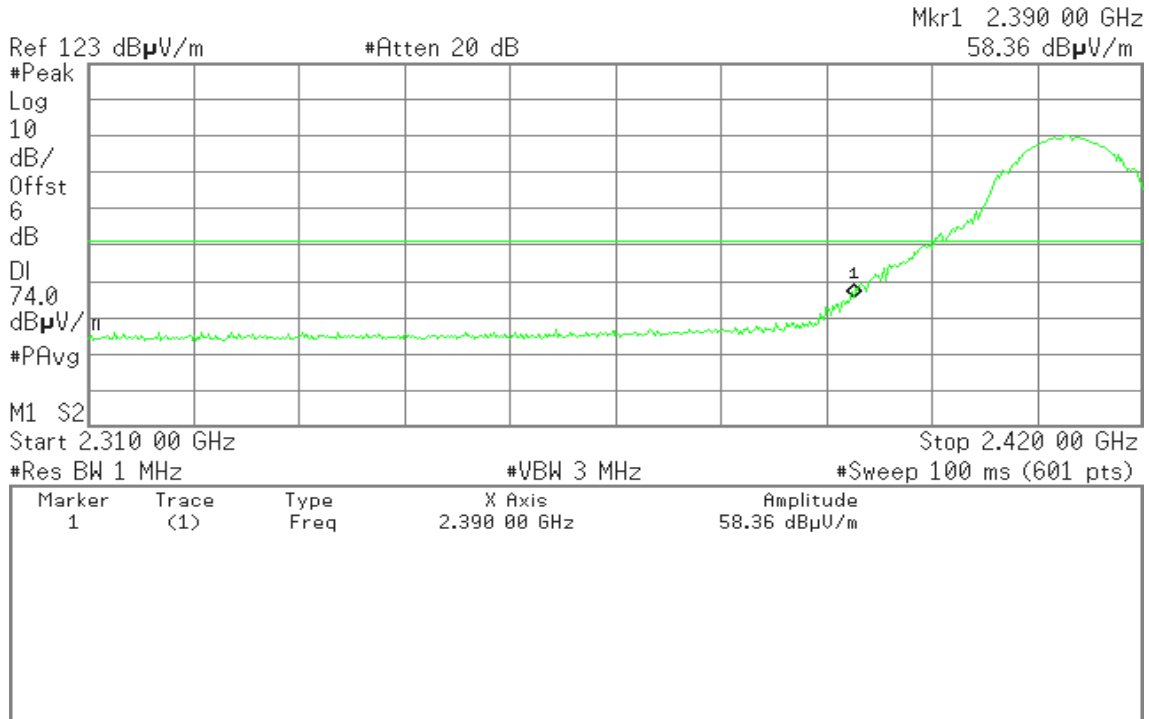

Detector mode: Average

Polarity: Horizontal

Agilent

R L

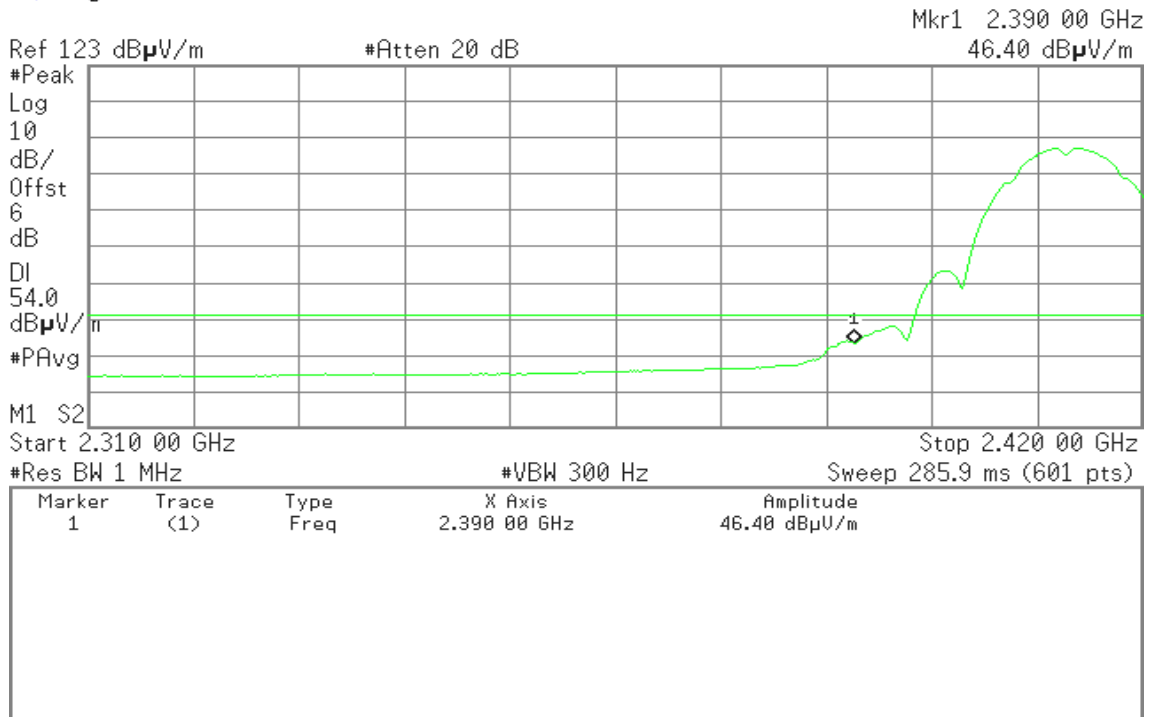



Band Edges (IEEE 802.11b mode / CH High)

Detector mode: Peak

Polarity: Vertical

Agilent

R L

Mkr1 2.483 50 GHz

53.65 dBµV/m

Ref 123 dBµV/m

#Atten 20 dB

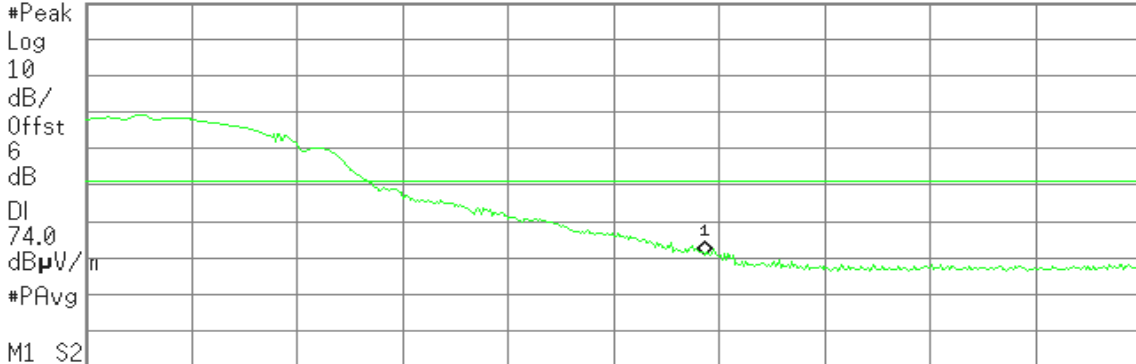

Start 2.460 00 GHz

Stop 2.500 00 GHz

#Res BW 1 MHz

#VBW 3 MHz

#Sweep 100 ms (601 pts)

Marker	Trace	Type	X Axis	Amplitude
1	(1)	Freq	2.483 50 GHz	53.65 dBµV/m

Detector mode: Average

Polarity: Vertical

Agilent

R L

Mkr1 2.483 50 GHz

42.024 dBµV/m

Ref 123 dBµV/m

#Atten 20 dB

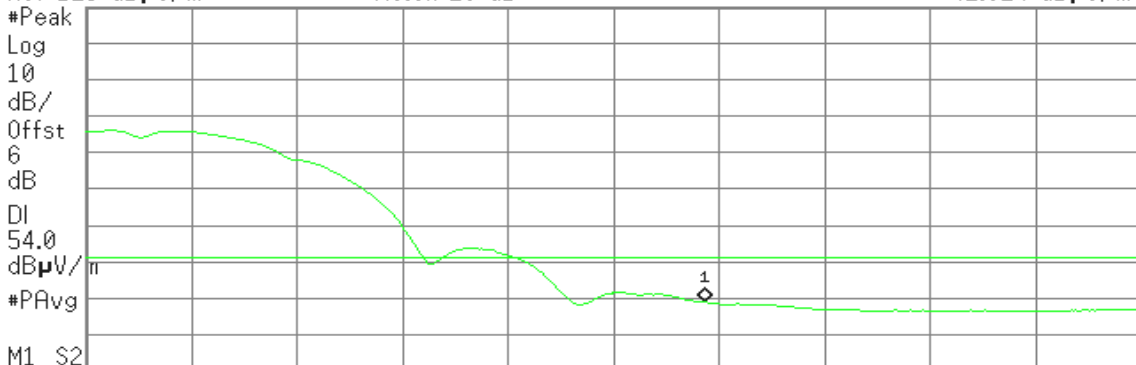

Start 2.460 00 GHz

Stop 2.500 00 GHz

#Res BW 1 MHz

#VBW 300 Hz

Sweep 104 ms (601 pts)

Marker	Trace	Type	X Axis	Amplitude
1	(1)	Freq	2.483 50 GHz	42.02 dBµV/m



Detector mode: Peak

Polarity: Horizontal

Agilent

R L

Mkr1 2.483 50 GHz
64.34 dBµV/m

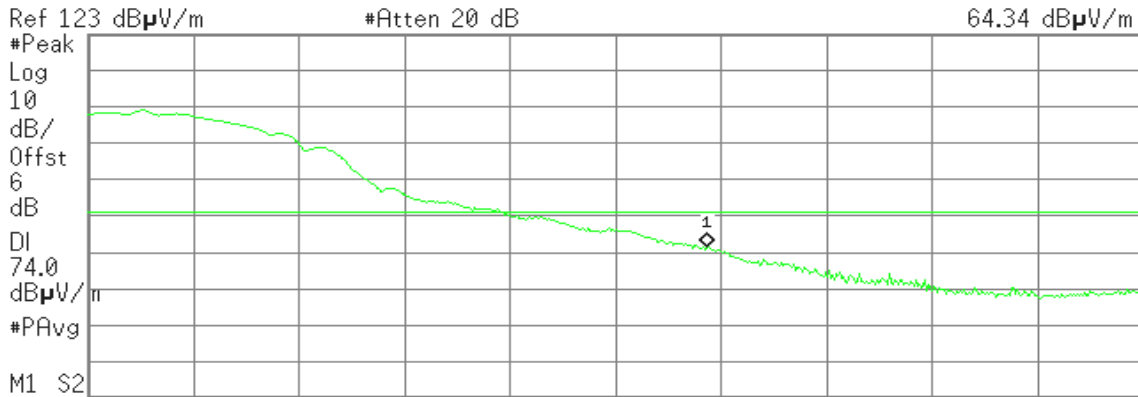

Start 2.460 00 GHz Stop 2.500 00 GHz
#Res BW 1 MHz #VBW 3 MHz #Sweep 100 ms (601 pts)

Marker	Trace	Type	X Axis	Amplitude
1	(1)	Freq	2.483 50 GHz	64.34 dBµV/m

Detector mode: Average

Polarity: Horizontal

Agilent

R L

Mkr1 2.483 50 GHz
49.672 dBµV/m

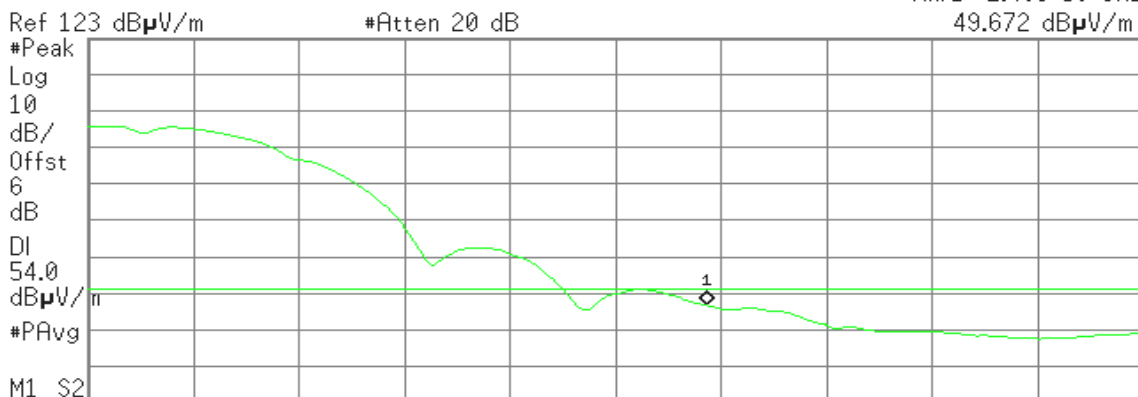

Start 2.460 00 GHz Stop 2.500 00 GHz
#Res BW 1 MHz #VBW 300 Hz Sweep 104 ms (601 pts)

Marker	Trace	Type	X Axis	Amplitude
1	(1)	Freq	2.483 50 GHz	49.67 dBµV/m



Band Edges (IEEE 802.11g mode / CH Low)

Detector mode: Peak

Polarity: Vertical

Agilent

R T

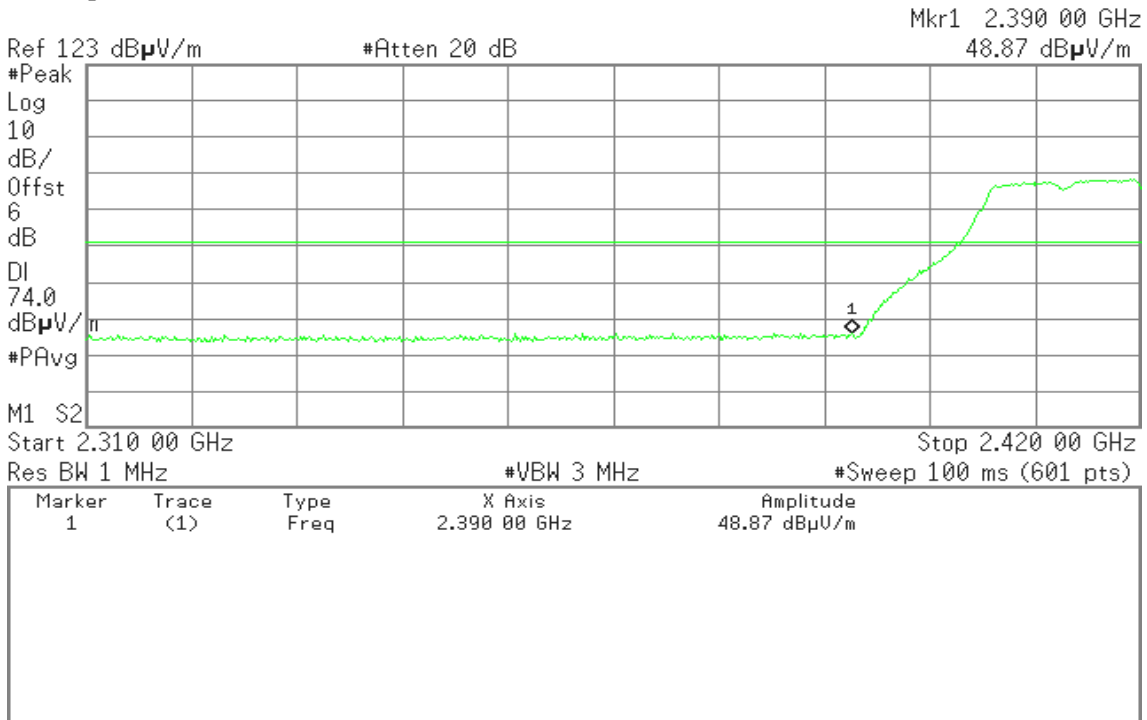

Detector mode: Average

Polarity: Vertical

Agilent

R T

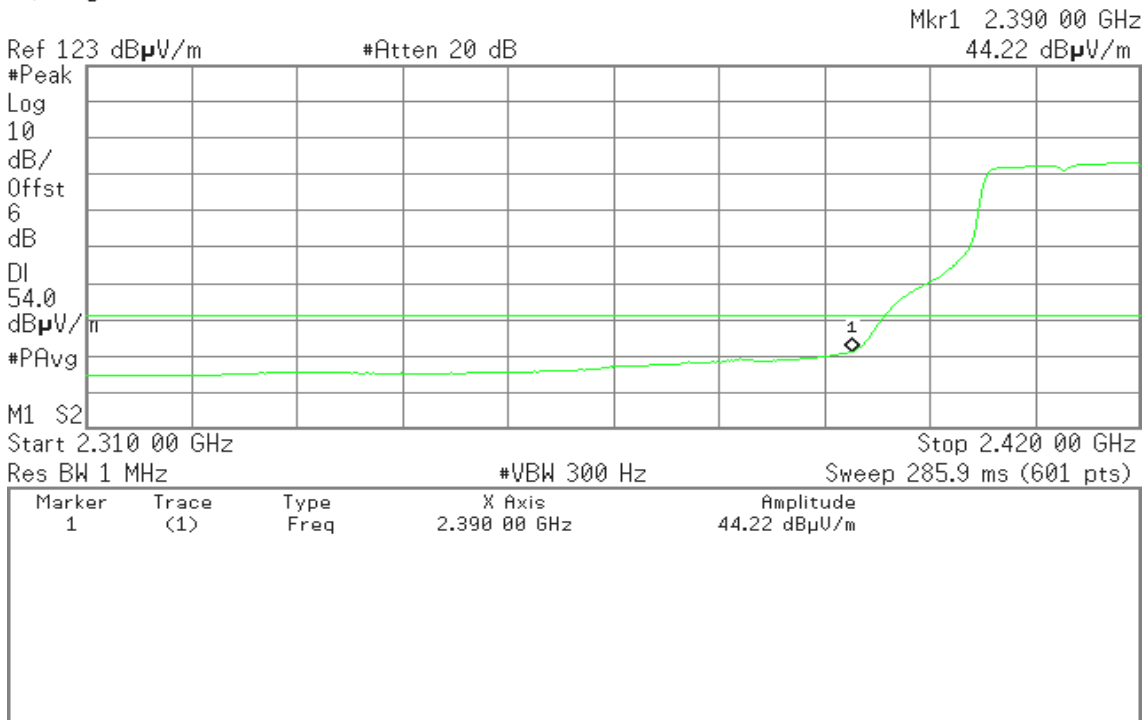



Detector mode: Peak

Polarity: Horizontal

Agilent

R T

Mkr1 2.390 00 GHz
55.37 dBµV/m

Ref 123 dBµV/m

#Atten 20 dB

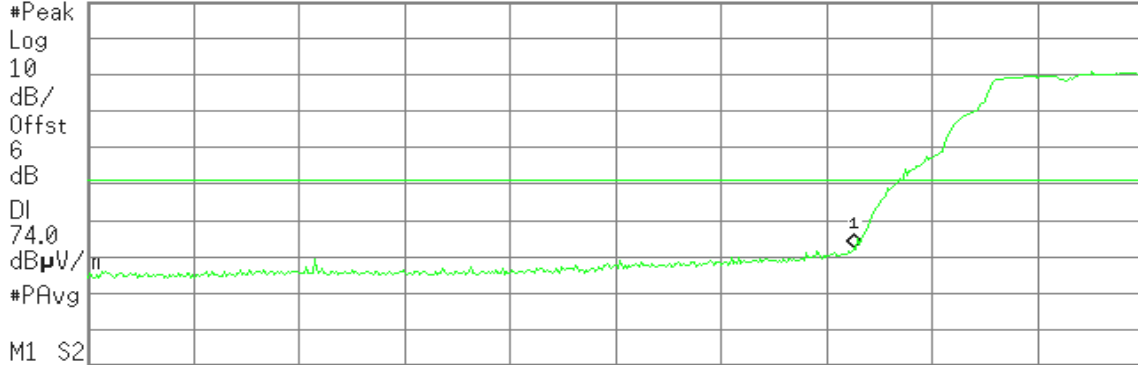

M1 S2
Start 2.310 00 GHz

Stop 2.420 00 GHz

Res BW 1 MHz

#VBW 3 MHz

#Sweep 100 ms (601 pts)

Marker	Trace	Type	X Axis	Amplitude
1	(1)	Freq	2.390 00 GHz	55.37 dBµV/m

Detector mode: Average

Polarity: Horizontal

Agilent

R T

Mkr1 2.390 00 GHz
44.22 dBµV/m

Ref 123 dBµV/m

#Atten 20 dB

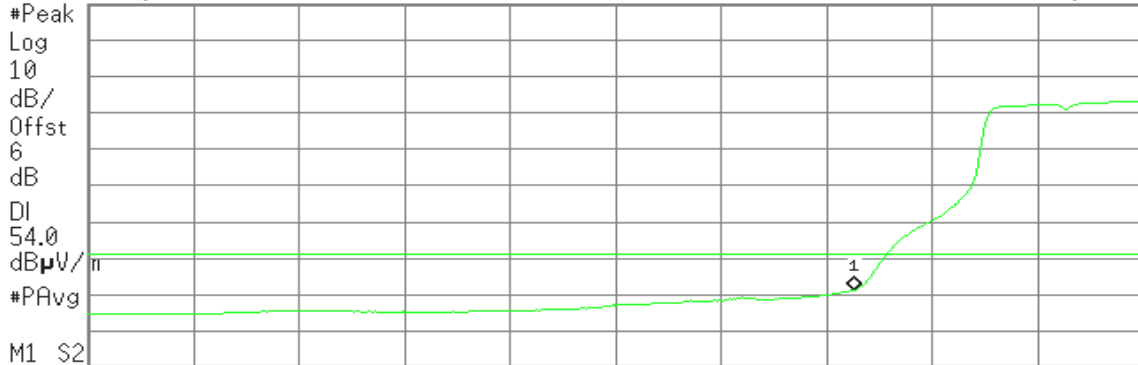

M1 S2
Start 2.310 00 GHz

Stop 2.420 00 GHz

Res BW 1 MHz

#VBW 300 Hz

Sweep 285.9 ms (601 pts)

Marker	Trace	Type	X Axis	Amplitude
1	(1)	Freq	2.390 00 GHz	44.22 dBµV/m



Band Edges (IEEE 802.11g mode / CH High)

Detector mode: Peak

Polarity: Vertical

Agilent

R T

Mkr2 2.484 00 GHz

61.67 dBµV/m

Ref 123 dBµV/m

#Atten 20 dB

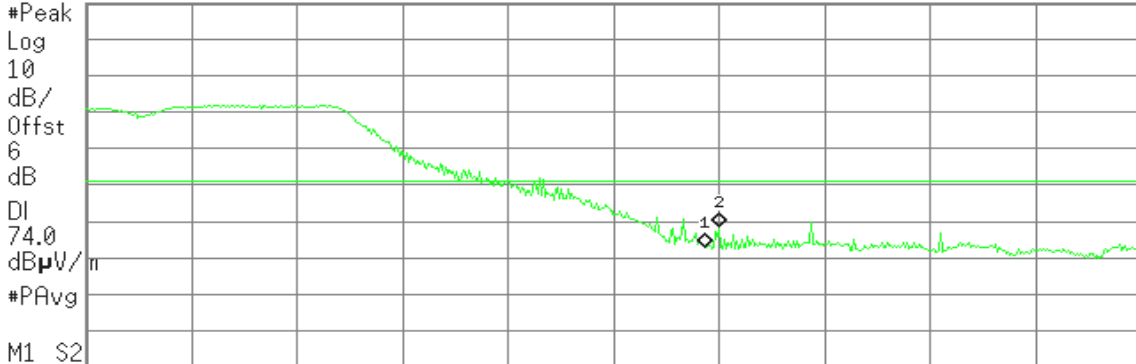

Start 2.460 00 GHz

Stop 2.500 00 GHz

#Res BW 1 MHz

#VBW 3 MHz

#Sweep 100 ms (601 pts)

Marker	Trace	Type	X Axis	Amplitude
1	(1)	Freq	2.483 50 GHz	55.82 dBµV/m
2	(1)	Freq	2.484 00 GHz	61.67 dBµV/m

Detector mode: Average

Polarity: Vertical

Agilent

R T

Mkr2 2.484 00 GHz

41.74 dBµV/m

Ref 123 dBµV/m

#Atten 20 dB

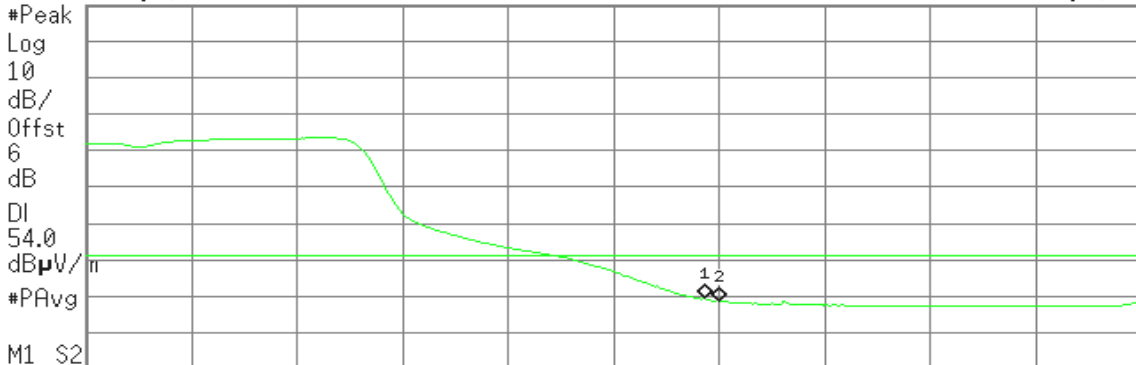

Start 2.460 00 GHz

Stop 2.500 00 GHz

#Res BW 1 MHz

#VBW 300 Hz

Sweep 104 ms (601 pts)

Marker	Trace	Type	X Axis	Amplitude
1	(1)	Freq	2.483 50 GHz	42.38 dBµV/m
2	(1)	Freq	2.484 00 GHz	41.74 dBµV/m



Detector mode: Peak

Polarity: Horizontal

Agilent

R T

Mkr2 2.485 73 GHz
68.00 dBµV/m

Ref 123 dBµV/m

#Atten 20 dB

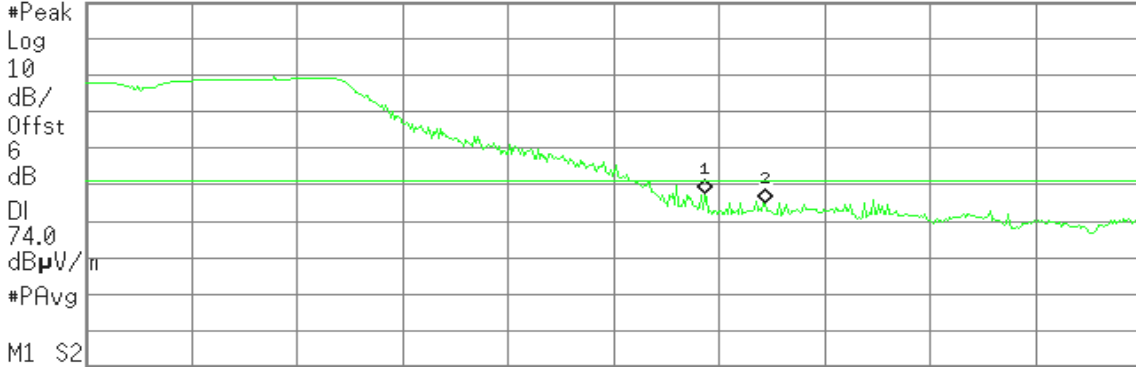

Start 2.460 00 GHz

Stop 2.500 00 GHz

#Res BW 1 MHz

#VBW 3 MHz

#Sweep 100 ms (601 pts)

Marker	Trace	Type	X Axis	Amplitude
1	(1)	Freq	2.483 50 GHz	70.42 dBµV/m
2	(1)	Freq	2.485 73 GHz	68.00 dBµV/m

Detector mode: Average

Polarity: Horizontal

Agilent

R T

Mkr2 2.485 73 GHz
47.32 dBµV/m

Ref 123 dBµV/m

#Atten 20 dB

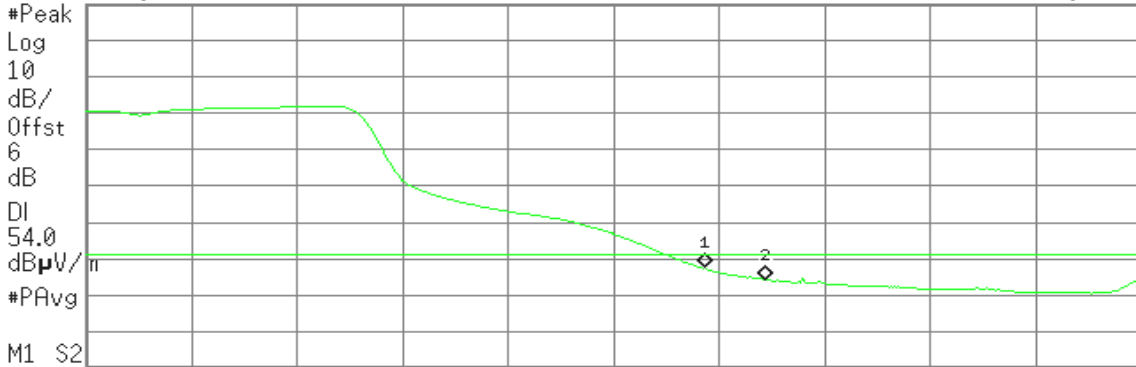

Start 2.460 00 GHz

Stop 2.500 00 GHz

#Res BW 1 MHz

#VBW 300 Hz

Sweep 104 ms (601 pts)

Marker	Trace	Type	X Axis	Amplitude
1	(1)	Freq	2.483 50 GHz	50.91 dBµV/m
2	(1)	Freq	2.485 73 GHz	47.32 dBµV/m



Band Edges (IEEE 802.11n HT20 mode / CH Low)

Detector mode: Peak

Polarity: Vertical

Agilent

R T

Mkr1 2.390 00 GHz

53.97 dBµV/m

Ref 123 dBµV/m

#Atten 20 dB

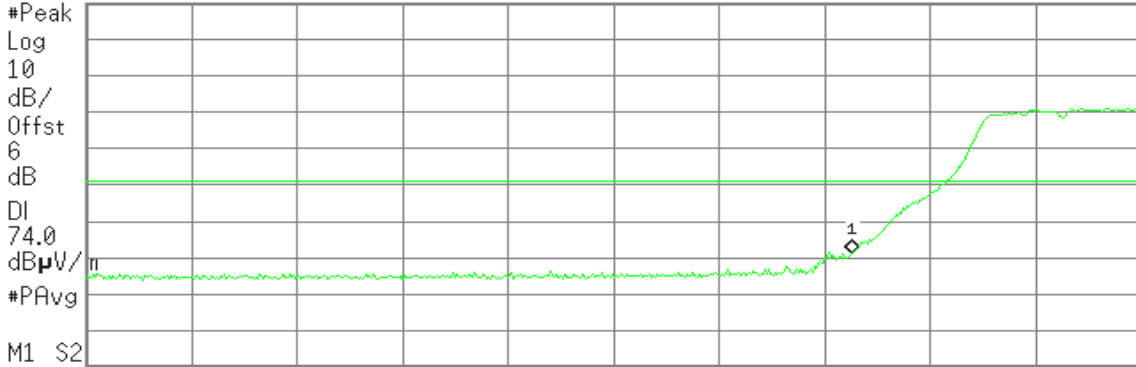

Start 2.310 00 GHz

Stop 2.420 00 GHz

Res BW 1 MHz

#VBW 3 MHz

#Sweep 100 ms (601 pts)

Marker	Trace	Type	X Axis	Amplitude
1	(1)	Freq	2.390 00 GHz	53.97 dBµV/m

Detector mode: Average

Polarity: Vertical

Agilent

R T

Mkr1 2.390 00 GHz

38.84 dBµV/m

Ref 123 dBµV/m

#Atten 20 dB

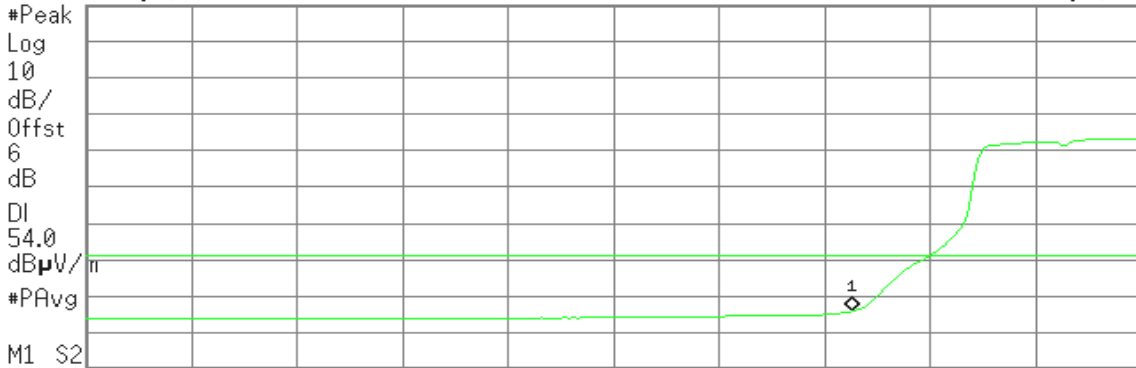

Start 2.310 00 GHz

Stop 2.420 00 GHz

Res BW 1 MHz

#VBW 300 Hz

Sweep 285.9 ms (601 pts)

Marker	Trace	Type	X Axis	Amplitude
1	(1)	Freq	2.390 00 GHz	38.84 dBµV/m



Detector mode: Peak

Polarity: Horizontal

Agilent

R T

Mkr1 2.390 00 GHz
68.04 dBµV/m

Ref 123 dBµV/m

#Atten 20 dB

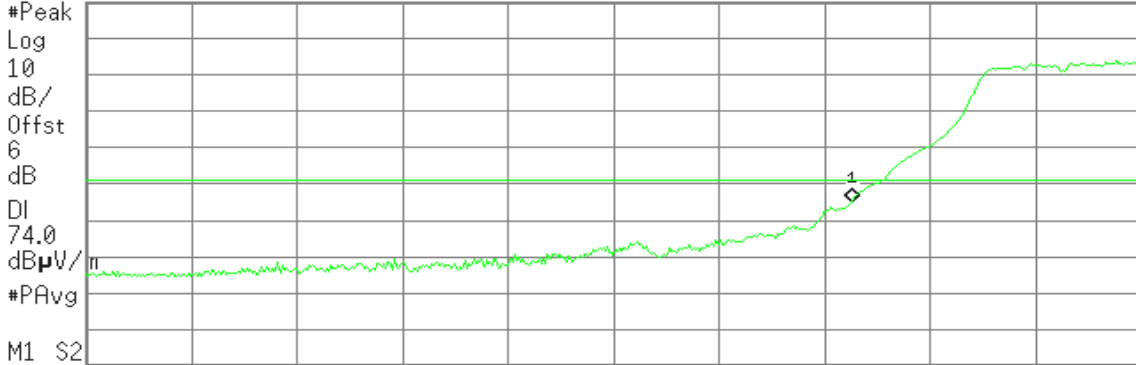

M1 S2
Start 2.310 00 GHz

Stop 2.420 00 GHz

Res BW 1 MHz

#VBW 3 MHz

#Sweep 100 ms (601 pts)

Marker	Trace	Type	X Axis	Amplitude
1	(1)	Freq	2.390 00 GHz	68.04 dBµV/m

Detector mode: Average

Polarity: Horizontal

Agilent

R T

Mkr1 2.390 00 GHz
49.68 dBµV/m

Ref 123 dBµV/m

#Atten 20 dB

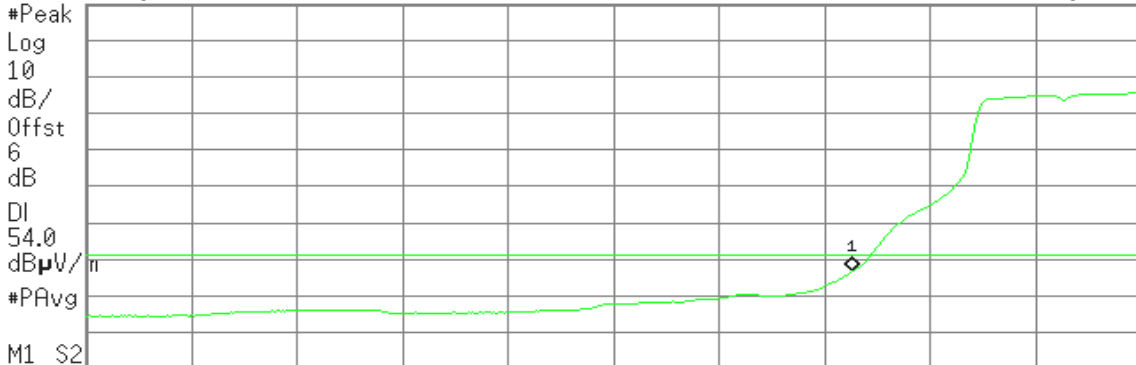

M1 S2
Start 2.310 00 GHz

Stop 2.420 00 GHz

Res BW 1 MHz

#VBW 300 Hz

Sweep 285.9 ms (601 pts)

Marker	Trace	Type	X Axis	Amplitude
1	(1)	Freq	2.390 00 GHz	49.68 dBµV/m



Band Edges (IEEE 802.11n HT20 mode / CH High)

Detector mode: Peak

Polarity: Vertical

Agilent

R T

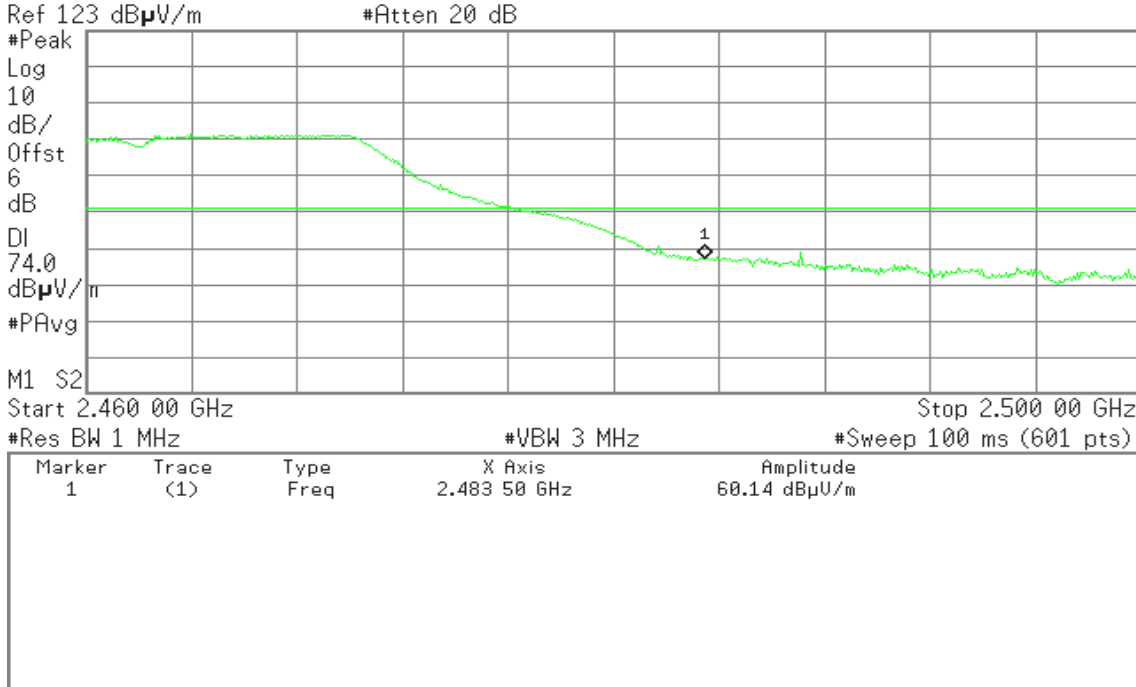

Detector mode: Average

Polarity: Vertical

Agilent

R T

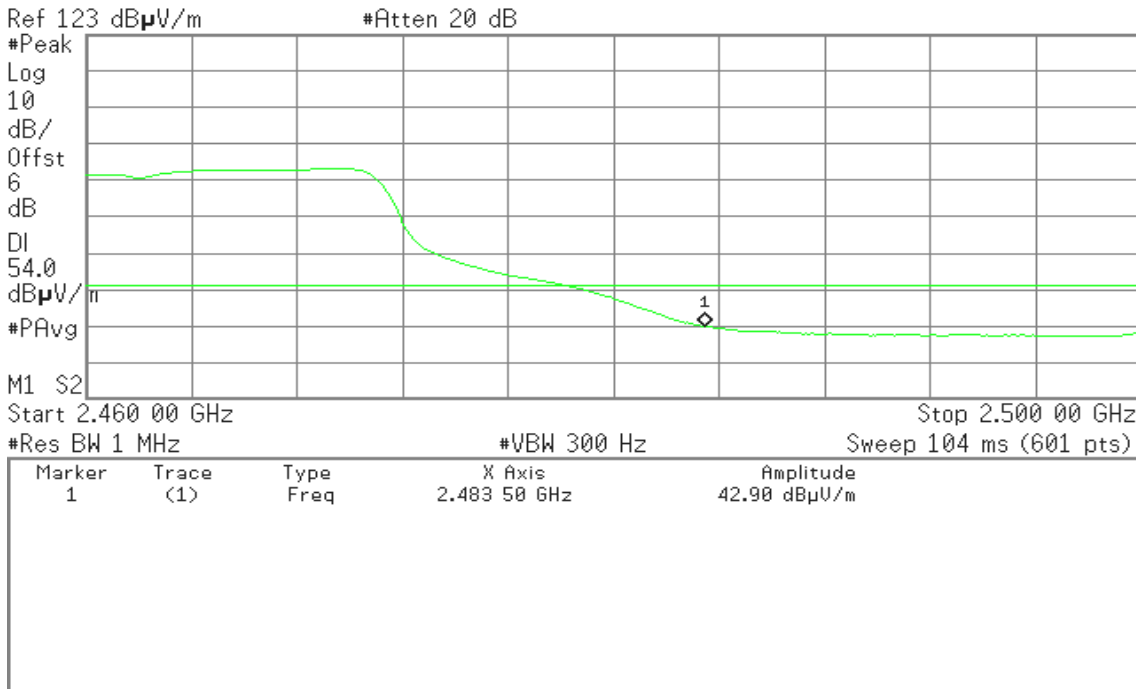



Detector mode: Peak

Polarity: Horizontal

Agilent

R T

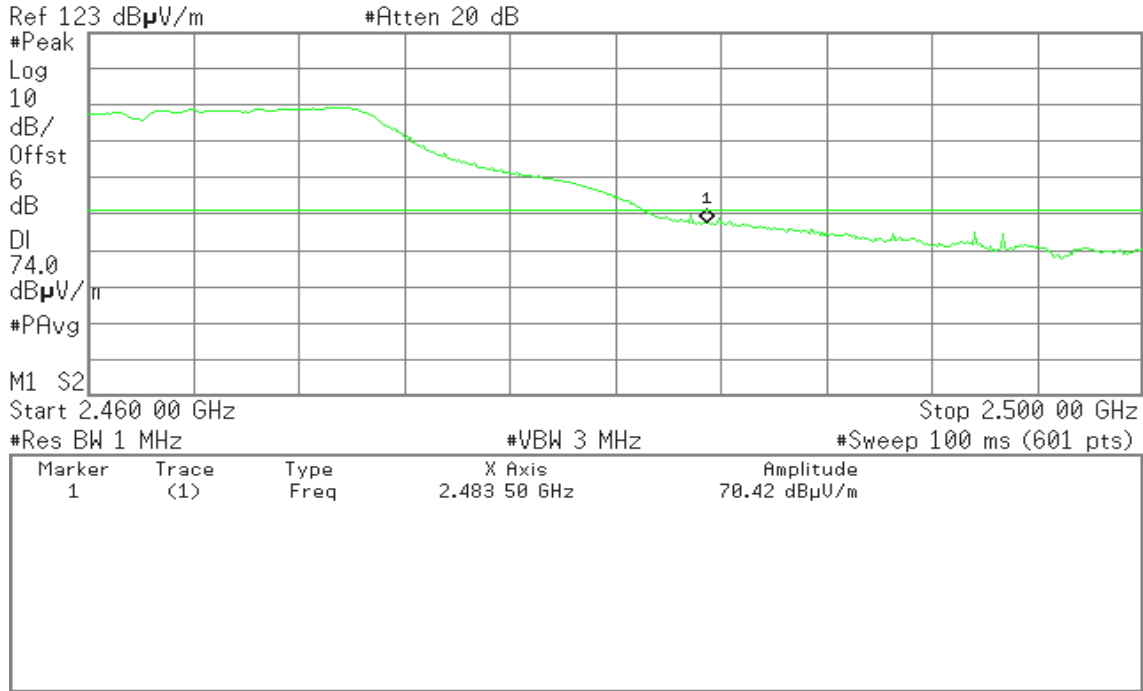

Detector mode: Average

Polarity: Horizontal

Agilent

R T

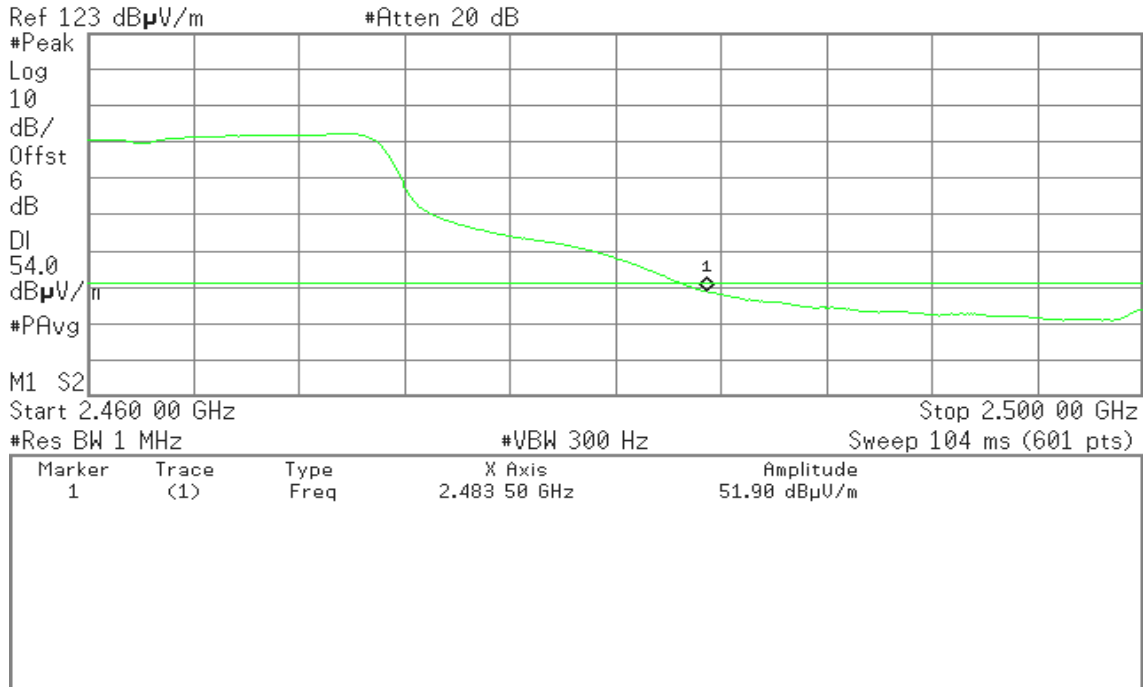



Band Edges (IEEE 802.11n HT40 mode / CH Low)

Detector mode: Peak

Polarity: Vertical

Agilent

R T

Mkr2 2.390 00 GHz

55.29 dBµV/m

Ref 123 dBµV/m

#Atten 20 dB

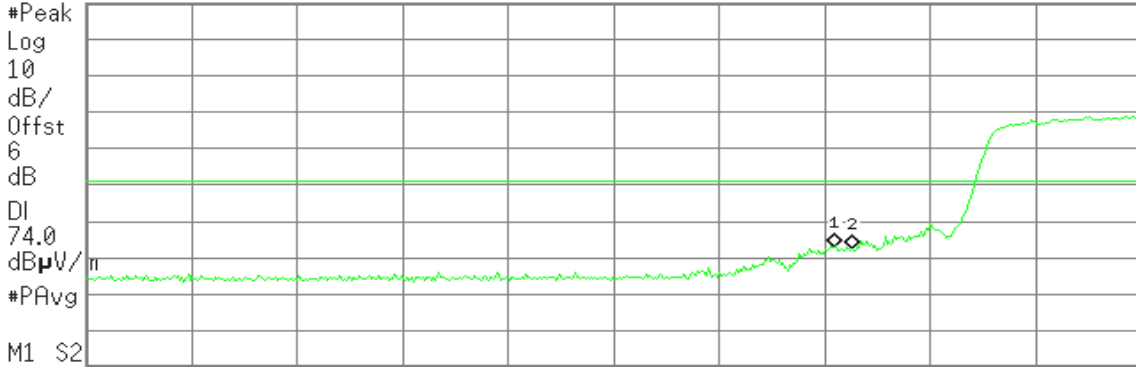

Start 2.310 00 GHz

Stop 2.420 00 GHz

Res BW 1 MHz

#VBW 3 MHz

#Sweep 100 ms (601 pts)

Marker	Trace	Type	X Axis	Amplitude
1	(1)	Freq	2.388 17 GHz	55.80 dBµV/m
2	(1)	Freq	2.390 00 GHz	55.29 dBµV/m

Detector mode: Average

Polarity: Vertical

Agilent

R T

Mkr2 2.390 00 GHz

40.37 dBµV/m

Ref 123 dBµV/m

#Atten 20 dB



Start 2.310 00 GHz

Stop 2.420 00 GHz

Res BW 1 MHz

#VBW 300 Hz

Sweep 285.9 ms (601 pts)

Marker	Trace	Type	X Axis	Amplitude
1	(1)	Freq	2.388 17 GHz	40.03 dBµV/m
2	(1)	Freq	2.390 00 GHz	40.37 dBµV/m



Detector mode: Peak

Polarity: Horizontal

Agilent

R T

Mkr2 2.390 00 GHz
68.00 dBµV/m

Ref 123 dBµV/m

#Atten 20 dB

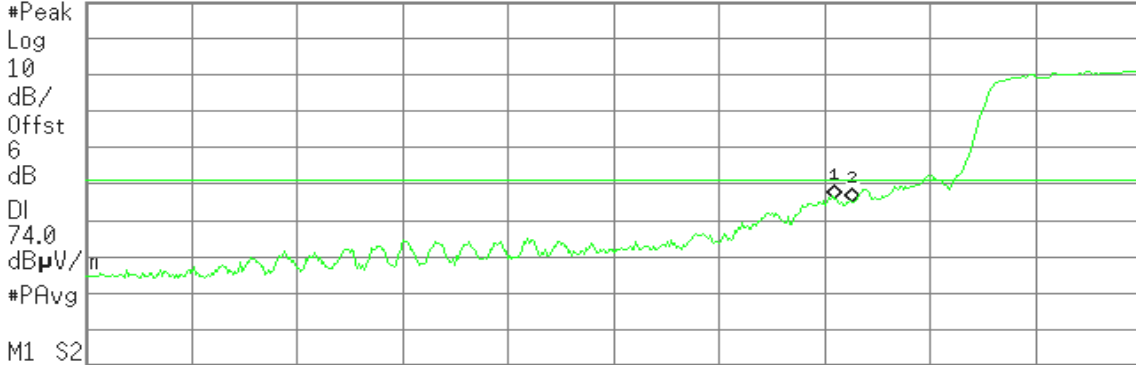

Start 2.310 00 GHz

Stop 2.420 00 GHz

Res BW 1 MHz

#VBW 3 MHz

#Sweep 100 ms (601 pts)

Marker	Trace	Type	X Axis	Amplitude
1	(1)	Freq	2.388 17 GHz	68.82 dBµV/m
2	(1)	Freq	2.390 00 GHz	68.00 dBµV/m

Detector mode: Average

Polarity: Horizontal

Agilent

R T

Mkr2 2.390 00 GHz
52.68 dBµV/m

Ref 123 dBµV/m

#Atten 20 dB

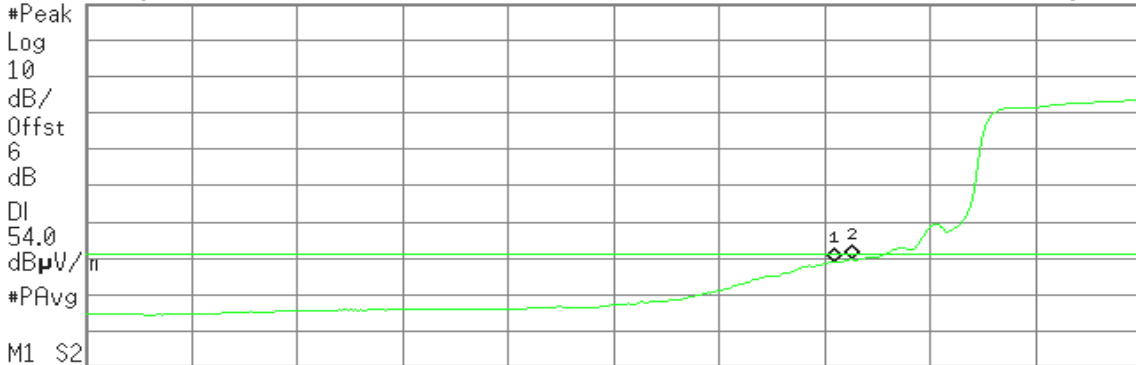

Start 2.310 00 GHz

Stop 2.420 00 GHz

Res BW 1 MHz

#VBW 300 Hz

Sweep 285.9 ms (601 pts)

Marker	Trace	Type	X Axis	Amplitude
1	(1)	Freq	2.388 17 GHz	52.00 dBµV/m
2	(1)	Freq	2.390 00 GHz	52.68 dBµV/m



Band Edges (IEEE 802.11n HT40 mode / CH High)

Detector mode: Peak

Polarity: Vertical

Agilent

R T

Mkr2 2.485 20 GHz

54.82 dBµV/m

Ref 123 dBµV/m

#Atten 20 dB

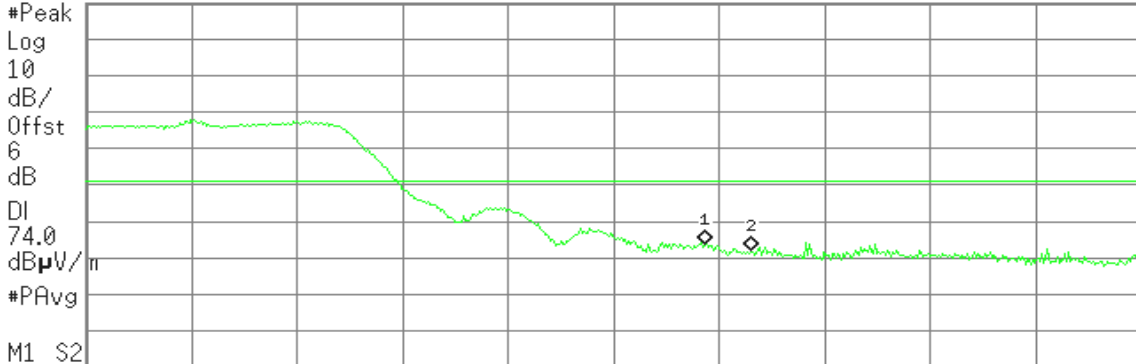

Start 2.460 00 GHz

Stop 2.500 00 GHz

#Res BW 1 MHz

#VBW 3 MHz

#Sweep 100 ms (601 pts)

Marker	Trace	Type	X Axis	Amplitude
1	(1)	Freq	2.483 50 GHz	56.64 dBµV/m
2	(1)	Freq	2.485 20 GHz	54.82 dBµV/m

Detector mode: Average

Polarity: Vertical

Agilent

R T

Mkr2 2.485 93 GHz

43.85 dBµV/m

Ref 123 dBµV/m

#Atten 20 dB

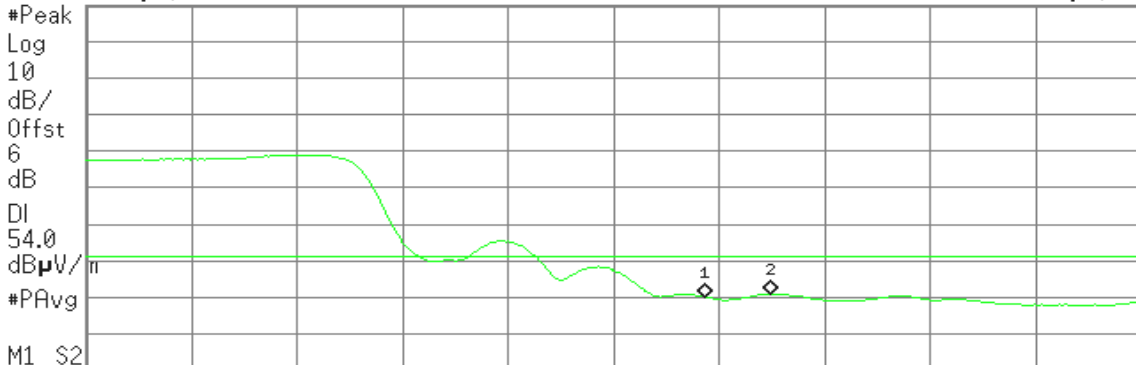

Start 2.460 00 GHz

Stop 2.500 00 GHz

#Res BW 1 MHz

#VBW 300 Hz

Sweep 104 ms (601 pts)

Marker	Trace	Type	X Axis	Amplitude
1	(1)	Freq	2.483 50 GHz	43.07 dBµV/m
2	(1)	Freq	2.485 93 GHz	43.85 dBµV/m



Detector mode: Peak

Polarity: Horizontal

Agilent

R T

Mkr2 2.485 20 GHz
66.81 dBµV/m

Ref 123 dBµV/m

#Atten 20 dB

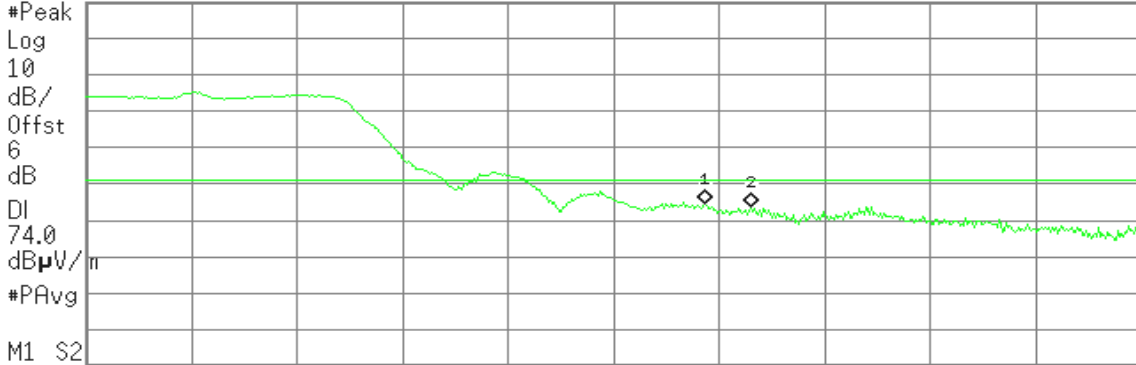

M1 S2
Start 2.460 00 GHz

Stop 2.500 00 GHz

#Res BW 1 MHz

#VBW 3 MHz

#Sweep 100 ms (601 pts)

Marker	Trace	Type	X Axis	Amplitude
1	(1)	Freq	2.483 50 GHz	67.64 dBµV/m
2	(1)	Freq	2.485 20 GHz	66.81 dBµV/m

Detector mode: Average

Polarity: Horizontal

Agilent

R T

Mkr2 2.486 00 GHz
52.77 dBµV/m

Ref 123 dBµV/m

#Atten 20 dB

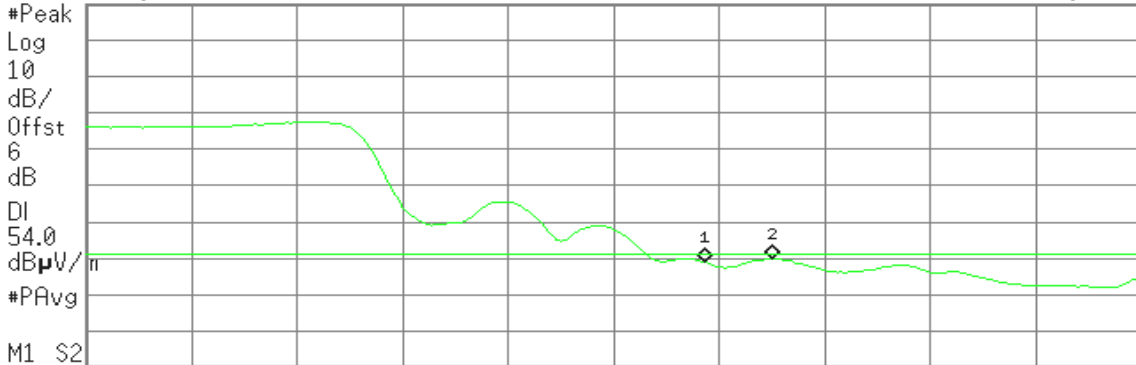

M1 S2
Start 2.460 00 GHz

Stop 2.500 00 GHz

#Res BW 1 MHz

#VBW 300 Hz

Sweep 104 ms (601 pts)

Marker	Trace	Type	X Axis	Amplitude
1	(1)	Freq	2.483 50 GHz	51.86 dBµV/m
2	(1)	Freq	2.486 00 GHz	52.77 dBµV/m



Test Plot

Conducted Band Edges (IEEE 802.11b mode / CH Low)

Agilent

R T

Mkr4 2.412 55 GHz
2.82 dBm

Ref 27.5 dBm

#Atten 30 dB

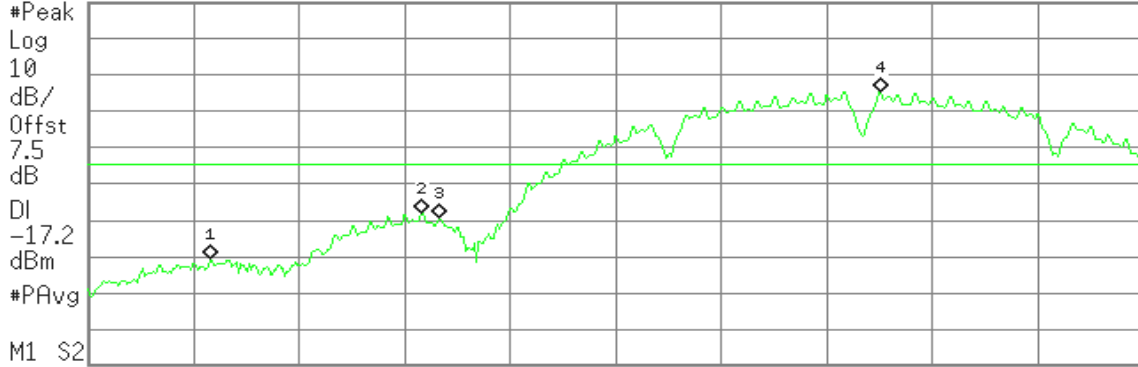

Start 2.390 00 GHz

Stop 2.420 00 GHz

#Res BW 100 kHz

#VBW 100 kHz

Sweep 3.64 ms (601 pts)

Marker	Trace	Type	X Axis	Amplitude
1	(1)	Freq	2.393 50 GHz	-43.19 dBm
2	(1)	Freq	2.399 50 GHz	-30.33 dBm
3	(1)	Freq	2.400 00 GHz	-31.80 dBm
4	(1)	Freq	2.412 55 GHz	2.82 dBm

Conducted Band Edges (IEEE 802.11b mode / CH High)

Agilent

R T

Mkr1 2.461 53 GHz
2.40 dBm

Ref 27.5 dBm

#Atten 30 dB

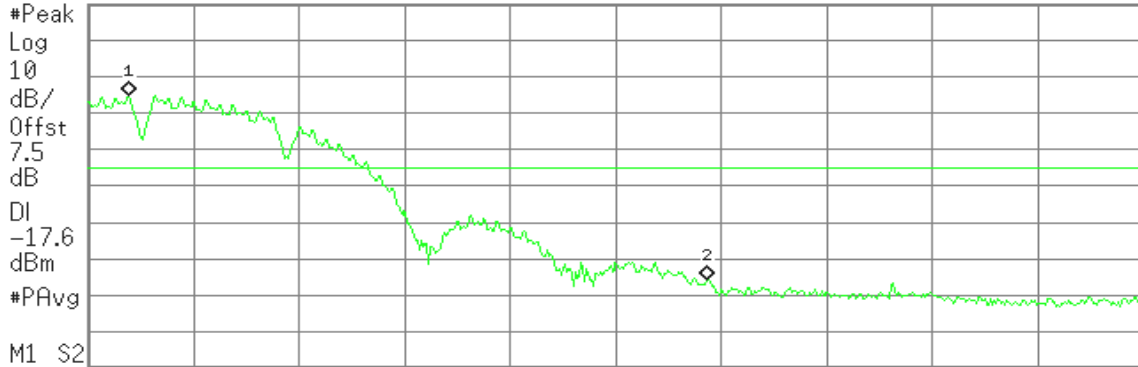

Start 2.460 00 GHz

Stop 2.500 00 GHz

#Res BW 100 kHz

#VBW 100 kHz

Sweep 4.84 ms (601 pts)

Marker	Trace	Type	X Axis	Amplitude
1	(1)	Freq	2.461 53 GHz	2.40 dBm
2	(1)	Freq	2.483 50 GHz	-48.24 dBm



Conducted Band Edges (IEEE 802.11g mode / CH Low)

Agilent

R T

Mkr2 2.413 30 GHz
2.56 dBm

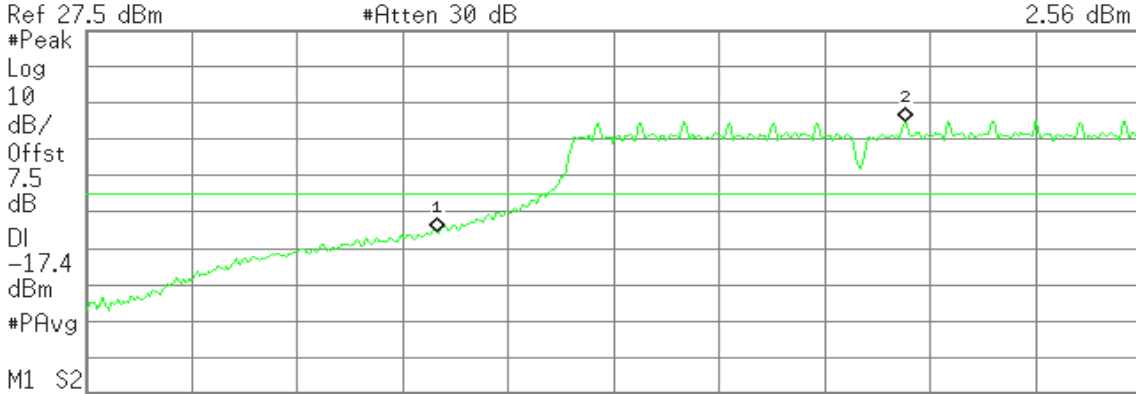

Start 2.390 00 GHz Stop 2.420 00 GHz
#Res BW 100 kHz #VBW 100 kHz Sweep 3.64 ms (601 pts)

Marker	Trace	Type	X Axis	Amplitude
1	(1)	Freq	2.400 00 GHz	-27.97 dBm
2	(1)	Freq	2.413 30 GHz	2.56 dBm

Conducted Band Edges (IEEE 802.11g mode / CH High)

Agilent

R T

Mkr1 2.469 53 GHz
0.94 dBm

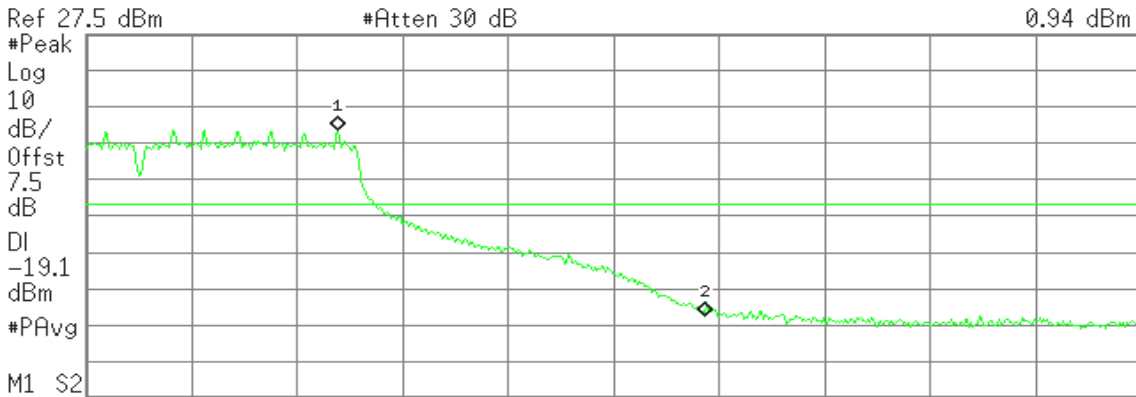

Start 2.460 00 GHz Stop 2.500 00 GHz
#Res BW 100 kHz #VBW 100 kHz Sweep 4.84 ms (601 pts)

Marker	Trace	Type	X Axis	Amplitude
1	(1)	Freq	2.469 53 GHz	0.94 dBm
2	(1)	Freq	2.483 50 GHz	-49.91 dBm



Conducted Band Edges (IEEE 802.11n HT20 mode / CH Low)

Agilent

R T

Mkr2 2.415 75 GHz
2.39 dBm

Ref 27.5 dBm

#Atten 30 dB

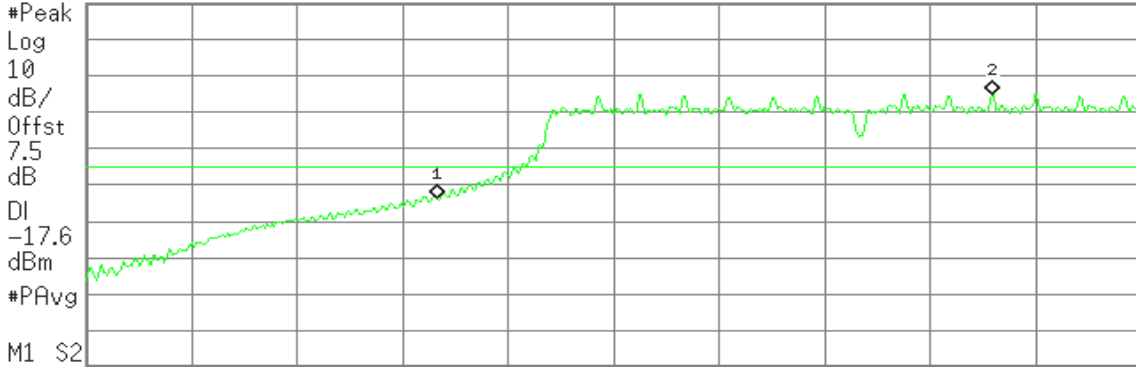

Start 2.390 00 GHz

Stop 2.420 00 GHz

#Res BW 100 kHz

#VBW 100 kHz

Sweep 3.64 ms (601 pts)

Marker	Trace	Type	X Axis	Amplitude
1	(1)	Freq	2.400 00 GHz	-26.23 dBm
2	(1)	Freq	2.415 75 GHz	2.39 dBm

Conducted Band Edges (IEEE 802.11n HT20 mode / CH High)

Agilent

R T

Mkr1 2.469 53 GHz
1.18 dBm

Ref 27.5 dBm

#Atten 30 dB

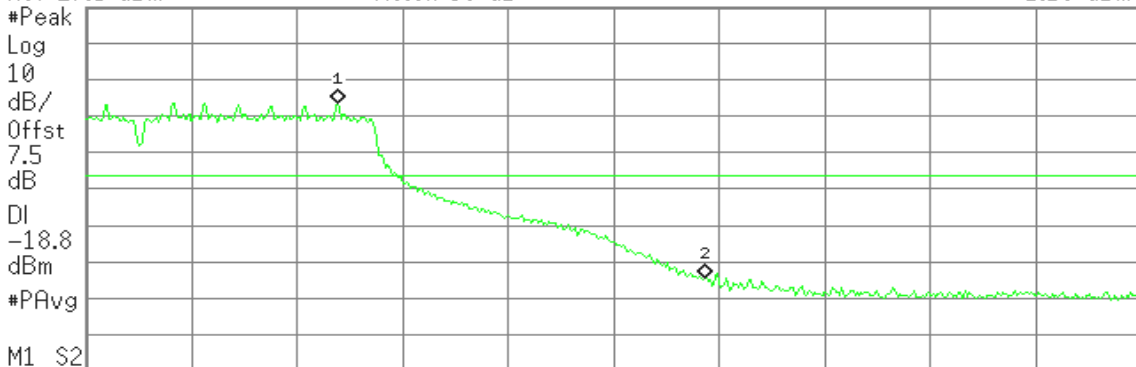

Start 2.460 00 GHz

Stop 2.500 00 GHz

#Res BW 100 kHz

#VBW 100 kHz

Sweep 4.84 ms (601 pts)

Marker	Trace	Type	X Axis	Amplitude
1	(1)	Freq	2.469 53 GHz	1.18 dBm
2	(1)	Freq	2.483 50 GHz	-46.86 dBm



Conducted Band Edges (IEEE 802.11n HT40 mode / CH Low)

Agilent

R T

Mkr3 2.417 00 GHz
0.34 dBm

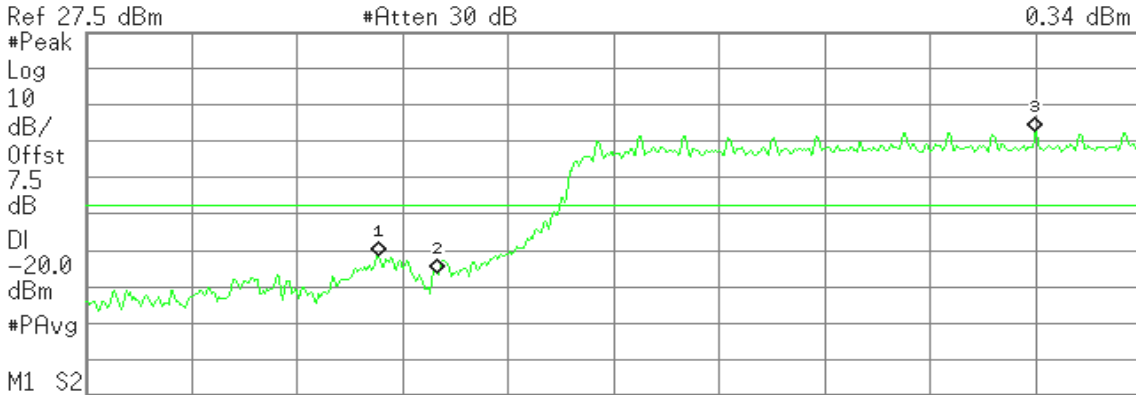

Ref 27.5 dBm #Atten 30 dB
Start 2.390 00 GHz Stop 2.420 00 GHz
#Res BW 100 kHz #VBW 100 kHz Sweep 3.64 ms (601 pts)

Marker	Trace	Type	X Axis	Amplitude
1	(1)	Freq	2.398 30 GHz	-34.06 dBm
2	(1)	Freq	2.400 00 GHz	-38.87 dBm
3	(1)	Freq	2.417 00 GHz	0.34 dBm

Conducted Band Edges (IEEE 802.11n HT40 mode / CH High)

Agilent

R T

Mkr1 2.467 00 GHz
-3.23 dBm

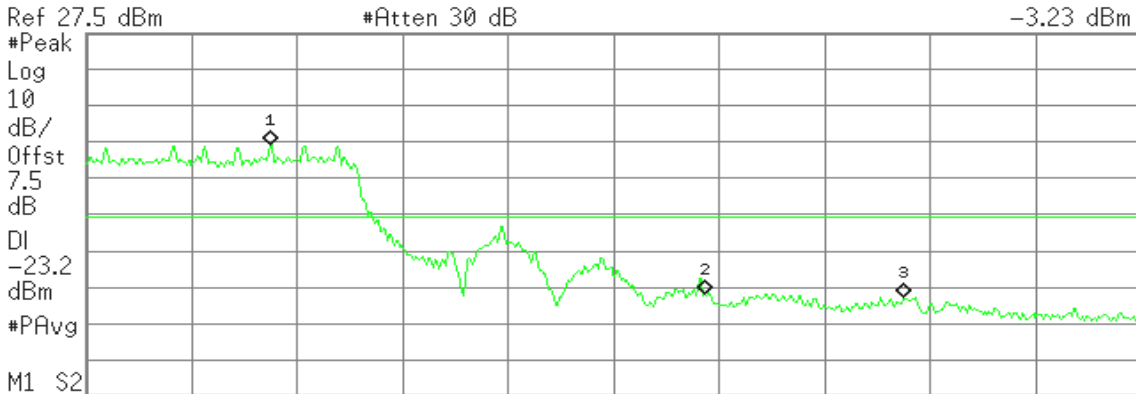

Ref 27.5 dBm #Atten 30 dB
Start 2.460 00 GHz Stop 2.500 00 GHz
#Res BW 100 kHz #VBW 100 kHz Sweep 4.84 ms (601 pts)

Marker	Trace	Type	X Axis	Amplitude
1	(1)	Freq	2.467 00 GHz	-3.23 dBm
2	(1)	Freq	2.483 50 GHz	-44.45 dBm
3	(1)	Freq	2.491 00 GHz	-45.13 dBm



7.5 PEAK POWER SPECTRAL DENSITY

LIMIT

1. According to §15.247(e), for digitally modulated systems, the power spectral density conducted from the intentional radiator to the antenna shall not be greater than 8 dBm in any 3 kHz band during any time interval of continuous transmission.
2. According to §15.247(f), the digital modulation operation of the hybrid system, with the frequency hopping turned off, shall comply with the power density requirements of paragraph (d) of this section.

Test Configuration

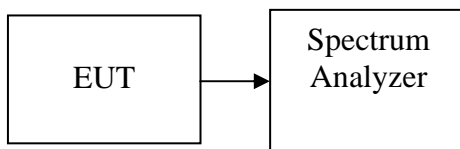

TEST PROCEDURE

Per KDB 558074 v03r01

This procedure must be used if maximum peak conducted output power was used to demonstrate compliance to the fundamental output power limit, and is optional if the maximum (average) conducted output power was used to demonstrate compliance.

1. Set analyzer center frequency to DTS channel center frequency.
2. Set the span to 1.5 times the DTS channel bandwidth.
3. Set the RBW \geq 3 kHz.
4. Set the VBW \geq 3 x RBW.
5. Detector = peak.
6. Sweep time = auto couple.
7. Trace mode = max hold.
8. Allow trace to fully stabilize.

Use the peak marker function to determine the maximum amplitude level.

If measured value exceeds limit, reduce RBW (no less than 3 kHz) and repeat

TEST RESULTS

No non-compliance noted

**Test Data****Test mode: IEEE 802.11b mode**

Channel	Frequency (MHz)	PPSD (dBm)	Limit (dBm)	Result
Low	2412	-4.84	8.00	PASS
Mid	2437	-3.40		PASS
High	2462	-4.98		PASS

Test mode: IEEE 802.11g mode

Channel	Frequency (MHz)	PPSD (dBm)	Limit (dBm)	Result
Low	2412	-13.17	8.00	PASS
Mid	2437	-11.87		PASS
High	2462	-14.12		PASS

Test mode: IEEE 802.11n HT20 mode

Channel	Frequency (MHz)	PPSD (dBm)	Limit (dBm)	Result
Low	2412	-9.98	8.00	PASS
Mid	2437	-12.15		PASS
High	2462	-13.05		PASS

Test mode: IEEE 802.11n HT40 mode

Channel	Frequency (MHz)	PPSD (dBm)	Limit (dBm)	Result
Low	2422	-13.43	8.00	PASS
Mid	2437	-10.75		PASS
High	2452	-17.67		PASS



Test Plot

**IEEE 802.11b mode
PPSD (CH Low)**

Agilent

R T

Mkr1 2.409 20 GHz
-4.84 dBm

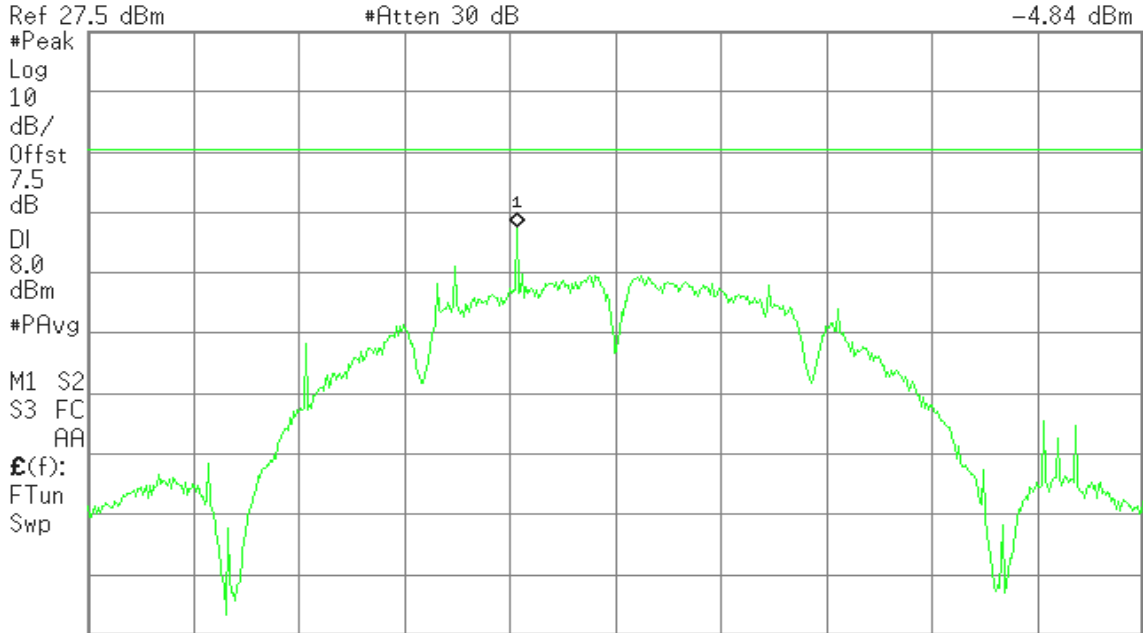

Center 2.412 00 GHz Span 30 MHz
#Res BW 3 kHz #VBW 10 kHz Sweep 3.163 s (601 pts)

PPSD (CH Mid)

Agilent

R T

Mkr1 2.438 85 GHz
-3.40 dBm

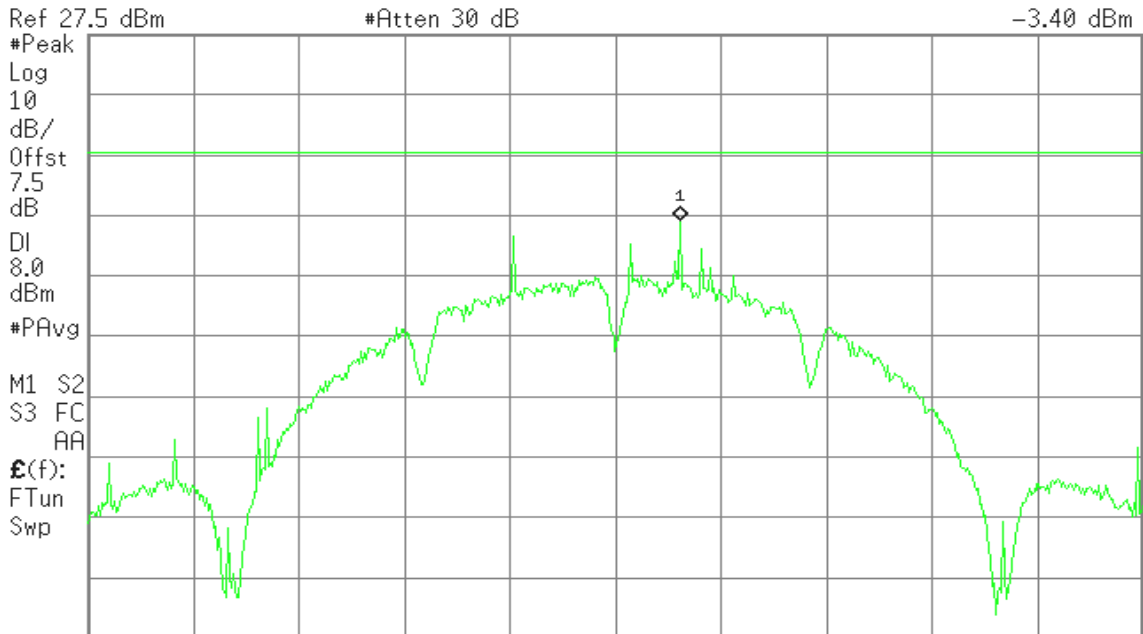

Center 2.437 00 GHz Span 30 MHz
#Res BW 3 kHz #VBW 10 kHz Sweep 3.163 s (601 pts)



PPSD (CH High)

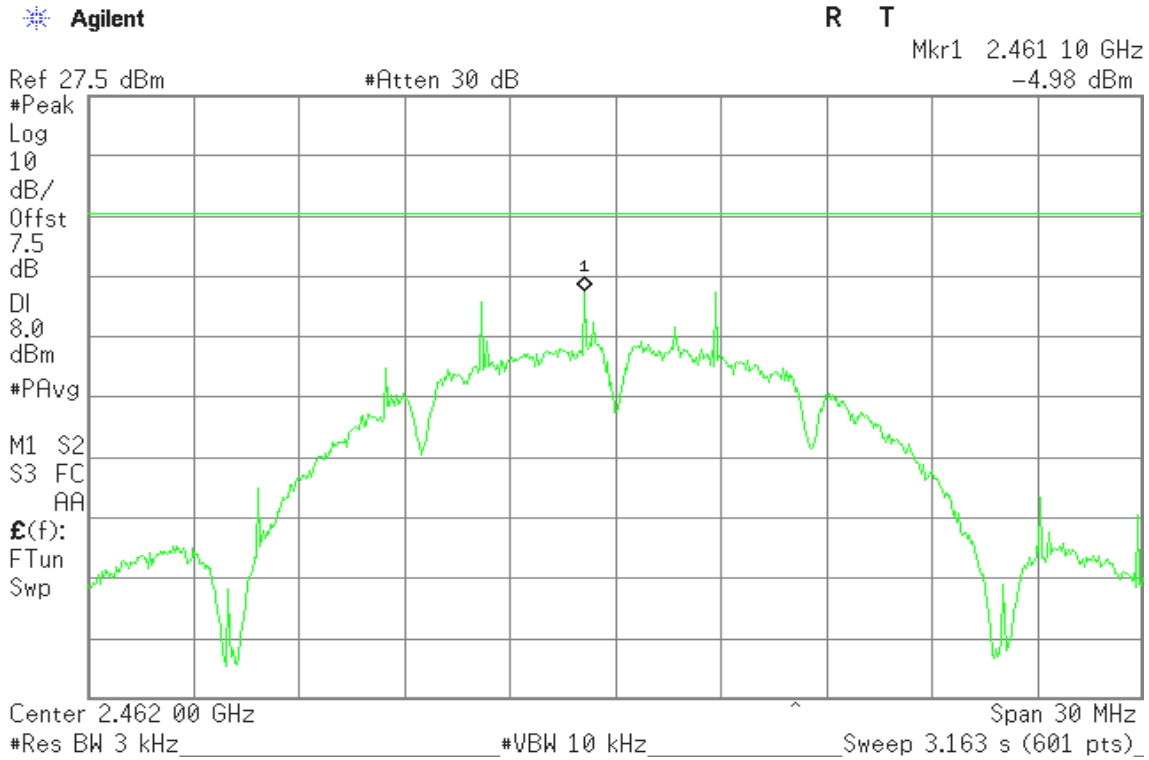

IEEE 802.11g mode

PPSD (CH Low)

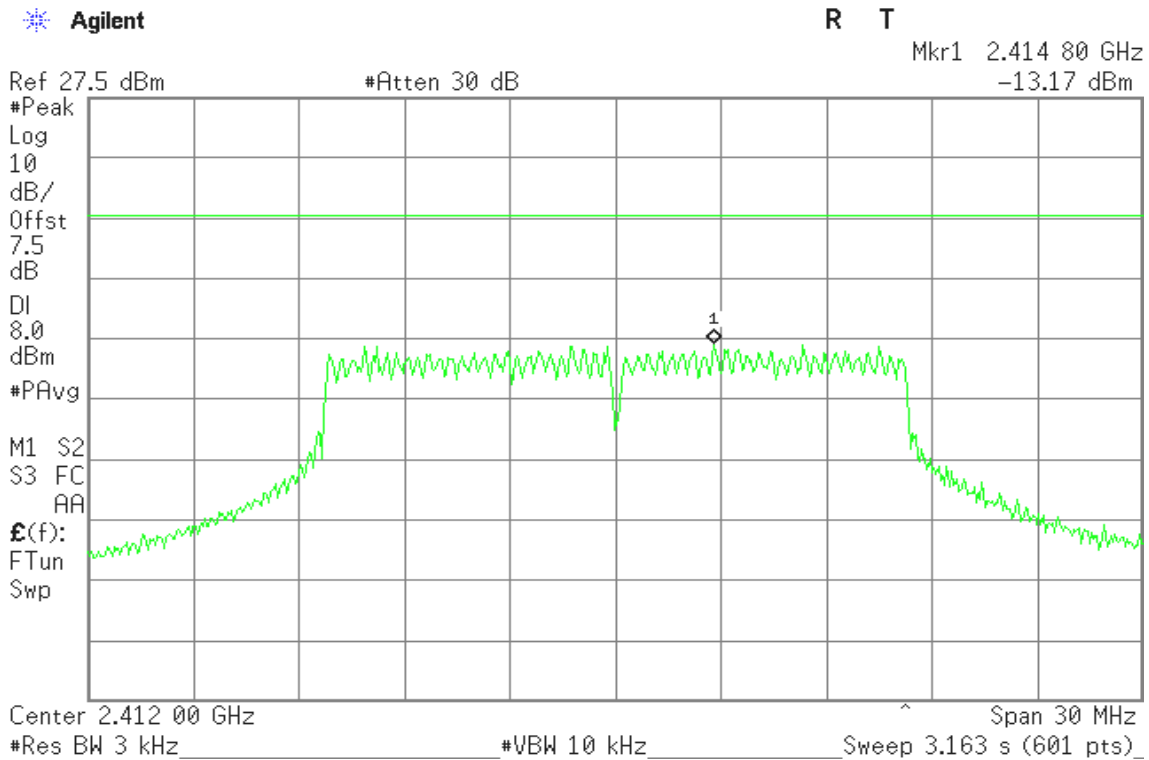



PPSD (CH Mid)

Agilent

R T

Mkr1 2.444 50 GHz
-11.87 dBm

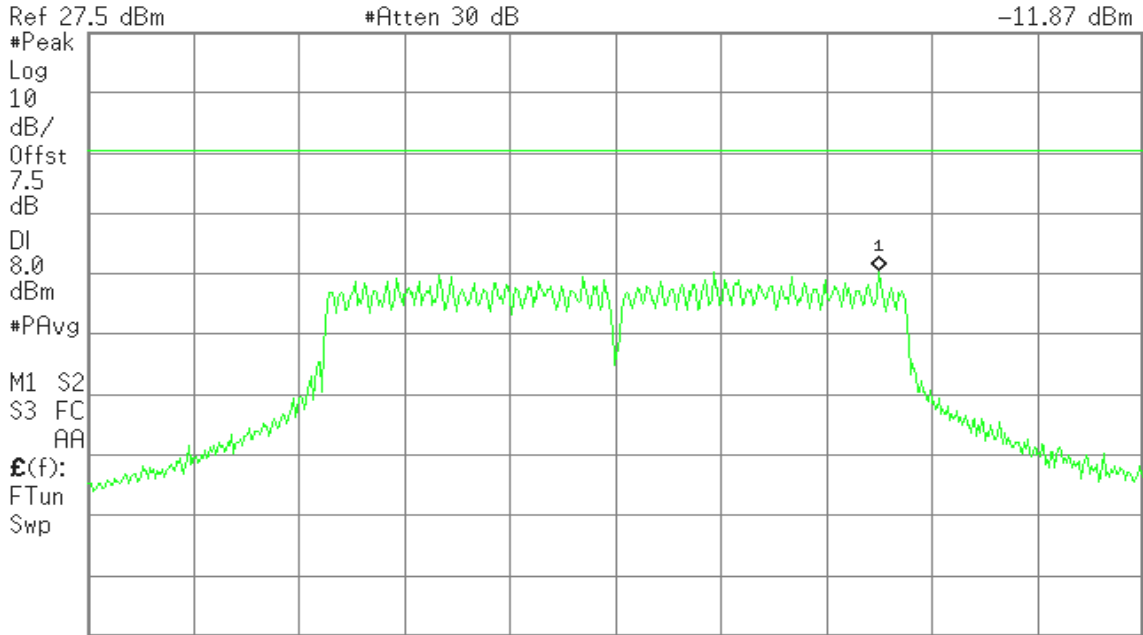

Center 2.437 00 GHz Span 30 MHz
#Res BW 3 kHz #VBW 10 kHz Sweep 3.163 s (601 pts)

PPSD (CH High)

Agilent

R T

Mkr1 2.457 00 GHz
-14.12 dBm

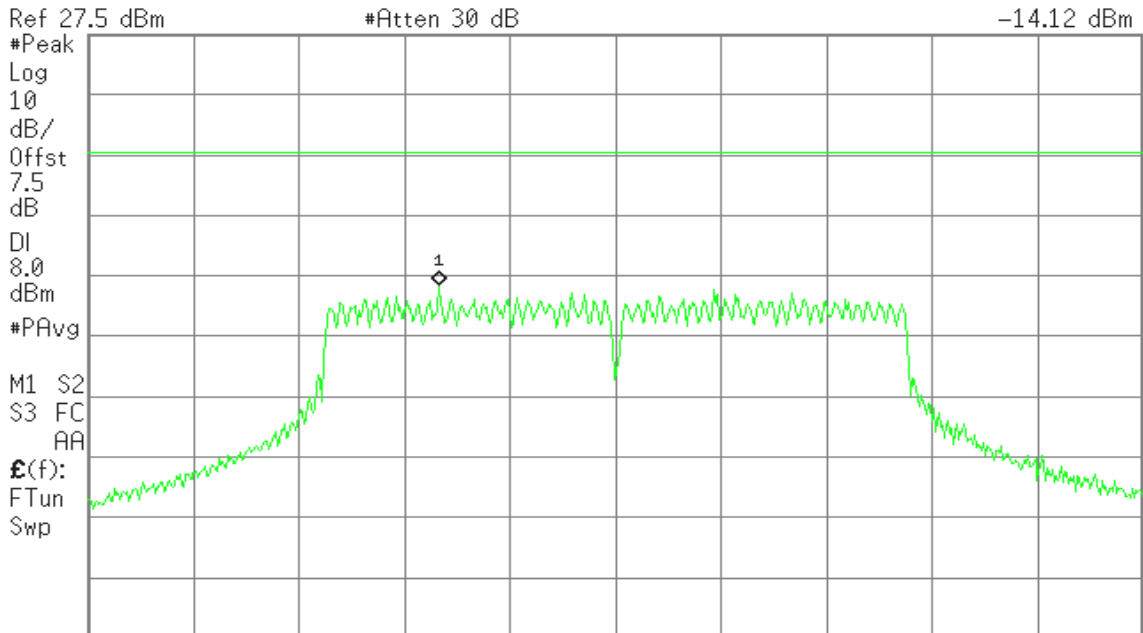

Center 2.462 00 GHz Span 30 MHz
#Res BW 3 kHz #VBW 10 kHz Sweep 3.163 s (601 pts)



IEEE 802.11n HT20 mode

PPSD (CH Low)

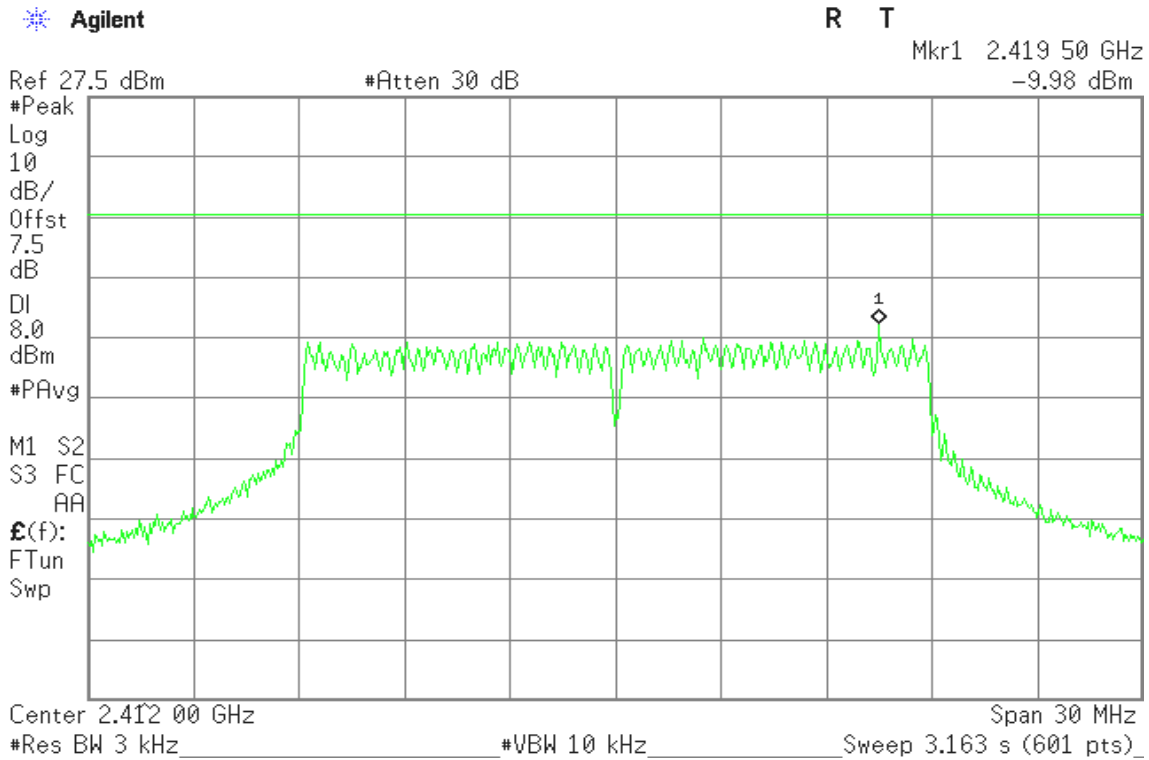

PPSD (CH Mid)

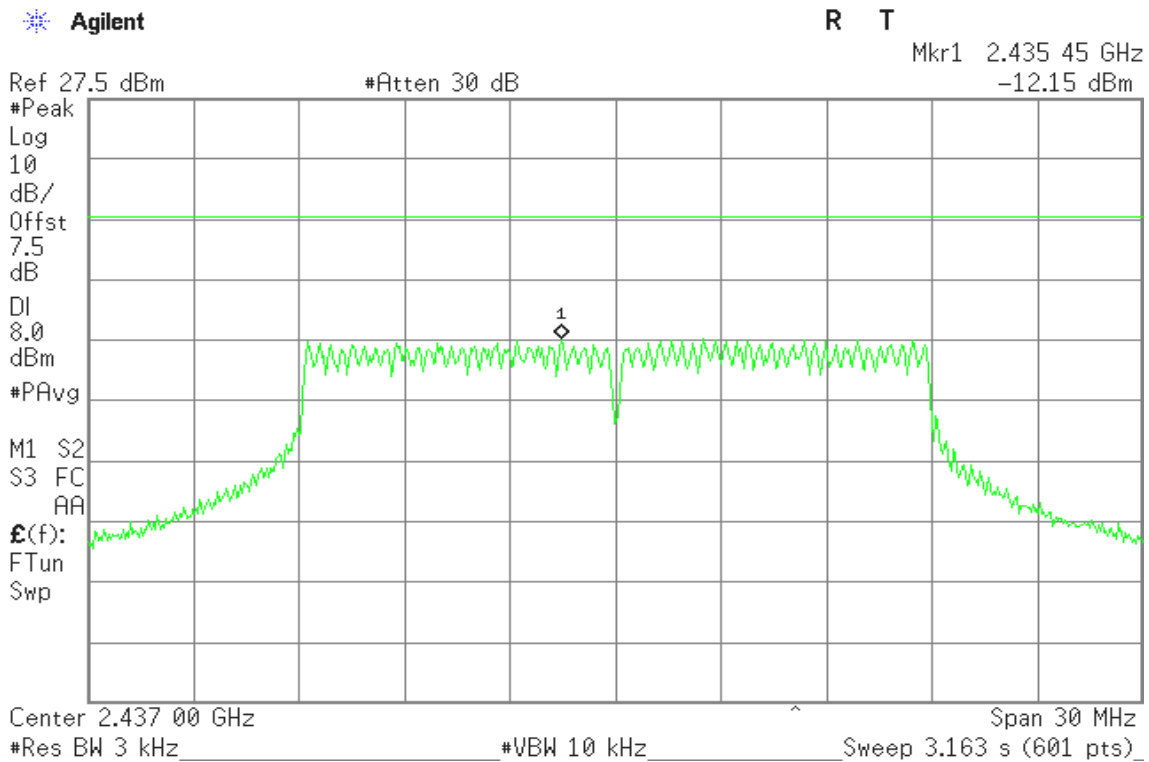



PPSD (CH High)

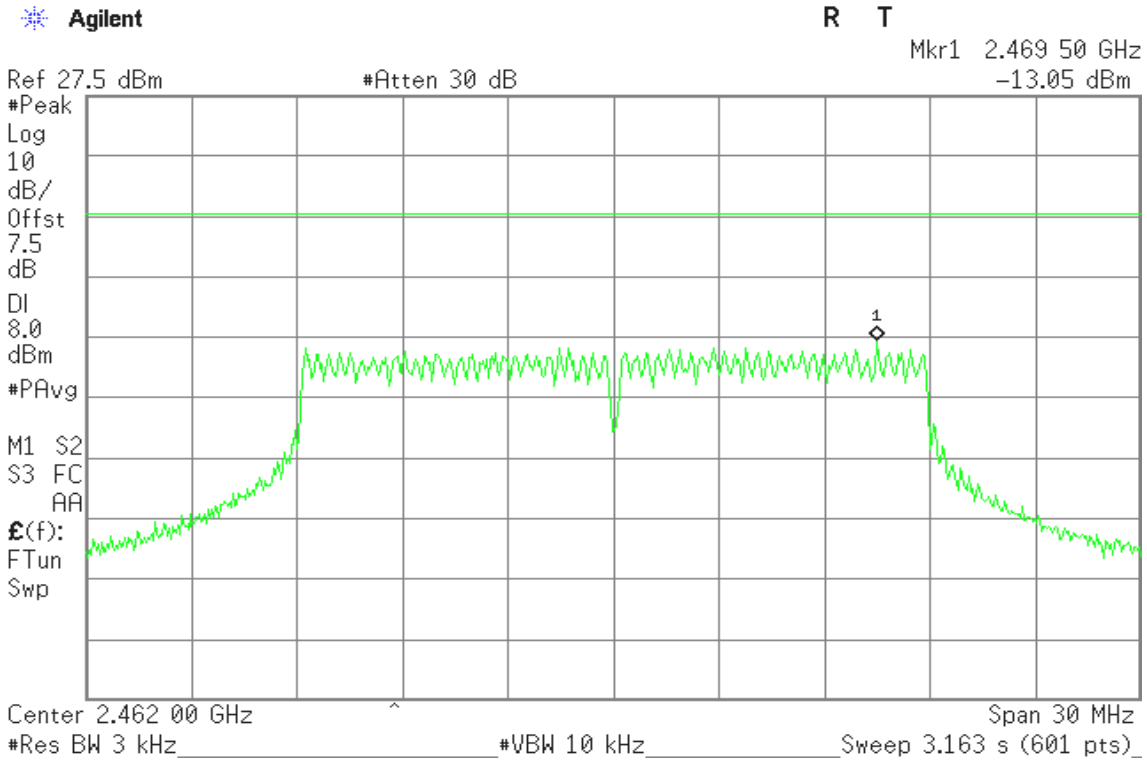

IEEE 802.11n HT40 mode

PPSD (CH Low)

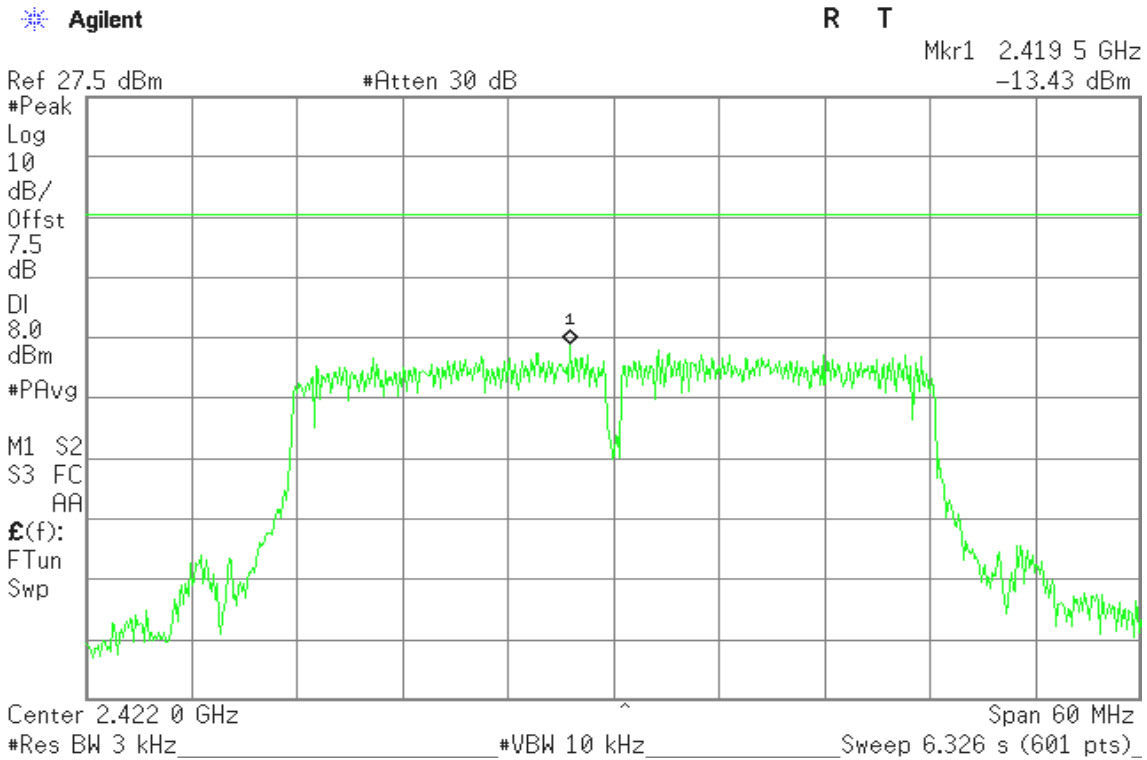



PPSD (CH Mid)

Agilent

R T

Mkr1 2.454 5 GHz
-10.75 dBm

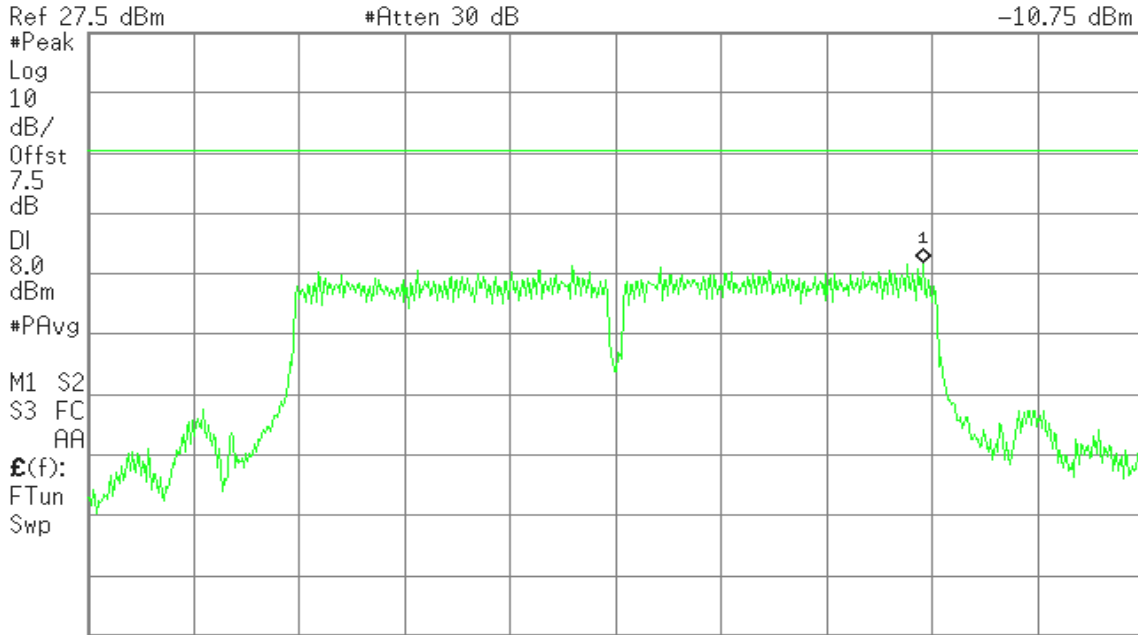

Center 2.437 0 GHz Span 60 MHz
#Res BW 3 kHz #VBW 10 kHz Sweep 6.326 s (601 pts)

PPSD (CH High)

Agilent

R T

Mkr1 2.449 5 GHz
-17.67 dBm

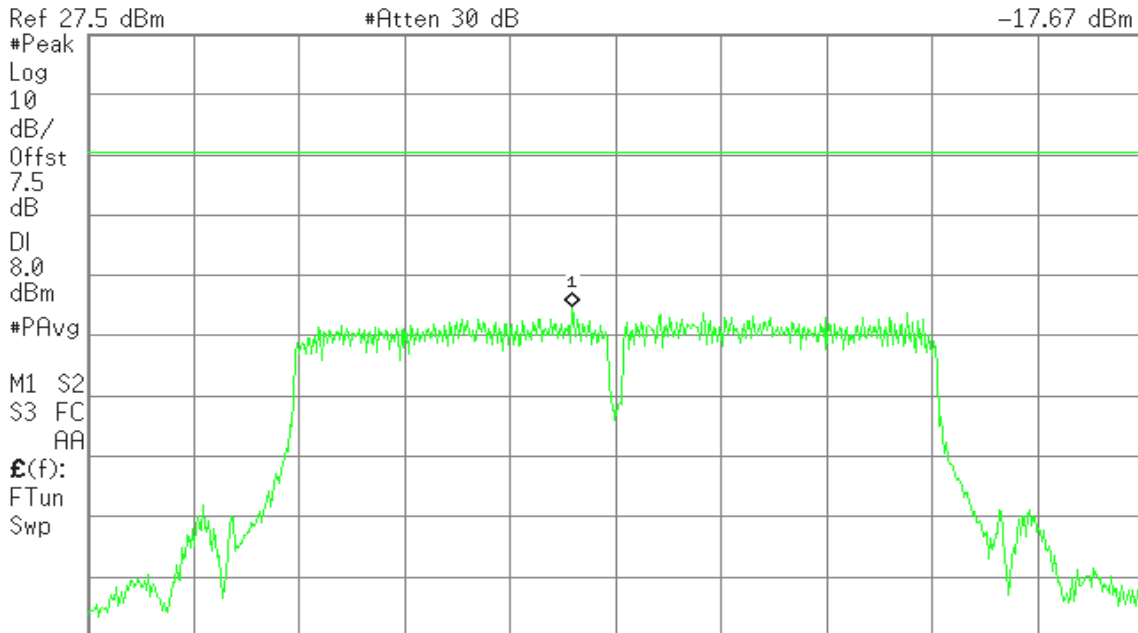

Center 2.452 0 GHz Span 60 MHz
#Res BW 3 kHz #VBW 10 kHz Sweep 6.326 s (601 pts)



7.6 SPURIOUS EMISSIONS

7.6.1 Conducted Measurement

LIMIT

According to §15.247(d), in any 100 kHz bandwidth outside the frequency bands in which the spread spectrum intentional radiator is operating, the radio frequency power that is produced by the intentional radiator shall be at least 20 dB below that in the 100 kHz bandwidth within the band that contains the highest level of the desired power, based on either an RF conducted or a radiated measurement, provided the transmitter demonstrates compliance with the peak conducted power limits. In addition, radiated emissions which fall in the restricted bands, as defined in §15.205(a), must also comply with the radiated emission limits specified in 15.209(a) (see Section 15.205(c)).

Test Configuration

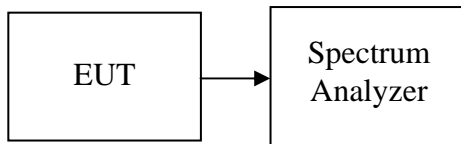

TEST PROCEDURE

Conducted RF measurements of the transmitter output were made to confirm that the EUT antenna port conducted emissions meet the specified limit and to identify any spurious signals that require further investigation or measurements on the radiated emissions site.

The transmitter output is connected to the spectrum analyzer. The resolution bandwidth is set to 100 kHz. The video bandwidth is set to 100 kHz.

Measurements are made over the 30MHz to 26GHz range for IEEE 802.11b/g, 30MHz to 40GHz range for IEEE 802.11a with the transmitter set to the lowest, middle, and highest channels.

TEST RESULTS

No non-compliance noted



Test Plot

IEEE 802.11b mode

CH Low

Agilent

R T

Mkr1 2.41 GHz
1.60 dBm

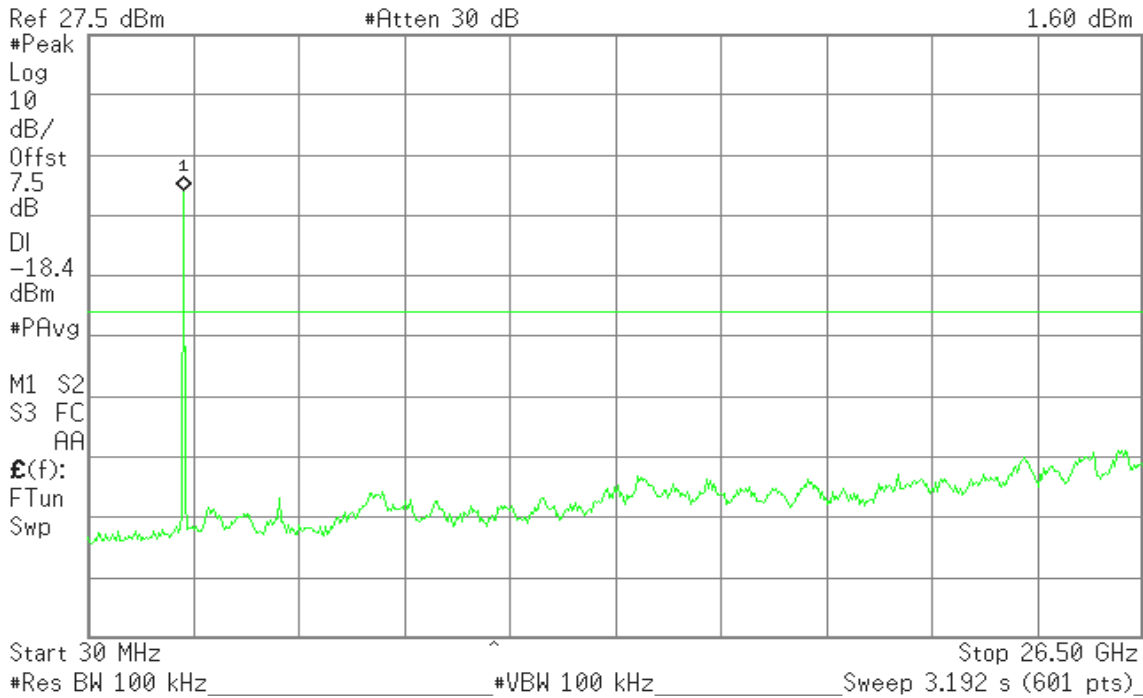

CH Mid

Agilent

R T

Mkr1 2.46 GHz
2.89 dBm

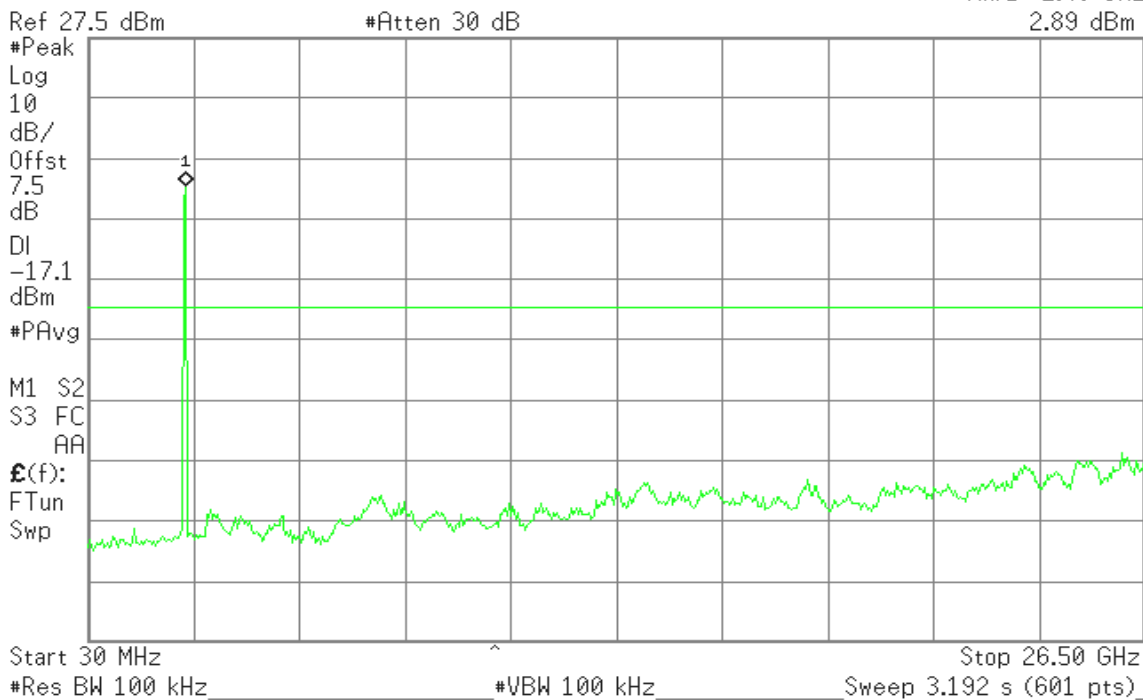



CH High

Agilent

R T

Mkr1 2.46 GHz
2.66 dBm

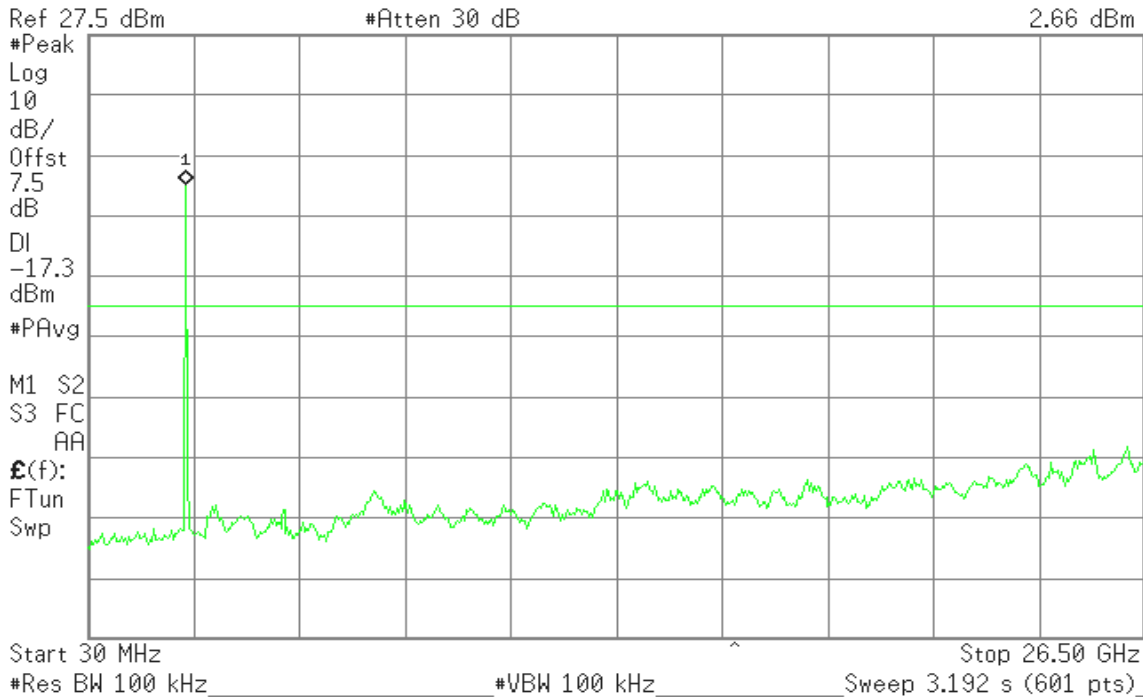

IEEE 802.11g mode

CH Low

Agilent

R T

Mkr1 2.41 GHz
2.42 dBm

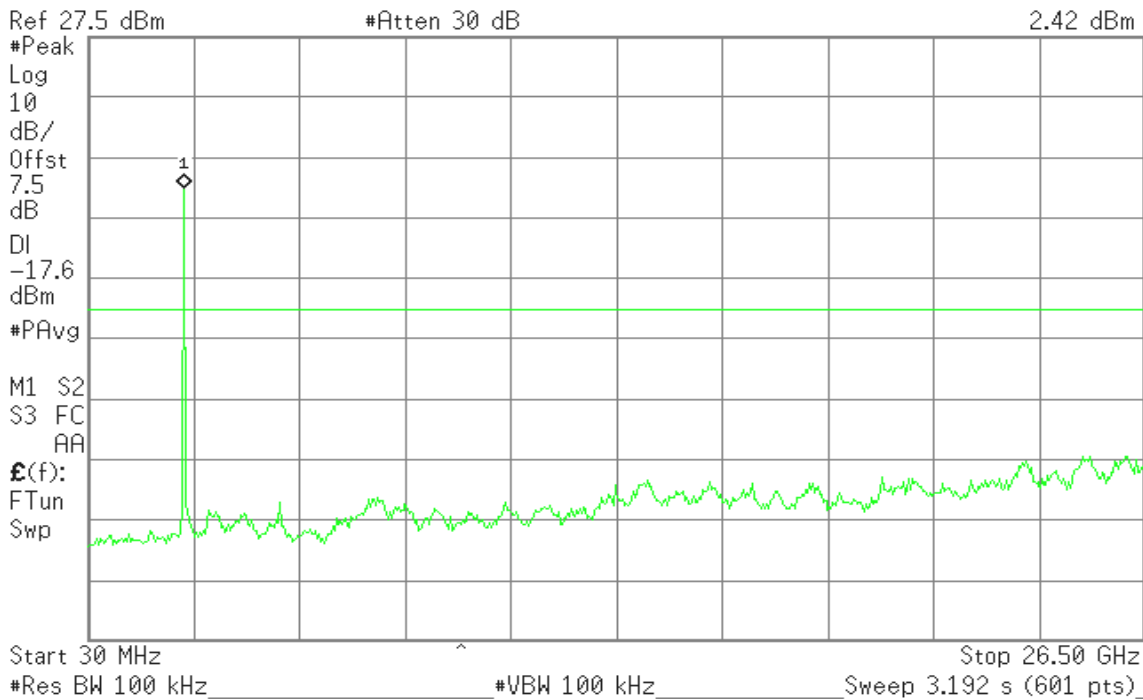



CH Mid

Agilent

R T

Mkr1 2.41 GHz
2.29 dBm

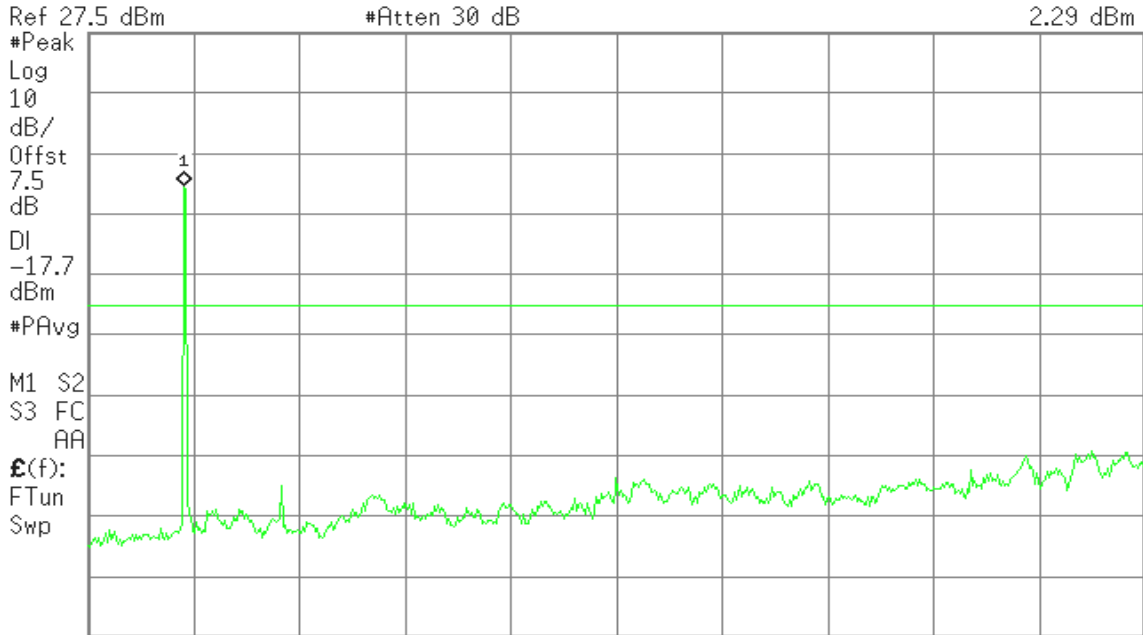

Start 30 MHz Stop 26.50 GHz
#Res BW 100 kHz #VBW 100 kHz Sweep 3.192 s (601 pts)

CH High

Agilent

R T

Mkr1 2.46 GHz
0.21 dBm

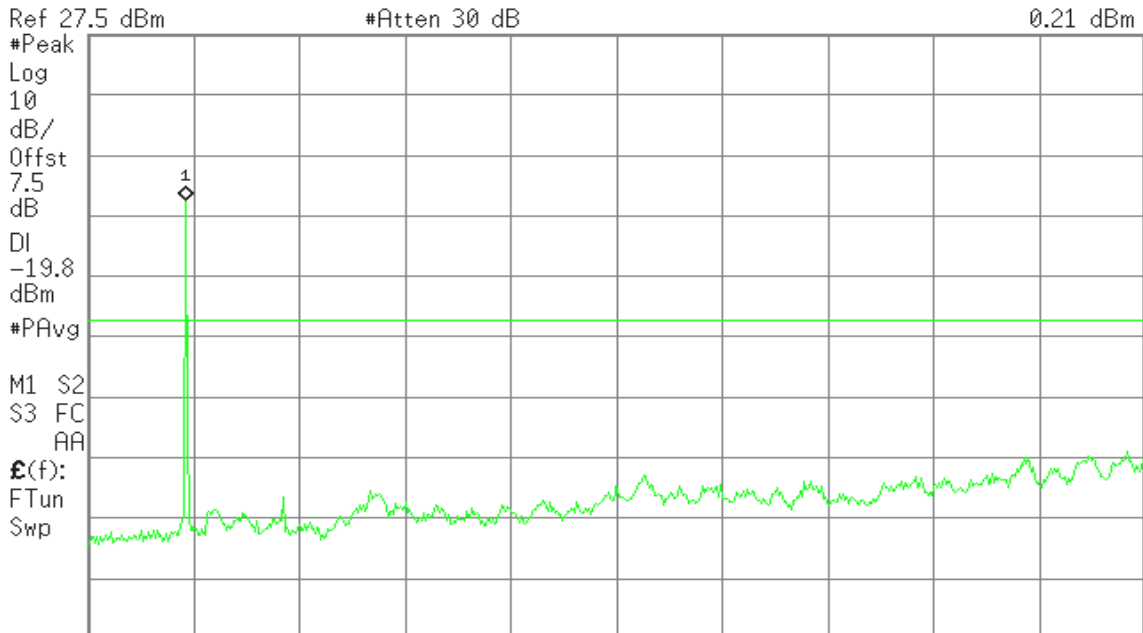

Start 30 MHz Stop 26.50 GHz
#Res BW 100 kHz #VBW 100 kHz Sweep 3.192 s (601 pts)



IEEE 802.11n HT20 mode

CH Low

Agilent

R T

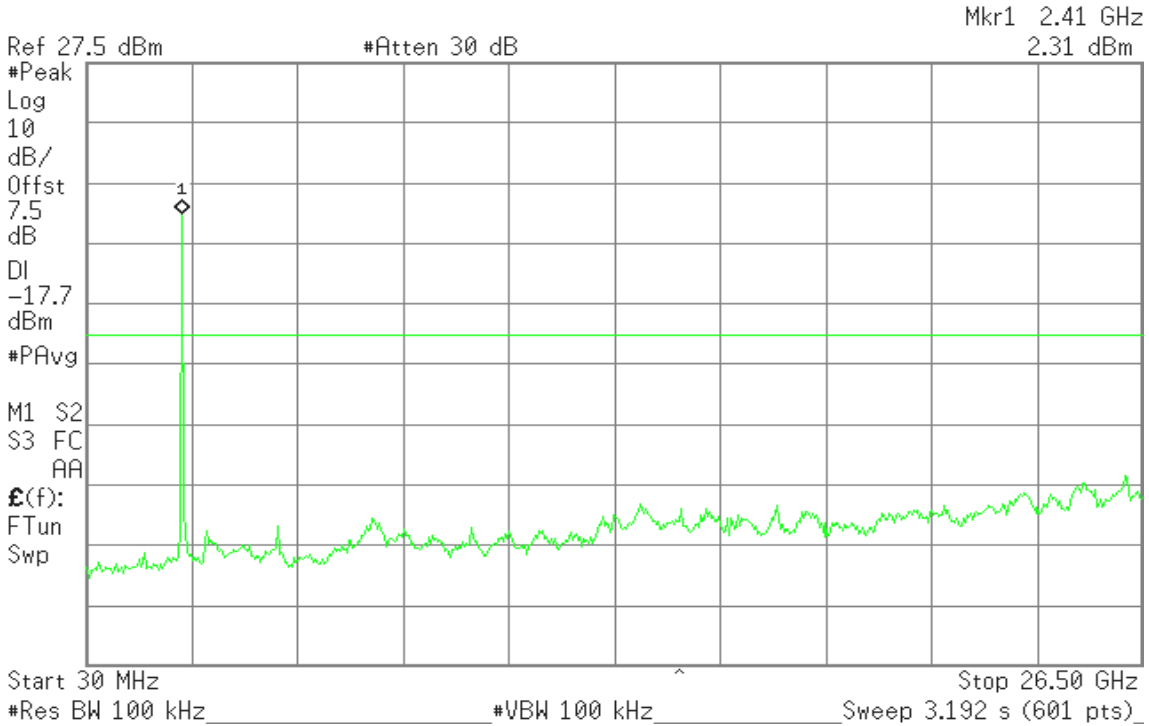

CH Mid

Agilent

R T

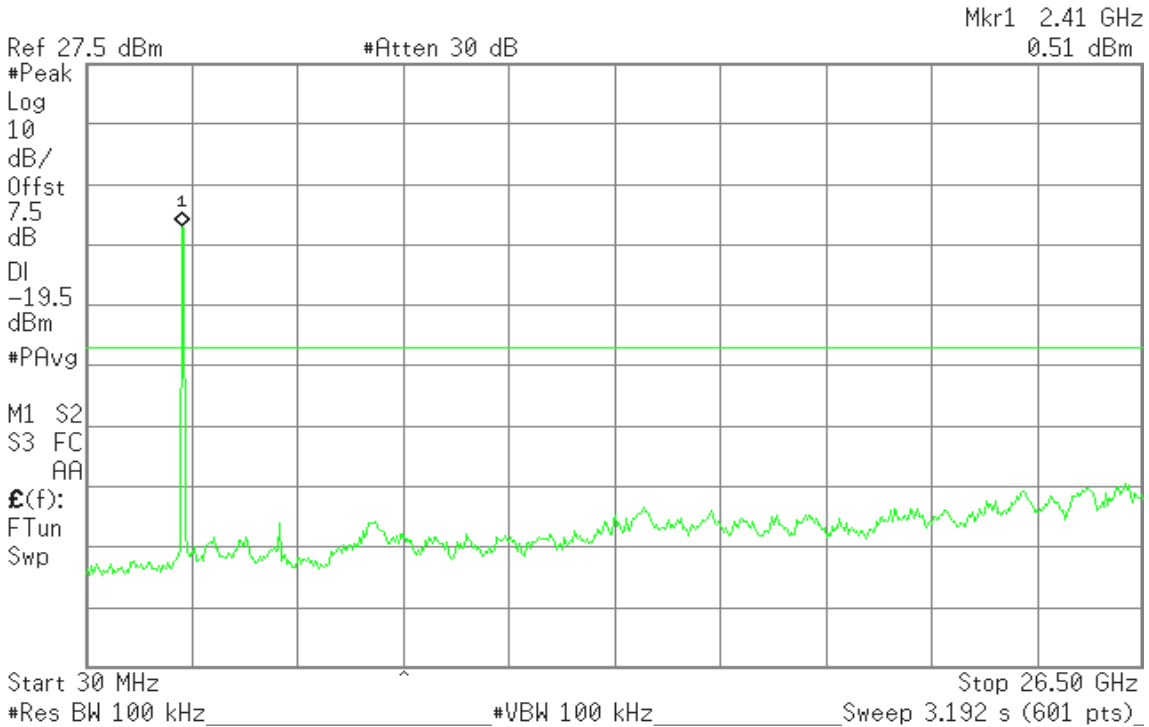



CH High

Agilent

R T

Mkr1 2.46 GHz
-0.14 dBm

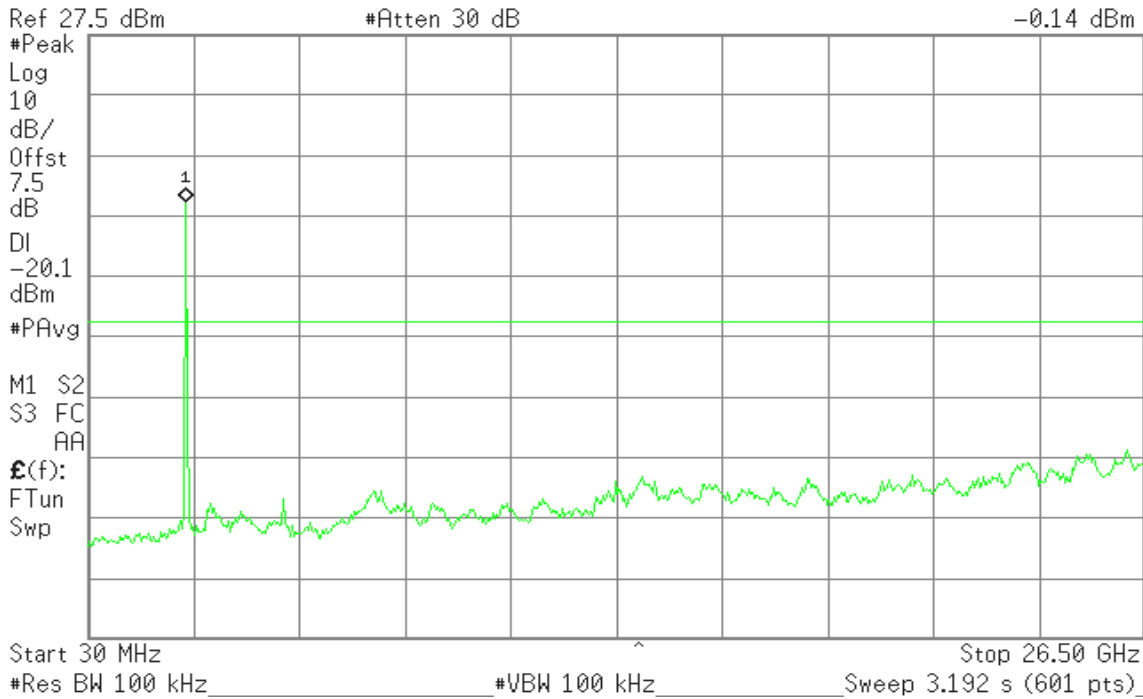

IEEE 802.11n HT40 mode

CH Low

Agilent

R T

Mkr1 2.41 GHz
-0.76 dBm

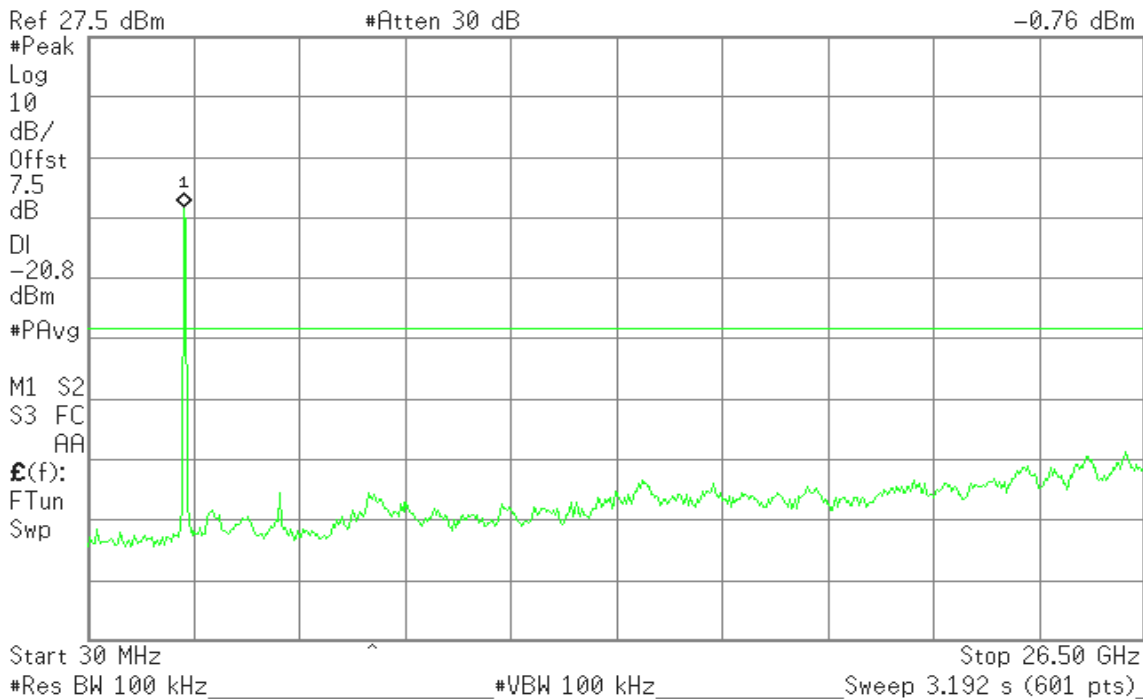



CH Mid

Agilent

R T

Mkr1 2.46 GHz
1.78 dBm

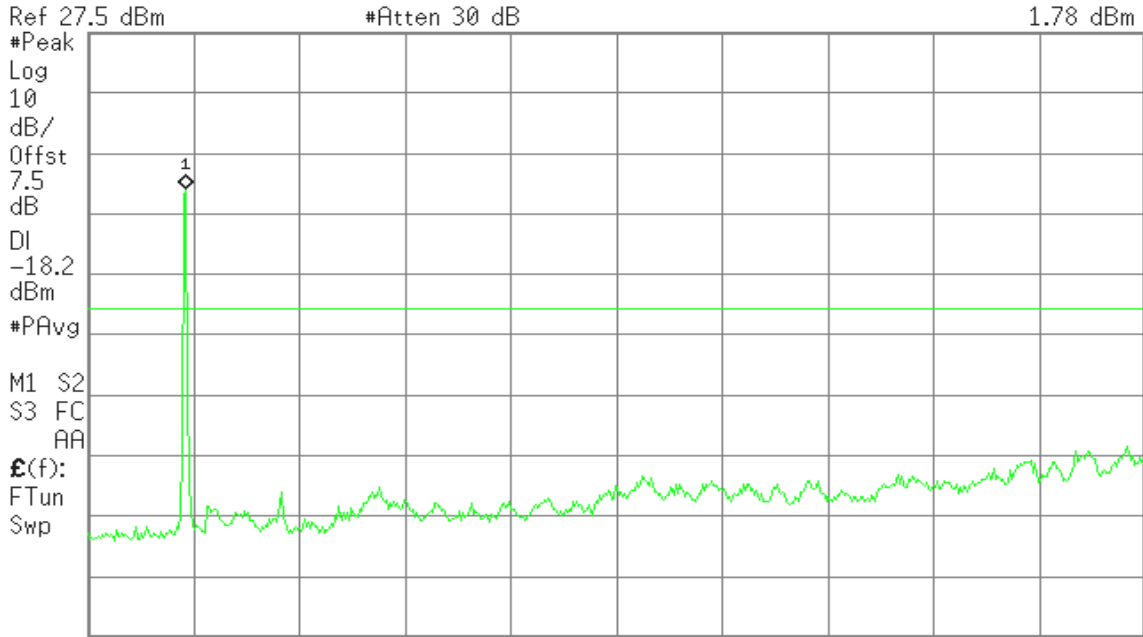

Start 30 MHz ^ Stop 26.50 GHz
#Res BW 100 kHz #VBW 100 kHz Sweep 3.192 s (601 pts)

CH High

Agilent

R T

Mkr1 2.46 GHz
-4.34 dBm

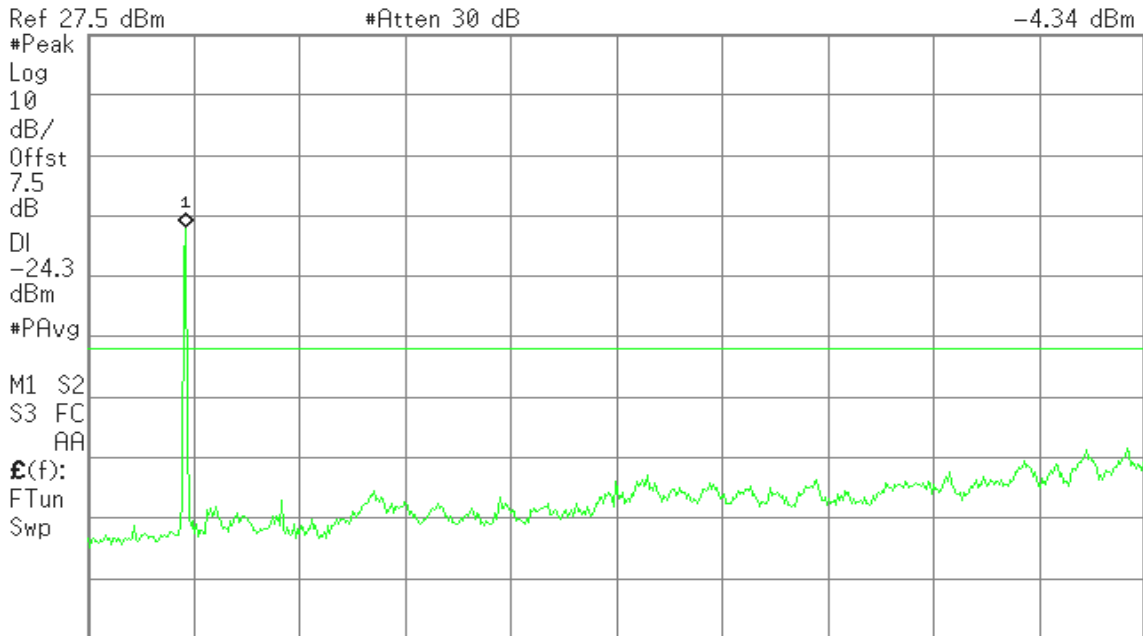

Start 30 MHz ^ Stop 26.50 GHz
#Res BW 100 kHz #VBW 100 kHz Sweep 3.192 s (601 pts)



7.6.2 Radiated Emissions

LIMIT

1. According to §15.209(a), except as provided elsewhere in this Subpart, the emissions from an intentional radiator shall not exceed the field strength levels specified in the following table:

Frequency (MHz)	Field Strength (µV/m)	Measurement Distance (m)
0.009 - 0.490	2400/F(kHz)	300
0.490 - 1.705	24000/F(kHz)	30
1.705 – 30.0	30	30
30-88	100	3
88-216	150	3
216-960	200	3
Above 960	500	3

Remark: Except as provided in paragraph (g), fundamental emissions from intentional radiators operating under this Section shall not be located in the frequency bands 54-72 MHz, 76-88 MHz, 174-216 MHz or 470-806 MHz. However, operation within these frequency bands is permitted under other sections of this Part, e.g., Sections 15.231 and 15.241.

2. In the above emission table, the tighter limit applies at the band edges.

Frequency (MHz)	Field Strength (µV/m at 3-meter)	Field Strength (dBµV/m at 3-meter)
0.009 - 0.490	2400/F(kHz) +80	20LOG((2400/F(kHz))+80)
0.490 - 1.705	24000/F(kHz) +40	20LOG((24000/F(kHz))+40)
1.705 – 30.0	30	69.54
30-88	100	40
88-216	150	43.5
216-960	200	46
Above 960	500	54



Test Configuration

9kHz ~ 30MHz

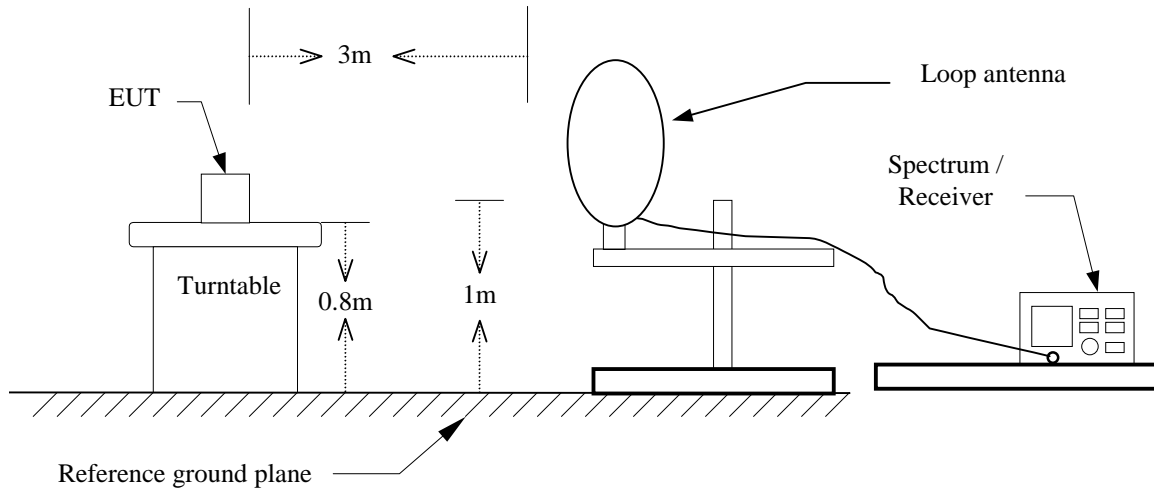

30MHz ~ 1GHz

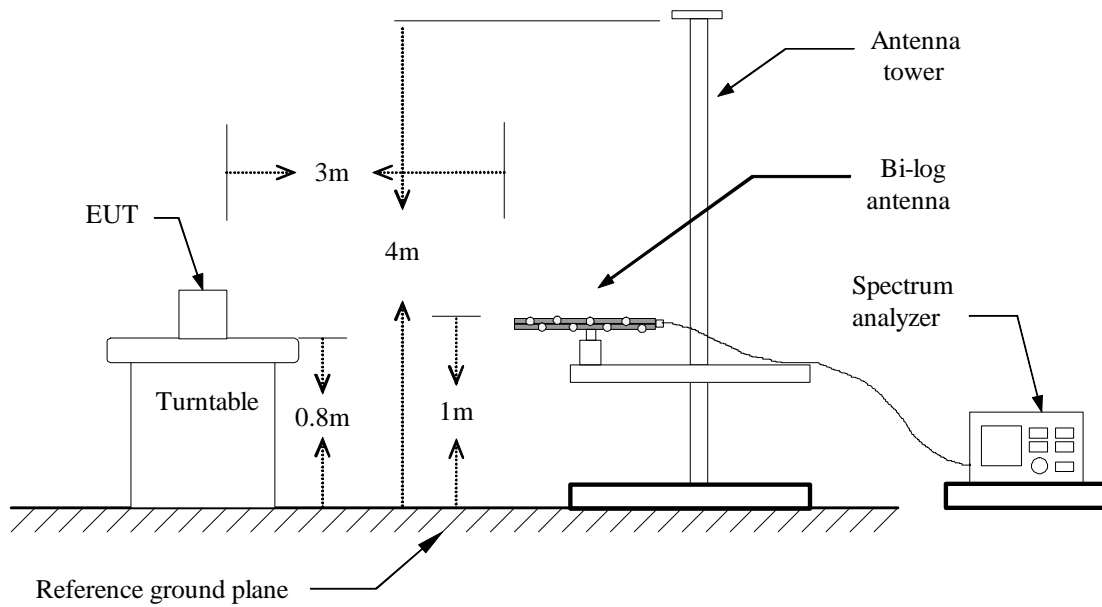



Above 1 GHz

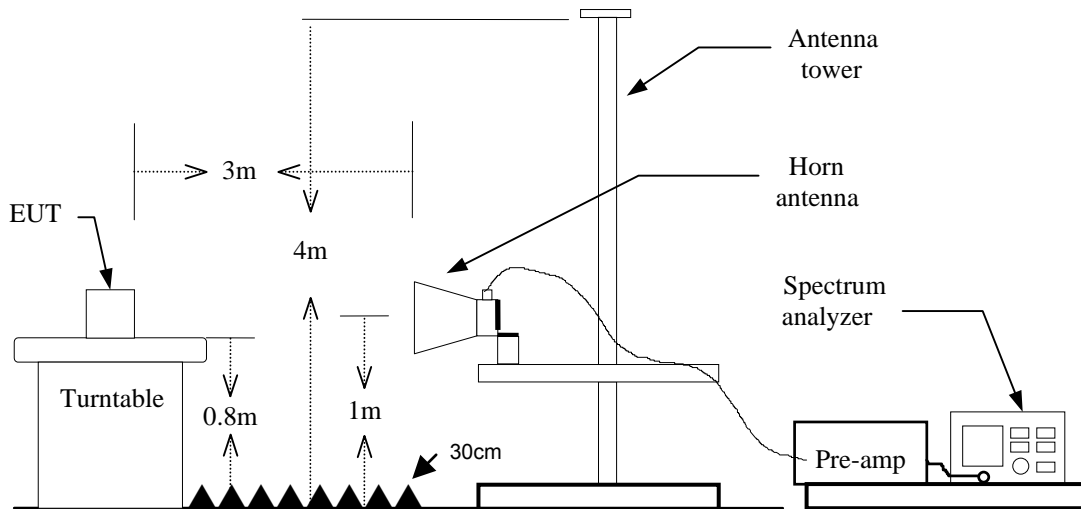

TEST PROCEDURE

1. The EUT is placed on a turntable, which is 0.8m above ground plane.
2. The turntable shall be rotated for 360 degrees to determine the position of maximum emission level.
3. EUT is set 3m away from the receiving antenna, which is varied from 1m to 4m to find out the highest emissions.
4. Maximum procedure was performed on the six highest emissions to ensure EUT compliance.
5. And also, each emission was to be maximized by changing the polarization of receiving antenna both horizontal and vertical.
6. Set the spectrum analyzer in the following setting as:

Below 30MHz

RBW=10kHz / VBW=30kHz / Sweep=AUTO

30 ~ 1000MHz:

RBW=100kHz / VBW=300KHz / Sweep=AUTO

Above 1GHz:

- a) PEAK: RBW=1MHz / VBW=3MHz / Sweep=AUTO
- b) AVERAGE: RBW=1MHz / VBW=300Hz / Sweep=AUTO

7. Repeat above procedures until the measurements for all frequencies are complete.



DATA SAMPLE

Below 1 GHz

Frequency (MHz)	Reading (dBuV)	Correction Factor (dB/m)	Result (dBuV/m)	Limit (dBuV/m)	Margin (dB)	Ant. Pol. (H/V)	Remark
x.xx	43.20	-20.71	22.49	40.00	-17.51	V	QP

Frequency (MHz) = Emission frequency in MHz
 Reading (dBuV) = Uncorrected Analyzer / Receiver reading
 Correction Factor (dB/m) = Antenna factor – Amplifier gain + Cable loss
 Result (dBuV/m) = Reading (dBuV) + Corr. Factor (dB/m)
 Limit (dBuV/m) = Limit stated in standard
 Margin (dB) = Result (dBuV/m) – Limit (dBuV/m)
 Q.P. = Quasi-Peak

Above 1 GHz

Freq. (MHz)	Reading (dBuV)	Correct Factor (dB/m)	Result (dBuV/m)	Limit (dBuV/m)	Margin (dB)	Ant. Pol H/V	Remark
x.xx	45.25	6.91	52.16	74.00	-21.84	H	peak
x.xx	32.33	6.91	39.24	54.00	-14.76	H	AVG

Frequency (MHz) = Emission frequency in MHz
 Reading (dBuV) = Uncorrected Analyzer / Receiver reading
 Correction Factor (dB/m) = Antenna factor + Cable loss – Amplifier gain
 Result (dBuV/m) = Reading (dBuV) + Corr. Factor (dB/m)
 Limit (dBuV/m) = Limit stated in standard
 Margin (dB) = Result (dBuV/m) – Limit (dBuV/m)



Below 1 GHz

Operation Mode: Normal Link **Test Date:** 2014/3/12
Temperature: 26°C **Tested by:** Louis Shen
Humidity: 56% RH **Polarity:** Ver. / Hor.

Frequency (MHz)	Reading (dBuV)	Correction Factor (dB/m)	Result (dBuV/m)	Limit (dBuV/m)	Margin (dB)	Ant. Pol. (H/V)	Remark
36.7900	46.20	-12.73	33.47	40.00	-6.53	V	QP
48.4300	53.95	-18.56	35.39	40.00	-4.61	V	QP
159.9800	40.01	-16.75	23.26	43.50	-20.24	V	QP
192.9600	40.73	-16.91	23.82	43.50	-19.68	V	QP
299.6600	38.35	-12.49	25.86	46.00	-20.14	V	QP
600.3600	36.83	-8.00	28.83	46.00	-17.17	V	QP
191.9900	42.78	-16.95	25.83	43.50	-17.67	H	QP
299.6600	39.93	-12.49	27.44	46.00	-18.56	H	QP
412.1800	36.53	-10.13	26.40	46.00	-19.60	H	QP
487.8400	36.41	-9.40	27.01	46.00	-18.99	H	QP
500.4500	35.38	-9.24	26.14	46.00	-19.86	H	QP
749.7400	31.43	-6.14	25.29	46.00	-20.71	H	QP
908.8200	35.09	-3.85	31.24	46.00	-14.76	H	QP

Remark:

1. No emission found between lowest internal used/generated frequency to 30MHz (9kHz~30MHz).
2. Radiated emissions measured in frequency range from 30 MHz to 1000MHz were made with an instrument using peak/quasi-peak detector mode.
3. Quasi-peak test would be performed if the peak result were greater than the quasi-peak limit or as required by the applicant.
4. Measurements above show only up to 6 maximum emissions noted, or would be lesser, with " N/A " remark, if no specific emissions from the EUT are recorded (ie: margin>20dB from the applicable limit) and considered that's already beyond the background noise floor.
5. Margin (dB) = Remark result (dBuV/m) – Quasi-peak limit (dBuV/m).



Above 1 GHz

Operation Mode: TX / IEEE 802.11b mode / CH Low **Test Date:** 2014/3/17

Temperature: 26°C

Tested by: Francis Lee

Humidity: 56%RH

Polarity: Ver. / Hor.

Freq. (MHz)	Reading (dBuV)	Correct Factor (dB/m)	Result (dBuV/m)	Limit (dBuV/m)	Margin (dB)	Ant. Pol H/V	Remark
1516.000	54.19	-5.18	49.01	74.00	-24.99	V	peak
2206.000	54.45	-1.34	53.11	74.00	-20.89	V	peak
2206.000	40.62	-1.34	39.28	54.00	-14.72	V	AVG
2512.000	54.62	-1.08	53.54	74.00	-20.46	V	peak
2512.000	41.23	-1.08	40.15	54.00	-13.85	V	AVG
2724.000	54.29	-1.62	52.67	74.00	-21.33	V	peak
2724.000	40.68	-1.62	39.06	54.00	-14.94	V	AVG
3590.000	41.37	2.86	44.23	74.00	-29.77	V	peak
4825.000	42.68	2.68	45.36	74.00	-28.64	V	peak
7570.000	38.91	11.80	50.71	74.00	-23.29	V	peak
1394.000	53.36	-7.05	46.31	74.00	-27.69	H	peak
2176.000	53.33	-3.61	49.72	74.00	-24.28	H	peak
2568.000	55.28	-3.50	51.78	74.00	-22.22	H	peak
3830.000	40.73	5.14	45.87	74.00	-28.13	H	peak
4825.000	46.88	5.88	52.76	74.00	-21.24	H	peak
4825.000	46.33	5.88	52.21	54.00	-1.79	H	AVG
7550.000	39.97	10.74	50.71	74.00	-23.29	H	peak

Remark:

1. Measuring frequencies from 1 GHz to the 10th harmonic of highest fundamental frequency.
2. Radiated emissions measured in frequency above 1000MHz were made with an instrument using peak/average detector mode.
3. Average test would be performed if the peak result were greater than the average limit.
4. Data of measurement within this frequency range shown " --- " in the table above means the reading of emissions are attenuated more than 20dB below the permissible limits or the field strength is too small to be measured.
5. Measurements above show only up to 6 maximum emissions noted, or would be lesser, with " N/A " remark, if no specific emissions from the EUT are recorded (ie: margin>20dB from the applicable limit) and considered that's already beyond the background noise floor.
6. Margin (dB) = Remark result (dBuV/m) – Average limit (dBuV/m).



Operation Mode: TX / IEEE 802.11b mode / CH Mid Test Date: 2014/3/17

Temperature: 26°C

Tested by: Francis Lee

Humidity: 56%RH

Polarity: Ver. / Hor.

Freq. (MHz)	Reading (dBuV)	Correct Factor (dB/m)	Result (dBuV/m)	Limit (dBuV/m)	Margin (dB)	Ant. Pol H/V	Remark
1404.000	54.39	-6.58	47.81	74.00	-26.19	V	peak
1998.000	53.10	-1.33	51.77	74.00	-22.23	V	peak
2292.000	54.75	-1.53	53.22	74.00	-20.78	V	peak
2292.000	41.27	-1.53	39.74	54.00	-14.26	V	AVG
2712.000	53.96	-1.55	52.41	74.00	-21.59	V	peak
2712.000	40.78	-1.55	39.23	54.00	-14.77	V	AVG
2894.000	53.60	-0.75	52.85	74.00	-21.15	V	peak
2894.000	40.46	-0.75	39.71	54.00	-14.29	V	AVG
3605.000	40.17	2.91	43.08	74.00	-30.92	V	peak
4875.000	43.73	3.81	47.54	74.00	-26.46	V	peak
7550.000	38.94	11.72	50.66	74.00	-23.34	V	peak
1720.000	54.95	-7.45	47.50	74.00	-26.50	H	peak
2186.000	54.12	-3.59	50.53	74.00	-23.47	H	peak
2738.000	54.59	-3.03	51.56	74.00	-22.44	H	peak
4505.000	41.41	6.58	47.99	74.00	-26.01	H	peak
4875.000	45.52	6.73	52.25	74.00	-21.75	H	peak
4875.000	44.32	6.73	51.05	54.00	-2.95	H	AVG
7480.000	37.99	10.97	48.96	74.00	-25.04	H	peak

Remark:

1. Measuring frequencies from 1 GHz to the 10th harmonic of highest fundamental frequency.
2. Radiated emissions measured in frequency above 1000MHz were made with an instrument using peak/average detector mode.
3. Average test would be performed if the peak result were greater than the average limit.
4. Data of measurement within this frequency range shown " --- " in the table above means the reading of emissions are attenuated more than 20dB below the permissible limits or the field strength is too small to be measured.
5. Measurements above show only up to 6 maximum emissions noted, or would be lesser, with " N/A " remark, if no specific emissions from the EUT are recorded (ie: margin>20dB from the applicable limit) and considered that's already beyond the background noise floor.
6. Margin (dB) = Remark result (dBuV/m) – Average limit (dBuV/m).



Operation Mode:TX / IEEE 802.11b mode / CH High Test Date: 2014/3/17

Temperature: 26°C

Tested by: Francis Lee

Humidity: 56%RH

Polarity: Ver. / Hor.

Freq. (MHz)	Reading (dBuV)	Correct Factor (dB/m)	Result (dBuV/m)	Limit (dBuV/m)	Margin (dB)	Ant. Pol H/V	Remark
1536.000	54.03	-5.09	48.94	74.00	-25.06	V	peak
1970.000	53.60	-1.77	51.83	74.00	-22.17	V	peak
2214.000	53.51	-1.36	52.15	74.00	-21.85	V	peak
2214.000	40.61	-1.36	39.25	54.00	-14.75	V	AVG
2708.000	53.93	-1.52	52.41	74.00	-21.59	V	peak
2708.000	40.83	-1.52	39.31	54.00	-14.69	V	AVG
3665.000	41.77	2.63	44.40	74.00	-29.60	V	peak
4925.000	42.70	4.61	47.31	74.00	-26.69	V	peak
7635.000	38.51	11.51	50.02	74.00	-23.98	V	peak
1416.000	54.40	-7.24	47.16	74.00	-26.84	H	peak
2172.000	54.11	-3.62	50.49	74.00	-23.51	H	peak
2798.000	53.73	-2.50	51.23	74.00	-22.77	H	peak
3905.000	40.83	5.20	46.03	74.00	-27.97	H	peak
4925.000	46.92	7.26	54.18	74.00	-19.82	H	peak
4925.000	45.32	7.26	52.58	54.00	-1.42	H	AVG
7385.000	37.81	11.39	49.20	74.00	-24.80	H	peak

Remark:

1. Measuring frequencies from 1 GHz to the 10th harmonic of highest fundamental frequency.
2. Radiated emissions measured in frequency above 1000MHz were made with an instrument using peak/average detector mode.
3. Average test would be performed if the peak result were greater than the average limit.
4. Data of measurement within this frequency range shown " --- " in the table above means the reading of emissions are attenuated more than 20dB below the permissible limits or the field strength is too small to be measured.
5. Measurements above show only up to 6 maximum emissions noted, or would be lesser, with " N/A " remark, if no specific emissions from the EUT are recorded (ie: margin>20dB from the applicable limit) and considered that's already beyond the background noise floor.
6. Margin (dB) = Remark result (dBuV/m) – Average limit (dBuV/m).



Operation Mode:TX / IEEE 802.11g mode / CH Low Test Date: 2014/3/17

Temperature: 26°C

Tested by: Francis Lee

Humidity: 56%RH

Polarity: Ver. / Hor.

Freq. (MHz)	Reading (dBuV)	Correct Factor (dB/m)	Result (dBuV/m)	Limit (dBuV/m)	Margin (dB)	Ant. Pol H/V	Remark
1628.000	54.53	-5.03	49.50	74.00	-24.50	V	peak
1996.000	54.45	-1.36	53.09	74.00	-20.91	V	peak
1996.000	40.41	-1.36	39.05	54.00	-14.95	V	AVG
2244.000	53.93	-1.43	52.50	74.00	-21.50	V	peak
2244.000	40.94	-1.43	39.51	54.00	-14.49	V	AVG
2680.000	53.85	-1.61	52.24	74.00	-21.76	V	peak
2680.000	40.60	-1.61	38.99	54.00	-15.01	V	AVG
3615.000	41.14	2.86	44.00	74.00	-30.00	V	peak
4825.000	43.12	2.68	45.80	74.00	-28.20	V	peak
7575.000	38.90	11.82	50.72	74.00	-23.28	V	peak
1394.000	54.01	-7.05	46.96	74.00	-27.04	H	peak
2144.000	53.91	-3.68	50.23	74.00	-23.77	H	peak
2830.000	53.20	-2.25	50.95	74.00	-23.05	H	peak
3840.000	40.31	5.15	45.46	74.00	-28.54	H	peak
4825.000	46.04	5.88	51.92	74.00	-22.08	H	peak
7390.000	38.36	11.36	49.72	74.00	-24.28	H	peak

Remark:

1. Measuring frequencies from 1 GHz to the 10th harmonic of highest fundamental frequency.
2. Radiated emissions measured in frequency above 1000MHz were made with an instrument using peak/average detector mode.
3. Average test would be performed if the peak result were greater than the average limit.
4. Data of measurement within this frequency range shown " --- " in the table above means the reading of emissions are attenuated more than 20dB below the permissible limits or the field strength is too small to be measured.
5. Measurements above show only up to 6 maximum emissions noted, or would be lesser, with " N/A " remark, if no specific emissions from the EUT are recorded (ie: margin>20dB from the applicable limit) and considered that's already beyond the background noise floor.
6. Margin (dB) = Remark result (dBuV/m) – Average limit (dBuV/m).



Operation Mode:TX / IEEE 802.11g mode / CH Mid Test Date: 2014/3/17

Temperature: 26°C

Tested by: Francis Lee

Humidity: 56%RH

Polarity: Ver. / Hor.

Freq. (MHz)	Reading (dBuV)	Correct Factor (dB/m)	Result (dBuV/m)	Limit (dBuV/m)	Margin (dB)	Ant. Pol H/V	Remark
1528.000	53.94	-5.13	48.81	74.00	-25.19	V	peak
1984.000	52.99	-1.55	51.44	74.00	-22.56	V	peak
2256.000	53.95	-1.45	52.50	74.00	-21.50	V	peak
2256.000	41.04	-1.45	39.59	54.00	-14.41	V	AVG
2854.000	53.90	-1.32	52.58	74.00	-21.42	V	peak
2854.000	40.49	-1.32	39.17	54.00	-14.83	V	AVG
3735.000	42.40	2.90	45.30	74.00	-28.70	V	peak
4875.000	44.66	3.81	48.47	74.00	-25.53	V	peak
7580.000	38.19	11.84	50.03	74.00	-23.97	V	peak
1406.000	54.91	-7.03	47.88	74.00	-26.12	H	peak
2176.000	54.41	-3.61	50.80	74.00	-23.20	H	peak
2716.000	54.47	-3.23	51.24	74.00	-22.76	H	peak
3670.000	41.39	3.89	45.28	74.00	-28.72	H	peak
4875.000	50.00	6.73	56.73	74.00	-17.27	H	peak
4875.000	45.64	6.73	52.37	54.00	-1.63	H	AVG
7285.000	38.72	11.62	50.34	74.00	-23.66	H	peak

Remark:

1. Measuring frequencies from 1 GHz to the 10th harmonic of highest fundamental frequency.
2. Radiated emissions measured in frequency above 1000MHz were made with an instrument using peak/average detector mode.
3. Average test would be performed if the peak result were greater than the average limit.
4. Data of measurement within this frequency range shown " --- " in the table above means the reading of emissions are attenuated more than 20dB below the permissible limits or the field strength is too small to be measured.
5. Measurements above show only up to 6 maximum emissions noted, or would be lesser, with " N/A " remark, if no specific emissions from the EUT are recorded (ie: margin>20dB from the applicable limit) and considered that's already beyond the background noise floor.
6. Margin (dB) = Remark result (dBuV/m) – Average limit (dBuV/m).



Operation Mode:TX / IEEE 802.11g mode / CH High Test Date: 2014/3/17

Temperature: 26°C

Tested by: Francis Lee

Humidity: 56%RH

Polarity: Ver. / Hor.

Freq. (MHz)	Reading (dBuV)	Correct Factor (dB/m)	Result (dBuV/m)	Limit (dBuV/m)	Margin (dB)	Ant. Pol H/V	Remark
1588.000	53.97	-4.85	49.12	74.00	-24.88	V	peak
2016.000	54.20	-1.66	52.54	74.00	-21.46	V	peak
2016.000	40.44	-1.66	38.78	54.00	-15.22	V	AVG
2766.000	54.54	-1.89	52.65	74.00	-21.35	V	peak
2766.000	40.43	-1.89	38.54	54.00	-15.46	V	AVG
2974.000	53.99	-1.13	52.86	74.00	-21.14	V	peak
2974.000	40.85	-1.13	39.72	54.00	-14.28	V	AVG
3735.000	40.32	2.90	43.22	74.00	-30.78	V	peak
4925.000	42.36	4.61	46.97	74.00	-27.03	V	peak
7550.000	39.81	11.72	51.53	74.00	-22.47	V	peak
1392.000	54.70	-7.11	47.59	74.00	-26.41	H	peak
2114.000	54.16	-3.75	50.41	74.00	-23.59	H	peak
2814.000	53.75	-2.37	51.38	74.00	-22.62	H	peak
3805.000	40.40	5.11	45.51	74.00	-28.49	H	peak
4925.000	49.56	7.26	56.82	74.00	-17.18	H	peak
4925.000	45.29	7.26	52.55	54.00	-1.45	H	AVG
7275.000	38.44	11.49	49.93	74.00	-24.07	H	peak

Remark:

1. Measuring frequencies from 1 GHz to the 10th harmonic of highest fundamental frequency.
2. Radiated emissions measured in frequency above 1000MHz were made with an instrument using peak/average detector mode.
3. Average test would be performed if the peak result were greater than the average limit.
4. Data of measurement within this frequency range shown " --- " in the table above means the reading of emissions are attenuated more than 20dB below the permissible limits or the field strength is too small to be measured.
5. Measurements above show only up to 6 maximum emissions noted, or would be lesser, with " N/A " remark, if no specific emissions from the EUT are recorded (ie: margin>20dB from the applicable limit) and considered that's already beyond the background noise floor.
6. Margin (dB) = Remark result (dBuV/m) – Average limit (dBuV/m).



Operation Mode: TX / IEEE 802.11n HT20 mode / CH Low

Test Date: 2014/3/17

Temperature: 26°C

Tested by: Francis Lee

Humidity: 56%RH

Polarity: Ver. / Hor.

Freq. (MHz)	Reading (dBuV)	Correct Factor (dB/m)	Result (dBuV/m)	Limit (dBuV/m)	Margin (dB)	Ant. Pol H/V	Remark
1996.000	53.31	-1.36	51.95	74.00	-22.05	V	peak
2300.000	55.57	-1.55	54.02	74.00	-19.98	V	peak
2300.000	41.00	-1.55	39.45	54.00	-14.55	V	AVG
2560.000	54.17	-1.67	52.50	74.00	-21.50	V	peak
2560.000	40.85	-1.67	39.18	54.00	-14.82	V	AVG
3735.000	40.60	2.90	43.50	74.00	-30.50	V	peak
4825.000	42.71	2.68	45.39	74.00	-28.61	V	peak
7570.000	39.03	11.80	50.83	74.00	-23.17	V	peak
1436.000	54.58	-7.66	46.92	74.00	-27.08	H	peak
2172.000	53.87	-3.62	50.25	74.00	-23.75	H	peak
2728.000	53.77	-3.12	50.65	74.00	-23.35	H	peak
3300.000	42.32	1.27	43.59	74.00	-30.41	H	peak
4825.000	45.53	5.88	51.41	74.00	-22.59	H	peak
7375.000	38.17	11.44	49.61	74.00	-24.39	H	peak

Remark:

1. Measuring frequencies from 1 GHz to the 10th harmonic of highest fundamental frequency.
2. Radiated emissions measured in frequency above 1000MHz were made with an instrument using peak/average detector mode.
3. Average test would be performed if the peak result were greater than the average limit.
4. Data of measurement within this frequency range shown " --- " in the table above means the reading of emissions are attenuated more than 20dB below the permissible limits or the field strength is too small to be measured.
5. Measurements above show only up to 6 maximum emissions noted, or would be lesser, with " N/A " remark, if no specific emissions from the EUT are recorded (ie: margin>20dB from the applicable limit) and considered that's already beyond the background noise floor.
6. Margin (dB) = Remark result (dBuV/m) – Average limit (dBuV/m).



Operation Mode: TX / IEEE 802.11n HT20 mode / CH Mid

Test Date: 2014/3/17

Temperature: 26°C

Tested by: Francis Lee

Humidity: 56%RH

Polarity: Ver. / Hor.

Freq. (MHz)	Reading (dBuV)	Correct Factor (dB/m)	Result (dBuV/m)	Limit (dBuV/m)	Margin (dB)	Ant. Pol H/V	Remark
1986.000	52.83	-1.52	51.31	74.00	-22.69	V	peak
2294.000	54.95	-1.54	53.41	74.00	-20.59	V	peak
2294.000	41.11	-1.54	39.57	54.00	-14.43	V	AVG
2616.000	53.35	-2.06	51.29	74.00	-22.71	V	peak
2904.000	53.48	-0.69	52.79	74.00	-21.21	V	peak
2904.000	40.39	-0.69	39.70	54.00	-14.30	V	AVG
3735.000	40.63	2.90	43.53	74.00	-30.47	V	peak
4875.000	44.19	3.81	48.00	74.00	-26.00	V	peak
7540.000	38.48	11.69	50.17	74.00	-23.83	V	peak
1746.000	54.78	-7.22	47.56	74.00	-26.44	H	peak
2184.000	54.12	-3.60	50.52	74.00	-23.48	H	peak
2720.000	54.86	-3.19	51.67	74.00	-22.33	H	peak
3900.000	39.65	5.22	44.87	74.00	-29.13	H	peak
4875.000	47.65	6.73	54.38	74.00	-19.62	H	peak
4875.000	45.47	6.73	52.20	54.00	-1.80	H	AVG
7265.000	39.50	11.35	50.85	74.00	-23.15	H	peak

Remark:

1. Measuring frequencies from 1 GHz to the 10th harmonic of highest fundamental frequency.
2. Radiated emissions measured in frequency above 1000MHz were made with an instrument using peak/average detector mode.
3. Average test would be performed if the peak result were greater than the average limit.
4. Data of measurement within this frequency range shown " --- " in the table above means the reading of emissions are attenuated more than 20dB below the permissible limits or the field strength is too small to be measured.
5. Measurements above show only up to 6 maximum emissions noted, or would be lesser, with " N/A " remark, if no specific emissions from the EUT are recorded (ie: margin>20dB from the applicable limit) and considered that's already beyond the background noise floor.
6. Margin (dB) = Remark result (dBuV/m) – Average limit (dBuV/m).



Operation Mode: TX / IEEE 802.11n HT20 mode / CH High

Test Date: 2014/3/17

Temperature: 26°C

Tested by: Francis Lee

Humidity: 56%RH

Polarity: Ver. / Hor.

Freq. (MHz)	Reading (dBuV)	Correct Factor (dB/m)	Result (dBuV/m)	Limit (dBuV/m)	Margin (dB)	Ant. Pol H/V	Remark
1542.000	55.03	-5.06	49.97	74.00	-24.03	V	peak
1992.000	54.03	-1.43	52.60	74.00	-21.40	V	peak
1992.000	40.40	-1.43	38.97	54.00	-15.03	V	AVG
2192.000	53.98	-1.51	52.47	74.00	-21.53	V	peak
2192.000	40.67	-1.51	39.16	54.00	-14.84	V	AVG
2682.000	53.52	-1.60	51.92	74.00	-22.08	V	peak
3635.000	40.82	2.77	43.59	74.00	-30.41	V	peak
4925.000	42.40	4.61	47.01	74.00	-26.99	V	peak
7595.000	38.46	11.89	50.35	74.00	-23.65	V	peak
1368.000	54.68	-7.72	46.96	74.00	-27.04	H	peak
2154.000	53.84	-3.66	50.18	74.00	-23.82	H	peak
2834.000	53.72	-2.22	51.50	74.00	-22.50	H	peak
4070.000	41.52	5.26	46.78	74.00	-27.22	H	peak
4925.000	47.56	7.26	54.82	74.00	-19.18	H	peak
4925.000	45.20	7.26	52.46	54.00	-1.54	H	AVG
6940.000	39.96	9.13	49.09	74.00	-24.91	H	peak

Remark:

1. Measuring frequencies from 1 GHz to the 10th harmonic of highest fundamental frequency.
2. Radiated emissions measured in frequency above 1000MHz were made with an instrument using peak/average detector mode.
3. Average test would be performed if the peak result were greater than the average limit.
4. Data of measurement within this frequency range shown " --- " in the table above means the reading of emissions are attenuated more than 20dB below the permissible limits or the field strength is too small to be measured.
5. Measurements above show only up to 6 maximum emissions noted, or would be lesser, with " N/A " remark, if no specific emissions from the EUT are recorded (ie: margin>20dB from the applicable limit) and considered that's already beyond the background noise floor.
6. Margin (dB) = Remark result (dBuV/m) – Average limit (dBuV/m).



Operation Mode: TX / IEEE 802.11n HT40 mode / CH Low

Test Date: 2014/3/17

Temperature: 26°C

Tested by: Francis Lee

Humidity: 56%RH

Polarity: Ver. / Hor.

Freq. (MHz)	Reading (dBuV)	Correct Factor (dB/m)	Result (dBuV/m)	Limit (dBuV/m)	Margin (dB)	Ant. Pol H/V	Remark
1558.000	53.96	-4.99	48.97	74.00	-25.03	V	peak
1976.000	54.35	-1.68	52.67	74.00	-21.33	V	peak
1976.000	40.43	-1.68	38.75	54.00	-15.25	V	AVG
2270.000	54.13	-1.48	52.65	74.00	-21.35	V	peak
2270.000	41.13	-1.48	39.65	54.00	-14.35	V	AVG
2694.000	53.37	-1.51	51.86	74.00	-22.14	V	peak
3560.000	41.82	2.65	44.47	74.00	-29.53	V	peak
4845.000	42.87	3.13	46.00	74.00	-28.00	V	peak
7550.000	38.31	11.72	50.03	74.00	-23.97	V	peak
1412.000	54.33	-7.15	47.18	74.00	-26.82	H	peak
2174.000	53.88	-3.62	50.26	74.00	-23.74	H	peak
2908.000	54.08	-1.64	52.44	74.00	-21.56	H	peak
2908.000	40.56	-1.64	38.92	54.00	-15.08	H	AVG
3950.000	41.14	5.04	46.18	74.00	-27.82	H	peak
4845.000	46.59	6.21	52.80	74.00	-21.20	H	peak
4845.000	45.76	6.21	51.97	54.00	-2.03	H	AVG
7270.000	39.59	11.42	51.01	74.00	-22.99	H	peak

Remark:

1. Measuring frequencies from 1 GHz to the 10th harmonic of highest fundamental frequency.
2. Radiated emissions measured in frequency above 1000MHz were made with an instrument using peak/average detector mode.
3. Average test would be performed if the peak result were greater than the average limit.
4. Data of measurement within this frequency range shown " --- " in the table above means the reading of emissions are attenuated more than 20dB below the permissible limits or the field strength is too small to be measured.
5. Measurements above show only up to 6 maximum emissions noted, or would be lesser, with " N/A " remark, if no specific emissions from the EUT are recorded (ie: margin>20dB from the applicable limit) and considered that's already beyond the background noise floor.
6. Margin (dB) = Remark result (dBuV/m) – Average limit (dBuV/m).



Operation Mode: TX / IEEE 802.11n HT40 mode / CH Mid

Test Date: 2014/3/17

Temperature: 26°C

Tested by: Francis Lee

Humidity: 56%RH

Polarity: Ver. / Hor.

Freq. (MHz)	Reading (dBuV)	Correct Factor (dB/m)	Result (dBuV/m)	Limit (dBuV/m)	Margin (dB)	Ant. Pol H/V	Remark
1582.000	53.71	-4.87	48.84	74.00	-25.16	V	peak
2004.000	53.49	-1.39	52.10	74.00	-21.90	V	peak
2004.000	40.36	-1.39	38.97	54.00	-15.03	V	AVG
2184.000	54.19	-1.69	52.50	74.00	-21.50	V	peak
2184.000	40.73	-1.69	39.04	54.00	-14.96	V	AVG
2836.000	54.82	-1.58	53.24	74.00	-20.76	V	peak
2836.000	40.55	-1.58	38.97	54.00	-15.03	V	AVG
3815.000	40.52	3.36	43.88	74.00	-30.12	V	peak
4875.000	44.95	3.81	48.76	74.00	-25.24	V	peak
7635.000	38.45	11.51	49.96	74.00	-24.04	V	peak
1396.000	53.91	-7.00	46.91	74.00	-27.09	H	peak
2110.000	54.42	-3.76	50.66	74.00	-23.34	H	peak
2896.000	53.59	-1.76	51.83	74.00	-22.17	H	peak
3870.000	40.53	5.18	45.71	74.00	-28.29	H	peak
4885.000	47.19	6.90	54.09	74.00	-19.91	H	peak
4885.000	45.65	6.90	52.55	54.00	-1.45	H	AVG
7285.000	37.96	11.62	49.58	74.00	-24.42	H	peak

Remark:

1. Measuring frequencies from 1 GHz to the 10th harmonic of highest fundamental frequency.
2. Radiated emissions measured in frequency above 1000MHz were made with an instrument using peak/average detector mode.
3. Average test would be performed if the peak result were greater than the average limit.
4. Data of measurement within this frequency range shown " --- " in the table above means the reading of emissions are attenuated more than 20dB below the permissible limits or the field strength is too small to be measured.
5. Measurements above show only up to 6 maximum emissions noted, or would be lesser, with " N/A " remark, if no specific emissions from the EUT are recorded (ie: margin>20dB from the applicable limit) and considered that's already beyond the background noise floor.
6. Margin (dB) = Remark result (dBuV/m) – Average limit (dBuV/m).



Operation Mode: TX / IEEE 802.11n HT40 mode / CH High

Test Date: 2014/3/17

Temperature: 26°C

Tested by: Francis Lee

Humidity: 56%RH

Polarity: Ver. / Hor.

Freq. (MHz)	Reading (dBuV)	Correct Factor (dB/m)	Result (dBuV/m)	Limit (dBuV/m)	Margin (dB)	Ant. Pol H/V	Remark
2000.000	54.02	-1.30	52.72	74.00	-21.28	V	peak
2000.000	40.47	-1.30	39.17	54.00	-14.83	V	AVG
2292.000	54.05	-1.53	52.52	74.00	-21.48	V	peak
2292.000	41.24	-1.53	39.71	54.00	-14.29	V	AVG
2514.000	56.58	-1.10	55.48	74.00	-18.52	V	peak
2514.000	46.13	-1.10	45.03	54.00	-8.97	V	AVG
2962.000	54.59	-1.05	53.54	74.00	-20.46	V	peak
2962.000	40.81	-1.05	39.76	54.00	-14.24	V	AVG
3630.000	40.85	2.79	43.64	74.00	-30.36	V	peak
4905.000	43.75	4.42	48.17	74.00	-25.83	V	peak
7605.000	38.12	11.85	49.97	74.00	-24.03	V	peak
1406.000	54.09	-7.03	47.06	74.00	-26.94	H	peak
2128.000	53.80	-3.72	50.08	74.00	-23.92	H	peak
2388.000	59.42	-6.35	53.07	74.00	-20.93	H	peak
2388.000	48.33	-6.35	41.98	54.00	-12.02	H	AVG
2514.000	65.21	-3.75	61.46	74.00	-12.54	H	peak
2514.000	52.40	-3.75	48.65	54.00	-5.35	H	AVG
2870.000	53.98	-1.95	52.03	74.00	-21.97	H	peak
2870.000	40.68	-1.95	38.73	54.00	-15.27	H	AVG
3810.000	39.53	5.11	44.64	74.00	-29.36	H	peak
4905.000	45.45	7.17	52.62	74.00	-21.38	H	peak
4905.000	45.12	7.17	52.29	54.00	-1.71	H	AVG
7290.000	38.47	11.69	50.16	74.00	-23.84	H	peak

Remark:

1. Measuring frequencies from 1 GHz to the 10th harmonic of highest fundamental frequency.
2. Radiated emissions measured in frequency above 1000MHz were made with an instrument using peak/average detector mode.
3. Average test would be performed if the peak result were greater than the average limit.
4. Data of measurement within this frequency range shown " --- " in the table above means the reading of emissions are attenuated more than 20dB below the permissible limits or the field strength is too small to be measured.
5. Measurements above show only up to 6 maximum emissions noted, or would be lesser, with " N/A " remark, if no specific emissions from the EUT are recorded (ie: margin>20dB from the applicable limit) and considered that's already beyond the background noise floor.
6. Margin (dB) = Remark result (dBuV/m) – Average limit (dBuV/m).



7.7 POWERLINE CONDUCTED EMISSIONS

LIMIT

According to §15.207(a), except as shown in paragraphs (b) and (c) of this section, for an intentional radiator that is designed to be connected to the public utility (AC) power line, the radio frequency voltage that is conducted back onto the AC power line on any frequency or frequencies within the band 150 kHz to 30 MHz shall not exceed the limits in the following table, as measured using a 50 μ H/50 ohms line impedance stabilization network (LISN). Compliance with the provisions of this paragraph shall be based on the measurement of the radio frequency voltage between each power line and ground at the power terminal. The lower limit applies at the boundary between the frequency ranges.

Frequency Range (MHz)	Limits (dB μ V)	
	Quasi-peak	Average
0.15 to 0.50	66 to 56*	56 to 46*
0.50 to 5	56	46
5 to 30	60	50

* Decreases with the logarithm of the frequency.

Test Configuration

See test photographs attached in Appendix 1 for the actual connections between EUT and support equipment.

TEST PROCEDURE

1. The EUT was placed on a table, which is 0.8m above ground plane.
2. Maximum procedure was performed on the six highest emissions to ensure EUT compliance.
3. Repeat above procedures until all frequency measured were complete.



TEST RESULTS

The initial step in collecting conducted data is a spectrum analyzer peak scan of the measurement range. Significant peaks are then marked as shown on the following data page, and these signals are then quasi-peaked.

Test Data

Operation Mode: Normal Link **Test Date:** 2014/3/14
Temperature: 25°C **Tested by:** Louis.Shen
Humidity: 57% RH

Freq. (MHz)	QP Reading	AV Reading	Corr. factor	QP Result	AV Result	QP Limit	AV Limit	QP Margin	AV Margin	Note
0.4840	34.15	19.84	9.64	43.79	29.48	56.27	46.27	-12.48	-16.79	L1
0.5246	37.92	25.61	9.64	47.56	35.25	56.00	46.00	-8.44	-10.75	L1
0.6492	39.50	28.09	9.64	49.14	37.73	56.00	46.00	-6.86	-8.27	L1
0.6706	37.26	25.08	9.64	46.90	34.72	56.00	46.00	-9.10	-11.28	L1
0.6766	38.37	24.75	9.64	48.01	34.39	56.00	46.00	-7.99	-11.61	L1
0.7955	29.80	19.33	9.64	39.44	28.97	56.00	46.00	-16.56	-17.03	L1
0.9242	34.44	22.81	9.64	44.08	32.45	56.00	46.00	-11.92	-13.55	L1
1.0040	35.19	23.10	9.64	44.83	32.74	56.00	46.00	-11.17	-13.26	L1
1.3035	32.34	20.83	9.65	41.99	30.48	56.00	46.00	-14.01	-15.52	L1
1.4879	29.26	19.16	9.65	38.91	28.81	56.00	46.00	-17.09	-17.19	L1
2.0216	28.39	17.83	9.68	38.07	27.51	56.00	46.00	-17.93	-18.49	L1
7.2893	36.56	26.47	9.76	46.32	36.23	60.00	50.00	-13.68	-13.77	L1
7.8767	37.40	26.96	9.78	47.18	36.74	60.00	50.00	-12.82	-13.26	L1
0.2788	35.70	22.04	9.59	45.29	31.63	60.85	50.85	-15.56	-19.22	L2
0.3717	29.22	14.87	9.60	38.82	24.47	58.46	48.46	-19.64	-23.99	L2
0.4850	35.75	19.61	9.62	45.37	29.23	56.25	46.25	-10.88	-17.02	L2
0.5404	39.73	25.56	9.62	49.35	35.18	56.00	46.00	-6.65	-10.82	L2
0.6467	40.14	26.94	9.62	49.76	36.56	56.00	46.00	-6.24	-9.44	L2
0.6890	39.79	24.47	9.62	49.41	34.09	56.00	46.00	-6.59	-11.91	L2
0.7500	27.05	13.11	9.62	36.67	22.73	56.00	46.00	-19.33	-23.27	L2
0.8014	28.72	15.33	9.62	38.34	24.95	56.00	46.00	-17.66	-21.05	L2
0.9286	34.86	21.20	9.62	44.48	30.82	56.00	46.00	-11.52	-15.18	L2
1.0069	32.59	19.58	9.62	42.21	29.20	56.00	46.00	-13.79	-16.80	L2
1.0209	33.98	20.99	9.62	43.60	30.61	56.00	46.00	-12.40	-15.39	L2
1.1725	30.23	16.91	9.63	39.86	26.54	56.00	46.00	-16.14	-19.46	L2
1.4404	30.12	17.58	9.63	39.75	27.21	56.00	46.00	-16.25	-18.79	L2
1.6752	28.70	17.17	9.65	38.35	26.82	56.00	46.00	-17.65	-19.18	L2
6.3420	31.87	22.18	9.73	41.60	31.91	60.00	50.00	-18.40	-18.09	L2
7.8442	36.41	27.45	9.77	46.18	37.22	60.00	50.00	-13.82	-12.78	L2

Remark:

1. Measuring frequencies from 0.15 MHz to 30MHz.
2. The emissions measured in frequency range from 0.15 MHz to 30MHz were made with an instrument using Quasi-peak detector and average detector.
3. The IF bandwidth of SPA between 0.15MHz to 30MHz was 10kHz; the IF bandwidth of Test Receiver between 0.15MHz to 30MHz was 9kHz;
4. L1 = Line One (Live Line) / L2 = Line Two (Neutral Line)



Test Plots

Conducted emissions (Line 1)

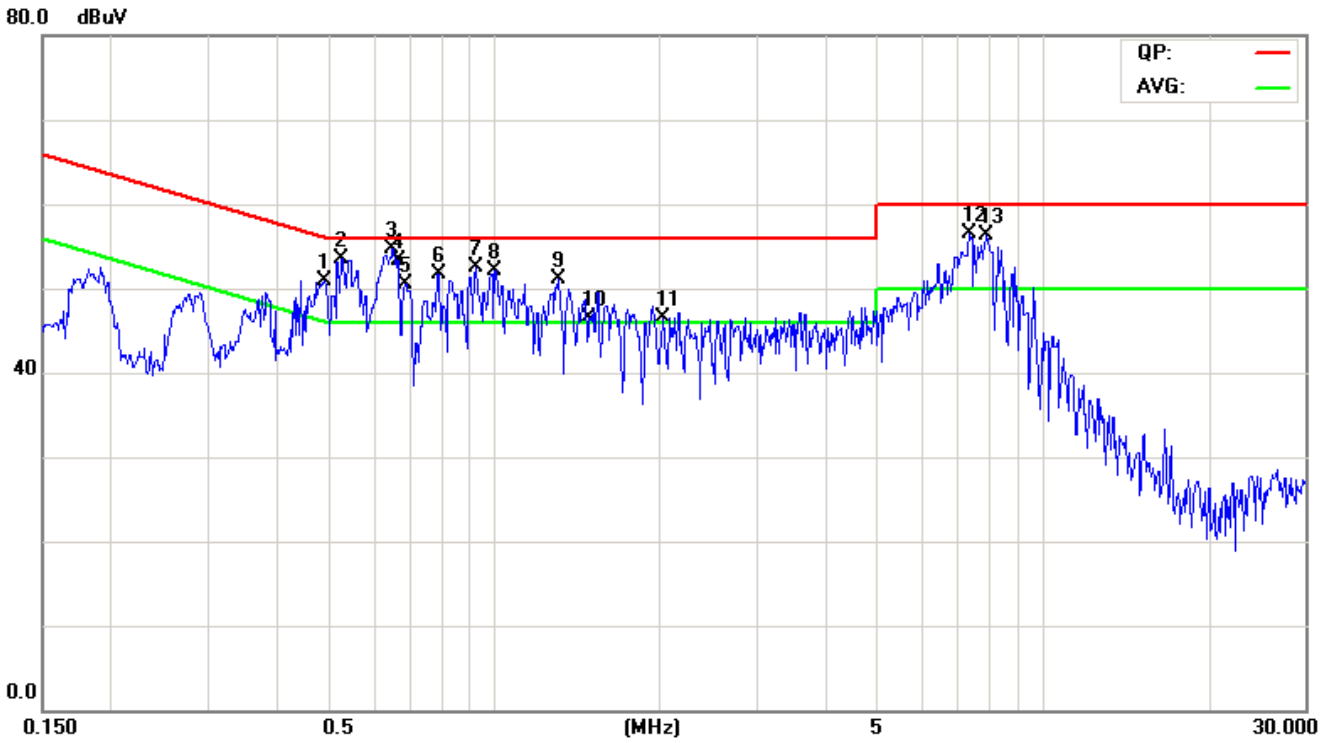

Conducted emissions (Line 2)

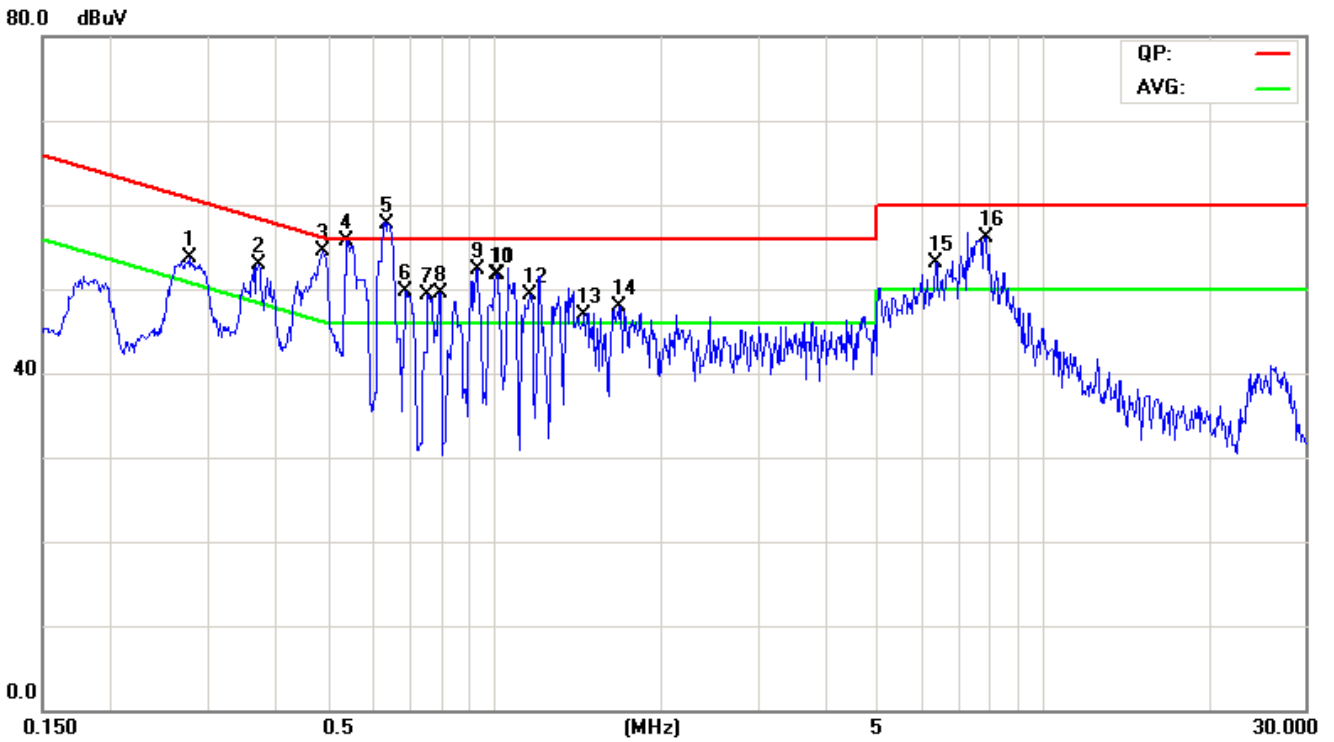



8 APPENDIX I PHOTOGRAPHS OF TEST SETUP

Radiated Emissions Setup Photos Below 1GHz

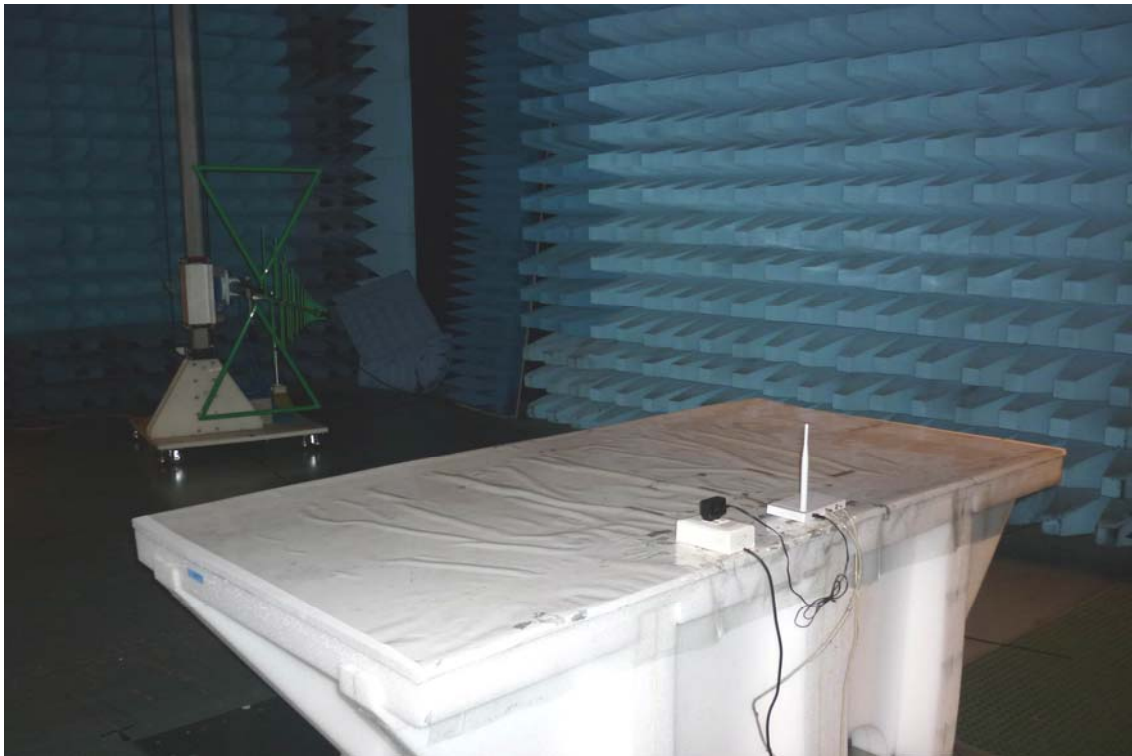



Above 1GHz

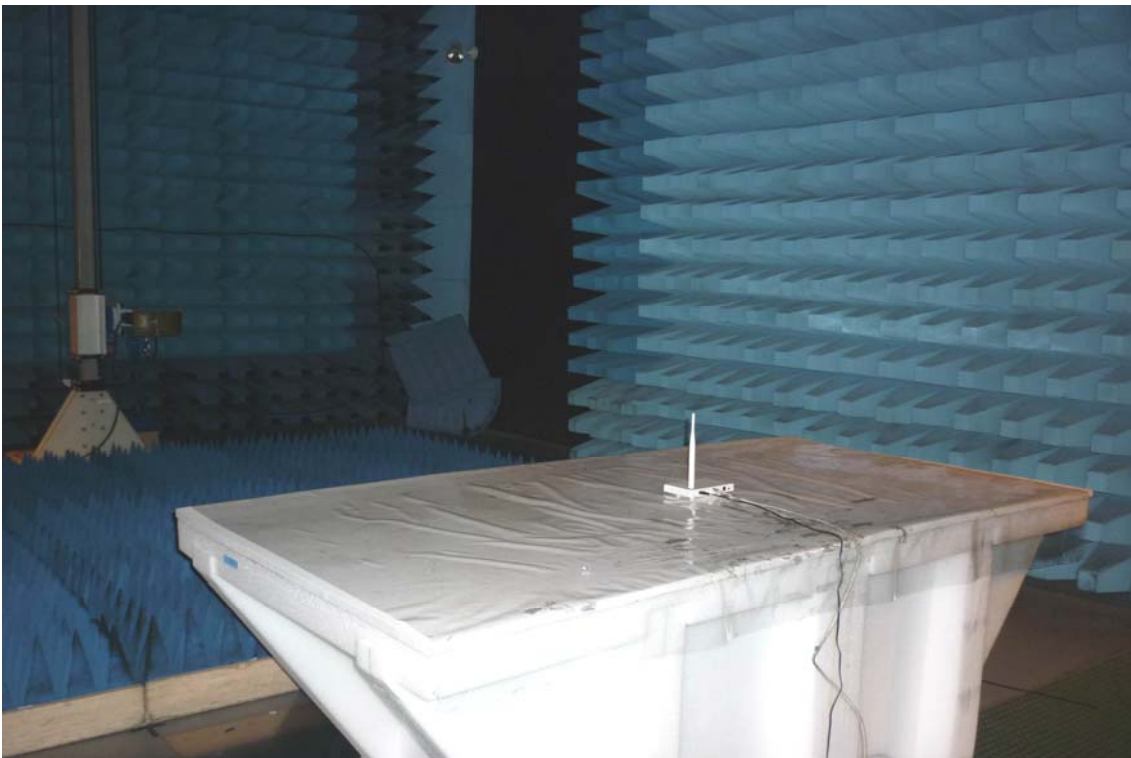



Conducted Emissions Setup Photo

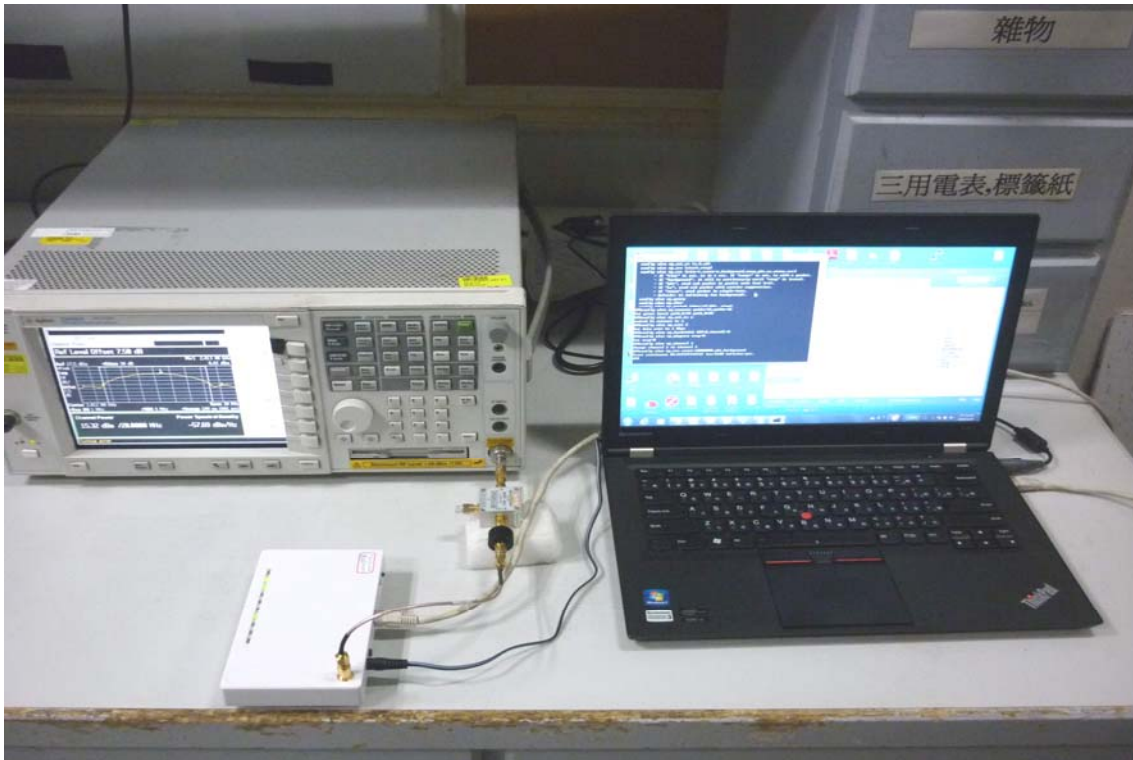



Powerline Conducted Emissions Setup Photos





9 APPENDIX II: PHOTOGRAPHS OF EUT

Refer to T140310D04 Photographs.