



FCC 47 CFR PART 15 SUBPART C

TEST REPORT

For

Wireless Access Point

Model: 520G / NC-520GM1 / NE-520GM1

Trade Name: N/A

Prepared for

NETCORE TECHNOLOGY INC.

**9F, B BLOCK, RESEARCH&DEVELOPMENT BUILDING, TSING HUA
INFORMATION PARK, HIGH-TECH INDUSTRIAL PARK NORTH
SECTION, NANSHAN, SHENZHEN, CHINA**

Prepared by

COMPLIANCE CERTIFICATION SERVICES (SHENZHEN) INC.

NO. 5, JINAO INDUSTRIAL PARK, NO. 35 JUKENG ROAD,

DASHUIKENG VILLAGE, GUANLAN TOWN, BAOAN

DISTRICT, SHENZHEN, CHINA

TEL: 86-755-28055000

FAX: 86-755-28055221



Note: This report shall not be reproduced except in full, without the written approval of Compliance Certification Services Inc. This document may be altered or revised by Compliance Certification Services Inc. personnel only, and shall be noted in the revision section of the document.



TABLE OF CONTENTS

1. TEST RESULT CERTIFICATION.....3

2. EUT DESCRIPTION4

3. TEST METHODOLOGY5

 3.1 EUT CONFIGURATION5

 3.2 EUT EXERCISE.....5

 3.3 GENERAL TEST PROCEDURES.....5

 3.4 FCC PART 15.205 RESTRICTED BANDS OF OPERATIONS.....6

 3.5 DESCRIPTION OF TEST MODES6

4. INSTRUMENT CALIBRATION.....7

5. FACILITIES AND ACCREDITATIONS8

 5.1 FACILITIES.....8

 5.2 EQUIPMENT.....8

 5.3 LABORATORY ACCREDITATIONS AND LISTING.....8

6. SETUP OF EQUIPMENT UNDER TEST9

 6.1 SETUP CONFIGURATION OF EUT.....9

 6.2 SUPPORT EQUIPMENT9

7. FCC PART 15.247 REQUIREMENTS.....10

 7.1 6DB BANDWIDTH.....10

 7.2 PEAK POWER.....16

 7.3 BAND EDGES MEASUREMENT22

 7.4 PEAK POWER SPECTRAL DENSITY.....31

 7.5 SPURIOUS EMISSIONS.....37

 7.6 POWERLINE CONDUCTED EMISSIONS59

APPENDIX 1 PHOTOGRPHS OF TEST SETUP65



1. TEST RESULT CERTIFICATION

Applicant: NETCORE TECHNOLOGY INC.
 9F, B BLOCK, RESEARCH&DEVELOPMENT BUILDING,
 TSING HUA INFORMATION PARK, HIGH-TECH
 INDUSTRIAL PARK NORTH SECTION, NANSHAN,
 SHENZHEN, CHINA

Equipment Under Test: Wireless Access Point

Trade Name: N/A

Model: 520G / NC-520GM1 / NE-520GM1

Date of Test: July 13-August 08, 2006

APPLICABLE STANDARDS	
STANDARD	TEST RESULT
FCC Part 15 Subpart C	No non-compliance noted

We hereby certify that:

The above equipment was tested by Compliance Certification Services (Shenzhen) Inc. The test data, data evaluation, test procedures, and equipment configurations shown in this report were made in accordance with the procedures given in ANSI C63.4: 2003 and the energy emitted by the sample EUT tested as described in this report is in compliance with the requirements of FCC Rules Part 15.207, 15.209, 15.247.

The test results of this report relate only to the tested sample EUT identified in this report.

Approved by:

Harris Lai / General Manager
COMPLIANCE CERTIFICATION
SERVICES (SHENZHEN) INC.

Tested By: Henry Ding

Reviewed By:

Eric Wong / Assistant manager
COMPLIANCE CERTIFICATION
SERVICES (SHENZHEN) INC.



2. EUT DESCRIPTION

Product	Wireless Access Point
Trade Name	N/A
Model Number	520G / NC-520GM1 / NE-520GM1
Model Difference	All models are identical to each other except for market designation for marketing purpose
Power Supply	Powered by the adapter
Frequency Range	802.11b mode: 2412 ~ 2462 MHz 802.11g mode: 2412 ~ 2462 MHz
Transmit Power	802.11b mode: 13.83 dBm 802.11g mode: 12.89 dBm
Modulation Technique	802.11b: DSSS (CCK; DQPSK; DBPSK) 802.11g: OFDM
Transmit Data Rate	802.11b: 11Mbps(CCK) with fall back rates of 5.5, 2, and 1Mbps 802.11g: 54Mbps with fall back rates of 48/36/24/18/12/9/6 Mbps (OFDM)
Number of Channels	11 Channels
Antenna Specification	Omni antenna Gain: 2 dBi (Max)

Note: This submittal(s) (test report) comply with Section 15.207, 15.209 and 15.247 of the FCC Part 15, Subpart C Rules.



3. TEST METHODOLOGY

The tests documented in this report were performed in accordance with ANSI C63.4: 2003 and FCC CFR 47 2.1046, 2.1047, 2.1049, 2.1051, 2.1053, 2.1055, 2.1057, 15.207, 15.209 and 15.247.

EUT CONFIGURATION

The EUT configuration for testing is installed on RF field strength measurement to meet the Commissions requirement and operating in a manner that intends to maximize its emission characteristics in a continuous normal application.

EUT EXERCISE

The EUT was operated in the engineering mode to fix the TX frequency that was for the purpose of the measurements.

According to its specifications, the EUT must comply with the requirements of the Section 15.207, 15.209 and 15.247 under the FCC Rules Part 15 Subpart C.

GENERAL TEST PROCEDURES

Conducted Emissions

The EUT is placed on the turntable, which is 0.8 m above ground plane. According to the requirements in Section 13.1.4.1 of ANSI C63.4: 2003 Conducted emissions from the EUT measured in the frequency range between 0.15 MHz and 30MHz using CISPR Quasi-peak and average detector modes.

Radiated Emissions

The EUT is placed on a turn table, which is 0.8 m above ground plane. The turntable shall rotate 360 degrees to determine the position of maximum emission level. EUT is set 3m away from the receiving antenna, which varied from 1m to 4m to find out the highest emission. And also, each emission was to be maximized by changing the polarization of receiving antenna both horizontal and vertical.



FCC PART 15.205 RESTRICTED BANDS OF OPERATIONS

(a) Except as shown in paragraph (d) of this section, only spurious emissions are permitted in any of the frequency bands listed below:

MHz	MHz	MHz	GHz
0.090 - 0.110	16.42 - 16.423	399.9 - 410	4.5 - 5.15
¹ 0.495 - 0.505	16.69475 - 16.69525	608 - 614	5.35 - 5.46
2.1735 - 2.1905	16.80425 - 16.80475	960 - 1240	7.25 - 7.75
4.125 - 4.128	25.5 - 25.67	1300 - 1427	8.025 - 8.5
4.17725 - 4.17775	37.5 - 38.25	1435 - 1626.5	9.0 - 9.2
4.20725 - 4.20775	73 - 74.6	1645.5 - 1646.5	9.3 - 9.5
6.215 - 6.218	74.8 - 75.2	1660 - 1710	10.6 - 12.7
6.26775 - 6.26825	108 - 121.94	1718.8 - 1722.2	13.25 - 13.4
6.31175 - 6.31225	123 - 138	2200 - 2300	14.47 - 14.5
8.291 - 8.294	149.9 - 150.05	2310 - 2390	15.35 - 16.2
8.362 - 8.366	156.52475 -	2483.5 - 2500	17.7 - 21.4
8.37625 - 8.38675	156.52525	2655 - 2900	22.01 - 23.12
8.41425 - 8.41475	156.7 - 156.9	3260 - 3267	23.6 - 24.0
12.29 - 12.293	162.0125 - 167.17	3332 - 3339	31.2 - 31.8
12.51975 - 12.52025	167.72 - 173.2	3345.8 - 3358	36.43 - 36.5
12.57675 - 12.57725	240 - 285	3600 - 4400	(²)
13.36 - 13.41	322 - 335.4		

¹ Until February 1, 1999, this restricted band shall be 0.490-0.510 MHz.

² Above 38.6

(b) Except as provided in paragraphs (d) and (e), the field strength of emissions appearing within these frequency bands shall not exceed the limits shown in Section 15.209. At frequencies equal to or less than 1000 MHz, compliance with the limits in Section 15.209 shall be demonstrated using measurement instrumentation employing a CISPR quasi-peak detector. Above 1000 MHz, compliance with the emission limits in Section 15.209 shall be demonstrated based on the average value of the measured emissions. The provisions in Section 15.35 apply to these measurements.

DESCRIPTION OF TEST MODES

The EUT has been tested under operating condition.

Software used to control the EUT for staying in continuous transmitting and receiving mode is programmed.

IEEE802.11b: Channel 1(2412MHz), Channel 6(2437MHz) and Channel 11(2462MHz) with 1Mbps highest data rate (worst case) are chosen for the final testing.

IEEE802.11g: Channel 1(2412MHz), Channel 6(2437MHz) and Channel 11(2462MHz) with 6Mbps data rate (the worst case) are chosen for the final testing.



4. INSTRUMENT CALIBRATION

The measuring equipment, which was utilized in performing the tests documented herein, has been calibrated in accordance with the manufacturer's recommendations for utilizing calibration equipment, which is traceable to recognized national standards.



5. FACILITIES AND ACCREDITATIONS

FACILITIES

All measurement facilities used to collect the measurement data are located at

No. 5, Jinao industrial park, No.35 Jukeng Road, Dashuikeng Village, Guanlan Town, Baoan District, Shenzhen, China

The sites are constructed in conformance with the requirements of ANSI C63.7, ANSI C63.4: 2003 and CISPR Publication 22.

EQUIPMENT

Radiated emissions are measured with one or more of the following types of Linearly polarized antennas: tuned dipole, biconical, log periodic, bi-log, and/or ridged waveguide, horn. Spectrum analyzers with pre-selectors and quasi-peak detectors are used to perform radiated measurements.

Conducted emissions are measured with Line Impedance Stabilization Networks and EMI Test Receivers.

Calibrated wideband preamplifiers, coaxial cables, and coaxial attenuators are also used for making measurements.

All receiving equipment conforms to CISPR Publication 16-1, "Radio Interference Measuring Apparatus and Measurement Methods."

LABORATORY ACCREDITATIONS AND LISTING

The test facilities used to perform radiated and conducted emissions tests are accredited by National Voluntary Laboratory Accreditation Program for the specific scope of accreditation under Lab Code: 200577-0 to perform Electromagnetic Interference tests according to FCC PART 15 AND CISPR 22 requirements. No part of this report may be used to claim or imply product endorsement by NVLAP or any agency of the US Government. In addition, the test facilities are listed with Federal Communications Commission.



6. SETUP OF EQUIPMENT UNDER TEST

SETUP CONFIGURATION OF EUT

See test photographs attached in Appendix 1 for the actual connections between EUT and support equipment.

SUPPORT EQUIPMENT

No	Equipment	Model	Serial No.	FCC ID	Trade Name	Data Cable	Power Cord
1.	Notebook	992F2VG	N/A	DoC	IBM	N/A	Unshielded 1.8m
2	AC Adapter	OH-41044DB	N/A	N/A	N/A	N/A	Unshielded 1.8m

Notes:

- 1. All the equipment/cables were placed in the worst-case configuration to maximize the emission during the test.*
- 2. Grounding was established in accordance with the manufacturer's requirements and conditions for the intended use.*

7. FCC PART 15.247 REQUIREMENTS

6dB BANDWIDTH

LIMIT

For the direct sequence systems, the minimum 6dB bandwidth shall be at least 500kHz.

MEASUREMENT EQUIPMENT USED

Name of Equipment	Manufacturer	Model	Serial Number	Calibration Due
PSA Spectrum Analyzer	Agilent	E4446A	US44300399	02/08/2007

Remark: Each piece of equipment is scheduled for calibration once a year.

Test Configuration

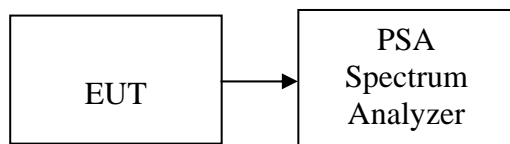

TEST PROCEDURE

1. Place the EUT on the table and set it in the transmitting mode.
2. Remove the antenna from the EUT and then connect a low loss RF cable from the antenna port to the spectrum analyzer.
3. Set the spectrum analyzer as RBW = 100kHz, VBW = RBW, Span = 20MHz, Sweep = auto.
4. Mark the peak frequency and -6dB (upper and lower) frequency.
5. Repeat until all the rest channels are investigated.



TEST RESULTS

No non-compliance noted

Test Data

Test mode: IEEE 802.11b

Channel	Frequency (MHz)	Bandwidth (kHz)	Limit (kHz)	Margin (kHz)
Low	2412	9530	>500	PASS
Mid	2437	9530		PASS
High	2462	9530		PASS

Test mode: IEEE 802.11g

Channel	Frequency (MHz)	Bandwidth (kHz)	Limit (kHz)	Margin (kHz)
Low	2412	16530	>500	PASS
Mid	2437	16530		PASS
High	2462	16530		PASS

Test Plot

802.11b mode

6dB Bandwidth (CH Low)

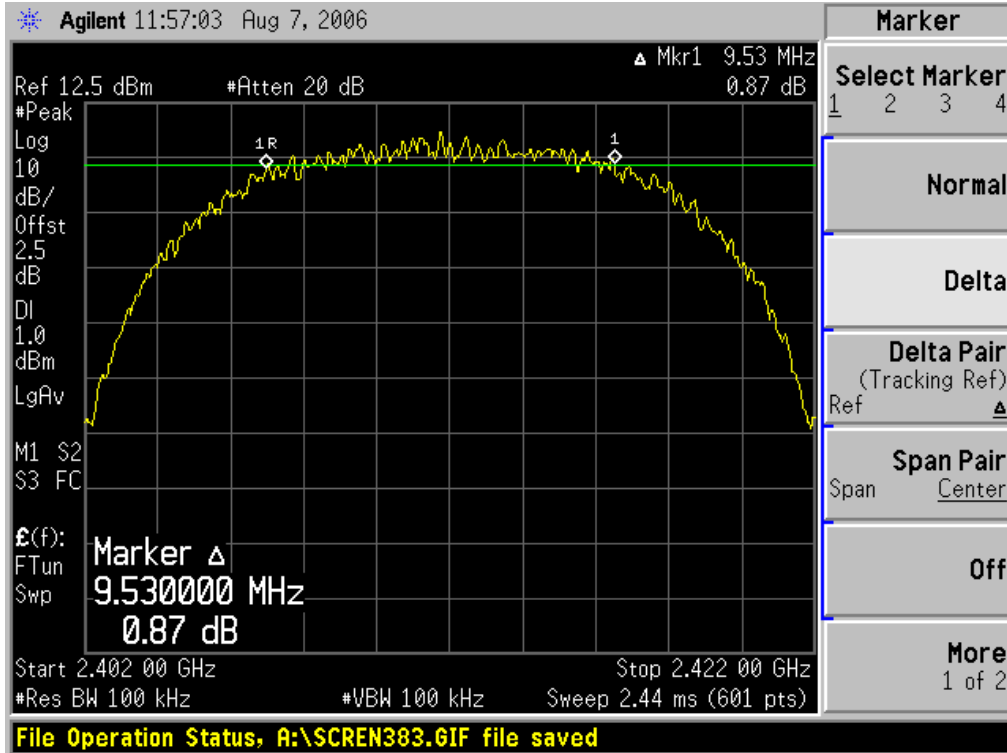

6dB Bandwidth (CH Mid)

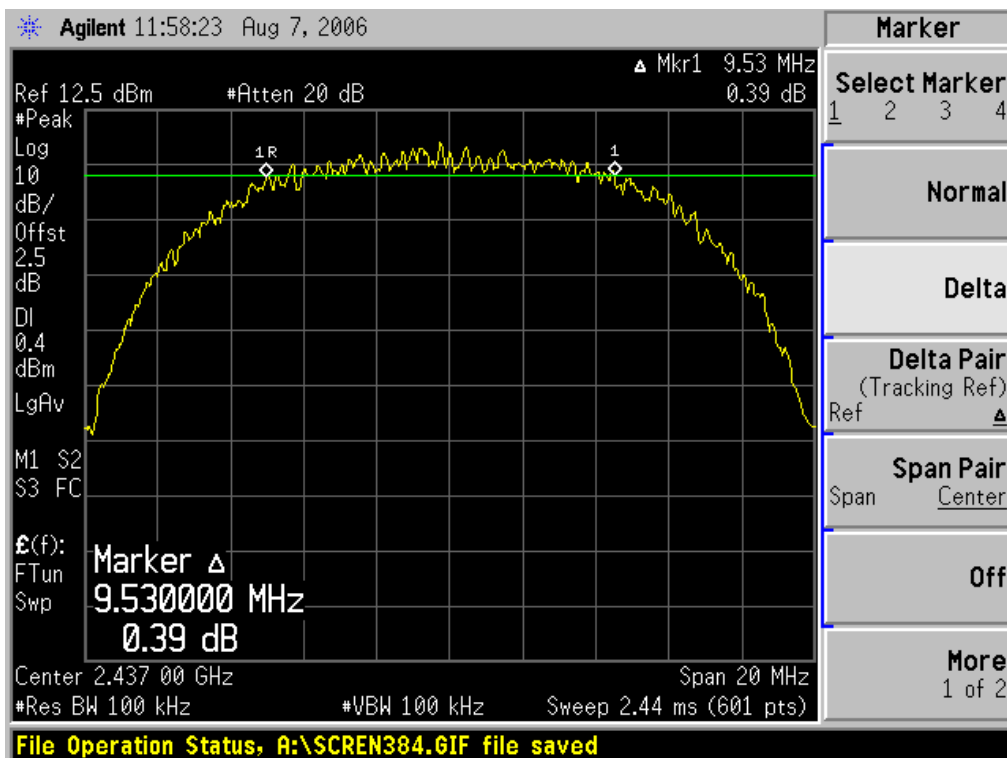



6dB Bandwidth (CH High)

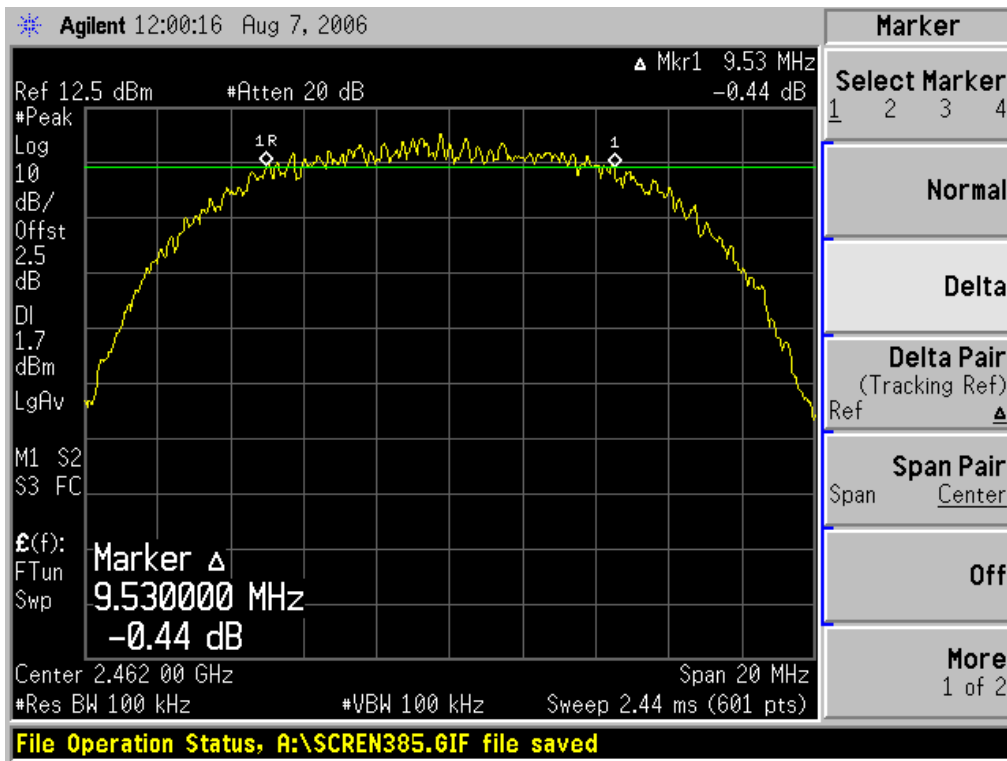



802.11g mode

6dB Bandwidth (CH Low)

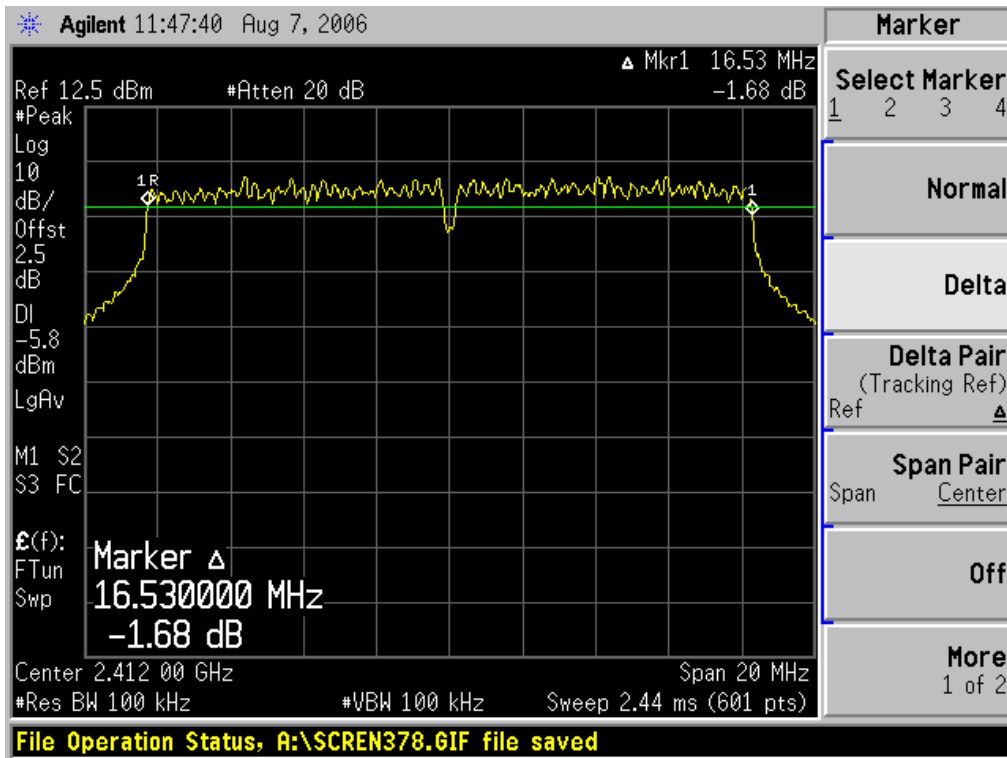

6dB Bandwidth (CH Mid)

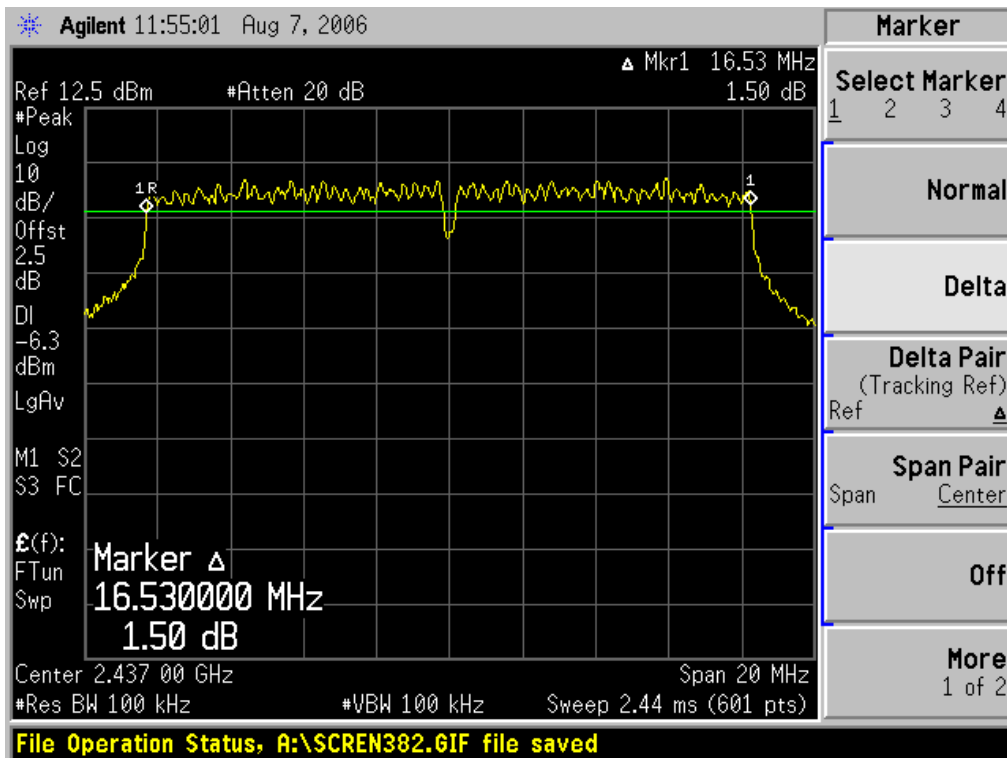



6dB Bandwidth (CH High)

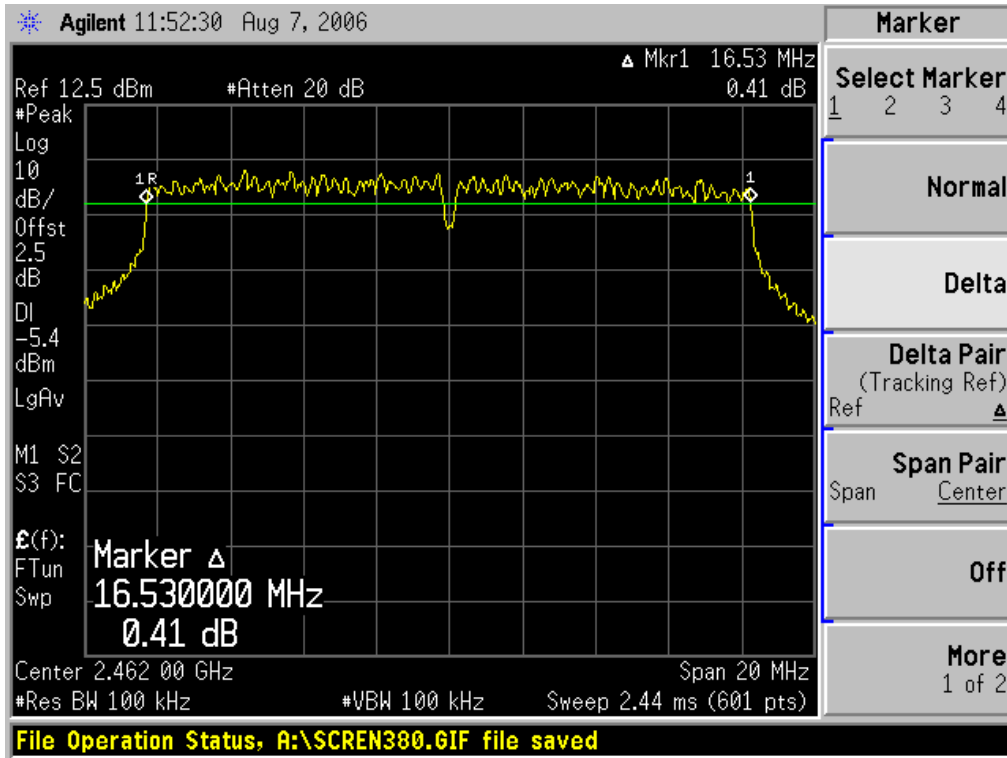



PEAK POWER

LIMIT

The maximum peak output power of the intentional radiator shall not exceed the following:

1. For systems using digital modulation in the bands of 902-928 MHz, 2400-2483.5 MHz, and 5725-5850 MHz: 1 watt.
2. Except as shown in paragraphs (b)(3) (i), (ii) and (iii) of this section, if transmitting antennas of directional gain greater than 6 dBi are used the peak output power from the intentional radiator shall be reduced below the stated values in paragraphs (b)(1) or (b)(2) of this section, as appropriate, by the amount in dB that the directional gain of the antenna exceeds 6 dBi.

MEASUREMENT EQUIPMENT USED

Name of Equipment	Manufacturer	Model	Serial Number	Calibration Due
PSA Spectrum Analyzer	Agilent	E4446A	US44300399	02/08/2007

Remark: Each piece of equipment is scheduled for calibration once a year.

Test Configuration

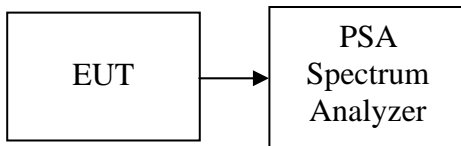

TEST PROCEDURE

The transmitter output is connected to the Spectrum analyzer. The Spectrum analyzer is set to the peak power detection.



TEST RESULTS

No non-compliance noted

Test Data

Test mode: IEEE 802.11b

Channel	Frequency (MHz)	Output Power (dBm)	Factor (dB)	Output Power (dBm)	Output Power (W)	Limit (W)	Result
Low	2412	11.33	250	13.83	0.02415	1	PASS
Md	2437	10.67	250	13.17	0.02075		PASS
Hgh	2462	10.60	250	13.10	0.02042		PASS

Test mode: IEEE 802.11g

Channel	Frequency (MHz)	Output Power (dBm)	Factor (dB)	Output Power (dBm)	Output Power (W)	Limit (W)	Result
Low	2412	10.08	250	12.58	0.01811	1	PASS
Md	2437	10.39	250	12.89	0.01945		PASS
Hgh	2462	10.06	250	12.56	0.01803		PASS



Test Plot

802.11b mode

Peak power (CH Low)

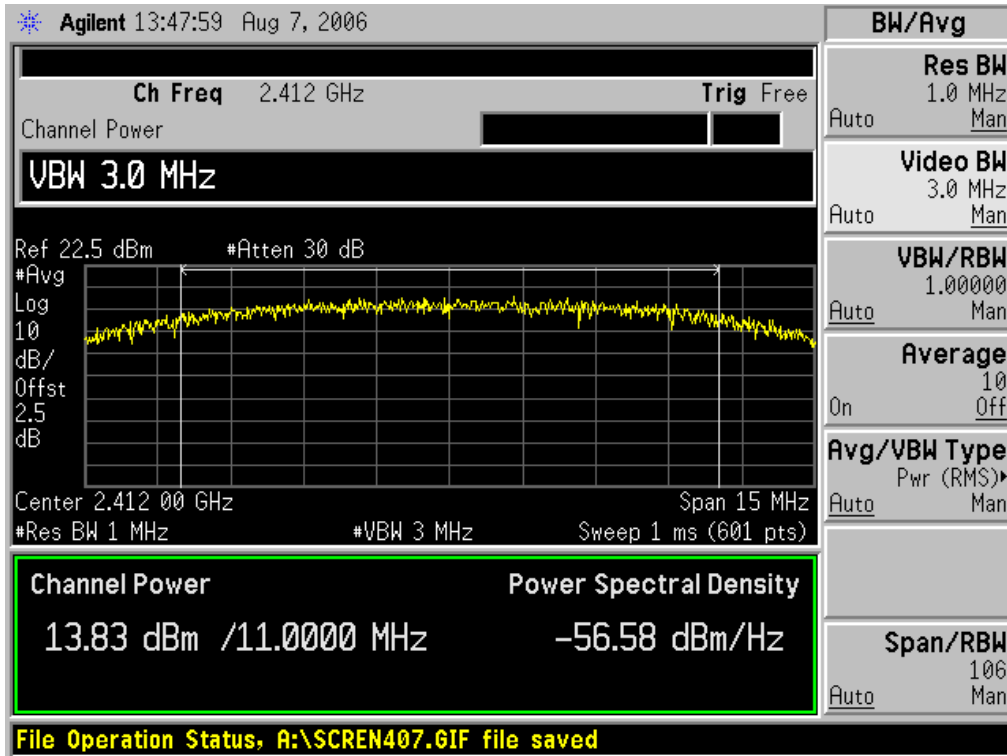

Peak power (CH Mid)

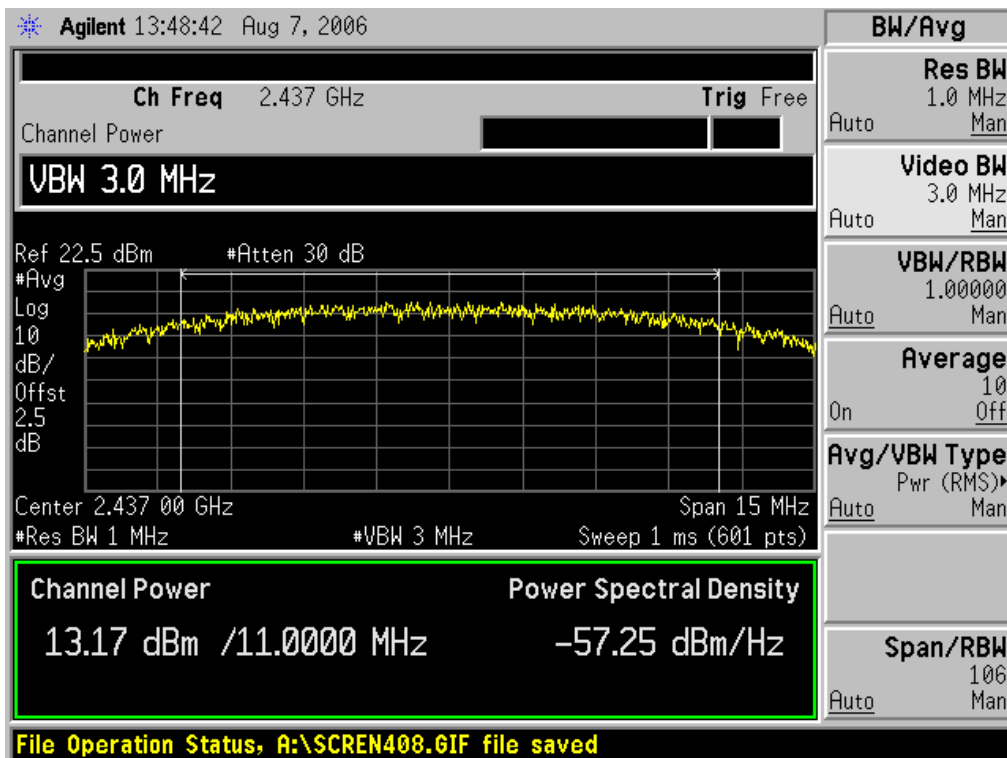



Peak power (CH High)

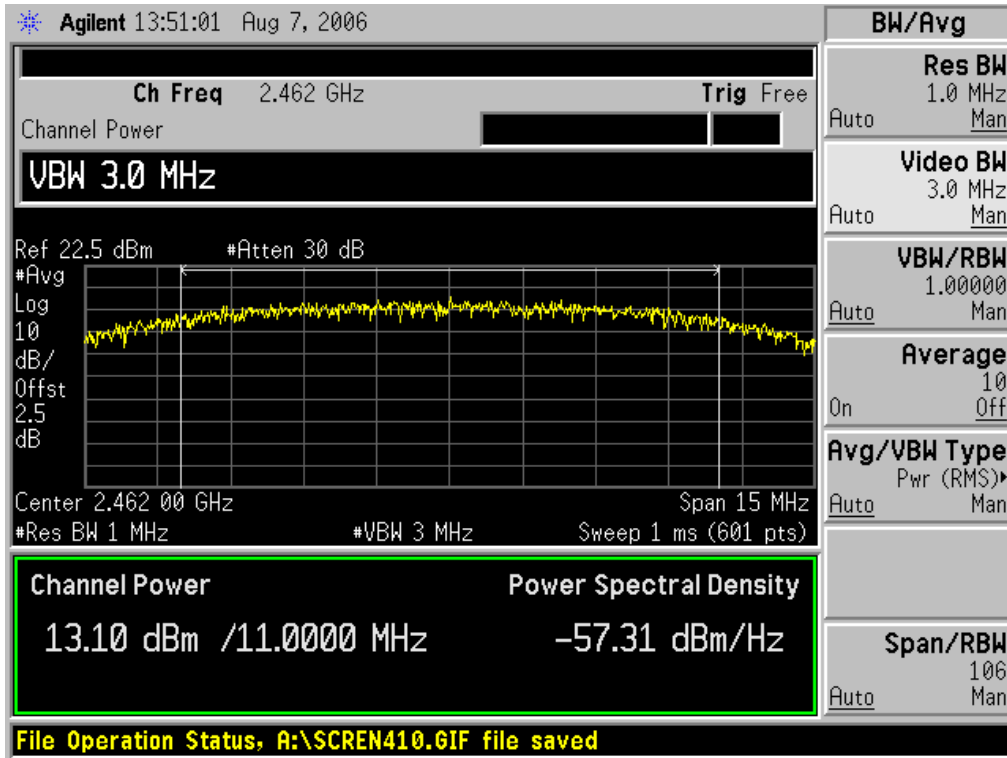



802.11g mode

Peak power (CH Low)

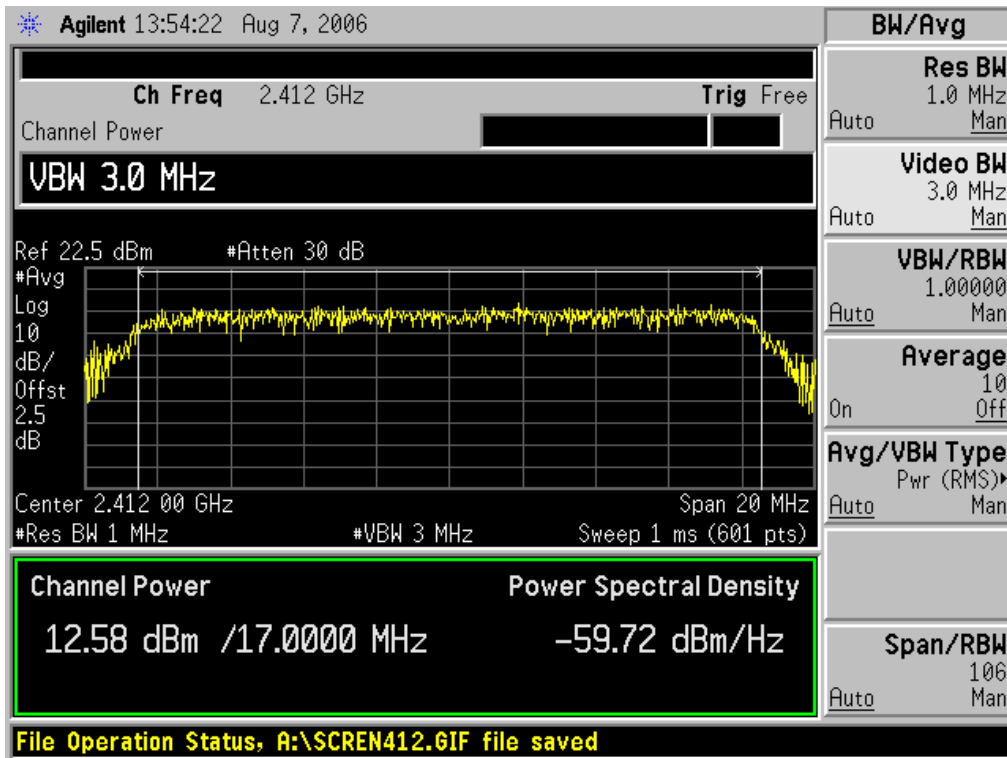

Peak power (CH Mid)

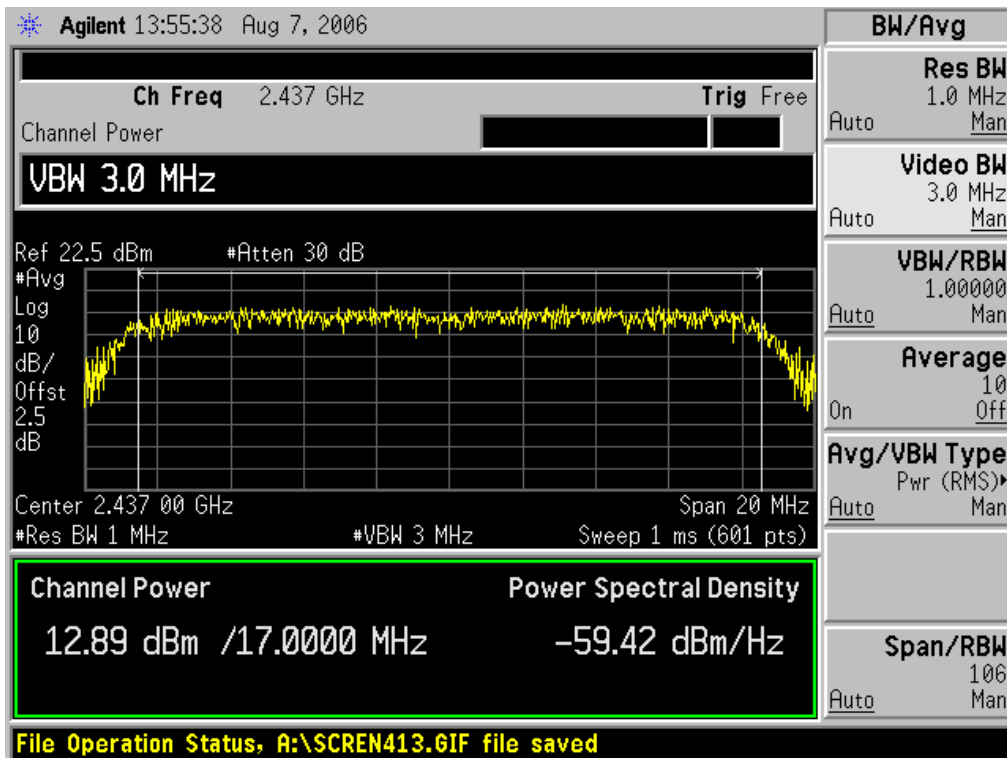



Peak power (CH High)

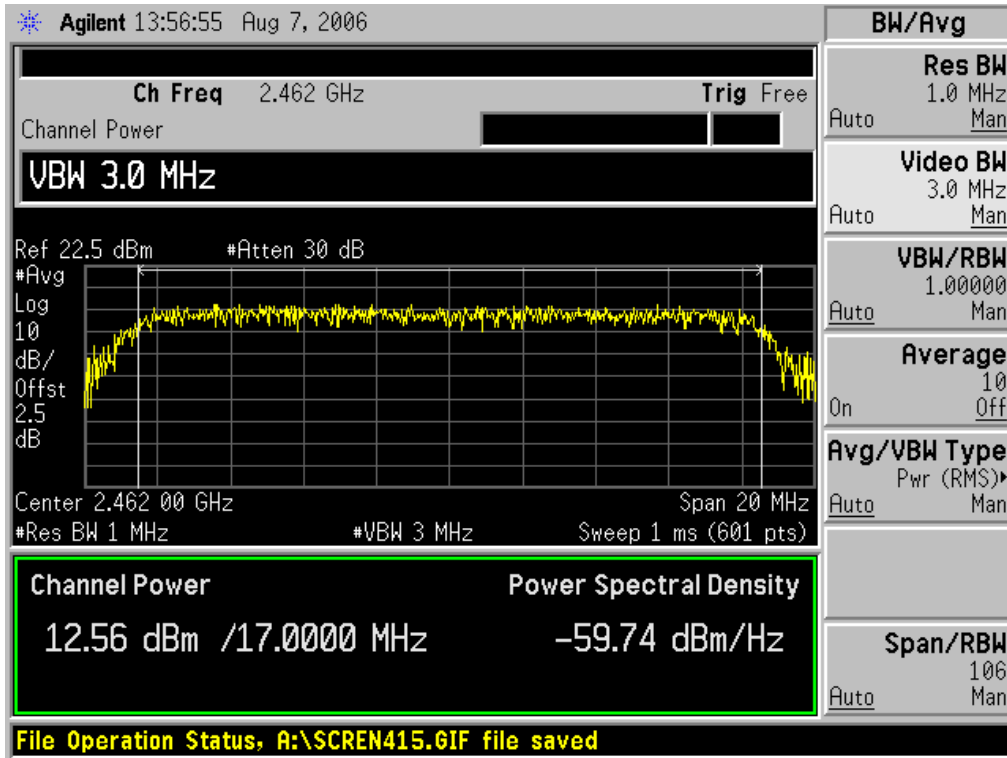

BAND EDGES MEASUREMENT

LIMIT

According to §15.247(c), in any 100 kHz bandwidth outside the frequency bands in which the spread spectrum intentional radiator is operating, the radio frequency power that is produced by the intentional radiator shall be at least 20dB below that in the 100kHz bandwidth within the band that contains the highest level of the desired power. In addition, radiated emissions which fall in the restricted bands, as defined in §15.205(a), must also comply with the radiated emission limits specified in §15.209(a).

MEASUREMENT EQUIPMENT USED

Name of Equipment	Manufacturer	Model	Serial Number	Calibration Due
PSA Spectrum Analyzer	Agilent	E4446A	US44300399	02/08/2007

Remark: Each piece of equipment is scheduled for calibration once a year.

Test Configuration

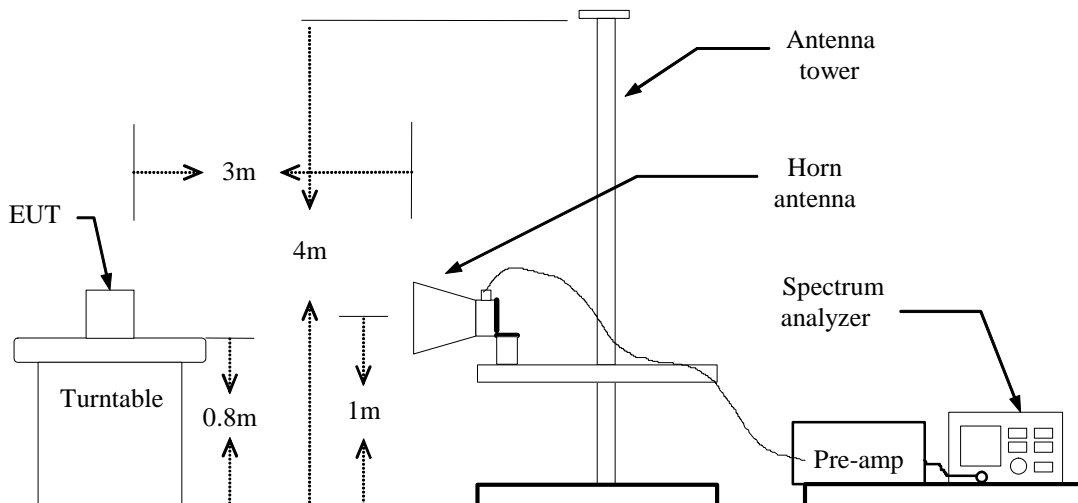

TEST PROCEDURE

1. The EUT is placed on a turntable, which is 0.8m above the ground plane.
2. The turntable shall be rotated for 360 degrees to determine the position of maximum emission level.
3. EUT is set 3m away from the receiving antenna, which is varied from 1m to 4m to find out the highest emission.
4. Set the spectrum analyzer in the following setting in order to capture the lower and upper band-edges of the emission:
 - (a) PEAK: RBW=VBW=1MHz / Sweep=AUTO
 - (b) AVERAGE: RBW=1MHz / VBW=10Hz / Sweep=AUTO
5. Repeat the procedures until all the PEAK and AVERAGE versus POLARIZATION are measured.

TEST RESULTS

Refer to attach spectrum analyzer data chart.

Band Edges (802.11b / CH Low)

Detector mode: Peak

Polarity: Vertical

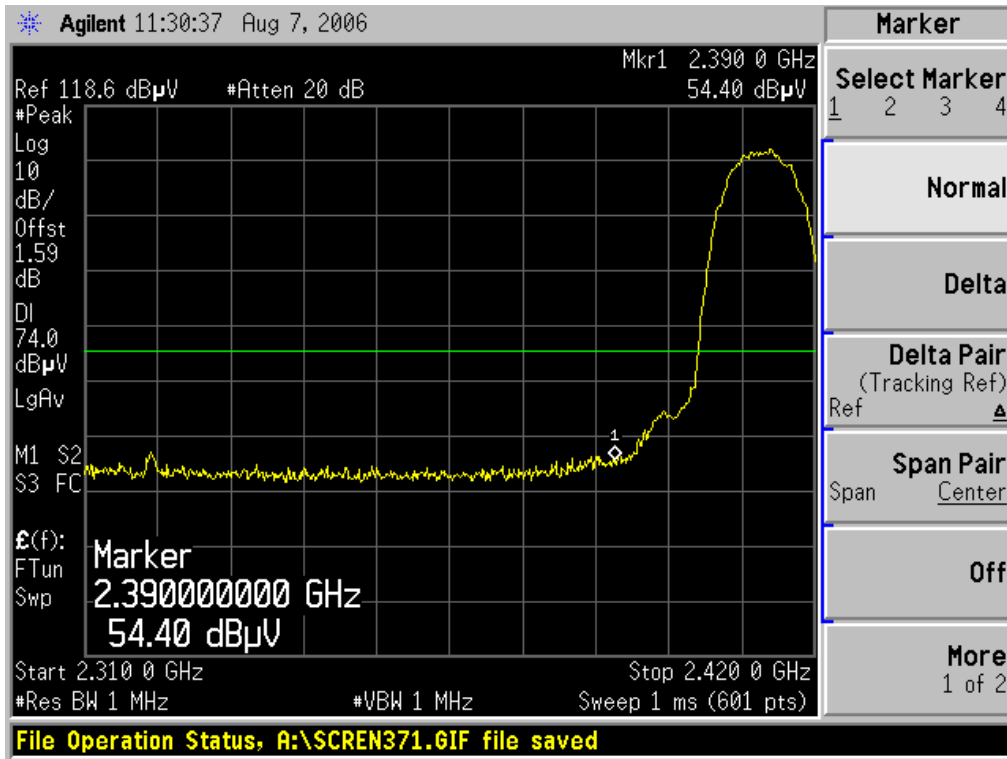

Detector mode: Average

Polarity: Vertical

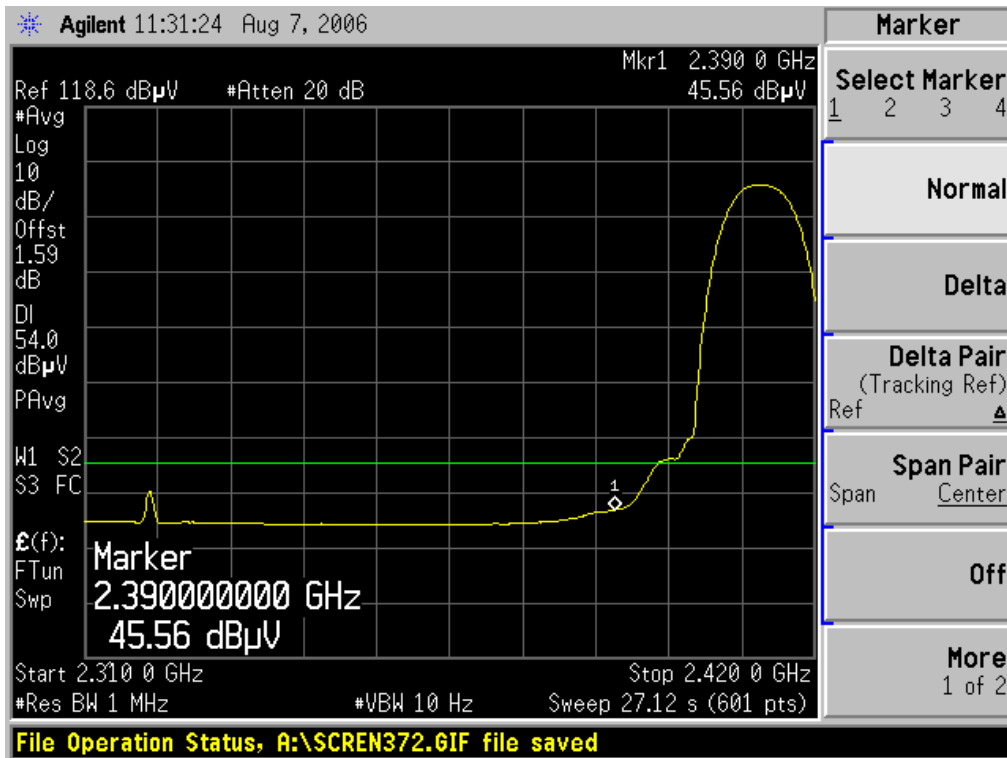



Detector mode: Peak

Polarity: Horizontal

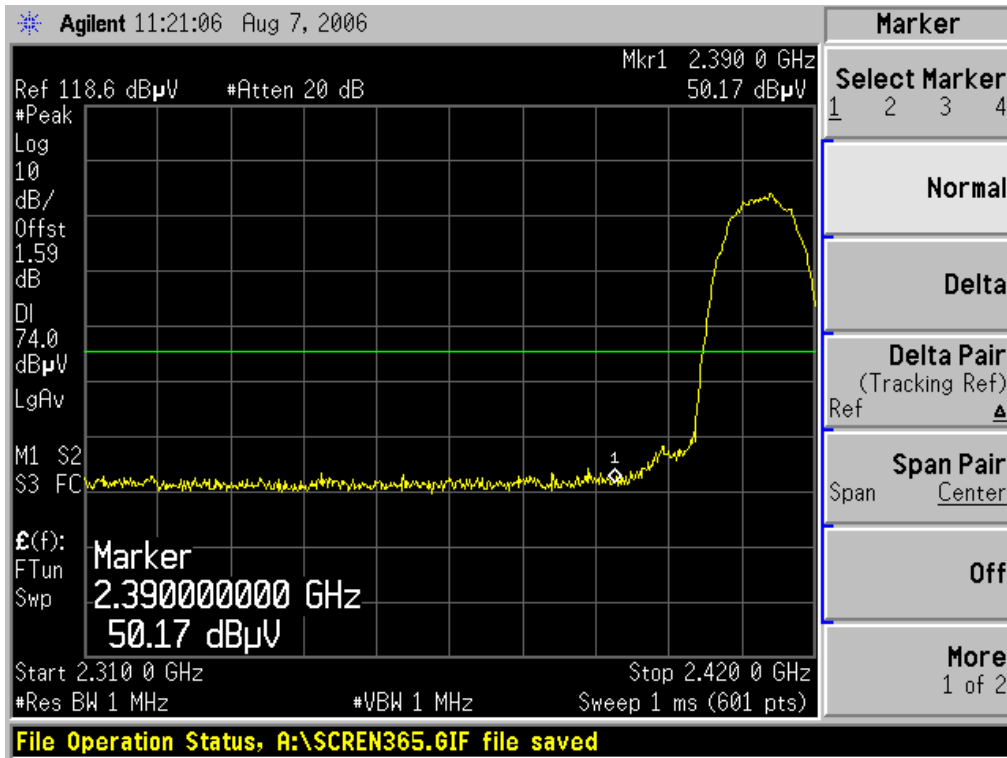

Detector mode: Average

Polarity: Horizontal

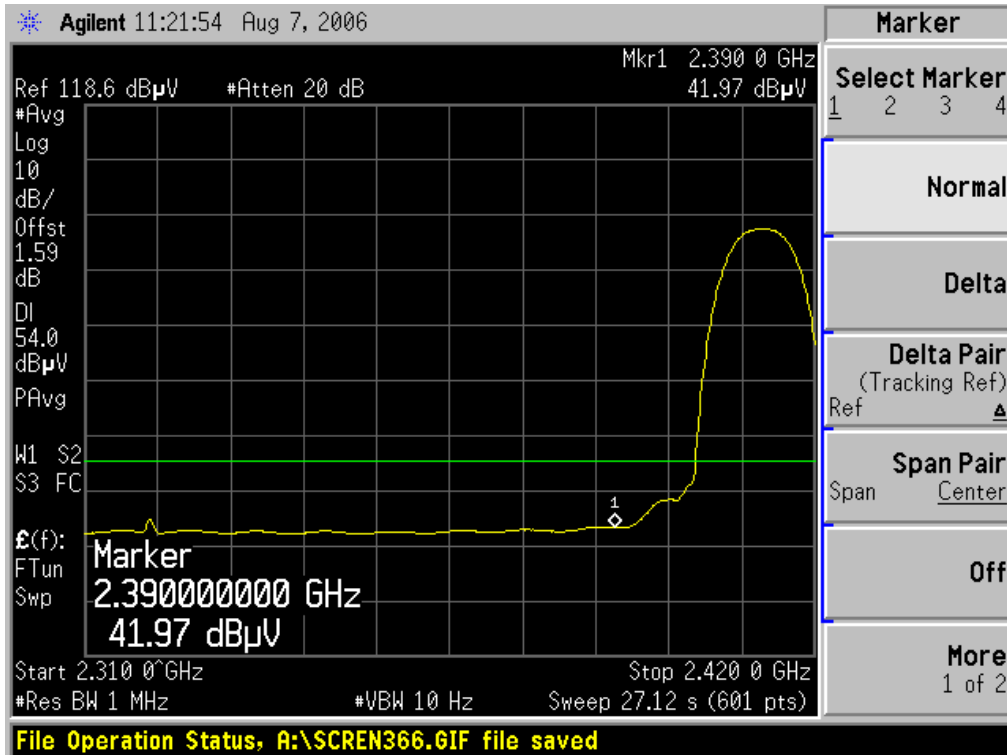



Band Edges (802.11b / CH High)

Detector mode: Peak

Polarity: Vertical

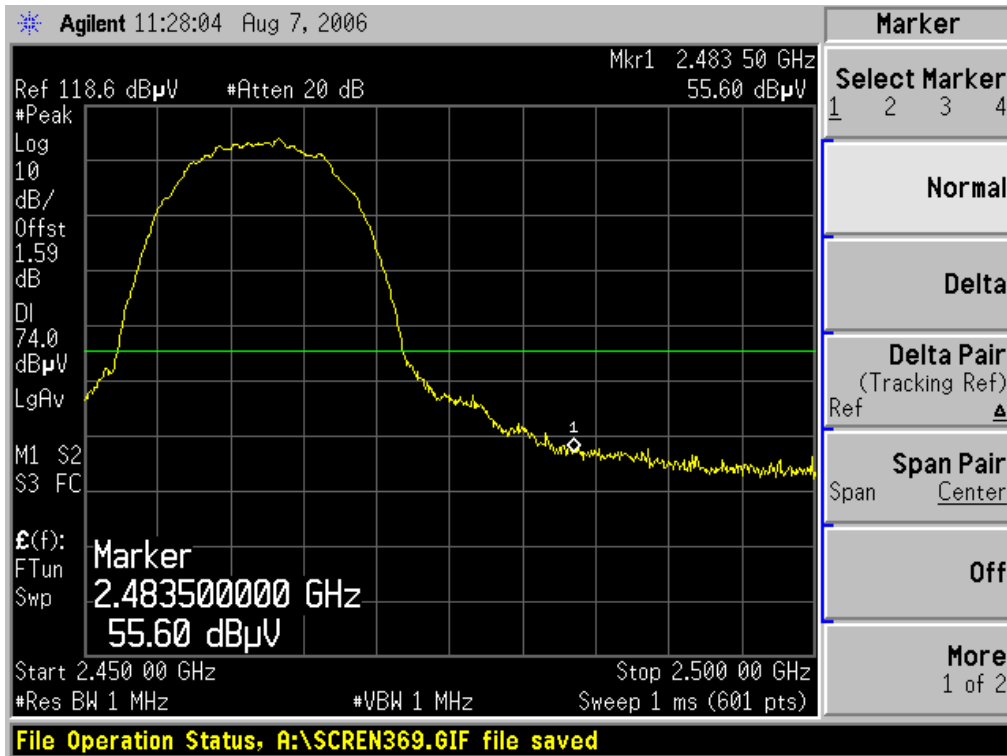

Detector mode: Average

Polarity: Vertical

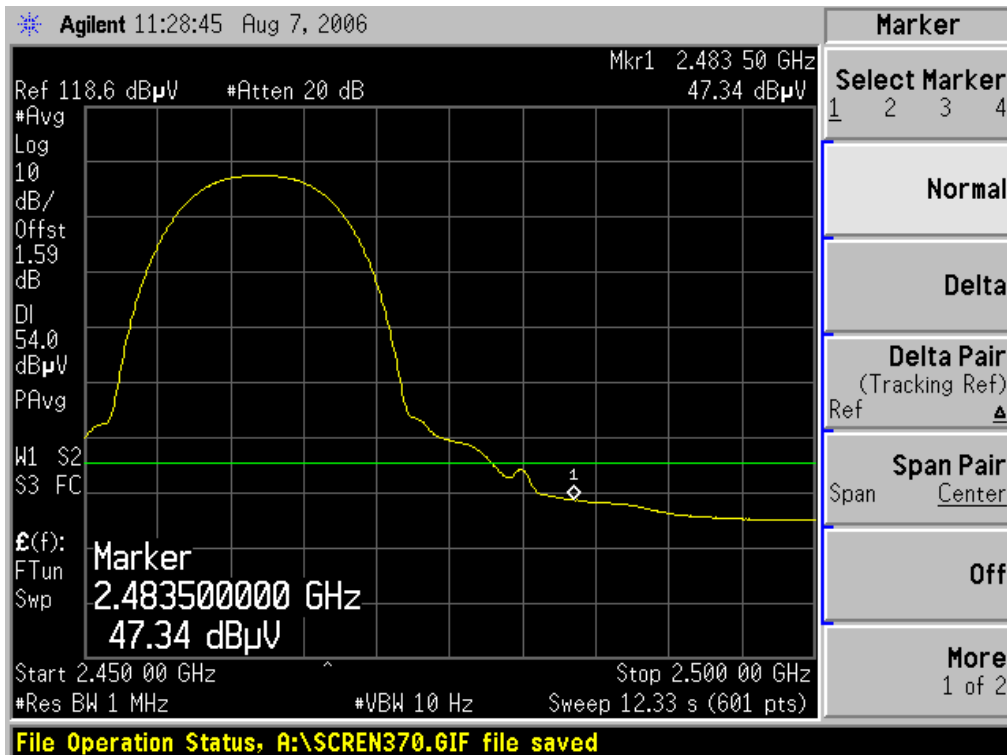



Detector mode: Peak

Polarity: Horizontal

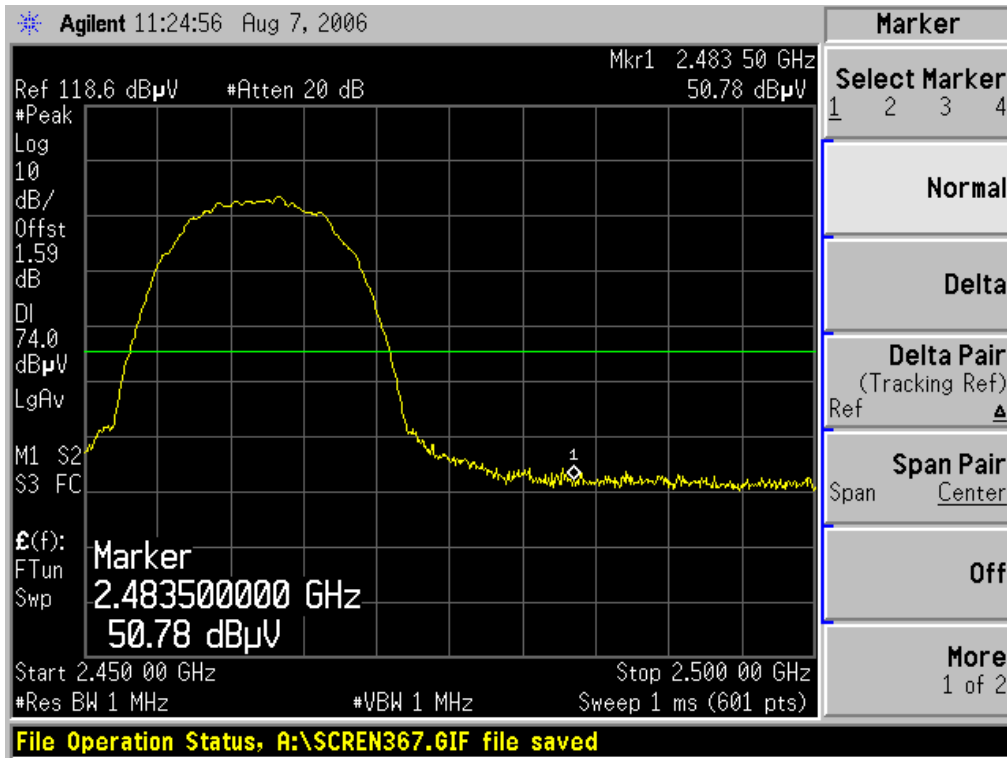

Detector mode: Average

Polarity: Horizontal

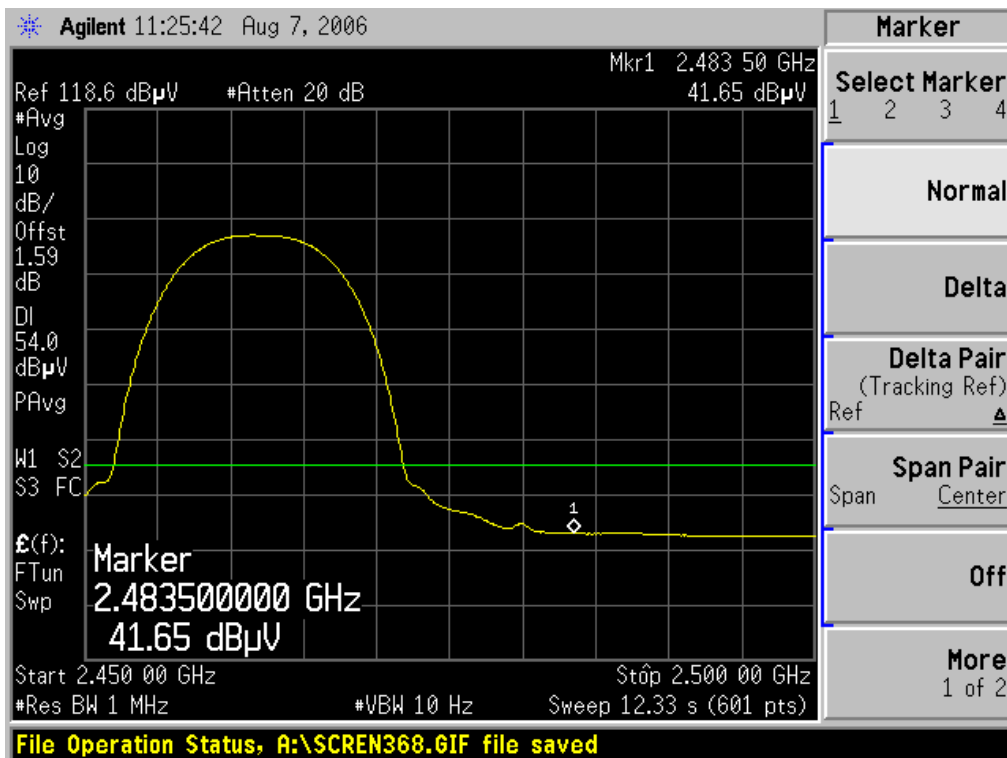



Band Edges (802.11g / CH Low)

Detector mode: Peak

Polarity: Vertical

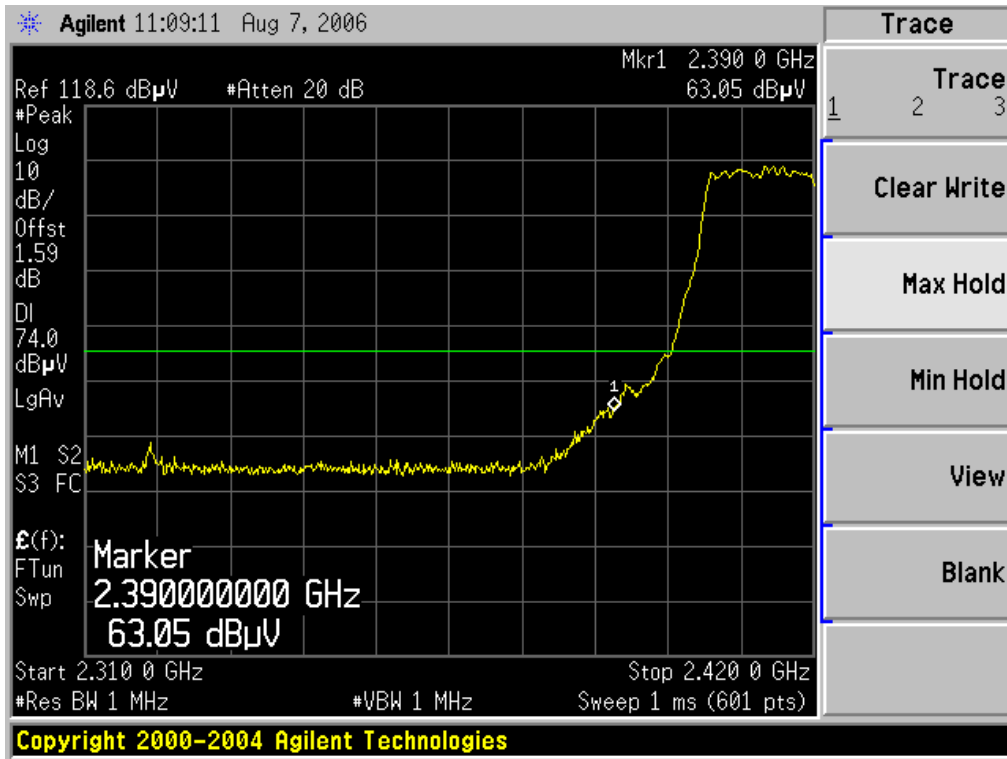

Detector mode: Average

Polarity: Vertical

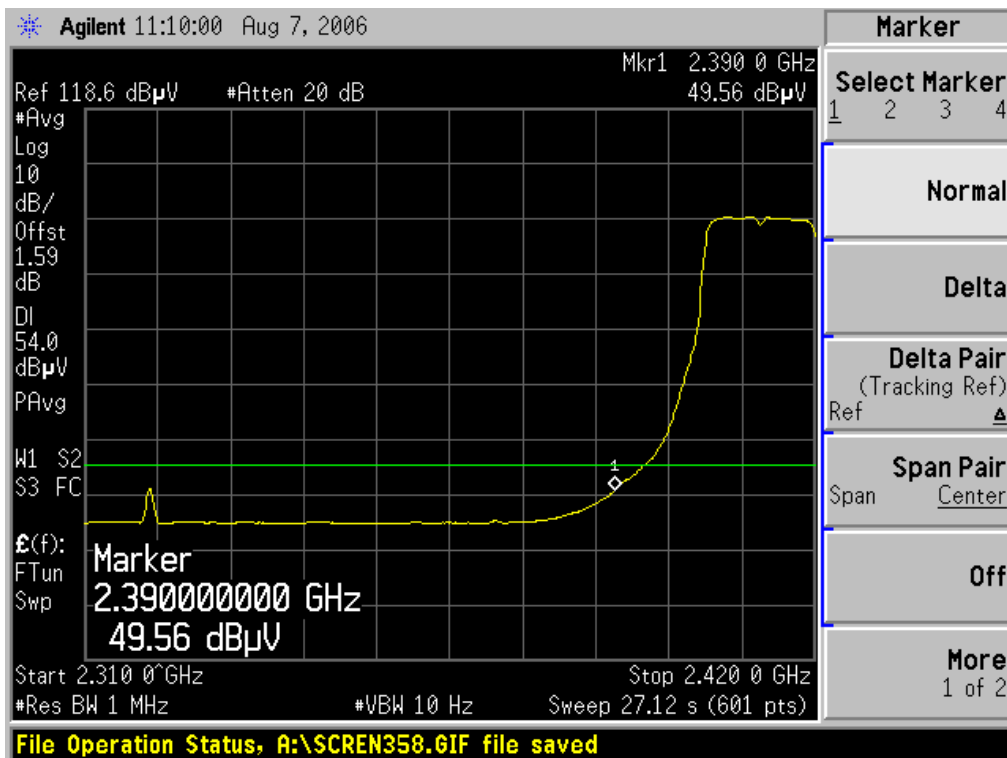



Detector mode: Peak

Polarity: Horizontal

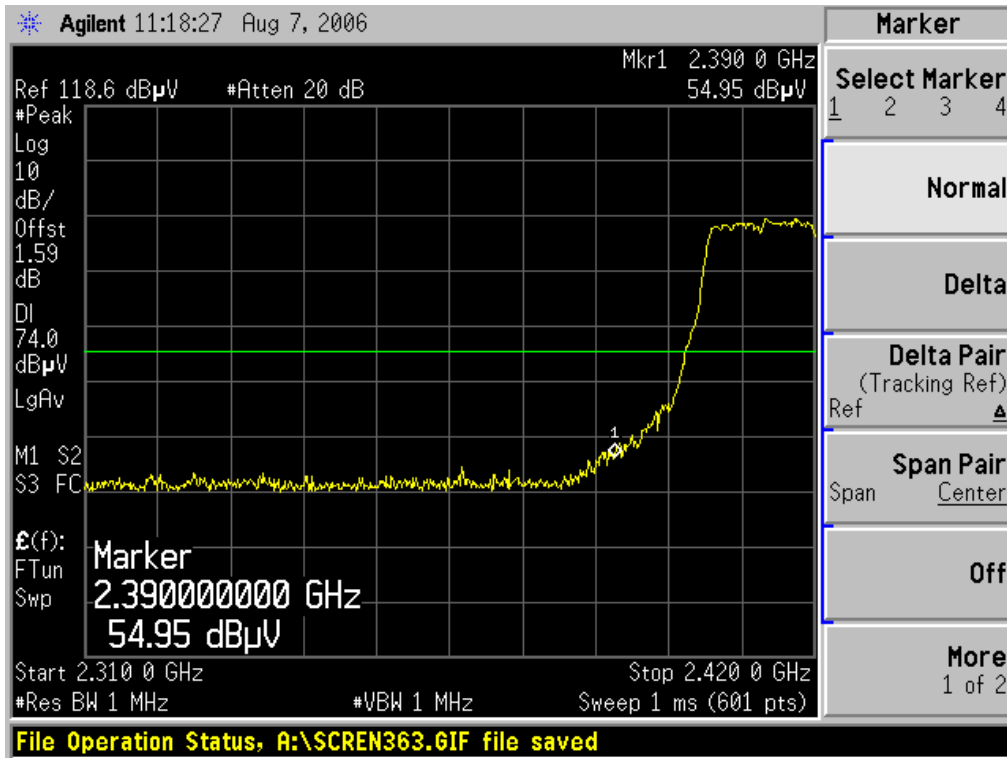

Detector mode: Average

Polarity: Horizontal

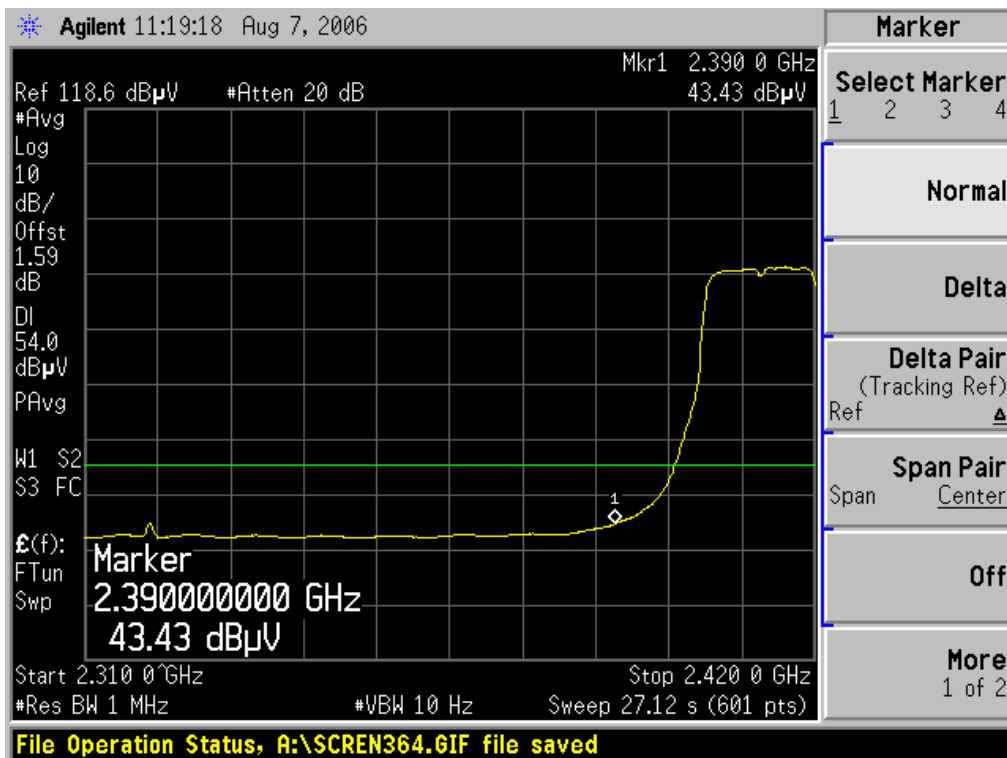



Band Edges (802.11g / CH High)

Detector mode: Peak

Polarity: Vertical

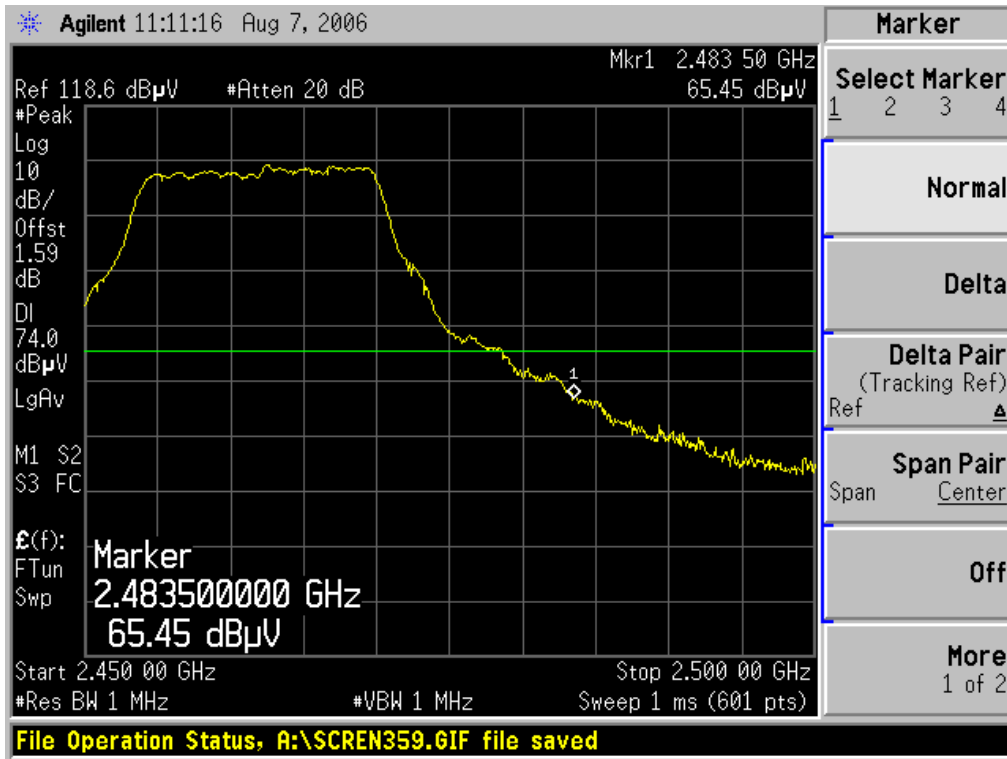

Detector mode: Average

Polarity: Vertical

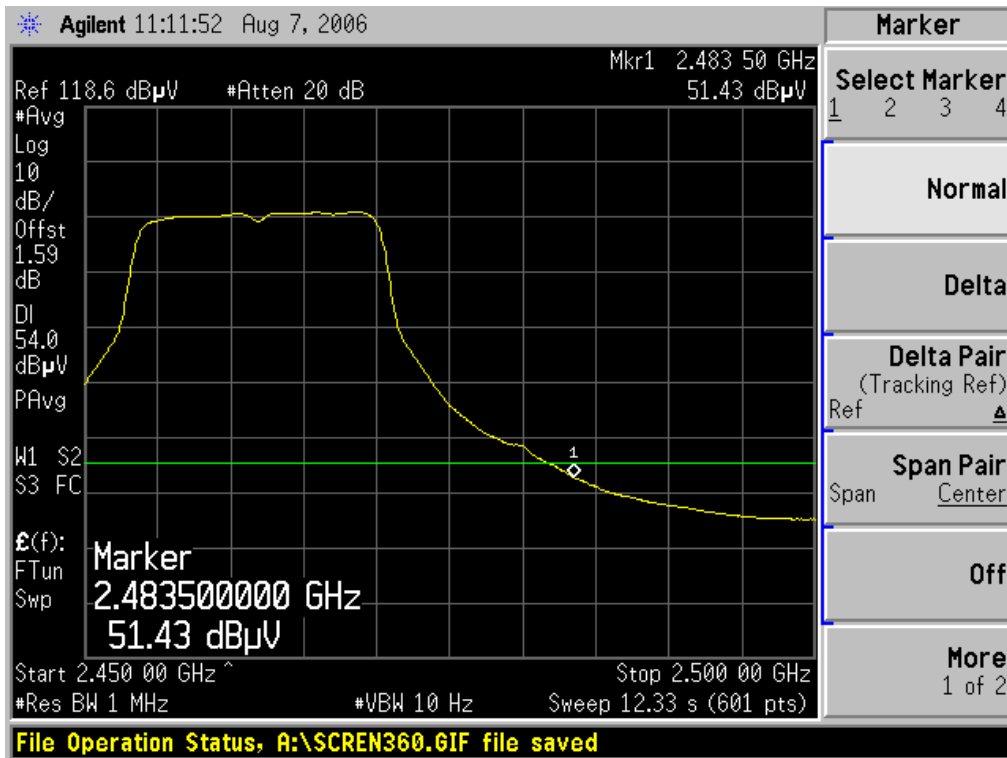



Detector mode: Peak

Polarity: Horizontal

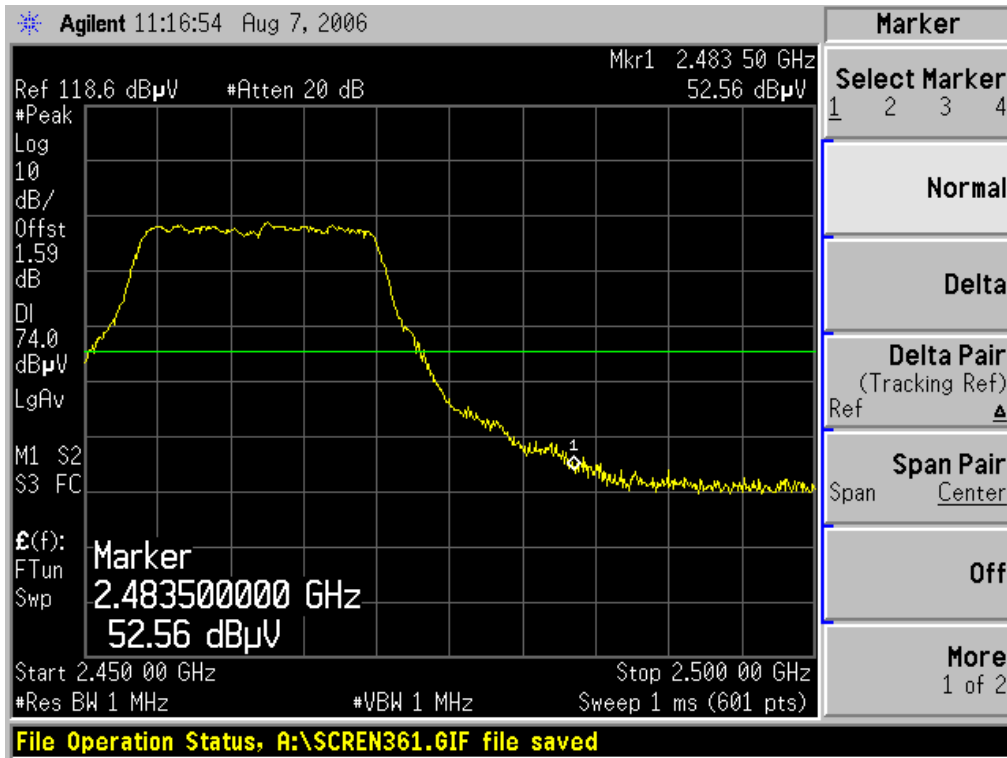

Detector mode: Average

Polarity: Horizontal

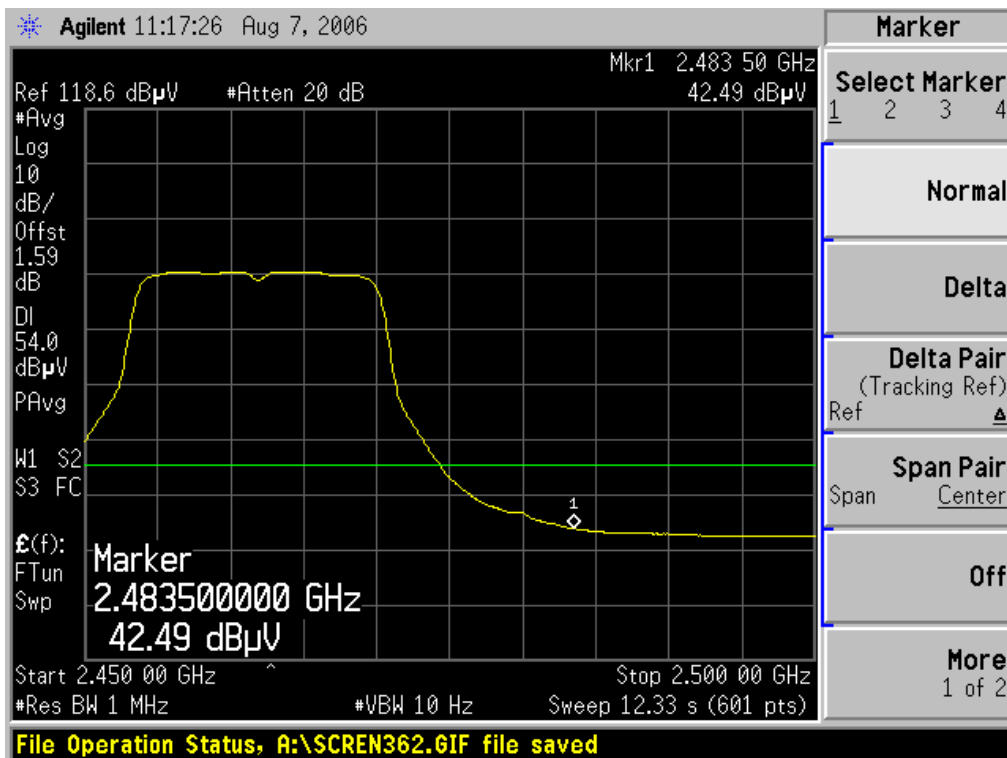

PEAK POWER SPECTRAL DENSITY

LIMIT

1. For direct sequence systems, the peak power spectral density conducted from the intentional radiator to the antenna shall not be greater than 8dBm in any 3kHz band during any time interval of continuous transmission.
2. The direct sequence operating of the hybrid system, with the frequency hopping operation turned off, shall comply with the power density requirements of paragraph (d) of this section.

MEASUREMENT EQUIPMENT USED

Name of Equipment	Manufacturer	Model	Serial Number	Calibration Due
PSA Spectrum Analyzer	Agilent	E4446A	US44300399	02/08/2007

Remark: Each piece of equipment is scheduled for calibration once a year.

Test Configuration

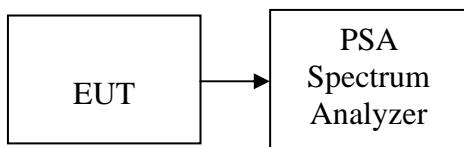

TEST PROCEDURE

1. Place the EUT on the table and set it in transmitting mode.
Remove the antenna from the EUT and then connect a low loss RF cable from the antenna port to the spectrum analyzer.
2. Set the spectrum analyzer as RBW = 3kHz, VBW = 10kHz, Span = 300kHz, Sweep=100s
3. Record the max. reading.
4. Repeat the above procedure until the measurements for all frequencies are completed.



TEST RESULTS

No non-compliance noted

Test Data

Test mode: IEEE 802.11b

Channel	Frequency	Reading (dBm)	Factor (dB)	PPSD (dBm)	Limit (dBm)	Result
Low	2412	-9.91	2.50	-7.41	8.00	PASS
Mid	2437	-10.78	2.50	-8.28		PASS
High	2462	-10.09	2.50	-7.59		PASS

Test mode: IEEE 802.11g

Channel	Frequency	Reading (dBm)	Factor (dB)	PPSD (dBm)	Limit (dBm)	Result
Low	2412	-24.48	2.50	-21.98	8.00	PASS
Mid	2437	-24.81	2.50	-22.31		PASS
High	2462	-24.60	2.50	-22.10		PASS



Test Plot

802.11b mode

PPSD (CH Low)

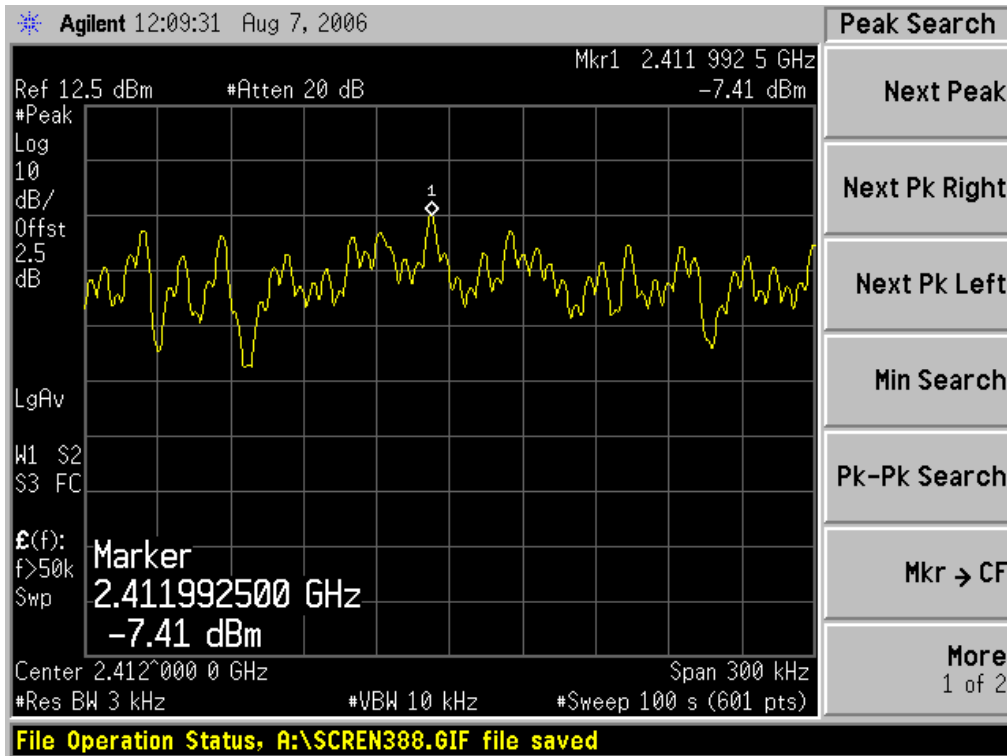

PPSD (CH Mid)

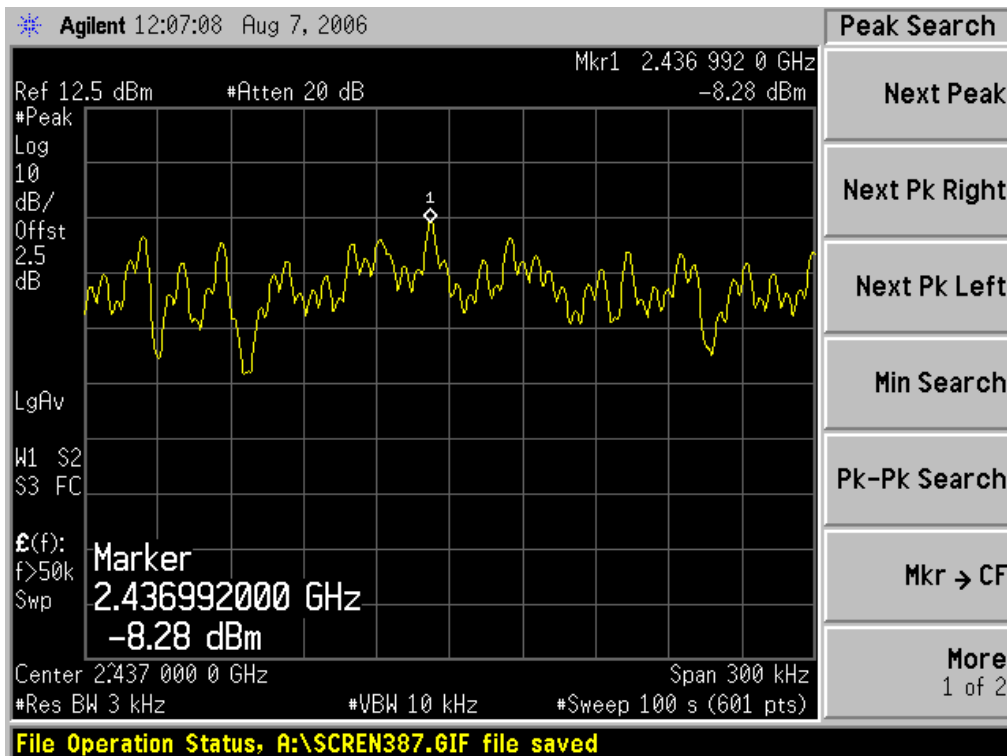



PPSD (CH High)

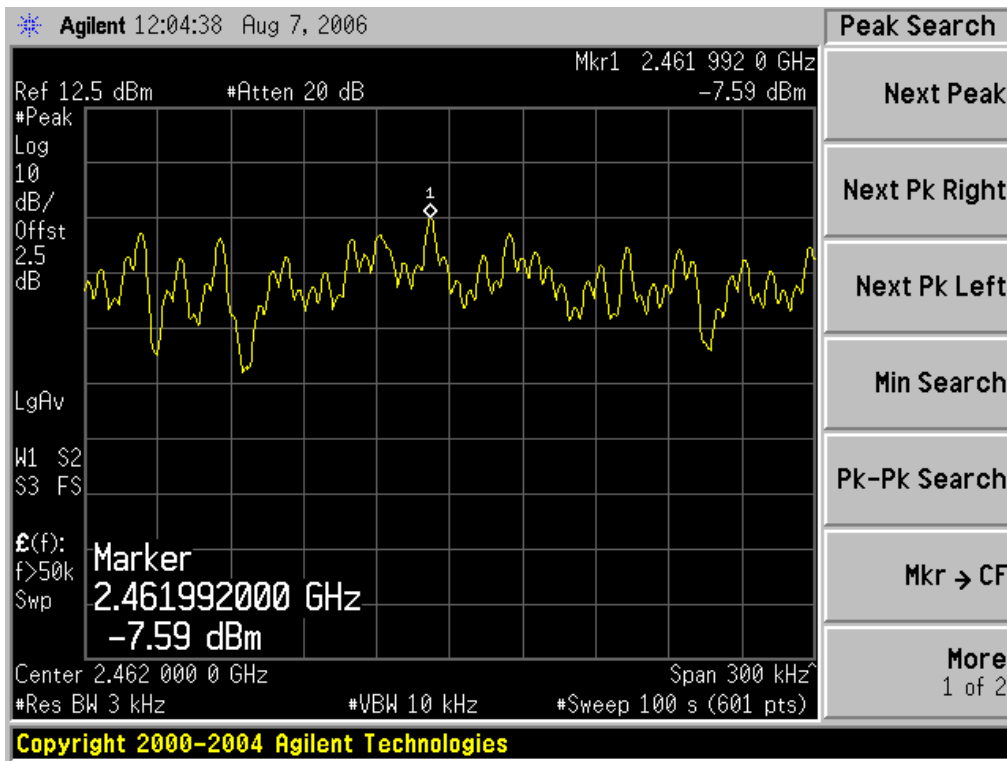



802.11g mode

PPSD (CH Low)

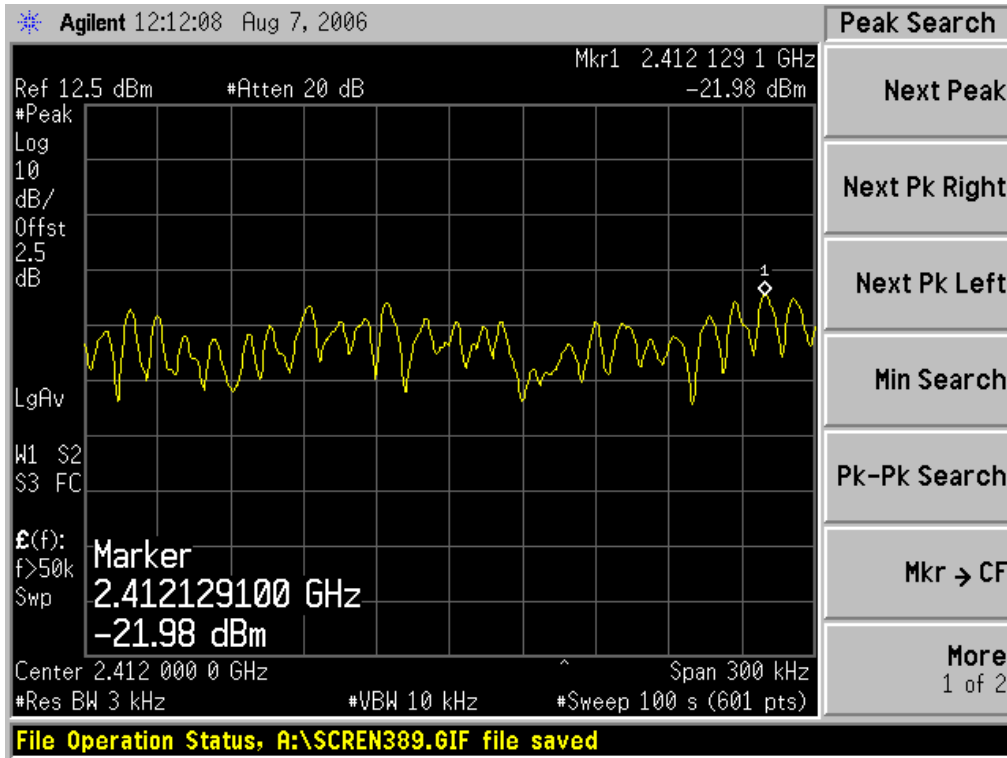

PPSD (CH Mid)

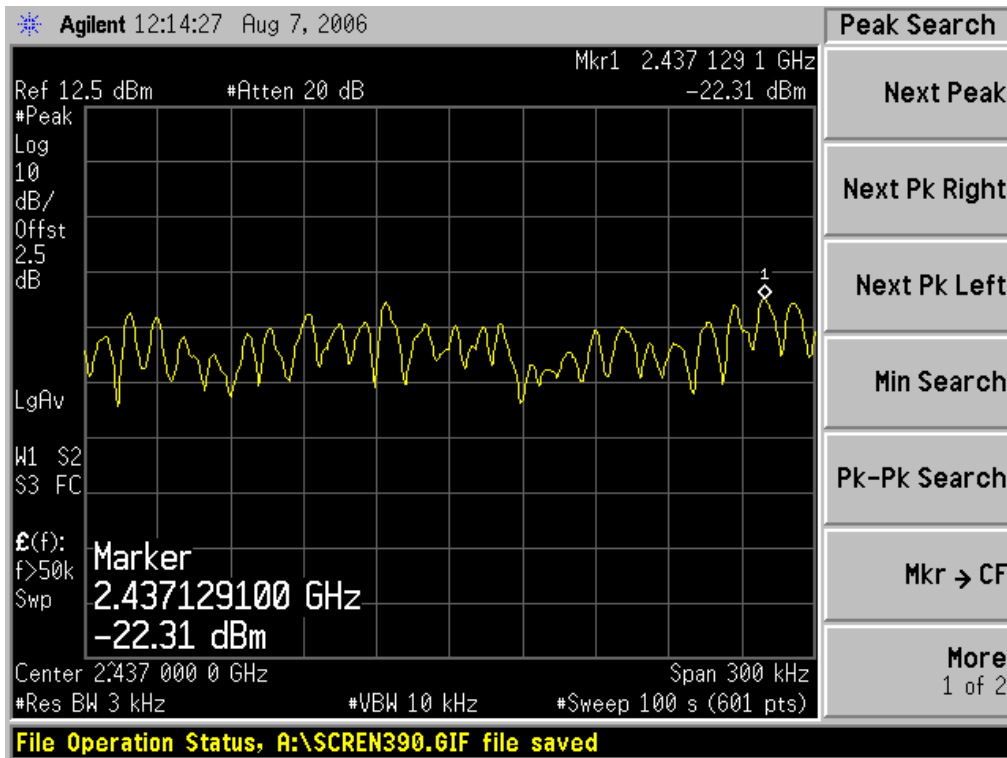



PPSD (CH High)

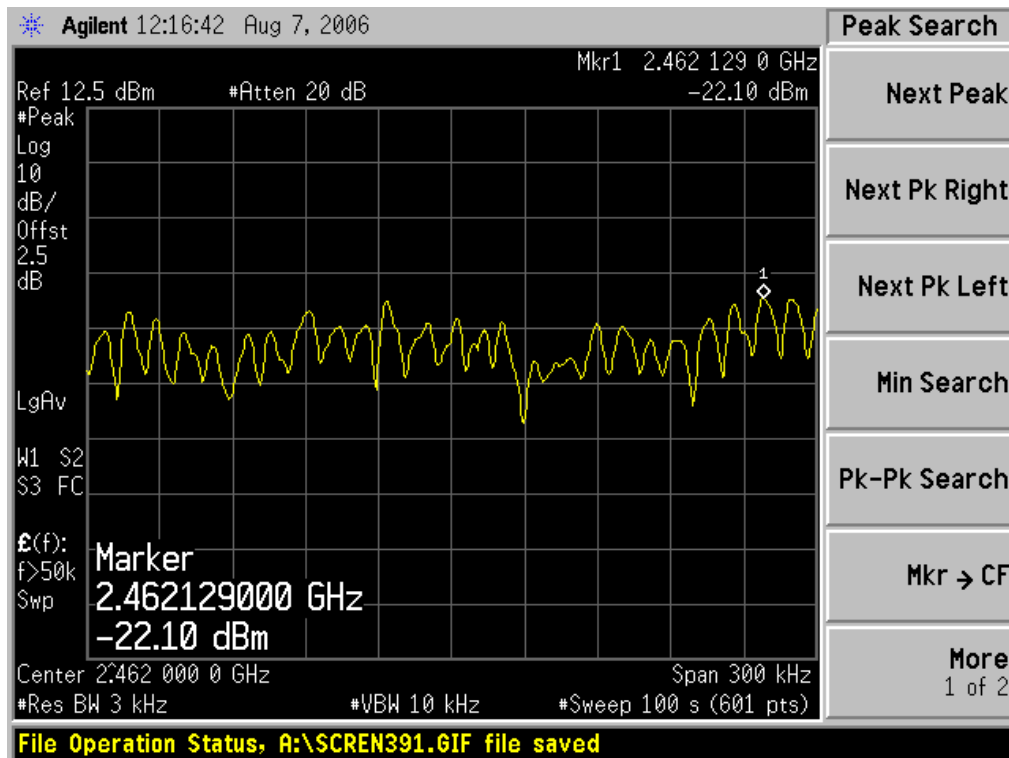

SPURIOUS EMISSIONS

7.5.1 Conducted Measurement

LIMIT

In any 100 kHz bandwidth outside the frequency band in which the spread spectrum or digitally modulated intentional radiator is operating, the radio frequency power that is produced by the intentional radiator shall be at least 20 dB below that in the 100 kHz bandwidth within the band that contains the highest level of the desired power, based on either an RF conducted or a radiated measurement. Attenuation below the general limits specified in Section 15.209(a) is not required. In addition, radiated emissions which fall in the restricted bands, as defined in Section 15.205(a), must also comply with the radiated emission limits specified in Section 15.209(a) (see Section 15.205(c)).

MEASUREMENT EQUIPMENT USED

Name of Equipment	Manufacturer	Model	Serial Number	Calibration Due
PSA Spectrum Analyzer	Agilent	E4446A	US44300399	02/08/2007

Remark: Each piece of equipment is scheduled for calibration once a year.

Test Configuration

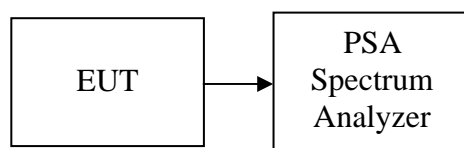

TEST PROCEDURE

Conducted RF measurements of the transmitter output were made to confirm that the EUT antenna port conducted emissions meet the specified limit and to identify any spurious signals that require further investigation or measurements on the radiated emissions site.

The transmitter output is connected to the spectrum analyzer. The resolution bandwidth is set to 100 KHz. The video bandwidth is set to 100 KHz.

Measurements are made over the 30MHz to 26GHz range with the transmitter set to the lowest, middle, and highest channels.

TEST RESULTS

No non-compliance noted



Test Plot

IEEE 802.11b / CH Low

30MHz ~ 2.9GHz

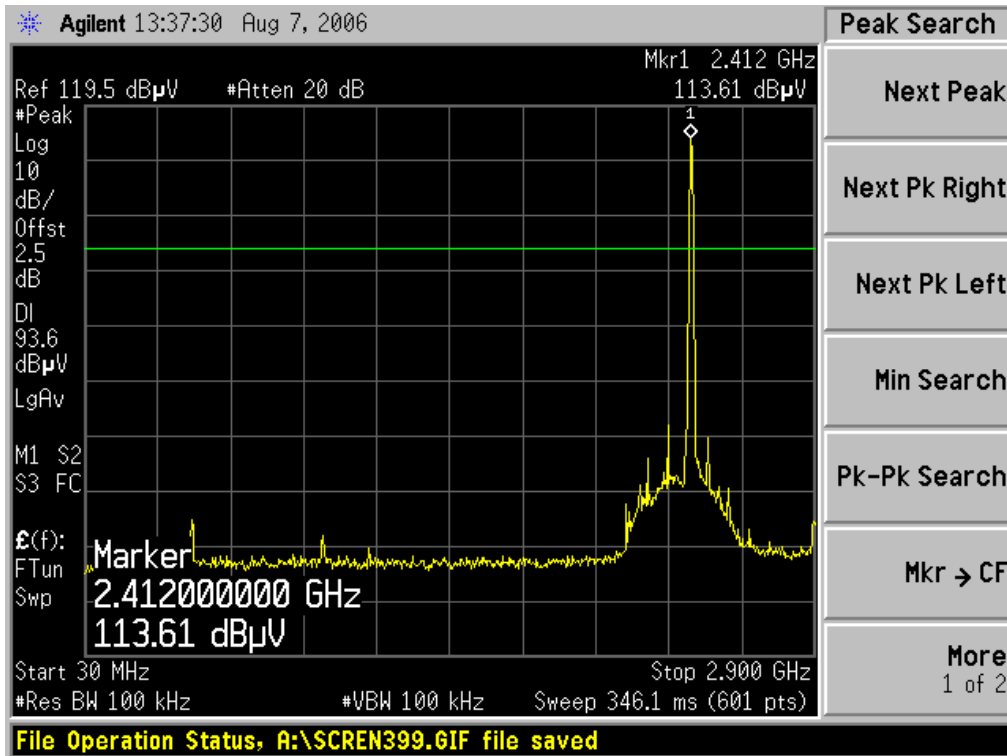

2.9GHz ~ 26.5GHz

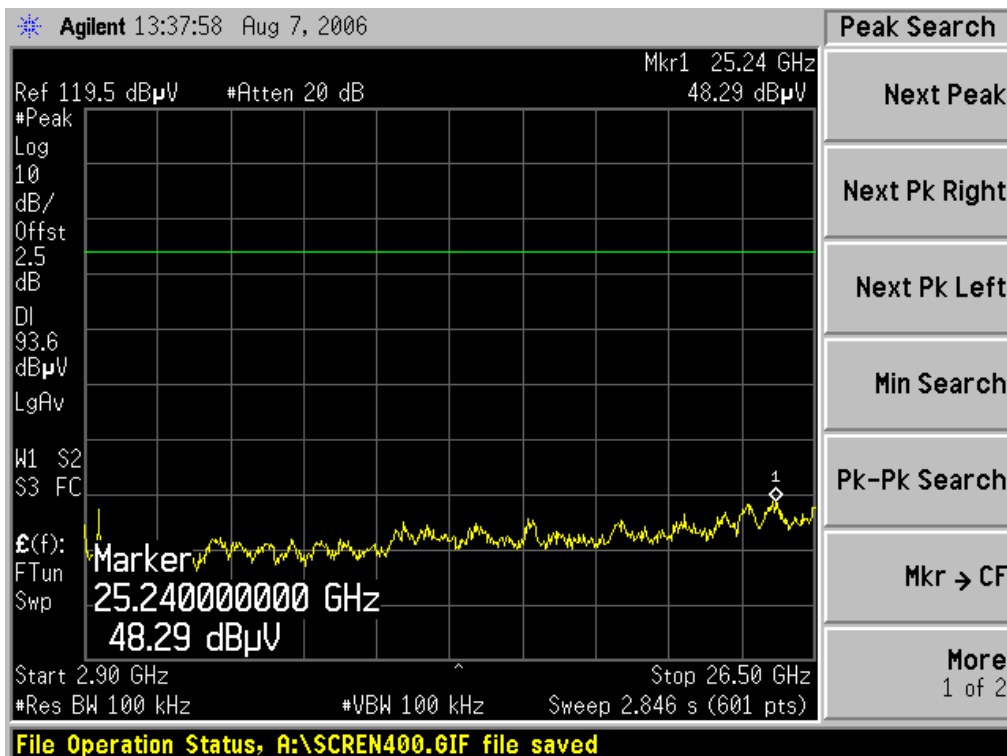



IEEE 802.11b / CH Mid

30MHz ~ 2.9GHz

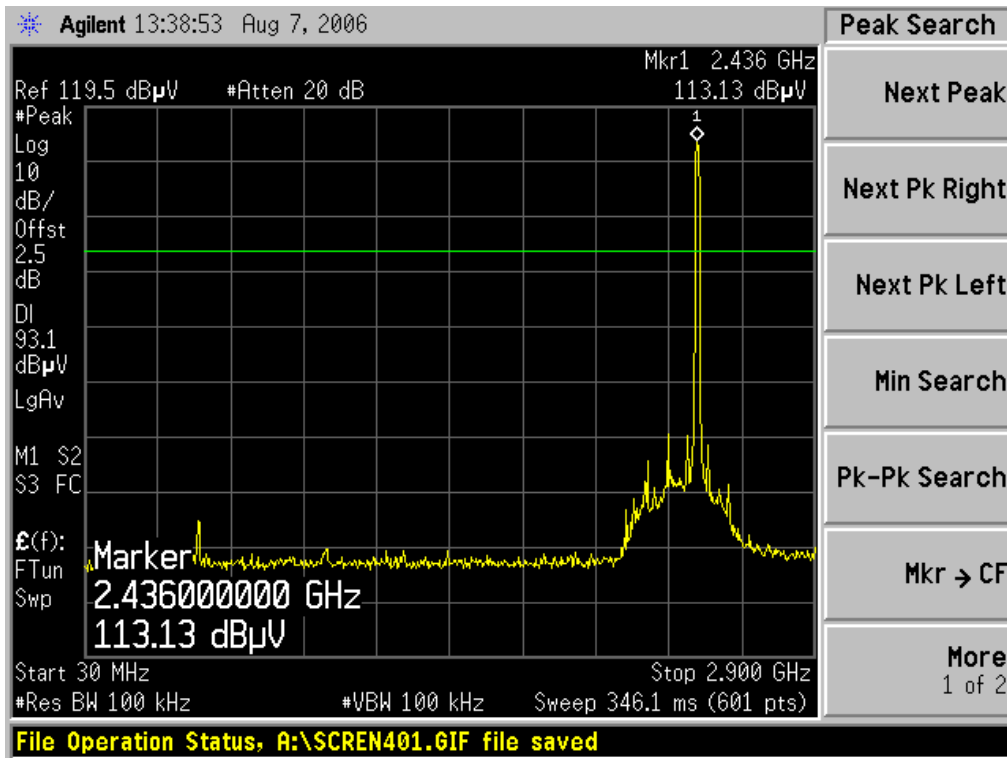

2.9GHz ~ 26.5GHz

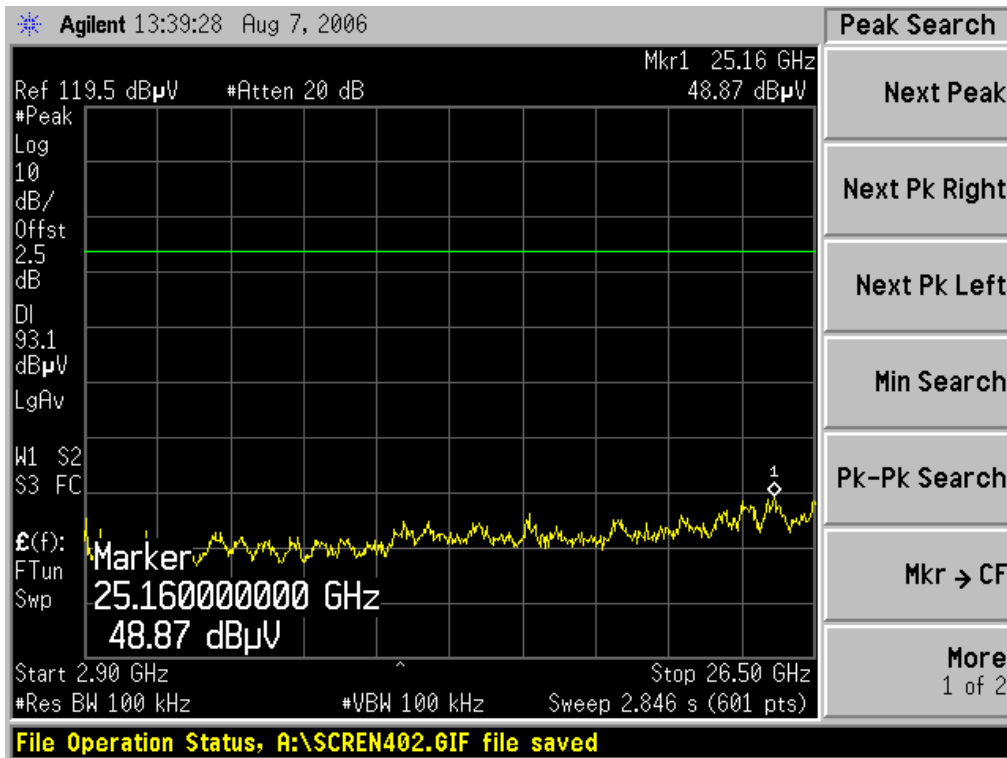



IEEE 802.11b / CH High

30MHz ~ 2.9GHz

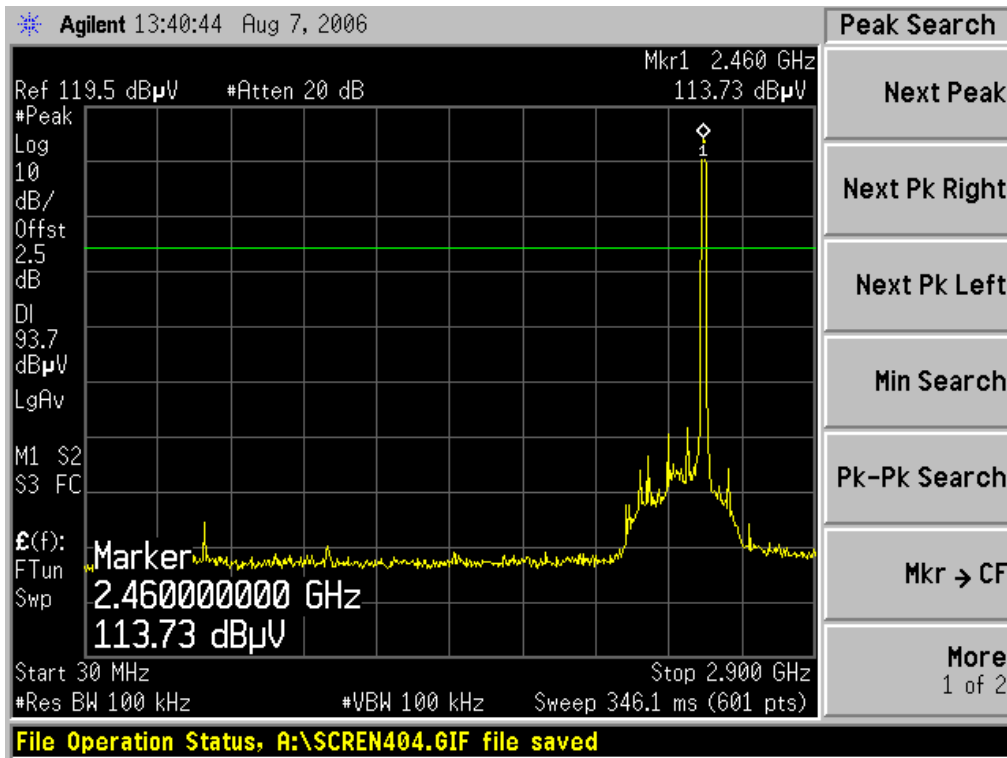

2.9GHz ~ 26.5GHz

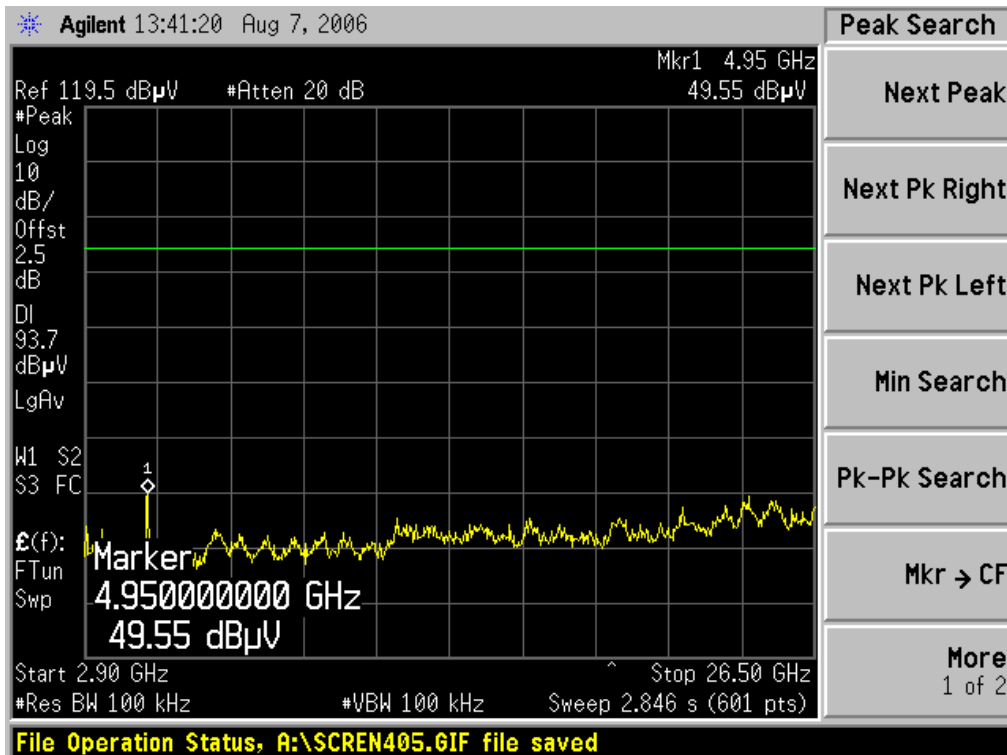



IEEE 802.11g / CH Low

30MHz ~ 2.9GHz

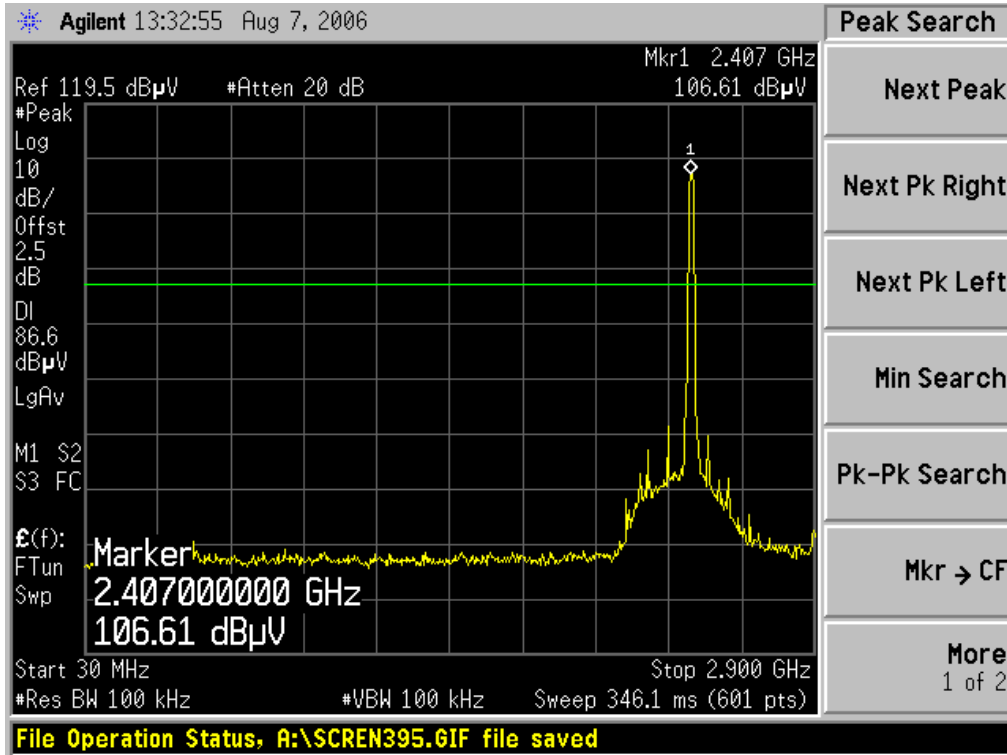

2.9GHz ~ 26.5GHz

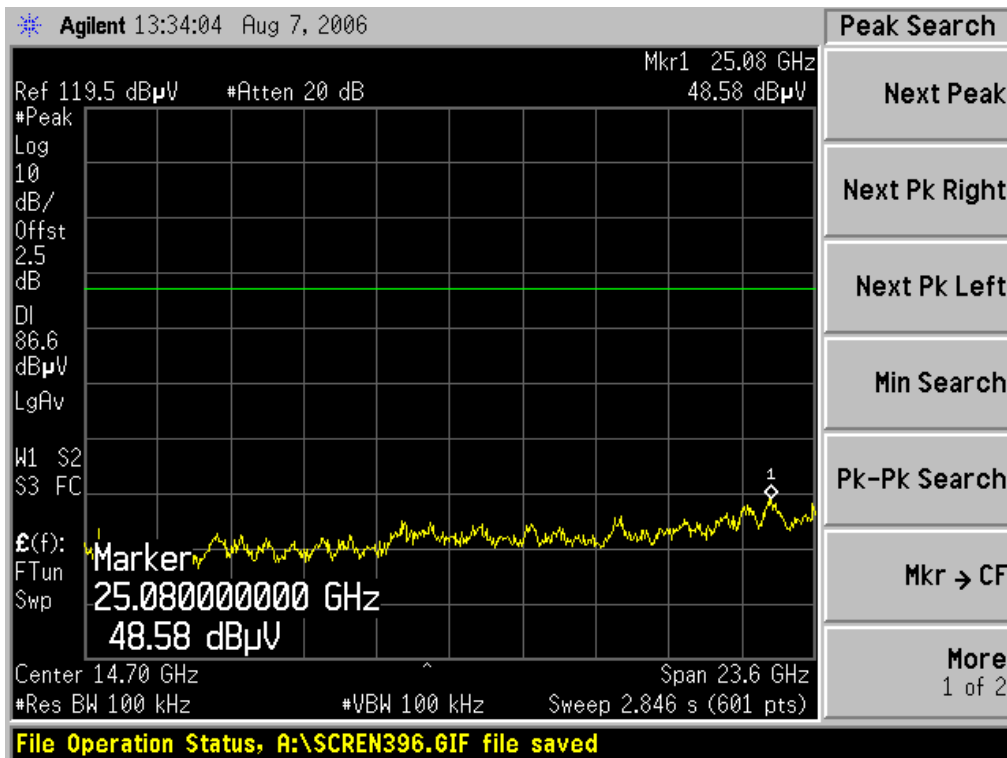



IEEE 802.11g / CH Mid

30MHz ~ 2.9GHz

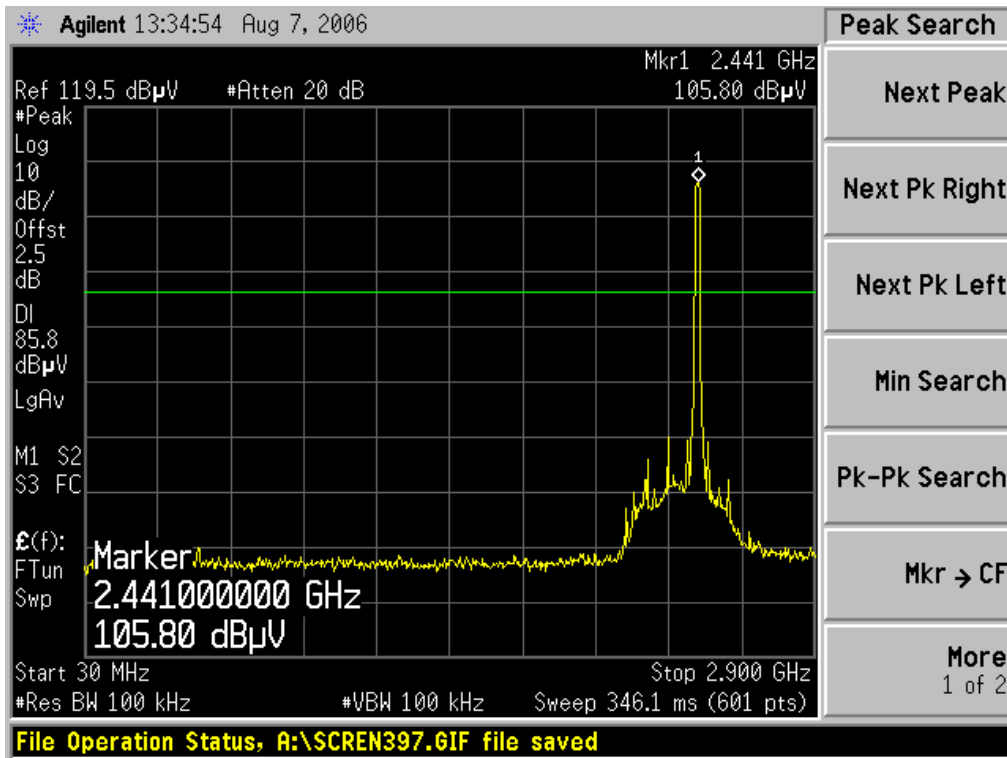

2.9GHz ~ 26.5GHz

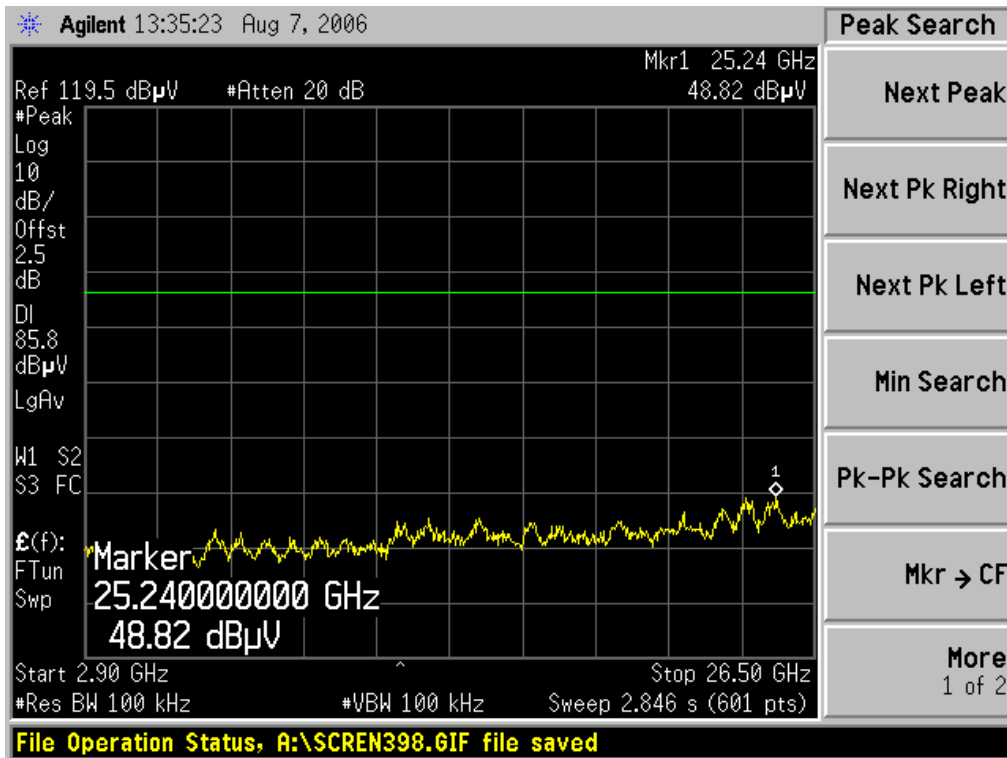



IEEE 802.11g / CH High

30MHz ~ 2.9GHz

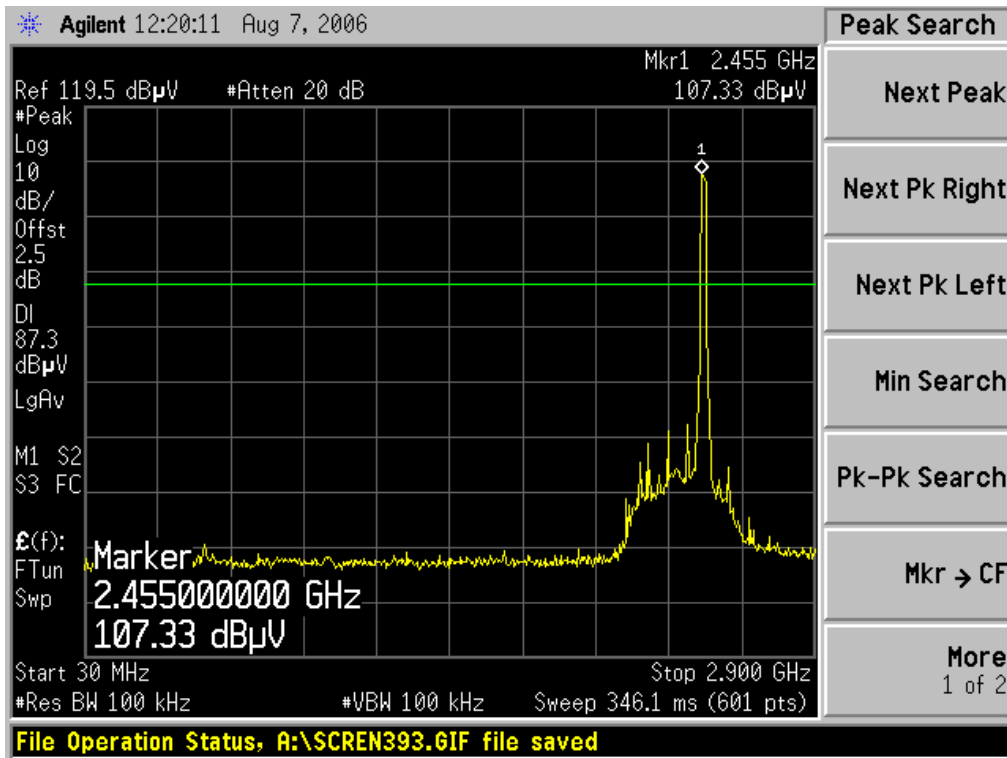

2.9GHz ~ 26.5GHz

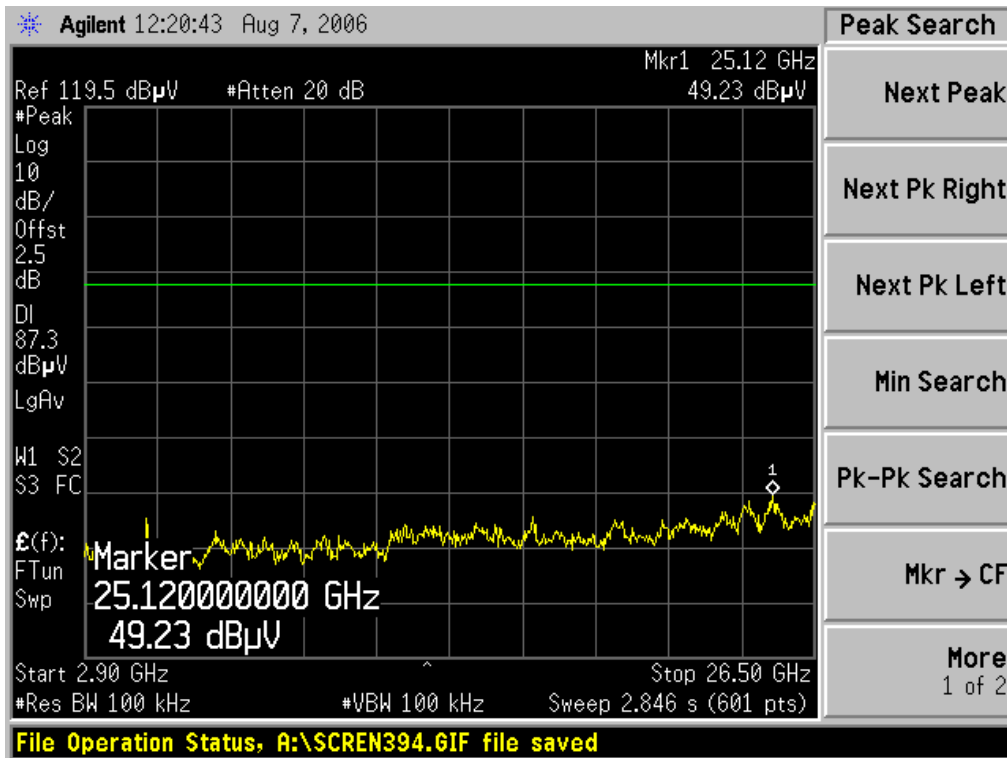



7.6.2 Radiated Emissions

LIMIT

1. Except as provided elsewhere in this Subpart, the emissions from an intentional radiator shall not exceed the field strength levels specified in the following table:

Frequency (MHz)	Field Strength (mV/m)	Measurement Distance (m)
30-88	100*	3
88-216	150*	3
216-960	200*	3
Above 960	500	3

Note: Except as provided in paragraph (g), fundamental emissions from intentional radiators operating under this Section shall not be located in the frequency bands 54-72 MHz, 76-88 MHz, 174-216 MHz or 470-806 MHz. However, operation within these frequency bands is permitted under other sections of this Part, e.g., Sections 15.231 and 15.241.

2. In the above emission table, the tighter limit applies at the band edges.

Frequency (Hz)	Field Strength (μ V/m at 3-meter)	Field Strength (dB μ V/m at 3-meter)
30-88	100	40
88-216	150	43.5
216-960	200	46
Above 960	500	54

MEASUREMENT EQUIPMENT USED

966 RF CHAMBER 2				
Name of Equipment	Manufacturer	Model	Serial Number	Calibration Due
PSA Spectrum Analyzer	Agilent	E4446A	US44300399	02/08/2007
EMI Test Receiver	R&S	ESCI	1166.5950 03	01/13/2007
Pre-Amplifier	MITEQ	N/A	AFS42-00102650-42-10P-42	02/14/2007
Bi-log Antenna	SCHWAZBECK	CBL6143	5082	06/09/2007
Turn Table	EMCO	2081-1.21	N/A	N.C.R
Antenna Tower	CT	N/A	N/A	N.C.R
Controller	CT	N/A	N/A	N.C.R
RF Comm. Test set	HP	8920B	US36142090	N.C.R
Site NSA	C&C	N/A	N/A	06/09/2007
Horn Antenna	TRC	N/A	N/A	03/04/2007

Remark: Each piece of equipment is scheduled for calibration once a year.

Test Configuration

Below 1 GHz

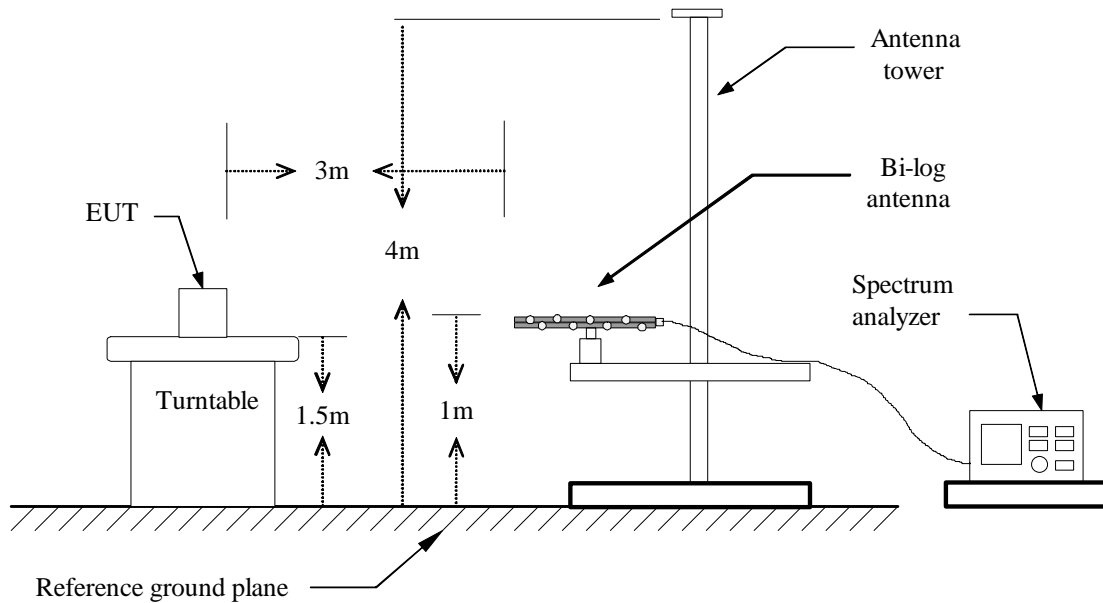

Above 1 GHz

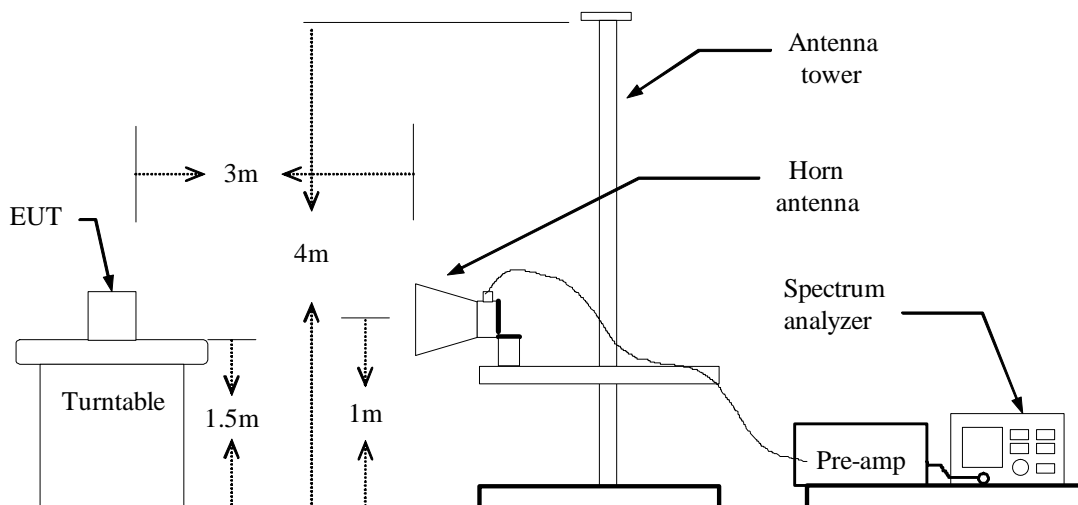

TEST PROCEDURE

1. The EUT is placed on a turntable, which is 0.8m above ground plane.
2. The turntable shall be rotated for 360 degrees to determine the position of maximum emission level.
3. EUT is set 3m away from the receiving antenna, which is varied from 1m to 4m to find out the highest emissions.
4. Maximum procedure was performed on the six highest emissions to ensure EUT compliance.
5. And also, each emission was to be maximized by changing the polarization of receiving antenna both horizontal and vertical.
6. Repeat above procedures until the measurements for all frequencies are complete.

**TEST RESULTS****Below 1 GHz****Operation Mode:** TX / IEEE 802.11b / CH Low**Test Date:** August 01, 2006**Temperature:** 20°C**Tested by:** Henry**Humidity:** 70 % RH**Polarity:** Ver. / Hor.

Freq. (MHz)	Ant.Pol. H/V	Detector Mode (PK/QP)	Reading (dBuV)	Factor (dB)	Actual FS (dBuV/m)	Limit 3m (dBuV/m)	Safe Margin (dB)
66.000	V	Peak	35.79	-0.63	35.16	40.00	-4.84
79.050	V	Peak	38.87	-7.29	31.58	40.00	-8.42
84.450	V	Peak	39.05	-7.16	31.89	40.00	-8.11
156.450	V	Peak	35.28	-7.79	27.49	43.50	-16.01
319.833	V	Peak	40.23	-11.93	28.30	46.00	-17.70
800.500	V	Peak	43.16	-3.25	39.91	46.00	-6.09
88.050	H	Peak	46.22	-10.15	36.07	43.50	-7.43
132.600	H	Peak	43.03	-7.25	35.78	43.50	-7.72
250.500	H	Peak	31.30	-6.21	25.09	46.00	-20.91
319.833	H	Peak	46.13	-7.72	38.41	46.00	-7.59
458.666	H	Peak	31.85	3.13	34.98	46.00	-11.02
800.500	H	Peak	44.07	-4.14	39.93	46.00	-6.07

Notes:

1. Measuring frequencies from 30 MHz to the 1GHz.
2. Radiated emissions measured in frequency range from 30 MHz to 1000MHz were made with an instrument using Peak/Quasi-peak detector mode.
3. Data of measurement within this frequency range shown " --- " in the table above means the reading of emissions are attenuated more than 20dB below the permissible limits or the field strength is too small to be measured.
4. The IF bandwidth of SPA between 30MHz to 1GHz was 100kHz.



Operation Mode: TX / IEEE 802.11b / CH Mid

Test Date: August 01, 2006

Temperature: 20°C

Tested by: Henry

Humidity: 70 % RH

Polarity: Ver. / Hor.

Freq. (MHz)	Ant.Pol. H/V	Detector Mode (PK/QP)	Reading (dBUV)	Factor (dB)	Actual FS (dBUV/m)	Limit 3m (dBUV/m)	Safe Margin (dB)
80.400	V	Peak	44.28	-7.12	37.16	40.00	-2.84
92.550	V	Peak	44.52	-9.80	34.72	43.50	-8.78
133.950	V	Peak	38.12	-6.90	31.22	43.50	-12.28
319.833	V	Peak	40.43	-11.93	28.50	46.00	-17.50
694.333	V	Peak	32.17	1.61	33.78	46.00	-12.22
800.500	V	Peak	43.74	-3.25	40.49	46.00	-5.51
85.350	H	Peak	41.18	-8.10	33.08	40.00	-6.92
88.950	H	Peak	46.48	-10.84	35.64	43.50	-7.86
134.850	H	Peak	43.89	-6.49	37.40	43.50	-6.10
143.400	H	Peak	42.06	-9.06	33.00	43.50	-10.50
319.833	H	Peak	46.30	-7.72	38.58	46.00	-7.42
800.500	H	Peak	44.48	-4.14	40.34	46.00	-5.66

Notes:

1. Measuring frequencies from 30 MHz to the 1GHz.
2. Radiated emissions measured in frequency range from 30 MHz to 1000MHz were made with an instrument using Peak/Quasi-peak detector mode.
3. Data of measurement within this frequency range shown " --- " in the table above means the reading of emissions are attenuated more than 20dB below the permissible limits or the field strength is too small to be measured.
4. The IF bandwidth of SPA between 30MHz to 1GHz was 100kHz.

**Operation Mode:** TX / IEEE 802.11b / CH High**Test Date:** August 01, 2006**Temperature:** 20°C**Tested by:** Henry**Humidity:** 70 % RH**Polarity:** Ver. / Hor.

Freq. (MHz)	Ant.Pol. H/V	Detector Mode (PK/QP)	Reading (dBUV)	Factor (dB)	Actual FS (dBUV/m)	Limit 3m (dBUV/m)	Safe Margin (dB)
98.400	V	Peak	36.17	-5.58	30.59	43.50	-12.91
124.050	V	Peak	37.36	-7.52	29.84	43.50	-13.66
152.400	V	Peak	39.86	-8.14	31.72	43.50	-11.78
319.833	V	Peak	40.33	-11.93	28.40	46.00	-17.60
800.500	V	Peak	42.96	-3.25	39.71	46.00	-6.29
907.833	V	Peak	36.99	-6.29	30.70	46.00	-15.30
91.650	H	Peak	47.89	-11.00	36.89	43.50	-6.61
141.150	H	Peak	41.78	-8.37	33.41	43.50	-10.09
168.600	H	Peak	38.48	-8.74	29.74	43.50	-13.76
280.200	H	Peak	35.09	-7.07	28.02	46.00	-17.98
319.833	H	Peak	46.51	-7.72	38.79	46.00	-7.21
800.500	H	Peak	44.08	-4.14	39.94	46.00	-6.06

Notes:

1. Measuring frequencies from 30 MHz to the 1GHz.
2. Radiated emissions measured in frequency range from 30 MHz to 1000MHz were made with an instrument using Peak/Quasi-peak detector mode.
3. Data of measurement within this frequency range shown " --- " in the table above means the reading of emissions are attenuated more than 20dB below the permissible limits or the field strength is too small to be measured.
4. The IF bandwidth of SPA between 30MHz to 1GHz was 100kHz.

**Operation Mode:** TX / IEEE 802.11g / CH Low**Test Date:** August 01, 2006**Temperature:** 20°C**Tested by:** Henry**Humidity:** 70 % RH**Polarity:** Ver. / Hor.

Freq. (MHz)	Ant.Pol. H/V	Detector Mode (PK/QP)	Reading (dBuV)	Factor (dB)	Actual FS (dBuV/m)	Limit 3m (dBuV/m)	Safe Margin (dB)
91.650	V	Peak	45.97	-10.31	35.66	43.50	-7.84
168.600	V	Peak	46.78	-6.84	39.94	43.50	-3.56
319.833	V	Peak	39.69	-11.93	27.76	46.00	-18.24
459.833	V	Peak	31.10	3.53	34.63	46.00	-11.37
723.500	V	Peak	31.41	2.60	34.01	46.00	-11.99
800.500	V	Peak	43.32	-3.25	40.07	46.00	-5.93
64.650	H	Peak	35.00	-0.39	34.61	40.00	-5.39
84.450	H	Peak	43.92	-7.92	36.00	40.00	-4.00
130.350	H	Peak	48.14	-8.00	40.14	43.50	-3.36
319.833	H	Peak	46.09	-7.72	38.37	46.00	-7.63
549.833	H	Peak	30.97	4.15	35.12	46.00	-10.88
800.500	H	Peak	43.37	-4.14	39.23	46.00	-6.77

Notes:

1. Measuring frequencies from 30 MHz to the 1GHz.
2. Radiated emissions measured in frequency range from 30 MHz to 1000MHz were made with an instrument using Peak/Quasi-peak detector mode.
3. Data of measurement within this frequency range shown " --- " in the table above means the reading of emissions are attenuated more than 20dB below the permissible limits or the field strength is too small to be measured.
4. The IF bandwidth of SPA between 30MHz to 1GHz was 100kHz.

**Operation Mode:** TX / IEEE 802.11g / CH Mid**Test Date:** August 01, 2006**Temperature:** 20°C**Tested by:** Henry**Humidity:** 70 % RH**Polarity:** Ver. / Hor.

Freq. (MHz)	Ant.Pol. H/V	Detector Mode (PK/QP)	Reading (dBuV)	Factor (dB)	Actual FS (dBuV/m)	Limit 3m (dBuV/m)	Safe Margin (dB)
80.400	V	Peak	40.64	-7.12	33.52	40.00	-6.48
160.950	V	Peak	44.37	-5.97	38.40	43.50	-5.10
319.833	V	Peak	39.91	-11.93	27.98	46.00	-18.02
459.833	V	Peak	30.49	3.53	34.02	46.00	-11.98
666.333	V	Peak	32.07	1.59	33.66	46.00	-12.34
800.500	V	Peak	44.43	-3.25	41.18	46.00	-4.82
78.150	H	Peak	44.53	-7.56	36.97	40.00	-3.03
89.850	H	Peak	46.42	-11.53	34.89	43.50	-8.61
124.950	H	Peak	41.98	-6.97	35.01	43.50	-8.49
319.833	H	Peak	46.40	-7.72	38.68	46.00	-7.32
459.833	H	Peak	30.57	4.15	34.72	46.00	-11.28
800.500	H	Peak	44.96	-4.14	40.82	46.00	-5.18

Notes:

1. Measuring frequencies from 30 MHz to the 1GHz.
2. Radiated emissions measured in frequency range from 30 MHz to 1000MHz were made with an instrument using Peak/Quasi-peak detector mode.
3. Data of measurement within this frequency range shown " --- " in the table above means the reading of emissions are attenuated more than 20dB below the permissible limits or the field strength is too small to be measured.
4. The IF bandwidth of SPA between 30MHz to 1GHz was 100kHz.



Operation Mode: TX / IEEE 802.11g / CH High

Test Date: August 01, 2006

Temperature: 20°C

Tested by: Henry

Humidity: 70 % RH

Polarity: Ver. / Hor.

Freq. (MHz)	Ant.Pol. H/V	Detector Mode (PK/QP)	Reading (dBUV)	Factor (dB)	Actual FS (dBUV/m)	Limit 3m (dBUV/m)	Safe Margin (dB)
77.250	V	Peak	39.16	-7.62	31.54	40.00	-8.46
187.500	V	Peak	39.94	-8.46	31.48	43.50	-12.02
319.833	V	Peak	40.01	-11.93	28.08	46.00	-17.92
461.000	V	Peak	31.41	3.36	34.77	46.00	-11.23
723.500	V	Peak	32.49	2.60	35.09	46.00	-10.91
800.500	V	Peak	43.14	-3.25	39.89	46.00	-6.11
77.250	H	Peak	39.59	-7.01	32.58	40.00	-7.42
87.600	H	Peak	44.91	-9.81	35.10	40.00	-4.90
94.350	H	Peak	43.20	-9.96	33.24	43.50	-10.26
319.833	H	Peak	46.06	-7.72	38.34	46.00	-7.66
459.833	H	Peak	31.13	4.15	35.28	46.00	-10.72
800.500	H	Peak	43.56	-4.14	39.42	46.00	-6.58

Notes:

1. Measuring frequencies from 30 MHz to the 1GHz.
2. Radiated emissions measured in frequency range from 30 MHz to 1000MHz were made with an instrument using Peak/Quasi-peak detector mode.
3. Data of measurement within this frequency range shown " --- " in the table above means the reading of emissions are attenuated more than 20dB below the permissible limits or the field strength is too small to be measured.
4. The IF bandwidth of SPA between 30MHz to 1GHz was 100kHz.



Above 1 GHz

Operation Mode: TX / IEEE 802.11b / CH Low

Test Date: August 01, 2006

Temperature: 23°C

Tested by: Henry

Humidity: 56 % RH

Polarity: Ver. / Hor.

Freq. (MHz)	Ant. Pol H/V	Peak Reading (dBuV)	AV Reading (dBuV)	Ant. / CL CF (dB)	Actual Fs		Peak Limit (dBuV/m)	AV Limit (dBuV/m)	Margin (dB)	Remark
					Peak (dBuV/m)	AV (dBuV/m)				
1920.00	V	54.49	37.91	-0.09	54.40	37.82	74.00	54.00	-19.60	AVG.
2240.00	V	53.71	36.09	0.65	54.36	36.74	74.00	54.00	-19.64	AVG.
4891.66	V	45.43	---	6.84	52.27	---	74.00	54.00	-1.73	Peak
N/A										
1120.00	H	54.41	---	-2.16	52.25	---	74.00	54.00	-1.75	Peak
1440.00	H	54.87	---	-2.22	52.65	---	74.00	54.00	-1.35	Peak
4925.00	H	44.73	---	7.18	51.91	---	74.00	54.00	-2.09	Peak
N/A										

Notes:

1. Measuring frequencies from 1 GHz to the 10th harmonic of highest fundamental frequency.
2. Measurements above show only up to 6 maximum emissions noted, or would be lesser if no specific emissions from the EUT are recorded (ie: margin > 20dB from the applicable limit) and considered that's already beyond the background noise floor.
3. Radiated emissions measured in frequency above 1000MHz were made with an instrument using Peak detector mode and average detector mode of the emission shown in Actual FS column.
4. Spectrum setting:
 - a. Peak Setting 1GHz - 26GHz, RBW = 1MHz, VBW = 1MHz, Sweep time = 200 ms.
 - b. AV Setting 1GHz - 26GHz, RBW = 1MHz, VBW = 10Hz, Sweep time = 200 ms.



Operation Mode: TX / IEEE 802.11b / CH Mid

Test Date: August 01, 2006

Temperature: 20°C

Tested by: Henry

Humidity: 70 % RH

Polarity: Ver. / Hor.

Freq. (MHz)	Ant. Pol H/V	Peak Reading (dBuV)	AV Reading (dBuV)	Ant. / CL CF (dB)	Actual Fs		Peak Limit (dBuV/m)	AV Limit (dBuV/m)	Margin (dB)	Remark
					Peak (dBuV/m)	AV (dBuV/m)				
1440.00	V	56.11	---	-2.22	53.89	---	74.00	54.00	-0.11	Peak
1920.00	V	54.17	39.58	-0.09	54.08	39.47	74.00	54.00	-19.92	AVG.
4941.66	V	45.64	---	7.35	52.99	---	74.00	54.00	-1.01	Peak
N/A										
1120.00	H	54.72	---	-2.16	52.56	---	74.00	54.00	-1.44	Peak
1440.00	H	54.96	---	-2.22	52.74	---	74.00	54.00	-1.26	Peak
4958.33	H	44.76	---	7.52	52.28	---	74.00	54.00	-1.72	Peak
N/A										

Notes:

1. Measuring frequencies from 1 GHz to the 10th harmonic of highest fundamental frequency.
2. Measurements above show only up to 6 maximum emissions noted, or would be lesser if no specific emissions from the EUT are recorded (ie: margin > 20dB from the applicable limit) and considered that's already beyond the background noise floor.
3. Radiated emissions measured in frequency above 1000MHz were made with an instrument using Peak detector mode and average detector mode of the emission shown in Actual FS column.
4. Spectrum setting:
 - a. Peak Setting 1GHz - 26GHz, RBW = 1MHz, VBW = 1MHz, Sweep time = 200 ms.
 - b. AV Setting 1GHz - 26GHz, RBW = 1MHz, VBW = 10Hz, Sweep time = 200 ms.



Operation Mode: TX / IEEE 802.11b / CH High

Test Date: August 01, 2006

Temperature: 20°C

Tested by: Henry

Humidity: 70 % RH

Polarity: Ver. / Hor.

Freq. (MHz)	Ant. Pol H/V	Peak Reading (dBuV)	AV Reading (dBuV)	Ant. / CL CF (dB)	Actual Fs		Peak Limit (dBuV/m)	AV Limit (dBuV/m)	Margin (dB)	Remark
					Peak (dBuV/m)	AV (dBuV/m)				
1440.00	V	55.14	---	-2.22	52.92	---	74.00	54.00	-1.08	Peak
1920.00	V	54.42	38.83	-0.09	54.33	38.74	74.00	54.00	-19.67	AVG
4941.66	V	45.87	---	7.35	53.22	---	74.00	54.00	-0.78	Peak
N/A										
1020.00	H	56.33	41.40	-2.23	54.10	39.01	74.00	54.00	-19.90	AVG
1090.00	H	54.72	---	-2.18	52.54	---	74.00	54.00	-1.46	Peak
4958.33	H	44.72	---	7.52	52.24	---	74.00	54.00	-1.76	Peak
N/A										

Notes:

1. Measuring frequencies from 1 GHz to the 10th harmonic of highest fundamental frequency.
2. Measurements above show only up to 6 maximum emissions noted, or would be lesser if no specific emissions from the EUT are recorded (ie: margin > 20dB from the applicable limit) and considered that's already beyond the background noise floor.
3. Radiated emissions measured in frequency above 1000MHz were made with an instrument using Peak detector mode and average detector mode of the emission shown in Actual FS column.
4. Spectrum setting:
 - a. Peak Setting 1GHz - 26GHz, RBW = 1MHz, VBW = 1MHz, Sweep time = 200 ms.
 - b. AV Setting 1GHz - 26GHz, RBW = 1MHz, VBW = 10Hz, Sweep time = 200 ms.



Operation Mode: TX / IEEE 802.11g / CH Low

Test Date: August 01, 2006

Temperature: 20°C

Tested by: Henry

Humidity: 70 % RH

Polarity: Ver. / Hor.

Freq. (MHz)	Ant. Pol H/V	Peak Reading (dBuV)	AV Reading (dBuV)	Ant. / CL CF (dB)	Actual Fs		Peak Limit (dBuV/m)	AV Limit (dBuV/m)	Margin (dB)	Remark
					Peak (dBuV/m)	AV (dBuV/m)				
1080.00	V	55.67	---	-2.19	53.48	---	74.00	54.00	-0.52	Peak
1920.00	V	53.54	---	-0.09	53.45	---	74.00	54.00	-0.55	Peak
4916.66	V	45.19	---	7.09	52.28	---	74.00	54.00	-1.72	Peak
N/A										
1440.00	H	56.18	---	-2.22	53.96	---	74.00	54.00	-0.04	Peak
1920.00	H	51.78	---	-0.09	51.69	---	74.00	54.00	-2.31	Peak
4950.00	H	45.81	---	7.43	53.24	---	74.00	54.00	-0.76	Peak
N/A										

Notes:

1. Measuring frequencies from 1 GHz to the 10th harmonic of highest fundamental frequency.
2. Measurements above show only up to 6 maximum emissions noted, or would be lesser if no specific emissions from the EUT are recorded (ie: margin > 20dB from the applicable limit) and considered that's already beyond the background noise floor.
3. Radiated emissions measured in frequency above 1000MHz were made with an instrument using Peak detector mode and average detector mode of the emission shown in Actual FS column.
4. Spectrum setting:
 - a. Peak Setting 1GHz - 26GHz, RBW = 1MHz, VBW = 1MHz, Sweep time = 200 ms.
 - b. AV Setting 1GHz - 26GHz, RBW = 1MHz, VBW = 10Hz, Sweep time = 200 ms.



Operation Mode: TX / IEEE 802.11g / CH Mid

Test Date: August 01, 2006

Temperature: 20°C

Tested by: Henry

Humidity: 70 % RH

Polarity: Ver. / Hor.

Freq. (MHz)	Ant. Pol H/V	Peak Reading (dBuV)	AV Reading (dBuV)	Ant. / CL CF (dB)	Actual Fs		Peak Limit (dBuV/m)	AV Limit (dBuV/m)	Margin (dB)	Remark
					Peak (dBuV/m)	AV (dBuV/m)				
1080.00	V	55.28	---	-2.19	53.09	---	74.00	54.00	-0.91	Peak
1920.00	V	53.92	---	-0.09	53.83	---	74.00	54.00	-0.17	Peak
4875.00	V	46.68	---	6.67	53.35	---	74.00	54.00	-0.65	Peak
N/A										
1440.00	H	56.14	---	-2.22	53.92	---	74.00	54.00	-0.08	Peak
1920.00	H	52.30	---	-0.09	52.21	---	74.00	54.00	-1.79	Peak
4983.33	H	45.07	---	7.77	52.84	---	74.00	54.00	-1.16	Peak
N/A										

Notes:

1. Measuring frequencies from 1 GHz to the 10th harmonic of highest fundamental frequency.
2. Measurements above show only up to 6 maximum emissions noted, or would be lesser if no specific emissions from the EUT are recorded (ie: margin > 20dB from the applicable limit) and considered that's already beyond the background noise floor.
3. Radiated emissions measured in frequency above 1000MHz were made with an instrument using Peak detector mode and average detector mode of the emission shown in Actual FS column.
4. Spectrum setting:
 - a. Peak Setting 1GHz - 26GHz, RBW = 1MHz, VBW = 1MHz, Sweep time = 200 ms.
 - b. AV Setting 1GHz - 26GHz, RBW = 1MHz, VBW = 10Hz, Sweep time = 200 ms.



Operation Mode: TX / IEEE 802.11g / CH High

Test Date: August 01, 2006

Temperature: 20°C

Tested by: Henry

Humidity: 70 % RH

Polarity: Ver. / Hor.

Freq. (MHz)	Ant. Pol H/V	Peak Reading (dBuV)	AV Reading (dBuV)	Ant. / CL CF (dB)	Actual Fs		Peak Limit (dBuV/m)	AV Limit (dBuV/m)	Margin (dB)	Remark
					Peak (dBuV/m)	AV (dBuV/m)				
1440.00	V	55.98	---	-2.22	53.76	---	74.00	54.00	-0.24	Peak
1920.00	V	52.89	---	-0.09	52.80	---	74.00	54.00	-1.20	Peak
4925.00	V	44.71	---	7.18	51.89	---	74.00	54.00	-2.11	Peak
N/A										
1440.00	H	56.41	41.44	-2.22	54.19	39.22	74.00	54.00	-19.81	AVG.
1920.00	H	51.99	---	-0.09	51.90	---	74.00	54.00	-2.10	Peak
4941.66	H	45.12	---	7.35	52.47	---	74.00	54.00	-1.53	Peak
N/A										

Notes:

1. Measuring frequencies from 1 GHz to the 10th harmonic of highest fundamental frequency.
2. Measurements above show only up to 6 maximum emissions noted, or would be lesser if no specific emissions from the EUT are recorded (ie: margin > 20dB from the applicable limit) and considered that's already beyond the background noise floor.
3. Radiated emissions measured in frequency above 1000MHz were made with an instrument using Peak detector mode and average detector mode of the emission shown in Actual FS column.
4. Spectrum setting:
 - a. Peak Setting 1GHz - 26GHz, RBW = 1MHz, VBW = 1MHz, Sweep time = 200 ms.
 - b. AV Setting 1GHz - 26GHz, RBW = 1MHz, VBW = 10Hz, Sweep time = 200 ms.



POWERLINE CONDUCTED EMISSIONS

LIMIT

For an intentional radiator which is designed to be connected to the public utility (AC) power Line, the radio frequency voltage that is conducted back onto the AC power Line on any frequency or frequencies within the band 150 kHz to 30 MHz shall not exceed 250 microvolts (The limit decreases Linearly with the logarithm of the frequency in the range 0.15 MHz to 0.50 MHz). The limits at specific frequency range is listed as follows:

Frequency Range (MHz)	Limits (dBµV)	
	Quasi-peak	Average
0.15 to 0.50	66 to 56	56 to 46
0.50 to 5	56	46
5 to 30	60	50

Compliance with this provision shall be based on the measurement of the radio frequency voltage between each power Line (LINE and NEUTRAL) and ground at the power terminals.

MEASUREMENT EQUIPMENT USED

Conducted Emission Test Site G				
Name of Equipment	Manufacturer	Model	Serial Number	Calibration Due
ESCI EMI TEST RECEIV.ESCI	ROHDE&SCHWARZ	1166.5950 03	100088	02/08/2007
LISN	EMCO	3825/2	1371	02/08/2007
LISN	EMCO	3825/2	8901-1459	02/08/2007

Remark: Each piece of equipment is scheduled for calibration once a year.

Test Configuration

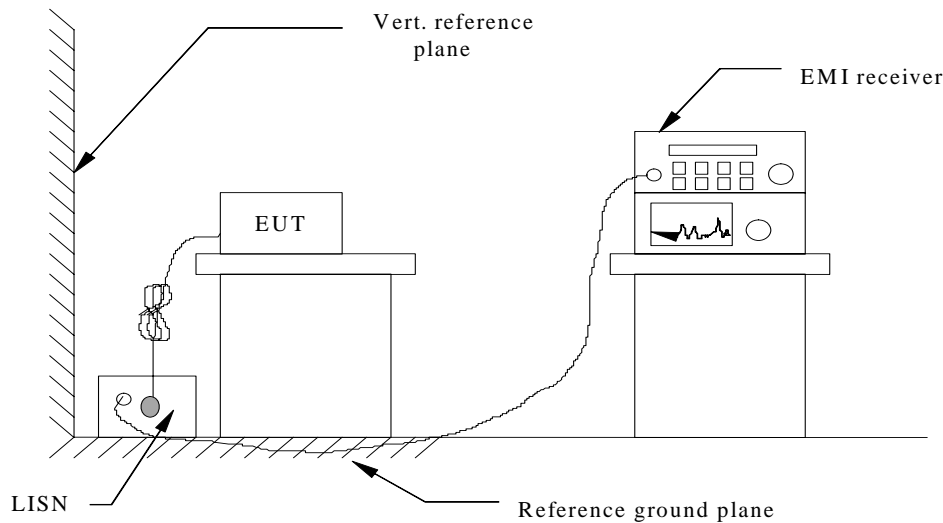

See test photographs attached in Appendix 1 for the actual connections between EUT and support equipment.

TEST PROCEDURE

1. The EUT was placed on a table, which is 0.8m above ground plane.
2. Maximum procedure was performed on the six highest emissions to ensure EUT compliance.
3. Repeat above procedures until all frequency measured were complete.

TEST RESULTS

The initial step in collecting conducted data is a spectrum analyzer peak scan of the measurement range. Significant peaks are then marked as shown on the following data page, and these signals are then quasi-peaked.

**Test Data**

Test Mode: TX+RX	Location: Site G
Model Name: 520G	Test Date: August 02, 2006
Tested by: Henry	Test Results: Passed

(The chart below shows the highest readings taken from the final data)

FREQ MHz	PEAK RAW dBuV	Q.P. RAW dBuV	AVG RAW dBuV	Q.P. Limit dBuV	AVG Limit dBuV	Q.P. Margin dB	AVG Margin dB	NOTE
0.187	42.45	---	---	64.94	54.94	---	-12.49	L1
0.272	37.04	---	---	62.50	52.50	---	-15.46	L1
0.353	34.49	---	---	60.17	50.17	---	-15.68	L1
0.580	28.82	---	---	56.00	46.00	---	-17.18	L1
1.013	31.32	---	---	56.00	46.00	---	-14.68	L1
4.436	16.04	---	---	56.00	46.00	---	-29.96	L1
0.287	32.34	---	---	62.08	52.08	---	-19.74	L2
0.565	24.38	---	---	56.00	46.00	---	-21.62	L2
1.006	30.71	---	---	56.00	46.00	---	-15.29	L2
1.792	13.91	---	---	56.00	46.00	---	-32.09	L2
3.939	13.97	---	---	56.00	46.00	---	-32.03	L2
6.448	11.43	---	---	60.00	50.00	---	-38.57	L2

Remark:

1. The measuring frequencies range between 0.15 MHz and 30 MHz.
2. The emissions measured in the frequency range between 0.15 MHz and 30MHz were made with an instrument using Quasi-peak detector and Average detector.
3. "----" denotes the emission level was or more than 2dB below the Average limit, and no re-check was made.
4. The IF bandwidth of SPA between 0.15MHz and 30MHz was 10KHz. The IF bandwidth of Test Receiver between 0.15MHz and 30MHz was 9kHz.
5. L1 = Line One (Live Line) / L2 = Line Two (Neutral Line)

Note:

Freq. = Emission frequency in KHz

Factor (dB) = cable loss + Insertion loss of LISN+ Insertion loss of TRANSIENT LIMITER (The TRANSIENT LIMITER included 10 dB ATTENUATION)

Amptd dBuV = Uncorrected Analyzer/Receiver reading + cable loss + Insertion loss of LISN+ Insertion loss of TRANSIENT LIMITER,



if it > 0.5 dB

Limit dBuV = Limit stated in standard

Margin dB = Reading in reference to limit

Calculation Formula

Margin (dB) = Amptd (dBuV) – Limit (dBuV)

Common Mode Conducted Emission

Not applicable

APPENDIX 1 PHOTOGRPHS OF TEST SETUP

LINE CONDUCTED EMISSION TEST



RADIATED EMISSION TEST

