

COMPANY:		
MODEL: VTB30		
PCB VER: V3.7	TITLE: S.C.H	DOC VER: 00
DRN./DATE:	DWG NO.:	
CHK./DATE:	IC:	
APP./DATE:	LCD:	
<input checked="" type="checkbox"/> TO FILE	<input type="checkbox"/> REL	SHEET OF: 1 OF 2

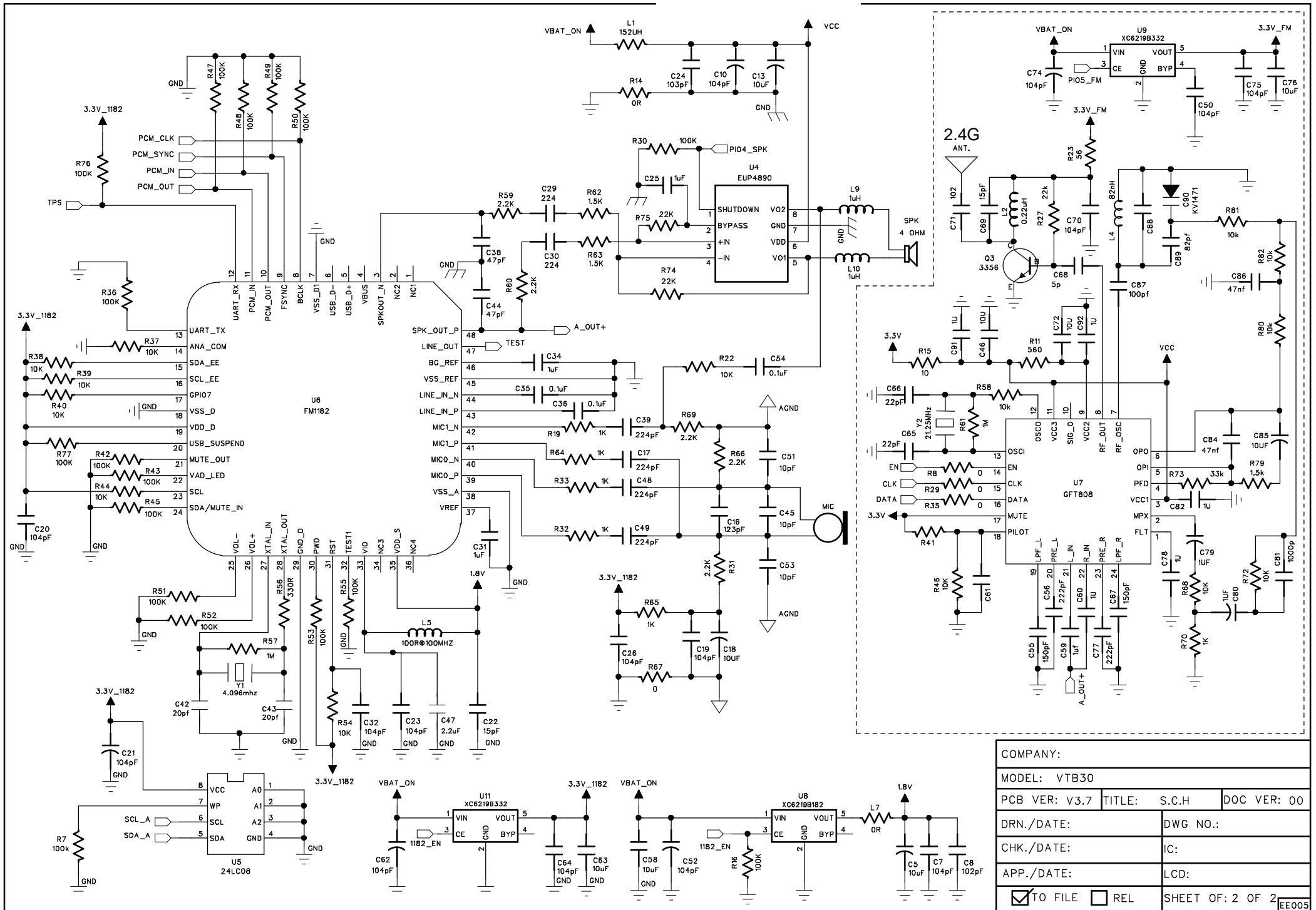

COMPANY:		
MODEL: VTB30		
PCB VER: V3.7	TITLE: S.C.H	DOC VER: 00
DRN./DATE:	DWG NO.:	
CHK./DATE:	IC:	
APP./DATE:	LCD:	
<input checked="" type="checkbox"/> TO FILE	<input type="checkbox"/> REL	SHEET OF: 2 OF 2