



FCC Part 90 TEST REPORT

For

Vehicle Radio

Model Name: ST-5189 (66 MHz- 88 MHz)

Brand Name: Soontone

FCC ID: T4KST-5189H3

Report No.: SZAGC013080302E6

Date of Issue: Apr.10, 2008

Prepared For

Qixiang Electron Science & Technology Co., Ltd.

Qixiang Building, Tangxi Industrial Zone, Luojiang District,

Quanzhou 362011, Fujian Province, China

Tel: 86-595-2265 6926

Fax:86-595-2265 6927

Prepared By

Shenzhen Attestation of Global Compliance Science & Technology Co., Ltd

Suite B11/B12, 4F, Huafeng Mall, Chuangye 2nd Road,

25 District, Bao'an, Shenzhen

Tel: 86-755-2974 2358

Fax: 86-755-2600 8484

VERIFICATION OF COMPLIANCE

Applicant:	Qixiang Electron Science & Technology Co., Ltd. Qixiang Building, Tangxi Industrial Zone, Luojiang District, Quanzhou 362011, Fujian Province, China
Manufacturer:	Qixiang Electron Science & Technology Co., Ltd. Qixiang Building, Tangxi Industrial Zone, Luojiang District, Quanzhou 362011, Fujian Province, China
Product Description:	Vehicle Radio
Brand Name:	Soontone
FCC ID:	T4KST-5189H3
File Number:	SZAGC013080302E6
Date of Test:	Mar.25, 2008 to Apr.09, 2008

We hereby certify that:

The above equipment was tested by **Shenzhen Attestation of Global Compliance Science & Technology Co., Ltd.** The data evaluation, test procedures, and equipment configurations shown in this report were made in accordance with the procedures given in ANSI C 63.4:2003 and TIA/EIA 603. :2004 The sample tested as described in this report is in compliance with the FCC Rules Part 90.

The test results of this report relate only to the tested sample identified in this report.

Prepared By: Tony Tian
Tony Tian Apr.10, 2008

Checked By: Randy He
Randy He Apr.10, 2008

Authorized By King Zhang
King Zhang Apr.10, 2008

TABLE OF CONTENTS

- 1. GENERAL INFORMATION 4**
 - 1.1 PRODUCT DESCRIPTION 4
 - 1.2 RELATED SUBMITTAL(S) / GRANT (S)..... 5
 - 1.3 TEST METHODOLOGY 5
 - 1.4 TEST FACILITY 5
 - 1.5 SPECIAL ACCESSORIES 5
 - 1.6 EQUIPMENT MODIFICATIONS 5

- 2. SYSTEM TEST CONFIGURATION 6**
 - 2.1 EUT CONFIGURATION..... 6
 - 2.2 EUT EXERCISE 6
 - 2.3 GENERAL TECHNICAL REQUIREMENTS 6
 - 2.4 CONFIGURATION OF TESTED SYSTEM..... 6

- 3. SUMMARY OF TEST RESULTS 7**

- 4. DESCRIPTION OF TEST MODES..... 8**

- 5. CONDUCTED LIMITS (NOT APPLICABLE) 9**
 - 5.1 PROVISIONS APPLICABLE 9
 - 5.2 MEASUREMENT PROCEDURE 9
 - 5.3 TEST SETUP BLOCK DIAGRAM..... 10
 - 5.4 TEST EQUIPMENT USED 10
 - 5.5 TEST RESULT 11

- 6. FREQUENCY TOLERANCE (NOT APPLICABLE) 12**
 - 6.1 PROVISIONS APPLICABLE..... 12
 - 6.2 MEASUREMENT PROCEDURE 12
 - 6.3 TEST SETUP BLOCK DIAGRAM..... 13
 - 6.4 TEST EQUIPMENT USED: 13
 - 6.5 TEST RESULT 13

- 7. EMISSION BANDWIDTH..... 17**
 - 7.1 PROVISIONS APPLICABLE..... 17
 - 7.2 MEASUREMENT PROCEDURE 17
 - 7.3 TEST SETUP BLOCK DIAGRAM 17
 - 7.4 MEASUREMENT EQUIPMENT USED: 17
 - 7.5 MEASUREMENT RESULT:..... 18

- 8. UNWANTED RADIATION 19**
 - 8.1 PROVISIONS APPLICABLE..... 19
 - 8.2 MEASUREMENT PROCEDURE 19
 - 8.3 TEST SETUP BLOCK DIAGRAM 20

- 8.4 MEASUREMENT EQUIPMENT USED: 22
- 8.5 MEASUREMENT RESULTS: 22
- 8.6 EMISSION MASK PLOT 23
- 9. MODULATION CHARACTERISTICS 24**
 - 9.1 PROVISIONS APPLICABLE 24
 - 9.2 MEASUREMENT METHOD 24
 - 9.3 MEASUREMENT INSTRUMENTS 24
 - 9.4 MEASUREMENT RESULT 25
- 10. MAXIMUM TRANSMITTER POWER (CONDUCTED OUTPUT POWER)..... 29**
 - 10.1 PROVISIONS APPLICABLE 29
 - 10.2 TEST PROCEDURE 29
 - 10.3 TEST INSTRUMENTS 29
 - 10.4 TEST RESULT 29
 - 10.5 CONDUCT SPURIOUS PLOT 30
- 11. TRANSMITTER FREQUENCY BEHAVIOR (NOT APPLICABLE) 32**
 - 11.1 PROVISIONS APPLICABLE 32
 - 11.2 TEST METHOD 32
 - 11.3 TEST INSTRUMENTS 32
 - 11.4 MEASURE RESULT 32
- 12. RADIATED EMISSION ON RECEIVING MODE..... 33**
 - 12.1 PROVISIONS APPLICABLE 33
 - 12.2 TEST METHOD 33
 - 12.3 TEST INSTRUMENTS 33
 - 12.4 MEASURE RESULT (MEASURED AT 3M USING FCC PART15 B LIMITS) 33
- APPENDIX I 34**
- PHOTOGRAPHS OF SETUP 34**
- APPENDIX II 36**
- PHOTOGRAPHS OF SAMPLE 36**

1. GENERAL INFORMATION

1.1 Product Description

The EUT is a single channel Two-way Radio designed for voice communication. It is designed by way of utilizing the FM modulation achieves the system operating.

A major technical description of EUT is described as following:

Communication Type	Voice / Tone only
Modulation	FM
Emission Type	14K0F3E
Emission Bandwidth	13.43 KHz (Limit: 20 KHz for 20 KHz channel Separation)
Audio Frequency Response	2.80 KHz (Limit<3.125 KHz)
Maximum Transmitter Power	48.19 W for 20.0 KHz Channel Separation
	24.21 W for 20.0 KHz Channel Separation
	4.93 W for 20.0 KHz Channel Separation
Output power Modification	Fixed can't be changed
Antenna Designation	Detachable
Power Supply	DC 13.8V
Operation Frequency Range and Channel	Frequency Range: 66 MHz to 88 MHz Channel Separation: 20 KHz
	Top Channel: 87.9875 MHz
	Centre Channel: 77.1250 MHz
	Bottom Channel: 66.1250 MHz

1.2 Related Submittal(s) / Grant (s)

This submittal(s) (test report) is intended for **FCC ID: T4KST-5189H3** filing to comply with the FCC Part 90 requirements

1.3 Test Methodology

The radiated emission testing was performed according to the procedures of ANSI C63.4 : 2003;TIA/EIA 603:2004 and FCC CFR 47 Rules of 2.1046, 2.1047, 2.1049, 2.1051, 2.1053, 2.1055, 2.1057.

1.4 Test Facility

The test site (WorldStandardizationCertification&TestingCo., Ltd.) used to collect the radiated data is located on the address of 1-2/F, Dachong Keji Building, No.28 of Tonggu Road, Nanshan District, Shenzhen, 518057, China

The registration number is 989301. The test site is constructed and calibrated to meet the FCC requirements in documents ANSI C63.4: 2003.

1.5 Special Accessories

Not available for this EUT intended for grant.

1.6 Equipment Modifications

Not available for this EUT intended for grant.

2. SYSTEM TEST CONFIGURATION

2.1 EUT Configuration

The EUT configuration for testing is installed on RF field strength measurement to meet the Commission’s requirement and operating in a manner which intends to maximize its emission characteristics in a continuous normal application.

2.2 EUT Exercise

The Transmitter was operated in the normal operating mode. the TX frequency was fixed which was for the purpose of the measurements.

2.3 General technical requirements

- (1). Section 15.207: Conducted Limits (Not Applicable)
- (2). Section 90.205: Maximum ERP is dependent upon the station’s antenna HAAT and required service area
- (3). Section 90.207: Modulation Characteristic
- (4). Section 90.209: Occupied Bandwidth
- (5). Section 90.210: Emission Mask
- (6). Section 90.213: Frequency Tolerance (Not Applicable)
- (7). Section 90.214: Transient Frequency Behavior (Not Applicable)

2.4 Configuration of Tested System

Fig. 2-1 Configuration of Tested System

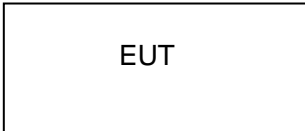

Table 2-1 Equipment Used in Tested System

Item	Equipment	Model No.	Identifier	Series No.	Note
1	Vehicle Radio	ST-5189	FCC ID: T4KST-5189H3	N/A	EUT
--	--	--	--	--	--
--	--	--	--	--	--

3. SUMMARY OF TEST RESULTS

FCC Rules	Description Of Test	Result
§15.207	Conducted Emission	N/A
§90.205	Maximum Transmitter Power	Compliant
§90.207	Modulation Characteristic	Compliant
§90.209	Occupied Bandwidth	Compliant
§90.210	Emission Mask	Compliant
§90.213	Frequency Tolerance	N/A
§90.214	Transient Frequency Behavior	N/A

4. DESCRIPTION OF TEST MODES

The EUT (Vehicle Radio) has been tested under normal operating condition. Three channels (The top channel, the middle channel and the bottom channel) are chosen for testing at 20.0 KHz each channel separation.

5. CONDUCTED LIMITS (Not Applicable)

5.1 PROVISIONS APPLICABLE

a). For an intentional radiator that is designed to be connected to the public utility(AC) power line, the, the radio frequency voltage that is conducted back onto the AC power line on any frequencies within the band 150 KHz to 30 MHz shall not exceed the limits in the following table, as measured using a 50uH/50 ohms line impedance stabilization network (LISN). Compliance with the provisions of this paragraph shall be based on the measurement of the radio frequency voltage between each power line and ground at the power terminal. The lower limit applies at the boundary between the frequencies ranges.

Frequency of Emission (MHz)	Conducted Limit(dBuV)	
	Quasi-Peak	Average
0.15 – 0.5	66 to 56 *	56 to 46 *
0.5 – 5	56	46
5 – 30	60	50

* Decreases with the logarithm of the frequency.

5.2 MEASUREMENT PROCEDURE

- (1) The equipment was set up as per the test configuration to simulate typical actual usage per the user’s manual. When the EUT is a tabletop system, a wooden table with a height of 0.8 meters is used and is placed on the ground plane as per ANSI C63.4 (see Test Facility for the dimensions of the ground plane used). When the EUT is a floor-standing equipment, it is placed on the ground plane which has a 3-12 mm non-conductive covering to insulate the EUT from the ground plane.
- (2) Support equipment, if needed, was placed as per ANSI C63.4.
- (3) All I/O cables were positioned to simulate typical actual usage as per ANSI C63.4.
- (4) The EUT received AC120V/60Hz power through a Line Impedance Stabilization Network (LISN) which supplied power source and was grounded to the ground plane.
- (5) All support equipments received AC power from a second LISN, if any.
- (6) The EUT test program was started. Emissions were measured on each current carrying line of the EUT using a spectrum Analyzer / Receiver connected to the LISN powering the EUT. The LISN has two monitoring points: Line 1 (Hot Side) and Line 2 (Neutral Side). Two scans were taken: one with Line 1 connected to Analyzer / Receiver and Line 2 connected to a 50 ohm load; the second scan had Line 1 connected to a 50 ohm load and Line 2 connected to the Analyzer / Receiver.
- (7) Analyzer / Receiver scanned from 150kHz to 30MHz for emissions in each of the test modes. During the above scans, the emissions were maximized by cable manipulation.

5.3 TEST SETUP BLOCK DIAGRAM

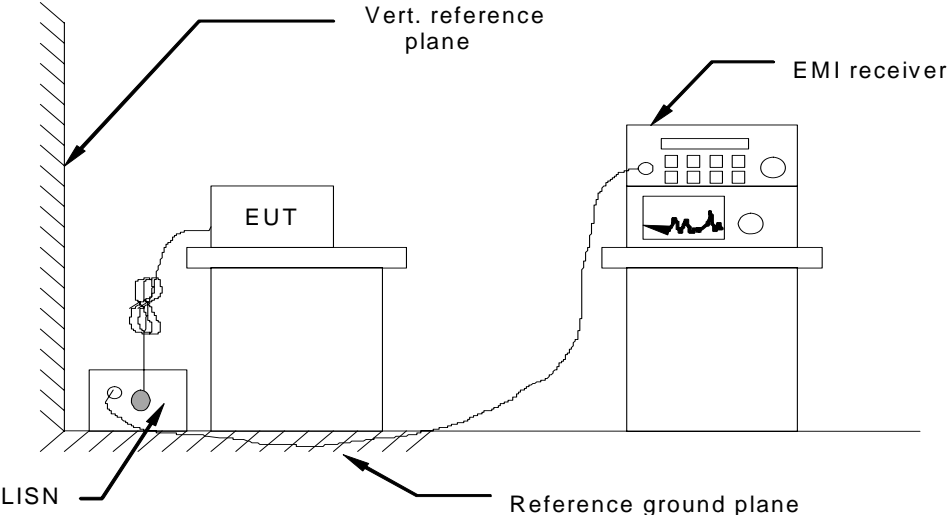

5.4 Test equipment used

Conducted Emission Test Site				
Name of Equipment	Manufacturer	Model	Serial Number	Calibration Due
--	--	--	--	--
--	--	--	--	--
--	--	--	--	--
--	--	--	--	--

5.5 TEST RESULT

LINE CONDUCTED EMISSION TEST

FREQ MHz	PEAK RAW dBuV	Q.P. RAW dBuV	AVG RAW dBuV	Q.P. Limit dBuV	AVG Limit dBuV	Q.P. Margin dB	AVG Margin dB	NOTE
---	---	---	---	---	---	---	---	---
---	---	---	---	---	---	---	---	---
---	---	---	---	---	---	---	---	---
---	---	---	---	---	---	---	---	---
---	---	---	---	---	---	---	---	---
---	---	---	---	---	---	---	---	---
---	---	---	---	---	---	---	---	---
---	---	---	---	---	---	---	---	---
---	---	---	---	---	---	---	---	---
---	---	---	---	---	---	---	---	---
---	---	---	---	---	---	---	---	---
---	---	---	---	---	---	---	---	---
---	---	---	---	---	---	---	---	---
---	---	---	---	---	---	---	---	---

****NOTE:**

“---” denotes the peak emission level was or more than 2dB below the Average limit, so no re-check anymore.

L1 = Line One (Hot side) / L2 = Line Two (Neutral side)

6. FREQUENCY TOLERANCE

6.1 Provisions Applicable

- a). According to FCC Part 2 Section 2.1055(a)(1), the frequency stability shall be measured with variation of ambient temperature from -30°C to $+60^{\circ}\text{C}$ centigrade.
- b). According to FCC Part 2 Section 2.1055(d)(2), for battery powered equipment, the frequency stability shall be measured with reducing primary supply voltage to the battery operating end point, which is specified by the manufacture.
- c). According to FCC Part 90 Section 90.213, the frequency tolerance must be maintained within 0.00025% for 12.5KHz channel separation and 0.0005% for 25KHz channel separation.

6.2 Measurement Procedure

6.2.1 Frequency stability versus environmental temperature

1. Setup the configuration per figure 1 for frequencies measurement inside an environment chamber, Install new battery in the EUT.
2. Turn on EUT and set SA center frequency to the EUT radiated frequency. Set SA Resolution Bandwidth to 1KHz and Video Resolution Bandwidth to 1KHz and Frequency Span to 50KHz. Record this frequency as reference frequency.
3. Set the temperature of chamber to 60°C . Allow sufficient time (approximately 30 min) for the temperature of the chamber to stabilize. While maintaining a constant temperature inside the chamber, turn the EUT on and measure the EUT operating frequency.
4. Repeat step 2 with a 10°C decreased per stage until the lowest temperature -30°C is measured, record all measured frequencies on each temperature step.

6.2.2 Frequency stability versus input voltage

1. Setup the configuration per figure 1 for frequencies measured at temperature if it is within 15°C to 25°C . Otherwise, an environment chamber set for a temperature of 20°C shall be used. The EUT shall be powered by DC 13.8V
2. Set SA center frequency to the EUT radiated frequency. Set SA Resolution Bandwidth to 1KHz and Video Resolution Bandwidth to 1KHz. Record this frequency as reference frequency.
3. Supply the EUT primary voltage at the operating end point which is specified by manufacturer and record the frequency.

6.3 Test Setup Block Diagram

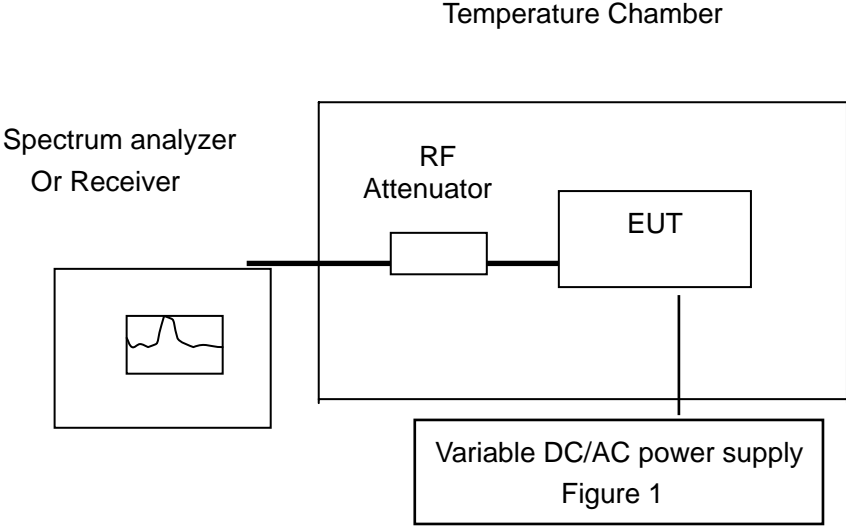

6.4 Test equipment used:

Name of Equipment	Manufacturer	Model	Serial Number	Cal. Date
Spectrum Analyzer	Agilent	E4440A	US41421290	2007-04-16
Climate Chamber	ESPEC	EL-10KA	05107008	2007-04-16

6.5 Test result

(50W – DC 13.8V/5.5A, 25W-DC 13.8V/3.7A, 5W-DC 13.8V/2.2A)

Measurement Result for Channel Separation of 20KHz

Channel	Reference Frequency (MHz)	Normal Condition	Frequency Deviation ppm	Limit ppm
Top	87.9875	87.987525	0.28	--
Middle	77.1250	77.125017	0.22	--
Bottom	66.1250	66.125013	0.20	--

(2) Frequency stability versus ambient temperature
(Max Power DC 11.73V and DC 15.88V)

Bottom Channel @ 20.0 KHz Channel Separations

Reference Frequency: 66.1250 MHz			
Environment Temperature (°C)	Power Supply (V)	Frequency deviation measured with time Elapse (10 minutes)	
		(MHz)	ppm
60	11.73 V	66.124918	-1.24
50	11.73 V	66.124941	-0.89
40	11.73 V	66.124965	-0.53
30	11.73 V	66.124981	-0.29
20	11.73 V	66.125009	0.14
10	11.73 V	66.125031	0.47
0	11.73 V	66.125057	0.86
-10	11.73 V	66.125085	1.29
-20	11.73 V	66.125112	1.69
-30	11.73 V	66.125137	2.07

Middle Channel @ 20.0 KHz Channel Separations

Reference Frequency: 77.1250 MHz			
Environment Temperature (°C)	Power Supply (V)	Frequency deviation measured with time Elapse (10 minutes)	
		(MHz)	ppm
60	11.73 V	77.124902	-1.27
50	11.73 V	77.124921	-1.02
40	11.73 V	77.124943	-0.74
30	11.73 V	77.124962	-0.49
20	11.73 V	77.125011	0.14
10	11.73 V	77.125029	0.38
0	11.73 V	77.125054	0.70
-10	11.73 V	77.125076	0.99
-20	11.73 V	77.125098	1.27
-30	11.73 V	77.125114	1.48

Top Channel @20.0 KHz Channel Separation

Reference Frequency: 87.9875 MHz			
Environment Temperature (°C)	Power Supply (V)	Frequency deviation measured with time Elapse (10 minutes)	
		(MHz)	ppm
60	11.73 V	87.987427	-0.83
50	11.73 V	87.987451	-0.56
40	11.73 V	87.987476	-0.27
30	11.73 V	87.987501	0.01
20	11.73 V	87.987519	0.22
10	11.73 V	87.987534	0.39
0	11.73 V	87.987559	0.67
-10	11.73 V	87.987581	0.92
-20	11.73 V	87.987603	1.17
-30	11.73 V	87.987624	1.41

Top Channel @ 20 KHz Channel Separation

Reference Frequency: 87.9875 MHz			
Environment Temperature (°C)	Power Supply (V)	Frequency deviation measured with time Elapse (10 minutes)	
		(MHz)	ppm
60	15.87	87.987421	-0.90
50	15.87	87.987448	-0.59
40	15.87	87.987471	-0.33
30	15.87	87.987506	0.07
20	15.87	87.987531	0.35
10	15.87	87.987556	0.64
0	15.87	87.987584	0.95
-10	15.87	87.987608	1.23
-20	15.87	87.987632	1.50
-30	15.87	87.987651	1.72

Middle Channel @ 20 KHz Channel Separations

Reference Frequency: 77.125 MHz			
Environment Temperature (°C)	Power Supply (V)	Frequency deviation measured with time Elapse (10 minutes)	
		(MHz)	ppm
60	15.87	77.124945	-0.71
50	15.87	77.124962	-0.49
40	15.87	77.124981	-0.25
30	15.87	77.125005	0.06
20	15.87	77.125024	0.31
10	15.87	77.125041	0.53
0	15.87	77.125065	0.84
-10	15.87	77.125089	1.15
-20	15.87	77.125107	1.39
-30	15.87	77.125126	1.63

Bottom Channel @ 20 KHz Channel Separation

Reference Frequency: 135.025 MHz			
Environment Temperature (°C)	Power Supply (V)	Frequency deviation measured with time Elapse (10 minutes)	
		(MHz)	ppm
60	15.87	66.124929	-1.07
50	15.87	66.124943	-0.86
40	15.87	66.124968	-0.48
30	15.87	66.124992	-0.12
20	15.87	66.125021	0.32
10	15.87	66.125047	0.71
0	15.87	66.125072	1.09
-10	15.87	66.125098	1.48
-20	15.87	66.125117	1.77
-30	15.87	66.125132	2.00

7. EMISSION BANDWIDTH

7.1 Provisions Applicable

According to FCC Part 90 Section 90.209: The authorized bandwidth shall be 20 KHz for 20 KHz channel spacing.

7.2 Measurement Procedure

- 1). The EUT was placed on a turn table which is 0.8m above ground plane.
- 2). The EUT was modulated by 1 KHz Sine wave audio signal to achieve 60% deviation
- 3). Set SPA Center Frequency = fundamental frequency, RBW=VBW= 300 Hz, Span =50 KHz.
- 4). Set SPA Max hold. Mark peak, -20dB.

7.3 Test Setup Block Diagram

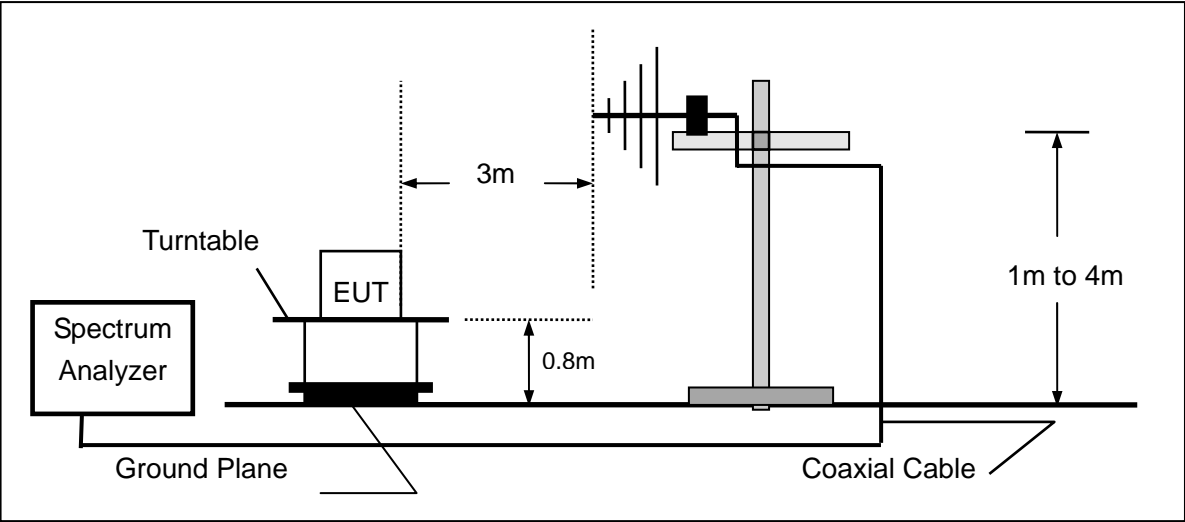

7.4 Measurement Equipment Used:

Name of Equipment	Manufacturer	Model	Serial Number	Cal. Date
Spectrum Analyzer	Agilent	E4440A	US41421290	2007-04-16
Climate Chamber	ESPEC	EL-10KA	05107008	2007-04-16

7.5 MEASUREMENT RESULT:

Operating Frequency	20 KHz Channel Separation		
	Test Data	Limits	Result
Bottom Channel	14.43 KHz	20.00 KHz	Pass
Middle Channel	14.12 KHz	20.00 KHz	Pass
Top Channel	14.32 KHz	20.00 KHz	Pass

Occupied bandwidth for Bottom Channel (Max Bandwidth)

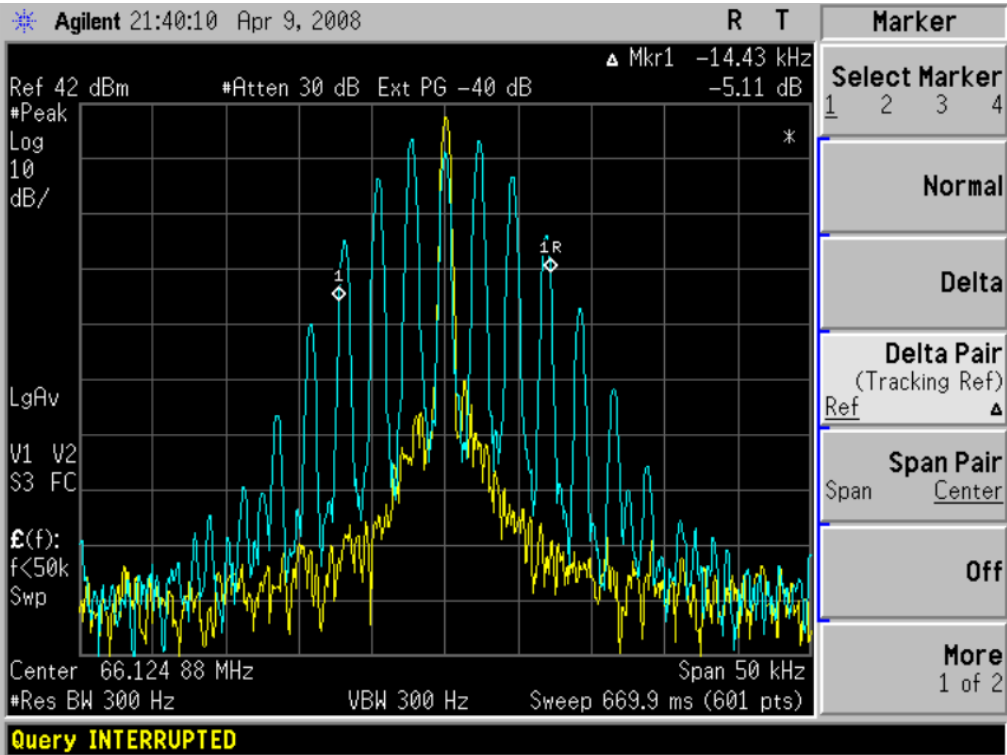

8. UNWANTED RADIATION

8.1 Provisions Applicable

- 8.1.1 According to Section 90.210, Emission mask B. For transmitters designed to transmit with 20 KHz channel separation and equipped with an audio low-pass filter, the power of any emission must be attenuated below the unmodulated carrier power (P) as following:
- (1), On any frequency removed from the assigned frequency by more than 50 percent, but no more than 100 percent of the authorized bandwidth: At least 25 dB.
 - (2), On any frequency removed from the assigned frequency by more than 100 percent, but no more than 250 percent of the authorized bandwidth: At least 35 dB.
 - (3), On any frequency removed from the assigned frequency by more than 250 percent of the authorized bandwidth: At least $43+10\text{Log}(P)$ dB.

8.2 Measurement Procedure

- (1). On a test site, the EUT shall be placed on a turntable, and in the position closest to the normal use as declared by the user.
- (2). The test antenna shall be oriented initially for vertical polarization located 3m from the EUT to correspond to the transmitter.
- (3). The output of the antenna shall be connected to the measuring receiver and either a peak or quasi-peak detector was used for the measurement as indicated on the report. The detector selection is based on how close the emission level was approaching the limit.
- (4). The transmitter shall be switched on; if possible, without the modulation and the measurement receiver shall be tuned to the frequency of the transmitter under test.
- (5). The test antenna shall be raised and lowered through the specified range of height until the measuring receiver detects a maximum signal level.
- (6). The transmitter shall then be rotated through 360° in the horizontal plane, until the maximum signal level is detected by the measuring receiver.
- (7). The test antenna shall be raised and lowered again through the specified range of height until the measuring receiver detects a maximum signal level.

- (8). The maximum signal level detected by the measuring receiver shall be noted.
- (9). The measurement shall be repeated with the test antenna set to horizontal polarization.
- (10). Replace the antenna with a proper Antenna (substitution antenna).
- (11). The substitution antenna shall be oriented for vertical polarization and, if necessary, the length of the substitution antenna shall be adjusted to correspond to the frequency of transmitting.
- (12). The substitution antenna shall be connected to a calibrated signal generator.
- (13). If necessary, the input attenuator setting of the measuring receiver shall be adjusted in order to increase the sensitivity of the measuring receiver.
- (14). The test antenna shall be raised and lowered through the specified range of the height to ensure that the maximum signal is received.
- (15). The input signal to substitution antenna shall be adjusted to the level that produces a level detected by the measuring receiver, that is equal to the level noted while the transmitter radiated power was measured, corrected for the change of input attenuation setting of the measuring

receiver.

(16). The input level to the substitution antenna shall be recorded as power level in dBm, corrected for any change of input attenuator setting of the measuring receiver.

(17). The measurement shall be repeated with the test antenna and the substitution antenna oriented for horizontal polarization.

8.3 Test Setup Block Diagram

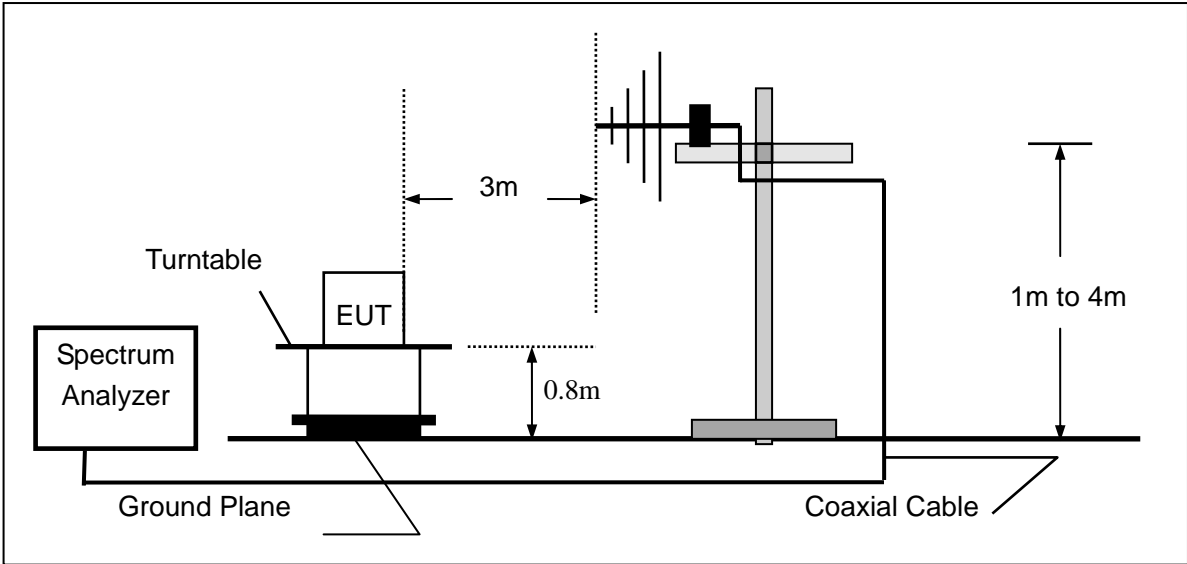

SUBSTITUTION METHOD: (Radiated Emissions)

Radiated Below 1GHz

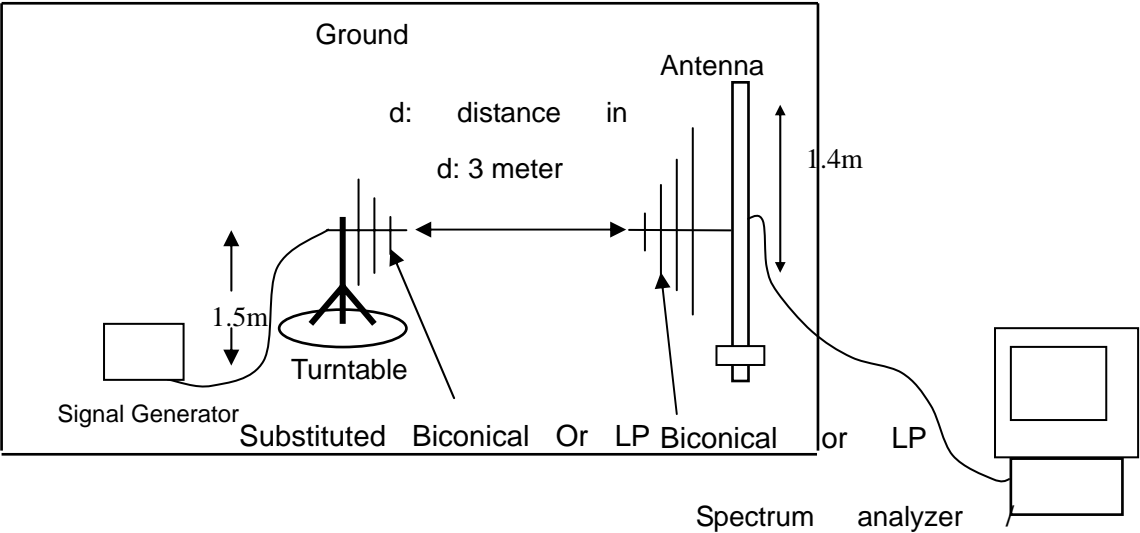

Radiated Above 1 GHz

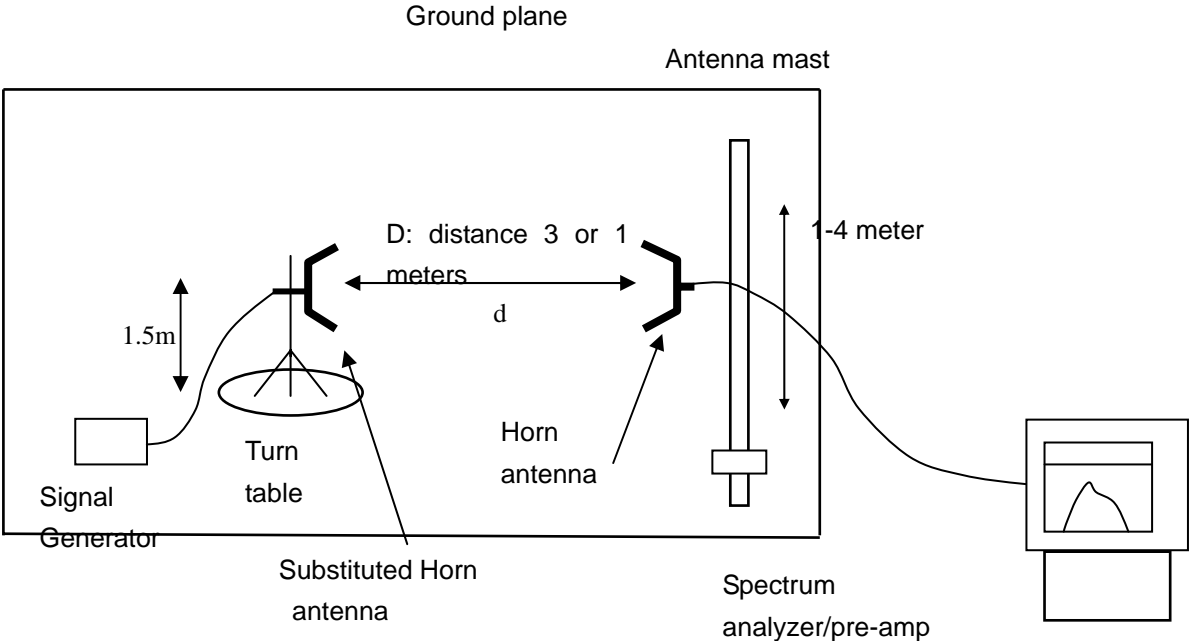

8.4 Measurement Equipment Used:

Radiated Emission Test Site				
Name of Equipment	Manufacturer	Model	Serial Number	Cal. Date
EMI Test Receiver	R&S	ESCS30	100343	2007-04-16
AMPLIFIER	HP	HP8447E	2945A02715	2007-04-16
ANTENNA	Sunol Sciences Corp.	JB3	A021907	2007-04-16

8.5 MEASUREMENT RESULTS:

Measurement Result For 20 KHz Channel Separation

Calculation: Limit (dBm)= EL-43-10log10 (TP)

Notes: EL is the emission level of the Output Power expressed in dBm,, in this application, the EL is 10log10(P) dBm.

Limit (dBm)=10log10(P) - 43-10log 10 (TP) = -13 dBm

Bottom Channel

Frequency (MHz)	Reading level (dBuV)	Antenna Polarization	S.G. (dBm)	Cable loss (dB)	Correction (dB)	Emission level (dBm)	Limit (dBm)	Margin (dB)
--	--	--	--	--	--	--	-13	--

Middle Channel

Frequency (MHz)	Reading level (dBuV)	Antenna Polarization	S.G. (dBm)	Cable loss (dB)	Correction (dB)	Emission level (dBm)	Limit (dBm)	Margin (dB)
--	--	--	--	--	--	--	-13	--

Top Channel

Frequency (MHz)	Reading level (dBuV)	Antenna Polarization	S.G. (dBm)	Cable loss (dB)	Correction (dB)	Emission level (dBm)	Limit (dBm)	Margin (dB)
--	--	--	--	--	--	--	-13	--

Notes:

“—“ means that the emission level is too low to be measured or at least 20 dB down than the limit.

8.6 Emission Mask Plot

The detailed procedure employed for Emission Mask measurements are specified as following:

- The transmitter shall be modulated by a 2.5 kHz audio signal,
- The level of the audio signal employed is 16 dB greater than that necessary to produce 50% of rated system deviation. Rated system deviation is 4 kHz (20 kHz channel spacing).

The Worst Emission Mask for 20 KHz channel Separation

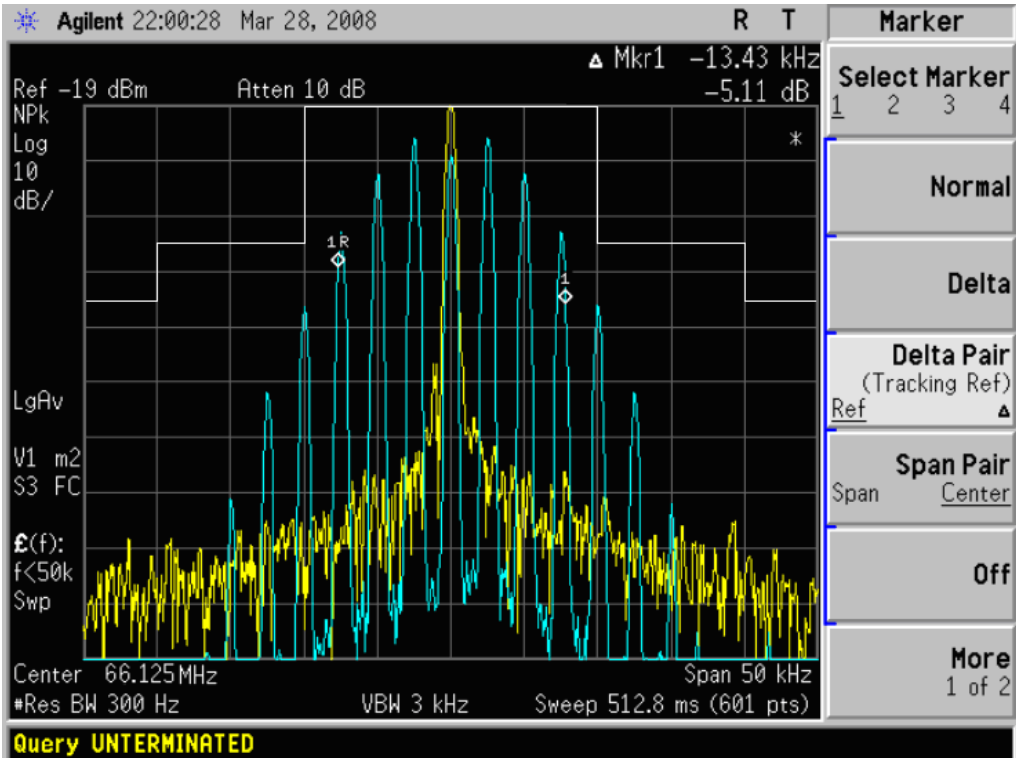

9. MODULATION CHARACTERISTICS

9.1 Provisions Applicable

According to CFR 47 section 2.1047(a), for Voice Modulation Communication Equipment, the frequency response of the audio modulation circuit over a range of 100 to 5000Hz shall be measured.

9.2 Measurement Method

9.2.1 Modulation Limit

- (1). Configure the EUT as shown in figure 1, adjust the audio input for 60% of rated system deviation at 1KHz using this level as a reference (0dB) and vary the input level from -20 to +20dB. Record the frequency deviation obtained as a function of the input level.
- (2). Repeat step 1 with input frequency changing to 300, 1000, and 3000Hz in sequence.

9.2.2 Audio Frequency Response

- (1). Configure the EUT as shown in figure 1.
- (2). Adjust the audio input for 20% of rated system deviation at 1 KHz using this level as a reference (0 dB).
- (3). Vary the Audio frequency from 100 Hz to 10 KHz and record the frequency deviation.
- (4). Audio Frequency Response = $20\log_{10} (\text{Deviation of test frequency} / \text{Deviation of 1KHz reference})$.

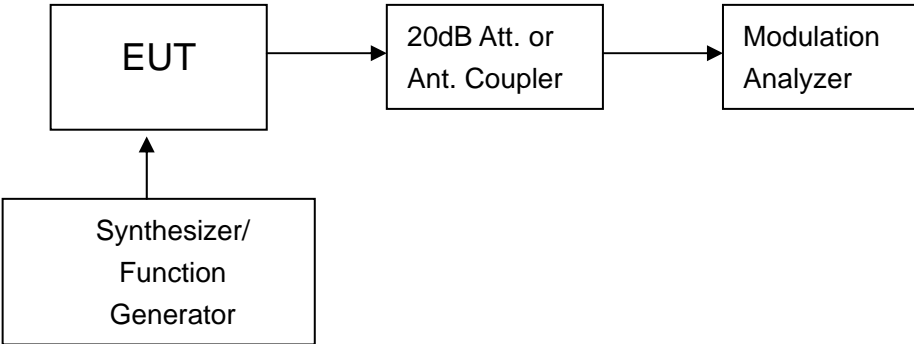

Figure 1: Modulation characteristic measurement configuration

9.3 Measurement Instruments

Name of Equipment	Manufacturer	Model	Serial Number	Cal. Date
Modulation Analyzer	HP	8920B	3104A03367	2007-04-16
Signal Generator	Rohde&Schwarz	SMT03	100059	2007-04-16

9.4 Measurement Result

(a). Modulation Limit:

Middle Channel @ 20KHz Channel Separation

Modulation Level (dB)	Peak Freq. Deviation At 300 Hz	Peak Freq. Deviation At 1000 Hz	Peak Freq. Deviation At 1500 Hz	Peak Freq. Deviation At 3000 Hz
-20	0.07	0.28	0.39	0.26
-15	0.10	0.45	0.65	0.40
-10	0.16	0.80	1.15	1.51
-5	0.36	1.39	2.04	2.50
0	0.61	2.47	2.95	2.65
+5	0.80	3.06	3.12	3.12
+10	1.42	3.17	3.16	3.21
+15	1.80	3.22	3.15	3.10
+20	1.89	3.23	3.16	3.18

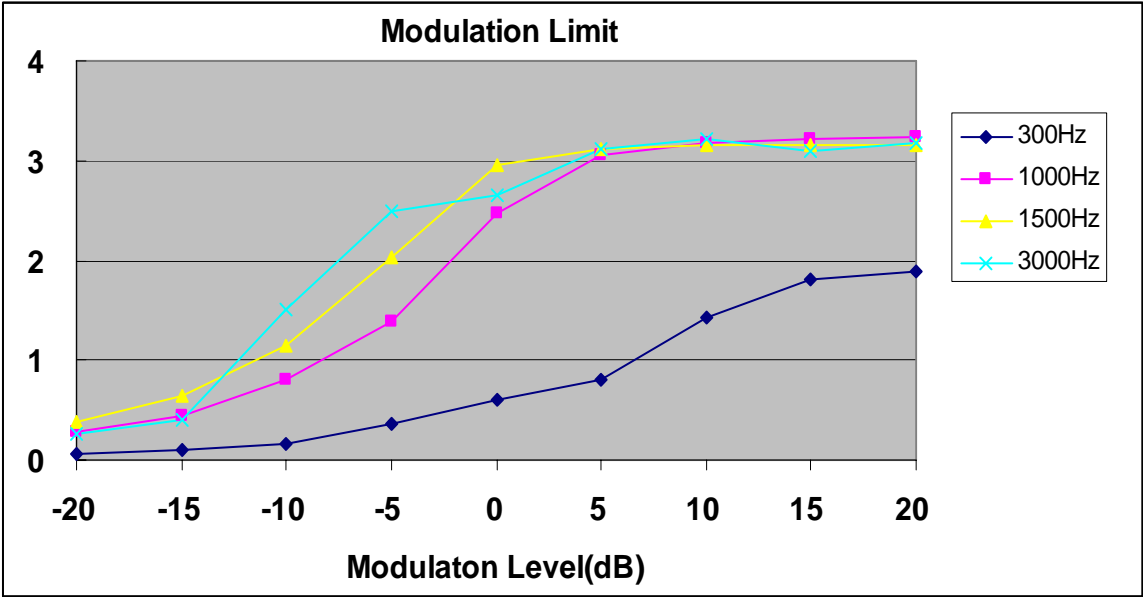

Audio Low Pass Filter Response Test Plot:

Response for 20.0 KHz Channel Separation

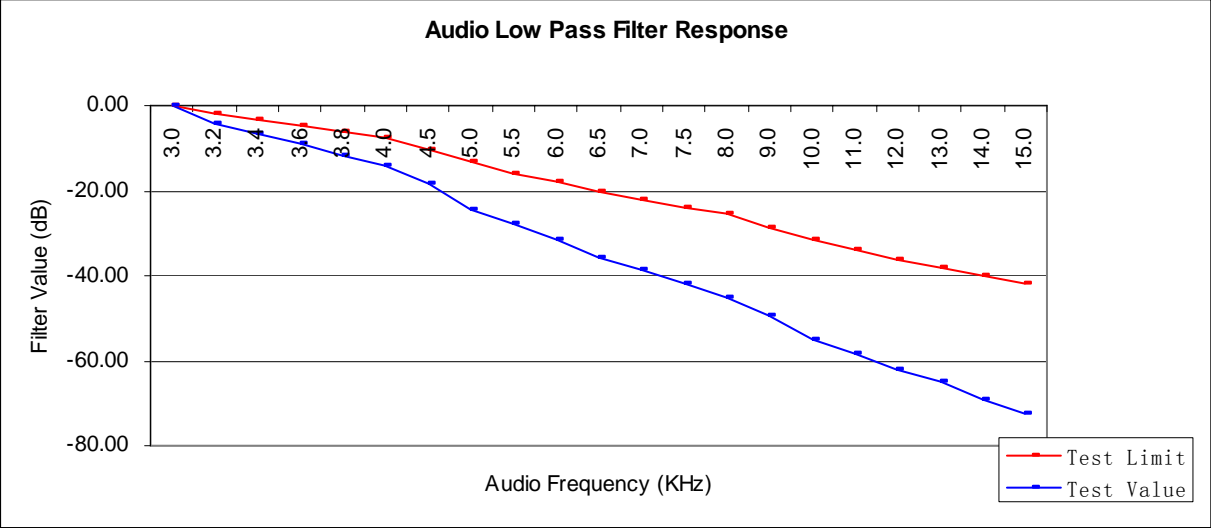

(b). Audio Frequency Response:

20 KHz Channel Separation

Frequency (Hz)	Deviation (KHz)
100	--
200	--
300	0.17
400	0.22
500	0.25
600	0.30
700	0.35
800	0.40
900	0.44
1000	0.49
1200	0.59
1400	0.69
1600	0.80
1800	0.91
2000	1.02
2200	1.13
2400	1.24
2600	1.33
2800	1.38
3000	1.36
3200	1.26
3400	1.11
3600	0.93
3800	0.77
4000	0.63
4500	0.38
5000	0.23
5500	0.14
6000	0.09
6500	0.06
7000	0.02
7500	--
8000	--
8500	--
9000	--
9500	--

Frequency Response of Middle Channel

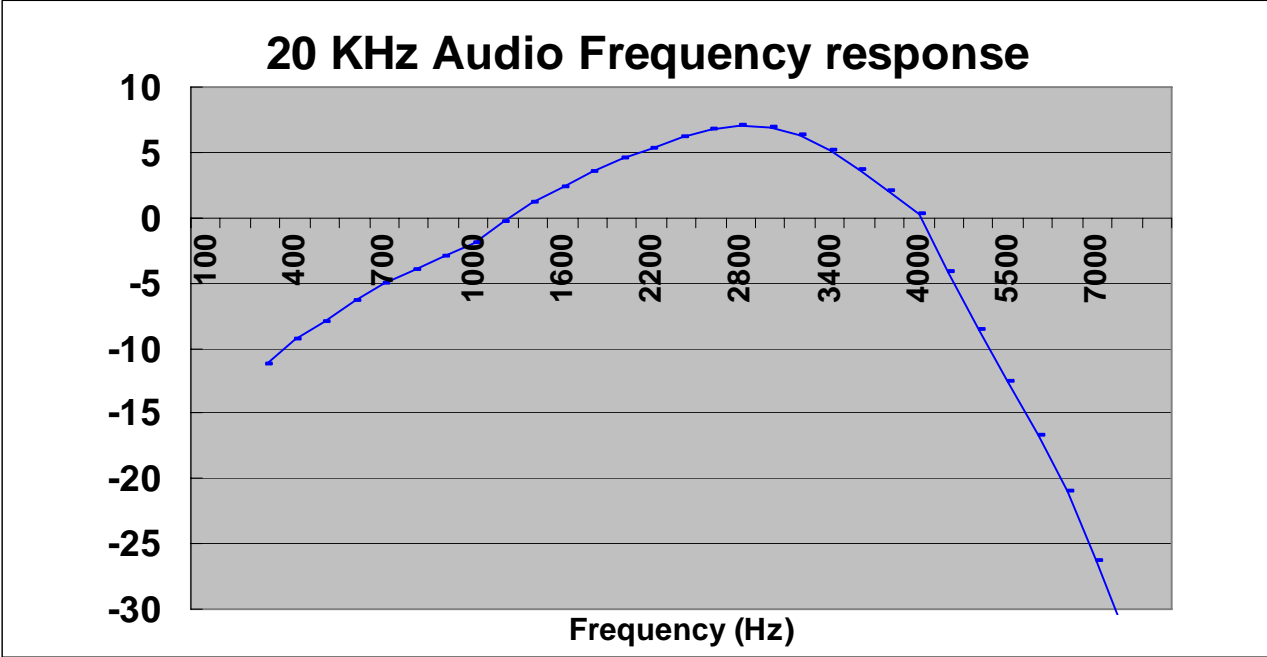

10. MAXIMUM TRANSMITTER POWER (CONDUCTED OUTPUT POWER)

10.1 Provisions Applicable

Per FCC §2.1046 and §90.205: Maximum ERP is dependent upon the station’s antenna HAAT and required service area.

10.2 Test Procedure

The RF output of transceiver was conducted to a spectrum analyzer through an appropriate attenuator.

10.3 Test Instruments

EQUIPMENT TYPE	MFR	MODEL NO.	SERIAL NO.	Cal. Date
Spectrum Analyzer	Agilent	E4440A	US41421290	2007-04-16
Attenuator	--	--	--	2007-04-16

10.4 Test Result

The maximum Conducted Power (CP) is
 48.19 W/24.21 W/4.93 W for 20 KHz Channel Separation

* Note:

Calculation Formula: $CP = R + A + L$

- CP: The final Conducted Power
- R : The reading value from spectrum analyzer
- A : The attenuation value of the used attenuator
- L : The loss of all connection cables

Conducted Power Measurement Results		
Channel Separation	Channel	Measurement Result
20 KHz	Bottom	46.74 / 43.89 / 36.92 dBm
	Middle	46.78 / 43.86 / 36.89 dBm
	Top	46.83 / 43.67 / 36.93 dBm

10.5 Conduct spurious plot

The Worst Case of The Three Channels for Conduct Spurious Emission - 50W

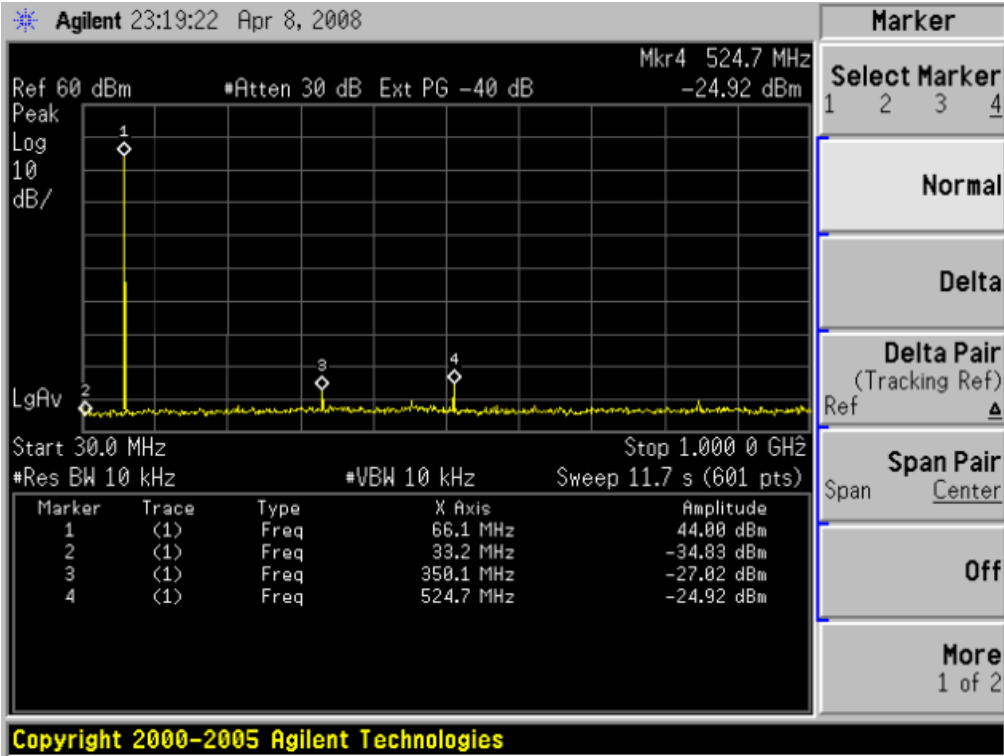

The Worst Case of The Three Channels for Conduct Spurious Emission - 25W

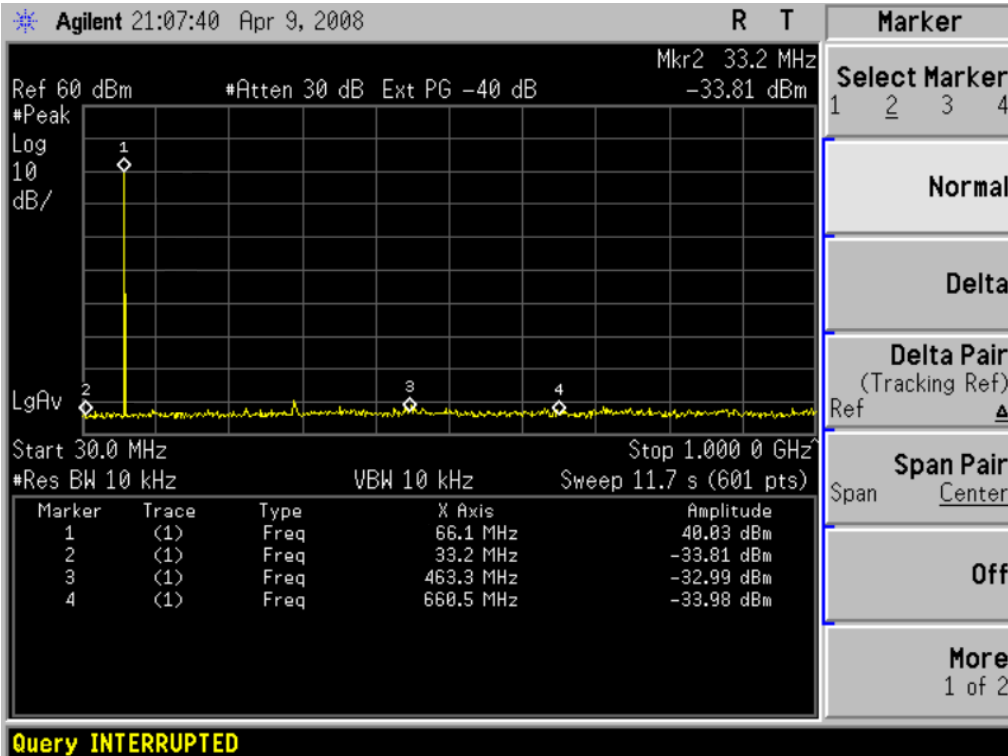

The Worst Case of The Three Channels for Conduct Spurious Emission - 5W

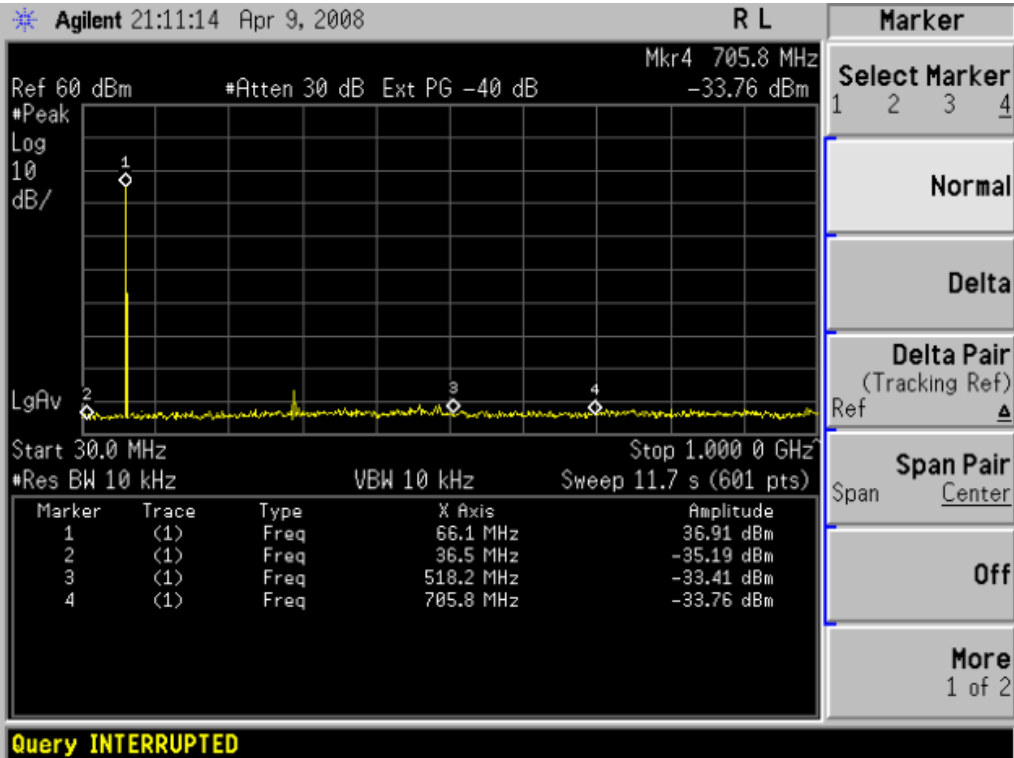

11 TRANSMITTER FREQUENCY BEHAVIOR (NOT APPLICABLE)

11.1 Provisions Applicable

Section 90.214

11.2 Test Method

TIA/EIA-603 2.2.19

11.3 Test Instruments

Name of Equipment	Manufacturer	Model	Serial Number	Calibration Due
Signal Generator	Rohde&Schwarz	SML01	101161	2007-04-16
Storage Oscilloscope	Tektronix	TDS3052	B017447	2007-04-16

11.4 Measure Result

N/A

12. RADIATED EMISSION ON RECEIVING MODE

12.1 Provisions Applicable

FCC Part 15 Subpart B Section 15.109

12.2 Test Method

ANSI C 63.4: 2003

12.3 Test Instruments

Radiated Emission Test Site				
Name of Equipment	Manufacturer	Model	Serial Number	Calibration Due
EMI Test Receiver	R&S	ESCS30	100343	2007-04-16
AMPLIFIER	HP	HP8447E	2945A02715	2007-04-16
ANTENNA	Sunol Sciences Corp.	JB3	A021907	2007-04-16

12.4 Measure Result (Measured at 3m using FCC Part15 B Limits)

Radiated Emission Test Result													
Frequency (MHz)	Reading Level (dBuV)			Factor dB	Emission Level (dBuV/m)			Limits (dBuV/m)			Margin (dB)	Result (P/F)	Remarks (H/V)
	Peak	Q.P.	Avg.		Peak	Q.P.	Avg.	Peak	Q.P.	Avg.			
44.09	18.98	--	--	6.02	25.00	--	--	--	40	--	-15.00	P	H
74.24	20.12	--	--	6.98	27.10	--	--	--	40	--	-12.90	P	H
267.89	17.65	--	--	13.56	31.21	--	--	--	46	--	-14.79	P	H
387.54	18.09	--	--	16.54	34.63	--	--	--	46	--	-11.37	P	H
523.65	16.42	--	--	17.89	34.31	--	--	--	46	--	-11.69	P	H
720.12	11.93	--	--	19.08	31.01	--	--	--	46	--	-14.99	P	H
44.12	23.17	--	--	9.76	32.93	--	--	--	40	--	-7.07	P	V
74.09	13.98	--	--	17.01	30.99	--	--	--	40	--	-9.01	P	V
301.26	12.08	--	--	17.68	29.76	--	--	--	46	--	-16.24	P	V
421.76	10.73	--	--	18.54	29.27	--	--	--	46	--	-16.73	P	V
547.98	9.87	--	--	20.07	29.94	--	--	--	46	--	-16.06	P	V
720.19	13.93	--	--	21.09	35.02	--	--	--	46	--	-10.98	P	V

APPENDIX I

PHOTOGRAPHS OF SETUP

RADIATED TEST SETUP



APPENDIX II
PHOTOGRAPHS OF SAMPLE

TOP VIEW OF SAMPLE



BOTTOM VIEW OF SAMPLE



LEFT VIEW OF SAMPLE



RIGHT VIEW OF SAMPLE



FRONT VIEW OF SAMPLE



BACK VIEW OF SAMPLE

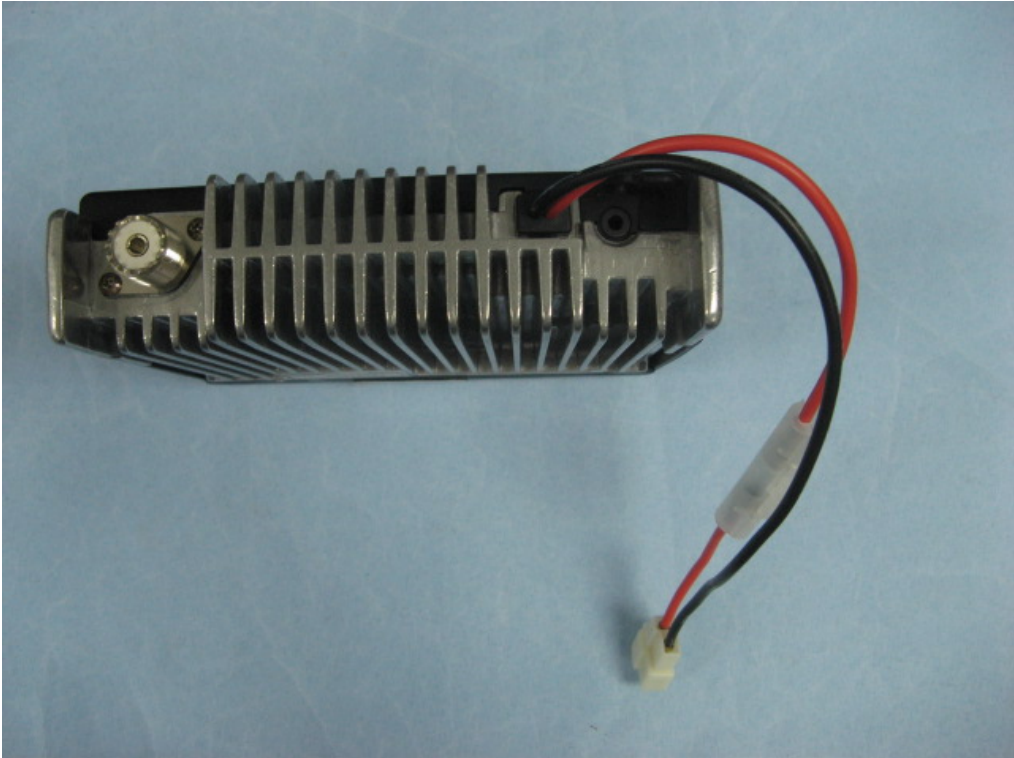

INTERNAL VIEW OF SAMPLE -1

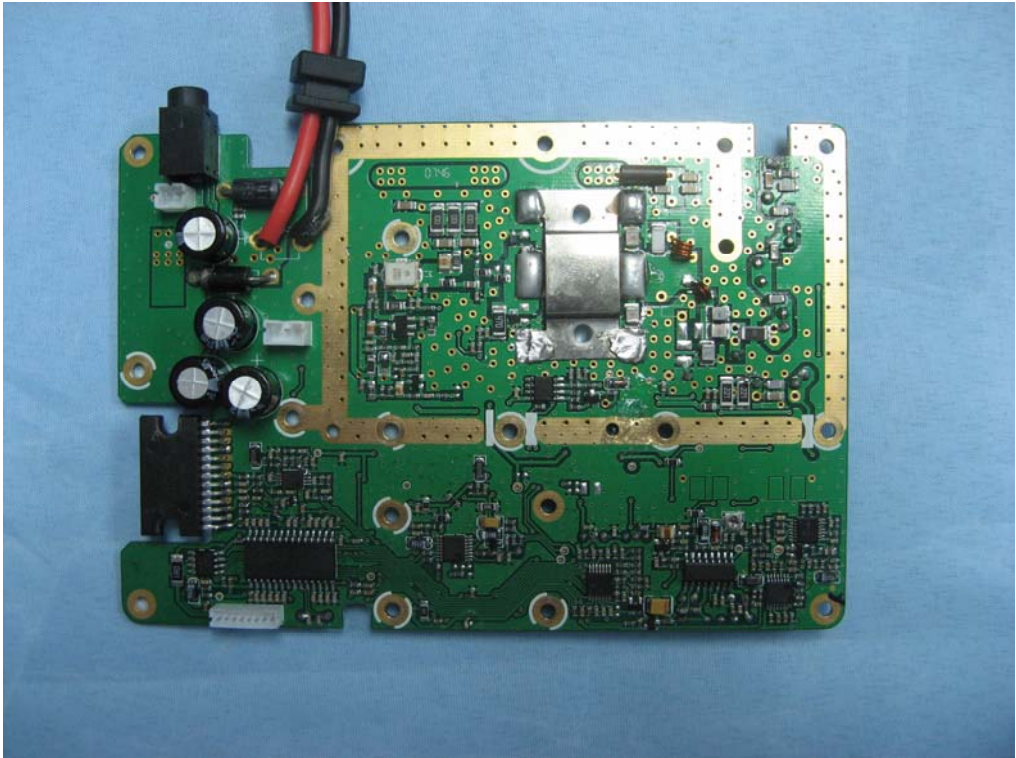

INTERNAL VIEW OF SAMPLE -2

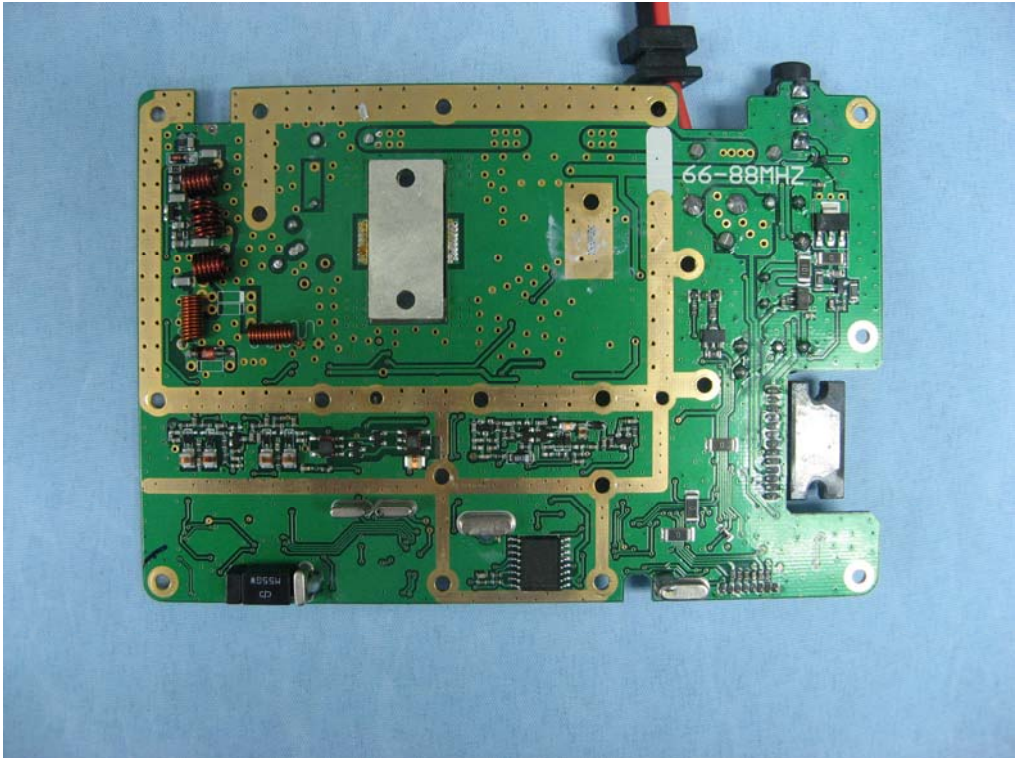

INTERNAL VIEW OF SAMPLE – 3

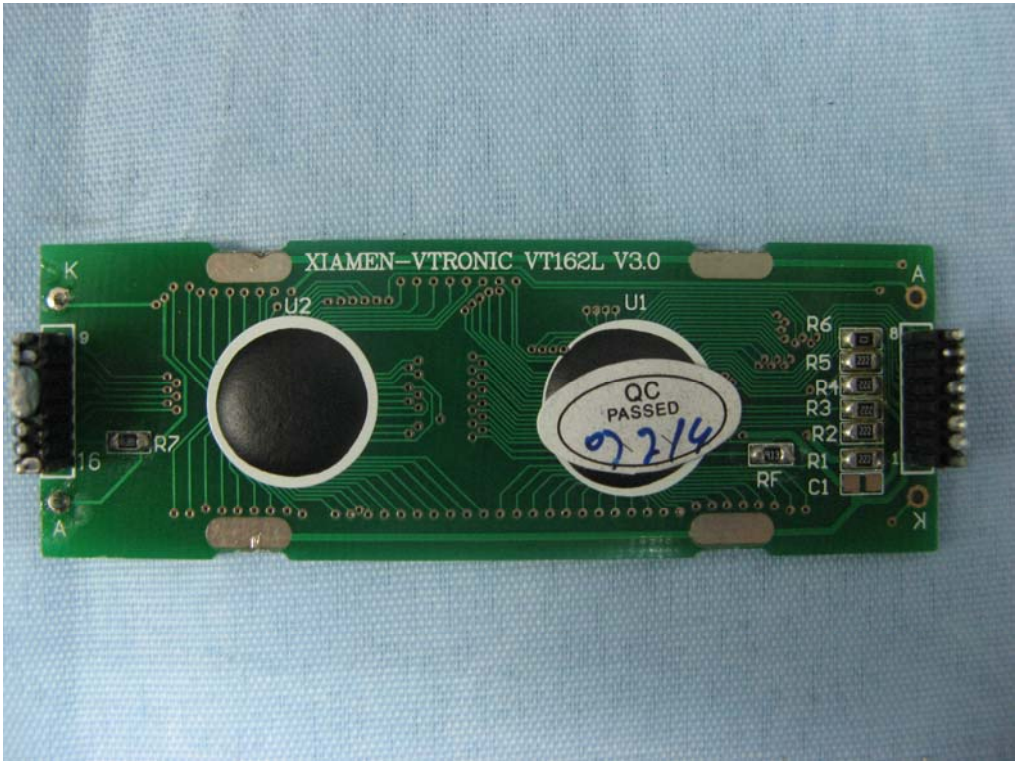

INTERNAL VIEW OF SAMPLE – 4

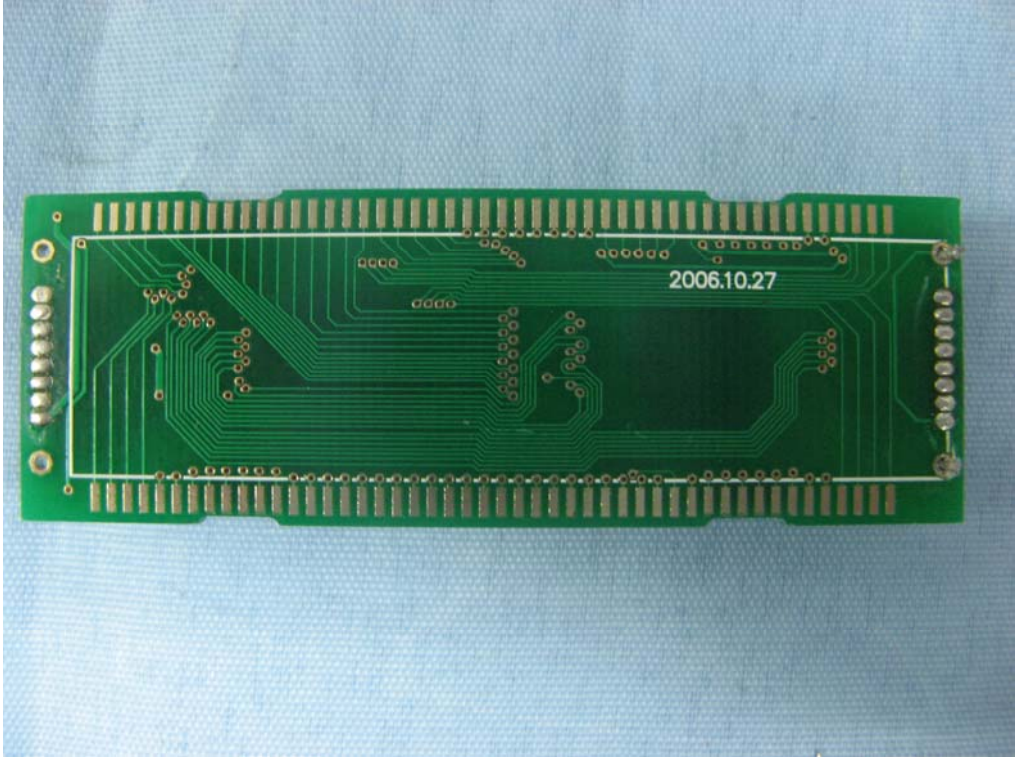

INTERNAL VIEW OF SAMPLE – 5

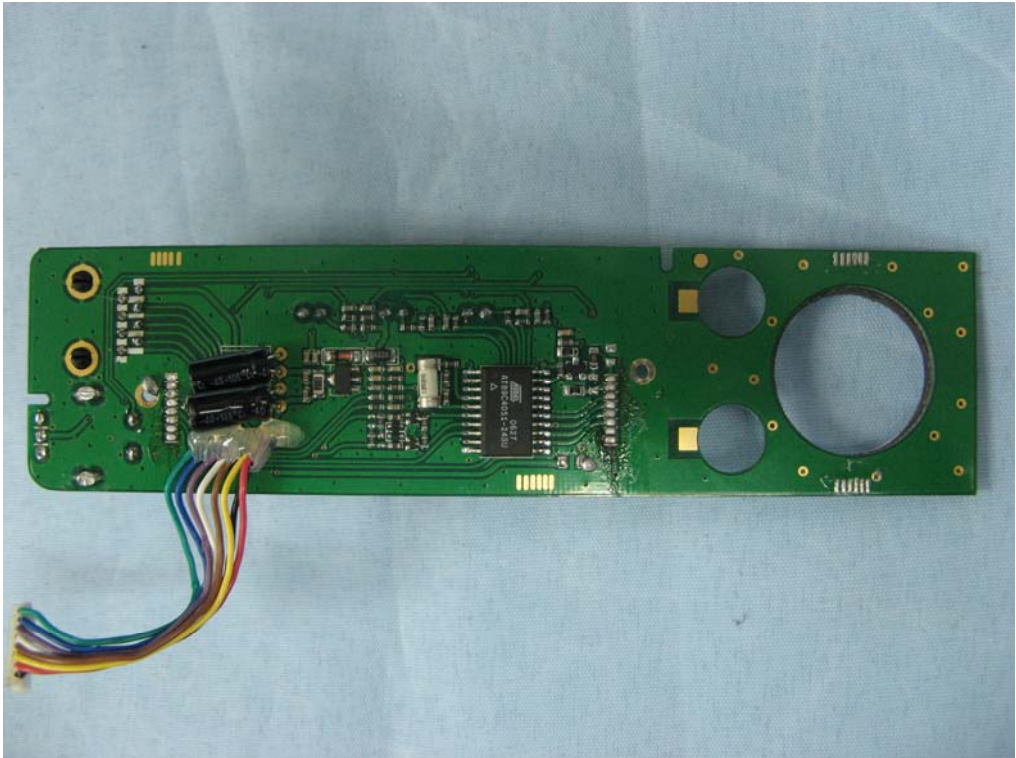

INTERNAL VIEW OF SAMPLE – 6

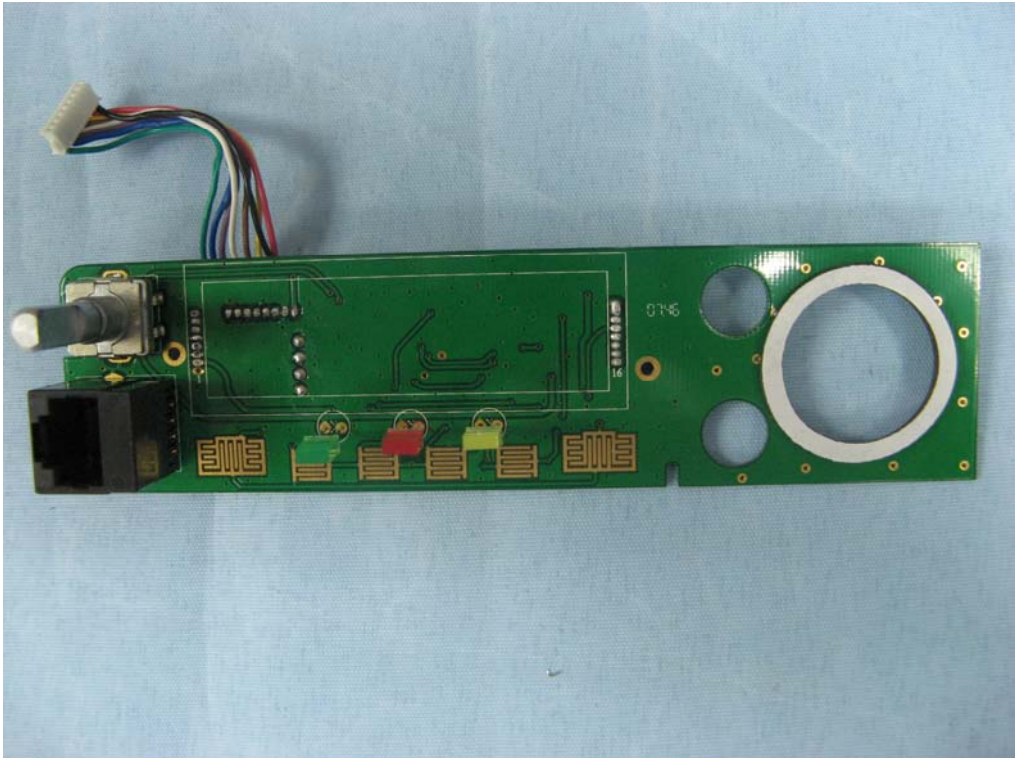

---END OF REPORT---