SAR Test Report

Report No.:AGC00589150304FH01

FCC ID : T4KD868

APPLICATION PURPOSE : Original Equipment

Product Designation : DIGITAL RADIO

Brand Name : N/A

Model Name : D868, D848, D838, D828, D818, D808, 868, 848, 838, 828.

Client : Qixiang Electron Science & Technology Co., Ltd. Quanzhou

Date of Issue : Apr. 23,2016

STANDARD(S) : IEEE Std. 1528:2013
FCC 47CFR § 2.1093
IEEE/ANSI C95.1:1992

REPORT VERSION : V1.0

Attestation of Global Compliance(Shenzhen) Co., Ltd.



CAUTION:

This report shall not be reproduced except in full without the written permission of the test laboratory and shall not be quoted out of context.



Report Revise Record

Report Version	Revise Time	Issued Date	Valid Version	Notes
V1.0	/	Apr. 23,2016	Valid	Original Report

Test Report Certification

Applicant Name	Qixiang Electron Science & Technology Co., Ltd. Quanzhou
Applicant Address	Qixiang Building, Tangxi Industrial Zone, Luojiang District, Quanzhou, Fujian China
Manufacturer Name	Qixiang Electron Science & Technology Co., Ltd. Quanzhou
Manufacturer Address	Qixiang Building, Tangxi Industrial Zone, Luojiang District, Quanzhou, Fujian China
Product Name	DIGITAL RADIO
Brand Name	N/A
Model Name	D868, D848, D838, D828, D818, D808, 868, 848, 838, 828.
Difference Description	All the same, except for the model name and appearance(The concave-convex grain of top view). The test model is D868.
EUT Voltage	DC7.4V by battery
Applicable Standard	IEEE Std. 1528:2013 FCC 47CFR § 2.1093 IEEE/ANSI C95.1:1992
Test Date	Apr. 29,2015 to Apr. 17,2016
Performed Location	Attestation of Global Compliance (Shenzhen)Co., Ltd. 2F, Building 2, No.1-No.4, Chaxi Sanwei Technical Industrial Park, Gushu, Xixiang Street, Bao'an District, Shenzhen, China
Report Template	AGCRT-US-PPT/SAR (2015-04-01)

Bobby Wang

Tested By _____
Bobby Wang Apr. 23,2016

Angela Li

Checked By _____
Angela Li Apr. 23,2016

Solger Zhang

Authorized By _____
Solger Zhang Apr. 23,2016

TABLE OF CONTENTS

1. SUMMARY OF MAXIMUM SAR VALUE	5
2. GENERAL INFORMATION	6
2.1. EUT Description	6
2.2. Test Procedure	7
2.3. Test Environment.....	7
3. SAR MEASUREMENT SYSTEM	8
3.1. Specific Absorption Rate (SAR)	8
3.2. SAR Measurement Procedure	9
3.3. DASY SAR System Description.....	10
3.4. DASY5 E-Field Probe.....	12
3.5. Isotropic E-Field Probe Specification.....	12
3.6. Robot	12
3.7. Light Beam Unit.....	13
3.8. Device Holder.....	13
3.9. Measurement Server.....	13
3.10. ELI4 Phantom	14
4. TISSUE SIMULATING LIQUID	15
4.1. The composition of the tissue simulating liquid	15
4.2. Tissue Calibration Result	16
4.3. Tissue Dielectric Parameters for Head and Body Phantoms.....	18
5. SAR MEASUREMENT PROCEDURE	19
5.1. SAR System Check Procedures	19
5.2. SAR System Check.....	20
6. EUT TEST POSITION	22
6.1. Body Worn Position	22
7. SAR EXPOSURE LIMITS.....	23
8. TEST EQUIPMENT LIST.....	24
9. MEASUREMENT UNCERTAINTY	26
10. CONDUCTED POWER MEASUREMENT	31
11. TEST RESULTS	33
11.1. SAR Test Results Summary	33
APPENDIX A. SAR SYSTEM CHECK DATA	36
APPENDIX B. SAR MEASUREMENT DATA	42
APPENDIX C. TEST SETUP PHOTOGRAPHS &EUT PHOTOGRAPHS.....	53
APPENDIX D. PROBE CALIBRATION DATA	62
APPENDIX E. DAE CALIBRATION DATA	84
APPENDIX F. DIPOLE CALIBRATION DATA	92

1. SUMMARY OF MAXIMUM SAR VALUE

The maximum results of Specific Absorption Rate (SAR) found during testing for EUT are as follows:
Highest Report tested & scaled SAR Summary (with 50% duty cycle)

Exposure Position	Mod.	Separation	Highest Reported SAR(W/Kg) (5W)
Face Up (with 25mm separation)	Digital	12.5 KHz	2.746
	Analog	12.5 KHz	4.343
Back Touch	Digital	12.5 KHz	3.477
	Analog	12.5 KHz	4.631

This device is compliance with Specific Absorption Rate (SAR) for Occupational / Controlled Exposure Environment limits (8.0W/Kg) specified in IEEE Std. 1528:2013; FCC 47CFR § 2.1093; IEEE/ANSI C95.1:1992 and the following specific FCC Test Procedures:

KDB 447498 D01 General RF Exposure Guidance v06

KDB 865664 D01 SAR Measurement 100MHz to 6GHz v01r04

KDB 643646 D01 SAR Test for PTT Radios V01r03

2. GENERAL INFORMATION

2.1. EUT Description

General Information	
Product Name	DIGITAL RADIO
Test Model	D868
Hardware Version	N/A
Software Version	N/A
Exposure Category:	Occupational/Controlled Exposure
Device Category	FM&4FSK UHF Portable Transceiver
Modulation Type	FM, 4FSK
TX Frequency Range	400-480MHz
Rated Power	5W&1W (It was fixed by the manufacturer, any individual can't arbitrarily change it)
Max. Average Power	Analog: 36.88dBm(5W); 29.93 dBm (1W) Digital: 36.91 dBm(5W); 29.94 dBm (1W)
Channel Spacing	12.5KHz (Analog), 12.5KHz(Digital)
Antenna Type	Detachable
Antenna Gain	2.15dBi
Body-Worn Accessories:	Belt Clip with headset
Face-Head Accessories:	None
Battery Type (s) Tested:	DC 7.4V, 2000mAh (by battery)

Product	Type
	<input checked="" type="checkbox"/> Production unit <input type="checkbox"/> Identical Prototype

2.2. Test Procedure

1	Setup the EUT for two typical configuration of hold to face and body worn individually
2	Power on the EUT and make it continuously transmitting on required operating channel
3	Make sure the EUT work normally during the test

2.3. Test Environment

Ambient conditions in the laboratory:

Items	Required	Actual
Temperature (°C)	18-25	21 ± 2
Humidity (%RH)	30-70	56

3. SAR MEASUREMENT SYSTEM

3.1. Specific Absorption Rate (SAR)

SAR is related to the rate at which energy is absorbed per unit mass in object exposed to a radio field. The SAR distribution in a biological body is complicated and is usually carried out by experimental techniques or numerical modeling. The standard recommends limits for two tiers of groups, occupational/controlled and occupational/uncontrolled, based on a person's awareness and ability to exercise control over his or her exposure. In general, occupational/controlled exposure limits are higher than the limits for general population/uncontrolled.

The SAR definition is the time derivative (rate) of the incremental energy (dW) absorbed by (dissipated in) an incremental mass (dm) contained in a volume (dv) of given mass density (ρ). The equation description is as below:

$$SAR = \frac{d}{dt} \left(\frac{dW}{dm} \right) = \frac{d}{dt} \left(\frac{dW}{\rho dV} \right)$$

SAR is expressed in units of Watts per kilogram (W/Kg)

SAR can be obtained using either of the following equations:

$$SAR = \frac{\sigma E^2}{\rho}$$

$$SAR = c_h \left. \frac{dT}{dt} \right|_{t=0}$$

Where

SAR	is the specific absorption rate in watts per kilogram;
E	is the r.m.s. value of the electric field strength in the tissue in volts per meter;
σ	is the conductivity of the tissue in siemens per metre;
ρ	is the density of the tissue in kilograms per cubic metre;
c_h	is the heat capacity of the tissue in joules per kilogram and Kelvin;

$\left. \frac{dT}{dt} \right|_{t=0}$ is the initial time derivative of temperature in the tissue in kelvins per second

3.2. SAR Measurement Procedure

The EUT is set to transmit at the required power in line with product specification, at each frequency relating to the LOW, MID, and HIGH channel settings.

Pre-scans are made on the device to establish the location for the transmitting antenna, using a large area scan in either air or tissue simulation fluid.

The EUT is placed against the Flat Phantom where the maximum area scan dimensions are larger than the physical size of the resonating antenna. When the scan size is not large enough to cover the peak SAR distribution, it is modified by either extending the area scan size in both the X and Y directions, or the device is shifted within the predefined area.

The area scan is then run to establish the peak SAR location (interpolated resolution set at 1mm^2) which is then used to orient the center of the zoom scan. The zoom scan is then executed and the 1g and 10g averages are derived from the zoom scan volume (interpolated resolution set at 1mm^3).

When multiple peak SAR location were found during the same configuration or test mode, Zoom scan shall performed on each peak SAR location, only the peak point with maximum SAR value will be reported for the configuration or test mode.

3.3. DASY SAR System Description

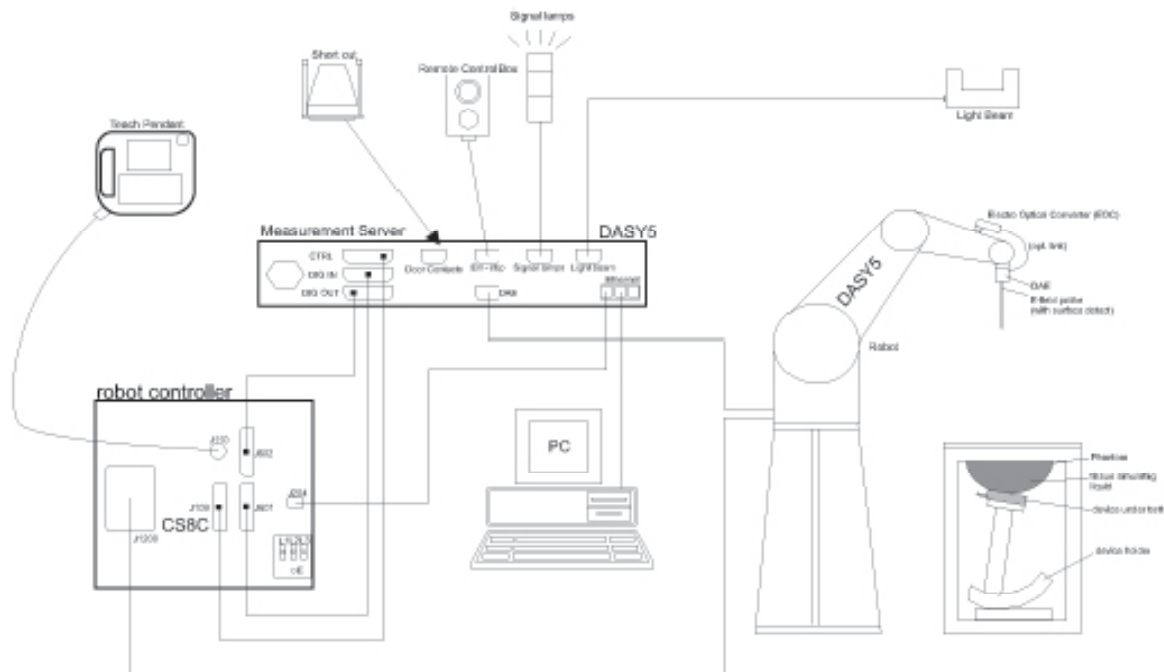

DASY5 System Configurations

The DASY system for performing compliance tests consists of the following items:

- (1) A standard high precision 6-axis robot with controller, teach pendant and software.
- (2) A data acquisition electronics (DAE) which attached to the robot arm extension. The DAE consist of a highly sensitive electrometer-grade preamplifier with auto-zeroing, a channel and gain-switching multiplexer, a fast 16 bit AD-converter and a command decoder with a control logic unit.
 The mechanical probe mounting device includes two different sensor systems frontal and side-ways probe contacts. They are used for mechanical surface detection and probe collision detection.
- (3) The Electro-optical converter (EOC) performs the conversion from optical to electrical signals for the digital Communication to the DAE. To use optical surface detection, a special version of the EOC is required. The EOC signal is transmitted to the measurement server..
- (4) A Light Beam used is for probe alignment. This improves the (absolute) accuracy of the probe positioning.
- (5) A computer running WinXP .
- (6) DASY software.
- (7) Remote control and teach pendant as well as additional circuitry for robot safety such as warning lamps, etc.
- (8) Phantoms, device holders and other accessories according to the targeted measurement.

3.3.1. Applications

Predefined procedures and evaluations for automated compliance testing with all worldwide standards, e.g., IEEE 1528-2013, Reference KDB files and others.

3.3.2. Area Scans

Area scans are defined prior to the measurement process being executed with a user defined variable spacing between each measurement point (integral) allowing low uncertainty measurements to be conducted. Scans defined for FCC applications utilize a 10mm² step integral, with 1mm interpolation used to locate the peak SAR area used for zoom scan assessments. When an Area Scan has measured all reachable points, it computes the field maxima found in the scanned area, within a range of the global maximum. The range (in dB) is specified in the standards for compliance testing. For example, a 2 dB range is required in IEEE 1528-2013, Reference KDB files standards, whereby 3 dB is a requirement when compliance is assessed in accordance with the ARIB standard (Japan).

3.3.3. Zoom Scan (Cube Scan Averaging)

Zoom Scans are used to assess the peak spatial SAR values within a cubic averaging volume containing 1 g and 10 g of simulated tissue. A density of 1000 kg/m³ is used to represent the head and body tissue density and not the phantom liquid density, in order to be consistent with the definition of the liquid dielectric properties, i.e. the side length of the 1 g cube is 10mm, with the side length of the 10 g cube 21,5mm. The zoom scan integer steps can be user defined so as to reduce uncertainty, but normal practice for typical test applications utilize a physical step of 7x7x7 (5mmx5mmx5mm) providing a volume of 30mm in the X & Y axis, and 30mm in the Z axis.

3.3.4. Uncertainty of Inter-/Extrapolation and Averaging

In order to evaluate the uncertainty of the interpolation, extrapolation and averaged SAR calculation algorithms of the Post processor, DASY allows the generation of measurement grids which are artificially predefined by analytically based test functions. Therefore, the grids of area scans and zoom scans can be filled with uncertainty test data, according to the SAR benchmark functions of IEEE 1528. The three analytical functions shown in equations as below are used to describe the possible range of the expected SAR distributions for the tested handsets. The field gradients are covered by the spatially flat distribution f1, the spatially steep distribution f3 and f2 accounts for H-field cancellation on the phantom/tissue surface.

$$f_1(x, y, z) = A e^{-\frac{z}{2a}} \cos^2 \left(\frac{\pi}{2} \frac{\sqrt{x'^2 + y'^2}}{5a} \right)$$

$$f_2(x, y, z) = A e^{-\frac{z}{a}} \frac{a^2}{a^2 + x'^2} \left(3 - e^{-\frac{2z}{a}} \right) \cos^2 \left(\frac{\pi}{2} \frac{y'}{3a} \right)$$

$$f_3(x, y, z) = A \frac{a^2}{\frac{a^2}{4} + x'^2 + y'^2} \left(e^{-\frac{2z}{a}} + \frac{a^2}{2(a + 2z)^2} \right)$$

3.4. DASYS E-Field Probe

The SAR measurement is conducted with the dosimetric probe manufactured by SPEAG. The probe is specially designed and calibrated for use in liquid with high permittivity. The dosimetric probe has special calibration in liquid at different frequency. SPEAG conducts the probe calibration in compliance with international and national standards (e.g. IEEE 1528, Reference KDB files, etc.). The calibration data are in Appendix D.

3.5. Isotropic E-Field Probe Specification

Model	ES3DV3	
Manufacture	SPEAG	
frequency	0.03GHz-3GHz Linearity:±0.2dB(30MHz-3GHz)	
Dynamic Range	0.01W/Kg-100W/Kg Linearity:±0.2dB	
Dimensions	Overall length:337mm Tip diameter:4mm Typical distance from probe tip to dipole centers:2mm	
Application	High precision dosimetric measurements in any exposure scenario (e.g., very strong gradient fields). Only probe which enables compliance testing for frequencies up to 6 GHz with precision of better 30%.	

3.6. Robot

The DASYS system uses the high precision robots (DASY5:TX60) type from Staubli SA (France). For the 6-axis controller system, the robot controller version from is used.

The XL robot series have many features that are important for our application:

- High precision (repeatability 0.02 mm)
- High reliability (industrial design)
- Jerk-free straight movements
- Low ELF interference (the closed metallic construction shields against motor control fields)
- 6-axis controller



3.7. Light Beam Unit

The light beam switch allows automatic “tooling” of the probe. During the process, the actual position of the probe tip with respect to the robot arm is measured, as well as the probe length and the horizontal probe offset. The software then corrects all movements, such that the robot coordinates are valid for the probe tip.

The repeatability of this process is better than 0.1 mm. If a position has been taught with an aligned probe, the same position will be reached with another aligned probe within 0.1 mm, even if the other probe has different dimensions. During probe rotations, the probe tip will keep its actual position.



3.8. Device Holder

The DASY device holder is designed to cope with different positions given in the standard. It has two scales for the device rotation (with respect to the body axis) and the device inclination (with respect to the line between the ear reference points). The rotation center for both scales is the ear reference point (EPR).

Thus the device needs no repositioning when changing the angles.

The DASY device holder has been made out of low-loss POM material having the following dielectric parameters: relative permittivity $\epsilon=3$ and loss tangent $\delta = 0.02$. The amount of dielectric material has been reduced in the closest vicinity of the device, since measurements have suggested that the influence of the clamp on the test results could thus be lowered.



3.9. Measurement Server

The measurement server is based on a PC/104 CPU board with CPU (DASY5: 400 MHz, Intel Celeron), chip-disk (DASY5: 128MB), RAM (DASY5: 128MB). The necessary circuits for communication with the DAE electronic box, as well as the 16 bit AD converter system for optical detection and digital I/O interface are contained on the DAYS I/O board, which is directly connected to the PC/104 bus of the CPU board.

The measurement server performs all the real-time data evaluation for field measurements and surface detection, controls robot movements and handles safety operations.



3.10. ELI4 Phantom

Flat phantom a fiberglass shell flat phantom with 2mm+/- 0.2 mm shell thickness. It has only one measurement area for Flat phantom

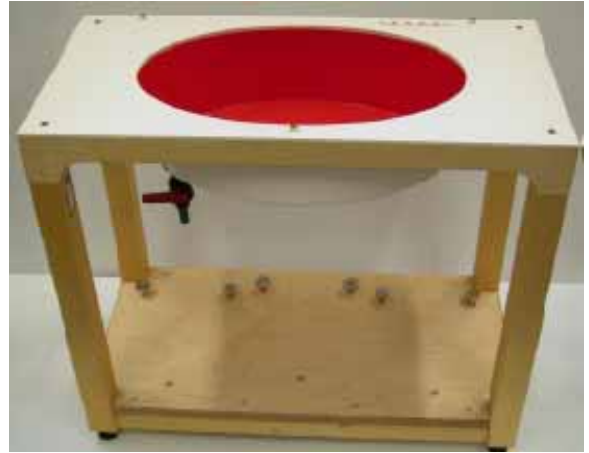

The bottom plate contains three pair of bolts for locking the device holder. The device holder positions are adjusted to the standard measurement positions in the three sections. A white cover is provided to tap the phantom during off-periods to prevent water evaporation and changes in the liquid parameters. On the phantom top, three reference markers are provided to identify the phantom position with respect to the robot.

4. TISSUE SIMULATING LIQUID

For SAR measurement of the field distribution inside the phantom, the phantom must be filled with homogeneous tissue simulating liquid to a depth of at least 15cm. For head SAR testing the liquid height from the ear reference point (ERP) of the phantom to the liquid top surface is larger than 15cm For body SAR testing, the liquid height from the center of the flat phantom to the liquid top surface is larger than 15cm. The nominal dielectric values of the tissue simulating liquids in the phantom and the tolerance of 5% are listed in 4.2

4.1. The composition of the tissue simulating liquid

Frequency (MHz) \ Ingredient (% Weight)	Water	Nacl	Sugar	HEC	Bactericide	DGBE	1,2-Propanediol	Triton X-100
450-Head	35%	3%	--	--	--	--	62%	--
450-Body	50%	2%	--	--	--	--	48%	--

4.2. Tissue Calibration Result

The dielectric parameters of the liquids were verified prior to the SAR evaluation using DASY5 Dielectric Probe Kit and R&S Network Analyzer ZVL6 .

Tissue Stimulant Measurement for 450MHz					
	Fr. (MHz)	Dielectric Parameters ($\pm 5\%$)		Tissue Temp [$^{\circ}\text{C}$]	Test time
		ϵ_r 43.50(41.325 to 45.675)	δ [s/m] 0.87(0.8265 to 0.9135)		
Head	400.025	44.46	0.84	21.9	Apr. 29,2015
	416.025	44.05	0.85		
	432.025	43.76	0.86		
	448.025	43.21	0.86		
	450.000	43.00	0.87		
	464.025	42.94	0.89		
	479.975	42.50	0.90		
	Fr. (MHz)	Dielectric Parameters ($\pm 5\%$)		Tissue Temp [$^{\circ}\text{C}$]	Test time
		ϵ_r 56.7(53.865 to 59.535)	δ [s/m] 0.94 (0.893 to 0.987)		
Body	400.025	58.20	0.91	22	Apr. 29,2015
	416.025	58.01	0.93		
	432.025	57.84	0.94		
	448.025	57.32	0.95		
	450.000	56.70	0.95		
	464.025	56.25	0.96		
	479.975	56.03	0.97		

Tissue Stimulant Measurement for 450MHz					
	Fr. (MHz)	Dielectric Parameters ($\pm 5\%$)		Tissue Temp [$^{\circ}\text{C}$]	Test time
		ϵ_r 43.50(41.325 to 45.675)	δ [s/m] 0.87(0.8265 to 0.9135)		
Head	400.025	44.24	0.84	21.8	Apr. 30,2015
	416.025	43.96	0.86		
	432.025	43.15	0.87		
	448.025	43.00	0.87		
	450.000	42.83	0.89		
	464.025	42.71	0.90		
	479.975	42.16	0.91		
	Fr. (MHz)	Dielectric Parameters ($\pm 5\%$)		Tissue Temp [$^{\circ}\text{C}$]	Test time
		ϵ_r 56.7(53.865 to 59.535)	δ [s/m] 0.94 (0.893 to 0.987)		
Body	400.025	58.62	0.91	22.1	Apr. 30,2015
	416.025	58.00	0.91		
	432.025	57.64	0.93		
	448.025	56.78	0.94		
	450.000	56.03	0.96		
	464.025	55.43	0.97		
	479.975	54.28	0.97		

Tissue Stimulant Measurement for 450MHz					
	Fr. (MHz)	Dielectric Parameters ($\pm 5\%$)		Tissue Temp [$^{\circ}\text{C}$]	Test time
		ϵ_r 43.50(41.325 to 45.675)	δ [s/m] 0.87(0.8265 to 0.9135)		
Head	400.025	44.90	0.84	21.4	Apr.17,2016
	416.025	44.37	0.85		
	432.025	44.12	0.85		
	448.025	43.72	0.87		
	450.000	43.61	0.88		
	464.025	43.07	0.90		
	479.975	42.84	0.90		
	Fr. (MHz)	Dielectric Parameters ($\pm 5\%$)		Tissue Temp [$^{\circ}\text{C}$]	Test time
		ϵ_r 56.7(53.865 to 59.535)	δ [s/m] 0.94 (0.893 to 0.987)		
Body	400.025	58.06	0.92	21.6	Apr.17,2016
	416.025	58.00	0.93		
	432.025	57.57	0.93		
	448.025	57.26	0.95		
	450.000	56.81	0.96		
	464.025	56.35	0.97		
	479.975	56.11	0.97		

4.3. Tissue Dielectric Parameters for Head and Body Phantoms

The head tissue dielectric parameters recommended by the IEEE SCC-34/SC-2 in P1528 have been incorporated in the following table. These head parameters are derived from planar layer models simulating the highest expected SAR for the dielectric properties and tissue thickness variations in a human head. Other head and body tissue parameters that have not been specified in P1528 are derived from the tissue dielectric parameters computed from the 4-Cole-Cole equations described in Reference [12] and extrapolated according to the head parameters specified in P1528.

Target Frequency (MHz)	head		body	
	ϵ_r	σ (S/m)	ϵ_r	σ (S/m)
150	52.3	0.76	61.9	0.80
300	45.3	0.87	58.2	0.92
450	43.5	0.87	56.7	0.94
835	41.5	0.90	55.2	0.97
900	41.5	0.97	55.0	1.05
915	41.5	0.98	55.0	1.06
1450	40.5	1.20	54.0	1.30
1610	40.3	1.29	53.8	1.40
1800 – 2000	40.0	1.40	53.3	1.52
2450	39.2	1.80	52.7	1.95
3000	38.5	2.40	51.6	2.73

(ϵ_r = relative permittivity, σ = conductivity and $\rho = 1000$ kg/m³)

5. SAR MEASUREMENT PROCEDURE

5.1. SAR System Check Procedures

Each DASY5 system is equipped with one or more system validation kits. These units, together with the predefined measurement procedures within the DASY5 software, enable the user to conduct the system performance check and system validation. System kit includes a dipole, and dipole device holder.

The system check verifies that the system operates within its specifications. It's performed daily or before every SAR measurement. The system check uses normal SAR measurement in the flat section of the phantom with a matched dipole at a specified distance. The system check setup is shown as below.

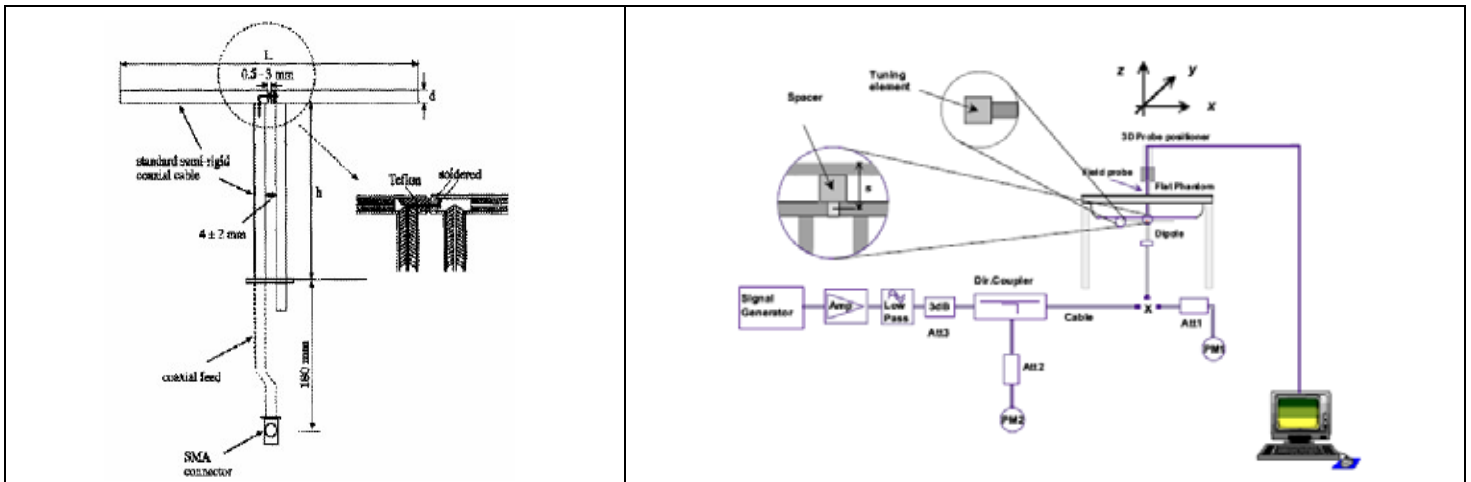

5.2. SAR System Check

5.2.1. Dipoles

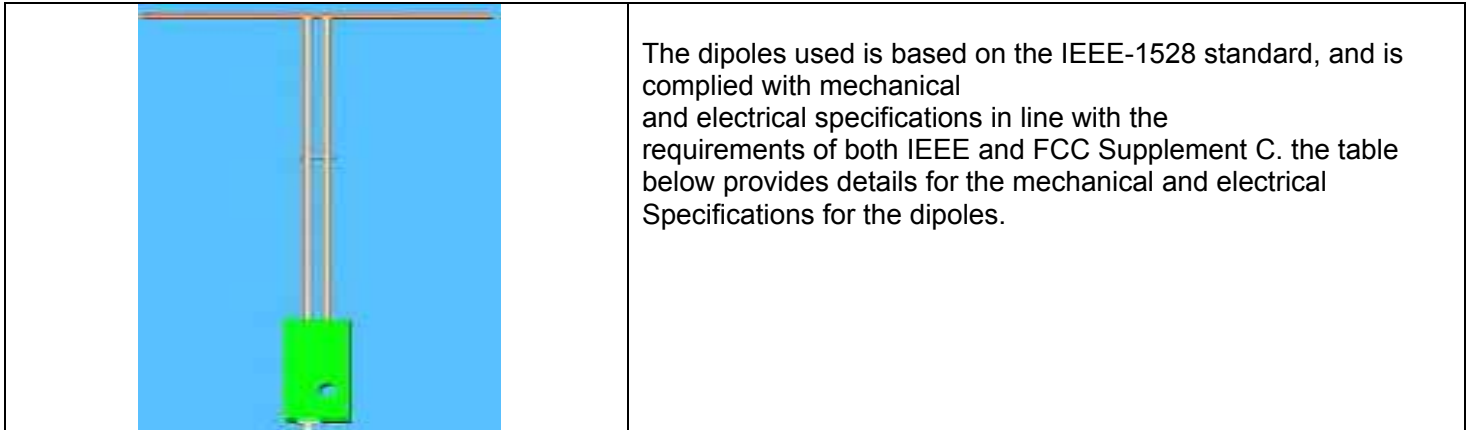

Frequency	L (mm)	h (mm)	d (mm)
450MHz	290	166.7	6.35

5.2.2. System Check Result

System Performance Check at 450MHz								
Validation Kit: SN 46/11DIP 0G450-184								
Frequency [MHz]	Target Value(W/Kg)		Reference Result ($\pm 10\%$)		Normalized to 1W(W/Kg)		Tissue Temp. [°C]	Test time
	1g	10g	1g	10g	1g	10g		
450 Head	4.91	3.13	4.419-5.401	2.817-3.443	4.726	3.304	21.9	Apr. 29,2015
450 Body	5.07	3.25	4.563-5.577	2.925-3.575	4.615	3.177	22.0	Apr. 29,2015
450 Head	4.91	3.13	4.419-5.401	2.817-3.443	4.877	3.376	21.8	Apr. 30,2015
450 Body	5.07	3.25	4.563-5.577	2.925-3.575	4.917	3.408	22.1	Apr. 30,2015
450 Head	4.91	3.13	4.419-5.401	2.817-3.443	4.766	3.249	21.4	Apr. 17,2016
450 Body	5.07	3.25	4.563-5.577	2.925-3.575	4.726	3.273	21.6	Apr. 17,2016

Note:

(1) We use a CW signal of 21dBm for system check, and then all SAR value are normalized to 1W forward power. The result must be within $\pm 10\%$ of target value.

(2) Tested normalized SAR (W/kg) = Tested SAR (W/kg) $\times [1000 / 10^{2.1}]$

6. EUT TEST POSITION

This EUT was tested in **Front Face and Rear Face**.

6.1. Body Worn Position

- (1) To position the EUT parallel to the phantom surface.
- (2) To adjust the EUT parallel to the flat phantom.
- (3) To adjust the distance between the EUT surface and the flat phantom to **25mm** while used in front of face, and body back touch with belt clip.

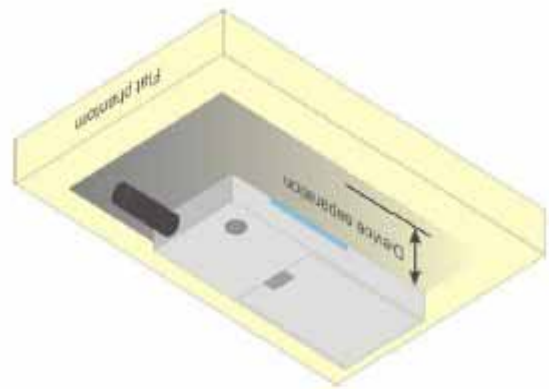
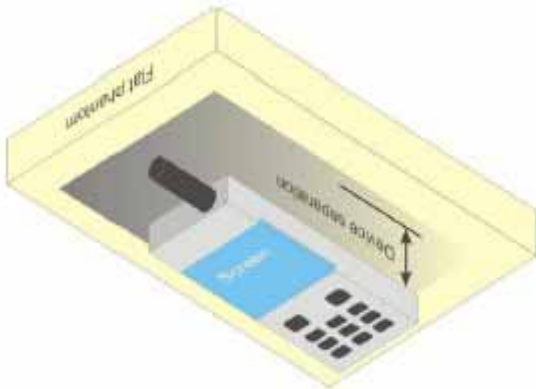

7. SAR EXPOSURE LIMITS

SAR assessments have been made in line with the requirements of IEEE-1528, FCC Supplement C, and comply with ANSI/IEEE C95.1-1992 “Controlled Exposure Environment” limits. These limits apply to a location which is deemed as “Controlled Exposure Environment” which can be described as a situation where adults are exposed under known conditions and are trained to be aware of potential risk and to take appropriate precautions.

Limits for Occupational / Controlled Exposure Environment

Type Exposure Limits	Occupational / Controlled Exposure Environment(W/Kg)
Spatial Average SAR (whole body)	8.0

8. TEST EQUIPMENT LIST

Equipment description	Manufacturer/ Model	Identification No.	Current calibration date	Next calibration date
Stäubli Robot	Stäubli-TX60	F13/5Q2UD1/A/01	N/A	N/A
TISSUE Probe	SATIMO	SN 45/11 OCPG45	11/14/2013	11/13/2015
Robot Controller	Stäubli-CS8	139522	N/A	N/A
E-Field Probe	ES3DV3	SN:3337	09/05/2014	09/04/2015
ELI4 Phantom	ELI V5.0	1210	N/A	N/A
Device Holder	Speag-SD 000 H01 KA	SD 000 H01 KA	N/A	N/A
DAE4	Speag-SD 000 D04 BM	1398	3/11/2015	3/10/2016
SAR Software	Speag-DASY5	DASY52.8	N/A	N/A
Liquid	SATIMO Head 450MHz	-	N/A	N/A
Liquid	SATIMO Body 450MHz	-	N/A	N/A
Radio Communication Tester	R&S-CMU200	069Y7-158-13-712	02/17/2014	02/16/2015
Dipole	SATIMO SID450	SN46/11 DIP 0G450-184	11/14/2013	11/13/2016
Signal Generator	Agilent-E4438C	MY44260051	03/06/2015	03/05/2016
Power Sensor	NRP-Z23	US38261498	03/06/2015	03/05/2016
Spectrum Analyzer E4440	Agilent	US41421290	07/25/2014	07/24/2015
Network Analyzer	Rhode & Schwarz ZVL6	SN100132	03/06/2015	03/05/2016
Attenuator	Warison /WATT-6SR1211	N/A	N/A	N/A
Attenuator	Mini-circuits / VAT-10+	N/A	N/A	N/A
Amplifier	EM30180	SN060552	03/06/2015	03/05/2016
Directional Couple	Werlatone/ C5571-10	SN99463	07/30/2014	07/29/2015
Power Sensor	NRP-Z21	1137.6000.02	10/22/2014	10/21/2015
Power Viewer	R&S	V2.3.1.0	N/A	N/A

Note: Per KDB 865664 Dipole SAR Validation Verification, AGC Lab has adopted 3 years calibration intervals. On annual basis, every measurement dipole has been evaluated and is in compliance with the following criteria:

1. There is no physical damage on the dipole;
2. System validation with specific dipole is within 10% of calibrated value;
3. Return-loss is within 20% of calibrated measurement;
4. Impedance is within 5Ω of calibrated measurement.

Equipment description	Manufacturer/ Model	Identification No.	Current calibration date	Next calibration date
Stäubli Robot	Stäubli-TX60	F13/5Q2UD1/A/01	N/A	N/A
Robot Controller	Stäubli-CS8	139522	N/A	N/A
TISSUE Probe	SATIMO	SN 45/11 OCPG45	12/02/2015	12/01/2016
E-Field Probe	Speag- ES3DV3	SN:3337	10/01/2015	09/30/2016
EL4 Phantom	ELI V5.0	1210	N/A	N/A
Device Holder	Speag-SD 000 H01 KA	SD 000 H01 KA	N/A	N/A
DAE4	Speag-SD 000 D04 BM	1398	02/02/2016	02/01/2017
SAR Software	Speag-DASY5	DASY52.8	N/A	N/A
Liquid	SATIMO	-	N/A	N/A
Dipole	SATIMO SID450	SN46/11 DIP 0G450-184	11/14/2013	11/13/2016
Signal Generator	Agilent-E4438C	US41461365	02/29/2016	02/28/2017
Spectrum Analyzer E4440	Agilent	US41421290	07/23/2015	07/22/2016
Network Analyzer	Rhode & Schwarz ZVL6	SN100132	03/01/2016	02/28/2017
Attenuator	Warison /WATT-6SR1211	N/A	N/A	N/A
Attenuator	Mini-circuits / VAT-10+	N/A	N/A	N/A
Amplifier	EM30180	SN060552	03/04/2016	03/03/2017
Directional Couple	Werlatone/ C5571-10	SN99463	07/29/2015	07/28/2016
Directional Couple	Werlatone/ C6026-10	SN99482	07/29/2015	07/28/2016
Power Sensor	NRP-Z21	1137.6000.02	10/20/2015	10/19/2016
Power Sensor	NRP-Z23	US38261498	03/01/2016	02/28/2017
Power Viewer	R&S	V2.3.1.0	N/A	N/A

Note: Per KDB 865664 Dipole SAR Validation Verification, AGC Lab has adopted 3 years calibration intervals. On annual basis, every measurement dipole has been evaluated and is in compliance with the following criteria:

1. There is no physical damage on the dipole;
2. System validation with specific dipole is within 10% of calibrated value;
3. Return-loss is within 20% of calibrated measurement;
4. Impedance is within 5Ω of calibrated measurement.

9. MEASUREMENT UNCERTAINTY

The component of uncertainty may generally be categorized according to the methods used to evaluate them. The evaluation of uncertainty by the statistical analysis of a series of observations is termed a Type A evaluation of uncertainty. The evaluation of uncertainty by means other than the statistical analysis of a series of observations is termed a Type B evaluation of uncertainty. Each component of uncertainty, however evaluated, is represented by an estimated standard deviation, termed standard uncertainty, which is determined by the positive square root of the estimated variance.

A Type A evaluation of standard uncertainty may be based on any valid statistical method for treating data. This includes calculating the standard deviation of the mean of a series of independent observations; using the method of least squares to fit a curve to the data in order to estimate the parameter of the curve and their standard deviations; or carrying out an analysis of variance in order to identify and quantify random effects in certain kinds of measurement.

A type B evaluation of standard uncertainty is typically based on scientific judgment using all of the relevant information available. These may include previous measurement data, experience, and knowledge of the behavior and properties of relevant materials and instruments, manufacture’s specification, data provided in calibration reports and uncertainties assigned to reference data taken from handbooks. Broadly speaking, the uncertainty is either obtained from an outdoor source or obtained from an assumed distribution, such as the normal distribution, rectangular or triangular distributions indicated in Table as follow.

Uncertainty Distributions	Normal	Rectangular	Triangular	U-Shape
Multi-plying Factor(a)	1/k(b)	$1/\sqrt{3}$	$1/\sqrt{6}$	$1/\sqrt{2}$

(a) Standard uncertainty is determined as the product of the multiplying factor and the estimated range of variations in the measured quantity

(b) κ is the coverage factor

Table 13.1 Standard Uncertainty for Assumed Distribution (above table)

The combined standard uncertainty of the measurement result represents the estimated standard deviation of the result. It is obtained by combining the individual standard uncertainties of both Type A and Type B evaluation using the usual “root-sum-squares” (RSS) methods of combining standard deviations by taking the positive square root of the estimated variances.

Expanded uncertainty is a measure of uncertainty that defines an interval about the measurement result within which the measured value is confidently believed to lie. It is obtained by multiplying the combined standard uncertainty by a coverage factor. Typically, the coverage factor ranges from 2 to 3. Using a coverage factor allows the true value of a measured quantity to be specified with a defined probability within the specified uncertainty range. For purpose of this document, a coverage factor two is used, which corresponds to confidence interval of about 95 %. The DASY uncertainty Budget is shown in the following tables.

DAYS5 Measurement Uncertainty							
Measurement uncertainty for 150 MHz to 450MHz averaged over 1 gram / 10 gram.							
Error Description	Uncertainty value($\pm 10\%$)	Probability Distribution	Divisor	(Ci) 1g	(Ci) 10g	Standard Uncertainty (1g)	Standard Uncertainty (10g)
Measurement System							
Probe Calibration	6.65	Normal	1	1	1	6.65	6.65
Axial Isotropy	0.25	Rectangular	$\sqrt{3}$	1	1	0.14	0.14
Hemispherical Isotropy	1.3	Rectangular	$\sqrt{3}$	1	1	0.75	0.75
Linearity	0.3	Rectangular	$\sqrt{3}$	1	1	0.17	0.17
Probe Modulation Response	1.9	Rectangular	$\sqrt{3}$	1	1	1.10	1.10
System Detection Limits	0.9	Rectangular	$\sqrt{3}$	1	1	0.52	0.52
Boundary Effects	0.9	Rectangular	$\sqrt{3}$	1	1	0.52	0.52
Readout Electronics	0.2	Normal	1	1	1	0.20	0.20
Response Time	0	Rectangular	$\sqrt{3}$	1	1	0	0
Integration Time	0	Rectangular	$\sqrt{3}$	1	1	0	0
RF Ambient Noise	0.9	Rectangular	$\sqrt{3}$	1	1	0.52	0.52
RF Ambient Reflection	0.9	Rectangular	$\sqrt{3}$	1	1	0.52	0.52
Probe Positioner	0.7	Rectangular	$\sqrt{3}$	1	1	0.40	0.40
Probe Positioning	6.5	Rectangular	$\sqrt{3}$	1	1	3.75	3.75
Post-processing	3.8	Rectangular	$\sqrt{3}$	1	1	2.19	2.19
Test Sample Related							
Device Positioning	3.6	Normal	1	1	1	3.6	3.6
Device Holder	2.9	Normal	1	1	1	2.9	2.9
Measurement SAR Drift	5	Rectangular	$\sqrt{3}$	1	1	2.89	2.89
Power Scaling	5	Rectangular	$\sqrt{3}$	1	1	2.89	2.89
Phantom and Setup							
Phantom Uncertainty (Shape and thickness tolerances)	0.05	Normal	$\sqrt{3}$	1	1	0.03	0.03
Uncertainty in SAR correction for deviations in permittivity and conductivity	1.9	Rectangular	1	1	0.84	1.90	1.60
Liquid conductivity measurement	5	Normal	1	0.78	0.71	3.90	3.55
Liquid permittivity measurement	5	Rectangular	1	0.23	0.26	1.15	1.30
Liquid conductivity – temperature uncertainty	5	Rectangular	$\sqrt{3}$	0.78	0.71	2.25	2.05
Liquid permittivity – temperature uncertainty	5	Rectangular	$\sqrt{3}$	0.23	0.26	0.66	0.75
Combined Standard Uncertainty						10.97	10.709
Coverage Factor for 95%						K=2	
Expanded Uncertainty						$\pm 21.94\%$	$\pm 21.418\%$

DAYS5 System Check Uncertainty for 150 MHz to 450MHz averaged range								
Error Description	Uncer. value (±10%)	Prob. Dist.	Div.	(Ci) 1g	(Ci) 10g	Std. Unc. (1g)	Std. Unc. (10g)	(v _i) V _{eff}
Measurement System								
Probe Calibration	6.65	Normal	1	1	1	6.65	6.65	∞
Axial Isotropy	0.25	Rectangular	$\sqrt{3}$	1	1	0.14	0.14	∞
Hemispherical Isotropy	1.3	Rectangular	$\sqrt{3}$	1	1	0.75	0.75	∞
Linearity	0.3	Rectangular	$\sqrt{3}$	1	1	0.17	0.17	∞
Probe Modulation Response	1.9	Rectangular	$\sqrt{3}$	1	1	1.10	1.10	∞
System Detection Limits	0.9	Rectangular	$\sqrt{3}$	1	1	0.52	0.52	∞
Boundary Effects	0.9	Rectangular	$\sqrt{3}$	1	1	0.52	0.52	∞
Readout Electronics	0.2	Normal	1	1	1	0.20	0.20	∞
Response Time	0	Rectangular	$\sqrt{3}$	1	1	0.00	0.00	∞
Integration Time	0	Rectangular	$\sqrt{3}$	1	1	0.00	0.00	∞
RF Ambient Noise	0.9	Rectangular	$\sqrt{3}$	1	1	0.52	0.52	∞
RF Ambient Reflection	0.9	Rectangular	$\sqrt{3}$	1	1	0.52	0.52	∞
Probe Positioner	0.7	Rectangular	$\sqrt{3}$	1	1	0.40	0.40	∞
Probe Positioning	6.5	Rectangular	$\sqrt{3}$	1	1	3.75	3.75	∞
Post-processing	3.8	Rectangular	$\sqrt{3}$	1	1	2.19	2.19	∞
Dipole Related								
Deviation of exp. dipole	5.3	Rectangular	$\sqrt{3}$	1	1	3.06	3.06	∞
Dipole Axis to Liquid Dist.	2.0	Rectangular	$\sqrt{3}$	1	1	1.15	1.15	∞
Input power & SAR drift	3.3	Rectangular	$\sqrt{3}$	1	1	1.91	1.91	∞
Phantom and Setup								
Phantom Uncertainty (Shape and thickness tolerances)	0.05	Normal	$\sqrt{3}$	1	1	0.03	0.03	∞
Uncertainty in SAR correction for deviations in permittivity and conductivity	1.9	Rectangular	1	1	0.84	1.90	1.60	∞
Liquid conductivity measurement	5	Normal	1	0.78	0.71	3.90	3.55	∞
Liquid permittivity measurement	5	Rectangular	1	0.23	0.26	1.15	1.30	∞
Liquid conductivity – temperature uncertainty	5	Rectangular	$\sqrt{3}$	0.78	0.71	2.25	2.05	∞
Liquid permittivity – temperature uncertainty	5	Rectangular	$\sqrt{3}$	0.23	0.26	0.66	0.75	∞
Combined Std. Uncertainty						9.83	9.538	
Expanded STD Uncertainty						±19.66%	±19.075%	

DAYS5 Measurement Uncertainty							
Measurement uncertainty for 150 MHz to 3GHz averaged over 1 gram / 10 gram.							
Error Description	Uncertainty value($\pm 10\%$)	Probability Distribution	Divisor	(Ci) 1g	(Ci) 10g	Standard Uncertainty (1g)	Standard Uncertainty (10g)
Measurement System							
Probe Calibration	6	Normal	1	1	1	6.00	6.00
Axial Isotropy	0.25	Rectangular	$\sqrt{3}$	1	1	0.14	0.14
Hemispherical Isotropy	1.3	Rectangular	$\sqrt{3}$	1	1	0.75	0.75
Linearity	0.3	Rectangular	$\sqrt{3}$	1	1	0.17	0.17
Probe Modulation Response	1.65	Rectangular	$\sqrt{3}$	1	1	0.95	0.95
System Detection Limits	0.9	Rectangular	$\sqrt{3}$	1	1	0.52	0.52
Boundary Effects	0.9	Rectangular	$\sqrt{3}$	1	1	0.52	0.52
Readout Electronics	0.2	Normal	1	1	1	0.20	0.20
Response Time	0	Rectangular	$\sqrt{3}$	1	1	0.00	0.00
Integration Time	0	Rectangular	$\sqrt{3}$	1	1	0.00	0.00
RF Ambient Noise	0.9	Rectangular	$\sqrt{3}$	1	1	0.52	0.52
RF Ambient Reflection	0.9	Rectangular	$\sqrt{3}$	1	1	0.52	0.52
Probe Positioner	0.7	Rectangular	$\sqrt{3}$	1	1	0.40	0.40
Probe Positioning	6.5	Rectangular	$\sqrt{3}$	1	1	3.75	3.75
Post-processing	3.8	Rectangular	$\sqrt{3}$	1	1	2.19	2.19
Test Sample Related							
Device Positioning	3.6	Normal	1	1	1	3.6	3.6
Device Holder	2.9	Normal	1	1	1	2.9	2.9
Measurement SAR Drift	5.0	Rectangular	$\sqrt{3}$	1	1	2.89	2.89
Power Scaling	0.0	Rectangular	$\sqrt{3}$	1	1	0	0
Phantom and Setup							
Phantom Uncertainty (Shape and thickness tolerances)	0.05	Normal	$\sqrt{3}$	1	1	0.03	0.03
Uncertainty in SAR correction for deviations in permittivity and conductivity	1.9	Rectangular	1	1	0.84	1.90	1.60
Liquid conductivity measurement	5	Normal	1	0.78	0.71	3.90	3.55
Liquid permittivity measurement	5	Rectangular	1	0.23	0.26	1.15	1.30
Liquid conductivity – temperature uncertainty	5	Rectangular	$\sqrt{3}$	0.78	0.71	2.25	2.05
Liquid permittivity – temperature uncertainty	5	Rectangular	$\sqrt{3}$	0.23	0.26	0.66	0.75
Combined Standard Uncertainty						10.17	9.89
Coverage Factor for 95%						K=2	
Expanded Uncertainty						$\pm 20.34\%$	$\pm 19.779\%$

DAY55 System Check Uncertainty for 150 MHz to 3GHz averaged range								
Error Description	Uncer. value (±10%)	Prob. Dist.	Div.	(Ci) 1g	(Ci) 10g	Std. Unc. (1g)	Std. Unc. (10g)	(v _i) V _{eff}
Measurement System								
Probe Calibration	6	Normal	1	1	1	6.00	6.00	∞
Axial Isotropy	0.25	Rectangular	$\sqrt{3}$	1	1	0.14	0.14	∞
Hemispherical Isotropy	1.3	Rectangular	$\sqrt{3}$	1	1	0.75	0.75	∞
Boundary Effects	0.3	Rectangular	$\sqrt{3}$	1	1	0.17	0.17	∞
Linearity	1.65	Rectangular	$\sqrt{3}$	1	1	0.95	0.95	∞
System Detection Limits	0.9	Rectangular	$\sqrt{3}$	1	1	0.52	0.52	∞
Modulation Response	0.9	Rectangular	$\sqrt{3}$	1	1	0.52	0.52	∞
Readout Electronics	0.2	Normal	1	1	1	0.20	0.20	∞
Response Time	0	Rectangular	$\sqrt{3}$	1	1	0.00	0.00	∞
Integration Time	0	Rectangular	$\sqrt{3}$	1	1	0.00	0.00	∞
RF Ambient Noise	0.9	Rectangular	$\sqrt{3}$	1	1	0.52	0.52	∞
RF Ambient Reflection	0.9	Rectangular	$\sqrt{3}$	1	1	0.52	0.52	∞
Probe Positioner	0.7	Rectangular	$\sqrt{3}$	1	1	0.40	0.40	∞
Probe Positioning	6.5	Rectangular	$\sqrt{3}$	1	1	3.75	3.75	∞
Max. SAR Eval.	3.8	Rectangular	$\sqrt{3}$	1	1	2.19	2.19	∞
Dipole Related								
Deviation of exp. dipole	5.3	Rectangular	$\sqrt{3}$	1	1	3.06	3.06	∞
Dipole Axis to Liquid Dist.	2.0	Rectangular	$\sqrt{3}$	1	1	1.15	1.15	∞
Input power & SAR drift	3.3	Rectangular	$\sqrt{3}$	1	1	1.91	1.91	∞
Phantom and Setup								
Phantom Uncertainty (Shape and thickness tolerances)	0.05	Normal	$\sqrt{3}$	1	1	0.03	0.03	∞
Uncertainty in SAR correction for deviations in permittivity and conductivity	1.9	Rectangular	1	1	0.84	1.90	1.60	∞
Liquid conductivity measurement	5	Normal	1	0.78	0.71	3.90	3.55	∞
Liquid permittivity measurement	5	Rectangular	1	0.23	0.26	1.15	1.30	∞
Liquid conductivity – temperature uncertainty	5	Rectangular	$\sqrt{3}$	0.78	0.71	2.25	2.05	∞
Liquid permittivity – temperature uncertainty	5	Rectangular	$\sqrt{3}$	0.23	0.26	0.66	0.75	∞
Combined Std. Uncertainty						9.38	9.080	
Expanded STD Uncertainty						±18.77%	±18.16%	

10. CONDUCTED POWER MEASUREMENT

Type of signal: Digital (5W)

Voice:

Frequency (MHz)	Channel Spacing	Max. Output Power (dBm)
400.025	12.5KHz	36.69
416.025		36.73
432.025		36.71
448.025		36.76
464.025		36.77
479.975		36.78

Data transmission mode:

Frequency (MHz)	Channel Spacing	Max. Output Power (dBm)
400.025	12.5KHz	36.55
416.025		36.58
432.025		36.56
448.025		36.52
464.025		36.60
479.975		36.63

Type of signal: Analog (5W)

Frequency (MHz)	Channel Spacing	Max. Output Power (dBm)
400.025	12.5KHz	36.88
416.025		36.74
432.025		36.79
448.025		36.72
464.025		36.70
479.975		36.67

Type of signal: Digital (1W)
Voice:

Frequency (MHz)	Channel Spacing	Max. Output Power (dBm)
400.025	12.5KHz	29.85
416.025		29.83
432.025		29.81
448.025		29.87
464.025		29.85
479.975		29.94

Data transmission mode:

Frequency (MHz)	Channel Spacing	Max. Output Power (dBm)
400.025	12.5KHz	29.74
416.025		29.70
432.025		29.73
448.025		29.69
464.025		29.68
479.975		29.77

Type of signal: Analog (1W)

Frequency (MHz)	Channel Spacing	Max. Output Power (dBm)
400.025	12.5KHz	29.81
416.025		29.83
432.025		29.90
448.025		29.86
464.025		29.84
479.975		29.93

11. TEST RESULTS

11.1. SAR Test Results Summary

11.1.1. Test position and configuration

Head SAR was performed with the device configured in the positions according to KDB 643646 and Body SAR was performed with the device configured with all accessories close to the Flat Phantom.

11.1.2. Operation Mode

- Set the EUT to maximum output power level and transmit on lower, middle and top channel with 100% duty cycle individually during SAR measurement.
- Per KDB 447498D01 v06 Chapter 4.1 6) the number of channels to be assessed is 5.
- Per KDB 643646 D01, Passive body-worn and audio accessories generally do not apply to the head SAR of PTT radios. Head SAR is measured with the front surface of the radio positioned at 2.5 cm parallel to a flat phantom.

When testing antennas with the default battery:

- a. When the SAR ≤ 3.5 W/kg, testing of all other required channels is not necessary for that antenna;
 - b. When the SAR > 3.5 W/kg and ≤ 4.0 W/kg, testing of the required immediately channel(s) is not necessary; testing of the other required channels may still be required.
 - c. When the SAR > 4.0 W/kg and ≤ 6.0 W/kg, SAR should be measured for that antenna on the all required channels;
 - d. When the highest scaled SAR is ≤ 6.0 W/kg, PBA is not required
- Per KDB 643646 D01, Body SAR is measured with the radio placed in a body-worn accessory, positioned against a flat phantom, representative of the normal operating conditions expected by users and typically with a standard default audio accessory supplied with the radio.

When testing antennas with the default battery: the same test measurement with head part.

11.1.3. Test Result

SAR MEASUREMENT (5W)									
Relative Humidity (%): 53					Depth of Liquid (cm):>15				
Product: DIGITAL RADIO									
Test Mode: Hold to Face with 2.5 cm separation & Body worn with all accessories									
Position	Frequency (MHz)	Separation (KHz)	Power Drift (<±0.2db)	SAR 1g with 100% duty Cycle (W/kg)	SAR 1g with 50% duty cycle (W/Kg)	Max. Turn-up Power (dBm)	Meas. output Power (dBm)	Scaled SAR (W/Kg)	Limit W/kg
Digital									
Face Up	479.975	12.5	0.11	5.22	2.610	37.00	36.78	2.746	8.0
Back Touch	479.975	12.5	-0.05	6.61	3.305	37.00	36.78	3.477	8.0
Analog									
Face Up	400.025	12.5	0.08	8.45	4.225	37.00	36.88	4.343	8.0
Face Up	416.025	12.5	-0.03	7.49	3.745	37.00	36.74	3.976	8.0
Face Up	432.025	12.5	-0.13	5.68	2.840	37.00	36.79	2.981	8.0
Face Up	448.025	12.5	0.05	8.09	4.045	37.00	36.72	4.314	8.0
Face Up	464.025	12.5	-0.01	4.92	2.460	37.00	36.70	2.636	8.0
Face Up	479.975	12.5	-0.08	4.4	2.200	37.00	36.67	2.374	8.0
Back Touch	400.025	12.5	-0.18	9.01	4.505	37.00	36.88	4.631	8.0
Back Touch	416.025	12.5	0.03	7.16	3.580	37.00	36.74	3.801	8.0
Back Touch	432.025	12.5	-0.17	7.34	3.670	37.00	36.79	3.852	8.0
Back Touch	448.025	12.5	-0.05	5.43	2.715	37.00	36.72	2.896	8.0
Back Touch	464.025	12.5	0.17	5.35	2.675	37.00	36.70	2.866	8.0
Back Touch	479.975	12.5	-0.19	5.53	2.765	37.00	36.67	2.983	8.0
Note:									
1 During the test, EUT power is 5 W with 100% duty cycle;									
2. There is just default battery and antenna in this project;									
3. According to KDB 643646 D01, when testing antennas with the default battery:									
a. When the SAR ≤ 3.5 W/kg, testing of all other required channels is not necessary for that antenna;									
b. When the SAR > 3.5 W/kg and ≤ 4.0 W/kg, testing of the required immediately channel(s) is not necessary; testing of the other required channels may still be required.									
c. When the SAR > 4.0 W/kg and ≤ 6.0 W/kg, SAR should be measured for that antenna on the all required channels;									
d. When the highest scaled SAR is ≤ 6.0 W/kg, PBA is not required									

Repeated SAR (5W)									
Relative Humidity (%):53					Depth of Liquid (cm):>15				
Product: DIGITAL RADIO									
Test Mode: Body worn with all accessories(UHF)									
Position	Freq. (MHz)	Separation (KHz)	Power Drift (<±0.2db)	Once SAR 1g with 100% duty cycle (W/kg)	Once SAR 1g with 50% duty cycle (W/Kg)	Twice SAR 1g with 100% duty cycle (W/kg)	Twice SAR 1g with 50% duty cycle (W/kg)	Limit W/kg	
Digital									
Back Touch	479.975	12.5	-0.07	5.82	2.91	--	--	8.0	
Analog									
Back Touch	400.025	12.5	-0.17	7.98	3.99	--	--	8.0	

SAR MEASUREMENT (1W)									
Relative Humidity (%): 59.8					Depth of Liquid (cm):>15				
Product: DIGITAL RADIO									
Test Mode: Hold to Face with 2.5 cm separation & Body worn with all accessories									
Position	Frequency (MHz)	Separation (KHz)	Power Drift (<±0.2db)	SAR 1g with 100% duty Cycle (W/kg)	SAR 1g with 50% duty cycle (W/Kg)	Max. Turn-up Power (dBm)	Meas. output Power (dBm)	Scaled SAR (W/Kg)	Limit W/kg
Digital									
Face Up	479.975	12.5	0.06	0.756	0.378	30.00	29.93	0.384	8.0
Back Touch	479.975	12.5	0.06	1.000	0.500	30.00	29.93	0.508	8.0
Analog									
Face Up	400.025	12.5	0.09	1.350	0.675	30.00	29.94	0.684	8.0
Back Touch	464.025	12.5	0.07	2.730	1.365	30.00	29.94	1.384	8.0
Note:									
1 During the test, EUT power is 1 W with 100% duty cycle;									
2. There is just default battery and antenna in this project;									
3 According to KDB 643646 D01, when testing antennas with the default battery:									
a. When the SAR ≤ 3.5 W/kg, testing of all other required channels is not necessary for that antenna;									
b. When the SAR > 3.5 W/kg and ≤ 4.0 W/kg, testing of the required immediately channel(s) is not necessary; testing of the other required channels may still be required.									
c. When the SAR > 4.0 W/kg and ≤ 6.0 W/kg, SAR should be measured for that antenna on the all required channels;									
d. When the highest scaled SAR is ≤ 6.0 W/kg, PBA is not required									

Repeated SAR (1W)									
Relative Humidity (%):59.8					Depth of Liquid (cm):>15				
Product: DIGITAL RADIO									
Test Mode: Body worn with all accessories(UHF)									
Position	Freq. (MHz)	Separation (KHz)	Power Drift (<±0.2db)	Once SAR 1g with 100% duty cycle (W/kg)	Once SAR 1g with 50% duty cycle (W/Kg)	Twice SAR 1g with 100% duty cycle (W/kg)	Twice SAR 1g with 50% duty cycle (W/kg)	Limit W/kg	
Analog									
Back Touch	464.025	12.5	-0.03	2.600	1.300	--	--	8.0	

APPENDIX A. SAR SYSTEM CHECK DATA

Test Laboratory: AGC Lab
System Check Head 450MHz

Test date: Apr. 29,2015

DUT: Dipole 450 MHz Type: SID 450

Communication System: CW; Communication System Band: CW; Duty Cycle: 1:1;

Frequency: 450MHz; Medium parameters used: $f = 450\text{MHz}$; $\sigma = 0.87 \text{ mho/m}$; $\epsilon_r = 43.00$; $\rho = 1000 \text{ kg/m}^3$;

Phantom Type: Elliptical Phantom; Input Power=21dBm

Ambient temperature (°C): 22.2 Liquid temperature (°C): 21.9

DASY Configuration:

- Probe: ES3DV3-SN:3337; ConvF(6.71,6.71,6.71); Calibrated: 09/05/2014;
- Sensor-Surface: 3mm (Mechanical Surface Detection), $z = 1.0$
- Electronics: DAE4 Sn1398; Calibrated: 03/11/2015
- Phantom: ELI v5.0; Type: QDOVA002AA; Serial: TP:1210
- DASY52 52.8.7(1137); SEMCAD X 14.6.10(7164)

Configuration/System Check 450MHz Head/Area Scan (8x23x1): Measurement grid: $dx=15\text{mm}$, $dy=15\text{mm}$
Maximum value of SAR (measured) = 0.669 W/kg

Configuration/System Check 450MHz Head/Zoom Scan ((5x5x7)/Cube 0: Measurement grid: $dx=8\text{mm}$, $dy=8\text{mm}$, $dz=5\text{mm}$

Reference Value = 27.487 V/m; Power Drift = 0.12 dB

Peak SAR (extrapolated) = 0.921 W/kg

SAR(1 g) = 0.595 W/kg; SAR(10 g) = 0.416 W/kg

Maximum value of SAR (measured) = 0.683 W/kg

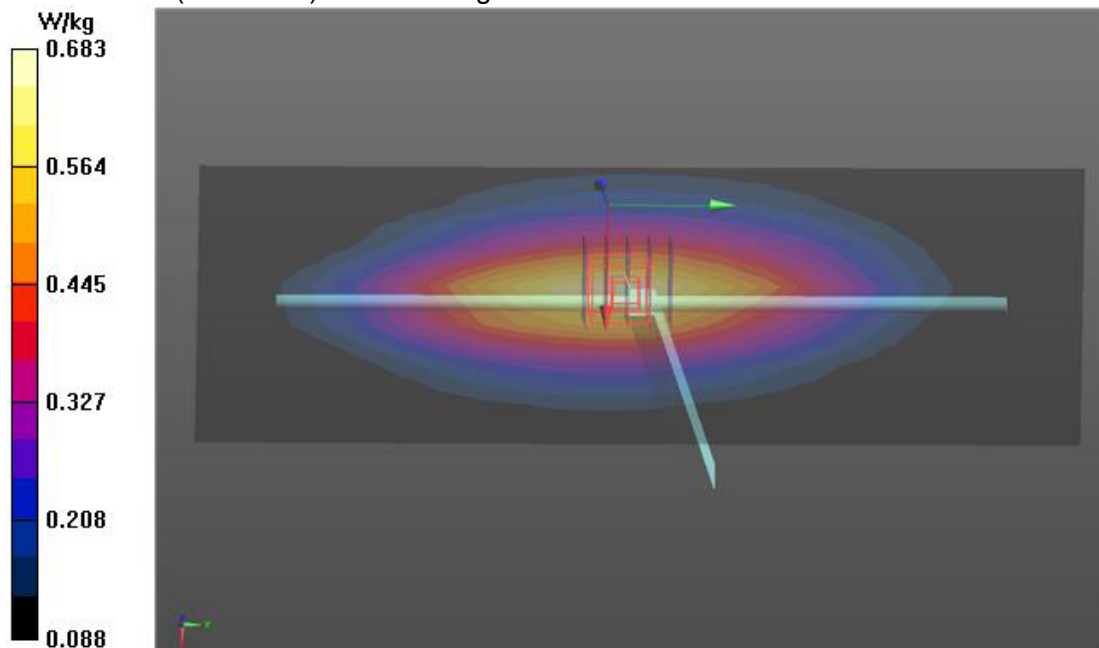

Test Laboratory: AGC Lab
System Check Body 450MHz

Test date: Apr. 29,2015

DUT: Dipole 450 MHz Type: SID 450

Communication System: CW; Communication System Band: CW; Duty Cycle: 1:1;
Frequency: 450MHz; Medium parameters used: $f = 450\text{MHz}$; $\sigma = 0.95 \text{ mho/m}$; $\epsilon_r = 56.70$; $\rho = 1000 \text{ kg/m}^3$;
Phantom Type: Elliptical Phantom; Input Power=21 dBm
Ambient temperature (°C): 22.2 Liquid temperature (°C): 22.0

DASY Configuration:

- Probe: ES3DV3-SN:3337; ConvF(7.08,7.08,7.08); Calibrated: 09/05/2014;
- Sensor-Surface: 3mm (Mechanical Surface Detection), $z = 1.0$
- Electronics: DAE4 Sn1398; Calibrated: 03/11/2015
- Phantom: ELI v5.0; Type: QDOVA002AA; Serial: TP:1210
- DASY52 52.8.7(1137); SEMCAD X 14.6.10(7164)

Configuration/System Check 450MHz Body/ Area Scan (8x23x1): Measurement grid: $dx=15\text{mm}$, $dy=15\text{mm}$
Maximum value of SAR (measured) = 0.646 W/kg

Configuration/System Check 450MHz Body/ Zoom Scan (5x5x7)/Cube 0: Measurement grid: $dx=8\text{mm}$,
 $dy=8\text{mm}$, $dz=5\text{mm}$

Reference Value = 26.784 V/m; Power Drift = 0.00 dB

Peak SAR (extrapolated) = 0.878 W/kg

SAR(1 g) = 0.581 W/kg; SAR(10 g) = 0.400 W/kg

Maximum value of SAR (measured) = 0.670 W/kg

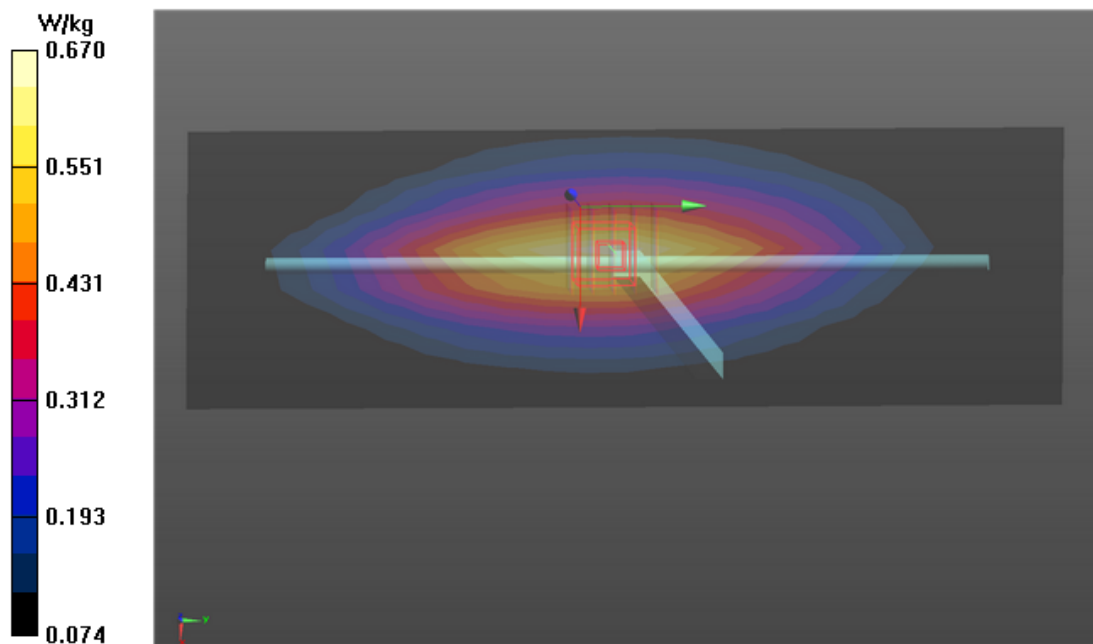

Test Laboratory: AGC Lab
System Check Head 450MHz

Test date: Apr. 30,2015

DUT: Dipole 450 MHz Type: SID 450

Communication System: CW; Communication System Band: CW; Duty Cycle: 1:1;
Frequency: 450MHz; Medium parameters used: $f = 450\text{MHz}$; $\sigma = 0.89 \text{ mho/m}$; $\epsilon_r = 42.83$; $\rho = 1000 \text{ kg/m}^3$;
Phantom Type: Elliptical Phantom; Input Power=21dBm
Ambient temperature (°C): 22.3, Liquid temperature (°C): 21.8

DASY Configuration:

- Probe: ES3DV3-SN:3337; ConvF(6.71,6.71,6.71); Calibrated: 09/05/2014;
- Sensor-Surface: 3mm (Mechanical Surface Detection), $z = 1.0$
- Electronics: DAE4 Sn1398; Calibrated: 03/11/2015
- Phantom: ELI v5.0; Type: QDOVA002AA; Serial: TP:1210
- DASY52 52.8.7(1137); SEMCAD X 14.6.10(7164)

Configuration/System Check 450MHz Head/Area Scan (8x23x1): Measurement grid: $dx=15\text{mm}$, $dy=15\text{mm}$
Maximum value of SAR (measured) = 0.687 W/kg

Configuration/System Check 450MHz Head/Zoom Scan ((5x5x7)/Cube 0: Measurement grid: $dx=8\text{mm}$,
 $dy=8\text{mm}$, $dz=5\text{mm}$

Reference Value = 28.517 V/m; Power Drift = 0.17 dB

Peak SAR (extrapolated) = 0.958 W/kg

SAR(1 g) = 0.614 W/kg; SAR(10 g) = 0.425 W/kg

Maximum value of SAR (measured) = 0.698 W/kg

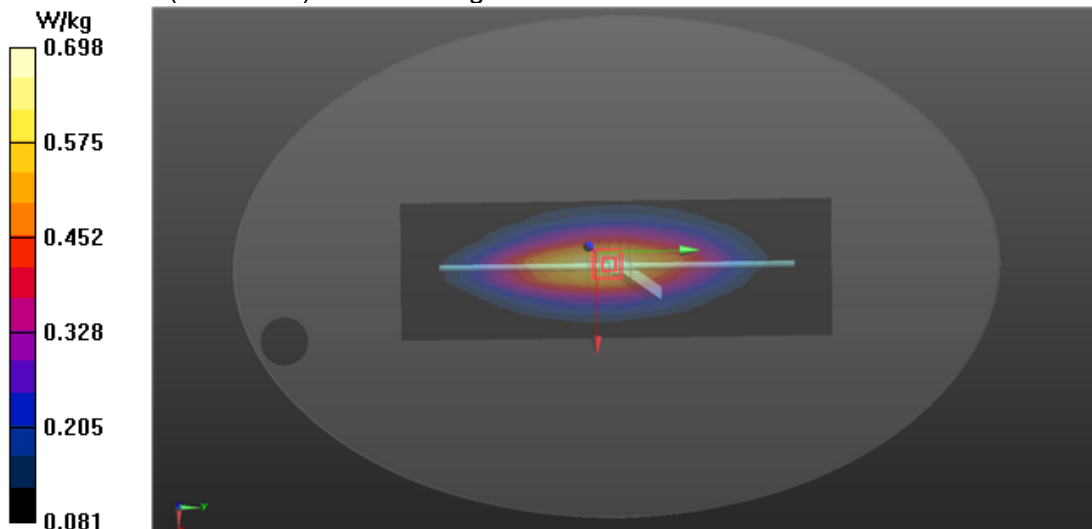

Test Laboratory: AGC Lab
System Check Body 450MHz

Test date: Apr. 30,2015

DUT: Dipole 450 MHz Type: SID 450

Communication System: CW; Communication System Band: CW; Duty Cycle: 1:1;
Frequency: 450MHz; Medium parameters used: $f = 450\text{MHz}$; $\sigma = 0.96 \text{ mho/m}$; $\epsilon_r = 56.03$; $\rho = 1000 \text{ kg/m}^3$;
Phantom Type: Elliptical Phantom; Input Power=21 dBm
Ambient temperature (°C): 22.3, Liquid temperature (°C): 22.1

DASY Configuration:

- Probe: ES3DV3-SN:3337; ConvF(7.08,7.08,7.08); Calibrated: 09/05/2014;
- Sensor-Surface: 3mm (Mechanical Surface Detection), $z = 1.0$
- Electronics: DAE4 Sn1398; Calibrated: 03/11/2015
- Phantom: ELI v5.0; Type: QDOVA002AA; Serial: TP:1210
- DASY52 52.8.7(1137); SEMCAD X 14.6.10(7164)

Configuration/System Check 450MHz Body/ Area Scan (8x23x1): Measurement grid: $dx=15\text{mm}$, $dy=15\text{mm}$
Maximum value of SAR (measured) = 0.703 W/kg

Configuration/System Check 450MHz Body/ Zoom Scan (5x5x7)/Cube 0: Measurement grid: $dx=8\text{mm}$,
 $dy=8\text{mm}$, $dz=5\text{mm}$

Reference Value = 26.536 V/m; Power Drift =-0.07 dB

Peak SAR (extrapolated) = 0.958 W/kg

SAR(1 g) = 0.619 W/kg; SAR(10 g) = 0.429 W/kg

Maximum value of SAR (measured) = 0.706 W/kg

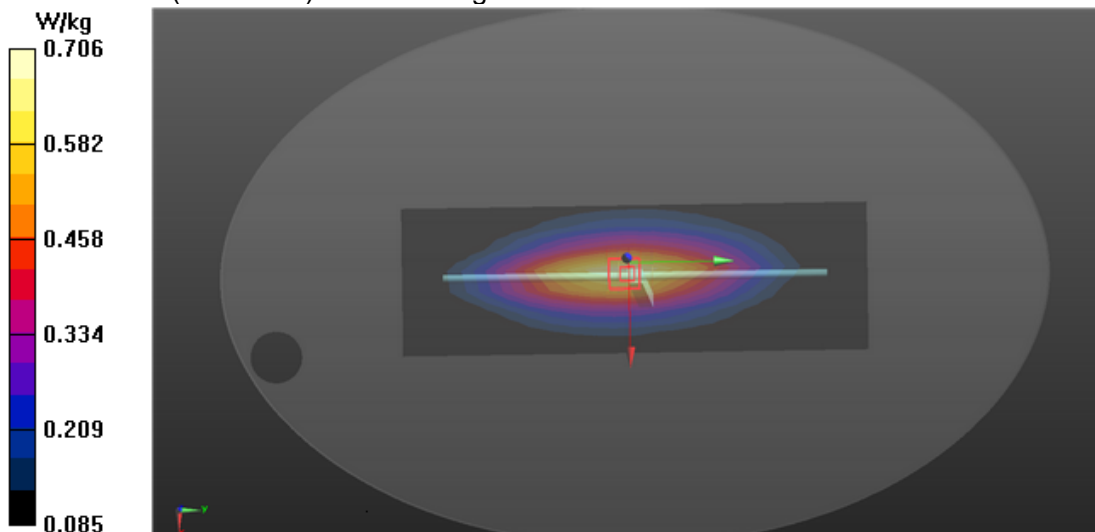

Test Laboratory: AGC Lab
System Check Head 450MHz

Test date: Apr. 17,2016

DUT: Dipole 450 MHz Type: SID 450

Communication System: CW; Communication System Band: CW; Duty Cycle: 1:1;
Frequency: 450MHz; Medium parameters used: $f = 450\text{MHz}$; $\sigma = 0.88 \text{ mho/m}$; $\epsilon_r = 43.61$; $\rho = 1000 \text{ kg/m}^3$;
Phantom Type: Elliptical Phantom; Input Power=21dBm
Ambient temperature (°C): 21.5, Liquid temperature (°C): 21.4

DASY Configuration:

- Probe: ES3DV3-SN:3337; ConvF(6.88,6.88,6.88); Calibrated: 10/01/2015;
- Sensor-Surface: 3mm (Mechanical Surface Detection), $z = 1.0$
- Electronics: DAE4 Sn1398; Calibrated: 02/02/2016
- Phantom: ELI v5.0; Type: QDOVA002AA; Serial: TP:1210
- DASY52 52.8.7(1137); SEMCAD X 14.6.10(7164)

Configuration/System Check 450MHz Head/Area Scan (8x23x1): Measurement grid: $dx=15\text{mm}$, $dy=15\text{mm}$
Maximum value of SAR (measured) = 0.687 W/kg

Configuration/System Check 450MHz Head/Zoom Scan (5x5x7)/Cube 0: Measurement grid: $dx=8\text{mm}$,
 $dy=8\text{mm}$, $dz=5\text{mm}$

Reference Value = 26.471 V/m; Power Drift = -0.06 dB

Peak SAR (extrapolated) = 0.913 W/kg

SAR(1 g) = 0.600 W/kg; SAR(10 g) = 0.409 W/kg

Maximum value of SAR (measured) = 0.683 W/kg

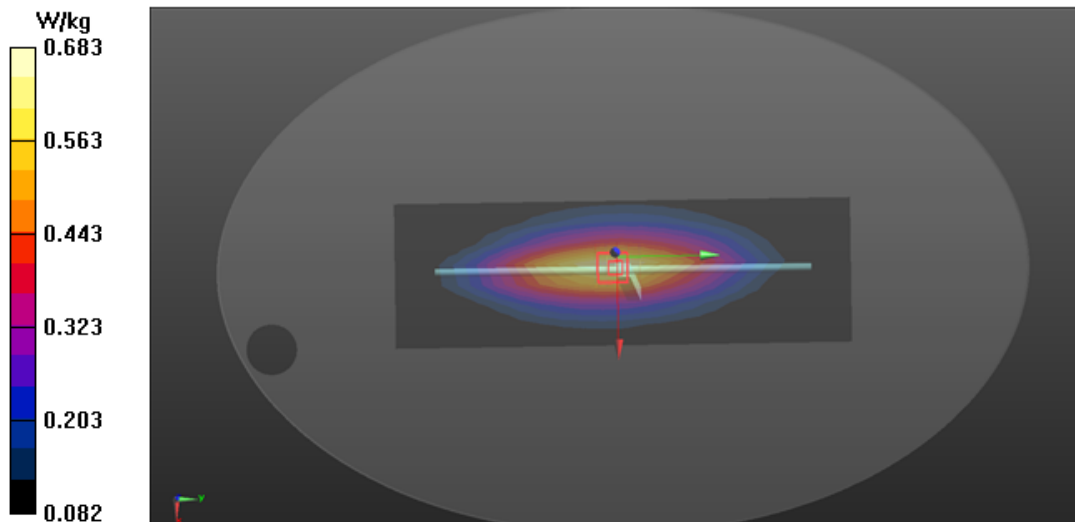

Test Laboratory: AGC Lab
System Check Body 450MHz

Test date: Apr. 17,2016

DUT: Dipole 450 MHz Type: SID 450

Communication System: CW; Communication System Band: CW; Duty Cycle: 1:1;

Frequency: 450MHz; Medium parameters used: $f = 450\text{MHz}$; $\sigma = 0.96 \text{ mho/m}$; $\epsilon_r = 56.81$; $\rho = 1000 \text{ kg/m}^3$;

Phantom Type: Elliptical Phantom; Input Power=21 dBm

Ambient temperature (°C): 21.5, Liquid temperature (°C): 21.4

DASY Configuration:

- Probe: ES3DV3-SN:3337; ConvF(6.88,6.88,6.88); Calibrated: 10/01/2015;
- Sensor-Surface: 3mm (Mechanical Surface Detection), $z = 1.0$
- Electronics: DAE4 Sn1398; Calibrated: 02/02/2016
- Phantom: ELI v5.0; Type: QDOVA002AA; Serial: TP:1210
- DASY52 52.8.7(1137); SEMCAD X 14.6.10(7164)

Configuration/System Check 450MHz Body/Area Scan (8x23x1): Measurement grid: $dx=15\text{mm}$, $dy=15\text{mm}$
Maximum value of SAR (measured) = 0.663 W/kg

Configuration/System Check 450MHz Body/Zoom Scan (5x5x7)/Cube 0: Measurement grid: $dx=8\text{mm}$,
 $dy=8\text{mm}$, $dz=5\text{mm}$

Reference Value = 27.051 V/m; Power Drift = 0.07 dB

Peak SAR (extrapolated) = 0.917 W/kg

SAR(1 g) = 0.595 W/kg; SAR(10 g) = 0.412 W/kg

Maximum value of SAR (measured) = 0.682 W/kg

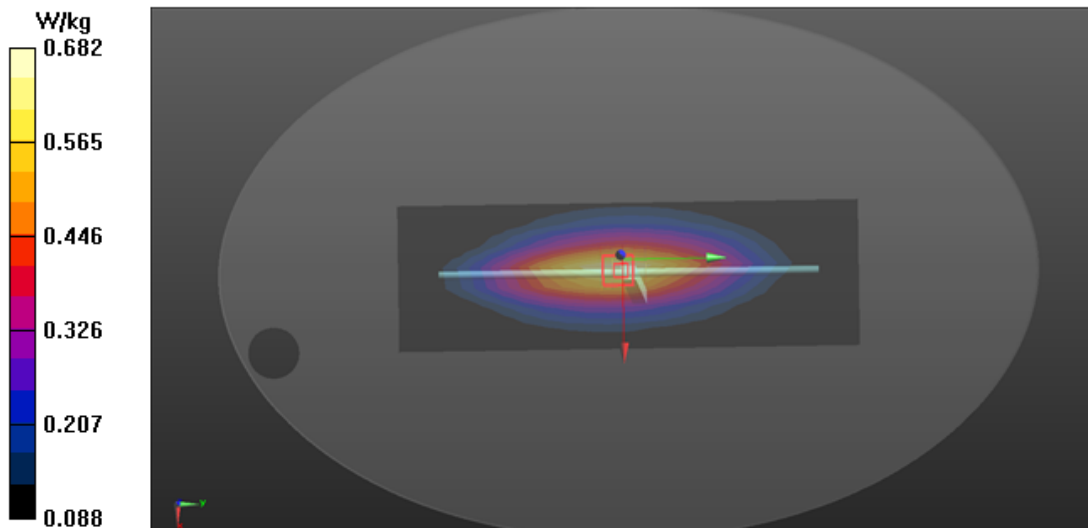

APPENDIX B. SAR MEASUREMENT DATA

Type of signal: Digital (5W)

Test Laboratory: AGC Lab
450MHz High- face up 2.5cm (12.5 KHz)
DUT: DIGITAL RADIO ; Type: D868

Date: Apr. 30,2015

Communication System: CW; Communication System Band:450MHz; Duty Cycle: 1:1;
Frequency: 479.975 MHz; Medium parameters used: $f = 450\text{MHz}$; $\sigma = 0.91\text{ mho/m}$; $\epsilon_r = 42.16$; $\rho = 1000\text{ kg/m}^3$;
Phantom Type: Elliptical Phantom
Ambient temperature (°C): 22.3, Liquid temperature (°C): 21.8

DASY Configuration:

- Probe: ES3DV3-SN:3337; ConvF(6.71,6.71,6.71); Calibrated: 09/05/2014;
- Sensor-Surface: 3mm (Mechanical Surface Detection), $z = 1.0$
- Electronics: DAE4 Sn1398; Calibrated: 03/11/2015
- Phantom: ELI v5.0; Type: QDOVA002AA; Serial: TP:1210
- DASY52 52.8.7(1137); SEMCAD X 14.6.10(7164)

FRONT/HIGH/Area Scan (9x13x1): Measurement grid: $dx=15\text{mm}$, $dy=15\text{mm}$
Maximum value of SAR (measured) = 6.14 W/kg

FRONT/HIGH/Zoom Scan (5x5x7)/Cube 0: Measurement grid: $dx=8\text{mm}$, $dy=8\text{mm}$, $dz=5\text{mm}$

Reference Value = 82.652 V/m; Power Drift = 0.11 dB

Peak SAR (extrapolated) = 6.61 W/kg

SAR(1 g) = 5.22 W/kg; SAR(10 g) = 4.09 W/kg

Maximum value of SAR (measured) = 5.70 W/kg

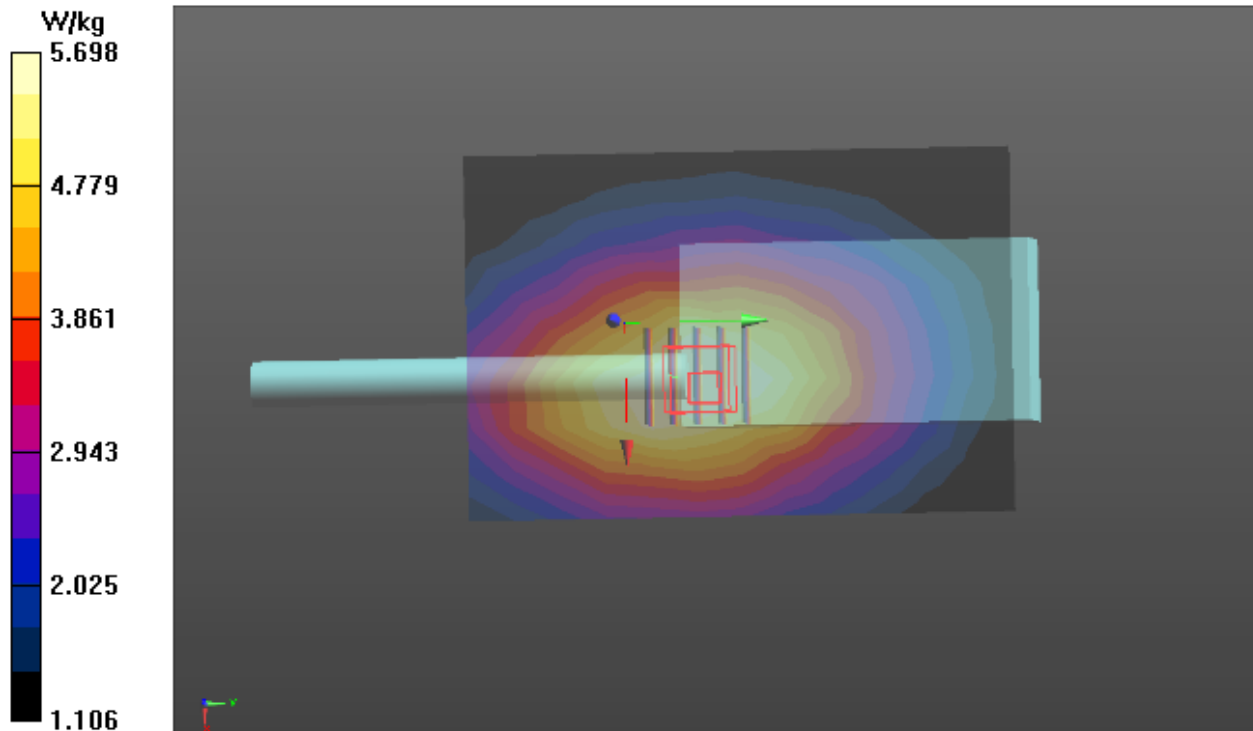

Test Laboratory: AGC Lab
450MHz High- Body - Touch (12.5 KHz)
DUT: DIGITAL RADIO ; Type: D868

Date: Apr. 30,2015

Communication System: CW; Communication System Band:450MHz; Duty Cycle: 1:1;
Frequency: 479.975MHz; Medium parameters used: $f = 450\text{MHz}$; $\sigma = 0.97\text{mho/m}$; $\epsilon_r = 54.28$; $\rho = 1000 \text{ kg/m}^3$;
Phantom Type: Elliptical Phantom
Ambient temperature (°C):22.3, Liquid temperature (°C): 22.1

DASY Configuration:

- Probe: ES3DV3-SN:3337; ConvF(7.08,7.08,7.08); Calibrated: 09/05/2014;
- Sensor-Surface: 3mm (Mechanical Surface Detection), $z = 1.0$
- Electronics: DAE4 Sn1398; Calibrated: 03/11/2015
- Phantom: ELI v5.0; Type: QDOVA002AA; Serial: TP:1210
- DASY52 52.8.7(1137); SEMCAD X 14.6.10(7164)

BACK/HIGH/Area Scan (9x13x1): Measurement grid: $dx=15\text{mm}$, $dy=15\text{mm}$
Maximum value of SAR (measured) = 7.19 W/kg

BACK/HIGH/Zoom Scan (5x5x7)/Cube 0: Measurement grid: $dx=8\text{mm}$, $dy=8\text{mm}$, $dz=5\text{mm}$
Reference Value = 83.049 V/m; Power Drift = -0.05 dB
Peak SAR (extrapolated) = 9.13 W/kg
SAR(1 g) = 6.61 W/kg; SAR(10 g) = 5 W/kg
Maximum value of SAR (measured) = 7.53 W/kg

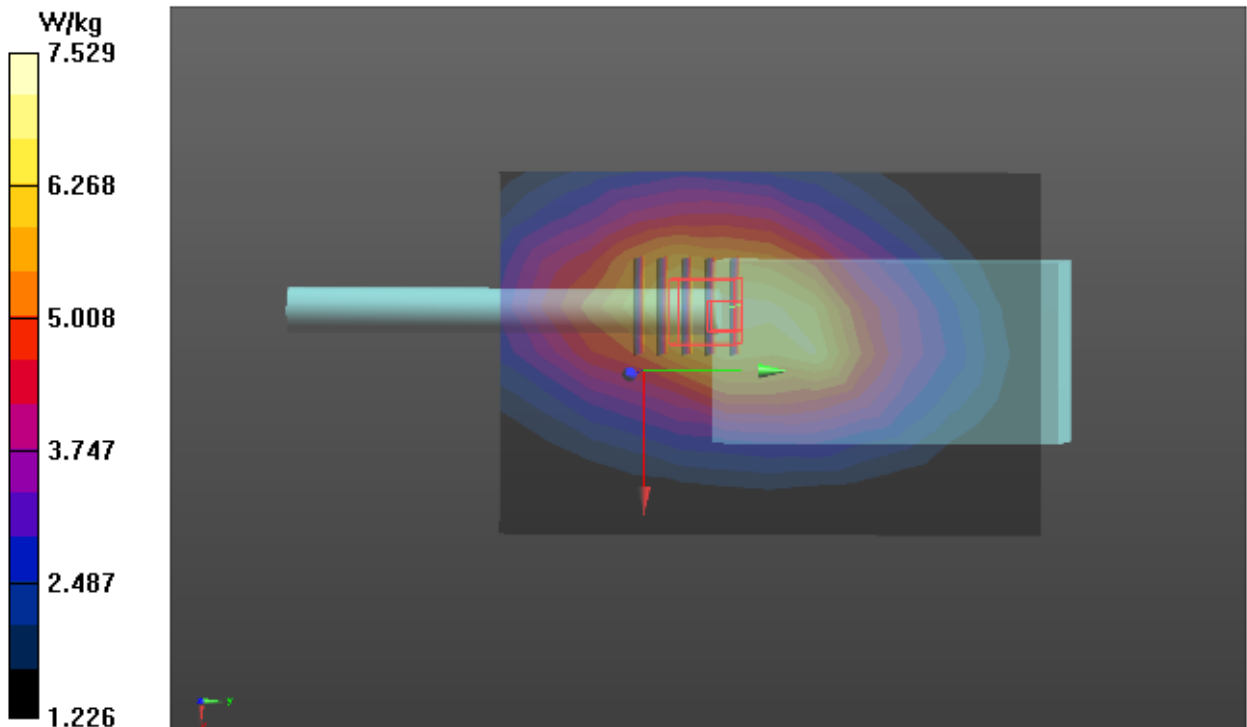

Repeated SAR(5W)

Test Laboratory: AGC Lab
450MHz High- Body - Touch (12.5 KHz)
DUT: DIGITAL RADIO ; Type: D868

Date: Apr. 30,2015

Communication System: CW; Communication System Band:450MHz; Duty Cycle: 1:1;
Frequency: 479.975MHz; Medium parameters used: $f = 450\text{MHz}$; $\sigma = 0.97\text{mho/m}$; $\epsilon_r = 54.28$; $\rho = 1000 \text{ kg/m}^3$;
Phantom Type: Elliptical Phantom
Ambient temperature (°C):22.3, Liquid temperature (°C): 22.1

DASY Configuration:

- Probe: ES3DV3-SN:3337; ConvF(7.08,7.08,7.08); Calibrated: 09/05/2014;
- Sensor-Surface: 3mm (Mechanical Surface Detection), $z = 1.0$
- Electronics: DAE4 Sn1398; Calibrated: 03/11/2015
- Phantom: ELI v5.0; Type: QDOVA002AA; Serial: TP:1210
- DASY52 52.8.7(1137); SEMCAD X 14.6.10(7164)

BACK/REPEATED/Area Scan (9x13x1): Measurement grid: $dx=15\text{mm}$, $dy=15\text{mm}$
Maximum value of SAR (measured) = 6.70 W/kg

BACK/REPEATED/Zoom Scan (5x5x7)/Cube 0: Measurement grid: $dx=8\text{mm}$, $dy=8\text{mm}$, $dz=5\text{mm}$
Reference Value = 80.491 V/m; Power Drift = -0.07 dB
Peak SAR (extrapolated) = 7.61 W/kg
SAR(1 g) = 5.82 W/kg; SAR(10 g) = 4.52 W/kg
Maximum value of SAR (measured) = 6.43 W/kg

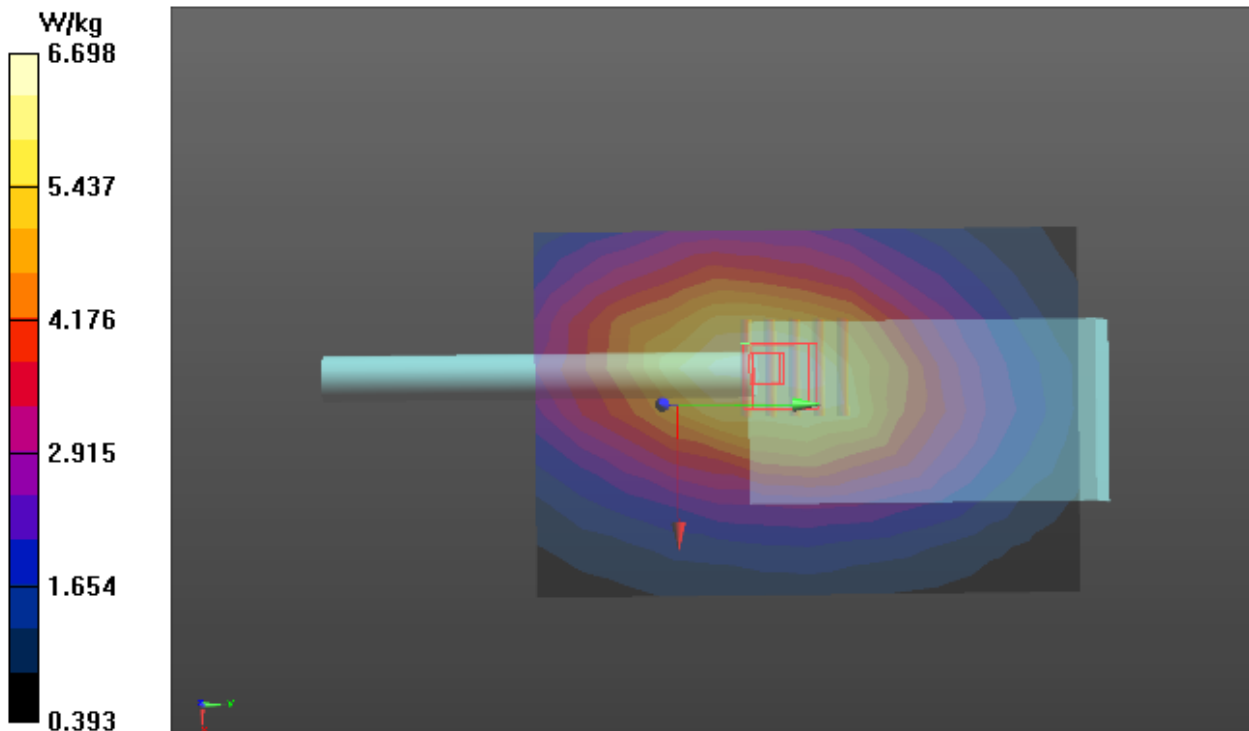

Type of signal: Analog (5W)

Test Laboratory: AGC Lab
450MHz Low- face up 2.5cm (12.5 KHz)
DUT: DIGITAL RADIO ; Type: D868

Date: Apr. 29,2015

Communication System: CW; Communication System Band:450MHz; Duty Cycle: 1:1;
Frequency: 400.025MHz; Medium parameters used: $f = 450\text{MHz}$; $\sigma = 0.84 \text{ mho/m}$; $\epsilon_r = 44.46$; $\rho = 1000 \text{ kg/m}^3$;
Phantom Type: Elliptical Phantom
Ambient temperature (°C): 22.2 Liquid temperature (°C): 21.9

DASY Configuration:

- Probe: ES3DV3-SN:3337; ConvF(6.71,6.71,6.71); Calibrated: 09/05/2014;
- Sensor-Surface: 3mm (Mechanical Surface Detection), $z = 1.0$
- Electronics: DAE4 Sn1398; Calibrated: 03/11/2015
- Phantom: ELI v5.0; Type: QDOVA002AA; Serial: TP:1210
- DASY52 52.8.7(1137); SEMCAD X 14.6.10(7164)

FRONT/LOW/Area Scan (9x13x1): Measurement grid: $dx=15\text{mm}$, $dy=15\text{mm}$
Maximum value of SAR (measured) = 9.60 W/kg

FRONT/LOW/Zoom Scan (5x5x7)/Cube 0: Measurement grid: $dx=8\text{mm}$, $dy=8\text{mm}$, $dz=5\text{mm}$

Reference Value = 108.7 V/m; Power Drift = 0.08 dB

Peak SAR (extrapolated) = 11.0 W/kg

SAR(1 g) = 8.45 W/kg; SAR(10 g) = 6.43 W/kg

Maximum value of SAR (measured) = 9.32 W/kg

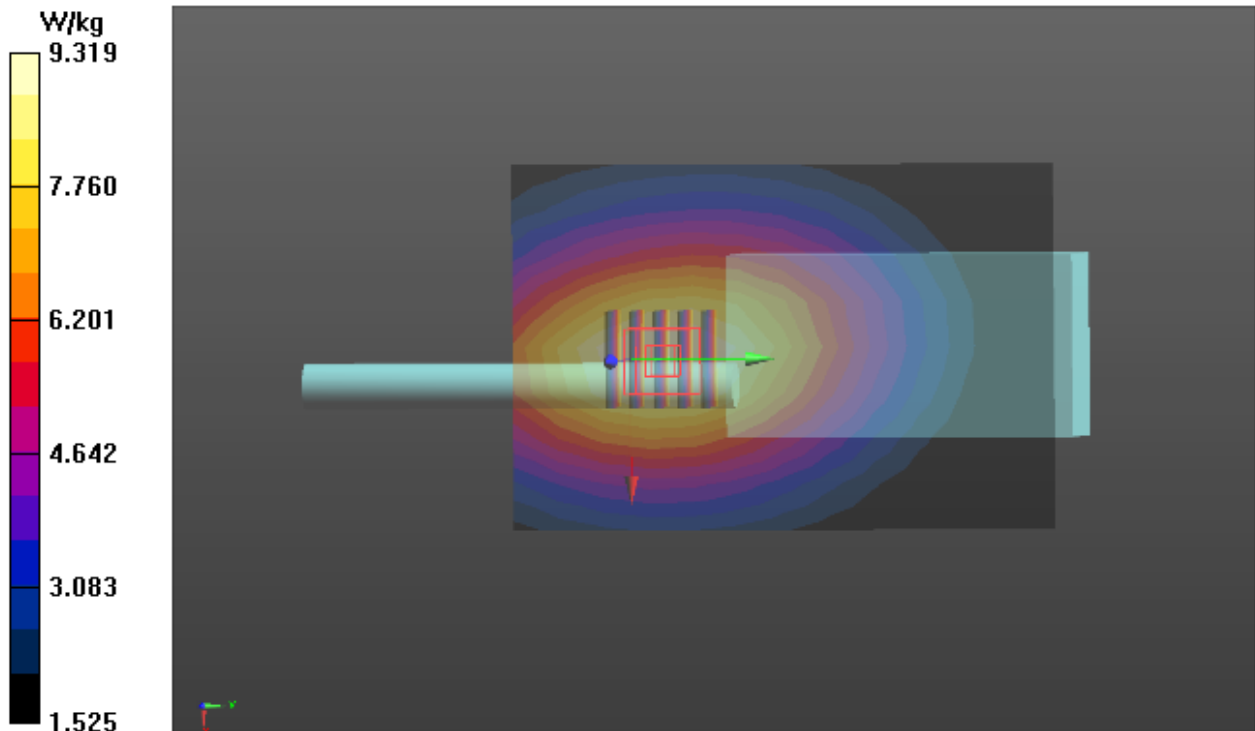

Test Laboratory: AGC Lab
450MHz Low- Body - Touch (12.5 KHz)
DUT: DIGITAL RADIO ; Type: D868

Date: Apr. 29,2015

Communication System: CW; Communication System Band:450MHz; Duty Cycle: 1:1;
Frequency: 400.025MHz; Medium parameters used: $f = 450\text{MHz}$; $\sigma = 0.91 \text{ mho/m}$; $\epsilon_r = 58.20$; $\rho = 1000 \text{ kg/m}^3$;
Phantom Type: Elliptical Phantom
Ambient temperature (°C): 22.2 Liquid temperature (°C): 22.0

DASY Configuration:

- Probe: ES3DV3-SN:3337; ConvF(7.08,7.08,7.08); Calibrated: 09/05/2014;
- Sensor-Surface: 3mm (Mechanical Surface Detection), $z = 1.0$
- Electronics: DAE4 Sn1398; Calibrated: 03/11/2015
- Phantom: ELI v5.0; Type: QDOVA002AA; Serial: TP:1210
- DASY52 52.8.7(1137); SEMCAD X 14.6.10(7164)

BACK/LOW/Area Scan (9x13x1): Measurement grid: $dx=15\text{mm}$, $dy=15\text{mm}$
Maximum value of SAR (measured) = 10.2 W/kg

BACK/LOW/Zoom Scan (5x5x7)/Cube 0: Measurement grid: $dx=8\text{mm}$, $dy=8\text{mm}$, $dz=5\text{mm}$
Reference Value = 108.7 V/m; Power Drift = -0.18 dB
Peak SAR (extrapolated) = 12.1 W/kg
SAR(1 g) = 9.01 W/kg; SAR(10 g) = 6.87 W/kg
Maximum value of SAR (measured) = 9.95 W/kg

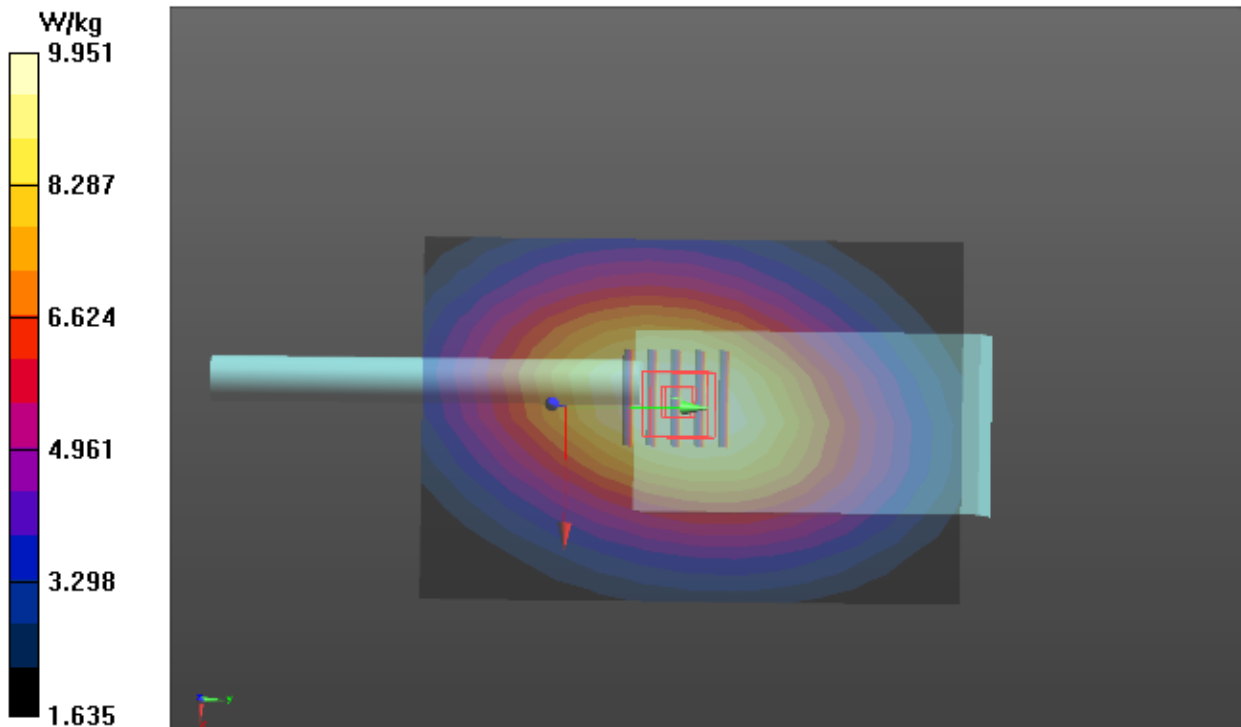

Repeated SAR(5W)

Test Laboratory: AGC Lab
450MHz Low- Body - Touch (12.5 KHz)
DUT: DIGITAL RADIO ; Type: D868

Date: Apr. 29,2015

Communication System: CW; Communication System Band:450MHz; Duty Cycle: 1:1;
Frequency: 400.025MHz; Medium parameters used: $f = 450\text{MHz}$; $\sigma = 0.91 \text{ mho/m}$; $\epsilon_r = 58.20$; $\rho = 1000 \text{ kg/m}^3$;
Phantom Type: Elliptical Phantom
Ambient temperature (°C): 22.2 Liquid temperature (°C): 22.0

DASY Configuration:

- Probe: ES3DV3-SN:3337; ConvF(7.08,7.08,7.08); Calibrated: 09/05/2014;
- Sensor-Surface: 3mm (Mechanical Surface Detection), $z = 1.0$
- Electronics: DAE4 Sn1398; Calibrated: 03/11/2015
- Phantom: ELI v5.0; Type: QDOVA002AA; Serial: TP:1210
- DASY52 52.8.7(1137); SEMCAD X 14.6.10(7164)

BACK/REPEATED/Area Scan (9x13x1): Measurement grid: $dx=15\text{mm}$, $dy=15\text{mm}$
Maximum value of SAR (measured) = 8.83 W/kg

BACK/REPEATED/Zoom Scan (5x5x7)/Cube 0: Measurement grid: $dx=8\text{mm}$, $dy=8\text{mm}$, $dz=5\text{mm}$
Reference Value = 96.652 V/m; Power Drift = -0.17 dB
Peak SAR (extrapolated) = 10.8 W/kg
SAR(1 g) = 7.98 W/kg; SAR(10 g) = 6.07 W/kg

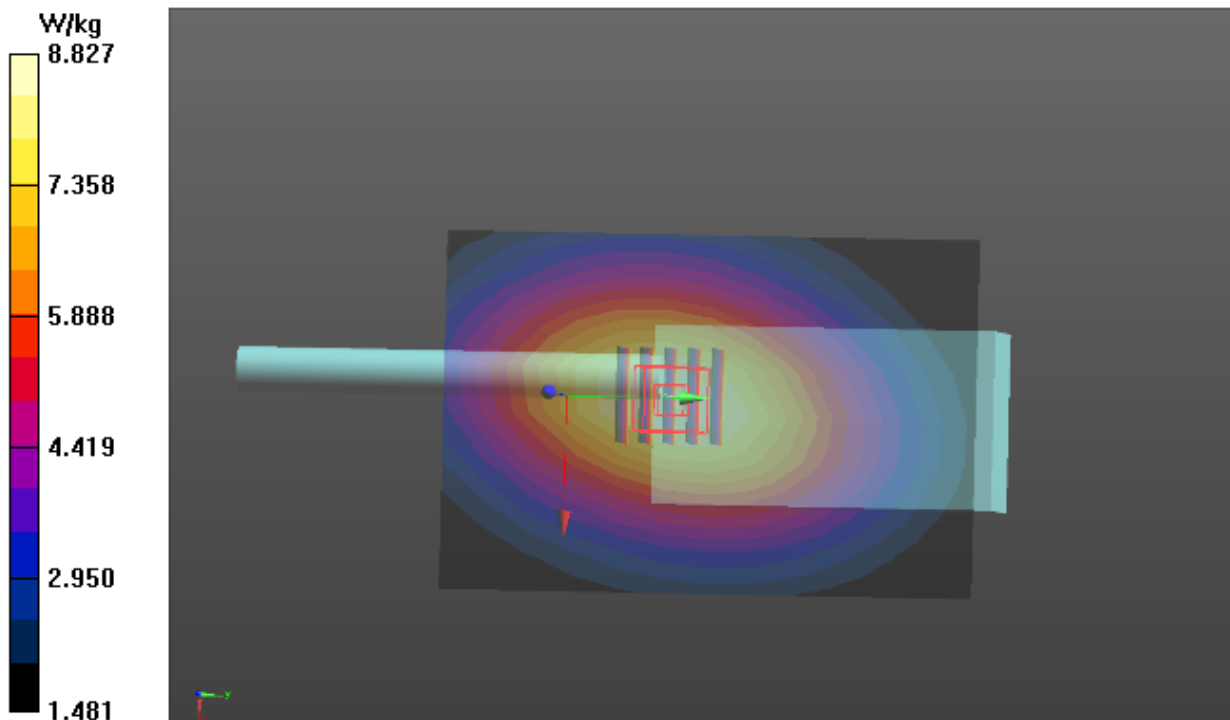

Type of signal: Digital (1W)

Test Laboratory: AGC Lab
450MHz High- face up 2.5cm (12.5 KHz)
DUT: DIGITAL RADIO ; Type: D868

Date: Apr. 17,2016

Communication System: CW; Communication System Band:450MHz; Duty Cycle: 1:1;
Frequency: 479.975 MHz; Medium parameters used: $f = 450\text{MHz}$; $\sigma = 0.90 \text{ mho/m}$; $\epsilon_r = 42.84$; $\rho = 1000 \text{ kg/m}^3$;
Phantom Type: Elliptical Phantom
Ambient temperature (°C): 21.5, Liquid temperature (°C): 21.4

DASY Configuration:

- Probe: ES3DV3-SN:3337; ConvF(6.88,6.88,6.88); Calibrated: 10/01/2015;
- Sensor-Surface: 3mm (Mechanical Surface Detection), $z = 1.0$
- Electronics: DAE4 Sn1398; Calibrated: 02/02/2016
- Phantom: ELI v5.0; Type: QDOVA002AA; Serial: TP:1210
- DASY52 52.8.7(1137); SEMCAD X 14.6.10(7164)

FRONT/HIGH/Area Scan (9x13x1): Measurement grid: $dx=15\text{mm}$, $dy=15\text{mm}$
Maximum value of SAR (measured) = 0.875 W/kg

FRONT/HIGH/Zoom Scan (5x5x7)/Cube 0: Measurement grid: $dx=8\text{mm}$, $dy=8\text{mm}$, $dz=5\text{mm}$
Reference Value = 32.288 V/m; Power Drift = 0.06 dB
Peak SAR (extrapolated) = 1.01 W/kg
SAR(1 g) = 0.756 W/kg; SAR(10 g) = 0.575 W/kg
Maximum value of SAR (measured) = 0.852 W/kg

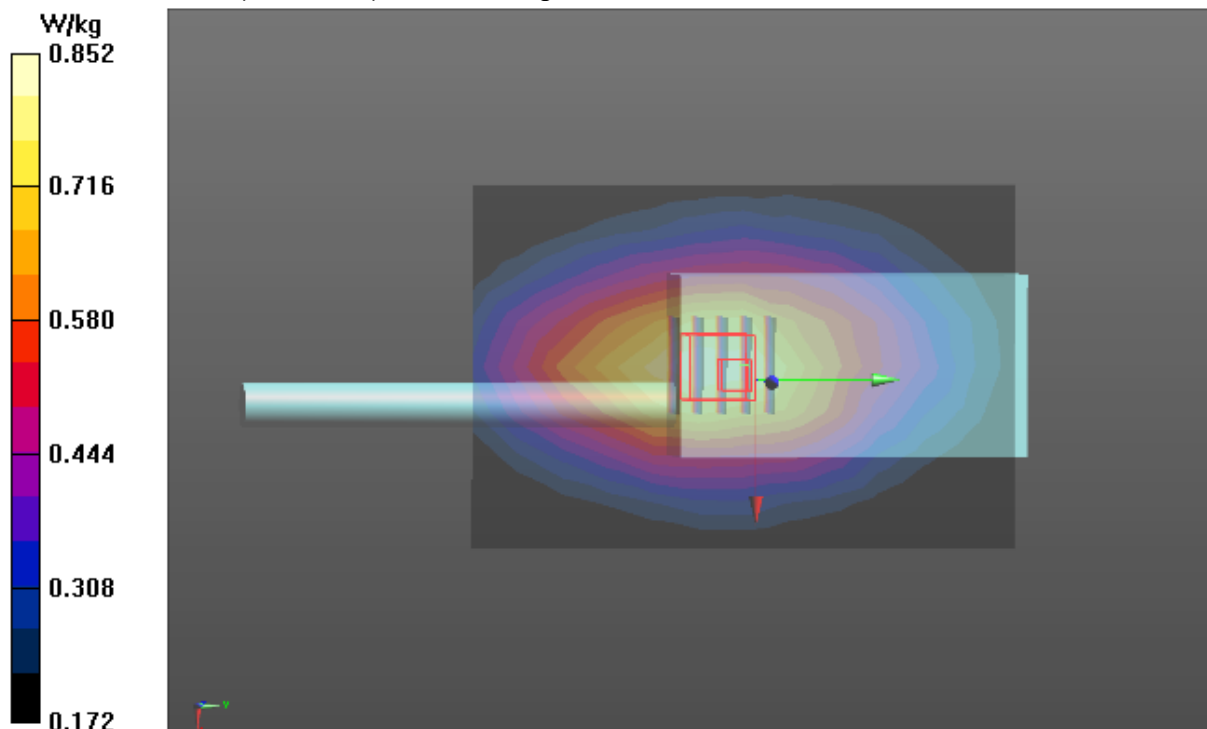

Test Laboratory: AGC Lab
450MHz High- Body - Touch (12.5 KHz)
DUT: DIGITAL RADIO ; Type: D868

Date: Apr. 17,2016

Communication System: CW; Communication System Band:450MHz; Duty Cycle: 1:1;
Frequency: 479.975MHz; Medium parameters used: $f = 450\text{MHz}$; $\sigma = 0.97\text{mho/m}$; $\epsilon_r = 56.11$; $\rho = 1000 \text{ kg/m}^3$;
Phantom Type: Elliptical Phantom
Ambient temperature (°C):21.5, Liquid temperature (°C): 21.6

DASY Configuration:

- Probe: ES3DV3-SN:3337; ConvF(6.88,6.88,6.88); Calibrated: 10/01/2015;
- Sensor-Surface: 3mm (Mechanical Surface Detection), $z = 1.0$
- Electronics: DAE4 Sn1398; Calibrated: 02/02/2016
- Phantom: ELI v5.0; Type: QDOVA002AA; Serial: TP:1210
- DASY52 52.8.7(1137); SEMCAD X 14.6.10(7164)

BACK/HIGH/Area Scan (9x13x1): Measurement grid: $dx=15\text{mm}$, $dy=15\text{mm}$
Maximum value of SAR (measured) = 1.14 W/kg

BACK/HIGH/Zoom Scan (5x5x7)/Cube 0: Measurement grid: $dx=8\text{mm}$, $dy=8\text{mm}$, $dz=5\text{mm}$
Reference Value = 32.288 V/m; Power Drift = 0.06 dB
Peak SAR (extrapolated) = 1.39 W/kg
SAR(1 g) = 1 W/kg; SAR(10 g) = 0.733 W/kg

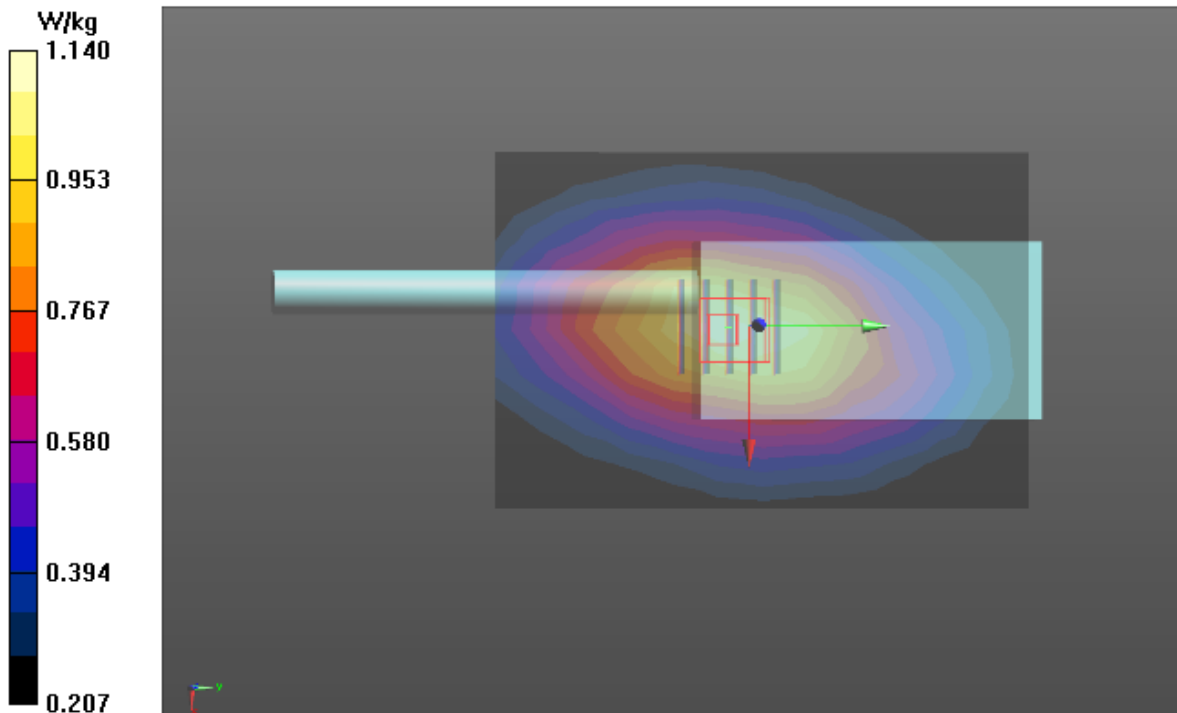

Type of signal: Analog (1W)

Test Laboratory: AGC Lab

Date: Apr. 17,2016

450MHz High- face up 2.5cm (12.5 KHz)

DUT: DIGITAL RADIO ; Type: D868

Communication System: CW; Communication System Band:450MHz; Duty Cycle: 1:1;

Frequency: 479.975 MHz; Medium parameters used: $f = 450\text{MHz}$; $\sigma = 0.90 \text{ mho/m}$; $\epsilon_r = 42.84$; $\rho = 1000 \text{ kg/m}^3$;

Phantom Type: Elliptical Phantom

Ambient temperature (°C): 21.5, Liquid temperature (°C): 21.4

DASY Configuration:

- Probe: ES3DV3-SN:3337; ConvF(6.88,6.88,6.88); Calibrated: 10/01/2015;
- Sensor-Surface: 3mm (Mechanical Surface Detection), $z = 1.0$
- Electronics: DAE4 Sn1398; Calibrated: 02/02/2016
- Phantom: ELI v5.0; Type: QDOVA002AA; Serial: TP:1210
- DASY52 52.8.7(1137); SEMCAD X 14.6.10(7164)

FRONT/HIGH/Area Scan (9x13x1): Measurement grid: $dx=15\text{mm}$, $dy=15\text{mm}$

Maximum value of SAR (measured) = 1.47 W/kg

FRONT/HIGH/Zoom Scan (5x5x7)/Cube 0: Measurement grid: $dx=8\text{mm}$, $dy=8\text{mm}$, $dz=5\text{mm}$

Reference Value = 56.739 V/m; Power Drift = 0.09 dB

Peak SAR (extrapolated) = 1.76 W/kg

SAR(1 g) = 1.35 W/kg; SAR(10 g) = 1.02 W/kg

Maximum value of SAR (measured) = 1.50 W/kg

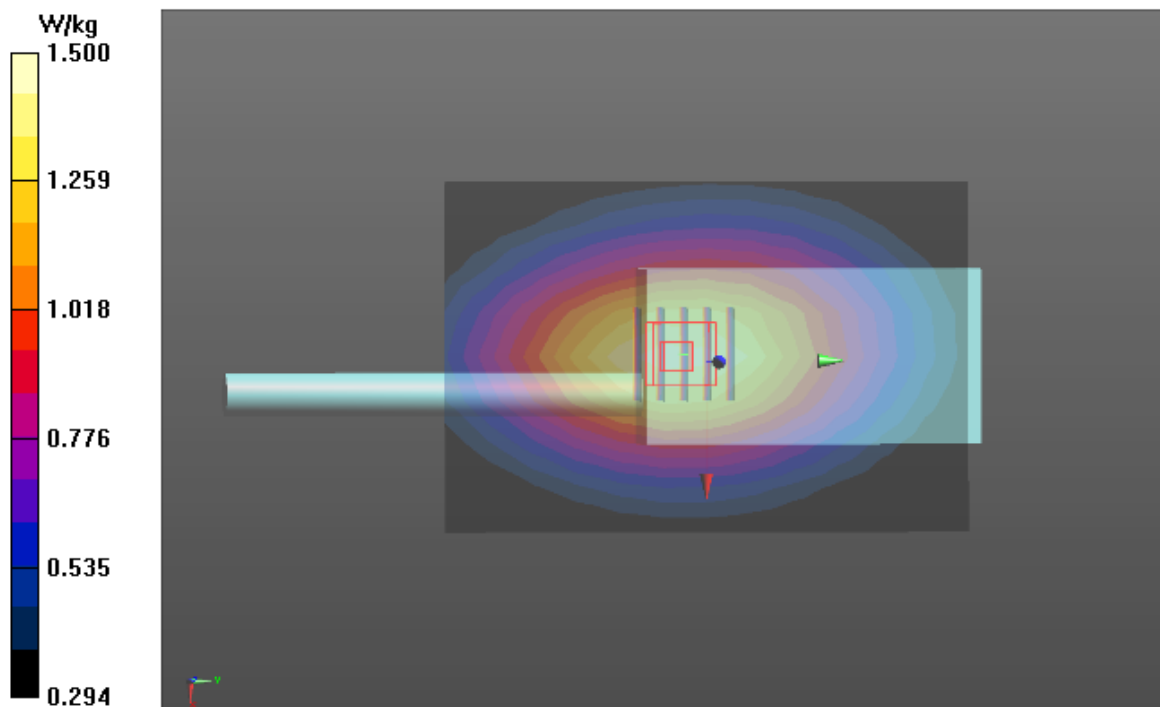

Test Laboratory: AGC Lab
450MHz High- Body - Touch (12.5 KHz)
DUT: DIGITAL RADIO ; Type: D868

Date: Apr. 17,2016

Communication System: CW; Communication System Band:450MHz; Duty Cycle: 1:1;
Frequency: 479.975MHz; Medium parameters used: $f = 450\text{MHz}$; $\sigma = 0.97\text{mho/m}$; $\epsilon_r = 56.11$; $\rho = 1000 \text{ kg/m}^3$;
Phantom Type: Elliptical Phantom
Ambient temperature (°C):21.5, Liquid temperature (°C): 21.6

DASY Configuration:

- Probe: ES3DV3-SN:3337; ConvF(6.88,6.88,6.88); Calibrated: 10/01/2015;
- Sensor-Surface: 3mm (Mechanical Surface Detection), $z = 1.0$
- Electronics: DAE4 Sn1398; Calibrated: 02/02/2016
- Phantom: ELI v5.0; Type: QDOVA002AA; Serial: TP:1210
- DASY52 52.8.7(1137); SEMCAD X 14.6.10(7164)

BACK/HIGH/Area Scan (9x13x1): Measurement grid: $dx=15\text{mm}$, $dy=15\text{mm}$
Maximum value of SAR (measured) = 3.06 W/kg

BACK/HIGH/Zoom Scan (5x5x7)/Cube 0: Measurement grid: $dx=8\text{mm}$, $dy=8\text{mm}$, $dz=5\text{mm}$
Reference Value = 56.739 V/m; Power Drift = 0.07 dB
Peak SAR (extrapolated) = 3.87 W/kg
SAR(1 g) = 2.73 W/kg; SAR(10 g) = 1.98 W/kg
Maximum value of SAR (measured) = 3.08 W/kg

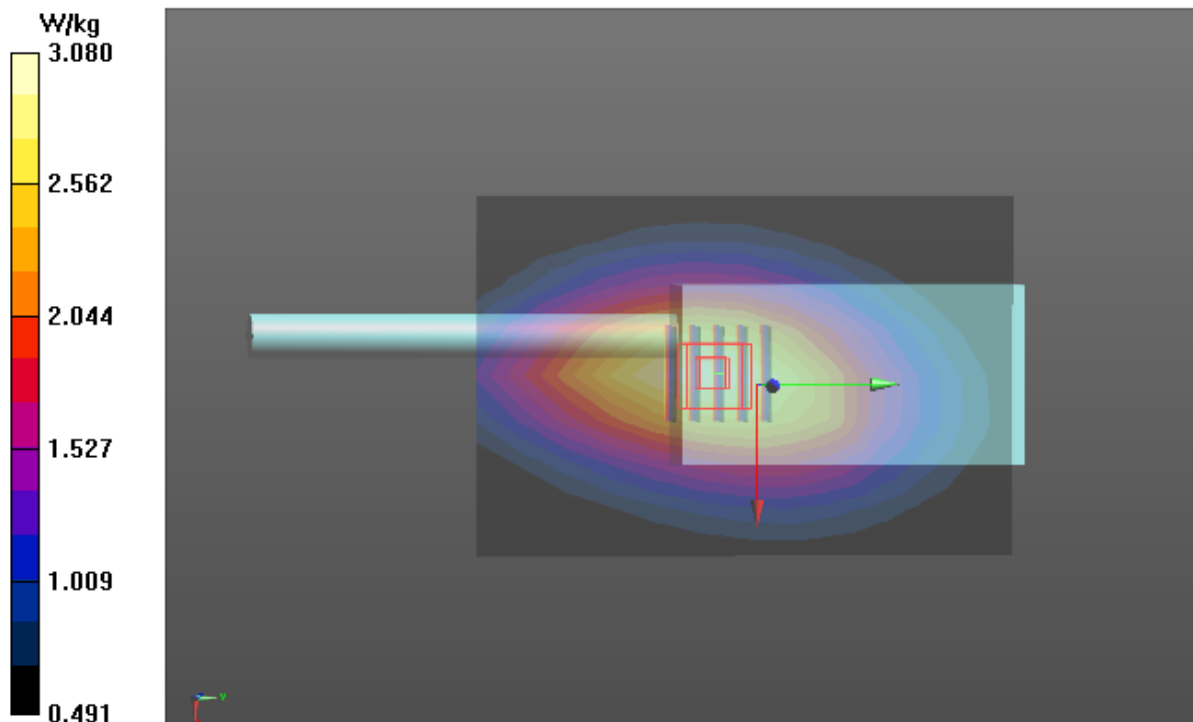

Repeated SAR

Test Laboratory: AGC Lab

Date: Apr. 17, 2016

450MHz High- Body - Touch (12.5 KHz)

DUT: DIGITAL RADIO ; Type: D868

Communication System: CW; Communication System Band:450MHz; Duty Cycle: 1:1;

Frequency: 464.025MHz; Medium parameters used: $f = 450\text{MHz}$; $\sigma = 0.97\text{mho/m}$; $\epsilon_r = 56.11$; $\rho = 1000 \text{ kg/m}^3$;

Phantom Type: Elliptical Phantom

Ambient temperature (°C):21.5, Liquid temperature (°C): 21.6

DASY Configuration:

- Probe: ES3DV3-SN:3337; ConvF(6.88,6.88,6.88); Calibrated: 10/01/2015;
- Sensor-Surface: 3mm (Mechanical Surface Detection), $z = 1.0$
- Electronics: DAE4 Sn1398; Calibrated: 02/02/2016
- Phantom: ELI v5.0; Type: QDOVA002AA; Serial: TP:1210
- DASY52 52.8.7(1137); SEMCAD X 14.6.10(7164)

BACK/REPEATED/Area Scan (9x13x1): Measurement grid: $dx=15\text{mm}$, $dy=15\text{mm}$

Maximum value of SAR (measured) = 2.89 W/kg

BACK/REPEATED/Zoom Scan (5x5x7)/Cube 0: Measurement grid: $dx=8\text{mm}$, $dy=8\text{mm}$, $dz=5\text{mm}$

Reference Value = 55.298 V/m; Power Drift = -0.02 dB

Peak SAR (extrapolated) = 3.68 W/kg

SAR(1 g) = 2.6 W/kg; SAR(10 g) = 1.89 W/kg

Maximum value of SAR (measured) = 2.93 W/kg

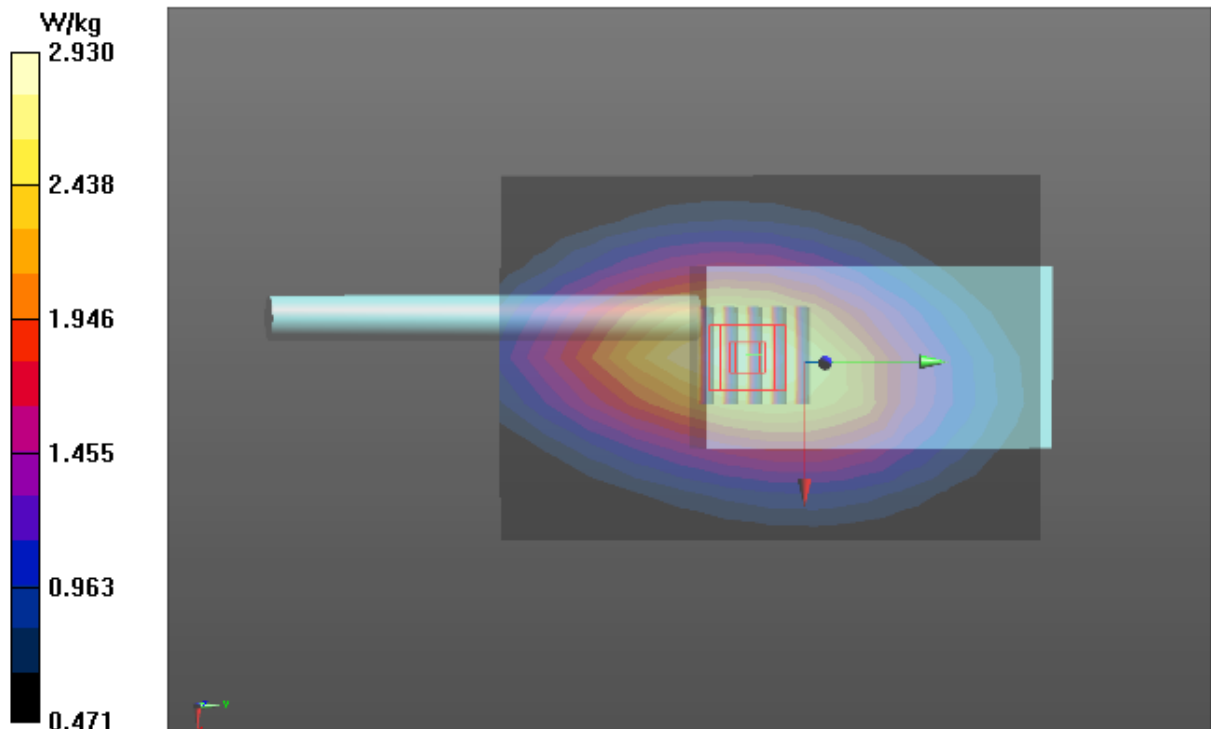

APPENDIX C. TEST SETUP PHOTOGRAPHS & EUT PHOTOGRAPHS

Test Setup Photographs

Face Up with 2.5 cm Separation Distance.



Body Back Touch with all accessories





Note : The headset is just for testing. This tested and electrically similar headsets may be used.

DEPTH OF THE LIQUID IN THE PHANTOM—ZOOM IN

Note: The position used in the measurement were according to IEEE 1528

450MHz Head

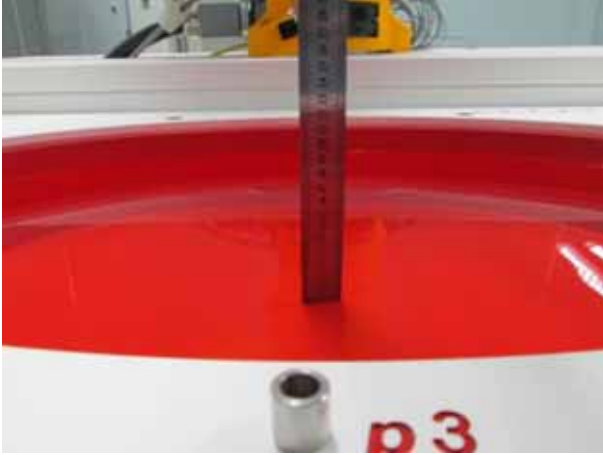

450MHz Body



EUT PHOTOGRAPHS
TOTAL VIEW OF EUT



TOP VIEW OF EUT



BOTTOM VIEW OF EUT



FRONT VIEW OF EUT



BACK VIEW OF EUT



LEFT VIEW OF EUT



RIGHT VIEW OF EUT



OPEN VIEW-1 OF EUT



OPEN VIEW-2 OF EUT



OPEN VIEW-3 OF EUT



INTERNAL VIEW-1 OF EUT

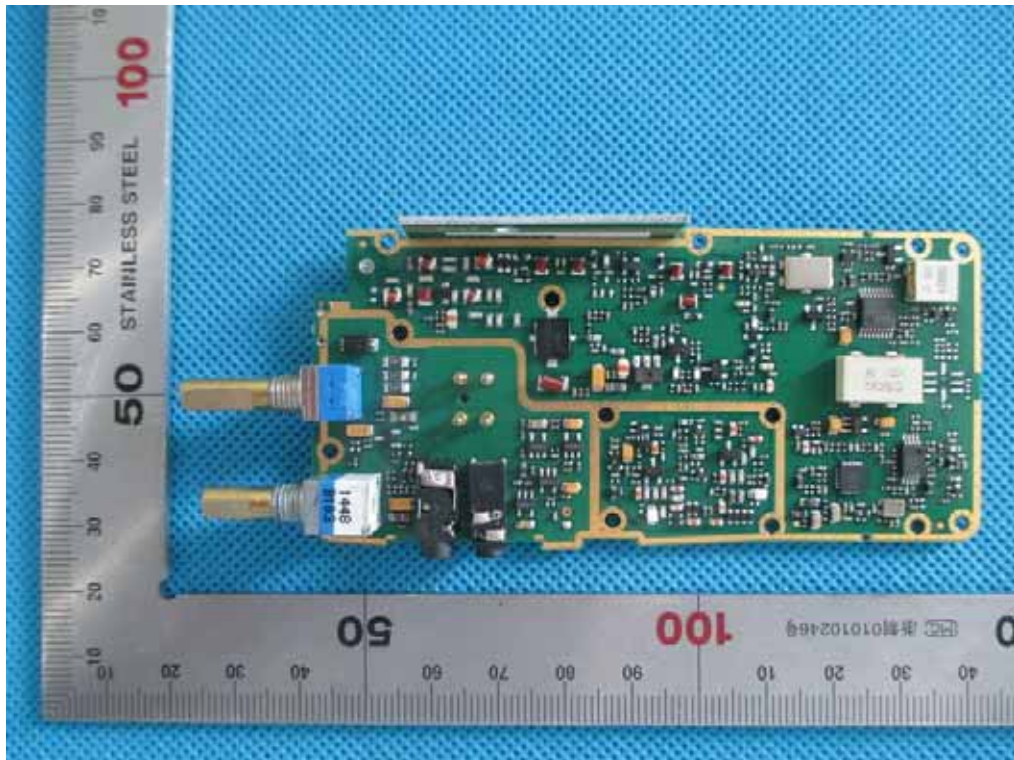

INTERNAL VIEW-2 OF EUT

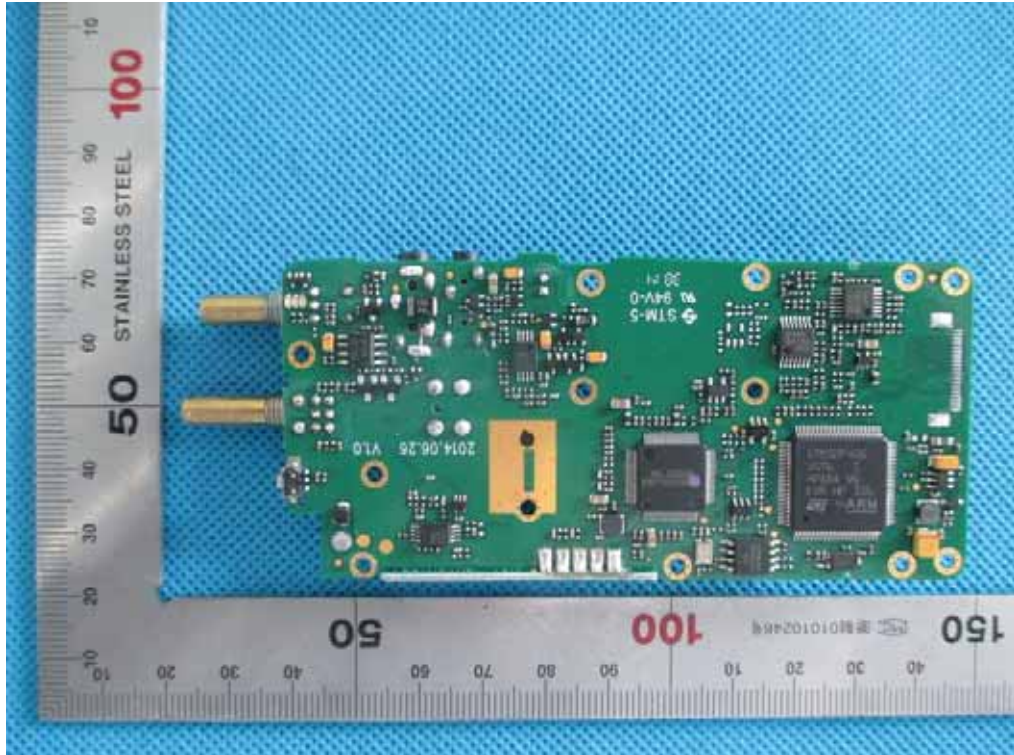

APPENDIX D. PROBE CALIBRATION DATA

**Calibration Laboratory of
Schmid & Partner
Engineering AG**
Zeughausstrasse 43, 8004 Zurich, Switzerland



S Schweizerischer Kalibrierdienst
C Service suisse d'étalonnage
S Servizio svizzero di taratura
S Swiss Calibration Service

Accredited by the Swiss Accreditation Service (SAS)
The Swiss Accreditation Service is one of the signatories to the EA
Multilateral Agreement for the recognition of calibration certificates

Accreditation No.: **SCS 108**

Client **AGC-CERT (Auden)**

Certificate No: **ES3-3337_Sep14**

CALIBRATION CERTIFICATE

Object **ES3DV3 - SN:3337**

Calibration procedure(s) **QA CAL-01.v9, QA CAL-12.v9, QA CAL-23.v5, QA CAL-25.v6
Calibration procedure for dosimetric E-field probes**

Calibration date **September 5, 2014**

This calibration certificate documents the traceability to national standards, which realize the physical units of measurements (SI).
The measurements and the uncertainties with confidence probability are given on the following pages and are part of the certificate.

All calibrations have been conducted in the closed laboratory facility; environment temperature (22 ± 3)°C and humidity < 70%.

Calibration Equipment used (M&TE critical for calibration)

Primary Standards	ID	Cal Date (Certificate No.)	Scheduled Calibration
Power meter E4419B	GB41293874	03-Apr-14 (No. 217-01911)	Apr-15
Power sensor E4412A	MY41498087	03-Apr-14 (No. 217-01911)	Apr-15
Reference 3 dB Attenuator	SN: S5054 (3c)	03-Apr-14 (No. 217-01915)	Apr-15
Reference 20 dB Attenuator	SN: S5277 (20x)	03-Apr-14 (No. 217-01919)	Apr-15
Reference 30 dB Attenuator	SN: S5129 (30b)	03-Apr-14 (No. 217-01920)	Apr-15
Reference Probe ES3DV2	SN: 3013	30-Dec-13 (No. ES3-3013, Dec13)	Dec-14
DAE4	SN: 660	13-Dec-13 (No. DAE4-660, Dec13)	Dec-14
Secondary Standards	ID	Check Date (in house)	Scheduled Check
RF generator HP 8648C	US3642U01700	4-Aug-99 (in house check Apr-13)	In house check: Apr-16
Network Analyzer HP 8753E	US37390585	16-Oct-01 (in house check Oct-13)	In house check: Oct-14

	Name	Function	Signature
Calibrated by:	Jeton Kastrati	Laboratory Technician	
Approved by:	Katja Pokovic	Technical Manager	

Issued: September 6, 2014

This calibration certificate shall not be reproduced except in full without written approval of the laboratory.

Calibration Laboratory of
Schmid & Partner
Engineering AG
Zeughausstrasse 43, 8004 Zurich, Switzerland



S Schweizerischer Kalibrierdienst
C Service suisse d'étalonnage
S Servizio svizzero di taratura
S Swiss Calibration Service

Accredited by the Swiss Accreditation Service (SAS)
The Swiss Accreditation Service is one of the signatories to the EA
Multilateral Agreement for the recognition of calibration certificates

Accreditation No.: SCS 108

Glossary:

TSL	tissue simulating liquid
NORM _{x,y,z}	sensitivity in free space
ConvF	sensitivity in TSL / NORM _{x,y,z}
DCP	diode compression point
CF	crest factor (1/duty_cycle) of the RF signal
A, B, C, D	modulation dependent linearization parameters
Polarization φ	φ rotation around probe axis
Polarization θ	θ rotation around an axis that is in the plane normal to probe axis (at measurement center), i.e., $\theta = 0$ is normal to probe axis
Connector Angle	information used in DASY system to align probe sensor X to the robot coordinate system

Calibration is Performed According to the Following Standards:

- a) IEEE Std 1528-2013, "IEEE Recommended Practice for Determining the Peak Spatial-Averaged Specific Absorption Rate (SAR) in the Human Head from Wireless Communications Devices: Measurement Techniques", June 2013
- b) IEC 62209-1, "Procedure to measure the Specific Absorption Rate (SAR) for hand-held devices used in close proximity to the ear (frequency range of 300 MHz to 3 GHz)", February 2005

Methods Applied and Interpretation of Parameters:

- **NORM_{x,y,z}**: Assessed for E-field polarization $\theta = 0$ ($f \leq 900$ MHz in TEM-cell; $f > 1800$ MHz: R22 waveguide). NORM_{x,y,z} are only intermediate values, i.e., the uncertainties of NORM_{x,y,z} does not affect the E²-field uncertainty inside TSL (see below ConvF).
- **NORM(f)_{x,y,z} = NORM_{x,y,z} * frequency_response** (see Frequency Response Chart). This linearization is implemented in DASY4 software versions later than 4.2. The uncertainty of the frequency response is included in the stated uncertainty of ConvF.
- **DCP_{x,y,z}**: DCP are numerical linearization parameters assessed based on the data of power sweep with CW signal (no uncertainty required). DCP does not depend on frequency nor media.
- **PAR**: PAR is the Peak to Average Ratio that is not calibrated but determined based on the signal characteristics
- **A_{x,y,z}; B_{x,y,z}; C_{x,y,z}; D_{x,y,z}; VR_{x,y,z}**: A, B, C, D are numerical linearization parameters assessed based on the data of power sweep for specific modulation signal. The parameters do not depend on frequency nor media. VR is the maximum calibration range expressed in RMS voltage across the diode.
- **ConvF and Boundary Effect Parameters**: Assessed in flat phantom using E-field (or Temperature Transfer Standard for $f \leq 800$ MHz) and inside waveguide using analytical field distributions based on power measurements for $f > 800$ MHz. The same setups are used for assessment of the parameters applied for boundary compensation (alpha, depth) of which typical uncertainty values are given. These parameters are used in DASY4 software to improve probe accuracy close to the boundary. The sensitivity in TSL corresponds to NORM_{x,y,z} * ConvF whereby the uncertainty corresponds to that given for ConvF. A frequency dependent ConvF is used in DASY version 4.4 and higher which allows extending the validity from ± 50 MHz to ± 100 MHz.
- **Spherical isotropy (3D deviation from isotropy)**: in a field of low gradients realized using a flat phantom exposed by a patch antenna.
- **Sensor Offset**: The sensor offset corresponds to the offset of virtual measurement center from the probe tip (on probe axis). No tolerance required.
- **Connector Angle**: The angle is assessed using the information gained by determining the NORM_x (no uncertainty required).

ES3DV3 – SN:3337

September 5, 2014

Probe ES3DV3

SN:3337

Manufactured:	January 24, 2012
Repaired:	August 25, 2014
Calibrated:	September 5, 2014

Calibrated for DASY/EASY Systems
(Note: non-compatible with DASY2 system!)

ES3DV3- SN:3337

September 5, 2014

DASY/EASY - Parameters of Probe: ES3DV3 - SN:3337

Basic Calibration Parameters

	Sensor X	Sensor Y	Sensor Z	Unc (k=2)
Norm ($\mu\text{V}/(\text{V}/\text{m})^2$) ^A	1.11	0.97	1.00	$\pm 10.1 \%$
DCP (mV) ^B	104.8	103.8	103.8	

Modulation Calibration Parameters

UID	Communication System Name		A dB	B dB $\sqrt{\mu\text{V}}$	C	D dB	VR mV	Unc ^C (k=2)
0	CW	X	0.0	0.0	1.0	0.00	168.6	$\pm 3.8 \%$
		Y	0.0	0.0	1.0		183.6	
		Z	0.0	0.0	1.0		184.7	

The reported uncertainty of measurement is stated as the standard uncertainty of measurement multiplied by the coverage factor $k=2$, which for a normal distribution corresponds to a coverage probability of approximately 95%.

^A The uncertainties of NormX,Y,Z do not affect the E²-field uncertainty inside TSL (see Pages 5 and 6).

^B Numerical linearization parameter, uncertainty not required.

^C Uncertainty is determined using the max. deviation from linear response applying rectangular distribution and is expressed for the square of the field value.

ES3DV3- SN:3337

September 5, 2014

DASY/EASY - Parameters of Probe: ES3DV3 - SN:3337

Calibration Parameter Determined in Head Tissue Simulating Media

f (MHz) ^c	Relative Permittivity ^f	Conductivity (S/m) ^f	ConvF X	ConvF Y	ConvF Z	Alpha ^g	Depth (mm) ^g	Unct. (k=2)
150	52.3	0.76	7.56	7.56	7.56	0.07	1.20	± 13.3 %
450	43.5	0.87	6.71	6.71	6.71	0.21	1.90	± 13.3 %

^c Frequency validity above 300 MHz of ± 100 MHz only applies for DASY v4.4 and higher (see Page 2), else it is restricted to ± 50 MHz. The uncertainty is the RSS of the ConvF uncertainty at calibration frequency and the uncertainty for the indicated frequency band. Frequency validity below 300 MHz is ± 10, 25, 40, 50 and 70 MHz for ConvF assessments at 30, 64, 128, 150 and 220 MHz respectively. Above 5 GHz frequency validity can be extended to ± 110 MHz.

^f At frequencies below 3 GHz, the validity of tissue parameters (ϵ and σ) can be relaxed to ± 10% if liquid compensation formula is applied to measured SAR values. At frequencies above 3 GHz, the validity of tissue parameters (ϵ and σ) is restricted to ± 5%. The uncertainty is the RSS of the ConvF uncertainty for indicated target tissue parameters.

^g Alpha/Depth are determined during calibration. SPEAG warrants that the remaining deviation due to the boundary effect after compensation is always less than ± 1% for frequencies below 3 GHz and below ± 2% for frequencies between 3-6 GHz at any distance larger than half the probe tip diameter from the boundary.

ES3DV3- SN:3337

September 5, 2014

DASY/EASY - Parameters of Probe: ES3DV3 - SN:3337

Calibration Parameter Determined in Body Tissue Simulating Media

f (MHz) ^c	Relative Permittivity ^f	Conductivity (S/m) ^f	ConvF X	ConvF Y	ConvF Z	Alpha ^g	Depth ^g (mm)	Unct. (k=2)
150	61.9	0.80	7.17	7.17	7.17	0.07	1.20	± 13.3 %
450	56.7	0.94	7.08	7.08	7.08	0.12	1.50	± 13.3 %

^c Frequency validity above 300 MHz of ± 100 MHz only applies for DASY v4.4 and higher (see Page 2), else it is restricted to ± 50 MHz. The uncertainty is the RSS of the ConvF uncertainty at calibration frequency and the uncertainty for the indicated frequency band. Frequency validity below 300 MHz is ± 10, 25, 40, 50 and 70 MHz for ConvF assessments at 30, 64, 128, 150 and 220 MHz respectively. Above 5 GHz frequency validity can be extended to ± 110 MHz.

^f At frequencies below 3 GHz, the validity of tissue parameters (ϵ and σ) can be relaxed to ± 10% if liquid compensation formula is applied to measured SAR values. At frequencies above 3 GHz, the validity of tissue parameters (ϵ and σ) is restricted to ± 5%. The uncertainty is the RSS of the ConvF uncertainty for indicated target tissue parameters.

^g Alpha/Depth are determined during calibration. SPEAG warrants that the remaining deviation due to the boundary effect after compensation is always less than ± 1% for frequencies below 3 GHz and below ± 2% for frequencies between 3-6 GHz at any distance larger than half the probe tip diameter from the boundary.

ES3DV3-SN:3337

September 5, 2014

Frequency Response of E-Field (TEM-Cell:ifi110 EXX, Waveguide: R22)

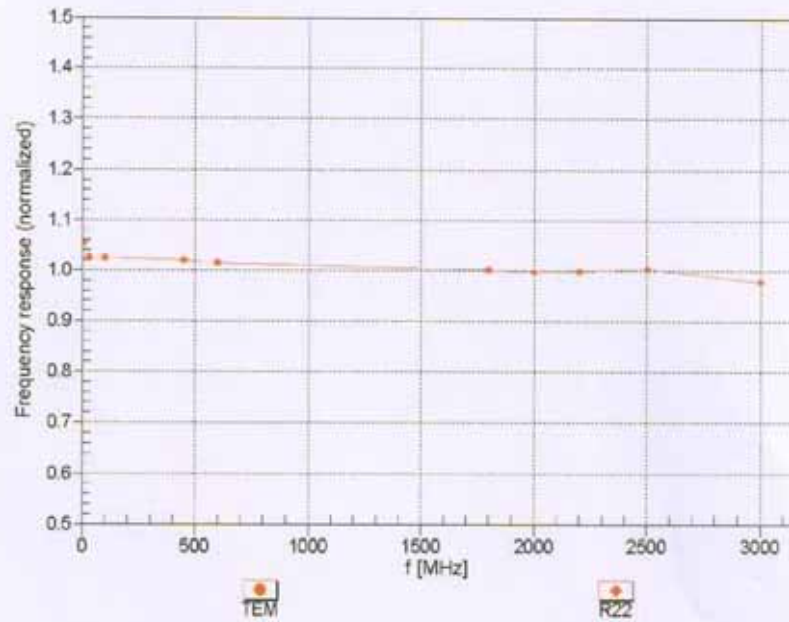

Uncertainty of Frequency Response of E-field: $\pm 6.3\%$ (k=2)

ES30V3-SN:3337

September 5, 2014

Receiving Pattern (ϕ), $\theta = 0^\circ$

f=600 MHz,TEM

f=1800 MHz,R22

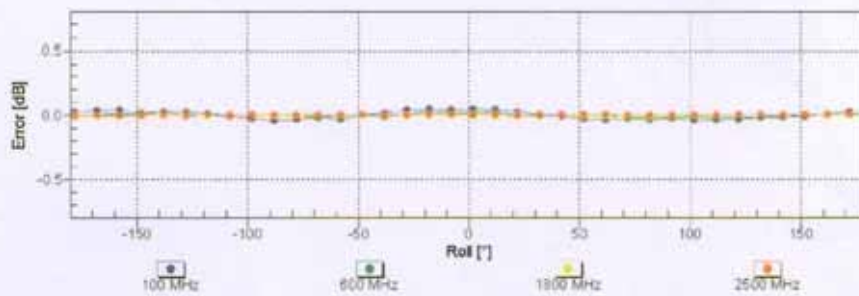
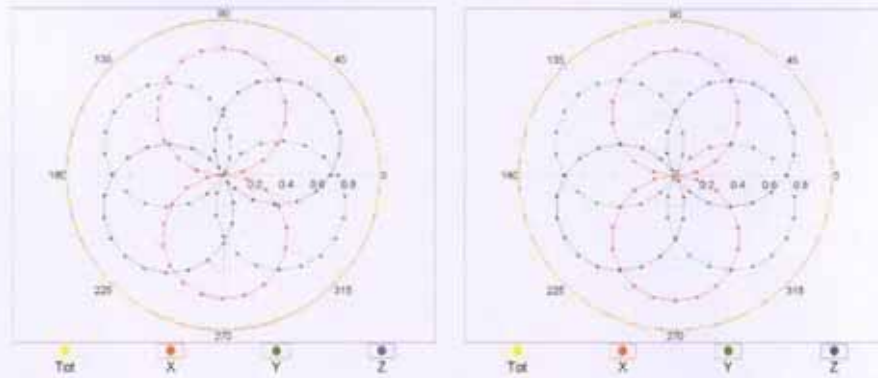

Uncertainty of Axial Isotropy Assessment: $\pm 0.5\%$ ($k=2$)

ES3DV3- SN:3337

September 5, 2014

Dynamic Range $f(SAR_{head})$ (TEM cell , $f_{eval}= 1900$ MHz)

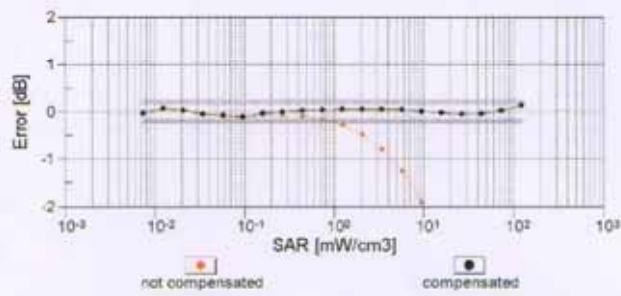
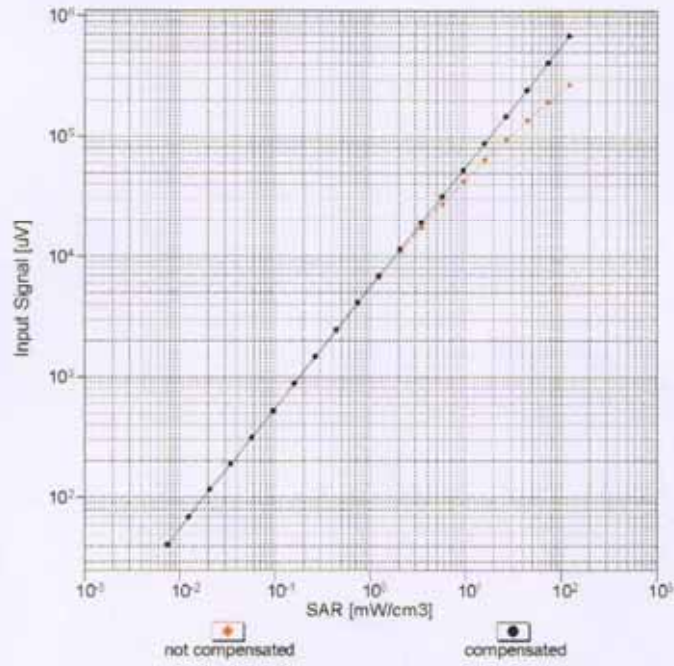

Uncertainty of Linearity Assessment: $\pm 0.6\%$ (k=2)

ES3DV3-SN:3337

September 5, 2014

Conversion Factor Assessment

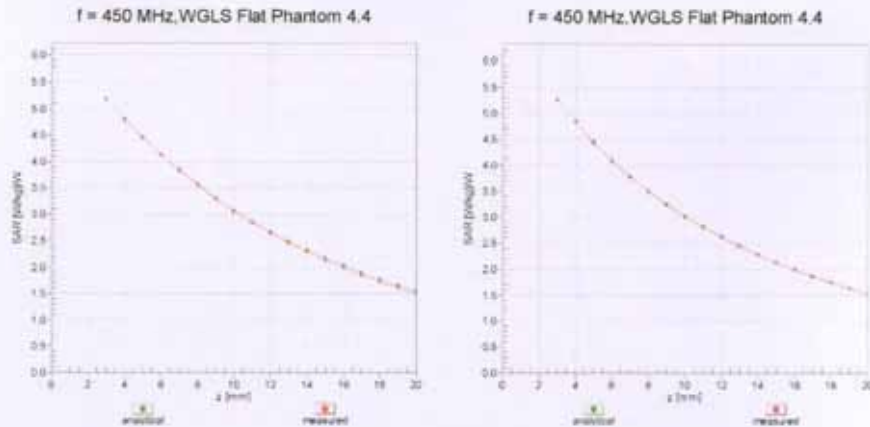

Deviation from Isotropy in Liquid Error (ϕ, θ), f = 900 MHz

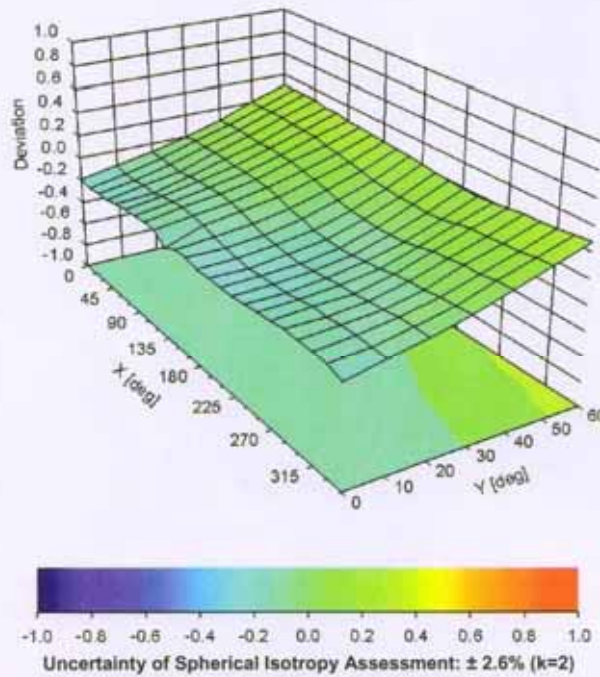

ES3DV3- SN:3337

September 5, 2014

DASY/EASY - Parameters of Probe: ES3DV3 - SN:3337

Other Probe Parameters

Sensor Arrangement	Triangular
Connector Angle (°)	-8.1
Mechanical Surface Detection Mode	enabled
Optical Surface Detection Mode	disabled
Probe Overall Length	337 mm
Probe Body Diameter	10 mm
Tip Length	10 mm
Tip Diameter	4 mm
Probe Tip to Sensor X Calibration Point	2 mm
Probe Tip to Sensor Y Calibration Point	2 mm
Probe Tip to Sensor Z Calibration Point	2 mm
Recommended Measurement Distance from Surface	2 mm

**Calibration Laboratory of
Schmid & Partner
Engineering AG**
Zeughausstrasse 43, 8004 Zurich, Switzerland



S Schweizerischer Kalibrierdienst
C Service suisse d'étalonnage
S Servizio svizzero di taratura
S Swiss Calibration Service

Accredited by the Swiss Accreditation Service (SAS)
The Swiss Accreditation Service is one of the signatories to the EA
Multilateral Agreement for the recognition of calibration certificates

Accreditation No.: **SCS 0108**

Client **AGC-CERT (Auden)**

Certificate No: **ES3-3337_Oct15**

CALIBRATION CERTIFICATE

Object **ES3DV3 - SN:3337**

Calibration procedure(s) **QA CAL-01.v9, QA CAL-12.v9, QA CAL-23.v5, QA CAL-25.v6
Calibration procedure for dosimetric E-field probes**

Calibration date: **October 1, 2015**

This calibration certificate documents the traceability to national standards, which realize the physical units of measurements (SI).
The measurements and the uncertainties with confidence probability are given on the following pages and are part of the certificate.

All calibrations have been conducted in the closed laboratory facility: environment temperature (22 ± 3)°C and humidity < 70%.

Calibration Equipment used (M&TE critical for calibration)

Primary Standards	ID	Cal Date (Certificate No.)	Scheduled Calibration
Power meter E4419B	GB41293874	01-Apr-15 (No. 217-02128)	Mar-16
Power sensor E4412A	MY41498087	01-Apr-15 (No. 217-02128)	Mar-16
Reference 3 dB Attenuator	SN: S5054 (3c)	01-Apr-15 (No. 217-02129)	Mar-16
Reference 20 dB Attenuator	SN: S5277 (20x)	01-Apr-15 (No. 217-02132)	Mar-16
Reference 30 dB Attenuator	SN: S5129 (30b)	01-Apr-15 (No. 217-02133)	Mar-16
Reference Probe E53DV2	SN: 3013	30-Dec-14 (No. ES3-3013_Dec14)	Dec-15
DAE4	SN: 660	14-Jan-15 (No. DAE4-660_Jan15)	Jan-16
Secondary Standards	ID	Check Date (in house)	Scheduled Check
RF generator HP 8648C	US3642U01700	4-Aug-99 (in house check Apr-13)	In house check: Apr-16
Network Analyzer HP 8753E	US37390585	18-Oct-01 (in house check Oct-14)	In house check: Oct-15

	Name	Function	Signature
Calibrated by:	Israa Elnaouq	Laboratory Technician	
Approved by:	Katja Pokovic	Technical Manager	
			Issued: October 2, 2015

This calibration certificate shall not be reproduced except in full without written approval of the laboratory.

**Calibration Laboratory of
Schmid & Partner
Engineering AG**
Zeughausstrasse 43, 8004 Zurich, Switzerland



S Schweizerischer Kalibrierdienst
C Service suisse d'étalonnage
S Servizio svizzero di taratura
S Swiss Calibration Service

Accredited by the Swiss Accreditation Service (SAS)
The Swiss Accreditation Service is one of the signatories to the EA
Multilateral Agreement for the recognition of calibration certificates

Accreditation No.: **SCS 0108**

Glossary:

TSL	tissue simulating liquid
NORM _{x,y,z}	sensitivity in free space
ConvF	sensitivity in TSL / NORM _{x,y,z}
DCP	diode compression point
CF	crest factor (1/duty_cycle) of the RF signal
A, B, C, D	modulation dependent linearization parameters
Polarization φ	φ rotation around probe axis
Polarization θ	θ rotation around an axis that is in the plane normal to probe axis (at measurement center), i.e., θ = 0 is normal to probe axis
Connector Angle	information used in DASY system to align probe sensor X to the robot coordinate system

Calibration is Performed According to the Following Standards:

- a) IEEE Std 1528-2013, "IEEE Recommended Practice for Determining the Peak Spatial-Averaged Specific Absorption Rate (SAR) in the Human Head from Wireless Communications Devices: Measurement Techniques", June 2013
- b) IEC 62209-1, "Procedure to measure the Specific Absorption Rate (SAR) for hand-held devices used in close proximity to the ear (frequency range of 300 MHz to 3 GHz)", February 2005
- c) IEC 62209-2, "Procedure to determine the Specific Absorption Rate (SAR) for wireless communication devices used in close proximity to the human body (frequency range of 30 MHz to 6 GHz)", March 2010
- d) KDB 865664, "SAR Measurement Requirements for 100 MHz to 6 GHz"

Methods Applied and Interpretation of Parameters:

- **NORM_{x,y,z}**: Assessed for E-field polarization θ = 0 (f ≤ 900 MHz in TEM-cell; f > 1800 MHz: R22 waveguide). NORM_{x,y,z} are only intermediate values, i.e., the uncertainties of NORM_{x,y,z} does not affect the E²-field uncertainty inside TSL (see below ConvF).
- **NORM(f)_{x,y,z} = NORM_{x,y,z} * frequency_response** (see Frequency Response Chart). This linearization is implemented in DASY4 software versions later than 4.2. The uncertainty of the frequency response is included in the stated uncertainty of ConvF.
- **DCP_{x,y,z}**: DCP are numerical linearization parameters assessed based on the data of power sweep with CW signal (no uncertainty required). DCP does not depend on frequency nor media.
- **PAR**: PAR is the Peak to Average Ratio that is not calibrated but determined based on the signal characteristics
- **A_{x,y,z}; B_{x,y,z}; C_{x,y,z}; D_{x,y,z}; VR_{x,y,z}**: A, B, C, D are numerical linearization parameters assessed based on the data of power sweep for specific modulation signal. The parameters do not depend on frequency nor media. VR is the maximum calibration range expressed in RMS voltage across the diode.
- **ConvF and Boundary Effect Parameters**: Assessed in flat phantom using E-field (or Temperature Transfer Standard for f ≤ 800 MHz) and inside waveguide using analytical field distributions based on power measurements for f > 800 MHz. The same setups are used for assessment of the parameters applied for boundary compensation (alpha, depth) of which typical uncertainty values are given. These parameters are used in DASY4 software to improve probe accuracy close to the boundary. The sensitivity in TSL corresponds to NORM_{x,y,z} * ConvF whereby the uncertainty corresponds to that given for ConvF. A frequency dependent ConvF is used in DASY version 4.4 and higher which allows extending the validity from ± 50 MHz to ± 100 MHz.
- **Spherical isotropy (3D deviation from isotropy)**: in a field of low gradients realized using a flat phantom exposed by a patch antenna.
- **Sensor Offset**: The sensor offset corresponds to the offset of virtual measurement center from the probe tip (on probe axis). No tolerance required.
- **Connector Angle**: The angle is assessed using the information gained by determining the NORM_x (no uncertainty required).

ES3DV3 – SN:3337

October 1, 2015

Probe ES3DV3

SN:3337

Manufactured: January 24, 2012
Calibrated: October 1, 2015

Calibrated for DASY/EASY Systems
(Note: non-compatible with DASY2 system!)

ES3DV3- SN:3337

October 1, 2015

DASY/EASY - Parameters of Probe: ES3DV3 - SN:3337

Basic Calibration Parameters

	Sensor X	Sensor Y	Sensor Z	Unc (k=2)
Norm ($\mu\text{V}/(\text{V/m})^2$) ^A	1.10	0.96	1.00	$\pm 10.1\%$
DCP (mV) ^B	106.0	105.9	103.4	

Modulation Calibration Parameters

UID	Communication System Name		A dB	B dB $\sqrt{\mu\text{V}}$	C	D dB	VR mV	Unc ^C (k=2)
0	CW	X	0.0	0.0	1.0	0.00	192.9	$\pm 3.3\%$
		Y	0.0	0.0	1.0		183.2	
		Z	0.0	0.0	1.0		197.3	

The reported uncertainty of measurement is stated as the standard uncertainty of measurement multiplied by the coverage factor k=2, which for a normal distribution corresponds to a coverage probability of approximately 95%.

^A The uncertainties of Norm X,Y,Z do not affect the E²-field uncertainty inside TSL (see Pages 5 and 6).

^B Numerical linearization parameter: uncertainty not required.

^C Uncertainty is determined using the max. deviation from linear response applying rectangular distribution and is expressed for the square of the field value.

ES3DV3- SN:3337

October 1, 2015

DASY/EASY - Parameters of Probe: ES3DV3 - SN:3337

Calibration Parameter Determined in Head Tissue Simulating Media

f (MHz) ^c	Relative Permittivity ^f	Conductivity (S/m) ^f	ConvF X	ConvF Y	ConvF Z	Alpha ^g	Depth (mm) ^g	Unc (k=2)
150	52.3	0.76	7.63	7.63	7.63	0.04	1.20	± 13.3 %
450	43.5	0.87	6.88	6.88	6.88	0.25	2.20	± 13.3 %
835	41.5	0.90	6.32	6.32	6.32	0.49	1.45	± 12.0 %
900	41.5	0.97	6.23	6.23	6.23	0.37	1.68	± 12.0 %
1810	40.0	1.40	5.28	5.28	5.28	0.51	1.53	± 12.0 %
1900	40.0	1.40	5.23	5.23	5.23	0.80	1.16	± 12.0 %
2100	39.8	1.49	5.28	5.28	5.28	0.62	1.35	± 12.0 %
2450	39.2	1.80	4.66	4.66	4.66	0.80	1.25	± 12.0 %

^c Frequency validity above 300 MHz of ± 100 MHz only applies for DASY v4.4 and higher (see Page 2), else it is restricted to ± 50 MHz. The uncertainty is the RSS of the ConvF uncertainty at calibration frequency and the uncertainty for the indicated frequency band. Frequency validity below 300 MHz is ± 10, 25, 40, 50 and 70 MHz for ConvF assessments at 30, 64, 128, 150 and 220 MHz respectively. Above 5 GHz frequency validity can be extended to ± 110 MHz.

^f At frequencies below 3 GHz, the validity of tissue parameters (ϵ and σ) can be relaxed to ± 10% if liquid compensation formula is applied to measured SAR values. At frequencies above 3 GHz, the validity of tissue parameters (ϵ and σ) is restricted to ± 5%. The uncertainty is the RSS of the ConvF uncertainty for indicated target tissue parameters.

^g Alpha/Depth are determined during calibration. SPEAG warrants that the remaining deviation due to the boundary effect after compensation is always less than ± 1% for frequencies below 3 GHz and below ± 2% for frequencies between 3-6 GHz at any distance larger than half the probe tip diameter from the boundary.

ES3DV3- SN:3337

October 1, 2015

DASY/EASY - Parameters of Probe: ES3DV3 - SN:3337

Calibration Parameter Determined in Body Tissue Simulating Media

f (MHz) ^c	Relative Permittivity ^f	Conductivity (S/m) ^f	ConvF X	ConvF Y	ConvF Z	Alpha ^g	Depth (mm) ^g	Unc (k=2)
150	61.9	0.80	7.24	7.24	7.24	0.06	1.20	± 13.3 %
450	56.7	0.94	7.12	7.12	7.12	0.15	1.74	± 13.3 %
835	55.2	0.97	6.31	6.31	6.31	0.43	1.63	± 12.0 %
900	55.0	1.05	6.29	6.29	6.29	0.35	1.81	± 12.0 %
1810	53.3	1.52	4.94	4.94	4.94	0.54	1.48	± 12.0 %
1900	53.3	1.52	4.83	4.83	4.83	0.45	1.78	± 12.0 %
2100	53.2	1.62	4.90	4.90	4.90	0.67	1.39	± 12.0 %
2450	52.7	1.95	4.36	4.36	4.36	0.80	1.14	± 12.0 %

^c Frequency validity above 300 MHz of ± 100 MHz only applies for DASY v4.4 and higher (see Page 2), else it is restricted to ± 50 MHz. The uncertainty is the RSS of the ConvF uncertainty at calibration frequency and the uncertainty for the indicated frequency band. Frequency validity below 300 MHz is ± 10, 25, 40, 50 and 70 MHz for ConvF assessments at 30, 64, 128, 150 and 220 MHz respectively. Above 5 GHz frequency validity can be extended to ± 110 MHz.

^f At frequencies below 3 GHz, the validity of tissue parameters (ϵ and σ) can be relaxed to ± 10% if liquid compensation formula is applied to measured SAR values. At frequencies above 3 GHz, the validity of tissue parameters (ϵ and σ) is restricted to ± 5%. The uncertainty is the RSS of the ConvF uncertainty for indicated target tissue parameters.

^g Alpha/Depth are determined during calibration. SPEAG warrants that the remaining deviation due to the boundary effect after compensation is always less than ± 1% for frequencies below 3 GHz and below ± 2% for frequencies between 3-6 GHz at any distance larger than half the probe tip diameter from the boundary.

ES3DV3- SN:3337

October 1, 2015

Frequency Response of E-Field (TEM-Cell:ifi110 EXX, Waveguide: R22)

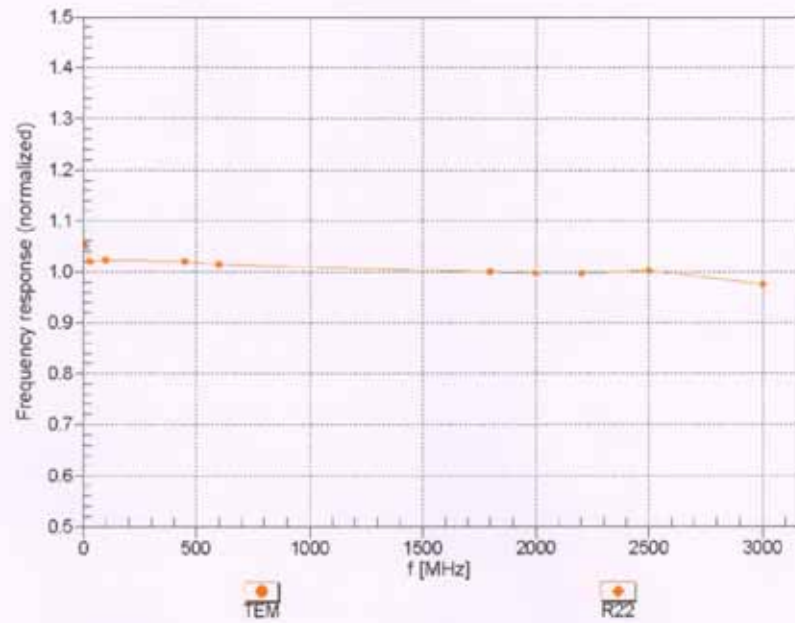

Uncertainty of Frequency Response of E-field: $\pm 6.3\%$ (k=2)

ES3DV3- SN:3337

October 1, 2015

Receiving Pattern (ϕ), $\theta = 0^\circ$

f=600 MHz,TEM

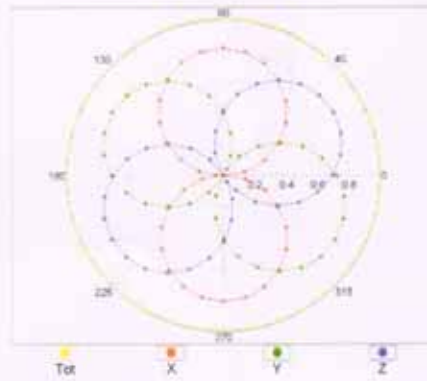

f=1800 MHz,R22

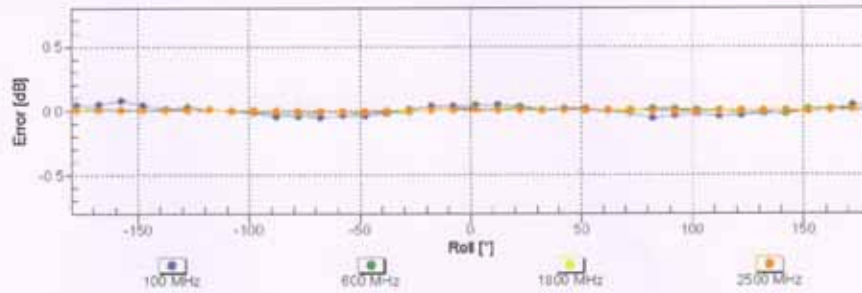
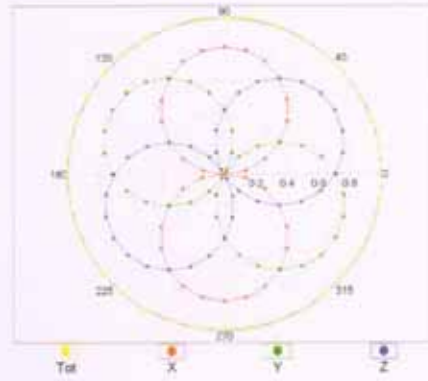

Uncertainty of Axial Isotropy Assessment: $\pm 0.5\%$ (k=2)

ES3DV3- SN:3337

October 1, 2015

Dynamic Range f(SAR_{head}) (TEM cell , f_{eval}= 1900 MHz)

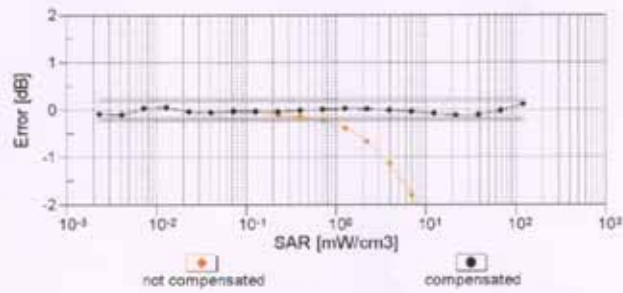
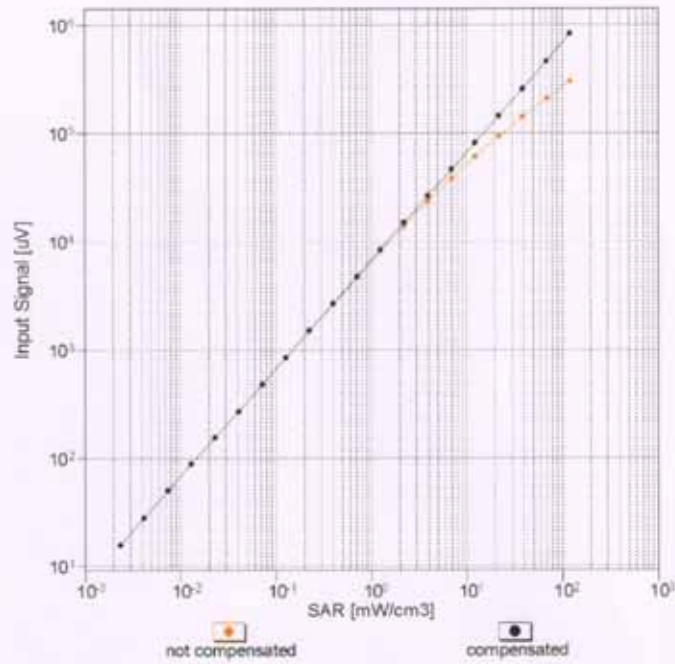

Uncertainty of Linearity Assessment: ± 0.6% (k=2)

ES3DV3- SN:3337

October 1, 2015

Conversion Factor Assessment

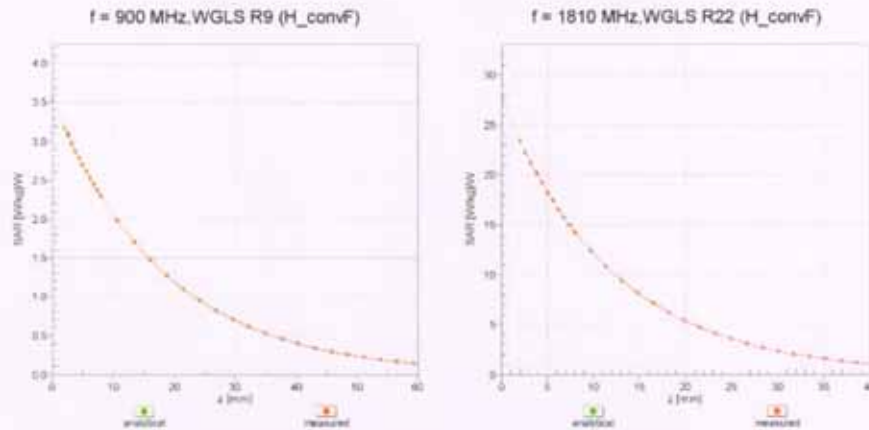

Deviation from Isotropy in Liquid Error (ϕ, θ), f = 900 MHz

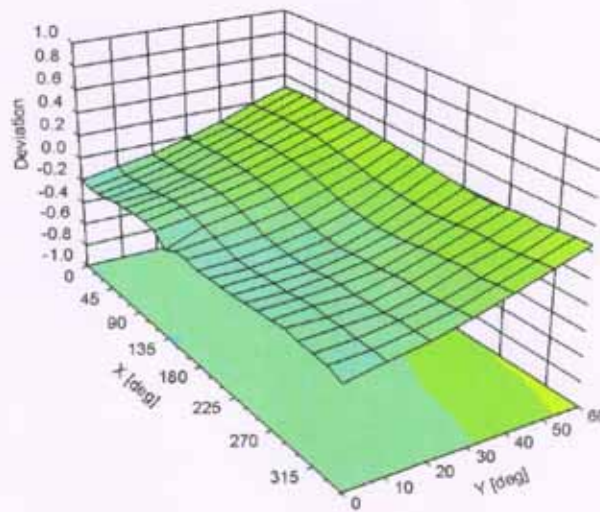

ES3DV3- SN:3337

October 1, 2015

DASY/EASY - Parameters of Probe: ES3DV3 - SN:3337

Other Probe Parameters

Sensor Arrangement	Triangular
Connector Angle (°)	2.3
Mechanical Surface Detection Mode	enabled
Optical Surface Detection Mode	disabled
Probe Overall Length	337 mm
Probe Body Diameter	10 mm
Tip Length	10 mm
Tip Diameter	4 mm
Probe Tip to Sensor X Calibration Point	2 mm
Probe Tip to Sensor Y Calibration Point	2 mm
Probe Tip to Sensor Z Calibration Point	2 mm
Recommended Measurement Distance from Surface	3 mm

APPENDIX E. DAE CALIBRATION DATA

**Calibration Laboratory of
Schmid & Partner
Engineering AG**
Zeughausstrasse 43, 8004 Zurich, Switzerland



S Schweizerischer Kalibrierdienst
C Service suisse d'étalonnage
S Servizio svizzero di taratura
S Swiss Calibration Service

Accredited by the Swiss Accreditation Service (SAS)
The Swiss Accreditation Service is one of the signatories to the EA
Multilateral Agreement for the recognition of calibration certificates

Accreditation No.: **SCS 0108**

Client **AGC-CERT (Auden)**

Certificate No: **DAE4-1398_Mar15**

CALIBRATION CERTIFICATE

Object: **DAE4 - SD 000 D04 BM - SN: 1398**

Calibration procedure(s): **QA CAL-06.v29
Calibration procedure for the data acquisition electronics (DAE)**

Calibration date: **March 11, 2015**

This calibration certificate documents the traceability to national standards, which realize the physical units of measurements (SI).
The measurements and the uncertainties with confidence probability are given on the following pages and are part of the certificate.

All calibrations have been conducted in the closed laboratory facility: environment temperature (22 ± 3)°C and humidity < 70%.

Calibration Equipment used (MATE critical for calibration)

Primary Standards	ID #	Cal Date (Certificate No.)	Scheduled Calibration
Keithley Multimeter Type 2001	SN: 0810278	03-Oct-14 (No:15573)	Oct-15
Secondary Standards	ID #	Check Date (in house)	Scheduled Check
Auto DAE Calibration Unit	SE UWS 053 AA 1001	06-Jan-15 (in house check)	In house check: Jan-16
Calibrator Box V2.1	SE UMS 006 AA 1002	06-Jan-15 (in house check)	In house check: Jan-16

Calibrated by:	Name R.Meyoraz	Function Technician	Signature
Approved by:	Name Fin Bomholt	Function Deputy Technical Manager	

Issued: March 11, 2015

This calibration certificate shall not be reproduced except in full without written approval of the laboratory.

**Calibration Laboratory of
Schmid & Partner
Engineering AG**
Zeughausstrasse 43, 8004 Zurich, Switzerland



S Schweizerischer Kalibrierdienst
C Service suisse d'étalonnage
S Servizio svizzero di taratura
S Swiss Calibration Service

Accredited by the Swiss Accreditation Service (SAS)
The Swiss Accreditation Service is one of the signatories to the EA
Multilateral Agreement for the recognition of calibration certificates

Accreditation No.: **SCS 0108**

Glossary

DAE data acquisition electronics
Connector angle information used in DASY system to align probe sensor X to the robot coordinate system.

Methods Applied and Interpretation of Parameters

- **DC Voltage Measurement:** Calibration Factor assessed for use in DASY system by comparison with a calibrated instrument traceable to national standards. The figure given corresponds to the full scale range of the voltmeter in the respective range.
- **Connector angle:** The angle of the connector is assessed measuring the angle mechanically by a tool inserted. Uncertainty is not required.
- The following parameters as documented in the Appendix contain technical information as a result from the performance test and require no uncertainty.
 - **DC Voltage Measurement Linearity:** Verification of the Linearity at +10% and -10% of the nominal calibration voltage. Influence of offset voltage is included in this measurement.
 - **Common mode sensitivity:** Influence of a positive or negative common mode voltage on the differential measurement.
 - **Channel separation:** Influence of a voltage on the neighbor channels not subject to an input voltage.
 - **AD Converter Values with inputs shorted:** Values on the internal AD converter corresponding to zero input voltage
 - **Input Offset Measurement:** Output voltage and statistical results over a large number of zero voltage measurements.
 - **Input Offset Current:** Typical value for information; Maximum channel input offset current, not considering the input resistance.
 - **Input resistance:** Typical value for information: DAE input resistance at the connector, during internal auto-zeroing and during measurement.
 - **Low Battery Alarm Voltage:** Typical value for information. Below this voltage, a battery alarm signal is generated.
 - **Power consumption:** Typical value for information. Supply currents in various operating modes.

DC Voltage Measurement

A/D - Converter Resolution nominal

High Range: 1LSB = 6.1 μ V, full range = -100...+300 mV

Low Range: 1LSB = 61nV, full range = -1.....+3mV

DASY measurement parameters: Auto Zero Time: 3 sec; Measuring time: 3 sec

Calibration Factors	X	Y	Z
High Range	404.177 \pm 0.02% (k=2)	404.159 \pm 0.02% (k=2)	403.623 \pm 0.02% (k=2)
Low Range	3.97359 \pm 1.50% (k=2)	3.99241 \pm 1.50% (k=2)	3.96904 \pm 1.50% (k=2)

Connector Angle

Connector Angle to be used in DASY system	195.5 $^{\circ}$ \pm 1 $^{\circ}$
---	-------------------------------------

Appendix (Additional assessments outside the scope of SCS0108)

1. DC Voltage Linearity

High Range	Reading (μV)	Difference (μV)	Error (%)
Channel X + Input	199993.58	-1.10	-0.00
Channel X + Input	20001.61	1.19	0.01
Channel X - Input	-19998.75	2.61	-0.01
Channel Y + Input	199994.17	-0.06	-0.00
Channel Y + Input	19999.73	-0.66	-0.00
Channel Y - Input	-20002.27	-0.74	0.00
Channel Z + Input	199994.39	-0.01	-0.00
Channel Z + Input	19999.60	-0.65	-0.00
Channel Z - Input	-20002.37	-0.85	0.00

Low Range	Reading (μV)	Difference (μV)	Error (%)
Channel X + Input	2000.37	-0.22	-0.01
Channel X + Input	201.03	-0.14	-0.07
Channel X - Input	-198.68	0.01	-0.00
Channel Y + Input	2000.16	-0.39	-0.02
Channel Y + Input	199.64	-1.42	-0.71
Channel Y - Input	-200.57	-1.84	0.93
Channel Z + Input	2000.33	-0.14	-0.01
Channel Z + Input	199.88	-1.17	-0.58
Channel Z - Input	-200.01	-1.12	0.56

2. Common mode sensitivity

DASY measurement parameters: Auto Zero Time: 3 sec; Measuring time: 3 sec

	Common mode Input Voltage (mV)	High Range Average Reading (μV)	Low Range Average Reading (μV)
Channel X	200	-13.00	-14.65
	-200	16.87	14.74
Channel Y	200	8.85	8.14
	-200	-11.30	-11.41
Channel Z	200	7.15	7.52
	-200	-9.35	-9.51

3. Channel separation

DASY measurement parameters: Auto Zero Time: 3 sec; Measuring time: 3 sec

	Input Voltage (mV)	Channel X (μV)	Channel Y (μV)	Channel Z (μV)
Channel X	200	-	-3.68	-0.69
Channel Y	200	5.01	-	-0.86
Channel Z	200	8.26	0.74	-

4. AD-Converter Values with inputs shorted

DASY measurement parameters: Auto Zero Time: 3 sec; Measuring time: 3 sec

	High Range (LSB)	Low Range (LSB)
Channel X	15958	16128
Channel Y	15964	17962
Channel Z	15846	14478

5. Input Offset Measurement

DASY measurement parameters: Auto Zero Time: 3 sec; Measuring time: 3 sec
Input 10M Ω

	Average (μ V)	min. Offset (μ V)	max. Offset (μ V)	Std. Deviation (μ V)
Channel X	-0.22	-1.08	0.72	0.33
Channel Y	-1.19	-1.94	-0.30	0.32
Channel Z	-1.46	-2.11	0.01	0.32

6. Input Offset Current

Nominal input circuitry offset current on all channels: <25fA

7. Input Resistance (Typical values for information)

	Zeroing (kOhm)	Measuring (MOhm)
Channel X	200	200
Channel Y	200	200
Channel Z	200	200

8. Low Battery Alarm Voltage (Typical values for information)

Typical values	Alarm Level (VDC)
Supply (+ Vcc)	+7.9
Supply (- Vcc)	-7.6

9. Power Consumption (Typical values for information)

Typical values	Switched off (mA)	Stand by (mA)	Transmitting (mA)
Supply (+ Vcc)	+0.01	+6	+14
Supply (- Vcc)	-0.01	-8	-9



Client : **agc-cert**

Certificate No: **Z16-97012**

CALIBRATION CERTIFICATE			
Object	DAE4 - SN: 1398		
Calibration Procedure(s)	FD-Z11-2-002-01 Calibration Procedure for the Data Acquisition Electronics (DAEx)		
Calibration date:	February 02, 2016		
<p>This calibration Certificate documents the traceability to national standards, which realize the physical units of measurements(SI). The measurements and the uncertainties with confidence probability are given on the following pages and are part of the certificate.</p> <p>All calibrations have been conducted in the closed laboratory facility: environment temperature(22±3)°C and humidity<70%.</p> <p>Calibration Equipment used (M&TE critical for calibration)</p>			
Primary Standards	ID #	Cal Date(Calibrated by, Certificate No.)	Scheduled Calibration
Process Calibrator 753	1971018	06-July-15 (CTTL, No:J15X04257)	July-16
Calibrated by:	Name	Function	Signature
	Yu Zongying	SAR Test Engineer	
Reviewed by:	Qi Dianyuan	SAR Project Leader	
Approved by:	Lu Bingsong	Deputy Director of the laboratory	
Issued: February 03, 2016			
This calibration certificate shall not be reproduced except in full without written approval of the laboratory.			



Add: No.51 Xueyuan Road, Haidian District, Beijing, 100191, China
Tel: +86-10-62304633-2218 Fax: +86-10-62304633-2209
E-mail: ctrl@chinattl.com Http://www.chinattl.cn

Glossary:

DAE data acquisition electronics
Connector angle information used in DASY system to align probe sensor X to the robot coordinate system.

Methods Applied and Interpretation of Parameters:

- *DC Voltage Measurement:* Calibration Factor assessed for use in DASY system by comparison with a calibrated instrument traceable to national standards. The figure given corresponds to the full scale range of the voltmeter in the respective range.
- *Connector angle:* The angle of the connector is assessed measuring the angle mechanically by a tool inserted. Uncertainty is not required.
- The report provide only calibration results for DAE, it does not contain other performance test results.



Add: No.51 Xueyuan Road, Haidian District, Beijing, 100191, China
Tel: +86-10-62304633-2218 Fax: +86-10-62304633-2209
E-mail: cttl@chinattl.com Http://www.chinattl.cn

DC Voltage Measurement

A/D - Converter Resolution nominal

High Range: 1LSB = 6.1 μ V, full range = -100...+300 mV

Low Range: 1LSB = 61nV, full range = -1.....+3mV

DASY measurement parameters: Auto Zero Time: 3 sec; Measuring time: 3 sec

Calibration Factors	X	Y	Z
High Range	404.195 \pm 0.15% (k=2)	404.179 \pm 0.15% (k=2)	403.642 \pm 0.15% (k=2)
Low Range	3.97538 \pm 0.7% (k=2)	3.99360 \pm 0.7% (k=2)	3.97118 \pm 0.7% (k=2)

Connector Angle

Connector Angle to be used in DASY system	196 $^{\circ}$ \pm 1 $^{\circ}$
---	-----------------------------------

APPENDIX F DIPOLE CALIBRATION DATA



SAR Reference Dipole Calibration Report

Ref: ACR.318.4.13.SATU.A

ATTESTATION OF GLOBAL COMPLIANCE CO. LTD.

1&2F, NO.2 BUILDING, HUAFENG NO.1 INDUSTRIAL
PARK, GUSHU COMMUNITY XIXIANG STREET
BAOAN DISTRICT, SHENZHEN, P.R. CHINA
SATIMO COMOSAR REFERENCE DIPOLE

FREQUENCY: 450 MHZ

SERIAL NO.: SN 46/11 DIP 0G450-184

Calibrated at SATIMO US
2105 Barrett Park Dr. - Kennesaw, GA 30144



11/14/13

Summary:

This document presents the method and results from an accredited SAR reference dipole calibration performed in SATIMO USA using the COMOSAR test bench. All calibration results are traceable to national metrology institutions.



SAR REFERENCE DIPOLE CALIBRATION REPORT

Ref: ACR 3:8.4.13.SATU.A

	<i>Name</i>	<i>Function</i>	<i>Date</i>	<i>Signature</i>
<i>Prepared by :</i>	Jérôme LUC	Product Manager	11/14/2013	<i>JL</i>
<i>Checked by :</i>	Jérôme LUC	Product Manager	11/14/2013	<i>JL</i>
<i>Approved by :</i>	Kim RUTKOWSKI	Quality Manager	11/14/2013	<i>Kim Rutkowski</i>

	<i>Customer Name</i>
<i>Distribution :</i>	ATTESTATION OF GLOBAL COMPLIANCE CO. LTD.

<i>Issue</i>	<i>Date</i>	<i>Modifications</i>
A	11/14/2013	Initial release



TABLE OF CONTENTS

1 Introduction..... 4

2 Device Under Test 4

3 Product Description 4

 3.1 General Information 4

4 Measurement Method 5

 4.1 Return Loss Requirements 5

 4.2 Mechanical Requirements 5

5 Measurement Uncertainty 5

 5.1 Return Loss 5

 5.2 Dimension Measurement 5

 5.3 Validation Measurement 5

6 Calibration Measurement Results 6

 6.1 Return Loss and Impedance 6

 6.2 Mechanical Dimensions 6

7 Validation measurement 7

 7.1 Measurement Condition 7

 7.2 Head Liquid Measurement 7

 7.3 Measurement Result 8

 7.4 Body Measurement Result 9

8 List of Equipment 10



1 INTRODUCTION

This document contains a summary of the requirements set forth by the IEEE 1528, OET 65 Bulletin C and CEI/IEC 62209 standards for reference dipoles used for SAR measurement system validations and the measurements that were performed to verify that the product complies with the fore mentioned standards.

2 DEVICE UNDER TEST

Device Under Test	
Device Type	COMOSAR 450 MHz REFERENCE DIPOLE
Manufacturer	Satimo
Model	SID450
Serial Number	SN 46/11 DIP 0G450-184
Product Condition (new / used)	Used

A yearly calibration interval is recommended.

3 PRODUCT DESCRIPTION

3.1 GENERAL INFORMATION

Satimo's COMOSAR Validation Dipoles are built in accordance to the IEEE 1528, OET 65 Bulletin C and CEI/IEC 62209 standards. The product is designed for use with the COMOSAR test bench only.



Figure 1 – Satimo COMOSAR Validation Dipole



4 MEASUREMENT METHOD

The IEEE 1528, OET 65 Bulletin C and CEI/IEC 62209 standards provide requirements for reference dipoles used for system validation measurements. The following measurements were performed to verify that the product complies with the fore mentioned standards.

4.1 RETURN LOSS REQUIREMENTS

The dipole used for SAR system validation measurements and checks must have a return loss of -20 dB or better. The return loss measurement shall be performed against a liquid filled flat phantom, with the phantom constructed as outlined in the fore mentioned standards.

4.2 MECHANICAL REQUIREMENTS

The IEEE Std. 1528 and CEI/IEC 62209 standards specify the mechanical components and dimensions of the validation dipoles, with the dimensions frequency and phantom shell thickness dependent. The COMOSAR test bench employs a 2 mm phantom shell thickness therefore the dipoles sold for use with the COMOSAR test bench comply with the requirements set forth for a 2 mm phantom shell thickness.

5 MEASUREMENT UNCERTAINTY

All uncertainties listed below represent an expanded uncertainty expressed at approximately the 95% confidence level using a coverage factor of k=2, traceable to the Internationally Accepted Guides to Measurement Uncertainty.

5.1 RETURN LOSS

The following uncertainties apply to the return loss measurement:

Frequency band	Expanded Uncertainty on Return Loss
400-6000MHz	0.1 dB

5.2 DIMENSION MEASUREMENT

The following uncertainties apply to the dimension measurements:

Length (mm)	Expanded Uncertainty on Length
3 - 300	0.05 mm

5.3 VALIDATION MEASUREMENT

The guidelines outlined in the IEEE 1528, OET 65 Bulletin C, CENELEC EN50361 and CEI/IEC 62209 standards were followed to generate the measurement uncertainty for validation measurements.

Scan Volume	Expanded Uncertainty
1 g	20.3 %
10 g	20.1 %



6 CALIBRATION MEASUREMENT RESULTS

6.1 RETURN LOSS AND IMPEDANCE

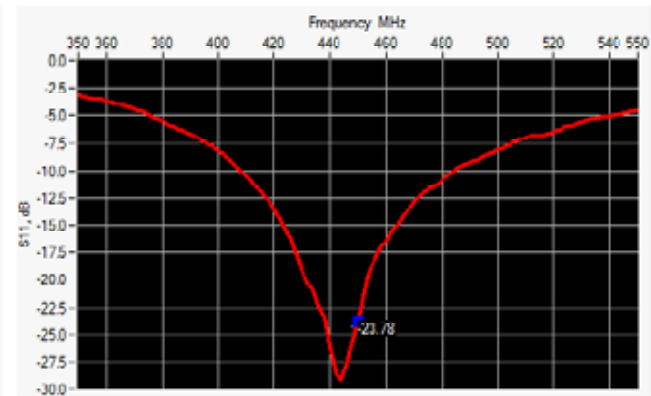

Frequency (MHz)	Return Loss (dB)	Requirement (dB)	Impedance
450	-23.78	-20	54.9 Ω + 5.1 $j\Omega$

6.2 MECHANICAL DIMENSIONS

Frequency MHz	l mm		h mm		d mm	
	required	measured	required	measured	required	measured
300	420.0 \pm 1 %		250.0 \pm 1 %		6.35 \pm 1 %	
450	290.0 \pm 1 %	PASS	166.7 \pm 1 %	PASS	6.35 \pm 1 %	PASS
750	176.0 \pm 1 %		100.0 \pm 1 %		6.35 \pm 1 %	
835	167.0 \pm 1 %		89.8 \pm 1 %		3.6 \pm 1 %	
900	149.0 \pm 1 %		83.3 \pm 1 %		3.6 \pm 1 %	
1450	89.1 \pm 1 %		51.7 \pm 1 %		3.6 \pm 1 %	
1500	80.5 \pm 1 %		50.0 \pm 1 %		3.6 \pm 1 %	
1640	79.0 \pm 1 %		45.7 \pm 1 %		3.6 \pm 1 %	
1750	75.2 \pm 1 %		42.9 \pm 1 %		3.6 \pm 1 %	
1800	72.0 \pm 1 %		41.7 \pm 1 %		3.6 \pm 1 %	
1900	68.0 \pm 1 %		39.5 \pm 1 %		3.6 \pm 1 %	
1950	66.3 \pm 1 %		38.5 \pm 1 %		3.6 \pm 1 %	
2000	64.5 \pm 1 %		37.5 \pm 1 %		3.6 \pm 1 %	
2100	61.0 \pm 1 %		35.7 \pm 1 %		3.6 \pm 1 %	
2300	55.5 \pm 1 %		32.6 \pm 1 %		3.6 \pm 1 %	
2450	51.5 \pm 1 %		30.4 \pm 1 %		3.6 \pm 1 %	
2600	48.5 \pm 1 %		28.8 \pm 1 %		3.6 \pm 1 %	
3000	41.5 \pm 1 %		25.0 \pm 1 %		3.6 \pm 1 %	
3500	37.0 \pm 1 %		26.4 \pm 1 %		3.6 \pm 1 %	
3700	34.7 \pm 1 %		26.4 \pm 1 %		3.6 \pm 1 %	



7 VALIDATION MEASUREMENT

The IEEE Std. 1528, OET 65 Bulletin C and CEI/IEC 62209 standards state that the system validation measurements must be performed using a reference dipole meeting the fore mentioned return loss and mechanical dimension requirements. The validation measurement must be performed against a liquid filled flat phantom, with the phantom constructed as outlined in the fore mentioned standards. Per the standards, the dipole shall be positioned below the bottom of the phantom, with the dipole length centered and parallel to the longest dimension of the flat phantom, with the top surface of the dipole at the described distance from the bottom surface of the phantom.

7.1 MEASUREMENT CONDITION

Software	OPENSAR V4
Phantom	SN 20/05 SAM71
Probe	SN 18/11 EPG122
Liquid	Head Liquid Values: ϵ_r' 42.5 σ : 0.85
Distance between dipole center and liquid	5.0 mm
Area scan resolution	$dx=8mm/dy=8mm$
Zoom Scan Resolution	$dx=8mm/dy=8mm/dz=3mm$
Frequency	450 MHz
Input power	20 dBm
Liquid Temperature	21 °C
Lab Temperature	21 °C
Lab Humidity	45 %

7.2 HEAD LIQUID MEASUREMENT

Frequency MHz	Relative permittivity (ϵ_r')		Conductivity (σ) S/m	
	required	measured	required	measured
300	45.3 ±5 %		0.87 ±5 %	
450	43.5 ±5 %	PASS	0.87 ±5 %	PASS
750	41.9 ±5 %		0.89 ±5 %	
835	41.5 ±5 %		0.90 ±5 %	
900	41.5 ±5 %		0.97 ±5 %	
1450	40.5 ±5 %		1.20 ±5 %	
1500	40.4 ±5 %		1.23 ±5 %	
1640	40.2 ±5 %		1.31 ±5 %	
1750	40.1 ±5 %		1.37 ±5 %	
1800	40.0 ±5 %		1.40 ±5 %	
1900	40.0 ±5 %		1.40 ±5 %	
1950	40.0 ±5 %		1.40 ±5 %	
2000	40.0 ±5 %		1.40 ±5 %	
2100	39.8 ±5 %		1.49 ±5 %	
2300	39.5 ±5 %		1.67 ±5 %	
2450	39.2 ±5 %		1.80 ±5 %	
2600	39.0 ±5 %		1.96 ±5 %	
3000	38.5 ±5 %		2.40 ±5 %	
3500	37.9 ±5 %		2.91 ±5 %	

Page: 1/10

This document shall not be reproduced, except in full or in part, without the written approval of SATIMO. The information contained herein is to be used only for the purpose for which it is submitted and is not to be released in whole or part without written approval of SATIMO.



7.3 MEASUREMENT RESULT

The IEEE Std. 1528 and CE1EC 62209 standards state that the system validation measurements should produce the SAR values shown below (for phantom thickness of 2 mm), within the uncertainty for the system validation. All SAR values are normalized to 1 W forward power. In bracket, the measured SAR is given with the used input power.

Frequency MHz	1 g SAR (W/kg/W)		10 g SAR (W/kg/W)	
	required	measured	required	measured
300	2.05		1.94	
450	4.58	4.91 (0.49)	3.06	3.13 (0.31)
750	8.49		5.55	
895	9.56		6.22	
900	10.9		6.99	
1450	29		16	
1500	30.5		16.8	
1640	34.2		18.4	
1750	36.4		19.3	
1800	38.4		20.1	
1900	39.7		20.5	
1950	40.5		20.9	
2000	41.1		21.1	
2100	43.6		21.9	
2300	48.7		23.3	
2450	52.4		24	
2600	55.3		24.6	
3000	63.9		25.7	
3500	67.1		25	

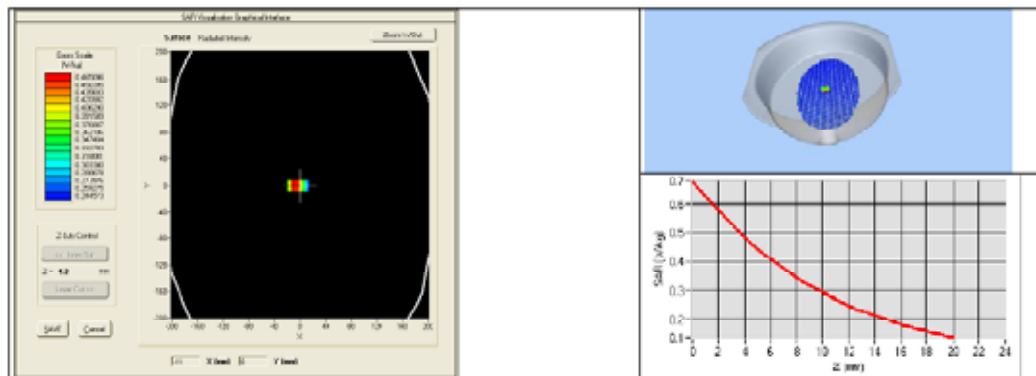



7.4 BODY MEASUREMENT RESULT

Software	OPENSAR V4
Phantom	SN 20/09 SAM71
Probe	SN : 8/11 EPG122
Liquid	Body Liquid Values: $\epsilon_p s' : 57.6$ σ : C.90
Distance between dipole center and liquid	15.0 mm
Area scan resolution	$dx=0mm/dy=0mm$
Zoon Scan Resolution	$dx=8mm/dy=8m/dz=5mm$
Frequency	450 MHz
Input power	20 dBm
Liquid Temperature	21 °C
Lab Temperature	21 °C
Lab Humidity	45 %

Frequency MHz	1 g SAR (W/kg/W)	10 g SAR (W/kg/W)
	measured	measured
450	5.07 (0.51)	3.25 (0.37)

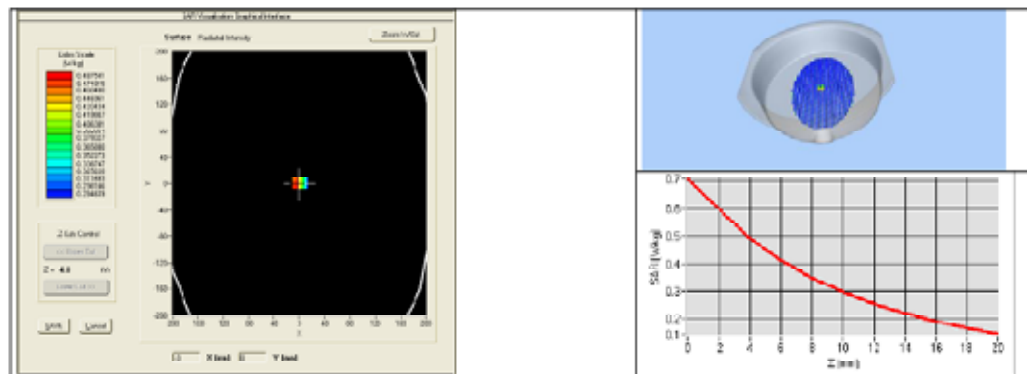



8 LIST OF EQUIPMENT

Equipment Summary Sheet				
Equipment Description	Manufacturer / Model	Identification No.	Current Calibration Date	Next Calibration Date
SAM Phantom	Satimo	SN-20/09-SAM71	Validated. No cal required.	Validated. No cal required.
COMOSAR Test Bench	Version 3	NA	Validated. No cal required.	Validated. No cal required.
Network Analyzer	Rhode & Schwarz ZVA	SN10C132	02/2013	02/2016
Calipers	Carrera	CALIPER-01	12/2010	12/2013
Reference Probe	Satimo	EPG122 SN 18/11	Characterized prior to test. No cal required.	Characterized prior to test. No cal required.
Multimeter	Keithley 2000	1188656	11/2010	11/2013
Signal Generator	Agilent E4438C	MY49070581	12/2010	12/2013
Amplifier	Aethercomm	SN 040	Characterized prior to test. No cal required.	Characterized prior to test. No cal required.
Power Meter	HP E4418A	US38261498	11/2010	11/2013
Power Sensor	HP ECP-E26A	US3718146C	11/2010	11/2013
Directional Coupler	Narda 4216 20	01386	Characterized prior to test. No cal required.	Characterized prior to test. No cal required.
Temperature and Humidity Sensor	Control Company	11-881-9	3/2012	3/2014