FCC Part 90 Test Report

Report No.: AGC00589141207FE09

FCC ID : T4KAT888V
PRODUCT DESIGNATION : MOBILE RADIO
BRAND NAME : N/A
MODEL NAME : AT888, AT999, AT555, AT889, AT899, AT888V, AT899V, AT999V, AT555V, AT889V, AT899V
CLIENT : Qixiang Electron Science & Technology Co., Ltd.
DATE OF ISSUE : Dec.24, 2014
STANDARD(S) : FCC Part 90 Rules
REPORT VERSION : V 1.0

Attestation of *Global Compliance (Shenzhen) Co., Ltd*

CAUTION: This report shall not be reproduced except in full without the written permission of the test laboratory and shall not be quoted out of context.



Report Revise Record

Report Version	Revise Time	Issued Date	Valid Version	Notes
V1.0	/	Dec.24, 2014	Valid	Original Report

VERIFICATION OF COMPLIANCE

Applicant:	Qixiang Electron Science & Technology Co., Ltd. Qixiang Building, Tangxi Industrial Zone, Luojiang District, Quanzhou, Fujian, China
Manufacturer:	Qixiang Electron Science & Technology Co., Ltd. Qixiang Building, Tangxi Industrial Zone, Luojiang District, Quanzhou, Fujian, China
Product Designation:	MOBILE RADIO
Brand Name:	N/A
Test Model	AT888
Series Model	AT999, AT555, AT889, AT899, AT888V, AT899V, AT999V, AT555V, AT889V, AT899V
Difference description	All the same except for the model name.
Date of Test:	Dec.17, 2014 to Dec.23, 2014

WE HEREBY CERTIFY THAT:

The above equipment was tested by Attestation of Global Compliance (Shenzhen) Co., Ltd. The data evaluation, test procedures, and equipment configurations shown in this report were made in accordance with the procedures given in ANSI C 63.4:2009. The sample tested as described in this report is in compliance with the FCC Rules Part 90 requirements

The test results of this report relate only to the tested sample identified in this report.



Tested by	
	_____ Freddie Duan Dec.24, 2014
Checked By	
	_____ Kidd Yang Dec.24, 2014
Authorized By	
	_____ Solger Zhang Dec.24, 2014

TABLE OF CONTENTS

1. GENERAL INFORMATION	6
1.1 PRODUCT DESCRIPTION	6
1.2 RELATED SUBMITTAL(S) / GRANT (S)	7
1.3 TEST METHODOLOGY	7
1.4 TEST FACILITY	7
1.5 SPECIAL ACCESSORIES	7
1.6 EQUIPMENT MODIFICATIONS	7
2. SYSTEM TEST CONFIGURATION	8
2.1 EUT CONFIGURATION	8
2.2 EUT EXERCISE	8
2.3 GENERAL TECHNICAL REQUIREMENTS	8
2.4 CONFIGURATION OF TESTED SYSTEM	9
2.5. SUMMARY OF TEST RESULTS	9
3. IDENTIFICATION OF THE RESPONSIBLE TESTING LOCATION	10
4. DESCRIPTION OF TEST MODES	11
5. FREQUENCY TOLERANCE	12
5.1 PROVISIONS APPLICABLE	12
5.2 MEASUREMENT PROCEDURE	12
5.3 TEST SETUP BLOCK DIAGRAM	13
5.4 TEST RESULT	14
6. EMISSION BANDWIDTH	17
6.1 PROVISIONS APPLICABLE	17
6.2 MEASUREMENT PROCEDURE	17
6.3 TEST SETUP BLOCK DIAGRAM	17
6.4 MEASUREMENT RESULT	18
7. UNWANTED RADIATION	19
7.1 PROVISIONS APPLICABLE	19
7.2 MEASUREMENT PROCEDURE	19
7.3 TEST SETUP BLOCK DIAGRAM	19
7.4 MEASUREMENT RESULTS:	22
8. MODULATION CHARACTERISTICS	26
8.1 PROVISIONS APPLICABLE	26
8.2 MEASUREMENT METHOD	26
8.3 MEASUREMENT RESULT	27

9. MAXIMUM TRANSMITTER POWER	30
9.1 PROVISIONS APPLICABLE	30
9.2 TEST PROCEDURE	30
9.3 TEST CONFIGURATION	30
9.4 TEST RESULT	32
10.5 CONDUCT SPURIOUS PLOT	33
10. TRANSMITTER FREQUENCY BEHAVIOR.....	34
10.1 PROVISIONS APPLICABLE	34
10.2 TEST METHOD.....	34
10.3 DESCRIBE LIMIT LINE OF TRANSMITTER FREQUENCY BEHAVIOR	34
10.4 MEASURE RESULT.....	36
11. RADIATED EMISSION ON RECEIVING MODE	37
11.1 PROVISIONS APPLICABLE	37
11.2 TEST METHOD	37
11.3 MEASURE RESULT (MEASURED AT 3M USING FCC PART15 B LIMITS).....	38
12. AUDIO LOW PASS FILTER RESPONSE	42
12.1 LIMITS	42
12.2. METHOD OF MEASUREMENTS.....	42
12.3 TEST DATA.....	43
APPENDIX I: PHOTOGRAPHS OF SETUP	45
APPENDIX II: EXTERNAL VIEW OF EUT	46

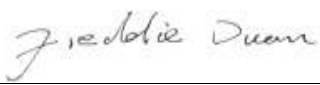
1. GENERAL INFORMATION

1.1 PRODUCT DESCRIPTION

The EUT is a MOBILE RADIO designed for voice communication. It is designed by way of utilizing the FM modulation achieves the system operating.

A major technical description of EUT is described as following:

Communication Type	Voice / Tone only
Modulation	FM
Emission Type	11KΦ F3E
Emission Bandwidth	10.19KHz
Peak Frequency Deviation	1.87KHz
Audio Frequency Response	10.88dB
Maximum Transmitter Power	47.71dBm
Output power Modification	60W (It was fixed by the manufacturer, any individual can't arbitrarily change it.)
Antenna Designation	Detachable
Antenna type	External antenna
Antenna gain	0dBi
Antenna connection cable length	2m
Power Supply	DC 13.8V
Limiting Voltage	DC 11.73V-DC 15.87V
Operation Frequency Range and Channel	Frequency Range: 136MHz to 174MHz Channel Separation: 12.5KHz
	Bottom Channel: 136.025MHz Centre Channel: 155.000MHz Top Channel: 173.975MHz
Frequency Tolerance	0.647ppm

1.2 RELATED SUBMITTAL(S) / GRANT (S)

This submittal(s) (test report) is intended for **FCC ID: T4KAT888V**, filing to comply with the FCC Part 90 requirements and the.

1.3 TEST METHODOLOGY

The radiated emission testing was performed according to the procedures of ANSI C 63.4: 2009; TIA/EIA 603 and FCC CFR 47 Rules of 2.1046, 2.1047, 2.1049, 2.1051, 2.1053, 2.1055, 2.1057.

1.4 TEST FACILITY

The test site used to collect the radiated data is located on the address of Attestation of Global Compliance (Shenzhen) Co., Ltd. The test site is constructed and calibrated to meet the FCC requirements in documents ANSI C63.4: 2003 and IC requirements in documents RS212.

FCC register No.: 259865

1.5 SPECIAL ACCESSORIES

Not available for this EUT intended for grant.

1.6 EQUIPMENT MODIFICATIONS

Not available for this EUT intended for grant.

2. SYSTEM TEST CONFIGURATION

2.1 EUT CONFIGURATION

The EUT configuration for testing is installed on RF field strength measurement to meet the Commission's requirement and operating in a manner which intends to maximize its emission characteristics in a continuous normal application.

2.2 EUT EXERCISE

The Transmitter was operated in the normal operating mode. The TX frequency was fixed which was for the purpose of the measurements.

2.3 GENERAL TECHNICAL REQUIREMENTS

For FCC Part 90 requirements:

- (1). Section 90.205: Maximum ERP is dependent upon the station's antenna HAAT and required service area
- (2). Section 90.207: Modulation Characteristic
- (3). Section 90.209: Occupied Bandwidth
- (4). Section 90.210: Emission Mask
- (5). Section 90.213: Frequency Tolerance
- (6). Section 90.214: Transient Frequency Behavior

2.4 CONFIGURATION OF TESTED SYSTEM

Fig. 2-1 Configuration of Tested System



Table 2-1 Equipment Used in Tested System

Item	Equipment	Model No.	Identifier	Note
1	MOBILE RADIO	AT888	FCC ID: T4KAT888V	EUT

2.5. SUMMARY OF TEST RESULTS

FCC Rules	Description Of Test	Result
§90.205	Maximum Transmitter Power	Compliant
§90.207	Modulation Characteristic	Compliant
§90.209	Occupied Bandwidth	Compliant
§90.210	Emission Mask	Compliant
§90.213	Frequency Tolerance	Compliant
§90.214	Transient Frequency Behavior	Compliant
§90.242	AUDIO LOW PASS FILTER RESPONSE	Compliant

3. IDENTIFICATION OF THE RESPONSIBLE TESTING LOCATION

Site	Attestation of Global Compliance (Shenzhen) Co., Ltd
Location 1	2/F., Building 2, No.1-No.4, Chaxi Sanwei Technical Industrial Park, Gushu, Xixiang, Bao'an District, Shenzhen, Guangdong, China
Location 2	B112-B113, Building 12, Baoan Building Materials Center, No.1 of Xixiang Inner Ring Road, Baoan District, Shenzhen, Guangdong, P.R.China

LIST OF EQUIPMENTS USED

NAME OF EQUIPMENT	MANUFACTURER	MODEL	SERIAL NUMBER	Cal. Date	Cal. Due
TEST RECEIVER	R&S	ESCI	N/A	07/25/2014	07/24/2015
LISN	R&S	ESH3-Z5	N/A	09/05/2014	09/04/2015
CLIMATE CHAMBER	EXPERY	TN-400	N/A	07/25/2014	07/24/2015
ATTENUATOR	WEINSCHTEL CORP	58-30-33	ML030	07/25/2014	07/24/2015
DC POWER SUPPLY	ZHAOXIN	RXN-605D	N/A	07/25/2014	07/24/2015
SPECTRUM ANALYZER	AGILENT	N9010A	MY53470504	10/21/2014	10/20/2015
MODULATION ANALYZER	HP	8920B	3104A03367	07/16/2014	07/15/2015
HEADPHONE LINE	AGC	N/A	N/A	N/A	N/A
HORN ANT	ETS	3117	00034609	08/17/2014	08/16/2015
BROADBAND ANT	SCHWARZBECK	VULB9168	D69250	08/17/2014	08/16/2015
Broadband Preamplifier	Schwarzbeck	BBV 9718	9718-62	07/30/2014	07/29/2015
Multi-Device Controller	EMCO	2090	N/A	07/30/2014	07/29/2015
HORN ANTENNA	A.H. SYSTEMS INC.	SAS-574	N/A	07/16/2014	07/15/2015
Biconilog Antenna	EMCO	3142C	N/A	08/17/2014	08/16/2015
SIGNAL GENERATOR	AGILENT	E4421B	122501288	07/25/2014	07/24/2015
SIGNAL GENERATOR	R&S	SMT03	A0304261	07/25/2014	07/24/2015
BICONILOG ANTENNA	EMCO	3142C	N/A	08/17/2014	08/16/2015
RF CABLE	SUIRONG	9KHZ-30MHZ	N/A	07/16/2014	07/15/2015
RF CABLE	SUIRONG	30MHZ-18GHZ	N/A	07/16/2014	07/15/2015

NOTE: 8920B can generate audio modulation frequency.

4. DESCRIPTION OF TEST MODES

RF TEST MODES

The EUT (MOBILE RADIO) has been tested under normal operating condition. (The top channel, the middle channel and the bottom channel) are chosen for testing at each channel separation.

No.	TEST MODES	CHANNEL SEPARATION
1	Low Channel	12.5KHz
2	Middle Channel	12.5KHz
3	High Channel	12.5KHz

EMC TEST MODES

No.	TEST MODES
1	Standby Mode

Note: Only the result of the worst case was recorded in the report.

5. FREQUENCY TOLERANCE

5.1 PROVISIONS APPLICABLE

- a). According to FCC Part 2 Section 2.1055(a)(1), the frequency stability shall be measured with variation of ambient temperature from -30°C to $+50^{\circ}\text{C}$ centigrade.
- b). According to FCC Part 2 Section 2.1055(d)(2), for battery powered equipment, the frequency stability shall be measured with reducing primary supply voltage to the battery operating end point, which is specified by the manufacturer.
- c). According to FCC Part 90 Section 90.213, the frequency tolerance must be maintained within 0.00025% for 12.5 KHz channel separation.
- d). According to RSS-119 Section 119.5.3, the frequency tolerance must be maintained within 0.00025% for 12.5 KHz channel separation and 0.0005% for 25KHz channel separation.

5.2 MEASUREMENT PROCEDURE

5.2.1 Frequency stability versus environmental temperature

1. Setup the configuration per figure 1 for frequencies measurement inside an environment chamber, Install new battery in the EUT.
2. Turn on EUT and set SA center frequency to the EUT radiated frequency. Set SA Resolution Bandwidth to 1KHz and Video Resolution Bandwidth to 1KHz and Frequency Span to 50KHz. Record this frequency as reference frequency.
3. Set the temperature of chamber to 50°C . Allow sufficient time (approximately 30 min) for the temperature of the chamber to stabilize. While maintaining a constant temperature inside the chamber, turn the EUT on and measure the EUT operating frequency.
4. Repeat step 2 with a 10°C decreased per stage until the lowest temperature -30°C is measured, record all measured frequencies on each temperature step.

5.2.2 Frequency stability versus input voltage

1. Setup the configuration per figure 1 for frequencies measured at temperature if it is within 15°C to 25°C . Otherwise, an environment chamber set for a temperature of 20°C shall be used. The EUT shall be powered by DC 13.8V.
2. Set SA center frequency to the EUT radiated frequency. Set SA Resolution Bandwidth to 1 KHz and Video Resolution Bandwidth to 1KHz. Record this frequency as reference frequency.
3. Supply the EUT primary voltage at the operating end point which is specified by manufacturer and record the frequency.

5.2 TEST SETUP BLOCK DIAGRAM

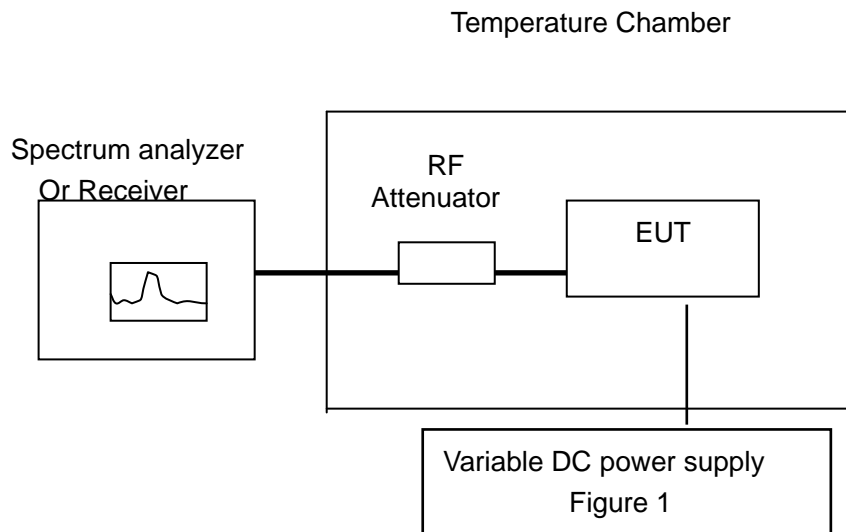

5.2TEST RESULT

Frequency stability versus input voltage (Supply nominal voltage is 13.8V, ambient temperature 20°C)

Bottom Channel @ 12.5KHz Channel Separation

Reference Frequency:	136.025 MHz	Limit:	2.5ppm
Environment Temperature	Power Supply	Frequency Deviation	
(°C)	(V)	(MHz)	ppm
50	DC 13.8 V	136.025042	0.309
40	DC 13.8 V	136.025057	0.419
30	DC 13.8 V	136.025075	0.551
20	DC 13.8 V	136.025081	0.595
10	DC 13.8 V	136.025064	0.471
0	DC 13.8 V	136.025074	0.544
-10	DC 13.8 V	136.025068	0.500
-20	DC 13.8 V	136.025071	0.522
-30	DC 13.8 V	136.025076	0.559

Middle Channel @ 12.5KHz Channel Separation

Reference Frequency:	155.000 MHz	Limit:	2.5ppm
Environment Temperature	Power Supply	Frequency Deviation	
(°C)	(V)	(MHz)	ppm
50	DC 13.8 V	155.000072	0.465
40	DC 13.8 V	155.000085	0.548
30	DC 13.8 V	155.000087	0.561
20	DC 13.8 V	155.000073	0.471
10	DC 13.8 V	155.000088	0.568
0	DC 13.8 V	155.000078	0.503
-10	DC 13.8 V	155.000065	0.419
-20	DC 13.8 V	155.000085	0.548
-30	DC 13.8 V	155.000089	0.574

Top Channel @ 12.5KHz Channel Separation

Reference Frequency:	173.975 MHz	Limit:	2.5ppm
Environment Temperature	Power Supply	Frequency Deviation	
(°C)	(V)	(MHz)	ppm
50	DC 13.8 V	173.975067	0.385
40	DC 13.8 V	173.975065	0.374
30	DC 13.8 V	173.975087	0.500
20	DC 13.8 V	173.975085	0.489
10	DC 13.8 V	173.975096	0.552
0	DC 13.8 V	173.975091	0.523
-10	DC 13.8 V	173.975078	0.448
-20	DC 13.8 V	173.975076	0.437
-30	DC 13.8 V	173.975087	0.500

(2) Frequency stability versus input voltage (Battery Limiting voltage is 11.73V)

Bottom Channel @ 12.5KHz Channel Separation

Reference Frequency:	136.025 MHz	Limit:	2.5ppm
Environment Temperature	Power Supply	Frequency Deviation	
(°C)	(V)	(MHz)	ppm
50	DC 11.73 V	136.025048	0.353
40	DC 11.73 V	136.025062	0.456
30	DC 11.73 V	136.025052	0.382
20	DC 11.73 V	136.025075	0.551
10	DC 11.73 V	136.025068	0.500
0	DC 11.73 V	136.025073	0.537
-10	DC 11.73 V	136.025069	0.507
-20	DC 11.73 V	136.025073	0.537
-30	DC 11.73 V	136.025081	0.595

Middle Channel @ 12.5KHz Channel Separation

Reference Frequency:	155.000 MHz	Limit:	2.5ppm
Environment Temperature	Power Supply	Frequency Deviation	
(°C)	(V)	(MHz)	ppm
50	DC 11.73 V	155.000075	0.484
40	DC 11.73 V	155.000072	0.465
30	DC 11.73 V	155.000081	0.523
20	DC 11.73 V	155.000088	0.568
10	DC 11.73 V	155.000079	0.510
0	DC 11.73 V	155.000067	0.432
-10	DC 11.73 V	155.000082	0.529
-20	DC 11.73 V	155.000079	0.510
-30	DC 11.73 V	155.000084	0.542

Top Channel @ 12.5KHz Channel Separation

Reference Frequency:	173.975 MHz	Limit:	2.5ppm
Environment Temperature	Power Supply	Frequency Deviation	
(°C)	(V)	(MHz)	ppm
50	DC 11.73 V	173.975089	0.512
40	DC 11.73 V	173.975094	0.540
30	DC 11.73 V	173.975091	0.523
20	DC 11.73 V	173.975083	0.477
10	DC 11.73 V	173.975089	0.512
0	DC 11.73 V	173.975081	0.466
-10	DC 11.73 V	173.975078	0.448
-20	DC 11.73 V	173.975092	0.529
-30	DC 11.73 V	173.975088	0.506

(3) Frequency stability versus input voltage (Battery MAX voltage is 15.87V)

Bottom Channel @ 12.5KHz Channel Separation

Reference Frequency:	136.025 MHz	Limit:	2.5ppm
Environment Temperature	Power Supply	Frequency Deviation	
(°C)	(V)	(MHz)	ppm
50	DC 15.87 V	136.025074	0.544
40	DC 15.87 V	136.025075	0.551
30	DC 15.87 V	136.025066	0.485
20	DC 15.87 V	136.025067	0.493
10	DC 15.87 V	136.025058	0.426
0	DC 15.87 V	136.025068	0.500
-10	DC 15.87 V	136.025073	0.537
-20	DC 15.87 V	136.025084	0.618
-30	DC 15.87 V	136.025088	0.647

Middle Channel @ 12.5KHz Channel Separation

Reference Frequency:	155.000 MHz	Limit:	2.5ppm
Environment Temperature	Power Supply	Frequency Deviation	
(°C)	(V)	(MHz)	ppm
50	DC 15.87 V	155.000074	0.477
40	DC 15.87 V	155.000071	0.458
30	DC 15.87 V	155.000069	0.445
20	DC 15.87 V	155.000089	0.574
10	DC 15.87 V	155.000082	0.529
0	DC 15.87 V	155.000076	0.490
-10	DC 15.87 V	155.000069	0.445
-20	DC 15.87 V	155.000075	0.484
-30	DC 15.87 V	155.000082	0.529

Top Channel @ 12.5KHz Channel Separation

Reference Frequency:	173.975 MHz	Limit:	2.5ppm
Environment Temperature	Power Supply	Frequency Deviation	
(°C)	(V)	(MHz)	ppm
50	DC 15.87 V	173.975097	0.558
40	DC 15.87 V	173.975084	0.483
30	DC 15.87 V	173.975087	0.500
20	DC 15.87 V	173.975076	0.437
10	DC 15.87 V	173.975086	0.494
0	DC 15.87 V	173.975064	0.368
-10	DC 15.87 V	173.975087	0.500
-20	DC 15.87 V	173.975082	0.471
-30	DC 15.87 V	173.975091	0.523

6. EMISSION BANDWIDTH

6.1 PROVISIONS APPLICABLE

According to FCC Part 90 Section 90.209: The authorized bandwidth shall be 11.25 KHz for 12.5 KHz channel separation.

According to RSS-119 Section 119.5.5: The authorized bandwidth shall be 11.25 KHz for 12.5 KHz

6.2 MEASUREMENT PROCEDURE

- 1). The EUT was placed on a turntable which is 0.8m above ground plane.
- 2). The EUT was modulated by 2.5 KHz Sine wave audio signal, The level of the audio signal employed is 16 dB greater than that necessary to produce 50% of rated system deviation. Rated system deviation is 2.5 kHz (12.5 kHz channel spacing).
- 3). Set SPA Center Frequency = fundamental frequency, RBW=100Hz, VBW= 300Hz, Span =50 KHz.
- 4). Set SPA Max hold. Mark peak, -26 dB.

6.3 TEST SETUP BLOCK DIAGRAM

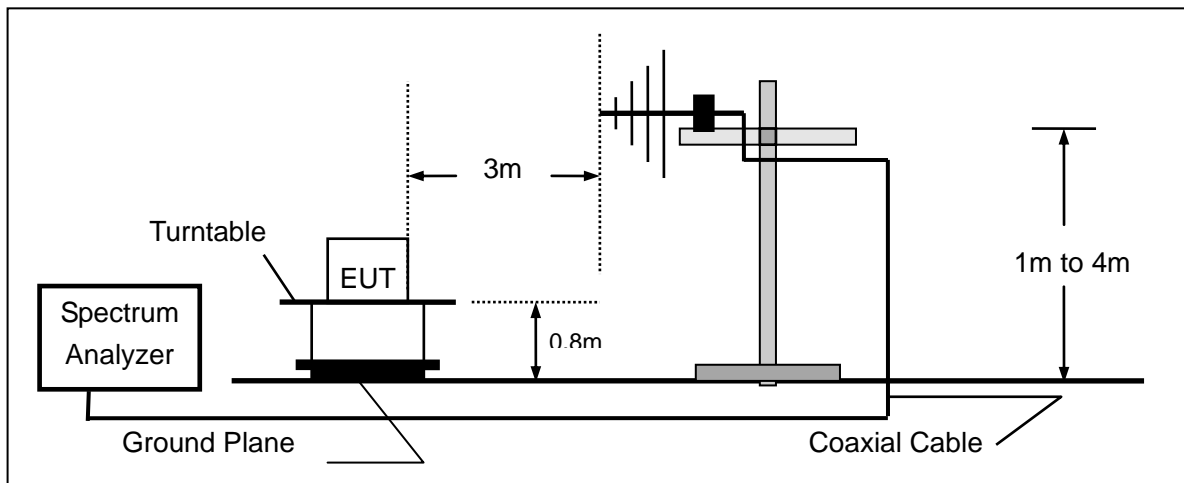

6.4 MEASUREMENT RESULT

26 DB BANDWIDTH MEASUREMENT RESULT			
Operating Frequency	12.5KHz Channel Separation		
	Test Data	Limits	Result
136.025MHz	10.19KHz	11.25 KHz	Pass
155.000MHz	10.12KHz	11.25 KHz	Pass
173.975MHz	10.15KHz	11.25 KHz	Pass

Occupied bandwidth of Low Channel (Maximum)

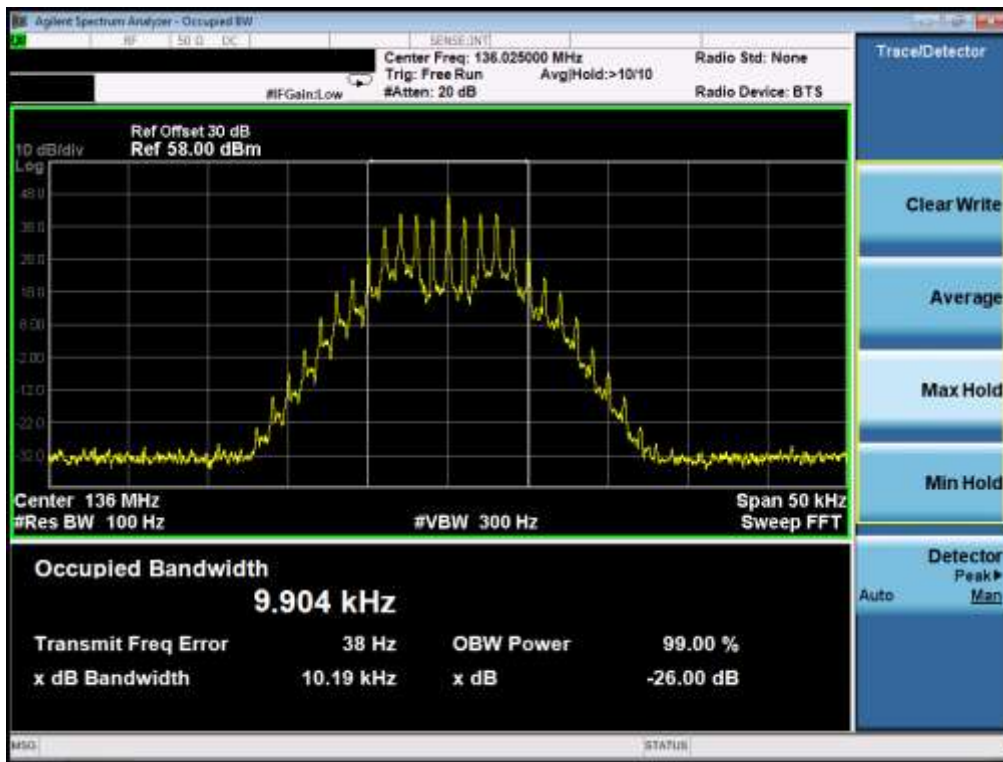

7. UNWANTED RADIATION

7.1 PROVISIONS APPLICABLE

8.1.1 According to Section 90.210, the power of each unwanted emission shall be less than Transmitted Power as specified below for transmitters designed to operate with each channel separation.

According to RSS-119 Section 119.5.8, the power of each unwanted emission shall be less than Transmitted Power as specified below for transmitters with each channel separation.

For 12.5 KHz Channel Separation:

- (1). On any frequency removed from the center of the authorized bandwidth f_0 to 5.625 KHz removed from f_0 : Zero dB.
- (2). On any frequency removed from the center of the authorized bandwidth by a displacement Frequency (f_d in KHz) f_0 of more than 5.625 KHz but no more than 12.5 KHz: At least $7.27(f_d - 2.88 \text{ KHz})$ dB
- (3). On any frequency removed from the center of the authorized bandwidth by a displacement Frequency (f_d in KHz) f_0 of more than 12.5 KHz: At least $50 + 10 \log(P)$ dB or 70 dB, which ever is lesser attenuation.

7.2 MEASUREMENT PROCEDURE

- (1) On a test site, the EUT shall be placed on a turntable, and in the position closest to the normal use as declared by the user.
- (2) The test antenna shall be oriented initially for vertical polarization located 3m from the EUT to correspond to the transmitter.
- (3) The output of the antenna shall be connected to the measuring receiver and either a peak or quasi-peak detector was used for the measurement as indicated on the report. The detector selection is based on how close the emission level was approaching the limit.
- (4) The transmitter shall be switched on; if possible, without the modulation and the measurement receiver shall be tuned to the frequency of the transmitter under test.
- (5) The test antenna shall be raised and lowered through the specified range of height until the measuring receiver detects a maximum signal level.
- (6) The transmitter shall then be rotated through 360° in the horizontal plane, until the maximum signal level is detected by the measuring receiver.
- (7) The test antenna shall be raised and lowered again through the specified range of height until the measuring receiver detects a maximum signal level.

- (8) The maximum signal level detected by the measuring receiver shall be noted.
- (9) The measurement shall be repeated with the test antenna set to horizontal polarization.
- (10) Replace the antenna with a proper Antenna (substitution antenna).
- (11) The substitution antenna shall be oriented for vertical polarization and, if necessary, the length of the substitution antenna shall be adjusted to correspond to the frequency of transmitting.
- (12) The substitution antenna shall be connected to a calibrated signal generator.
- (13) If necessary, the input attenuator setting of the measuring receiver shall be adjusted in order to increase the sensitivity of the measuring receiver.

(14)The test antenna shall be raised and lowered through the specified range of the height to ensure that the maximum signal is received.

(15)The input signal to substitution antenna shall be adjusted to the level that produces a level detected by the measuring receiver, that is equal to the level noted while the transmitter radiated power was measured, corrected for the change of input attenuation setting of the measuring receiver.

(16)The input level to the substitution antenna shall be recorded as power level in dBm, corrected for any change of input attenuator setting of the measuring receiver.

(17)The measurement shall be repeated with the test antenna and the substitution antenna oriented for horizontal polarization.

7.3 TEST SETUP BLOCK DIAGRAM

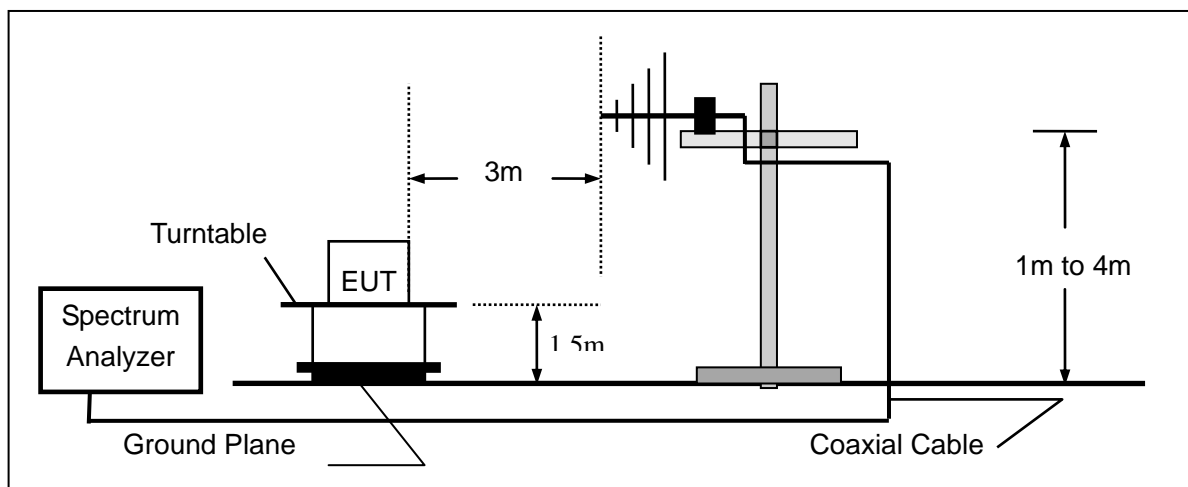

SUBSTITUTION METHOD: (Radiated Emissions)

Radiated Below 1GHz

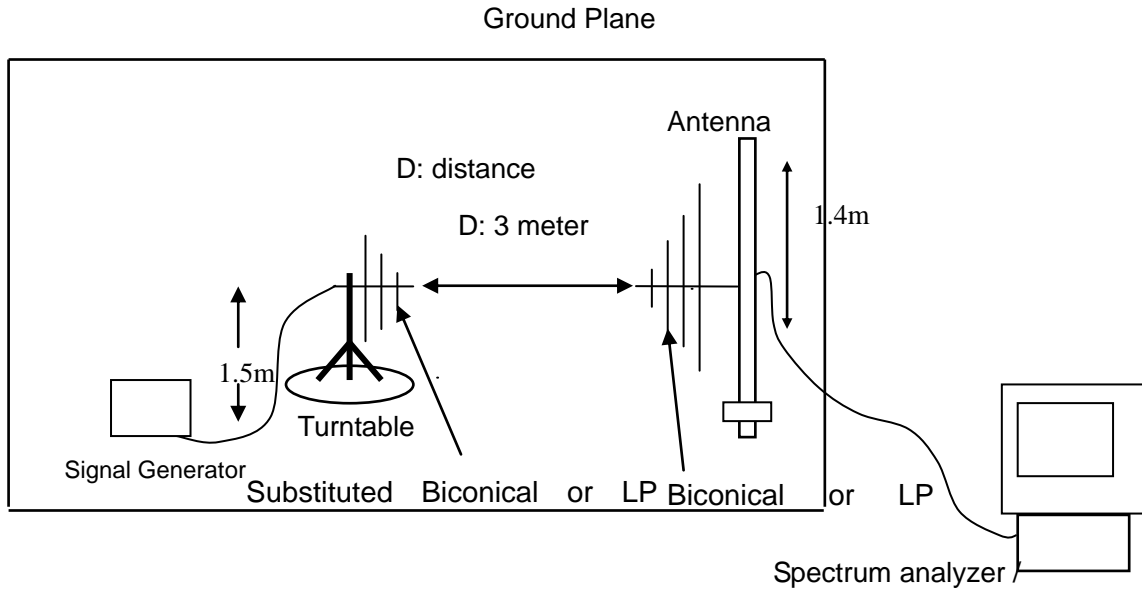

Radiated Above 1 GHz

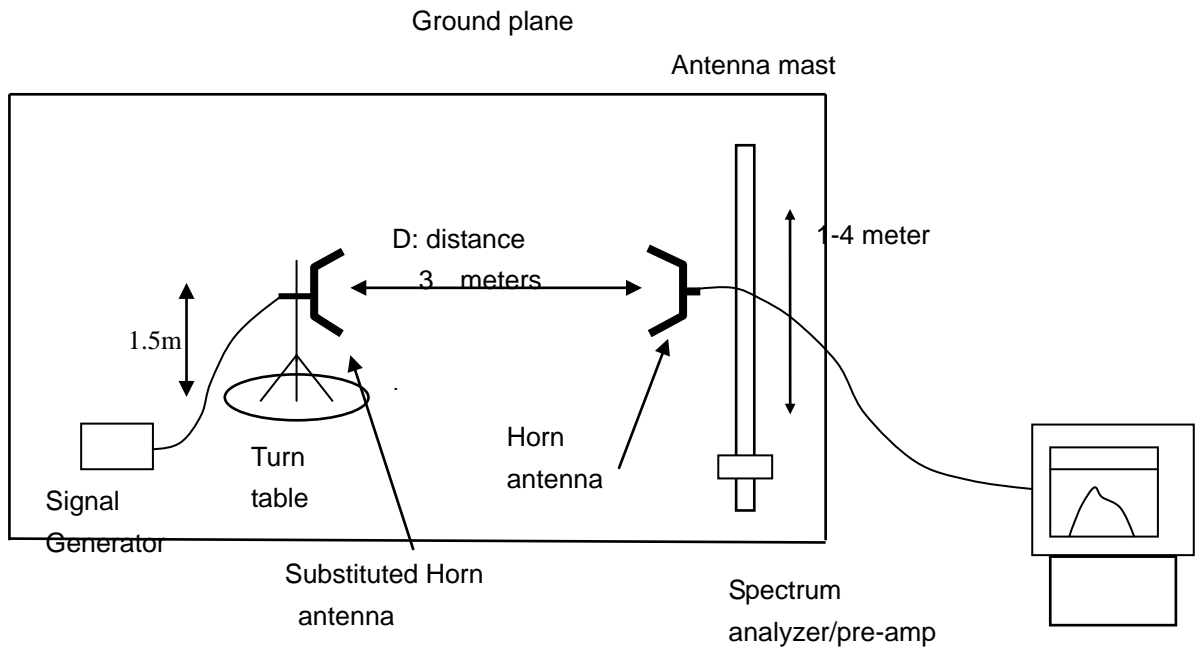

7.4 MEASUREMENT RESULTS:

Measurement Result for 12.5 KHz Channel Separation

On any frequency removed from the center of the authorized bandwidth by a displacement Frequency (fd in KHz)for of more than 12.5 KHz: at least 50+10 log(P) dB or 70 dB, whichever is lesser attenuation.

At least 50+10 log (P) =50+10log (60) =68 (dB)

Measurement Result for 12.5KHz Channel Separation @ 136.025MHz

Emission Frequency (MHz)	Ant. Polarity(H/V)	Measurement Result Below carrier(dBc)	Limit below carrier(dBc)	Result(P/F)
136.025	V	0		pass
272.050	V	70.57	68	pass
408.08	V	73.26	68	pass
544.100	V	74.25	68	pass
680.125	V	73.48	68	pass
816.150	V	74.12	68	pass
952.175	V	75.84	68	pass
1088.200	V	77.67	68	pass
1224.225	V	79.75	68	pass
1360.250	V	82.36	68	pass

Measurement Result for 12.5KHz Channel Separation @ 155.000MHz

Emission Frequency (MHz)	Ant. Polarity(H/V)	Measurement Result Below carrier(dBc)	Limit below carrier(dBc)	Result(P/F)
155.000	V	0		pass
310.000	V	70.86	68	pass
465.000	V	70.67	68	pass
620.000	V	72.46	68	pass
775.000	V	75.57	68	pass
930.000	V	76.45	68	pass
1085.000	V	78.57	68	pass
1240.000	V	74.67	68	pass
1395.000	V	80.32	68	pass
1550.000	V	81.27	68	pass

Measurement Result for 12.5KHz Channel Separation @ 173.975MHz

Emission Frequency (MHz)	Ant. Polarity(H/V)	Measurement Result Below carrier(dBc)	Limit below carrier(dBc)	Result(P/F)
173.975	V	0		pass
347.950	V	70.76	68	pass
521.925	V	71.66	68	pass
695.900	V	73.77	68	pass
869.875	V	74.55	68	pass
1043.850	V	75.86	68	pass
1217.825	V	77.64	68	pass
1391.800	V	79.57	68	pass
1565.775	V	70.48	68	pass
1739.750	V	81.72	68	pass

Measurement Result for 12.5KHz Channel Separation @ 136.025MHz

Emission Frequency (MHz)	Ant. Polarity(H/H)	Measurement Result Below carrier(dBc)	Limit below carrier(dBc)	Result(P/F)
136.025	H	0		pass
272.050	H	70.35	68	pass
408.08	H	71.43	68	pass
544.100	H	72.54	68	pass
680.125	H	73.68	68	pass
816.150	H	74.57	68	pass
952.175	H	75.86	68	pass
1088.200	H	77.59	68	pass
1224.225	H	79.42	68	pass
1360.250	H	81.79	68	pass

Measurement Result for 12.5KHz Channel Separation @ 155.000MHz

Emission Frequency (MHz)	Ant. Polarity(H/H)	Measurement Result Below carrier(dBc)	Limit below carrier(dBc)	Result(P/F)
155.000	H	0		pass
310.000	H	71.67	68	pass
465.000	H	72.12	68	pass
620.000	H	72.47	68	pass
775.000	H	75.75	68	pass
930.000	H	76.98	68	pass
1085.000	H	78.67	68	pass
1240.000	H	70.14	68	pass
1395.000	H	80.12	68	pass
1550.000	H	81.28	68	pass

Measurement Result for 12.5KHz Channel Separation @ 173.975MHz

Emission Frequency (MHz)	Ant. Polarity(H/H)	Measurement Result Below carrier(dBc)	Limit below carrier(dBc)	Result(P/F)
173.975	H	0		pass
347.950	H	69.87	68	pass
521.925	H	71.55	68	pass
695.900	H	73.73	68	pass
869.875	H	74.42	68	pass
1043.850	H	75.74	68	pass
1217.825	H	77.56	68	pass
1391.800	H	79.53	68	pass
1565.775	H	70.49	68	pass
1739.750	H	81.75	68	pass

Notes: The emissions were scanned from 30 MHz to 10th harmonics.

7.5 EMISSION MASK PLOT

The detailed procedure employed for Emission Mask measurements are specified as following:

- The transmitter shall be modulated by a 2.5 kHz audio signal,
- The level of the audio signal employed is 16 dB greater than that necessary to produce 50% of rated system deviation. Rated system deviation is 2.5 kHz.

The Worst Emission Mask D for 12.5KHz channel Separation (60W)

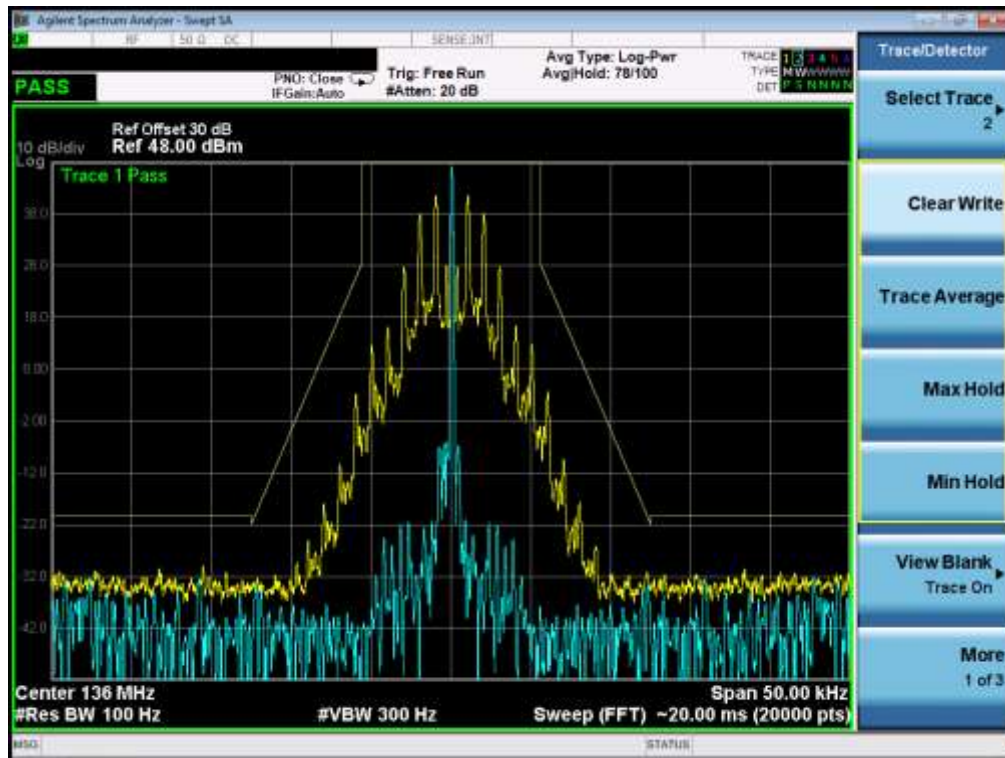

8. MODULATION CHARACTERISTICS

8.1 PROVISIONS APPLICABLE

According to CFR 47 section 2.1047(a), for Voice Modulation Communication Equipment, the frequency response of the audio modulation circuit over a range of 100 to 5000Hz shall be measured.

8.2 MEASUREMENT METHOD

8.2.1 Modulation Limit

- (1). Configure the EUT as shown in figure 1, adjust the audio input for 60% of rated system deviation at 1KHz using this level as a reference (0dB) and vary the input level from -20 to +20dB. Record the frequency deviation obtained as a function of the input level.
- (2). Repeat step 1 with input frequency changing to 300, 1000, 1500 and 3000Hz in sequence.

8.2.2 Audio Frequency Response

- (1). Configure the EUT as shown in figure 1.
- (2). Adjust the audio input for 20% of rated system deviation at 1 KHz using this level as a reference (0 dB).
- (3). Vary the Audio frequency from 100 Hz to 10 KHz and record the frequency deviation.
- (4). Audio Frequency Response = $20\log_{10}(\text{Deviation of test frequency}/\text{Deviation of 1 KHz reference})$.

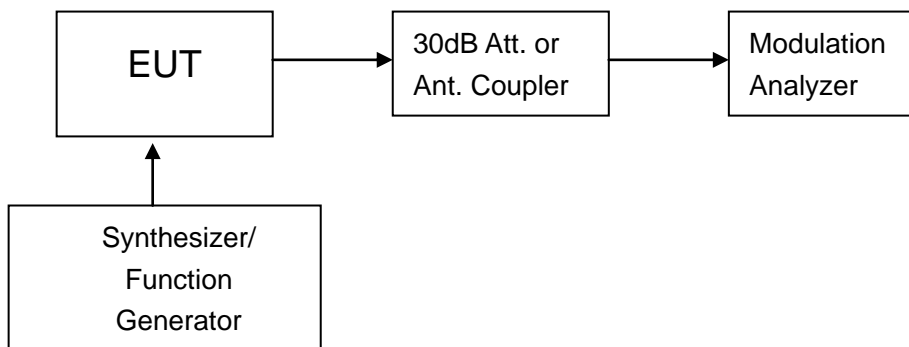

Figure 1: Modulation characteristic measurement configuration

8.3 MEASUREMENT RESULT

(A). MODULATION LIMIT:

Middle Channel @ 12.5KHz Channel Separations

Modulation Level (dB)	Peak Freq. Deviation At 300 Hz	Peak Freq. Deviation At 1000 Hz	Peak Freq. Deviation At 1500 Hz	Peak Freq. Deviation At 3000 Hz
-20	0.28	0.85	0.87	0.89
-15	0.34	0.94	0.97	1.04
-10	0.46	1.23	1.28	1.35
-5	0.53	1.35	1.44	1.48
0	0.65	1.5	1.56	1.59
5	0.73	1.63	1.73	1.86
10	0.86	1.7	1.77	1.87
15	0.94	1.64	1.74	1.79
20	0.87	1.55	1.65	1.74

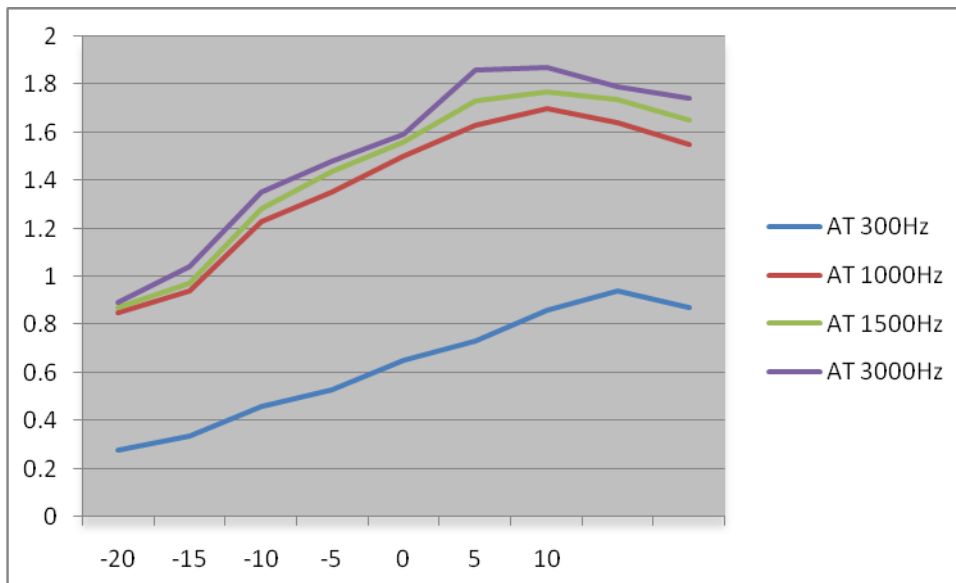

Note: All the modes had been tested, but only the worst data recorded in the report.

(B). AUDIO FREQUENCY RESPONSE:

Middle Channel @ 12.5KHz Channel Separations

Frequency (Hz)	Deviation (KHz)	Audio Frequency Response(dB)
100	--	--
200	--	--
300	0.16	-9.90
400	0.19	-8.40
500	0.24	-6.38
600	0.28	-5.04
700	0.29	-4.73
800	0.36	-2.85
900	0.42	-1.51
1000	0.5	0.00
1200	0.55	0.83
1400	0.65	2.28
1600	0.75	3.52
1800	0.88	4.91
2000	0.96	5.67
2400	1.24	7.89
2500	1.46	9.31
2800	1.66	10.42
3000	1.75	10.88
3200	1.71	10.68
3600	1.57	9.94
4000	1.05	6.44
4500	0.85	4.61
5000	0.74	3.41
5500	0.56	0.98
6000	0.14	-11.06
6500	0.06	-18.42
7000	0.04	-21.94
7500	0.01	-33.98
9000	--	--
10000	--	--
14000	--	--
18000	--	--
20000	--	--
30000	--	--

Frequency Response of Middle Channel (VHF)

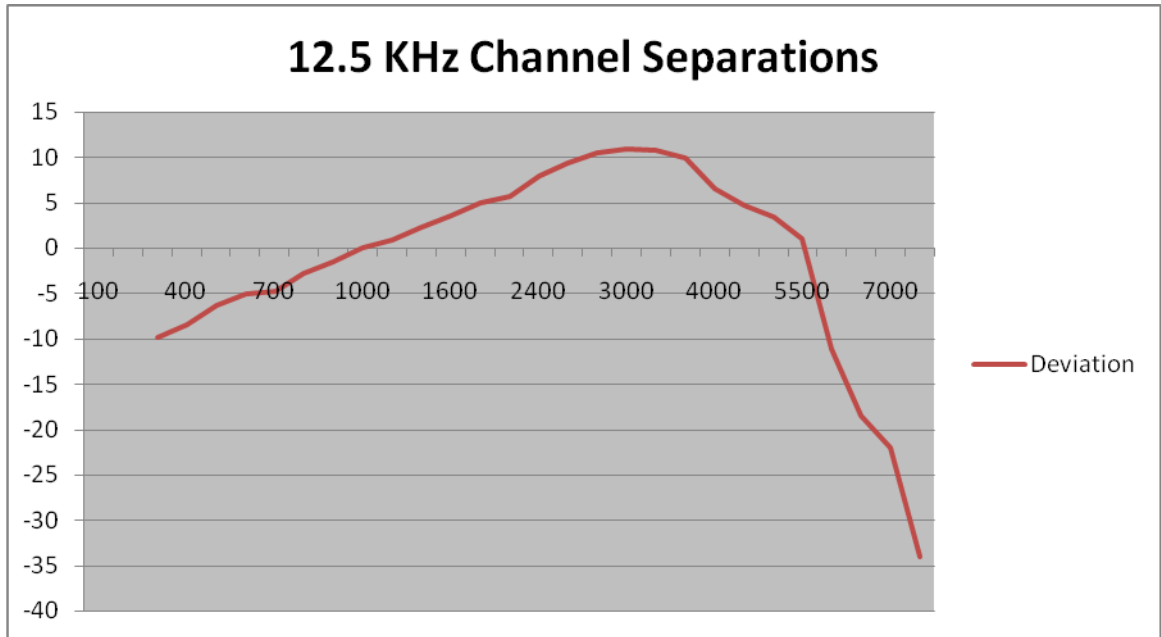

Note: All the modes had been tested, but only the worst data recorded in the report.

9. MAXIMUM TRANSMITTER POWER

9.1 PROVISIONS APPLICABLE

Per FCC §2.1046 and §90.205 AND RSS 119 Part 4.1: Maximum ERP is dependent upon the station's antenna HAAT and required service area.

9.2 TEST PROCEDURE

The RF output of Two-way Radio was conducted to a spectrum analyzer through an appropriate attenuator.

9.3 TEST CONFIGURATION

Conducted Output Power:

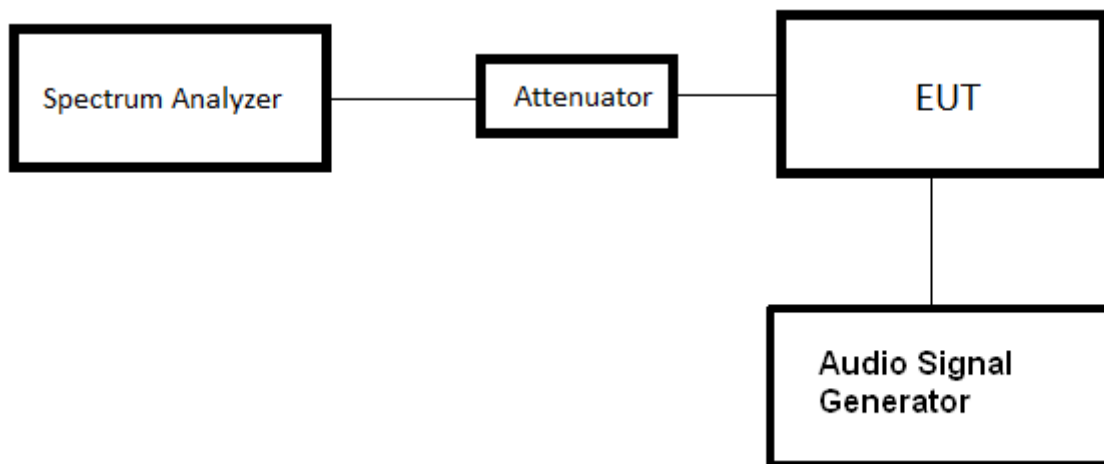

Effective Radiated Power measurement
Below 1GHz

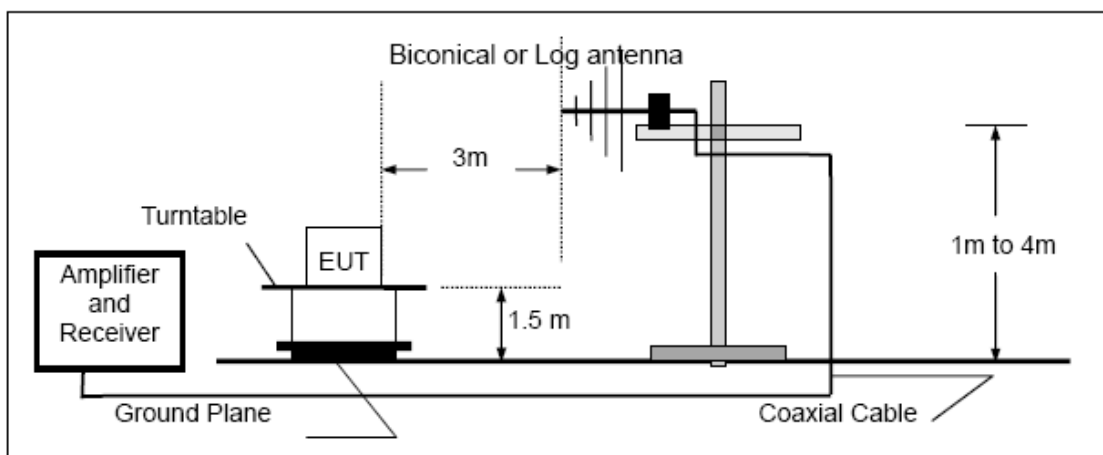

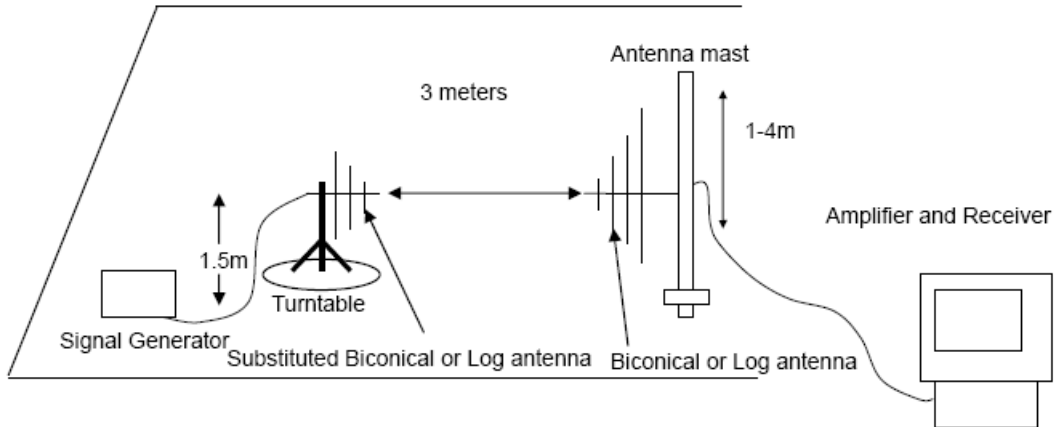

Above 1GHz

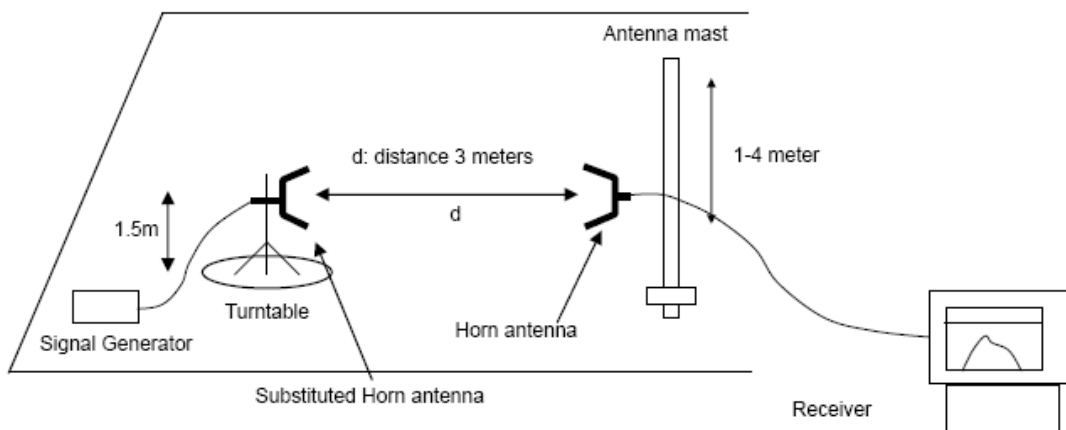
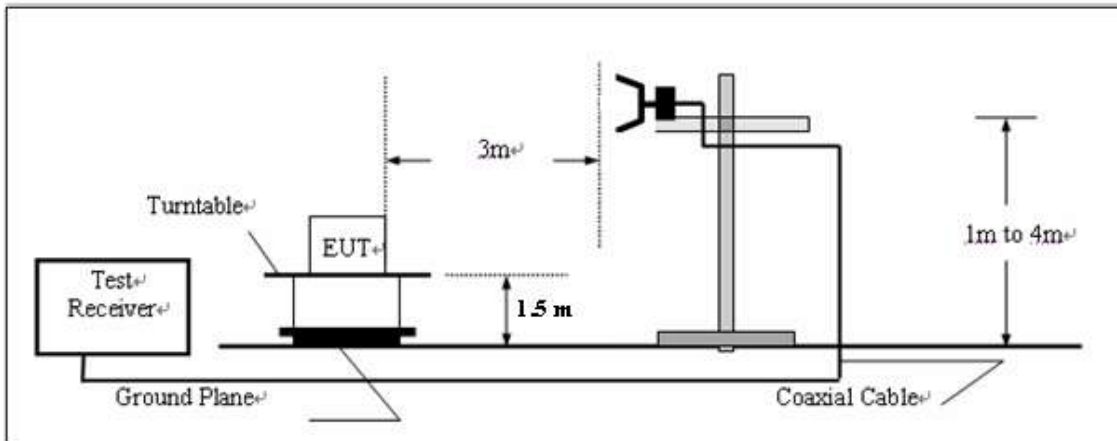

9.4 TEST RESULT

The maximum Conducted Power (CP) is
60W for 12.5KHz Channel Separation

Calculation Formula: $CP = R + A + L$

* Note:

CP: The final Conducted Power

R : The reading value from spectrum analyzer

A : The attenuation value of the used attenuator

L : The loss of all connection cables

Conducted Power Measurement Results		
Channel Separation	Channel	Measurement Result (dBm)
		For 47.78dBm(60W)
12.5KHz	Bottom(136.025MHz)	47.68
	Middle(155.000MHz)	47.71
	Top (173.975MHz)	47.65

9.5 CONDUCT SPURIOUS PLOT

Conducted Spurious Emission (worst) @ 136.025MHz With 12.5KHz Channel Separation 30MHz-1GHz

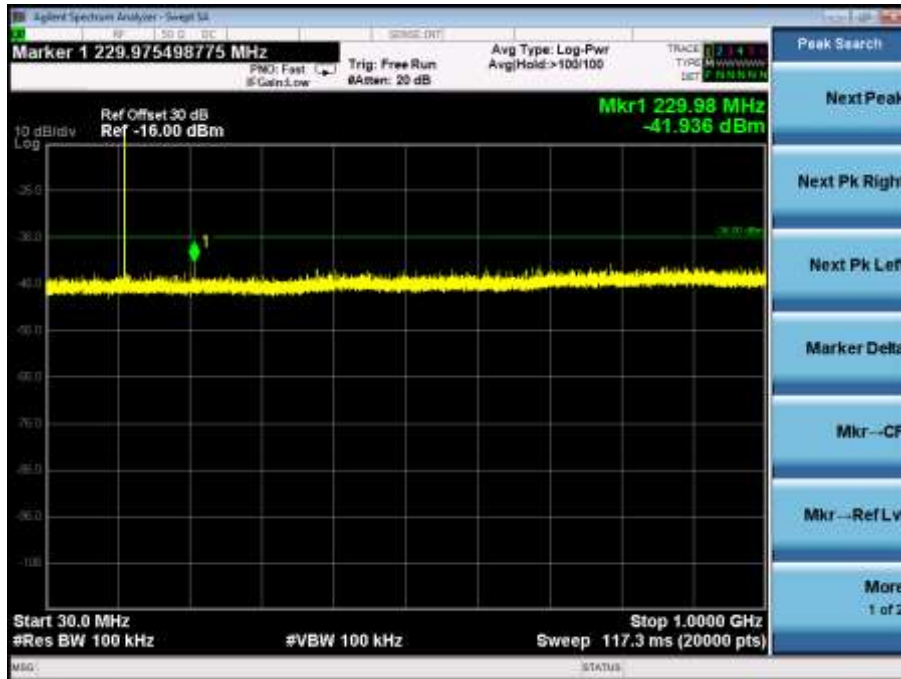

Conduct Spurious Emission (worst) @ 136.025MHz With 12.5KHz Channel Separation 1GHz-12.75GHz

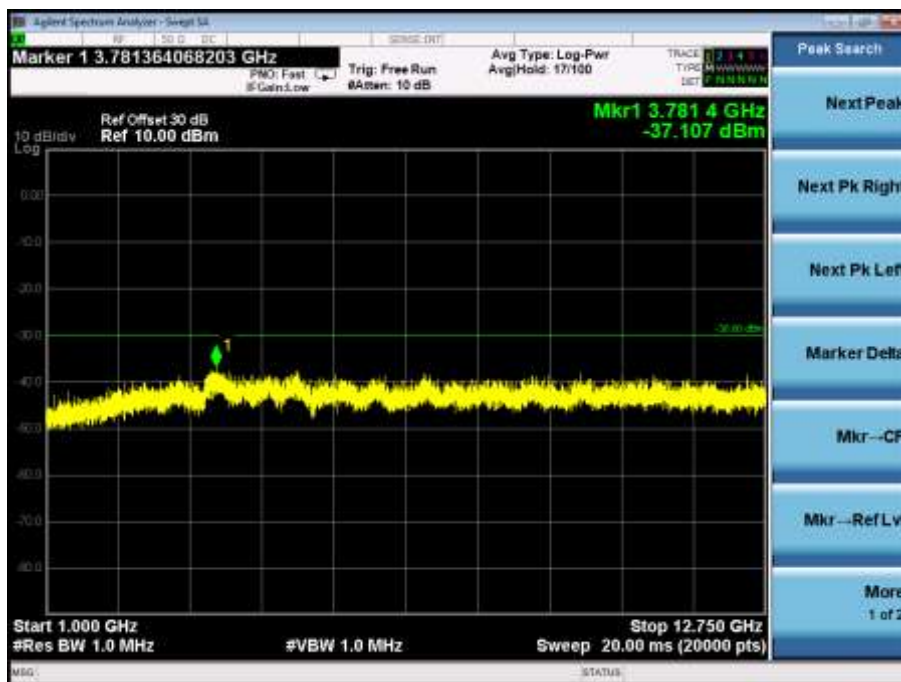

10. TRANSMITTER FREQUENCY BEHAVIOR

10.1 PROVISIONS APPLICABLE

Section 90.214

Time intervals ^{1, 2}	Maximum frequency difference ³	All equipment	
		150 to 174 MHz	421 to 512 MHz
Transient Frequency Behavior for Equipment Designed to Operate on 25 kHz Channels			
t ₁ ⁴	± 25.0 kHz	5.0 ms	10.0 ms
t ₂	± 12.5 kHz	20.0 ms	25.0 ms
t ₃ ⁴	± 25.0 kHz	5.0 ms	10.0 ms
Transient Frequency Behavior for Equipment Designed to Operate on 12.5 kHz Channels			
t ₁ ⁴	± 12.5 kHz	5.0 ms	10.0 ms
t ₂	± 6.25 kHz	20.0 ms	25.0 ms
t ₃ ⁴	± 12.5 kHz	5.0 ms	10.0 ms
Transient Frequency Behavior for Equipment Designed to Operate on 6.25 kHz Channels			
t ₁ ⁴	± 6.25 kHz	5.0 ms	10.0 ms
t ₂	± 3.125 kHz	20.0 ms	25.0 ms
t ₃ ⁴	± 6.25 kHz	5.0 ms	10.0 ms

¹ t_{on} is the instant when a 1 kHz test signal is completely suppressed, including any capture time due to phasing.

t₁ is the time period immediately following t_{on}.

t₂ is the time period immediately following t₁.

t₃ is the time period from the instant when the transmitter is turned off until t_{off}.

t_{off} is the instant when the 1 kHz test signal starts to rise.

² During the time from the end of t₂ to the beginning of t₃, the frequency difference must not exceed the limits specified in § 90.213.

³ Difference between the actual transmitter frequency and the assigned transmitter frequency.

⁴ If the transmitter carrier output power rating is 6 watts or less, the frequency difference during this time period may exceed the maximum frequency difference for this time period.

10.2 TEST METHOD

TIA/EIA-603 2.2.19

10.3 DESCRIBE LIMIT LINE OF TRANSMITTER FREQUENCY BEHAVIOR

ton: The switch-on instant ton of a transmitter is defined by the condition when the output power, measured at the antenna terminal, exceeds 0,1 % of the full output power (-30 dBc).

t1: period of time starting at ton and finishing according to above 11.1

t2: period of time starting at the end of t1 and finishing according to above 11.1

toff: switch-off instant defined by the condition when the output power falls below 0,1 % of the full output power (-30 dBc).

t3: period of time that finishing at toff and starting according to above 11.1

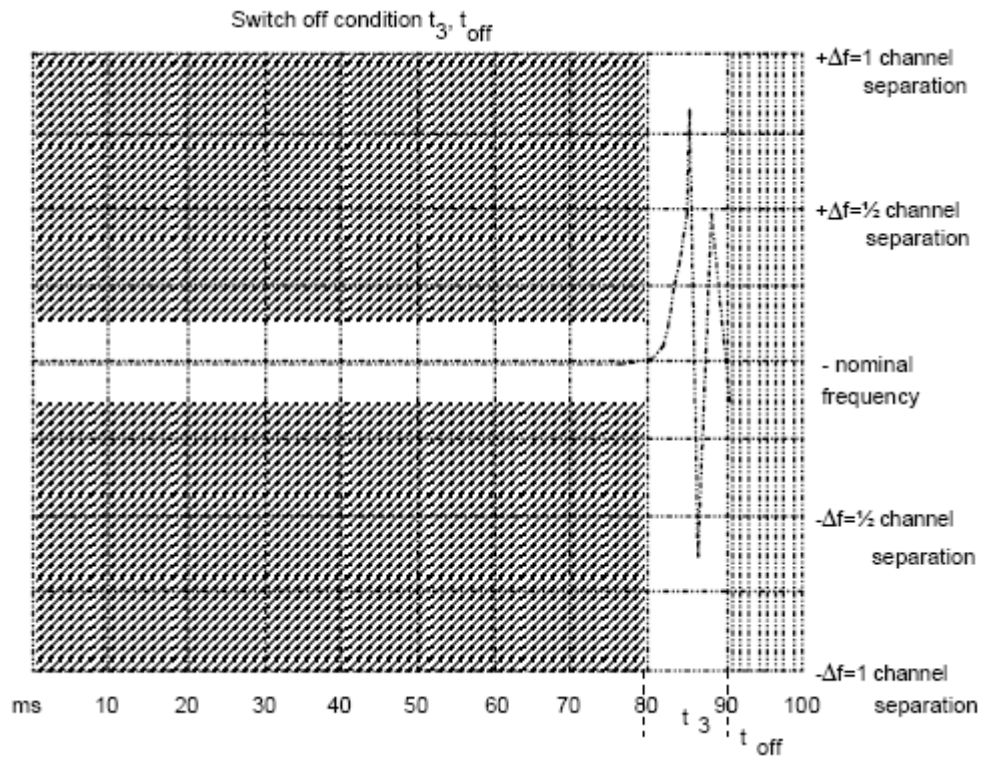
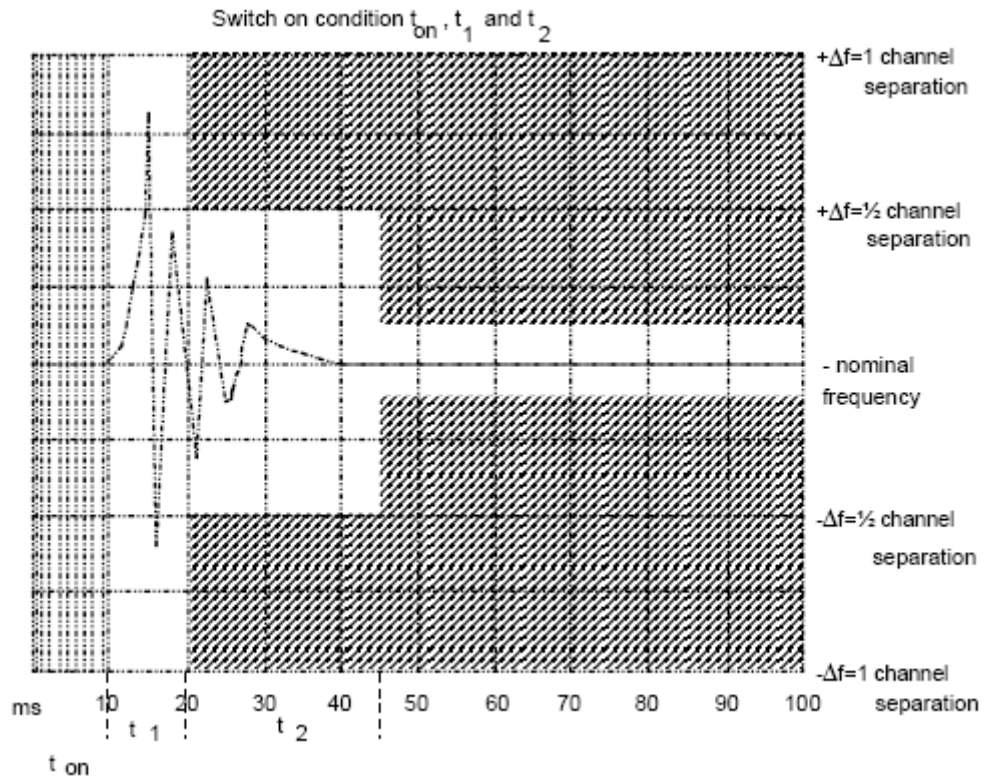

10.4 MEASURE RESULT

Transmitter Frequency Behavior @ 12.5 KHz Channel Separation--Off to On

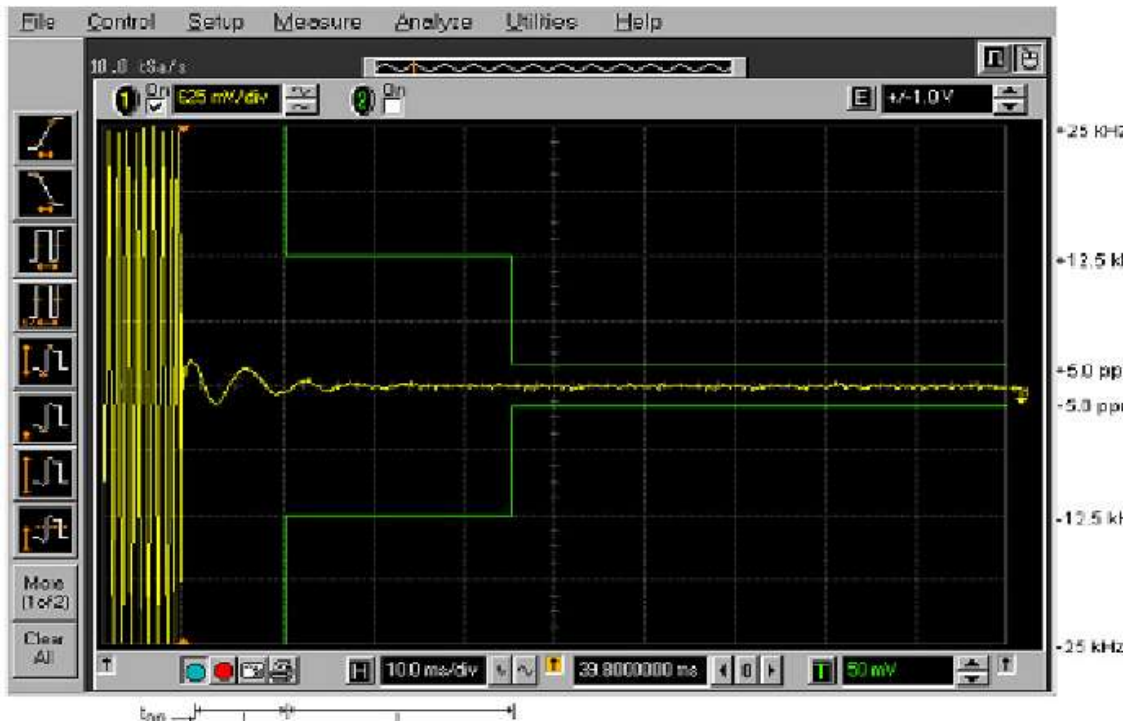

Transmitter Frequency Behavior @ 12.5 KHz Channel Separation--On to Off

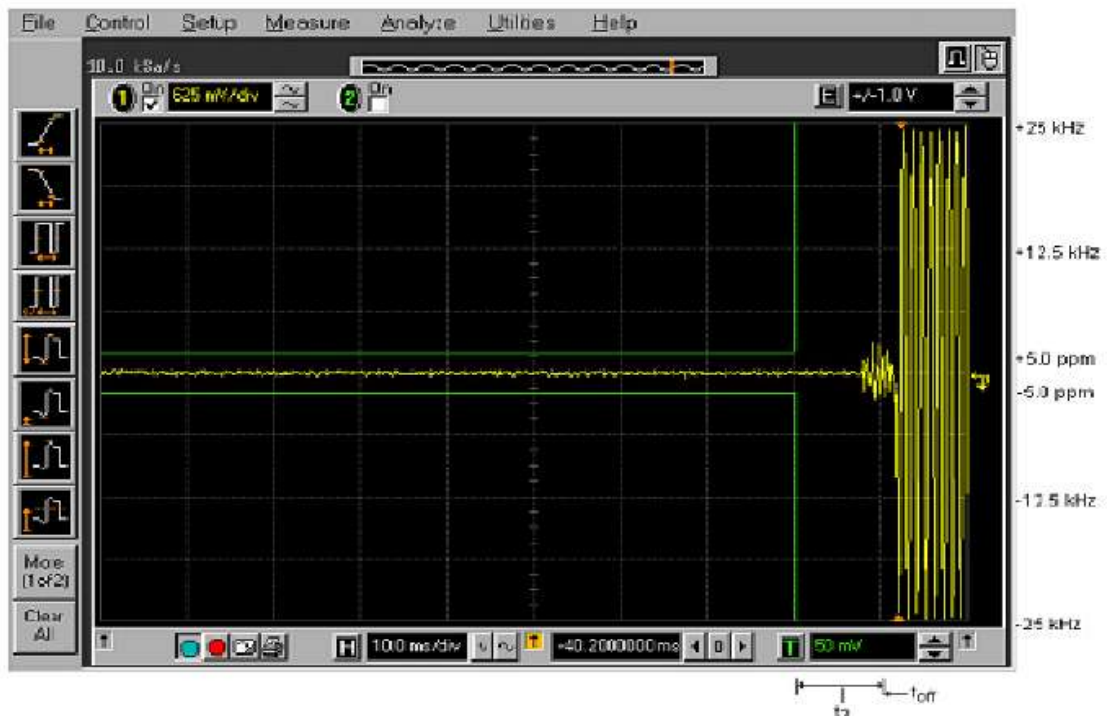

11. RADIATED EMISSION ON RECEIVING MODE

11.1 PROVISIONS APPLICABLE

FCC Part 15 Subpart B Section 15.109

RSS-Gen Subpart B Section RSS-Gen.6.1

11.2 TEST METHOD

ANSI C 63.4: 2003

11.1 MEASURE RESULT (MEASURED AT 3M USING FCC PART15 B LIMITS)

RADIATED EMISSION TEST RESULTS – HORIZONTAL

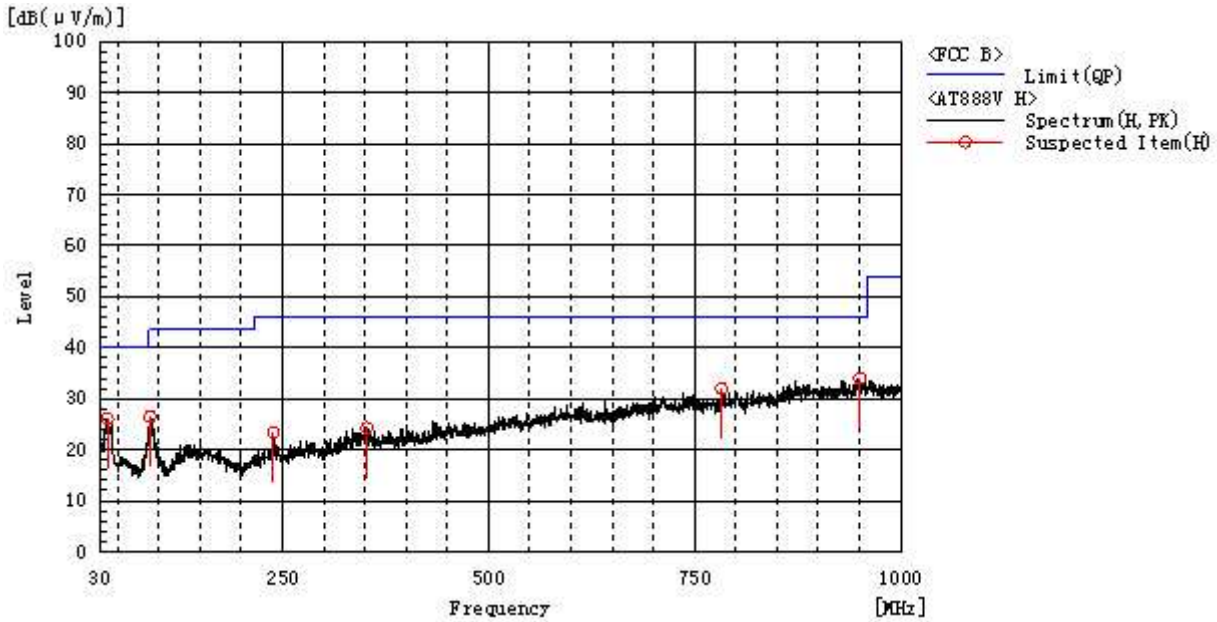

Frequency MHz	Polarization	Reading dB(uV)	Factor dB (1/m)	Level dB(uV/m) PK	Limit dB(uV/m) QP	Margin dB	Pass/Fail	Height cm	Angle deg
38.245	H	4.9	21.2	26.1	40.0	13.9	Pass	100.0	106.6
89.655	H	17.1	9.4	26.5	43.5	17.0	Pass	150.0	181.4
239.035	H	9.9	13.5	23.4	46.0	22.6	Pass	150.0	35.7
352.525	H	6.0	18.3	24.3	46.0	21.7	Pass	100.0	35.8
782.720	H	6.3	25.7	32.0	46.0	14.0	Pass	100.0	287.1
950.530	H	5.3	28.7	34.0	46.0	12.0	Pass	200.0	177.4

RADIATED EMISSION TEST RESULTS – VERTICAL

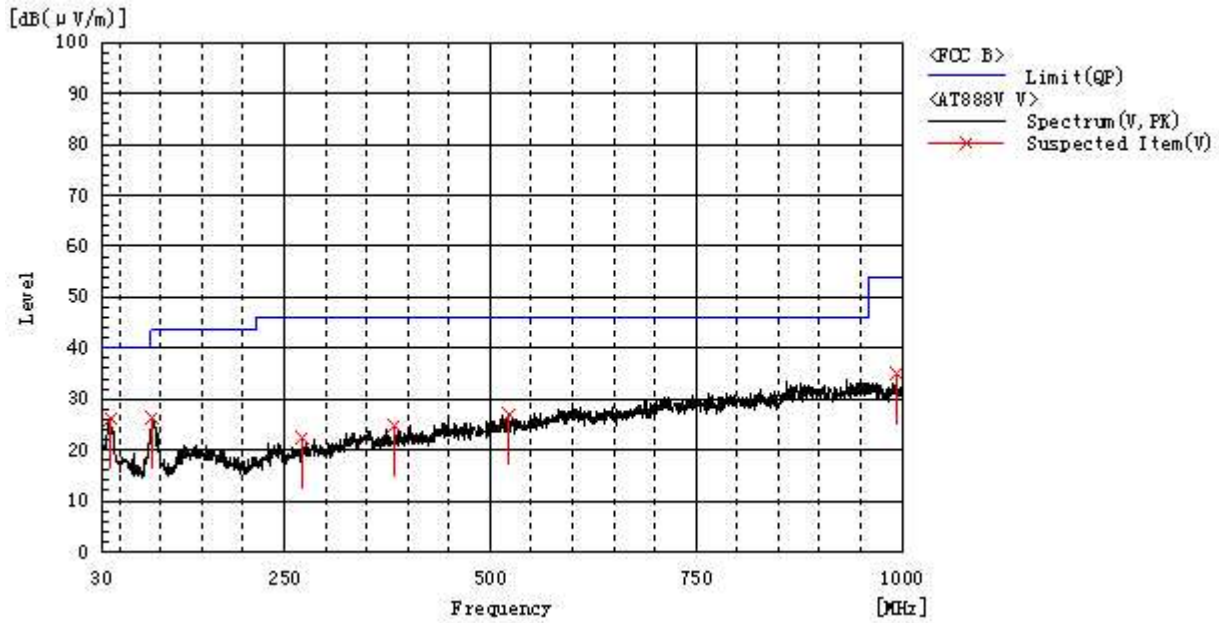

Frequency MHz	Polarization	Reading dB(uV)	Factor dB (1/m)	Level dB(uV/m) PK	Limit dB(uV/m) QP	Margin dB	Pass/Fail	Height cm	Angle deg
39.215	V	5.4	20.7	26.1	40.0	13.9	Pass	200.0	73.6
90.625	V	16.9	9.4	26.3	43.5	17.2	Pass	200.0	219.1
993.210	V	6.6	28.4	35.0	54.0	19.0	Pass	100.0	141.5
272.500	V	7.6	14.8	22.4	46.0	23.6	Pass	150.0	180.1
383.565	V	6.4	18.3	24.7	46.0	21.3	Pass	150.0	250.6
522.760	V	5.5	21.5	27.0	46.0	19.0	Pass	200.0	219.1

RADIATED EMISSION TEST RESULTS – HORIZONTAL (ABOVE 1G)

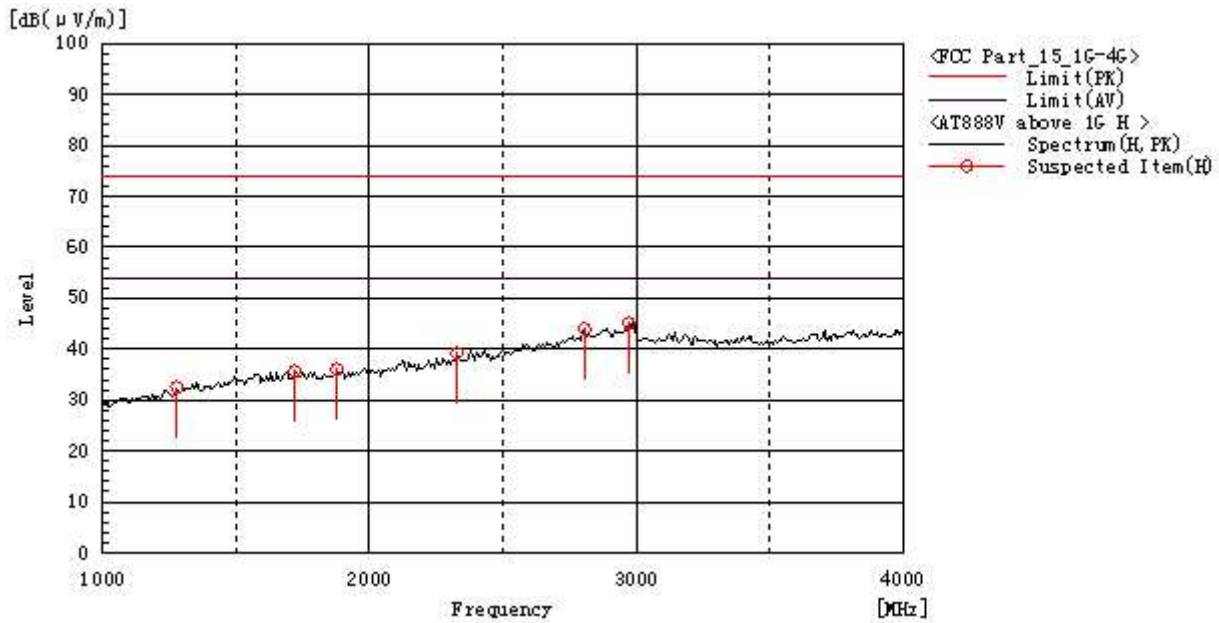

Frequency MHz	Polarization	Reading dB(uV)	Factor dB (1/m)	Level dB(uV/m) PK	Limit dB(uV/m) PK	Margin dB PK	Pass/Fail	Height cm	Angle deg
2807.500	H	41.4	2.6	44.0	74.0	30.0	Pass	200.0	252.9
2972.500	H	41.8	3.3	45.1	74.0	28.9	Pass	200.0	179.7
2327.500	H	40.4	-1.1	39.3	74.0	34.7	Pass	100.0	151.3
1720.000	H	39.1	-3.4	35.7	74.0	38.3	Pass	100.0	151.3
1877.500	H	39.2	-3.1	36.1	74.0	37.9	Pass	100.0	296.7
1277.500	H	38.1	-5.6	32.5	74.0	41.5	Pass	100.0	188.5

RADIATED EMISSION TEST RESULTS – VERTICAL (ABOVE 1G)

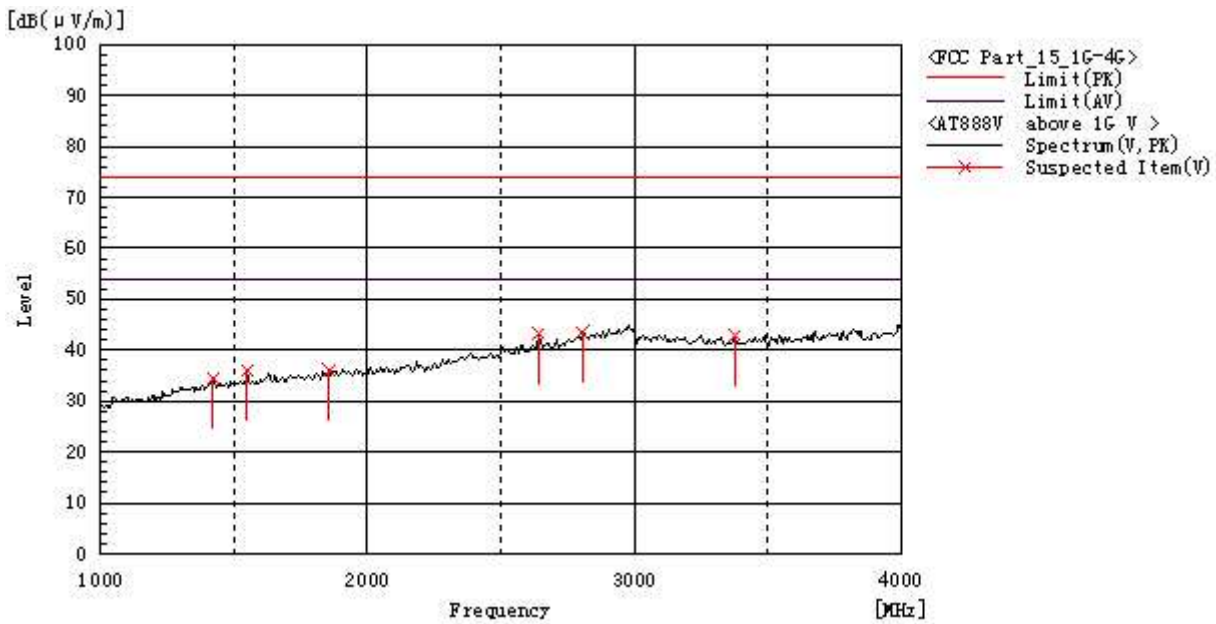

Frequency MHz	Polarization	Reading dB(uV)	Factor dB (1/m)	Level dB(uV/m) PK	Limit dB(uV/m) PK	Margin dB PK	Pass/Fail	Height cm	Angle deg
2642.500	V	41.9	1.3	43.2	74.0	30.8	Pass	100.0	285.2
1547.500	V	39.9	-3.9	36.0	74.0	38.0	Pass	200.0	220.9
1420.000	V	39.1	-4.6	34.5	74.0	39.5	Pass	100.0	72.6
1855.000	V	39.3	-3.2	36.1	74.0	37.9	Pass	100.0	72.6
2807.500	V	40.9	2.6	43.5	74.0	30.5	Pass	100.0	178.6
3377.500	V	38.8	4.0	42.8	74.0	31.2	Pass	200.0	294.1

12. AUDIO LOW PASS FILTER RESPONSE

12.1 LIMITS

2.1047(a): Voice modulated communication equipment. A curve or equivalent data showing the frequency response of the audio modulating circuit over a range of 100 to 5000 Hz shall be submitted. For equipment required to have an audio low-pass filter, a curve showing the frequency response of the filter or of all circuitry installed between the modulation limiter and the modulated stage shall be submitted.

90.242(b)(8): Recommended audio filter attenuation characteristics are given below:

Audio band	Minimum Attenuation Rel. to 1 KHz Attenuation
3 –20 KHz	$60 \log_{10}(f/3)$ dB where f is in KHz
20 – 30 KHz	50dB

12.2. METHOD OF MEASUREMENTS

The rated audio input signal was applied to the input of the audio low-pass filter (or of all modulation stages) using an audio oscillator, this input signal level and its corresponding output signal were then measured and recorded using the FFT Digital Spectrum Analyzer. Tests were repeated at different audio signal frequencies from 0 to 50 KHz.

12.3 TEST DATA

12.5 KHZ CHANNEL SPACING, F3E, FREQUENCY OF ALL MODULATION STATES (TEST RESULT FOR VHF)

Frequency	Audio In	Audio out	Attenuation	Attenuation	Recommended Attenuation
(KHz)	(dBV)	(dBV)	(Out_In)	Rel.to 3 KHz	(dB)
			dB	(dB)	
0.1	-76.15	-31.23	46.37	-36.57	
0.2	-76.15	-17.33	58.27	-25.66	
0.4	-76.15	-6.27	71.65	-12.82	
0.6	-76.15	0.43	74.25	-6.43	
0.8	-76.15	4.17	78.95	-2.92	
1.0	-76.15	7.16	83.65	-0.07	
1.5	-76.15	8.24	84.85	2.15	
2.0	-76.15	8.94	85.35	1.55	
2.5	-76.15	7.54	83.85	0.65	
3.0	-76.15	6.25	82.55	-1.83	0
3.5	-76.15	2.63	78.45	-4.94	-4
4.0	-76.15	-2.27	74.65	-9.44	-7
4.5	-76.15	-9.22	68.24	-16.54	-12
5.0	-76.15	-15.17	60.64	-21.74	-15
6.0	-76.15	-21.23	54.14	-28.63	-18
7.0	-76.15	-31.61	46.24	-36.43	-22
8.0	-76.15	-39.22	37.94	-47.65	-26
9.0	-76.15	-61.94	15.14	-66.96	-28
10.0	-76.15	-61.94	15.14	-66.46	-31
12.0	-76.15	-61.94	15.14	-66.46	-37
14.0	-76.15	-61.94	15.14	-66.46	-40
16.0	-76.15	-61.94	15.14	-66.46	-44
18.0	-76.15	-61.94	15.14	-66.46	-47
20.0	-76.15	-61.94	15.14	-66.46	-49
25.0	-76.15	-61.94	15.14	-66.46	-49
30.0	-76.15	-61.94	15.14	-66.46	-49
35.0	-76.15	-61.94	15.14	-66.46	-49
40.0	-76.15	-61.94	15.14	-66.46	-49
45.0	-76.15	-61.94	15.14	-66.46	-49
50.0	-76.15	-61.94	15.14	-66.46	-49

Note: Due to the difficulty of measuring the Frequency Response of the internal low-pass filter, the Frequency Response of All Modulation States is performed to show the roll-off at 3 KHz in comparison with the recommended audio filter attenuation.

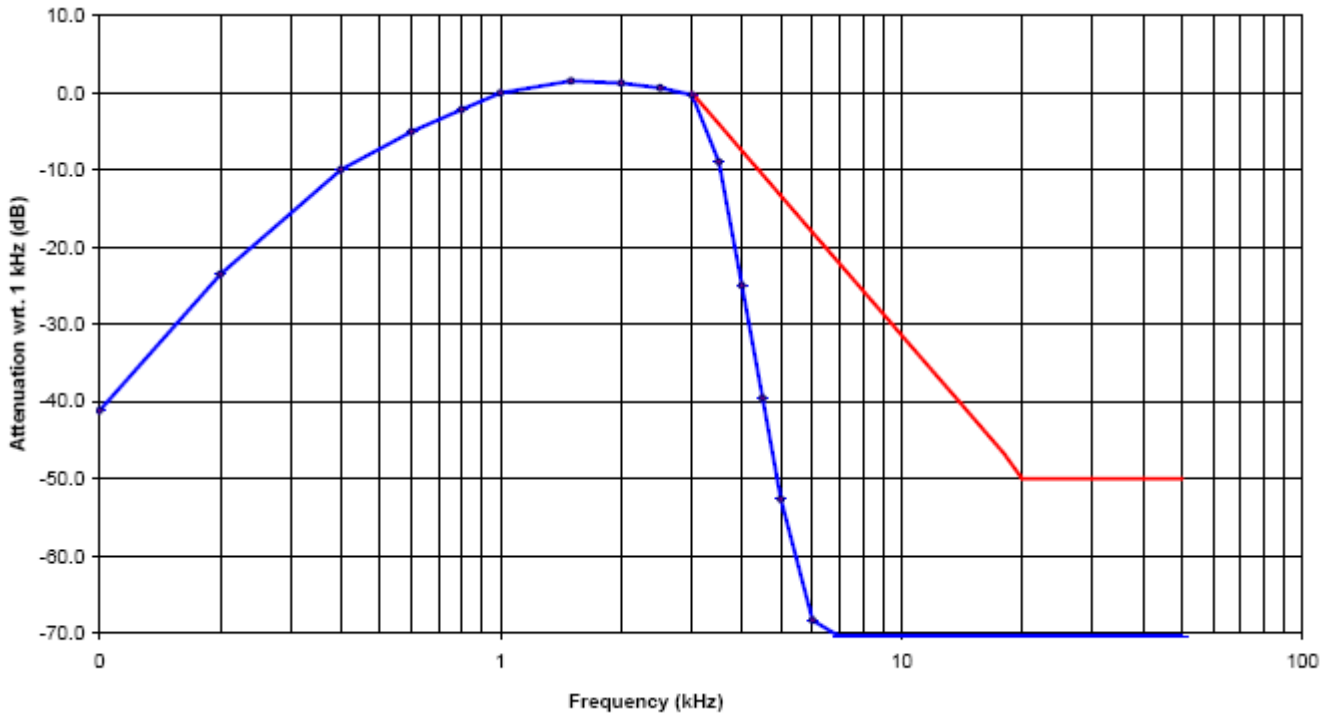

APPENDIX I: PHOTOGRAPHS OF SETUP
RADIATED EMISSION TEST SETUP



APPENDIX II: EXTERNAL VIEW OF EUT
TOTAL VIEW OF EUT



TOP VIEW OF EUT



BOTTOM VIEW OF EUT



FRONT VIEW OF EUT

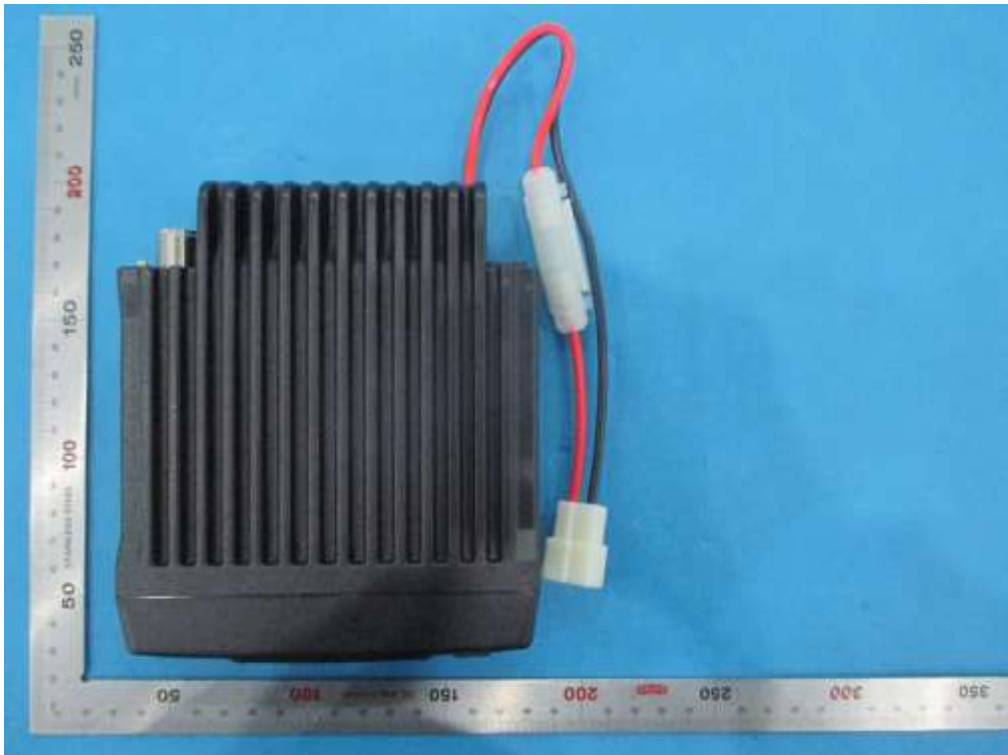

BACK VIEW OF EUT



LEFT VIEW OF EUT



RIGHT VIEW OF EUT



OPEN VIEW-1 OF EUT



OPEN VIEW-2 OF EUT



OPEN VIEW-3 OF EUT

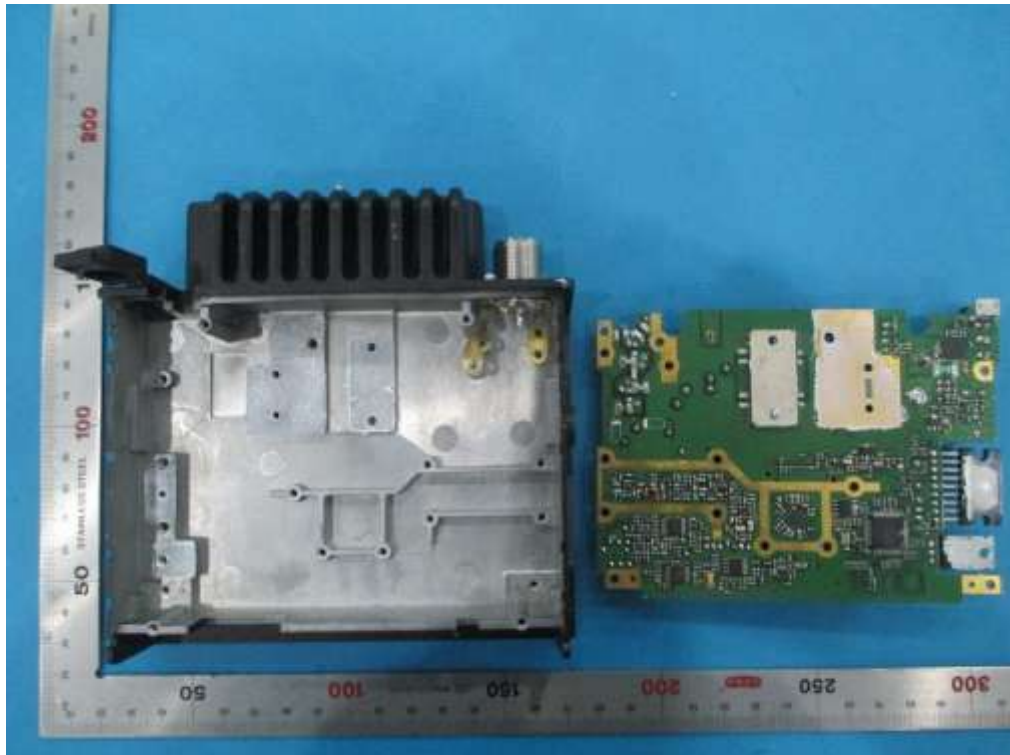

OPEN VIEW-4 OF EUT



OPEN VIEW-5 OF EUT



OPEN VIEW-6 OF EUT

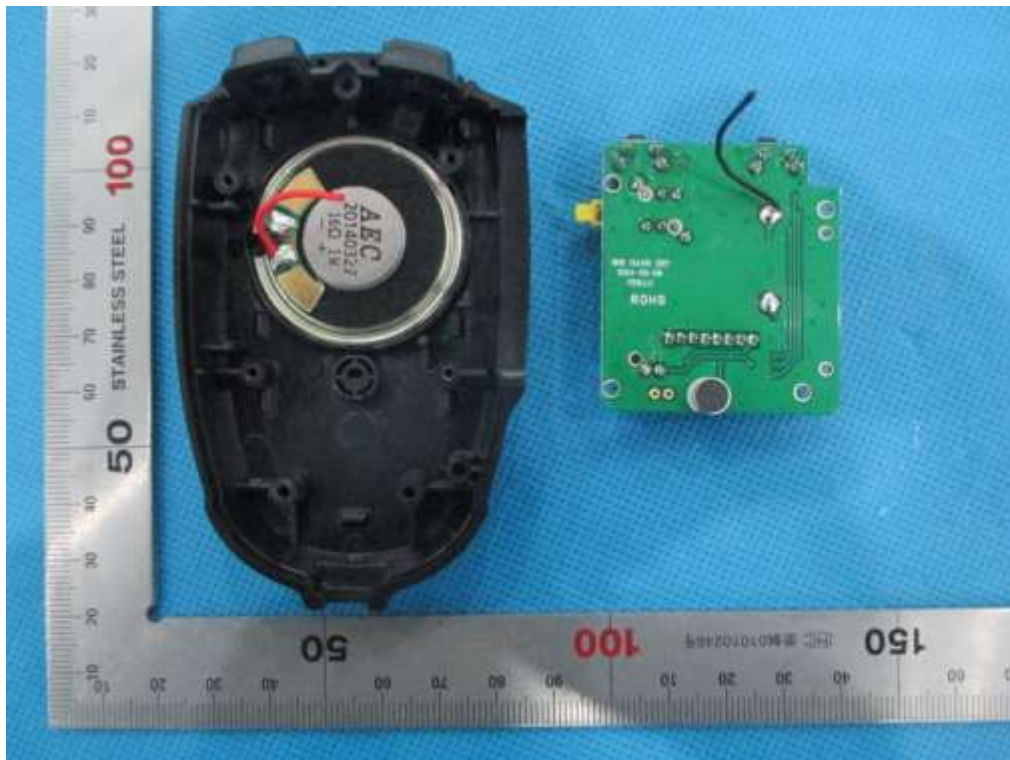

INTERNAL VIEW-1 OF EUT



INTERNAL VIEW-2 OF EUT



INTERNAL VIEW-3 OF EUT

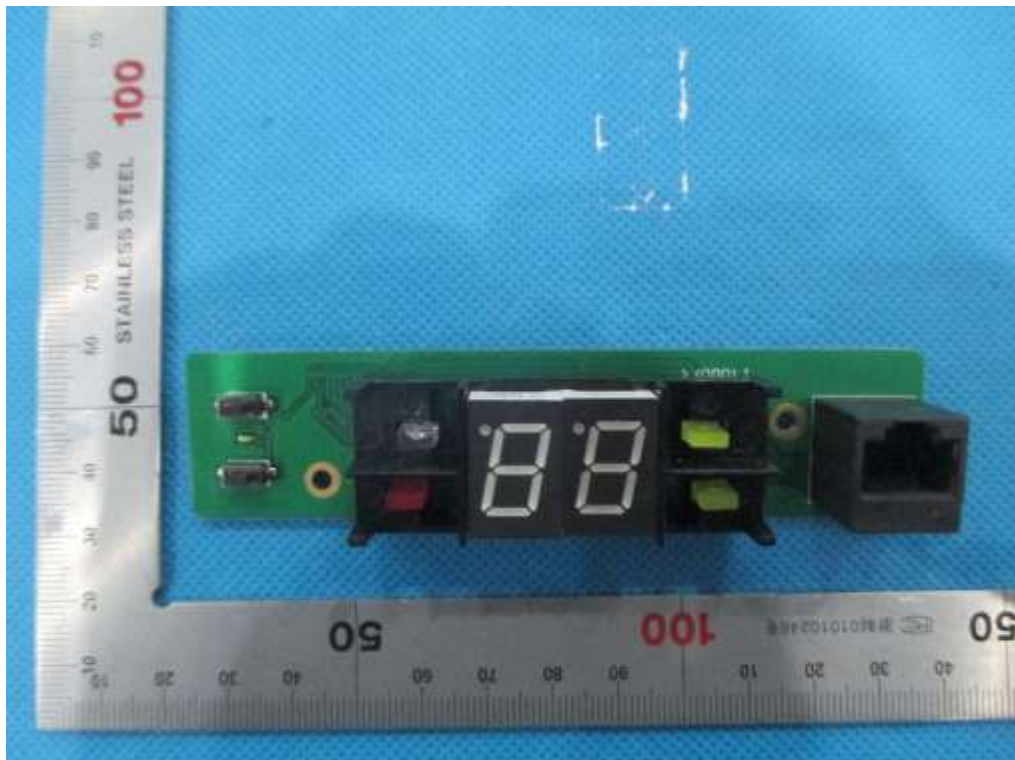

INTERNAL VIEW-4 OF EUT

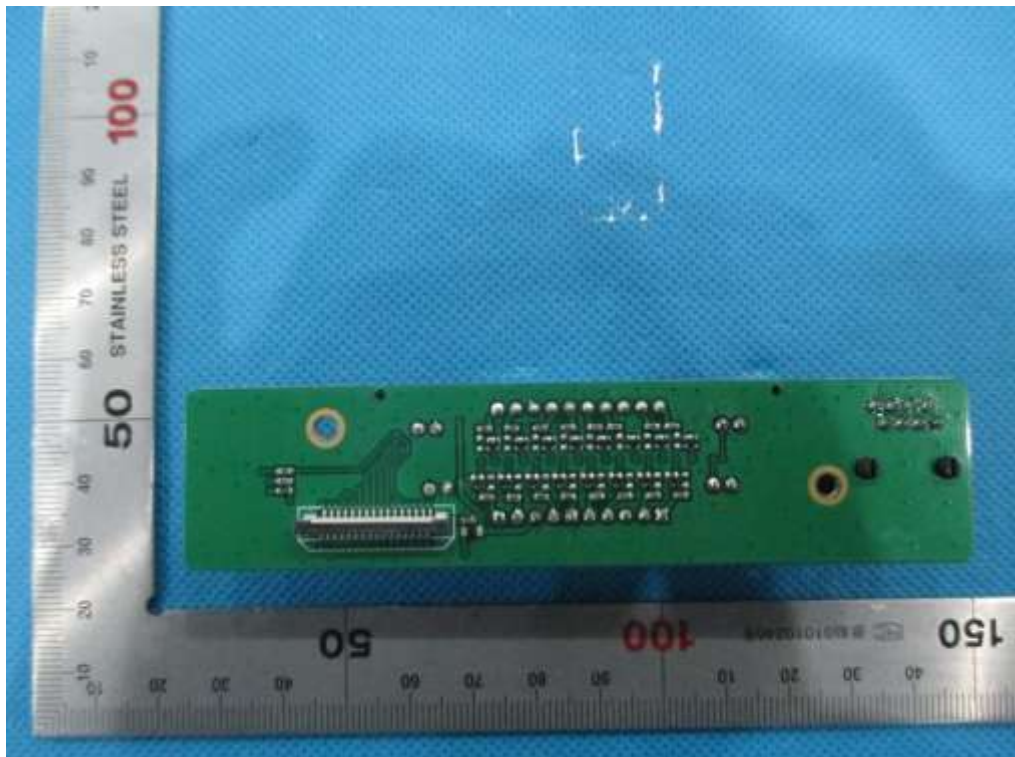

INTERNAL VIEW-5 OF EUT

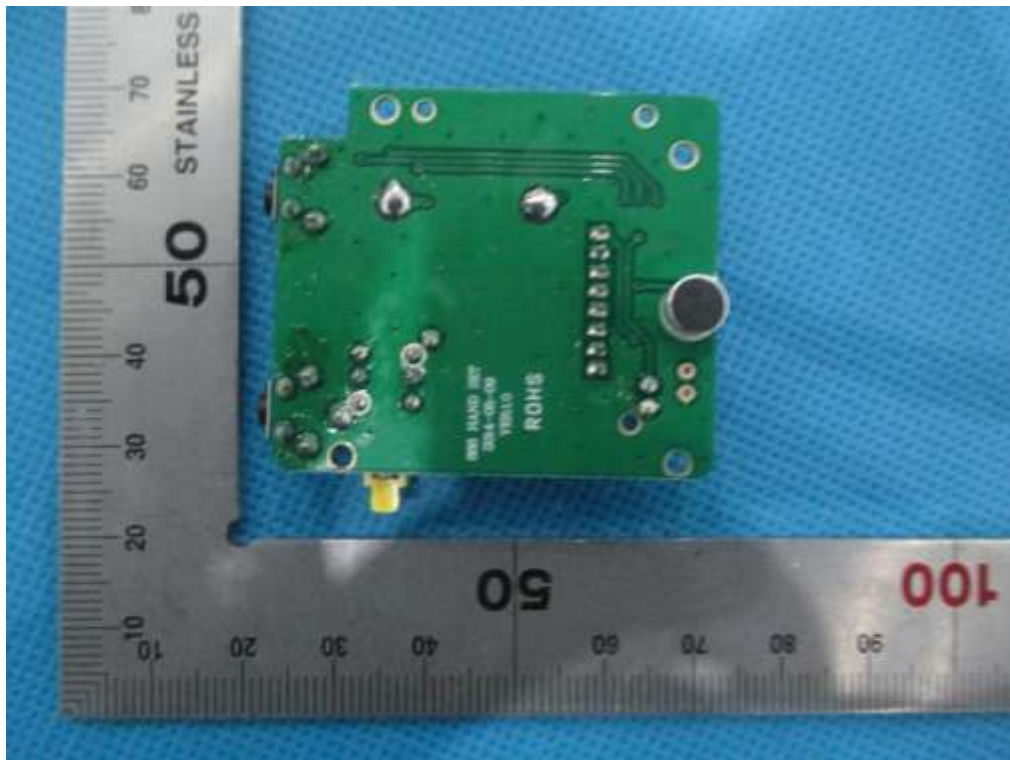

INTERNAL VIEW-6 OF EUT

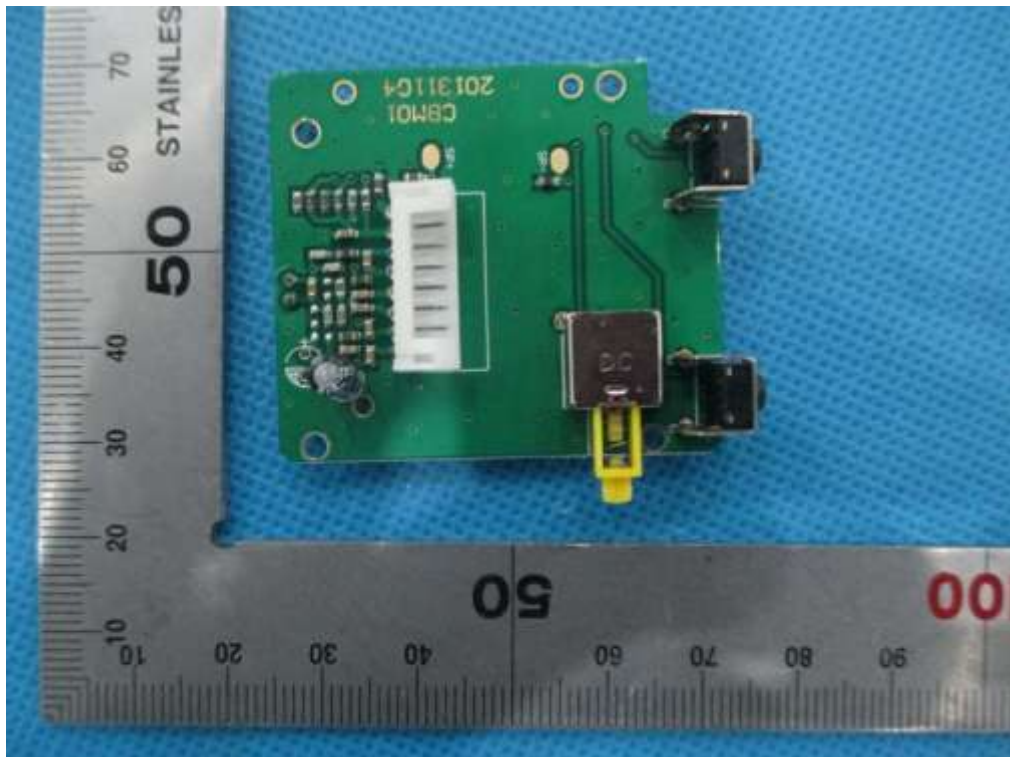

----END OF REPORT----