

# AT888

## Mobile Radio

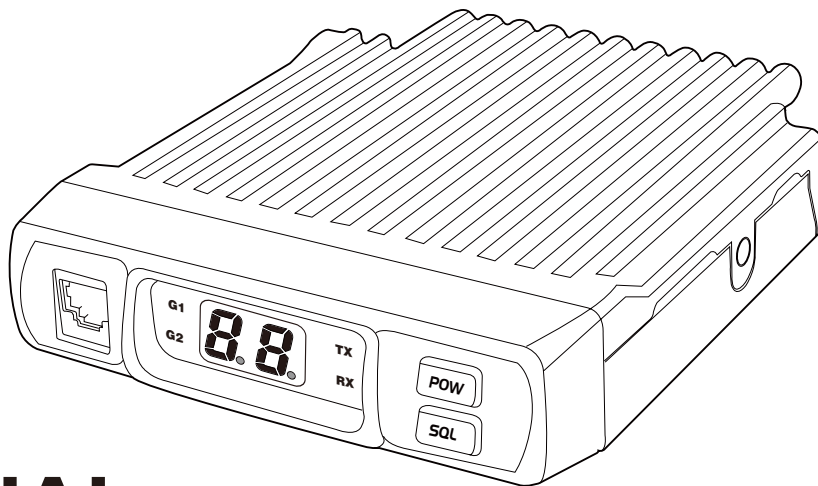

# USER'S MANUAL

FCC ID: T4KAT888U

Nice Housing, Stoutness & Stability, Advanced and Concise operation, Perfect & Valuable. **FC** **CE** **RoHS** Approval. 888 mobile radio especially designs for drivers with high cost performance.

*We only do best radio!*



**NOTE** When programming the transceiver, read the factory initial data firstly, then rewrite the frequency and signaling etc., otherwise errors may occur because of different frequency band etc..

888 Mobile Radio Applicable Software: QPS888

Models Apply To This Manual: AT888 Mobile radio

# MOBILE RADIO

---

---

Thank you for choosing this Mobile Radio vehicle transceiver, Mobile Radio always provides high quality products, And this transceiver is no exception. As you learn how to use this transceiver, you will find that Mobile Radio is pursuing "user operation", this transceiver with the advantage of concise operation and high cost performance.

Though concise operation for user, this transceiver is technically and commercially. and some features may be new to you. Consider this manual to be a personal tutorial from the designers, allow the manual to guide you through the learning process now, then act as a reference in the coming years.

## Precautions

Please observe the following precautions to prevent fire, personal injury, or transceiver damage:

- ⚠ Do not attempt to configure your transceiver while driving, it is dangerous.
- ⚠ This transceiver is designed for a 13.8V DC power supply. Don't use a 24V battery to power on the transceiver.
- ⚠ Do not place the transceiver in excessively dusty, humid or wet areas, nor unstable surfaces.
- ⚠ Please keep it away from interferential devices (such as TV, generator etc.).
- ⚠ Do not expose the transceiver to long periods of direct sunlight nor place it close to heating appliances.
- ⚠ If an abnormal odor or smoke is detected coming from the transceiver, turn OFF the power immediately. Contact an Anytone service station or your dealer.
- ⚠ Do not transmit with high output power for extended periods; the transceiver may overheat.

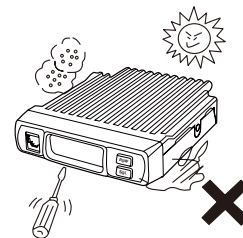

---

---

# CONTENTS

<b>Supplied Accessories/Optional Accessories.....</b>	<b>1</b>	<b>Maintenance.....</b>	<b>11</b>
Supplied Accessories.....	1	Default Setting after Resetting(UHF).....	11
Optional Accessories.....	1	Trouble Shooting.....	11
<b>Initial Installation.....</b>	<b>2</b>	<b>Attached Chart.....</b>	<b>12</b>
Mobile Installation.....	2	50 groups CTCSS Tone Frequency(Hz).....	12
DC Power Cable Connection.....	2	1024 groups DCS Code.....	12
Antenna Connection.....	4		
Accessories Connections.....	4		
<b>Getting Acquainted.....</b>	<b>6</b>		
Front panel.....	6		
Rear panel.....	6		
Microphone.....	7		
<b>Basic Operations.....</b>	<b>8</b>		
Switching the Power On.....	8		
Switching the Power Off.....	8		
Adjusting the Volume.....	8		
Channel Selection.....	8		
Receiving.....	8		
Squelch Level Setup.....	8		
Transmitting Pilot Frequency.....	9		
Transmit 2TONE,5TONE,DTMF.....	9		
Restore Factory Setting.....	9		
<b>Programming Software Installing and Starting (in windows XP system).....</b>	<b>10</b>		
Install USB Cable Driver Programme.....	10		

# 1 Supplied Accessories

## ■ SUPPLIED ACCESSORIES

After carefully unpacking the transceiver, identify the items listed in the table below. We suggest you keep the box and packaging.

- Transceiver

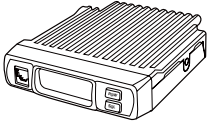

- Microphone

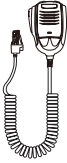

- DC Power Cable with Fuse Holder(QPL-01)



- User Manual



## MOBILE INSTALLATION

To install the transceiver, select a safe, convenient location inside your vehicle that minimizes danger to your passengers and yourself while the vehicle is in motion. Consider installing the unit at an appropriate position so that knees or legs will not strike it during sudden braking of your vehicle. Try to pick a well ventilated location that is shielded from direct sunlight.

1. Install the mounting bracket in the vehicle using the supplied self-tapping screws (4pcs) and flat washers (4pcs).

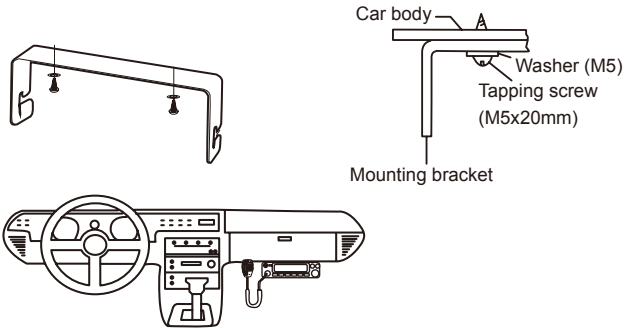

2. Position the transceiver, then insert and tighten the supplied hexagon SEMS screws.

- ▼ Double check that all screws are tightened to prevent vehicle vibration from loosening the bracket or transceiver.

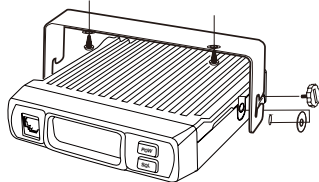

- ▼ Determine the appropriate angle of the transceiver, using the 3 screw hole positions on the side of the mounting bracket.

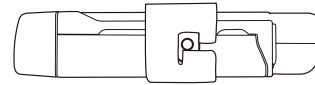

## DC POWER CABLE CONNECTION



**NOTE** Locate the power input connector as close to the transceiver as possible.

### ✘ MOBILE OPERATION

The vehicle battery must have a nominal rating of 12V. Never connect the transceiver to a 24V battery. Be sure to use a 12V vehicle battery that has sufficient current capacity. If the current to the transceiver is insufficient, the display may darken during transmission, or transmitting output power may drop excessively.

1. Route the DC power cable supplied with the transceiver directly to the vehicle's battery terminals using the shortest path from the transceiver. 2

- ▼ We recommend you do not use the cigarette lighter socket as some cigarette lighter sockets introduce an unacceptable voltage drop.
- ▼ The entire length of the cable must be dressed so it is isolated from heat, moisture, and the engine secondary (high voltage) ignition system/ cables.

2. After installing cable, in order to avoid the risk of damp, please use heat-resistant tap to tie together with fuse box. Don't forget to reinforce whole cable.
3. In order to avoid the risk of short circuit, please cut down connection with negative (-) of battery, then connect with radio.
4. Confirm the correct polarity of the connections, then attach the power cable to the battery terminals; red connects to the positive (+) terminal and black connects to the negative (-) terminal.

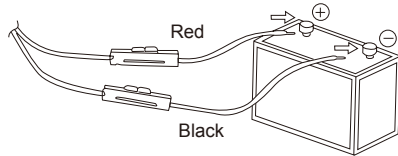

- ▼ Use the full length of the cable without cutting off excess even if the cable is longer than required. In particular, never remove the fuse holders from the cable.

- Reconnect any wiring removed from the negative terminal.
- Connect the DC power cable to the transceiver's power supply connector.
  - ▼ Press the connectors firmly together until the locking tab clicks.

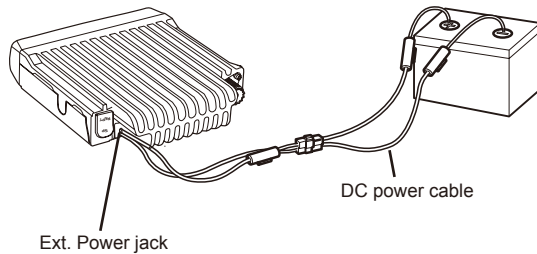

### ✘ FIXED STATION OPERATION

In order to use this transceiver for fixed station operation, you will need a separate 13.8V DC power supply (not included), power supply( QRP-01) as optional accessories. Please contact local dealer to require.

The recommended current capacity of your power supply is 12A.

- Connect the DC power cable to the regulated DC power supply and ensure that the polarities are correct. (Red: positive, Black: negative).

- ▼ Do not directly connect the transceiver to an AC outlet.
- ▼ Use the supplied DC power cable to connect the transceiver to a regulated power supply.
- ▼ Do not substitute a cable with smaller gauge wires.

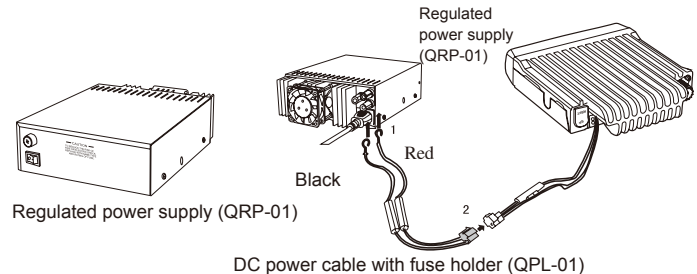

- Connect the transceiver's DC power connector to the connector on the DC power cable.

- ▼ Press the connectors firmly together until the locking tab clicks.
- NOTE**
- ▼ Before connecting the DC power to the transceiver, be sure to switch the transceiver and the DC power supply OFF.
  - ▼ Do not plug the DC power supply into an AC outlet until you make all connections. The EUT can be used on the vehicle.

### ✘ REPLACING FUSES

If the fuse blows, determine the cause, then correct the problem. After the problem is resolved, replace the fuse. If newly installed fuses continue to blow, disconnect the power cable and contact your authorized

Mobile Radio dealer or an authorized Mobile Radio service center for assistance.

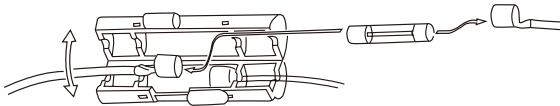

Fuse Location	Fuse Current Rating
Transceiver	15A
Supplied Accessory DC power cable	20A

Only use fuses of the specified type and rating, otherwise the transceiver could be damaged.

**NOTE** If you use the transceiver for a long period when the vehicle battery is not fully charged, or when the engine is OFF, the battery may become discharged, and will not have sufficient reserves to start the vehicle. Avoid using the transceiver in these conditions.

## ANTENNA CONNECTION

Before operating, install an efficient, well-tuned antenna. The success of your installation will depend largely on the type of antenna and its correct installation. The transceiver can give excellent results if the antenna system and its installation are given careful attention.

Use a 50Ω impedance antenna and low-loss coaxial feed-line that has a characteristic impedance of 50Ω, to match the transceiver input impedance. Coupling the antenna to the transceiver via feed-lines having an impedance other than 50Ω reduces the efficiency of the antenna system and can cause interference to nearby broadcast television receivers, radio receivers, and other electronic equipment.

**NOTE** Transmitting without first connecting an antenna or other matched load may damage the transceiver. Always connect the antenna to the transceiver before transmitting.  
All fixed stations should be equipped with a lightning arrester to reduce the risk of fire, electric shock, and transceiver damage.

The possible locations of antenna on a car are shown as following:



## ACCESSORIES CONNECTIONS

### EXTERNAL SPEAKER

If you plan to use an external speaker, choose a speaker with an impedance of 8Ω. The external speaker jack accepts a 3.5mm (1/8") mono (2-conductor) plug.

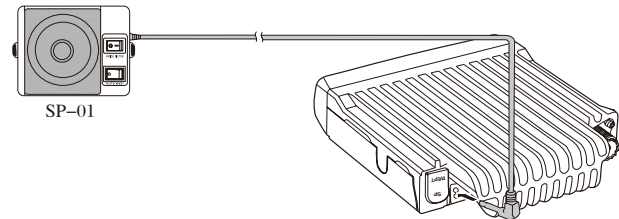

**NOTE** External speaker adopt double port BTL, please care about the connecting way. The speaker can not connect with the ground, otherwise the speaker will be fault. The wrong connecting way as the following picture.

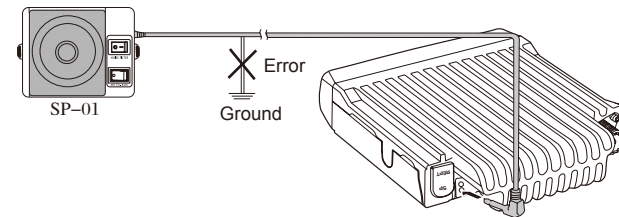



## 2

## Initial Installation

### ✕ MICROPHONE

For voice communications, connect a microphone equipped with an 8-pin modular plug into the modular socket on the front of the main unit. Press firmly on the plug until the locking tab clicks. Attach the supplied microphone hanger in an appropriate location using the screws included in the screw set.

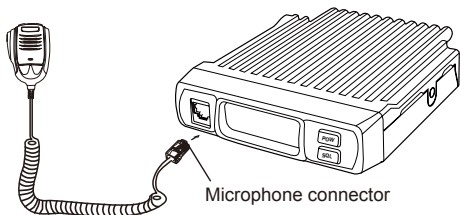

## 5

### ✕ PC CONNECTING

To utilize the optional QPS-888 software, you must first connect the transceiver to your PC then using an optional programming cable PC50 .

Please use QPS-888 software for programming.

<http://www.qxdz.cn>



NOTE

Ask your dealer about purchasing a Programming Cable PC50.

## FRONT PANEL

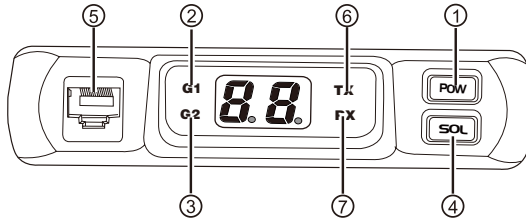

## • Basic Function

NO	KEY	FUNCTION
1	Power	Press this key turn on or turn off the transceiver.
2	G1	It refers current channel in the group 1.
3	G2	function keys.
4	SQL	squelch off
5	Mic/ program cable connection port	Step size key(1MHz step).
6	transmitting indicator	Set CTCSS and DCS value.
7	receive indicator	Call Key.

## REAR PANEL

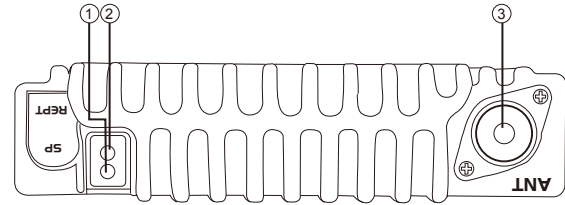

NO	KEY	FUNCTION
1	repeating connection port	Connecting by repeater cable to another QX888 and realize repeating function.
2	Ext speaker Terminal	Terminal for optional external speaker SP01.
3	Antenna Connector	Connection for 50Ω coaxial cable and antenna.

## MICROPHONE

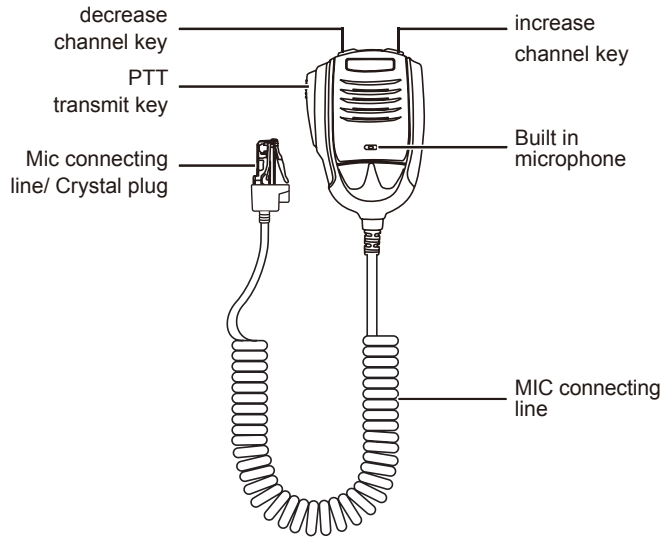

MIC Connector Diagram(in the front view of connector)

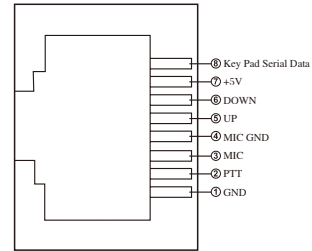

## SWITCHING THE POWER ON

In power off state, press **[POW]** key, until the transceiver sounds " DO-DO", the screen display current channel and group, the transceiver power on. The indicator light in the transceiver left side indicate the group, "G1" refers first group, "G2" refers second group.

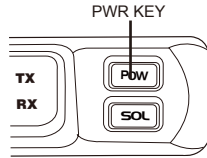

## SWITCHING THE POWER OFF

In standby state, press **[POW]** key, until transceiver sounds "DO-DO", the screen display nothing, the transceiver power off.

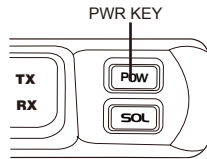

## ADJUSTING THE VOLUME

In standby state, press **[VOL]** key, when speaker sounds background noise press **[UP/DW]** key on microphone to adjust the volume. When adjusting volume, the bottom right corner of channel unit digit display a red dot, to distinguish channel value and volume value. This transceiver have 0~31 total 32 volume level for user's choose.

## CHANNEL SELECTION

In standby, press key **[UP/DN]** to choose desire channel, press **[UP]** to up adjust the channel, press **[DN]** to adjust the channel. Long press **[UP/DN]** to adjust the channel quick!

There are two groups of this transceiver, and every group has 100 channels, when one group UP adjust or Down adjust to last or first channel, then UP or DOWN adjust again, the channel will auto switch to another group. If the transceiver only one group, the channel will not switch group.

## RECEIVING

In standby state, the transceiver right side RX indicator light up, you can receive the match signal and hear someone talking.

The speaker is built in microphone, only connect microphone to hear someone talking.

**NOTE** When the transceiver RX indicator light up, but can not hearing transmit party calling, it refers current channel receive match carrier but different signal.

## SQUELCH LEVEL SETUP

Setting the radio to a tight squelch level, you can avoid unwanted signals or noise, but you may not receive a weak signal. Therefore, it will be better for you to select the normal squelch level.

In standby state, hold SQL key, then press **[UP/DN]** key to adjust squelch level, press **[UP]** to up adjust squelch level, press **[DN]** to down adjust squelch level.

This transceiver have total 10 squelch level for users selection. 0 level is normally open, squelch circuit but not mute. 9 is the biggest level.

The speaker is built in microphone, only connect microphone to hear someone talking.



NOTE

When the transceiver RX indicator light up, but can not hearing transmit party calling, it refers current channel receive match carrier but different signal.

### ■ TRANSMITTING PILOT FREQUENCY

In standby state, press PTT key then pres [DN] key to transmit pilot frequency.



NOTE

Pilot frequency should setup by program software.

9

### ■ TRAN 2TONE,5TONE,DTMF

In standby state, hold PTT key and [UP] key to transmit 2TONE,5TONE or DTMF signal, When the channel optional signal set to 2TONE, this operation can transmit the preset 2TONE signal. When the channel optional signal set to 5TONE, this operation can transmit the preset 5TONE signal. When the channel optional signal set to DTMF or none setting, this operation can transmit the preset DTMF signal.

### ■ RESTORE FACTORY SETTING

If the transceiver can not normal use since program error, you can restore to factory setting through this function.

In power off state, press [UP] key to power on, then all channel and functions restore to factory setting.

---

Double click "QPS888 setup.exe", then follow the installing instruction.

## INSTALL USB CABLE DRIVER PROGRAMME

1. Click start menu in computer, under "ALL PROGRAMS" menu, choose and click "USB To Com port" in QPS888 program, install "USB To Com port" driver by indication.
2. Connect the optional PC50 USB Programming cable to USB port in PC with transceiver.(As pic 1)
3. Double click QPS888 shortcut or click QPS888 in procedure index of start menu, choose serial com port as indicated then click OK to start programming software. (As pic 2)
4. According to instruction, select correct "COM Port"(As pic 3), then click "OK" to start programming software.

**Note:**Even in same computer, the selective COM Port is different when USB cable connects with different USB port.

You shall install software before connecting the USB cable line. Switch on transceiver before writing frequency. You had better not switch on or off the power supply of transceiver when it is connected with computer, otherwise, it will make transceiver unable to read or write frequency. In this case, you have to turn off programming software, pull out USB cable. then reinsert USB cable and open software, then rechoose COM Port, it will turn into normal operation. Therefore, please connect transceiver with computer after switching on the transceiver. Don't restart transceiver power when it is connected with computer.

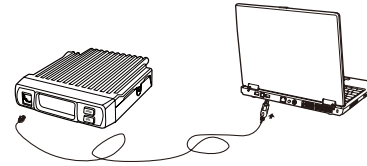

(As pic 1)

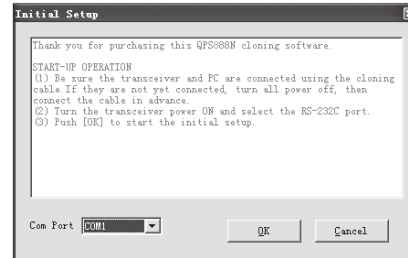

(As pic 2)

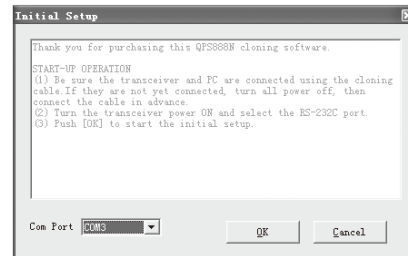

(As pic 3)



**NOTE** This software has product identify system, so when firstly installing the software, you have to connect the products, otherwise you can not start the software.

### ■ DEFAULT SETTING AFTER RESETTING(UHF)

	888	DCS encode and decode	—
UFO frequency	435.00MHz	DCS code	023N
Memory channel 0-199	—	Output power	HI
Offset direction	—	Key-lock setting	OFF
Offset frequency	5MHz	TOT	OFF
Channel step	12.5KHz	APO	OFF
CTCSS encode and decode	—	Squelch Level	4
CTCSS tone frequency	88.5Hz		

### ■ TROUBLE SHOOTING

Problem	Possible Causes and Potential Solutions
(a) Power is on, nothing appears on Display.	+ and - polarities of power connection are reversed. Connect red lead to plus terminal and black lead to minus terminal of DC power supply.
(b) Fuse is blown.	Check and solve problem resulting in blown fuse and replace fuse with new fuse.
(c) Display is too dim.	Dimmer setting is "LAMP-L". Please make the dimmer setting "LAMP-H".
(d) No sound comes from speaker.	<ul style="list-style-type: none"> <li>• Squelch is muted. Decrease squelch level.</li> <li>• Tone or CTCSS/DCS squelch is active. Turn CTCSS or DCS squelch off.</li> </ul>
(e) Key and Dial do not function.	Key-lock function is activated. Cancel Key-lock function.
(i) Rotating Dial will not change memory channel.	Transceiver is in CALL mode. Press the UFO or memory mode.
(g) PTT key is pressed but transmission does not occur.	<ul style="list-style-type: none"> <li>• Microphone connection is poor. Connect microphone properly.</li> <li>• Antenna connection is poor. Connect antenna properly.</li> </ul>

## 50 GROUPS CTCSS TONE FREQUENCY(HZ)

67.0	79.7	94.8	110.9	131.8	156.7	171.3	186.2	203.5	229.1
69.3	82.5	97.4	114.8	136.5	159.8	173.8	189.9	206.5	233.6
71.9	85.4	100.0	118.8	141.3	162.2	177.3	192.8	210.7	241.8
74.4	88.5	103.5	123.0	146.2	165.5	179.9	196.6	218.1	250.3
77.0	91.5	107.2	127.3	151.4	167.9	183.5	199.5	225.7	254.1

## 1024 GROUPS DCS CODE.

000	001	002	003	004	005	006	007
010	011	012	013	014	015	016	017
020	021	022	023	024	025	026	027
030	031	032	033	034	035	036	037
040	041	042	043	044	045	046	047
050	051	052	053	054	055	056	057
060	061	062	063	064	065	066	067
070	071	072	073	074	075	076	077
100	101	102	103	104	105	106	107
110	111	112	113	114	115	116	117
120	121	122	123	124	125	126	127
130	131	132	133	134	135	136	137
140	141	142	143	144	145	146	147
150	151	152	153	154	155	156	157
160	161	162	163	164	165	166	167
170	171	172	173	174	175	176	177
200	201	202	203	204	205	206	207
210	211	212	213	214	215	216	217
220	221	222	223	224	225	226	227
230	231	232	233	234	235	236	237
240	241	242	243	244	245	246	247
250	251	252	253	254	255	256	257
260	261	262	263	264	265	266	267
270	271	272	273	274	275	276	277
300	301	302	303	304	305	306	307
310	311	312	313	314	315	316	317
320	321	322	323	324	325	326	327
330	331	332	333	334	335	336	337



340	341	342	343	344	345	346	347
350	351	352	353	354	355	356	357
360	361	362	363	364	365	366	367
370	371	372	373	374	375	376	377
400	401	402	403	404	405	406	407
410	411	412	413	414	415	416	417
420	421	422	423	424	425	426	427
430	431	432	433	434	435	436	437
440	441	442	443	444	445	446	447
450	451	452	453	454	455	456	457
460	461	462	463	464	465	466	467
470	471	472	473	474	475	476	477
500	501	502	503	504	505	506	507
510	511	512	513	514	515	516	517
520	521	522	523	524	525	526	527
530	531	532	533	534	535	536	537
540	541	542	543	544	545	546	547
550	551	552	553	554	555	556	557
560	561	562	563	564	565	566	567
570	571	572	573	574	575	576	577
600	601	602	603	604	605	606	607
610	611	612	613	614	615	616	617
620	621	622	623	624	625	626	627
630	631	632	633	634	635	636	637
640	641	642	643	644	645	646	647
650	651	652	653	654	655	656	657
660	661	662	663	664	665	666	667
670	671	672	673	674	675	676	677
700	701	702	703	704	705	706	707
710	711	712	713	714	715	716	717

720	721	722	723	724	725	726	727
730	731	732	733	734	735	736	737
740	741	742	743	744	745	746	747
750	751	752	753	754	755	756	757
760	761	762	763	764	765	766	767
770	771	772	773	774	775	776	777

*We only do best radio!*

Qixiang Electron Science & Technology Co., Ltd.

[www.qxdz.cn](http://www.qxdz.cn)

## SAFETY TRAINING INFORMATION



Your Qixiang Electron Science & Technology Co.,Ltd. radio generators RF electromagnetic energy during transmit mode. This radio is designed for and classified as "Occupational Use Only", meaning it must be used only during the course of employment by individuals aware of the hazards, and the ways to minimize such hazards. This radio is NOT intended for use by the "General Population" in an uncontrolled environment. This radio has been tested and complies with the FCC RF exposure limits for "Occupational Use Only". In addition, your Qixiang Electron Science & Technology Co.,Ltd. radio complies with the following Standards and Guidelines with regard to RF energy and electromagnetic energy levels and evaluation of such levels for exposure to humans:

- ◆ FCC OET Bulletin 65 Edition 97-01 Supplement C, Evaluating Compliance with FCC Guidelines for Human Exposure to Radio Frequency Electromagnetic Fields.
- ◆ American National Standards Institute (C95.1-1992), IEEE Standard for Safety Levels with Respect to Human Exposure to Radio Frequency Electromagnetic Fields, 3 kHz to 300 GHz.
- ◆ American National Standards Institute (C95.3-1992), IEEE Recommended Practice for the Measurement of Potentially Hazardous Electromagnetic Fields— RF and Microwave.
- ◆ The following accessories are authorized for use with this product. Use of accessories other than those (listed in the instruction) specified may result in RF exposure levels exceed the FCC requirements for wireless RF exposure.



To ensure you're your exposure to RF electromagnetic energy is within the FCC allowable limits for occupational use, always adhere to the following guidelines

The information listed above provides the user with the information needed to make him or her aware of RF exposure, and what to do to assure that this radio operates with the FCC RF exposure limits of this radio.

### Electromagnetic Interference/Compatibility

During transmissions, Qixiang Electron Science & Technology Co.,Ltd. radio generates RF energy that can possibly cause interference with other devices or systems. To avoid such interference, turn off the radio in areas where signs are posted to do so. **DO NOT** operate the transmitter in areas that are sensitive to electromagnetic radiation such as hospitals, aircraft, and blasting sites.

### Occupational/Controlled Use

The radio transmitter is used in situations in which persons are exposed as consequence of their employment provided those persons are fully aware of the potential for exposure and can exercise control over their exposure.

In order to comply with RF exposure requirements, a minimum distance of 51.6 cm must be maintained between the antenna and all persons