

SAR EVALUATION REPORT

For

Qixiang Electron Science & Technology Co., Ltd.

Qixiang Building, Tangxi Industrial Zone, Luojiang District, Quanzhou, Fujian, China

FCC ID: T4K3208UV

Report Type: Original report	Product Type: Two way radio
Test Engineer: Wilson Chen	<i>Wilson Chen</i>
Report Number: RSZ140723004-20M1	
Report Date: 2014-08-13	
Reviewed By: SAR Engineer	<i>Bell Hu</i>
Prepared By: Bay Area Compliance Laboratories Corp. (Shenzhen) 6/F, the 3rd Phase of WanLi Industrial Building, ShiHua Road, FuTian Free Trade Zone Shenzhen, Guangdong, China Tel: +86-755-33320018 Fax: +86-755-33320008 www.baclcorp.com.cn	

Note: This test report is prepared for the customer shown above and for the device described herein. It may not be duplicated or used in part without prior written consent from Bay Area Compliance Laboratories Corp.

Attestation of Test Results				
EUT Information	Company Name	Qixiang Electron Science & Technology Co., Ltd.		
	EUT Description	Two way radio		
	FCC ID	T4K3208UV		
	Model Number	518UV, 3208UV, 298UV, 938UV, 318UV, 518UVII, 3208UVII		
	Test Date	2014-07-26		
Modulation	Frequency (MHz)	Max. SAR Level(s) Reported (1g)		Limit (W/Kg)
Analog	136-174	12.5kHz	Face up: 0.115 W/kg (50% duty cycle) Body-Back: 0.378 W/kg (50% duty cycle)	8.0
Applicable Standards	ANSI / IEEE C95.1: 2005 IEEE Standard for Safety Levels with Respect to Human Exposure to Radio Frequency Electromagnetic Fields, 3 kHz to 300 GHz.			
	ANSI / IEEE C95.3: 2002 IEEE Recommended Practice for Measurements and Computations of Radio Frequency Electromagnetic Fields With Respect to Human Exposure to Such Fields, 100 kHz—300 GHz.			
	IEEE 1528:2013 IEEE Recommended Practice for Determining the Peak Spatial-Average Specific Absorption Rate (SAR) in the Human Head from Wireless Communications Devices: Measurement Techniques			
	KDB procedures KDB 447498 D01 v05r02: Mobile and Portable Devices RF Exposure Procedures and Equipment Authorization Policies. KDB 865664 D01v01r03: SAR measurement 100 MHz to 6 GHz v01. KDB 643646D01 v01r01: SAR test Reduction Considerations for Occupational PTT Radios. KDB Inquiry: Tracking Number 316436 for SAR VHF system validation.			
<p>Note: This wireless device has been shown to be capable of compliance for localized specific absorption rate SAR for Occupational /Controlled Exposure Environment limits specified in ANSI/IEEE Standards and has been tested in accordance with the measurement procedures specified in IEEE 1528-2013 and RF exposure KDB procedures.</p> <p>The results and statements contained in this report pertain only to the device(s) evaluated.</p>				

TABLE OF CONTENTS

DOCUMENT REVISION HISTORY	5
EUT DESCRIPTION	6
TECHNICAL SPECIFICATION	6
REFERENCE, STANDARDS, AND GUIDELINES	7
SAR LIMITS	8
FACILITIES.....	9
DESCRIPTION OF TEST SYSTEM	10
EQUIPMENT LIST AND CALIBRATION	17
EQUIPMENTS LIST & CALIBRATION INFORMATION	17
SAR MEASUREMENT SYSTEM VERIFICATION	18
LIQUID VERIFICATION	18
SYSTEM ACCURACY VERIFICATION	20
SAR SYSTEM VALIDATION DATA	21
EUT TEST STRATEGY AND METHODOLOGY	25
TEST POSITIONS FOR DEVICE OPERATING NEXT TO A PERSON’S EAR.....	25
CHEEK/TOUCH POSITION	26
EAR/TILT POSITION	26
TEST POSITIONS FOR BODY-WORN AND OTHER CONFIGURATIONS	27
SAR EVALUATION PROCEDURE.....	28
TEST METHODOLOGY	28
CONDUCTED OUTPUT POWER MEASUREMENT	29
PROVISION APPLICABLE	29
TEST PROCEDURE	29
MAXIMUM OUTPUT POWER AMONG PRODUCTION UNITS	29
TEST RESULTS:	29
SAR MEASUREMENT RESULTS.....	30
SAR TEST DATA.....	30
TEST RESULT:.....	30
SAR PLOTS (SUMMARY OF THE HIGHEST SAR VALUES)	31
APPENDIX A – MEASUREMENT UNCERTAINTY	33
APPENDIX B – PROBE CALIBRATION CERTIFICATES.....	34
APPENDIX C – DIPOLE CALIBRATION CERTIFICATES.....	45
APPENDIX D – EUT TEST POSITION PHOTOS	53
LIQUID DEPTH ≥ 15CM	53
FACE-UP 2.5 CM SEPARATION TO FLAT PHANTOM SETUP PHOTO.....	53
BODY-BACK 0.0 CM SEPARATION TO FLAT PHANTOM SETUP PHOTO (BELT)	54
APPENDIX E – EUT PHOTOS.....	55
EUT – FRONT VIEW.....	55
EUT – BACK VIEW	55
EUT – LEFT VIEW	56
EUT – RIGHT VIEW	56
EUT – TOP VIEW.....	57
EUT – BOTTOM VIEW.....	57
EUT – UNCOVERED VIEW	58
EUT – ANTENNA VIEW.....	58
EUT –BELT CLIP VIEW.....	59

EUT –BATTERY VIEW59

APPENDIX F – INFORMATIVE REFERENCES60

PRODUCT SIMILARITY DECLARATION LETTER.....61

DOCUMENT REVISION HISTORY

Revision Number	Report Number	Description of Revision	Date of Revision
0	RSZ140723004-20	Original Report	2014-7-28
1	RSZ140723004-20M1	Mended Reprot	2014-08-13

EUT DESCRIPTION

This report has been prepared on behalf of Xiamen Puxing Electronics Science&Technology Co., Ltd and their product, FCC ID: T4K3208UV, Model: 518UV or the EUT(Equipment Under Test) as referred to in the rest of this report.

***Note:** This series products model: 518UV, 3208UV, 298UV, 938UV, 318UV, 518UVII and 3208UVII, we select model: 518UV to test, there is no electrical change has been made to the equipment, please refer to the product similarity letter.

Technical Specification

Product Type	Portable
Exposure Category:	Occupational/Controlled Exposure
Antenna Type(s):	External Antenna
Body-Worn Accessories:	Belt Clip and Headset Cable
Face-Head Accessories:	None
Modulation Type:	FM
Frequency Band:	136MHz-174MHz
Conducted RF Power:	36.82dBm
Dimensions (L*W*H):	138mm (L) × 61mm (W) × 36mm (H)
Power Source:	7.4V Rechargeable Li-ION Battery
Normal Operation:	Face Up and Body-worn

REFERENCE, STANDARDS, AND GUIDELINES

FCC:

The Report and Order requires routine SAR evaluation prior to equipment authorization of portable transmitter devices, including portable telephones. For consumer products, the applicable limit is 1.6 mW/g as recommended by the ANSI/IEEE standard C95.1-1992 [6] for an uncontrolled environment (Paragraph 65). According to 447498 D03 Supplement C Cross-Reference v01 "Evaluating Compliance with FCC Guide-lines for Human Exposure to Radio frequency Electromagnetic Fields", released on Jun 29, 2001 by the FCC, the device should be evaluated at maximum output power (radiated from the antenna) under "worst-case" conditions for normal or intended use, incorporating normal antenna operating positions, device peak performance frequencies and positions for maximum RF energy coupling.

This report describes the methodology and results of experiments performed on wireless data terminal. The objective was to determine if there is RF radiation and if radiation is found, what is the extent of radiation with respect to safety limits. SAR (Specific Absorption Rate) is the measure of RF exposure determined by the amount of RF energy absorbed by human body (or its parts) – to determine how the RF energy couples to the body or head which is a primary health concern for body worn devices. The limit below which the exposure to RF is considered safe by regulatory bodies in North America is 1.6 mW/g average over 1 gram of tissue mass.

CE:

The order requires routine SAR evaluation prior to equipment authorization of portable transmitter devices, including portable telephones. For consumer products, the applicable limit is 2 mW/g as recommended by EN62209-1 for an uncontrolled environment. According to the Standard, the device should be evaluated at maximum output power (radiated from the antenna) under "worst-case" conditions for normal or intended use, incorporating normal antenna operating positions, device peak performance frequencies and positions for maximum RF energy coupling.

This report describes the methodology and results of experiments performed on wireless data terminal. The objective was to determine if there is RF radiation and if radiation is found, what is the extent of radiation with respect to safety limits. SAR (Specific Absorption Rate) is the measure of RF exposure determined by the amount of RF energy absorbed by human body (or its parts) – to determine how the RF energy couples to the body or head which is a primary health concern for body worn devices. The limit below which the exposure to RF is considered safe by regulatory bodies in Europe is 2 mW/g average over 10 gram of tissue mass.

The test configurations were laid out on a specially designed test fixture to ensure the reproducibility of measurements. Each configuration was scanned for SAR. Analysis of each scan was carried out to characterize the above effects in the device.

SAR Limits

FCC Limit (1g Tissue)

EXPOSURE LIMITS	SAR (W/kg)	
	(General Population / Uncontrolled Exposure Environment)	(Occupational / Controlled Exposure Environment)
Spatial Average (averaged over the whole body)	0.08	0.4
Spatial Peak (averaged over any 1 g of tissue)	1.60	8.0
Spatial Peak (hands/wrists/feet/ankles averaged over 10 g)	4.0	20.0

CE Limit (10g Tissue)

EXPOSURE LIMITS	SAR (W/kg)	
	(General Population / Uncontrolled Exposure Environment)	(Occupational / Controlled Exposure Environment)
Spatial Average (averaged over the whole body)	0.08	0.4
Spatial Peak (averaged over any 10 g of tissue)	2.0	10
Spatial Peak (hands/wrists/feet/ankles averaged over 10 g)	4.0	20.0

Population/Uncontrolled Environments are defined as locations where there is the exposure of individual who have no knowledge or control of their exposure.

Occupational/Controlled Environments are defined as locations where there is exposure that may be incurred by people who are aware of the potential for exposure (i.e. as a result of employment or occupation).

Occupational/Controlled environments Spatial Peak limit 8.0W/kg (FCC/IC) & 10 W/kg (CE) applied to the EUT.

FACILITIES

The test site used by Bay Area Compliance Laboratories Corp. (Shenzhen) to collect data is located at 6/F, the 3rd Phase of WanLi Industrial Building, Shi Hua Road, Fu Tian Free Trade Zone, Shenzhen, Guangdong, P.R. of China

DESCRIPTION OF TEST SYSTEM

These measurements were performed with ALSAS 10 Universal Integrated SAR Measurement system from APREL Laboratories.

ALSAS-10U System Description

ALSAS-10-U is fully compliant with the technical and scientific requirements of IEEE 1528, IEC 62209, CENELEC, ARIB, ACA, and the Federal Communications Commission. The system comprises of a six axes articulated robot which utilizes a dedicated controller. ALSAS-10U uses the latest methodologies. And FDTD modeling to provide a platform which is repeatable with minimum uncertainty.

Applications

Predefined measurement procedures compliant with the guidelines of CENELEC, IEEE, IEC, FCC, etc are utilized during the assessment for the device. Automatic detection for all SAR maxima are embedded within the core architecture for the system, ensuring that peak locations used for centering the zoom scan are within a 1mm resolution and a 0.05mm repeatable position. System operation range currently available up-to 6 GHz in simulated tissue.

Area Scans

Area scans are defined prior to the measurement process being executed with a user defined variable spacing between each measurement point (integral) allowing low uncertainty measurements to be conducted. Scans defined for FCC applications utilize a 10mm² step integral, with 1mm interpolation used to locate the peak SAR area used for zoom scan assessments.

Where the system identifies multiple SAR peaks (which are within 25% of peak value) the system will provide the user with the option of assessing each peak location individually for zoom scan averaging.

Zoom Scan (Cube Scan Averaging)

The averaging zoom scan volume utilized in the ALSAS-10U software is in the shape of a cube and the side dimension of a 1 g or 10 g mass is dependent on the density of the liquid representing the simulated tissue. A density of 1000 kg/m³ is used to represent the head and body tissue density and not the phantom liquid density, in order to be consistent with the definition of the liquid dielectric properties, i.e. the side length of the 1 g cube is 10mm, with the side length of the 10 g cube 21,5mm.

When the cube intersects with the surface of the phantom, it is oriented so that 3 vertices touch the surface of the shell or the center of a face is tangent to the surface. The face of the cube closest to the surface is modified in order to conform to the tangent surface.

The zoom scan integer steps can be user defined so as to reduce uncertainty, but normal practice for typical test applications (including FCC) utilize a physical step of 5x5x8 (8mmx8mmx5mm) providing a volume of 32mm³ in the X & Y axis, and 35mm in the Z axis.



ALSAS-10U Interpolation and Extrapolation Uncertainty

The overall uncertainty for the methodology and algorithms the used during the SAR calculation was evaluated using the data from IEEE 1528 based on the example f3 algorithm:

$$f_3(x, y, z) = A \frac{a^2}{\frac{a^2}{4} + x'^2 + y'^2} \cdot \left(e^{-\frac{2z}{a}} + \frac{a^2}{2(a + 2z)^2} \right)$$

Isotropic E-Field Probe

The isotropic E-Field probe has been fully calibrated and assessed for isotropicity, and boundary effect within a controlled environment. Depending on the frequency for which the probe is calibrated the method utilized for calibration will change.

The E-Field probe utilizes a triangular sensor arrangement as detailed in the diagram below:

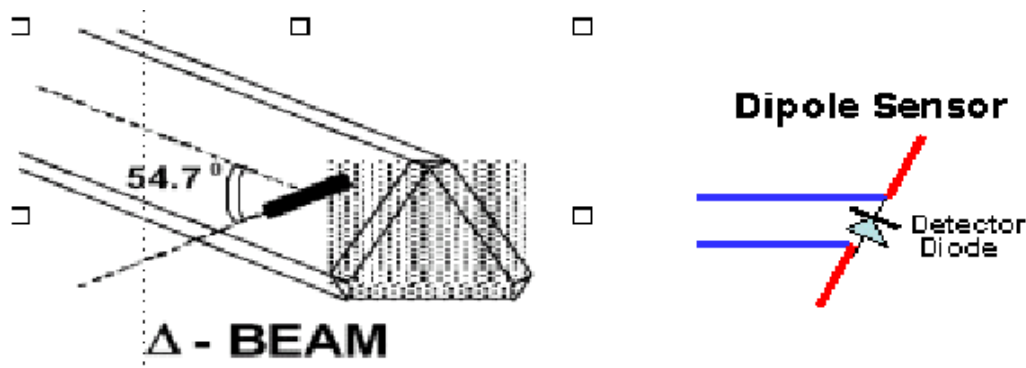

SAR is assessed with a calibrated probe which moves at a default height of 5mm from the center of the diode, which is mounted to the sensor, to the phantom surface (in the Z Axis). The 5mm offset height has been selected so as to minimize any resultant boundary effect due to the probe being in close proximity to the phantom surface.

The following algorithm is an example of the function used by the system for linearization of the output from the probe when measuring complex modulation schemes.

$$V_i = U_i + U_i^2 \cdot \frac{cf}{dcp_i}$$

Isotropic E-Field Probe Specification

Calibration Method	Frequency Dependent Below 1 GHz Calibration in air performed in a TEM Cell Above 1 GHz Calibration in air performed in waveguide
Sensitivity	0.70 $\mu\text{V}/(\text{V}/\text{m})^2$ to 0.85 $\mu\text{V}/(\text{V}/\text{m})^2$
Dynamic Range	0.0005 W/kg to 100 W/kg
Isotropic Response	Better than 0.1 dB
Diode Compression Point (DCP)	Calibration for Specific Frequency
Probe Tip Diameter	< 2.9 mm
Sensor Offset	1.56 (+/- 0.02 mm)
Probe Length	289 mm
Video Bandwidth	@ 500 Hz: 1 dB @ 1.02 kHz: 3 dB
Boundary Effect	Less than 2.1% for distance greater than 0.58 mm
Spatial Resolution	The spatial resolution uncertainty is less than 1.5% for 4.9mm diameter probe. The spatial resolution uncertainty is less than 1.0% for 2.5mm diameter probe

Boundary Detection Unit and Probe Mounting Device

ALSAS-10U incorporates a boundary detection unit with a sensitivity of 0.05mm for detecting all types of surfaces. The robust design allows for detection during probe tilt (probe normalize) exercises, and utilizes a second stage emergency stop. The signal electronics are fed directly into the robot controller for high accuracy surface detection in lateral and axial detection modes (X, Y, & Z).

The probe is mounted directly onto the Boundary Detection unit for accurate tooling and displacement calculations controlled by the robot kinematics. The probe is connect to an isolated probe interconnect where the output stage of the probe is fed directly into the amplifier stage of the Daq-Paq.

Daq-Paq (Analog to Digital Electronics)

ALSAS-10U incorporates a fully calibrated Daq-Paq (analog to digital conversion system) which has a 4 channel input stage, sent via a 2 stage auto-set amplifier module. The input signal is amplified accordingly so as to offer a dynamic range from 5 μV to 800mV. Integration of the fields measured is carried out at board level utilizing a Co-Processor which then sends the measured fields down into the main computational module in digitized form via an RS232 communications port. Probe linearity and duty cycle compensation is carried out within the main Daq-Paq module.

ADC	12 Bit
Amplifier Range	20 mV to 200 mV and 150 mV to 800 mV
Field Integration	Local Co-Processor utilizing proprietary integration algorithms
Number of Input Channels	4 in total 3 dedicated and 1 spare
Communication	Packet data via RS232

Axis Articulated Robot

ALSAS-10U utilizes a six axis articulated robot, which is controlled using a Pentium based real-time movement controller. The movement kinematics engine utilizes proprietary (Thermo CRS) interpolation and extrapolation algorithms, which allow full freedom of movement for each of the six joints within the working envelope. Utilization of joint 6 allows for full probe rotation with a tolerance better than 0.05mm around the central axis.



Robot/Controller Manufacturer	Thermo CRS
Number of Axis	Six independently controlled axis
Positioning Repeatability	0.05 mm
Controller Type	Single phase Pentium based C500C
Robot Reach	710 mm
Communication	RS232 and LAN compatible

ALSAS Universal Workstation

ALSAS Universal workstation allows for repeatability and fast adaptability. It allows users to do calibration, testing and measurements using different types of phantoms with one set up, which significantly speeds up the measurement process.

Universal Device Positioner

The universal device positioner allows complete freedom of movement of the EUT. Developed to hold a EUT in a free-space scenario any additional loading attributable to the material used in the construction of the positioner has been eliminated. Repeatability has been enhanced through the linear scales which form the design used to indicate positioning for any given test scenario in all major axes. A 15° tilt indicator is included for the of aid cheek to tilt movements for head SAR analysis. Overall uncertainty for measurements have been reduced due to the design of the Universal device positioner, which allows positioning of a device in as near to a free-space scenario as possible, and by providing the means for complete repeatability.



Phantom Types

The ALSAS-10U allows the integration of multiple phantom types. SAM Phantoms fully compliant with IEEE 1528, Universal Phantom, and Universal Flat.

APREL SAM Phantoms

The SAM phantoms developed using the IEEE SAM CAD file. They are fully compliant with the requirements for both IEEE 1528 and FCC Supplement C. Both the left and right SAM phantoms are interchangeable, transparent and include the IEEE 1528 grid with visible NF and MB lines.

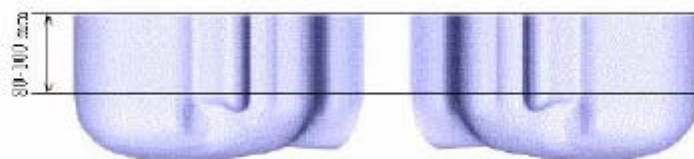

APREL Laboratories Universal Phantom

The Universal Phantom is used on the ALSAS-10U as a system validation phantom. The Universal Phantom has been fully validated both experimentally from 30MHz to 6GHz and numerically using XFDTD numerical software.

The shell thickness is 2mm overall, with a 4mm spacer located at the NF/MB intersection providing an overall thickness of 6mm in line with the requirements of IEEE-1528.

The design allows for fast and accurate measurements, of handsets, by allowing the conservative SAR to be evaluated at on frequency for both left and right head experiments in one measurement.



Tissue Dielectric Parameters for Head and Body Phantoms

The head tissue dielectric parameters recommended by the IEEE SCC-34/SC-2 in P1528 have been incorporated in the following table. These head parameters are derived from planar layer models simulating the highest expected SAR for the dielectric properties and tissue thickness variations in a human head. Other head and body tissue parameters that have not been specified in P1528 are derived from the tissue dielectric parameters computed from the 4-Cole-Cole equations described in Reference [12] and extrapolated according to the head parameters specified in P1528.

Ingredients (% by weight)	Frequency (MHz)									
	450		835		915		1900		2450	
Tissue Type	Head	Body	Head	Body	Head	Body	Head	Body	Head	Body
Water	38.56	51.16	41.45	52.4	41.05	56.0	54.9	40.4	62.7	73.2
Salt (Nacl)	3.95	1.49	1.45	1.4	1.35	0.76	0.18	0.5	0.5	0.04
Sugar	56.32	46.78	56.0	45.0	56.5	41.76	0.0	58.0	0.0	0.0
HEC	0.98	0.52	1.0	1.0	1.0	1.21	0.0	1.0	0.0	0.0
Bactericide	0.19	0.05	0.1	0.1	0.1	0.27	0.0	0.1	0.0	0.0
Triton x-100	0.0	0.0	0.0	0.0	0.0	0.0	0.0	0.0	36.8	0.0
DGBE	0.0	0.0	0.0	0.0	0.0	0.0	44.92	0.0	0.0	26.7
Dielectric Constant	43.42	58.0	42.54	56.1	42.0	56.8	39.9	54.0	39.8	52.5
Conductivity (s/m)	0.85	0.83	0.91	0.95	1.0	1.07	1.42	1.45	1.88	1.78

Recommended Tissue Dielectric Parameters for Head and Body

Frequency (MHz)	Head Tissue		Body Tissue	
	ϵ_r	σ (S/m)	ϵ_r	σ (S/m)
150	52.3	0.76	61.9	0.80
300	45.3	0.87	58.2	0.92
450	43.5	0.87	56.7	0.94
835	41.5	0.90	55.2	0.97
900	41.5	0.97	55.0	1.05
915	41.5	0.98	55.0	1.06
1450	40.5	1.20	54.0	1.30
1610	40.3	1.29	53.8	1.40
1800-2000	40.0	1.40	53.3	1.52
2450	39.2	1.80	52.7	1.95
3000	38.5	2.40	52.0	2.73
5800	35.3	5.27	48.2	6.00

EQUIPMENT LIST AND CALIBRATION

Equipments List & Calibration Information

Equipment	Model	Calibration Date	S/N
CRS F3 robot	ALS-F3	N/A	RAF0805352
CRS F3 Software	ALS-F3-SW	N/A	N/A
CRS C500C controller	ALS-C500	N/A	RCF0805379
Probe mounting device & Boundary Detection Sensor System	ALS-PMDPS-3	N/A	120-00270
Universal Work Station	ALS-UWS	N/A	100-00157
Data Acquisition Package	ALS-DAQ-PAQ-3	2013-10-08	110-00212
Miniature E-Field Probe	E-020	2013-10-08	500-00283
Loop, 150 MHz	CLA150	2014-05-08	4004
Device holder/Positioner	ALS-H-E-SET-2	N/A	170-00510
Left ear SAM phantom	ALS-P-SAM-L	N/A	130-00311
Right ear SAM phantom	ALS-P-SAM-R	N/A	140-00359
UniPhantom	ALS-UM-FLAT	N/A	153-00104
Simulated Tissue 150 MHz Head	ALS-TS-150-H	Each Time	250-01302
Simulated Tissue 150 MHz Body	ALS-TS-150-B	Each Time	250-01304
Directional couple	DC6180A	2013-11-12	0325849
Attenuator	3dB	2014-05-08	5402
Network analyzer	8752C	2014-06-13	3410A02356
Dielectric probe kit	HP85070B	2014-06-13	N/A
Power Amplifier	5S1G4	N/A	71377
Synthesized Sweeper	HP 8341B	2014-05-08	2624A00116
EMI Test Receiver	ESCI	2013-11-12	101120

SAR MEASUREMENT SYSTEM VERIFICATION

Liquid Verification

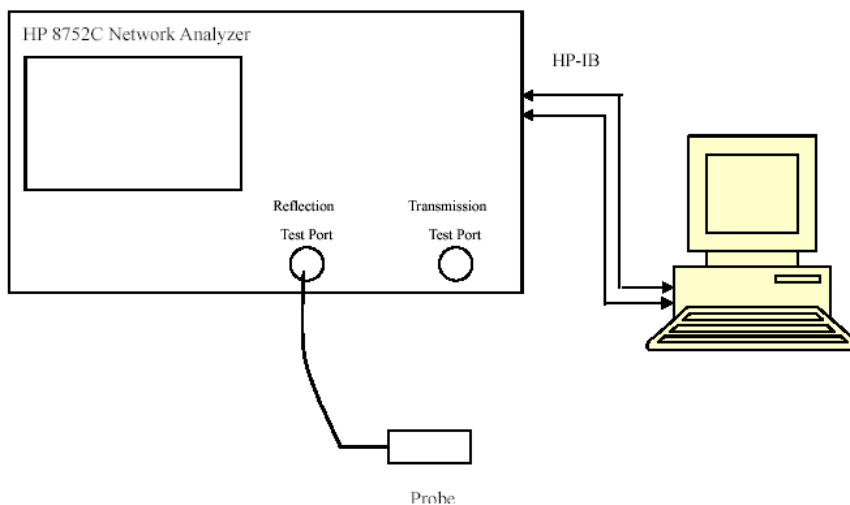

Liquid Verification Setup Block Diagram

Liquid Verification Results

Frequency (MHz)	Liquid Type	Liquid Parameter		Target Value		Delta (%)		Tolerance (%)
		ϵ_r	σ (S/m)	ϵ_r	σ (S/m)	$\Delta\epsilon_r$	$\Delta\sigma$ (S/m)	
136.025	Head	51.62	0.77	52.30	0.76	-1.300	1.316	±5
	Body	62.96	0.79	61.90	0.80	1.712	-1.250	±5
155.025	Head	50.45	0.78	52.30	0.76	-3.537	2.632	±5
	Body	60.20	0.80	61.90	0.80	-2.746	0.000	±5
173.975	Head	51.11	0.79	52.30	0.76	-2.275	3.947	±5
	Body	60.17	0.83	61.90	0.80	-2.795	3.750	±5

*Liquid Verification was performed on 2014-07-26

Please refer to the following tables.

150MHz Head			150MHz Body		
Frequency (MHz)	e'	e''	Frequency (MHz)	e'	e''
136.00	51.6200	101.1896	136.00	62.9619	105.1202
136.76	51.8183	100.1426	136.76	60.8984	105.4739
137.52	51.7622	100.0946	137.52	61.4407	104.8474
138.28	51.9940	99.2941	138.28	62.7089	104.7491
139.04	51.5388	99.0040	139.04	61.0595	104.2013
139.80	51.2541	98.9205	139.80	62.0049	103.7203
140.56	51.2793	98.1653	140.56	62.0828	102.3146
141.32	51.3808	97.1746	141.32	61.9404	102.1296
142.08	51.0527	97.4980	142.08	63.0501	102.3457
142.84	51.2019	97.0350	142.84	62.5258	101.6825
143.60	50.9603	96.4654	143.60	62.9333	101.3070
144.36	50.9775	96.0877	144.36	61.2956	100.1808
145.12	50.6309	95.6113	145.12	62.4787	100.3824
145.88	50.5849	95.6821	145.88	62.8994	99.7671
146.64	50.6448	95.1130	146.64	60.9484	99.7142
147.40	50.6235	94.6983	147.40	62.8449	98.6250
148.16	50.5959	94.2430	148.16	62.5246	98.7167
148.92	50.5195	93.6106	148.92	60.5710	97.9550
149.68	50.5763	93.4602	149.68	61.9495	97.4827
150.44	50.6751	92.2404	150.44	60.4015	97.2660
151.20	50.4848	92.2842	151.20	60.7357	95.0947
151.96	50.5189	91.4905	151.96	61.9218	95.6758
152.72	50.4854	91.3958	152.72	61.2488	96.0908
153.48	50.4884	92.1404	153.48	60.3724	95.1232
154.24	50.5643	91.0141	154.24	61.2419	94.8251
155.00	50.4471	89.9364	155.00	60.2014	92.6432
155.76	50.2486	89.7989	155.76	61.0305	93.1003
156.52	50.1974	90.7449	156.52	60.9200	92.9479
157.28	49.8462	88.9776	157.28	60.5691	92.3066
158.04	50.3646	89.5086	158.04	61.2735	92.8201
158.80	50.3716	88.7314	158.80	61.1073	92.9816
159.56	50.3535	87.4230	159.56	60.5368	92.1048
160.32	50.3783	87.2182	160.32	62.2495	90.9714
161.08	50.5894	87.4078	161.08	62.1768	90.4927
161.84	50.6606	87.6514	161.84	60.0221	90.4043
162.60	50.6826	87.2372	162.60	62.0785	88.4992
163.36	51.0194	86.0569	163.36	60.1298	90.1542
164.12	50.5736	86.6650	164.12	61.7327	90.5934
164.88	50.6295	86.4645	164.88	60.4419	89.3877
165.64	50.7637	86.1387	165.64	59.8969	88.7700
166.40	50.5533	84.4042	166.40	62.3166	88.6277
167.16	50.3849	84.3540	167.16	61.9896	87.8502
167.92	50.4123	85.0113	167.92	62.6495	87.8690
168.68	50.4025	84.8207	168.68	60.9410	87.2399
169.44	50.7864	83.6816	169.44	60.6863	88.1549
170.20	50.9871	84.1401	170.20	60.3002	88.1731
170.96	50.6624	83.5464	170.96	60.5521	87.3761
171.72	50.9007	82.7272	171.72	61.2907	85.7124
172.48	50.7210	82.8308	172.48	61.7956	85.9157
173.24	51.0654	82.0134	173.24	60.2967	84.6913
174.00	51.1125	82.1471	174.00	60.1726	85.6475

System Accuracy Verification

Prior to the assessment, the system validation kit was used to test whether the system was operating within its specifications of $\pm 10\%$. The validation results are tabulated below. And also the corresponding SAR plot is attached as well in the SAR plots files.

System Verification Setup Block Diagram

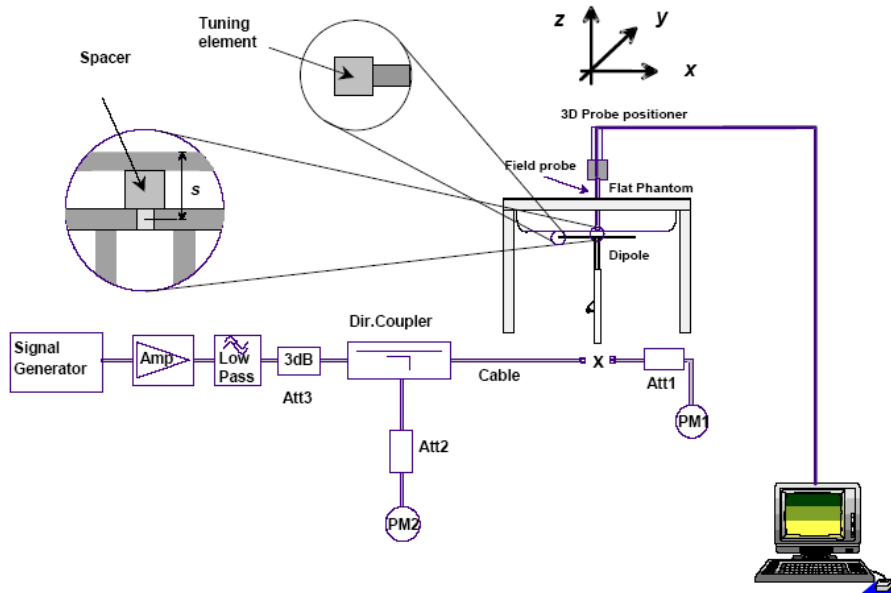

Probe and dipole antenna List and Detail

Manufacturer	Description	Model	Serial Number	Calibration Date	Calibration Due Date
APREL	Probe	ALS-E-020	500-00283	2013-10-08	2014-10-07
Speag	Loop antenna(150MHz)	CLA150	4004	2014-05-08	2017-05-07

System Accuracy Check Results

Date	Frequency (MHz)	Liquid Type	Measured SAR (W/Kg)	Target Value (W/Kg)	Delta (%)	Tolerance (%)	
2014-07-26	150	Head	1g	3.587	3.750	-4.347	± 10
		Body	1g	3.694	3.810	-3.045	± 10

*All SAR values are normalized to 1 Watt forward power.

SAR SYSTEM VALIDATION DATA**Test Laboratory: Bay Area Compliance Lab Corp. (Shenzhen)****System Performance Check 150 MHz Head Liquid****Loop150 MHz; Type: CLA150; S/N:4004**

Product Data

Device Name : Loop 150 MHz
Serial No. : 4004
Type : Loop
Model : CLA150
Frequency Band : 150
Max. Transmit Pwr : 1 W
Drift Time : 3 min(s)
Power Drift-Start : 3.258 W/kg
Power Drift-Finish : 3.235 W/kg
Power Drift (%) : -0.754

Phantom Data

Name : APREL-Uni
Type : Uni-Phantom
Serial No. : System Default
Location : Center
Description : Default
Phantom Data

Tissue Data

Type : Head
Serial No. : 250-01302
Frequency : 150.00MHz
Last Calib. Date : 26-Jul-2014
Temperature : 20.00 °C
Ambient Temp. : 21.00 °C
Humidity : 56.00 RH%
Epsilon : 50.22 F/m
Sigma : 0.78 S/m
Density : 1000.00 kg/cu. m

Probe Data

Name : E-Field
Model : E-020
Type : E-Field Triangle
Serial No. : 500-00283
Last Calib. Date : 08-Oct-2013
Frequency Band : 150
Duty Cycle Factor : 1
Conversion Factor : 6.0
Probe Sensitivity : 1.20 1.20 1.20 $\mu\text{V}/(\text{V}/\text{m})^2$
Compression Point : 95.00 mV
Offset : 1.56 mm

Measurement Data

Crest Factor : 1
Scan Type : Complete
Tissue Temp. : 21.00 °C
Ambient Temp. : 21.00 °C
Area Scan : 8x10x1 : Measurement x=10mm, y=10mm, z=4mm
Zoom Scan : 7x7x7 : Measurement x=5mm, y=5mm, z=5mm

1 gram SAR value : 3.587 W/kg
10 gram SAR value : 2.502 W/kg
Area Scan Peak SAR : 3.859 W/kg
Zoom Scan Peak SAR : 5.991 W/kg

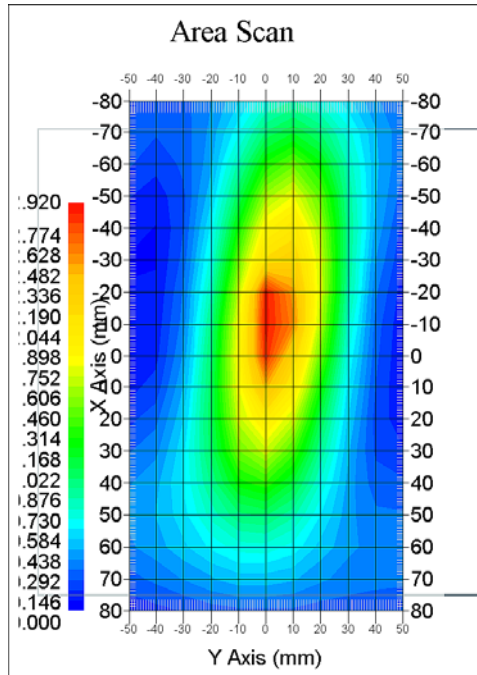

150 MHz System Validation with Head Tissue

Test Laboratory: Bay Area Compliance Lab Corp. (Shenzhen)**System Performance Check 150 MHz Body Liquid****Loop 150 MHz; Type: CLA150; S/N: 4004**

Product Data

Device Name : Loop 150 MHz
Serial No. : 4004
Type : Loop
Model : CAL150
Frequency Band : 150
Max. Transmit Pwr : 1 W
Drift Time : 3 min(s)
Power Drift-Start : 2.933 W/kg
Power Drift-Finish : 3.002 W/kg
Power Drift (%) : 3.428

Phantom Data

Name : APREL-Uni
Type : Uni-Phantom
Serial No. : System Default
Location : Center
Description : Default
Phantom Data

Tissue Data

Type : Body
Serial No. : 250-01304
Frequency : 150.00MHz
Last Calib. Date : 26-Jul-2014
Temperature : 20.00 °C
Ambient Temp. : 21.00 °C
Humidity : 56.00 RH%
Epsilon : 60.97 F/m
Sigma : 0.81 S/m
Density : 1000.00 kg/cu. m

Probe Data

Name : E-Field
Model : E-020
Type : E-Field Triangle
Serial No. : 500-00283
Last Calib. Date : 08-Oct-2013
Frequency Band : 150
Duty Cycle Factor : 1
Conversion Factor : 6.0
Probe Sensitivity : 1.20 1.20 1.20 $\mu\text{V}/(\text{V}/\text{m})^2$
Compression Point : 95.00 mV
Offset : 1.56 mm

Measurement Data

Crest Factor : 1
Scan Type : Complete
Tissue Temp. : 21.00 °C
Ambient Temp. : 21.00 °C
Area Scan : 8x10x1 : Measurement x=10mm, y=10mm, z=4mm
Zoom Scan : 7x7x7 : Measurement x=5mm, y=5mm, z=5mm

1 gram SAR value : 3.694 W/kg
10 gram SAR value : 2.660 W/kg
Area Scan Peak SAR : 3.837 W/kg
Zoom Scan Peak SAR : 6.016 W/kg

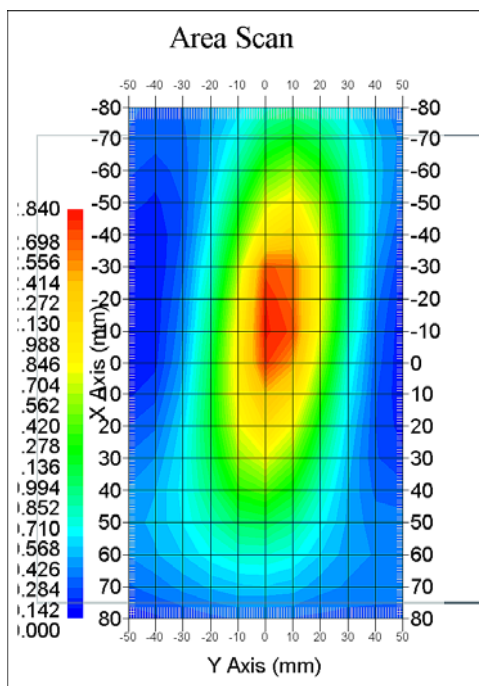

150 MHz System Validation with Body Tissue

EUT TEST STRATEGY AND METHODOLOGY

Test Positions for Device Operating Next to a Person’s Ear

This category includes most wireless handsets with fixed, retractable or internal antennas located toward the top half of the device, with or without a foldout, sliding or similar keypad cover. The handset should have its earpiece located within the upper ¼ of the device, either along the centerline or off-centered, as perceived by its users. This type of handset should be positioned in a normal operating position with the “test device reference point” located along the “vertical centerline” on the front of the device aligned to the “ear reference point”. The “test device reference point” should be located at the same level as the center of the earpiece region. The “vertical centerline” should bisect the front surface of the handset at its top and bottom edges. A “ear reference point” is located on the outer surface of the head phantom on each ear spacer. It is located 1.5 cm above the center of the ear canal entrance in the “phantom reference plane” defined by the three lines joining the center of each “ear reference point” (left and right) and the tip of the mouth.

A handset should be initially positioned with the earpiece region pressed against the ear spacer of a head phantom. For the SCC-34/SC-2 head phantom, the device should be positioned parallel to the “N-F” line defined along the base of the ear spacer that contains the “ear reference point”. For interim head phantoms, the device should be positioned parallel to the cheek for maximum RF energy coupling. The “test device reference point” is aligned to the “ear reference point” on the head phantom and the “vertical centerline” is aligned to the “phantom reference plane”. This is called the “initial ear position”. While maintaining these three alignments, the body of the handset is gradually adjusted to each of the following positions for evaluating SAR:

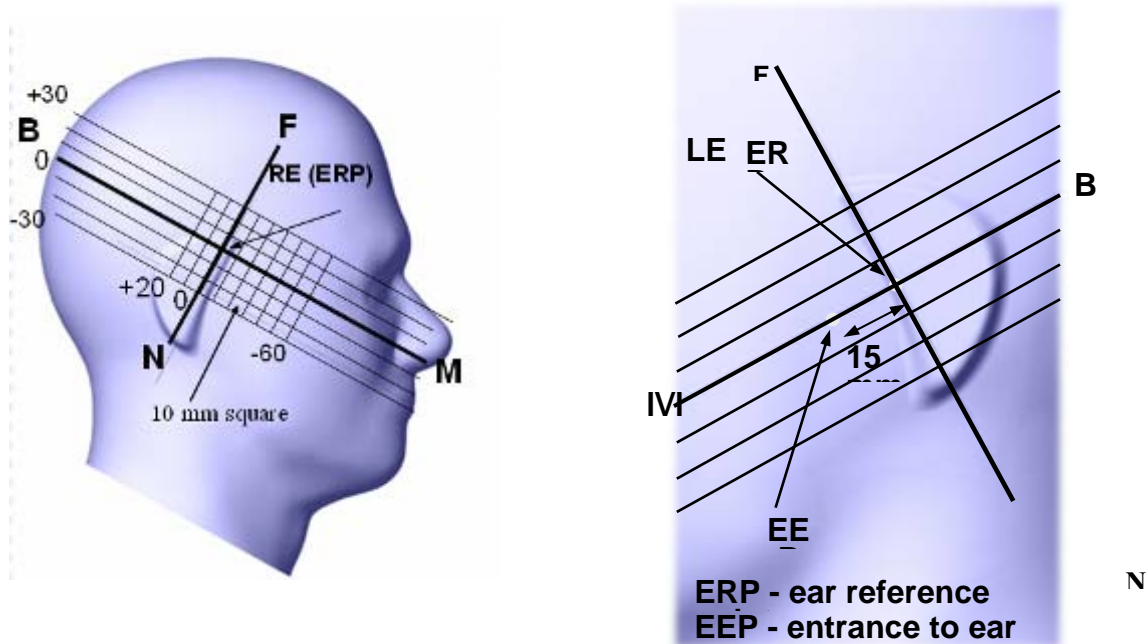

Cheek/Touch Position

The device is brought toward the mouth of the head phantom by pivoting against the “ear reference point” or along the “N-F” line for the SCC-34/SC-2 head phantom.

This test position is established:

- When any point on the display, keypad or mouthpiece portions of the handset is in contact with the phantom.
- (or) When any portion of a foldout, sliding or similar keypad cover opened to its intended self-adjusting normal use position is in contact with the cheek or mouth of the phantom.

For existing head phantoms – when the handset loses contact with the phantom at the pivoting point, rotation should continue until the device touches the cheek of the phantom or breaks its last contact from the ear spacer.

Cheek /Touch Position

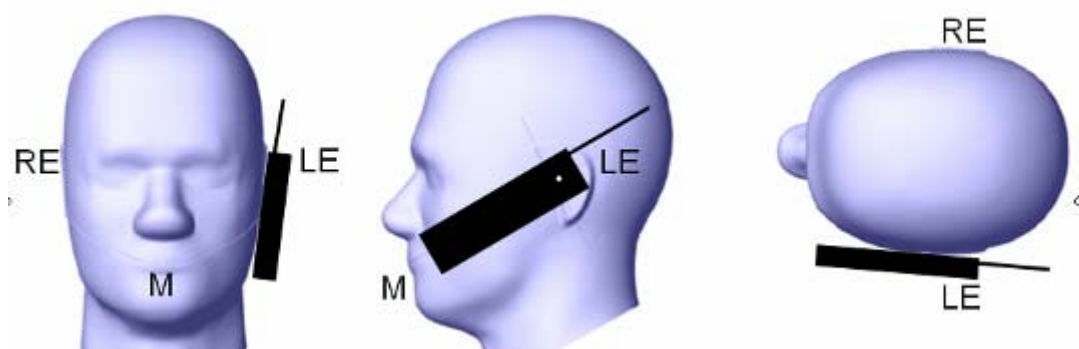

Ear/Tilt Position

With the handset aligned in the “Cheek/Touch Position”:

1) If the earpiece of the handset is not in full contact with the phantom’s ear spacer (in the “Cheek/Touch position”) and the peak SAR location for the “Cheek/Touch” position is located at the ear spacer region or corresponds to the earpiece region of the handset, the device should be returned to the “initial ear position” by rotating it away from the mouth until the earpiece is in full contact with the ear spacer.

2) (otherwise) The handset should be moved (translated) away from the cheek perpendicular to the line passes through both “ear reference points” (note: one of these ear reference points may not physically exist on a split head model) for approximate 2-3 cm. While it is in this position, the device handset is tilted away from the mouth with respect to the “test device reference point” until the inside angle between the vertical centerline on the front surface of the phone and the horizontal line passing through the ear reference point is by 15° to 80° . After the tilt, it is then moved (translated) back toward the head perpendicular to the line passes through both “ear reference points” until the device touches the phantom or the ear spacer. If the antenna touches the head first, the positioning process should be repeated with a tilt angle less than 15° so that the device and its antenna would touch the phantom simultaneously. This test position may require a device holder or positioner to achieve the translation and tilting with acceptable positioning repeatability.

If a device is also designed to transmit with its keypad cover closed for operating in the head position, such positions should also be considered in the SAR evaluation. The device should be tested on the left and right side of the head phantom in the “Cheek/Touch” and “Ear/Tilt” positions. When applicable, each configuration should be tested with the antenna in its fully extended and fully retracted positions. These test configurations should be tested at the high, middle and low frequency channels of each operating mode; for example, AMPS, CDMA, and TDMA. If the SAR measured at the middle channel for each test configuration (left, right, Cheek/Touch, Tile/Ear, extended and retracted) is at least 2.0 dB lower than the SAR limit, testing at the high and low channels is optional for such test configuration(s). If the transmission band of the test device is less than 10 MHz, testing at the high and low frequency channels is optional.

Ear /Tilt 15° Position

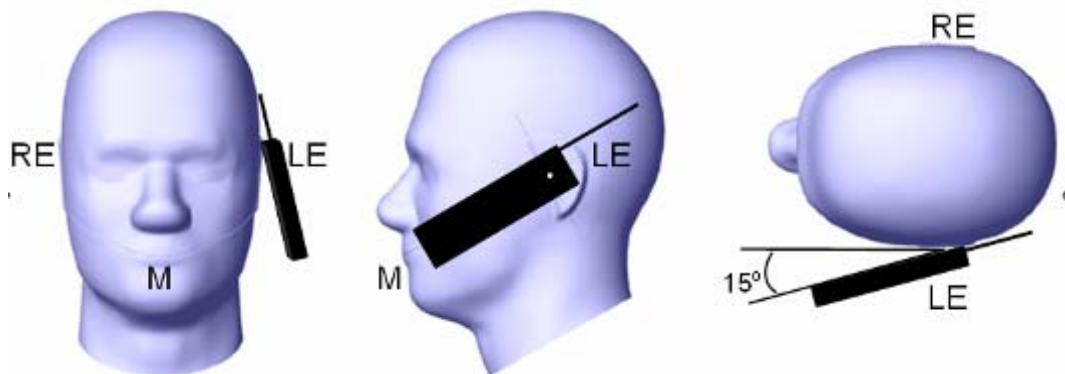

Test positions for body-worn and other configurations

Body-worn operating configurations should be tested with the belt-clips and holsters attached to the device and positioned against a flat phantom in normal use configurations. Devices with a headset output should be tested with a headset connected to the device. When multiple accessories that do not contain metallic components are supplied with the device, the device may be tested with only the accessory that dictates the closest spacing to the body. When multiple accessories that contain metallic components are supplied with the device, the device must be tested with each accessory that contains a unique metallic component. If multiple accessories share an identical metallic component (e.g., the same metallic belt-clip used with different holsters with no other metallic components), only the accessory that dictates the closest spacing to the body must be tested.

Body-worn accessories may not always be supplied or available as options for some devices that are intended to be authorized for body-worn use. A separation distance of 1.5 cm between the back of the device and a flat phantom is recommended for testing body-worn SAR compliance under such circumstances. Other separation distances may be used, but they should not exceed 2.5 cm. In these cases, the device may use body-worn accessories that provide a separation distance greater than that tested for the device provided however that the accessory contains no metallic components.

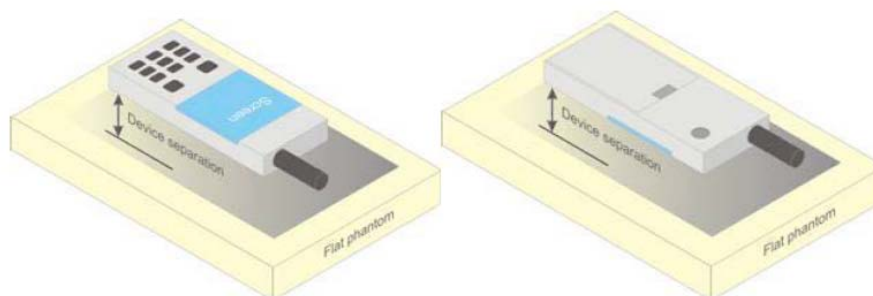

Figure 5 – Test positions for body-worn devices

SAR Evaluation Procedure

The evaluation was performed with the following procedure:

Step 1: Measurement of the SAR value at a fixed location above the ear point or central position was used as a reference value for assessing the power drop. The SAR at this point is measured at the start of the test and then again at the end of the testing.

Step 2: The SAR distribution at the exposed side of the head was measured at a distance of 4 mm from the inner surface of the shell. The area covered the entire dimension of the head or EUT and the horizontal grid spacing was 10 mm x 10 mm. Based on these data, the area of the maximum absorption was determined by spline interpolation. The first Area Scan covers the entire dimension of the EUT to ensure that the hotspot was correctly identified.

Step 3: Around this point, a volume of 35 mm x 35 mm x 35 mm was assessed by measuring 7x 7 x 7 points. On the basis of this data set, the spatial peak SAR value was evaluated under the following procedure:

- 1) The data at the surface were extrapolated, since the center of the dipoles is 1.2 mm away from the tip of the probe and the distance between the surface and the lowest measuring point is 1.3 mm. The extrapolation was based on a least square algorithm. A polynomial of the fourth order was calculated through the points in z-axes. This polynomial was then used to evaluate the points between the surface and the probe tip.
- 2) The maximum interpolated value was searched with a straightforward algorithm. Around this maximum the SAR values averaged over the spatial volumes (1 g or 10 g) were computed by the 3D-Spline interpolation algorithm. The 3D-Spline is composed of three one dimensional splines with the "Not a knot"-condition (in x, y and z-directions). The volume was integrated with the trapezoidal-algorithm. One thousand points (10 x 10 x 10) were interpolated to calculate the averages.

All neighboring volumes were evaluated until no neighboring volume with a higher average value was found.

Step 4: Re-measurement of the SAR value at the same location as in Step 1. If the value changed by more than 5%, the evaluation was repeated.

Test methodology

IEEE1528:2013

KDB 447498 D01 v05r02

KDB 865664 D01 v01r03

KDB 643646 D01 v01r01

KDB Inquiry: Tracking Number 316436

CONDUCTED OUTPUT POWER MEASUREMENT

Provision Applicable

The measured peak output power should be greater and within 5% than EMI measurement.

Test Procedure

The RF output of the transmitter was connected to the input of the Signal Analyzer through sufficient attenuation.

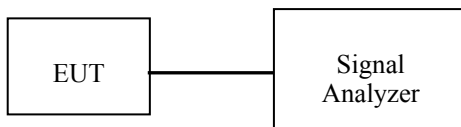

Maximum Output Power among production units

Max. tune-up tolerance power limit for Production Unit (dBm)			
PTT/Mode	Frequency		
	136.025	155.025	173.975
Analog-12.5K	37.00	37.00	37.00

Test Results:

Mode	Frequency Spacing (kHz)	Frequency (MHz)	Output(dBm)	Output Power(W)	Power level	Note
Analog	12.5	136.025	35.62	3.648	High	Not for FCC Review
		155.025	36.82	4.808	High	/
		173.975	36.26	4.227	High	Not for FCC Review

SAR MEASUREMENT RESULTS

This page summarizes the results of the performed dosimetric evaluation.

SAR Test Data

Environmental Conditions

Temperature:	21 °C
Relative Humidity:	50%
ATM Pressure:	1002 mbar

* Testing was performed by Wilson Chen on 2014-07-26

Test Result:

Analog (Modulation FM; Channel Spacing 12.5 kHz):

Frequency (MHz)	Body-Worn Accessory	Power Drift (%)	Max. Meas. Power (dBm)	Max. Rated Power (dBm)	1 g SAR Value(W/Kg)				
					Scaled Factor	Meas. SAR	Scaled SAR	50% duty cycle	Plot
Face up (2.5cm)									
155.025	/	2.105	36.82	37.00	1.042	0.221	0.230	0.115	1#
Body-Back (0.0cm)									
155.025	Belt Clip	-1.712	36.82	37.00	1.042	0.725	0.755	0.378	2#

Note:

1. When the 1-g SAR tested using the default battery and default accessories is $\leq 3.5W/Kg$ (corrected by Multiplying 50% for FM mode), testing for other channels are optional.
2. For a analog PTT, only simplex communication technology was supported, so the SAR value need to be corrected by Multiplying 50%.
3. Passive body-worn and audio accessories generally do not apply to the head SAR of PTT radios.
4. The whole antenna and radiating structures that may contribute to the measured SAR or influence the SAR distribution has been included in the area scan.

SAR Plots (Summary of the Highest SAR Values)

Test Laboratory: Bay Area Compliance Lab Corp. (Shenzhen)

Face-Up 2.5cm (Analog 12.5k-155.025MHz)

Measurement Data

Modulation mode : FM
 Crest Factor : 1
 Scan Type : Complete
 Area Scan : 15x8x1: Measurement x=10mm, y=10mm, z=4mm
 Zoom Scan : 7x7x7: Measurement x=5mm, y=5mm, z=5mm
 Power Drift-Start : 0.198 W/kg
 Power Drift-Finish : 0.202 W/kg
 Power Drift (%) : 2.105

Tissue Data

Type : Head
 Frequency : 155.025MHz
 Epsilon : 50.45 F/m
 Sigma : 0.78 S/m
 Density : 1000.00 kg/cu. m

Probe Data

Serial No. : 500-00283
 Frequency Band : 150
 Duty Cycle Factor : 1
 Conversion Factor : 6.0
 Probe Sensitivity : 1.20 1.20 1.20 $\mu\text{V}/(\text{V}/\text{m})^2$
 Compression Point : 95.00 mV
 Offset : 1.56 mm

1 gram SAR value : 0.221 W/kg
 10 gram SAR value : 0.173 W/kg
 Area Scan Peak SAR : 0.232 W/kg
 Zoom Scan Peak SAR : 0.396 W/kg

Plot 1#

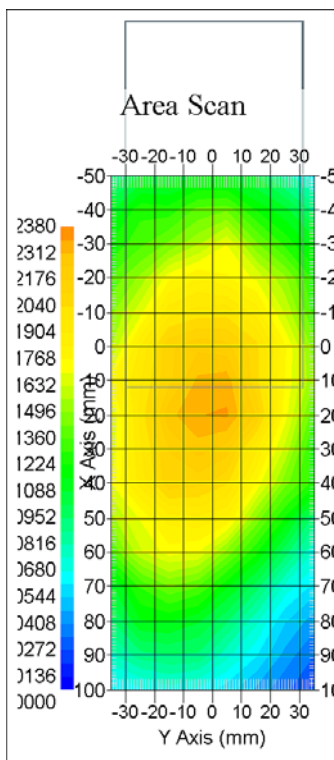

Test Laboratory: Bay Area Compliance Lab Corp. (Shenzhen)

Body-back 0.0cm (Analog 12.5k-155.025MHz)

Measurement Data

Modulation mode : FM
 Crest Factor : 1
 Scan Type : Complete
 Area Scan : 15x8x1: Measurement x=10mm, y=10mm, z=4mm
 Zoom Scan : 7x7x7: Measurement x=5mm, y=5mm, z=5mm
 Power Drift-Start : 0.596 W/kg
 Power Drift-Finish : 0.587 W/kg
 Power Drift (%) : -1.712

Tissue Data

Type : Body
 Frequency : 155.025MHz
 Epsilon : 60.20 F/m
 Sigma : 0.80 S/m
 Density : 1000.00 kg/cu. m

Probe Data

Serial No. : 500-00283
 Frequency Band : 150
 Duty Cycle Factor : 1
 Conversion Factor : 6.0
 Probe Sensitivity : 1.20 1.20 1.20 $\mu\text{V}/(\text{V}/\text{m})^2$
 Compression Point : 95.00 mV
 Offset : 1.56 mm

1 gram SAR value : 0.725 W/kg
 10 gram SAR value : 0.503 W/kg
 Area Scan Peak SAR : 0.737 W/kg
 Zoom Scan Peak SAR : 1.203 W/kg

Plot 2#

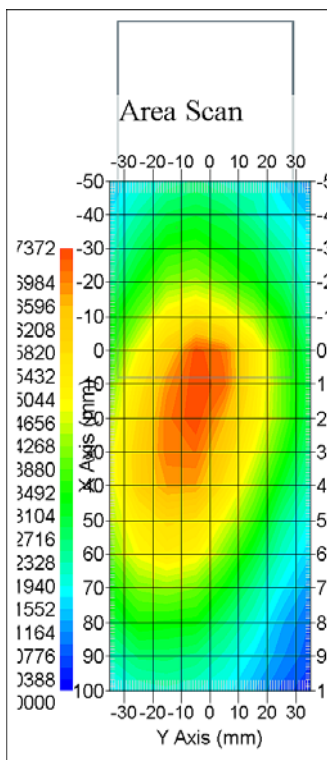

APPENDIX A – MEASUREMENT UNCERTAINTY

The uncertainty budget has been determined for the measurement system and is given in the following Table.

Measurement Uncertainty for 30 MHz to 6 GHz

Source of Uncertainty	Tolerance Value	Probability Distribution	Divisor	c_i^1 (1-g)	c_i^1 (10-g)	Standard Uncertainty (1-g) %	Standard Uncertainty (10-g) %
Measurement System							
Probe Calibration	3.5	normal	1	1	1	3.5	3.5
Axial Isotropy	3.7	rectangular	$\sqrt{3}$	$(1-cp)^{1/2}$	$(\frac{1-cp}{2})^{1/2}$	1.5	1.5
Hemispherical Isotropy	10.9	rectangular	$\sqrt{3}$	\sqrt{cp}	\sqrt{cp}	4.4	4.4
Boundary Effect	1.0	rectangular	$\sqrt{3}$	1	1	0.6	0.6
Linearity	4.7	rectangular	$\sqrt{3}$	1	1	2.7	2.7
Detection Limit	1.0	rectangular	$\sqrt{3}$	1	1	0.6	0.6
Readout Electronics	1.0	normal	1	1	1	1.0	1.0
Response Time	0.8	rectangular	$\sqrt{3}$	1	1	0.5	0.5
Integration Time	1.7	rectangular	$\sqrt{3}$	1	1	1.0	1.0
RF Ambient Condition -Noise	0.6	rectangular	$\sqrt{3}$	1	1	0.3	0.3
RF Ambient Condition -Reflections	3.0	rectangular	$\sqrt{3}$	1	1	1.7	1.7
Probe Positioner Mech. Restrictions	0.4	rectangular	$\sqrt{3}$	1	1	0.2	0.2
Restriction							
Probe Positioning with respect to Phantom Shell	2.9	rectangular	$\sqrt{3}$	1	1	1.7	1.7
Extrapolation and Integration	3.7	rectangular	$\sqrt{3}$	1	1	2.1	2.1
Test Sample Positioning	2.3	normal	1	1	1	2.3	2.3
Device Holder Uncertainty	6.215	normal	1	1	1	6.215	6.215
Drift of Output Power	4.627	rectangular	$\sqrt{3}$	1	1	2.67	2.67
Phantom and Setup							
Phantom Uncertainty(shape & thickness tolerance)	3.4	rectangular	$\sqrt{3}$	1	1	2.0	2.0
Liquid Conductivity(target)	5.0	rectangular	$\sqrt{3}$	0.7	0.5	2.0	1.4
Liquid Conductivity(meas.)	1.938	normal	1	0.7	0.5	1.36	0.97
Liquid Permittivity(target)	5.0	rectangular	$\sqrt{3}$	0.6	0.5	1.7	1.4
Liquid Permittivity(meas.)	3.093	normal	1	0.6	0.5	1.86	1.55
Combined Uncertainty		RSS				10.78	10.55
Expanded uncertainty (coverage factor=2)		Normal(k=2)				21.56	21.10

APPENDIX B – PROBE CALIBRATION CERTIFICATES

NCL CALIBRATION LABORATORIES

Calibration File No.: PC-1537

Task No: BACL-5745

CERTIFICATE OF CALIBRATION

It is certified that the equipment identified below has been calibrated in the **NCL CALIBRATION LABORATORIES** by qualified personnel following recognized procedures and using transfer standards traceable to NRC/NIST.

Equipment: Miniature Isotropic RF Probe

Record of Calibration

Head and Body

Manufacturer: APREL Laboratories

Model No.: E-020

Serial No.: 500-00283

Calibration Procedure: D01-032-E020-V2, D22-012-Tissue, D28-002-Dipole
Project No: BACL-5745

Calibrated: 8th October 2013

Released on: 8th October 2013

This Calibration Certificate is Incomplete Unless Accompanied with the Calibration Results Summary

Released By: _____



Art Brennan, Quality Manager

NCL CALIBRATION LABORATORIES

Suite 102, 303 Terry Fox Dr,
OTTAWA, ONTARIO
CANADA K2K 3J1

Division of APREL Lab.
TEL: (613) 435-8300
FAX: (613) 435-8306

NCL Calibration Laboratories

Division of APREL Inc.

Introduction

This Calibration Report reproduces the results of the calibration performed in line with the references listed below. Calibration is performed using accepted methodologies as per the references listed below. Probes are calibrated for air, and tissue and the values reported are the results from the physical quantification of the probe through meteorological practices.

Calibration Method

Probes are calibrated using the following methods.

<1000MHz

TEM Cell for sensitivity in air

Standard phantom using temperature transfer method for sensitivity in tissue

>1000MHz

Waveguide* method to determine sensitivity in air and tissue

*Waveguide is numerically (simulation) assessed to determine the field distribution and power

The boundary effect for the probe is assessed using a standard flat phantom where the probe output is compared against a numerically simulated series of data points

References

- IEEE Standard 1528
IEEE Recommended Practice for Determining the Peak Spatial-Average Specific Absorption Rate (SAR) in the Human Head from Wireless Communications Devices: Measurement Techniques
- EN 62209-1
Human Exposure to RF Fields from hand-held and body-mounted wireless communication devices - Human models, instrumentation, and procedures-Part 1: Procedure to measure the Specific Absorption Rate (SAR) for hand-held mobile wireless devices
- IEC 62209-2
Human exposure to RF fields from hand-held and body-mounted wireless devices - Human models, instrumentation, and procedures - Part 2: specific absorption rate (SAR) for wireless communication devices (30 MHz - 6 GHz)
- TP-D01-032-E020-V2 E-Field probe calibration procedure
- D22-012-Tissue dielectric tissue calibration procedure
- D28-002-Dipole procedure for validation of SAR system using a dipole
- IEEE 1309 Standard for Calibration of Electromagnetic Field Sensors and Probes, Excluding Antennas, from 9kHz to 40GHz

Page 2 of 10

This page has been reviewed for content and attested to on Page 2 of this document.

NCL Calibration Laboratories

Division of APREL Inc.

Conditions

Probe 500-00283 was a recalibration.

Ambient Temperature of the Laboratory: 22 °C +/- 1.5°C
Temperature of the Tissue: 21 °C +/- 1.5°C
Relative Humidity: < 60%

Primary Measurement Standards

Instrument	Serial Number	Cal due date
Tektronix USB Power Meter	11C940	May 14, 2015
Signal Generator HP 83640B	3844A00689	Feb 12, 2015

Secondary Measurement Standards

Network Analyzer Anritsu 37347C	002106	Feb. 20, 2015
---------------------------------	--------	---------------

Attestation

The below named signatories have conducted the calibration and review of the data which is presented in this calibration report.

We the undersigned attest that to the best of our knowledge the calibration of this subject has been accurately conducted and that all information contained within the results pages have been reviewed for accuracy.



Art Brennan, Quality Manager



Dan Brooks, Test Engineer

NCL Calibration Laboratories

Division of APREL Inc.

Probe Summary

Probe Type:	E-Field Probe E020
Serial Number:	500-00283
Frequency:	As presented on page 5
Sensor Offset:	1.56
Sensor Length:	2.5
Tip Enclosure:	Composite*
Tip Diameter:	< 2.9 mm
Tip Length:	55 mm
Total Length:	289 mm

*Resistive to recommended tissue recipes per IEEE-1528

Sensitivity in Air

Channel X:	1.2 $\mu\text{V}/(\text{V}/\text{m})^2$
Channel Y:	1.2 $\mu\text{V}/(\text{V}/\text{m})^2$
Channel Z:	1.2 $\mu\text{V}/(\text{V}/\text{m})^2$
Diode Compression Point:	95 mV

Page 4 of 10

This page has been reviewed for content and attested to on Page 2 of this document.

NCL Calibration Laboratories

Division of APREL Inc.

Calibration for Tissue (Head H, Body B)

Frequency	Tissue Type	Measured Epsilon	Measured Sigma	Standard Uncertainty (%)	Calibration Frequency Range (MHz)	Conversion Factor
450 H	Head	44.29	0.86	3.5	±50	5.7
450 B	Body	56.6	0.94	3.5	±50	5.8
750 H	Head	42.7	0.85	3.5	±50	5.6
750 B	Body	56.6	0.94	3.5	±50	5.5
835 H	Head	42.35	0.938	3.5	±50	5.9
835 B	Body	56.65	1.018	3.5	±50	5.9
900 H	Head	X	X	X	X	X
900 B	Body	X	X	X	X	X
1450 H	Head	X	X	X	X	X
1450 B	Body	X	X	X	X	X
1500 H	Head	X	X	X	X	X
1500 B	Body	X	X	X	X	X
1640 H	Head	X	X	X	X	X
1640 B	Body	X	X	X	X	X
1750 H	Head	38.51	1.36	3.5	±75	5.4
1750 B	Body	51.79	1.53	3.5	±75	5.3
1800 H	Head	38.26	1.41	3.5	±75	5.0
1800 B	Body	51.61	1.58	3.5	±75	5.0
1900 H	Head	38.03	1.36	3.5	±75	4.8
1900 B	Body	53.13	1.58	3.5	±75	4.5
2000 H	Head	X	X	X	X	X
2000 B	Body	X	X	X	X	X
2100 H	Head	X	X	X	X	X
2100 B	Body	X	X	X	X	X
2300 H	Head	X	X	X	X	X
2300 B	Body	X	X	X	X	X
2450 H	Head	37.64	1.88	3.5	±75	4.9
2450 B	Body	50.7	2.03	3.5	±75	4.3
2600 H	Head	X	X	X	X	X
2600 B	Body	X	X	X	X	X
3000 H	Head	X	X	X	X	X
3000 B	Body	X	X	X	X	X
3600 H	Head	X	X	X	X	X
3600 B	Body	X	X	X	X	X
5250 H	Head	34.65	4.8	3.5	±100	2.7
5250 B	Body	47.6	5.3	3.5	±100	2.6
5600 H	Head	33.2	5.15	3.5	±100	2.5
5600 B	Body	45.21	5.57	3.5	±100	2.2
5800 H	Head	32.72	5.38	3.5	±100	3.2
5800 B	Body	44.28	6.04	3.5	±100	2.5

NCL Calibration Laboratories

Division of APREL Inc.

Boundary Effect:

Uncertainty resulting from the boundary effect is less than 2.1% for the distance between the tip of the probe and the tissue boundary, when less than 0.58mm.

Spatial Resolution:

The spatial resolution uncertainty is less than 1.5% for 4.9mm diameter probe.
The spatial resolution uncertainty is less than 1.0% for 2.5mm diameter probe.

DAQ-PAQ Contribution

To minimize the uncertainty calculation all tissue sensitivity values were calculated using a load impedance of 5 MΩ.

Page 6 of 10

This page has been reviewed for content and attested to on Page 2 of this document.

NCL Calibration Laboratories

Division of APREL Inc.

Receiving Pattern Air

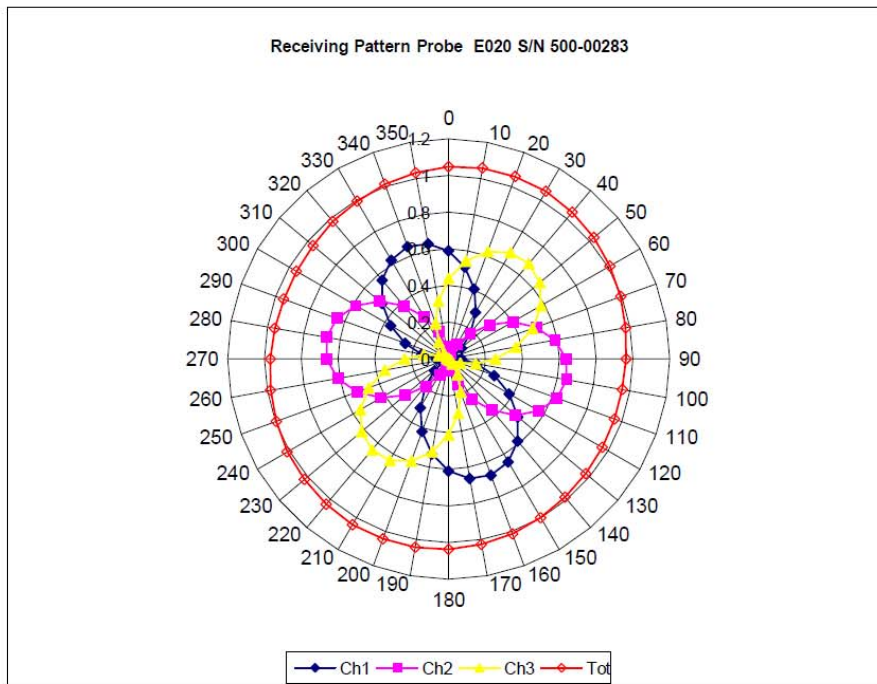

NCL Calibration Laboratories

Division of APREL Inc.

Isotropy Error Air

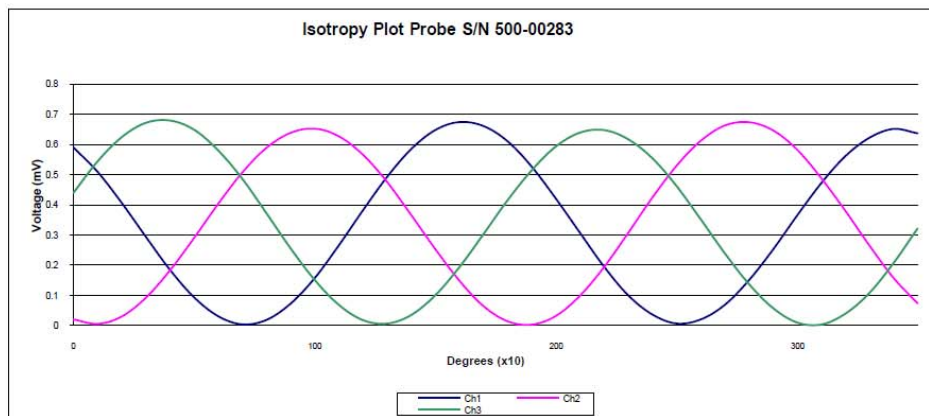
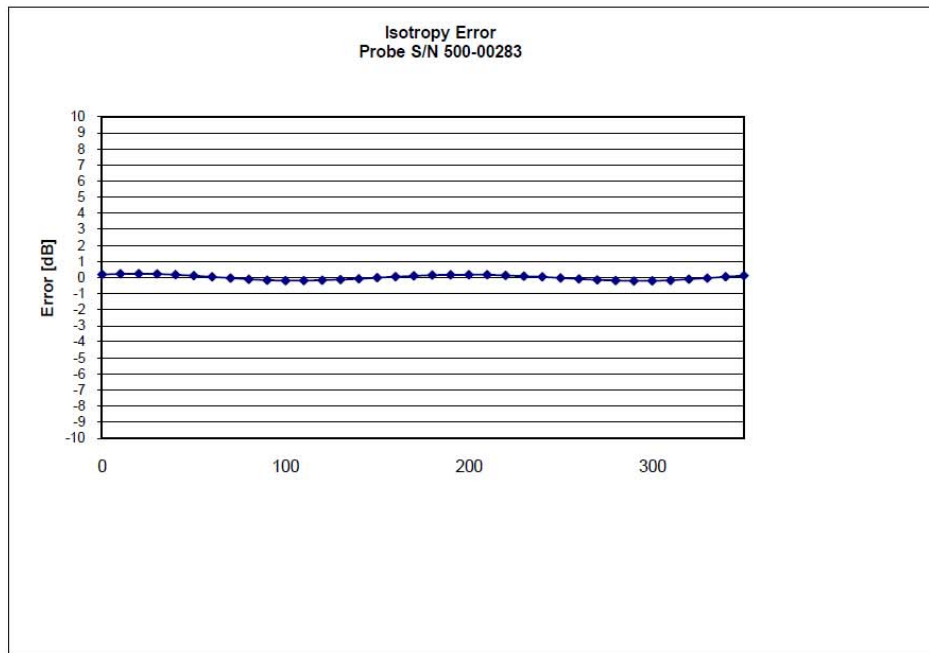

Isotropicity Tissue: 0.10 dB

NCL Calibration Laboratories

Division of APREL Inc.

Dynamic Range

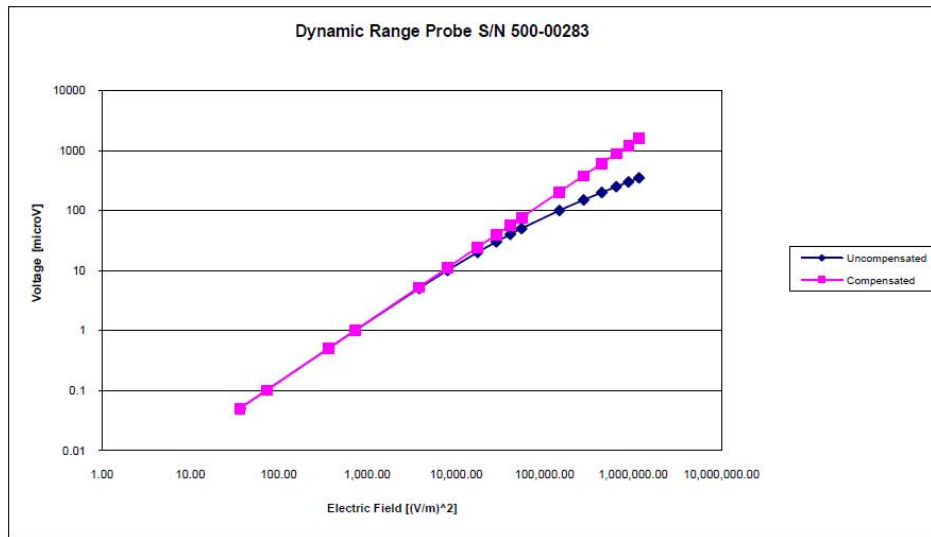

NCL Calibration Laboratories

Division of APREL Inc.

Video Bandwidth

Probe Frequency Characteristics

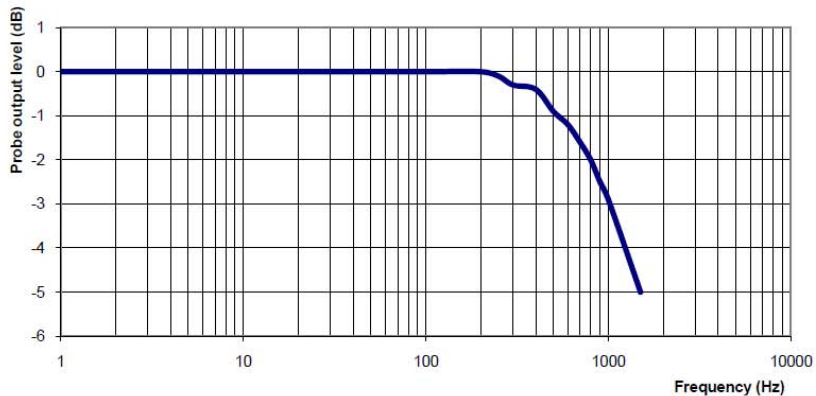

Video Bandwidth at 500 Hz 1 dB
Video Bandwidth at 1.02 KHz: 3 dB

Test Equipment

The test equipment used during Probe Calibration, manufacturer, model number and, current calibration status are listed and located on the main APREL server R:\NCL\Calibration Equipment\Instrument List May 2013.

Page 10 of 10
This page has been reviewed for content and attested to on Page 2 of this document.

ANNEX

PROBE ALS-E020 S/N 500-00283 CALIBRATION

Conditions

Ambient Temperature of the laboratory: 20 °C +/- 1.5°C
 Temperature of the Tissue: 21 °C +/- 1.5°C
 Relative Humidity: < 55%

Frequency	Tissue Type	Measured Epsilon	Measured Sigma	Standard Uncertainty (%)	Calibration Frequency Range (MHz)	Conversion Factor
150 H	Head	50.6	0.78	3.5	±50	6.0
150 B	Body	60.8	0.82	3.5	±50	6.0

Probe Calibration Uncertainty

Uncertainty component	Tolerance (± %)	Probability distribution	Divisor	Standard uncertainty (± %)
Incident or forward power	2.5	R	√3	1.44
Reflected power	2	R	√3	1.15
Liquid conductivity measurement	1	R	√3	0.58
Liquid permittivity measurement	1	R	√3	0.58
Liquid conductivity deviation	1.5	R	√3	0.87
Liquid permittivity deviation	1.5	R	√3	0.87
Frequency deviation	2.25	R	√3	1.30
Field homogeneity	2.5	R	√3	1.44
Field-probe positioning	2.5	R	√3	1.44
Field-probe linearity	1.55	R	√3	0.89
Combined standard uncertainty		RSS		3.50

APPENDIX C – DIPOLE CALIBRATION CERTIFICATES

**Calibration Laboratory of
Schmid & Partner
Engineering AG**
Zeughausstrasse 43, 8004 Zurich, Switzerland



S Schweizerischer Kalibrierdienst
C Service suisse d'étalonnage
S Servizio svizzero di taratura
S Swiss Calibration Service

Accredited by the Swiss Accreditation Service (SAS)
The Swiss Accreditation Service is one of the signatories to the EA
Multilateral Agreement for the recognition of calibration certificates

Accreditation No.: **SCS 108**

Client **BACL**

Certificate No: **CLA150-4004_May14**

CALIBRATION CERTIFICATE

Object: **CLA150 - SN: 4004**

Calibration procedure(s): **QA CAL-15.v8**
Calibration procedure for system validation sources below 700 MHz

Calibration date: **May 08, 2014**

This calibration certificate documents the traceability to national standards, which realize the physical units of measurements (SI).
The measurements and the uncertainties with confidence probability are given on the following pages and are part of the certificate.

All calibrations have been conducted in the closed laboratory facility: environment temperature (22 ± 3)°C and humidity < 70%.

Calibration Equipment used (M&TE critical for calibration)

Primary Standards	ID #	Cal Date (Certificate No.)	Scheduled Calibration
Power meter E4419B	GB41293874	03-Apr-14 (No. 217-01911)	Apr-15
Power sensor E4412A	MY41498087	03-Apr-14 (No. 217-01911)	Apr-15
Reference 3 dB Attenuator	SN: S5054 (3c)	03-Apr-14 (No. 217-01915)	Apr-15
Reference 20 dB Attenuator	SN: S5058 (20k)	03-Apr-14 (No. 217-01918)	Apr-15
Type-N mismatch combination	SN: 5047.2 / 06327	03-Apr-14 (No. 217-01921)	Apr-15
Reference Probe EX3DV4	SN: 3877	06-Jan-14 (No. EX3-3877_Jan14)	Jan-15
DAE4	SN: 654	18-Jul-13 (No. DAE4-654_Jul13)	Jul-14
Secondary Standards	ID #	Check Date (in house)	Scheduled Check
RF generator HP 8648C	US3642U01700	04-Aug-99 (in house check Apr-13)	In house check: Apr-16
Network Analyzer HP 8753E	US37390585 S4206	18-Oct-01 (in house check Oct-13)	In house check: Oct-14

	Name	Function	Signature
Calibrated by:	Israe El-Naouq	Laboratory Technician	
Approved by:	Katja Pokovic	Technical Manager	

Issued: May 8, 2014

This calibration certificate shall not be reproduced except in full without written approval of the laboratory.

**Calibration Laboratory of
Schmid & Partner
Engineering AG**
Zeughausstrasse 43, 8004 Zurich, Switzerland



S Schweizerischer Kalibrierdienst
C Service suisse d'étalonnage
S Servizio svizzero di taratura
S Swiss Calibration Service

Accredited by the Swiss Accreditation Service (SAS)
The Swiss Accreditation Service is one of the signatories to the EA
Multilateral Agreement for the recognition of calibration certificates

Accreditation No.: **SCS 108**

Glossary:

TSL	tissue simulating liquid
ConvF	sensitivity in TSL / NORM x,y,z
N/A	not applicable or not measured

Calibration is Performed According to the Following Standards:

- a) IEC 62209-2, "Procedure to measure the Specific Absorption Rate (SAR) for hand-held devices used in close proximity to the ear (frequency range of 300 MHz to 3 GHz)", February 2013
- b) KDB 865664, "SAR Measurement Requirements for 100 MHz to 6 GHz"

Additional Documentation:

- c) DASY4/5 System Handbook

Methods Applied and Interpretation of Parameters:

- *Measurement Conditions:* Further details are available from the Validation Report at the end of the certificate. All figures stated in the certificate are valid at the frequency indicated.
- *Antenna Parameters with TSL:* The source is mounted in a touch configuration below the center marking of the flat phantom.
- *Return Loss:* This parameter is measured with the source positioned under the liquid filled phantom (as described in the measurement condition clause). The Return Loss ensures low reflected power. No uncertainty required.
- *SAR measured:* SAR measured at the stated antenna input power.
- *SAR normalized:* SAR as measured, normalized to an input power of 1 W at the antenna connector.
- *SAR for nominal TSL parameters:* The measured TSL parameters are used to calculate the nominal SAR result.

The reported uncertainty of measurement is stated as the standard uncertainty of measurement multiplied by the coverage factor k=2, which for a normal distribution corresponds to a coverage probability of approximately 95%.

Measurement Conditions

DASY system configuration, as far as not given on page 1.

DASY Version	DASY5	V52.8.8
Extrapolation	Advanced Extrapolation	
Phantom	ELI4 Flat Phantom	Shell thickness: 2 ± 0.2 mm
EUT Positioning	Touch Position	
Zoom Scan Resolution	dx, dy, dz = 5.0 mm	
Frequency	150 MHz ± 1 MHz	

Head TSL parameters

The following parameters and calculations were applied.

	Temperature	Permittivity	Conductivity
Nominal Head TSL parameters	22.0 °C	52.3	0.76 mho/m
Measured Head TSL parameters	(22.0 ± 0.2) °C	49.9 ± 6 %	0.76 mho/m ± 6 %
Head TSL temperature change during test	< 0.5 °C	----	----

SAR result with Head TSL

SAR averaged over 1 cm ³ (1 g) of Head TSL	Condition	
SAR measured	1 W input power	3.79 W/kg
SAR for nominal Head TSL parameters	normalized to 1W	3.75 W/kg ± 18.4 % (k=2)

SAR averaged over 10 cm ³ (10 g) of Head TSL	condition	
SAR measured	1 W input power	2.51 W/kg
SAR for nominal Head TSL parameters	normalized to 1W	2.49 W/kg ± 18.0 % (k=2)

Body TSL parameters

The following parameters and calculations were applied.

	Temperature	Permittivity	Conductivity
Nominal Body TSL parameters	22.0 °C	61.9	0.80 mho/m
Measured Body TSL parameters	(22.0 ± 0.2) °C	62.5 ± 6 %	0.80 mho/m ± 6 %
Body TSL temperature change during test	< 0.5 °C	----	----

SAR result with Body TSL

SAR averaged over 1 cm ³ (1 g) of Body TSL	Condition	
SAR measured	1 W input power	3.80 W/kg
SAR for nominal Body TSL parameters	normalized to 1W	3.81 W/kg ± 18.4 % (k=2)

SAR averaged over 10 cm ³ (10 g) of Body TSL	condition	
SAR measured	1 W input power	2.55 W/kg
SAR for nominal Body TSL parameters	normalized to 1W	2.55 W/kg ± 18.0 % (k=2)

Appendix**Antenna Parameters with Head TSL**

Impedance, transformed to feed point	45.5 Ω - 10.6 j Ω
Return Loss	- 18.4 dB

Antenna Parameters with Body TSL

Impedance, transformed to feed point	46.0 Ω - 14.6 j Ω
Return Loss	- 16.2 dB

Additional EUT Data

Manufactured by	SPEAG
Manufactured on	August 23, 2013

DASY5 Validation Report for Head TSL

Date: 08.05.2014

Test Laboratory: SPEAG, Zurich, Switzerland

DUT: CLA150; Type: CLA150; Serial: CLA150 - SN: 4004

Communication System: UID 0 - CW; Frequency: 150 MHz

Medium parameters used: $f = 150$ MHz; $\sigma = 0.76$ S/m; $\epsilon_r = 49.9$; $\rho = 1000$ kg/m³

Phantom section: Flat Section

Measurement Standard: DASY5 (IEEE/IEC/ANSI C63.19-2007)

DASY52 Configuration:

- Probe: EX3DV4 - SN3877; ConvF(11.76, 11.76, 11.76); Calibrated: 06.01.2014;
- Sensor-Surface: 2mm (Mechanical Surface Detection)
- Electronics: DAE4 Sn654; Calibrated: 18.07.2013
- Phantom: ELI v4.0; Type: QDOVA001BB; Serial: TP:1003
- DASY52 52.8.8(1222); SEMCAD X 14.6.10(7331)

CLA Calibration for HSL-LF Tissue/CLA150, touch configuration, Pin=1W/Area Scan**(81x81x1):** Interpolated grid: dx=1.500 mm, dy=1.500 mm

Maximum value of SAR (interpolated) = 4.91 W/kg

CLA Calibration for HSL-LF Tissue/CLA150, touch configuration, Pin=1W/Zoom Scan**(7x7x7)/Cube 0:** Measurement grid: dx=5mm, dy=5mm, dz=5mm

Reference Value = 80.11 V/m; Power Drift = -0.05 dB

Peak SAR (extrapolated) = 6.11 W/kg

SAR(1 g) = 3.79 W/kg; SAR(10 g) = 2.51 W/kg

Maximum value of SAR (measured) = 4.89 W/kg

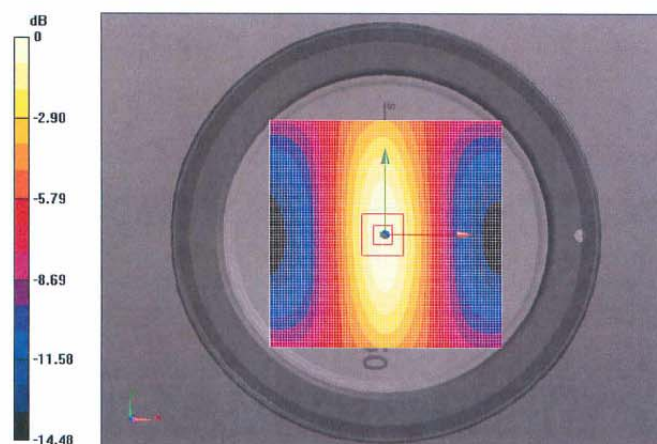

0 dB = 4.91 W/kg = 6.91 dBW/kg

Impedance Measurement Plot for Head TSL

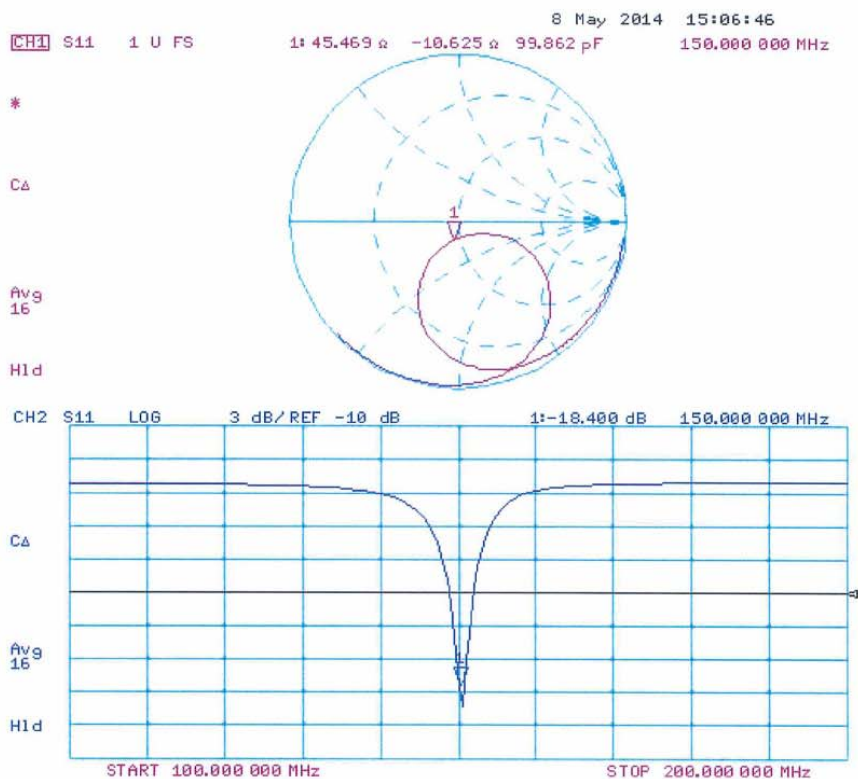

DASY5 Validation Report for Body TSL

Date: 08.05.2014

Test Laboratory: SPEAG, Zurich, Switzerland

DUT: CLA150; Type: CLA150; Serial: CLA150 - SN: 4004

Communication System: UID 0 - CW; Frequency: 150 MHz

Medium parameters used: $f = 150$ MHz; $\sigma = 0.8$ S/m; $\epsilon_r = 62.5$; $\rho = 1000$ kg/m³

Phantom section: Flat Section

Measurement Standard: DASY5 (IEEE/IEC/ANSI C63.19-2007)

DASY52 Configuration:

- Probe: EX3DV4 - SN3877; ConvF(11.45, 11.45, 11.45); Calibrated: 06.01.2014;
- Sensor-Surface: 2mm (Mechanical Surface Detection)
- Electronics: DAE4 Sn654; Calibrated: 18.07.2013
- Phantom: ELI v4.0; Type: QDOVA001BB; Serial: TP:1003
- DASY52 52.8.8(1222); SEMCAD X 14.6.10(7331)

CLA Calibration for MSL-LF Tissue/CLA150, touch configuration, Pin=1W/Area Scan**(81x81x1):** Interpolated grid: $dx=1.500$ mm, $dy=1.500$ mm

Maximum value of SAR (interpolated) = 4.87 W/kg

CLA Calibration for MSL-LF Tissue/CLA150, touch configuration, Pin=1W/Zoom Scan**(7x7x7)/Cube 0:** Measurement grid: $dx=5$ mm, $dy=5$ mm, $dz=5$ mm

Reference Value = 77.84 V/m; Power Drift = -0.03 dB

Peak SAR (extrapolated) = 6.05 W/kg

SAR(1 g) = 3.8 W/kg; SAR(10 g) = 2.55 W/kg

Maximum value of SAR (measured) = 4.88 W/kg

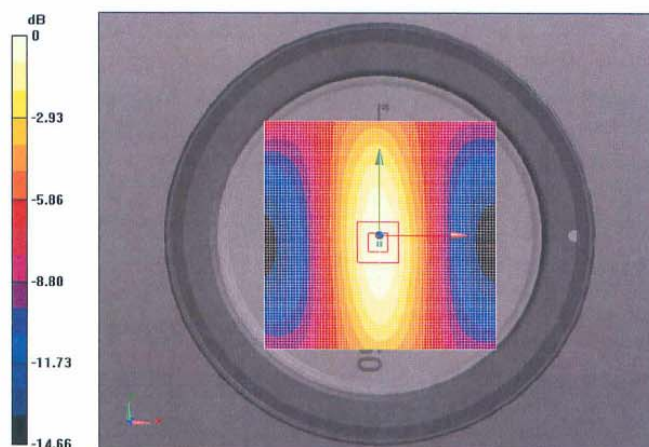

0 dB = 4.87 W/kg = 6.88 dBW/kg

Impedance Measurement Plot for Body TSL

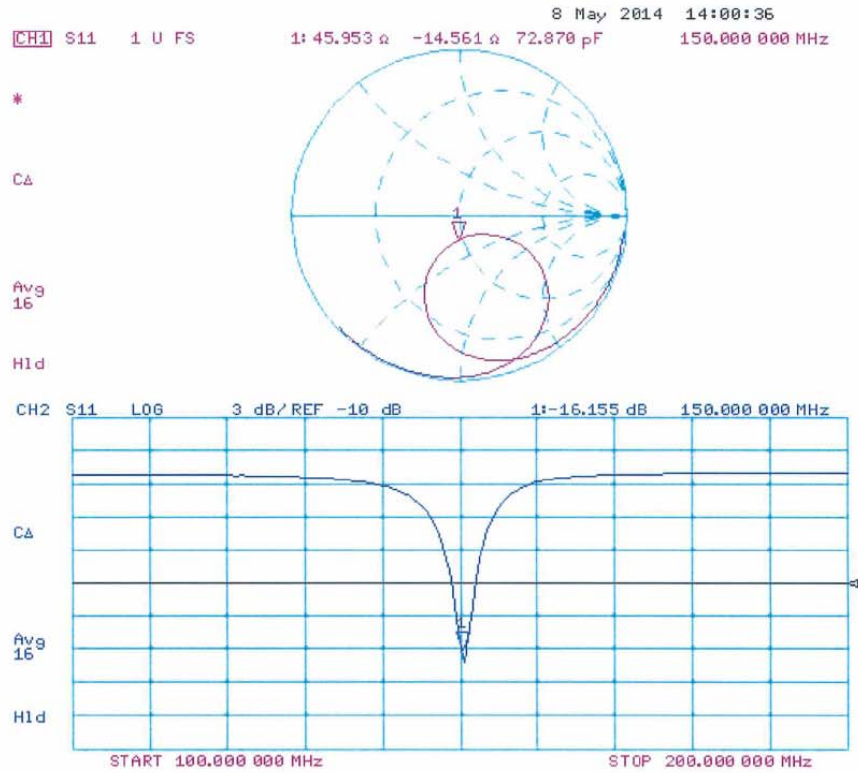

APPENDIX D – EUT TEST POSITION PHOTOS

Liquid depth $\geq 15\text{cm}$

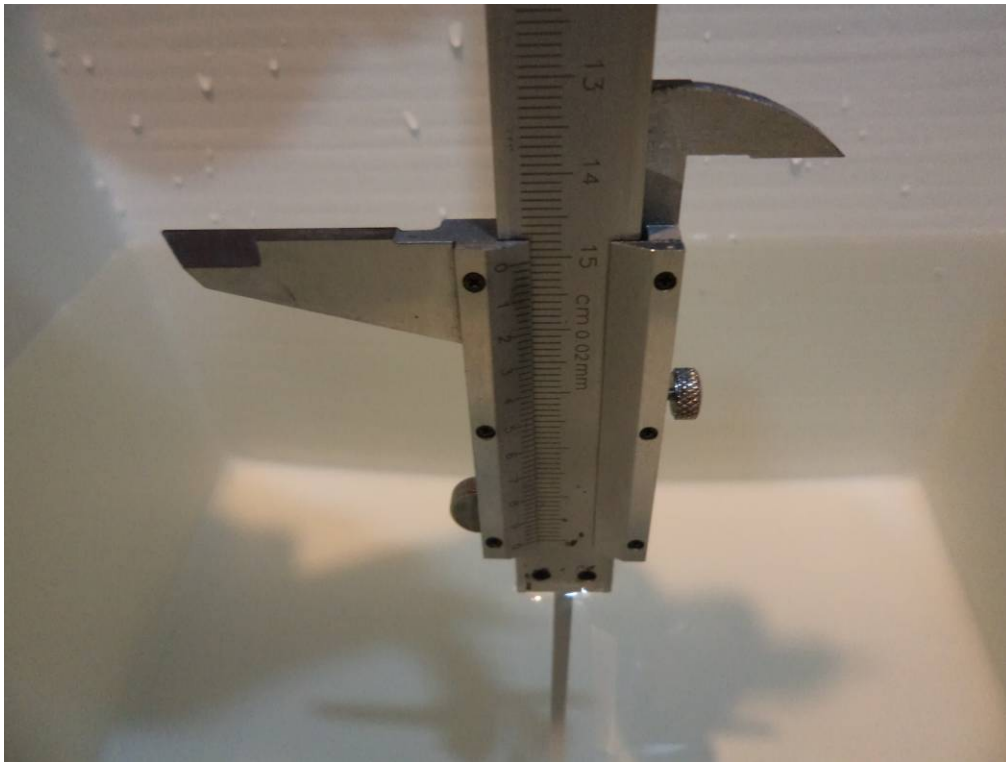

Face-Up 2.5 cm Separation to Flat Phantom Setup Photo

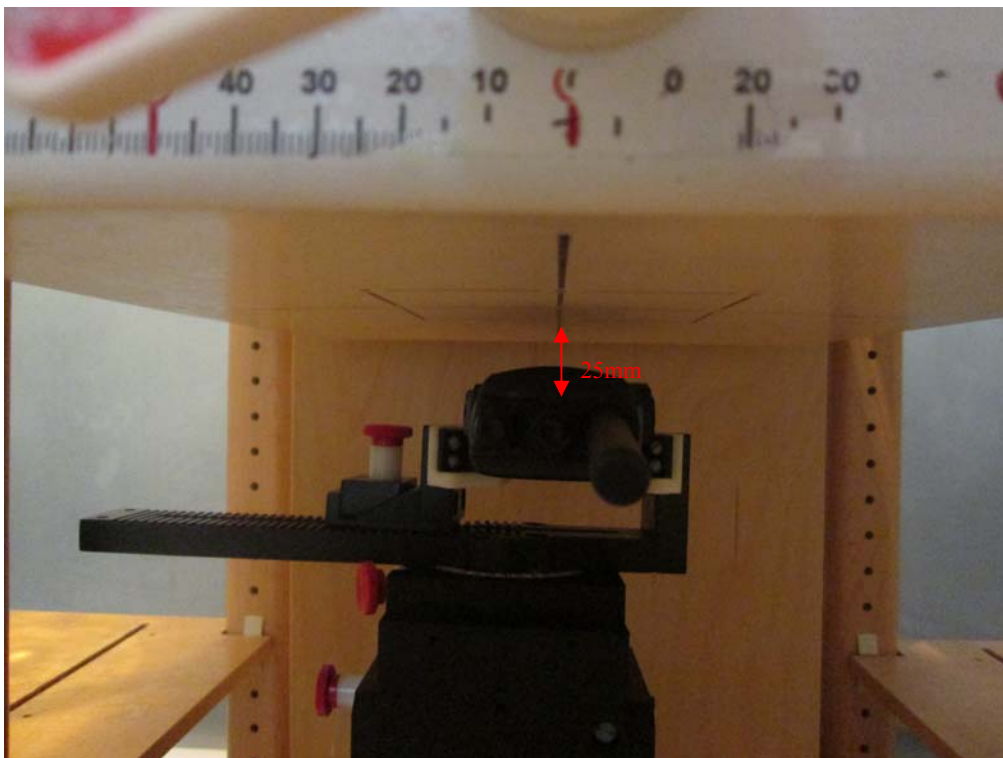

Body-Back 0.0 cm Separation to Flat Phantom Setup Photo (Belt)

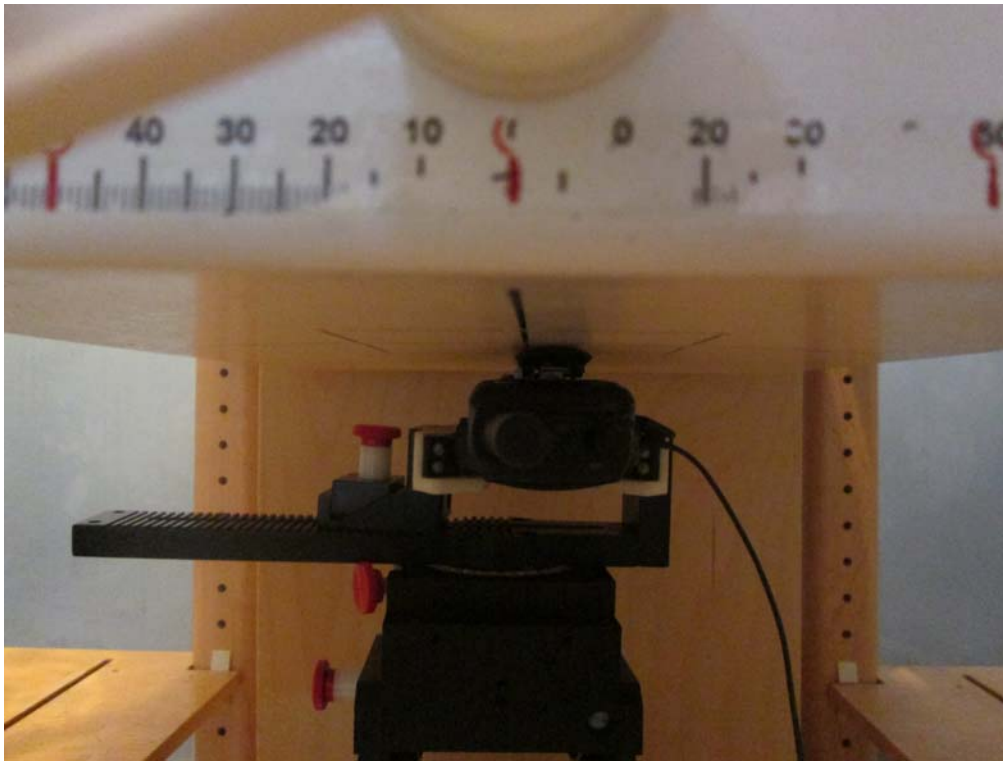

APPENDIX E – EUT PHOTOS

EUT – Front View



EUT – Back View



EUT – Left View



EUT – Right View



EUT – Top View



EUT – Bottom View



EUT – Uncovered View



EUT – Antenna View

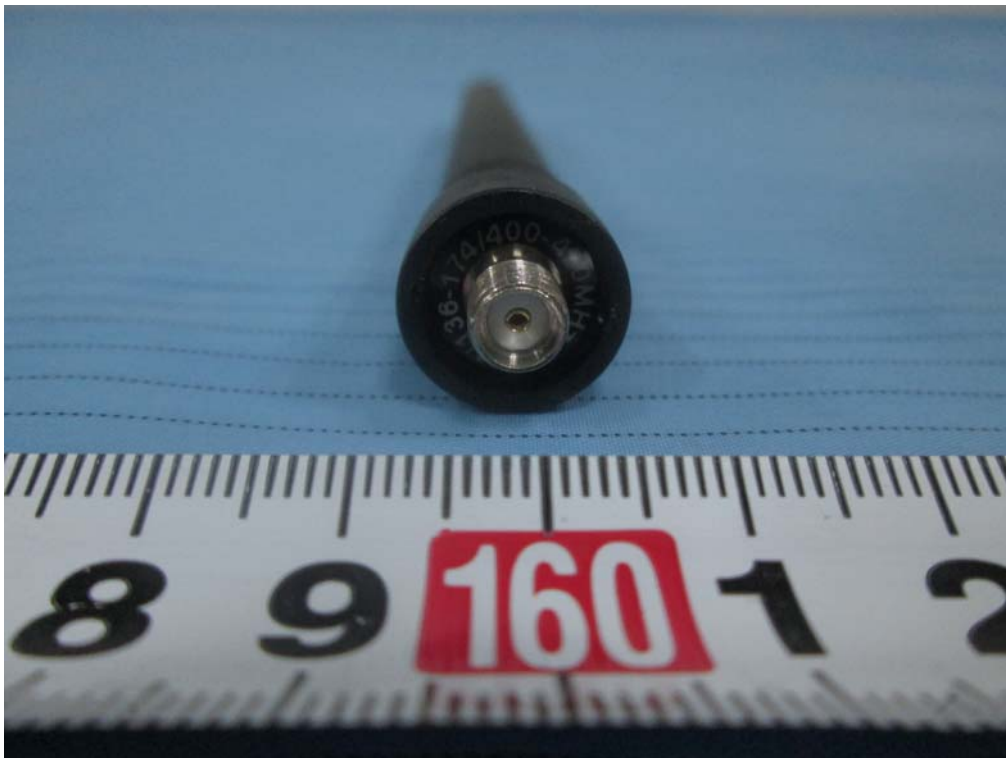

EUT –Belt Clip View



EUT –Battery View



APPENDIX F – INFORMATIVE REFERENCES

- [1] Federal Communications Commission, "Report and order: Guidelines for evaluating the environmental effects of radiofrequency radiation", Tech. Rep. FCC 96-326, FCC, Washington, D.C. 20554, 1996.
- [2] David L. Means Kwok Chan, Robert F. Cleveland, "Evaluating compliance with FCC guidelines for human exposure to radiofrequency electromagnetic fields", Tech. Rep., Federal Communication Commission, Office of Engineering & Technology, Washington, DC, 1997.
- [3] Thomas Schmid, Oliver Egger, and Niels Kuster, "Automated E-field scanning system for dosimetric assessments", IEEE Transactions on Microwave Theory and Techniques, vol. 44, pp. 105-113, Jan. 1996.
- [4] Niels Kuster, Ralph Kastle, and Thomas Schmid, "Dosimetric evaluation of mobile communications equipment with known precision", IEEE Transactions on Communications, vol. E80-B, no. 5, pp. 645-652, May 1997.
- [5] CENELEC, "Considerations for evaluating of human exposure to electromagnetic fields (EMFs) from mobile telecommunication equipment (MTE) in the frequency range 30MHz - 6GHz", Tech. Rep., CENELEC, European Committee for Electrotechnical Standardization, Brussels, 1997.
- [6] ANSI, ANSI/IEEE C95.1-1992: IEEE Standard for Safety Levels with Respect to Human Exposure to Radio Frequency Electromagnetic Fields, 3 kHz to 300 GHz, The Institute of Electrical and Electronics Engineers, Inc., New York, NY 10017, 1992.
- [7] Katja Pokovic, Thomas Schmid, and Niels Kuster, "Robust setup for precise calibration of E-field probes in tissue simulating liquids at mobile communications frequencies", in ICECOM '97, Dubrovnik, October 15-17, 1997, pp. 120-24.
- [8] Katja Pokovic, Thomas Schmid, and Niels Kuster, "E-field probe with improved isotropy in brain simulating liquids", in Proceedings of the ELMAR, Zadar, Croatia, 23-25 June, 1996, pp. 172-175.
- [9] Volker Hombach, Klaus Meier, Michael Burkhardt, Eberhard Kuhn, and Niels Kuster, "The dependence of EM energy absorption upon human head modeling at 900 MHz", IEEE Transactions on Microwave Theory and Techniques, vol. 44, no. 10, pp. 1865-1873, Oct. 1996.
- [10] Klaus Meier, Ralf Kastle, Volker Hombach, Roger Tay, and Niels Kuster, "The dependence of EM energy absorption upon human head modeling at 1800 MHz", IEEE Transactions on Microwave Theory and Techniques, Oct. 1997, in press.
- [11] W. Gander, Computermathematik, Birkhaeuser, Basel, 1992.
- [12] W. H. Press, S. A. Teukolsky, W. T. Vetterling, and B. P. Flannery, Numerical Recipes in C, The Art of Scientific Computing, Second Edition, Cambridge University Press, 1992. Dosimetric Evaluation of Sample device, month 1998 9
- [13] NIS81 NAMAS, "The treatment of uncertainty in EMC measurement", Tech. Rep., NAMAS Executive, National Physical Laboratory, Teddington, Middlesex, England, 1994.
- [14] Barry N. Taylor and Christ E. Kuyatt, "Guidelines for evaluating and expressing the uncertainty of NIST measurement results", Tech. Rep., National Institute of Standards and Technology, 1994. Dosimetric Evaluation of Sample device, month 1998 10.
- [15] FCC OET KDB643646 SAR Test Reduction Considerations for Occupational PTT Radios.

PRODUCT SIMILARITY DECLARATION LETTER

Qixiang Electron Science&Technology Co.,Ltd.Quanzhou
QixiangBuilding,TangxiIndustrialZone,LuojiangDistrict,Quanzhou,Fujian,
China.
Tel :86-595-22656926 Fax:86-595-22656927

2014-7-8

Product Similarity Declaration Letter

To Whom It May Concern,

We, **Qixiang Electron Science&Technology Co.,Ltd.Quanzhou**; hereby declare that our product **TWO WAY RADIO**, the model **518UV,3208UV,298UV,938UV,318UV 518UVII,3208UVII** are electrically identical, they have the same PCB layout , schematic and software, the only difference is the model number due to the marketing purpose. Details as below:

Trade Name	Model
AnyTone	518UV
AnyTone	3208UV,
AnyTone	298UV
AnyTone	938UV
AnyTone	318UV
AnyTone	518UVII,
AnyTone	3208UVII

518UV was tested by Lab.

Please contact me if you have any question.

Signature:Melinda

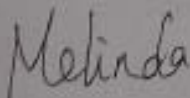

***** END OF REPORT *****