

SAR Test Report

Report No.: AGC00589130504FH01

FCC ID : T4K289G

Product Designation : TWO WAY RADIO

Brand Name : N/A

Model Name : 289, 289G, 289P, 3317, 258, 268, 278, 298, 299, 898, 889, X-500V,
X-5000V, X-2000V, 289G1

Client : Qixiang Electron Science & Technology Co., Ltd. Quanzhou

Date of Issue : May 28, 2013

STANDARD(S) : FCC OET65 Supplement C June 2001
IEEE Std.1528-2003
47CFR§2.1093

REPORT VERSION : V1.0

Attestation of Global Compliance (Shenzhen) Co., Ltd.



CAUTION:

This report shall not be reproduced except in full without the written permission of the test laboratory and shall not be quoted out of context.

Report Revise Record

Report Version	Revise Time	Issued Date	Valid Version	Notes
V1.0	/	May 28, 2013	Valid	Original Report

Test Report Certification

Applicant Name	Qixiang Electron Science & Technology Co., Ltd. Quanzhou
Applicant Address	Qixiang Building, Tangxi Industrial Zone, Luojiang District, Quanzhou, Fujian, China
Manufacturer Name	Qixiang Electron Science & Technology Co., Ltd. Quanzhou
Manufacturer Address	Qixiang Building, Tangxi Industrial Zone, Luojiang District, Quanzhou, Fujian, China
Product Name	TWO WAY RADIO
Brand Name	N/A
Model Name	289, 289G, 289P, 3317, 258, 268, 278, 298, 299, 898, 889, X-500V, X-5000V, X-2000V, 289G1
Difference Description	All the models are the same, only different in model names. The test model is 289.
EUT Voltage	DC7.4V by battery
Applicable Standard	FCC OET65 Supplement C June 2001 IEEE Std.1528-2003 47CFR§2.1093
Test Date	May 28, 2013
Test Results	MAX SAR MEASUREMENT(1g) (with 50% duty cycle) Head: 0.266 W/Kg Body: 0.544 W/Kg (Maximum Scaling SAR= 0.545 W/Kg)
Performed Location	Attestation of Global Compliance (Shenzhen)Co., Ltd. 2F, Building 2, No.1-No.4, Chaxi Sanwei Technical Industrial Park, Gushu, Xixiang Street, Bao'an District, Shenzhen, China
Report Template	AGCRT-EC-PPT4/SAR (2013-03-01)



 Documented By Vivi Zeng May 28, 2013



 Checked By Angela Li May 28, 2013



 Authorized By Solger Zhang May 28, 2013

TABLE OF CONTENTS

1. GENERAL INFORMATION	5
1.1. EUT Description.....	5
1.2. Test Procedure.....	6
1.3. Test Environment	6
2. SAR MEASUREMENT SYSTEM.....	7
2.1. COMOSAR System Description.....	7
2.2. COMOSAR E-Field Probe.....	9
2.3 Robot	9
2.4. Video Positioning System.....	10
2.5. Device Holder	10
2.6. Elliptic Phantom	11
3. TISSUE SIMULATING LIQUID	12
3.1. The composition of the tissue simulating liquid.....	12
3.2. Tissue Calibration Result.....	13
3.3. Tissue Dielectric Parameters for Head and Body Phantoms	14
4. SAR MEASUREMENT PROCEDURE.....	15
4.1. SAR System Validation	15
4.2. SAR Measurement Procedure	17
5. SAR EXPOSURE LIMITS	18
6. TEST EQUIPMENT LIST	19
7. MEASUREMENT UNCERTAINTY	20
8. CONDUCTED POWER MEASUREMENT.....	21
9. TEST RESULTS	22
APPENDIX A. SAR SYSTEM VALIDATION DATA	24
APPENDIX B. SAR MEASUREMENT DATA.....	26
APPENDIX C. TEST SETUP PHOTOGRAPHS &EUT PHOTOGRAPHS.....	38
APPENDIX D. PROBE CALIBRATION DATA	46
APPENDIX E. DIPOLE CALIBRATION DATA.....	56

1. General Information

1.1. EUT Description

General Information	
Product Name	TWO WAY RADIO
Test Model	289
Hardware Version	N/A
Software Version	N/A
Exposure Category	Occupational/Controlled Exposure
Device Category	FM VHF Portable Transceiver
Modulation Type	FM
TX Frequency Range	136-174MHz
Rated Power	5Watt
Maximum Peak Power	36.96dBm
Channel Spacing	12.5 kHz
Antenna Type	Detachable
Antenna Gain	3dBi
Body-Worn Accessories	Belt Clip with headset
Face-Head Accessories	None
Battery Type (s) Tested	DC7.4V by battery

Note: The sample used for testing is end product.

1.2. Test Procedure

1	Setup the EUT for two typical configuration of hold to face and body worn individually
2	Power on the EUT and make it continuously transmitting on required operating channel
3	Make sure the EUT work normally during the test

1.3. Test Environment

Ambient conditions in the laboratory:

Items	Required	Actual
Temperature (°C)	18-25	21 ± 2
Humidity (%RH)	30-70	56

2. SAR Measurement System

2.1. COMOSAR System Description

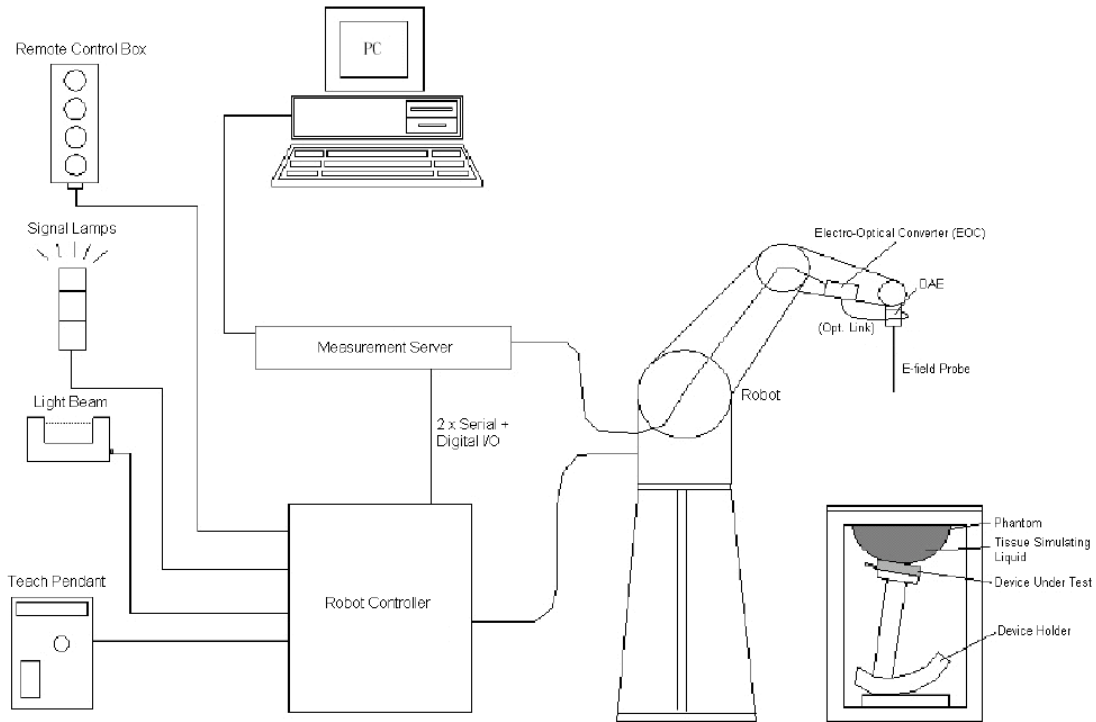

The COMOSAR system for performing compliance tests consists of the following items:

- A standard high precision 6axis robot with controller, teach pendant and software. An arm extension for accommodating the data acquisition electronics (DAE).
- A data acquisition electronics (DAE) which performs the signal amplification, signal multiplexing, AD-conversion, offset measurements, mechanical surface detection, collision detection, etc. The unit is battery powered with standard or rechargeable batteries. The signal is optically transmitted to the EOC.
- The Electrooptical converter (EOC) performs the conversion from optical to electrical signals for the digital communication to the DAE. To use optical surface detection, a special version of the EOC is required. The EOC signal is transmitted to the measurement server.
- The Light Beam used is for probe alignment. This improves the (absolute) accuracy of the probe positioning.
- A computer running WinXP and the Opensar software.
- Remote control and teach pendant as well as additional circuitry for robot safety such as warning lamps, etc.
- The phantom, the device holder and other accessories according to the targeted measurement.

2.1.1. Applications

Predefined procedures and evaluations for automated compliance testing with all worldwide standards, e.g., IEEE 1528, OET 65, IEC 62209-1, IEC 62209-2, EN 50360, EN 50383 and others.

2.1.2. Area Scans

Area scans are defined prior to the measurement process being executed with a user defined variable spacing between each measurement point (integral) allowing low uncertainty measurements to be conducted. Scans defined for FCC applications utilize a 10mm² step integral, with 1mm interpolation used to locate the peak SAR area used for zoom scan assessments.

When an Area Scan has measured all reachable points, it computes the field maxima found in the scanned area, within a range of the global maximum. The range (in dB) is specified in the standards for compliance testing. For example, a 2 dB range is required in IEEE 1528-2003, EN 50361 and IEC 62209 standards, whereby 3 dB is a requirement when compliance is assessed in accordance with the ARIB standard (Japan).

2.1.3. Zoom Scan (Cube Scan Averaging)

Zoom Scans are used to assess the peak spatial SAR values within a cubic averaging volume containing 1 g and 10 g of simulated tissue. A density of 1000 kg/m³ is used to represent the head and body tissue density and not the phantom liquid density, in order to be consistent with the definition of the liquid dielectric properties, i.e. the side length of the 1 g cube is 10mm, with the side length of the 10 g cube 21,5mm.

The zoom scan integer steps can be user defined so as to reduce uncertainty, but normal practice for typical test applications utilize a physical step of 7x7x7 (5mmx5mmx5mm) providing a volume of 30mm in the X & Y axis, and 30mm in the Z axis.

2.1.4. Uncertainty of Inter-/Extrapolation and Averaging

In order to evaluate the uncertainty of the interpolation, extrapolation and averaged SAR calculation algorithms of the Post processor, COMOSAR allows the generation of measurement grids which are artificially predefined by analytically based test functions. Therefore, the grids of area scans and zoom scans can be filled with uncertainty test data, according to the SAR benchmark functions of IEEE 1528. The three analytical functions shown in equations as below are used to describe the possible range of the expected SAR distributions for the tested handsets. The field gradients are covered by the spatially flat distribution f1, the spatially steep distribution f3 and f2 accounts for H-field cancellation on the phantom/tissue surface.

$$f_1(x, y, z) = Ae^{-\frac{z}{2a}} \cos^2 \left(\frac{\pi}{2} \frac{\sqrt{x'^2 + y'^2}}{5a} \right)$$

$$f_2(x, y, z) = Ae^{-\frac{z}{a}} \frac{a^2}{a^2 + x'^2} \left(3 - e^{-\frac{2z}{a}} \right) \cos^2 \left(\frac{\pi}{2} \frac{y'}{3a} \right)$$

$$f_3(x, y, z) = A \frac{a^2}{\frac{a^2}{4} + x'^2 + y'^2} \left(e^{-\frac{2z}{a}} + \frac{a^2}{2(a + 2z)^2} \right)$$

2.2. COMOSAR E-Field Probe

The SAR measurement is conducted with the dissymmetric probe manufactured by SPEAG.

The probe is specially designed and calibrated for use in liquid with high permittivity. The dissymmetric probe has special calibration in liquid at different frequency.

SPEAG conducts the probe calibration in compliance with international and national standards (e.g. IEEE 1528, EN62209-1, IEC 62209, etc.) Under ISO17025. The calibration data are in Appendix D.

2.2.1. Isotropic E-Field Probe Specification

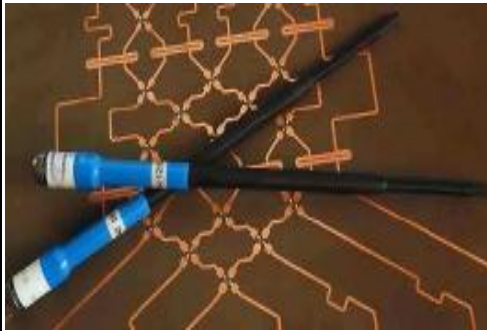
Model	EP165	
Manufacture	Satimo	
frequency	0.03GHz-3 GHz Linearity:±0.2dB(30 MHz-3 GHz)	
Dynamic Range	0.01W/Kg-100W/Kg Linearity:±0.2dB	
Dimensions	Overall length:330mm Length of individual dipoles:4.5mm Maximum external diameter:8mm Probe Tip external diameter:5mm Distance between dipoles/ probe extremity:2.7mm	
Application	High precision dosimetric measurements in any exposure scenario (e.g., very strong gradient fields). Only probe which enables compliance testing for frequencies up to 3 GHz with precision of better 30%.	

2.3 Robot

The COMOSAR system uses the high precision robots TX90 XL type out of the newer series from Satimo SA (France).For the 6-axis controller COMOSAR system, the KUKA robot controller version from Satimo is used.

The XL robot series have many features that are important for our application:

- High precision (repeatability 0.02 mm)
- High reliability (industrial design)
- Jerk-free straight movements
- Low ELF interference (the closed metallic construction shields against motor control fields)
- 6-axis controller



2.4. Video Positioning System

The video positioning system is used in OpenSAR to check the probe. Which is composed of a camera, LED, mirror and mechanical parts. The camera is piloted by the main computer with firmware link.

During the process, the actual position of the probe tip with respect to the robot arm is measured, as well as the probe length and the horizontal probe offset. The software then corrects all movements, such that the robot coordinates are valid for the probe tip.

The repeatability of this process is better than 0.1 mm. If a position has been taught with an aligned probe, the same position will be reached with another aligned probe within 0.1 mm, even if the other probe has different dimensions. During probe rotations, the probe tip will keep its actual position.



2.5. Device Holder

The COMOSAR device holder is designed to cope with different positions given in the standard. It has two scales for the device rotation (with respect to the body axis) and the device inclination (with respect to the line between the ear reference points). The rotation center for both scales is the ear reference point (EPR).

Thus the device needs no repositioning when changing the angles.

The COMOSAR device holder has been made out of low-loss POM material having the following dielectric parameters: relative permittivity $\epsilon_r \approx 3$ and loss tangent $\delta = 0.02$. The amount of dielectric material has been reduced in the closest vicinity of the device, since measurements have suggested that the influence of the clamp on the test results could thus be lowered.

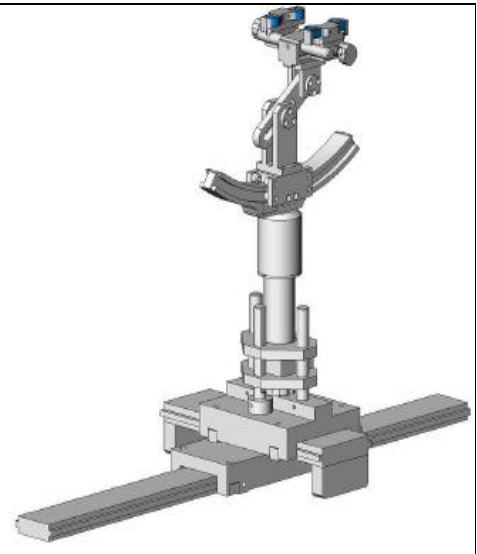

2.6. Elliptic Phantom

The Elliptic Phantom is a fiberglass shell flat phantom with 2mm+/- 0.2 mm shell thickness. It has only one measurement area for Flat phantom



3. Tissue Simulating Liquid

3.1. The composition of the tissue simulating liquid

Ingredient (% Weight) Tissue Type	300MHz
Water	37.56
Salt (NaCl)	5.95
Sugar	55.32
HEC	0.98
Bactericide	0.19
Triton X-100	0.0
DGBE	0.0

3.2. Tissue Calibration Result

The dielectric parameters of the liquids were verified prior to the SAR evaluation using COMOSAR Dielectric Probe Kit and R&S Network Analyzer ZVL6 .

Head Tissue Stimulant Measurement				
Frequency (MHz)	Description	Dielectric Parameters		Tissue Temp [°C]
300MHz	Reference result ±5% window	ϵ_r 45.30 43.035 -47.565	δ [s/m] 0.87 0.8265 - 0.9135	N/A
	May 28, 2013	46.70	0.86	21.0

Body Tissue Stimulant Measurement				
Frequency (MHz)	Description	Dielectric Parameters		Tissue Temp [°C]
300MHz	Reference result ±5% window	ϵ_r 45.30 43.035 -47.565	δ [s/m] 0.87 0.8265 - 0.9135	N/A
	May 28, 2013	45.79	0.91	21.0

3.3. Tissue Dielectric Parameters for Head and Body Phantoms

The head tissue dielectric parameters recommended by the IEEE SCC-34/SC-2 in P1528 have been incorporated in the following table. These head parameters are derived from planar layer models simulating the highest expected SAR for the dielectric properties and tissue thickness variations in a human head. Other head and body tissue parameters that have not been specified in P1528 are derived from the tissue dielectric parameters computed from the 4-Cole-Cole equations described in Reference [12] and extrapolated according to the head parameters specified in P1528.

Target Frequency (MHz)	head		body	
	ϵ_r	σ (S/m)	ϵ_r	σ (S/m)
300	45.3	0.87	45.3	0.87
450	43.5	0.87	43.5	0.87
835	41.5	0.90	41.5	0.90
900	41.5	0.97	41.5	0.97
915	41.5	0.98	41.5	0.98
1450	40.5	1.20	40.5	1.20
1610	40.3	1.29	40.3	1.29
1800 – 2000	40.0	1.40	40.0	1.40
2450	39.2	1.80	39.2	1.80
3000	38.5	2.40	38.5	2.40
5800	35.3	5.27	35.3	5.27

(ϵ_r = relative permittivity, σ = conductivity and $\rho = 1000 \text{ kg/m}^3$)

4. SAR Measurement Procedure

4.1. SAR System Validation

4.1.1. Validation Dipoles

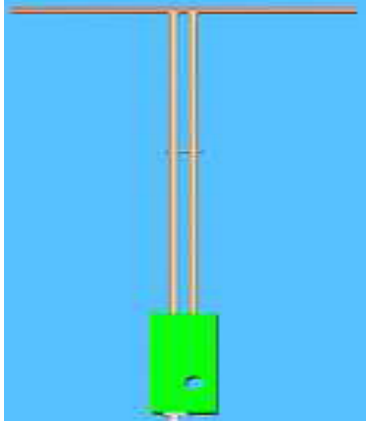
	<p>The dipoles used is based on the IEEE-1528 standard, and is complied with mechanical and electrical specifications in line with the requirements of both IEEE and FCC Supplement C. the table below provides details for the mechanical and electrical Specifications for the dipoles.</p>
---	---

Frequency	L (mm)	h (mm)	d (mm)
300MHz	420	290	6.36

4.1.2. Validation Result

System Performance Check at 300 MHz for Head				
Validation Kit: SN 46/11DIP 0G300-183				
Frequency [MHz]	Description	SAR [w/kg] 1g	SAR [w/kg] 10g	Tissue Temp.[°C]
300 MHz	Reference result ± 10% window	2.85 2.565 to 3.135	1.94 1.746 to 2.134	N/A
	May 28, 2013	2.96	1.87	21
Note: All SAR values are normalized to 1W forward power.				

4.2. SAR Measurement Procedure

The COMOSAR calculates SAR using the following equation,

$$SAR = \frac{\sigma |E|^2}{\rho}$$

σ : represents the simulated tissue conductivity

ρ : represents the tissue density

The EUT is set to transmit at the required power in line with product specification, at each frequency relating to the LOW, MID, and HIGH channel settings.

Pre-scans are made on the device to establish the location for the transmitting antenna, using a large area scan in either air or tissue simulation fluid.

The EUT is placed against the Universal Phantom where the maximum area scan dimensions are larger than the physical size of the resonating antenna. When the scan size is not large enough to cover the peak SAR distribution, it is modified by either extending the area scan size in both the X and Y directions, or the device is shifted within the predefined area.

The area scan is then run to establish the peak SAR location (interpolated resolution set at 1mm²) which is then used to orient the center of the zoom scan. The zoom scan is then executed and the 1g and 10g averages are derived from the zoom scan volume (interpolated resolution set at 1mm³).

When multiple peak SAR locations were found during the same configuration or test mode, Zoom scan shall performed on each peak SAR location, only the peak point with maximum SAR value will be reported for the configuration or test mode.

5. SAR Exposure Limits

SAR assessments have been made in line with the requirements of IEEE-1528, FCC Supplement C, and comply with ANSI/IEEE C95.1-1992 “Uncontrolled Environments” limits. These limits apply to a location which is deemed as “Uncontrolled Environment” which can be described as a situation where the general public may be exposed to an RF source with no prior knowledge or control over their exposure.

Limits for General Population/Uncontrolled and Occupational Environment

Type Exposure Limits	General Population / Uncontrolled Environment Limit (W/Kg)	Occupational / Controlled Exposure Environment (W/Kg)
Spatial Average SAR (whole body)	1.60	8.0

6. Test Equipment List

Equipment description	Manufacturer/Model	Identification No.	Current calibration date	Next calibration date
SAR Probe	Satimo	SN 04/13 EP165	01/31/2013	01/30/2014
Phantom	Satimo	SN_4511_SAM90	Validated. No cal required.	Validated. No cal required.
Liquid	Satimo	-	Validated. No cal required.	Validated. No cal required.
Comm Tester	R&S - CMU200	069Y7-158-13-712	02/28/2013	02/27/2014
Comm Tester	Agilent-8960	GB46310822	10/22/2012	10/21/2013
Multimeter	Keithley 2000	1188656	02/28/2013	02/27/2014
Dipole	Satimo SID300	SN 46/11DIP 0G300-183	12/09/2011	12/08/2013
Amplifier	Aethercomm	SN 046	12/08/2012	12/07/2013
Signal Generator	Agilent-E4421B	MY43351603	05/13/2013	05/12/2014
Power Meter	HP E4418A	US38261498	02/28/2013	02/27/2014
Network Analyzer	Rhode & Schwarz ZVA	SN100132	02/28/2013	02/27/2014

Note: Per KDB 50824 Dipole SAR Validation Verification, AGC Lab has adopted 3 years calibration intervals. On annual basis, every measurement dipole has been evaluated and is in compliance with the following criteria:

1. There is no physical damage on the dipole;
2. System validation with specific dipole is within 10% of calibrated value;
3. Return-loss is within 20% of calibrated measurement;
4. Impedance is within 5Ω of calibrated measurement.

7. Measurement Uncertainty

Satimo Uncertainty

Measurement uncertainty for 300 MHz to 6 GHz averaged over 1 gram / 10 gram.

Error Description	Sec	Tol (±%)	Prob. Dist.	Div.	(Ci) 1g	(Ci) 10g	Std. Unc. (1g) (±%)	Std. Unc. (10g)(±%)	(Vi) Veff
Measurement System									
Probe Calibration	E.2.1	6	N	1	1	1	6	6	∞
Axial Isotropy	E.2.2	3	R	$\sqrt{3}$	$(1-c_p)^{1/2}$	$(1-c_p)^{1/2}$	1.22474	1.22474	∞
Hemispherical Isotropy	E.2.2	5	R	$\sqrt{3}$	$\sqrt{c_p}$	$\sqrt{c_p}$	2.04124	2.04124	∞
Boundary Effects	E.2.3	1	R	$\sqrt{3}$	1	1	0.57735	0.57735	∞
Linearity	E.2.4	5	R	$\sqrt{3}$	1	1	2.88675	2.88675	∞
System Detection Limits	E.2.5	1	R	$\sqrt{3}$	1	1	0.57735	0.57735	∞
Readout Electronics	E.2.6	0.5	N	1	1	1	0.5	0.5	∞
Response Time	E.2.7	0.2	R	$\sqrt{3}$	1	1	0.11547	0.11547	∞
Integration Time	E.2.8	2	R	$\sqrt{3}$	1	1	1.1547	1.1547	∞
RF Ambient Noise	E.6.1	3	R	$\sqrt{3}$	1	1	1.73205	1.73205	∞
Probe Positioner Mechanical Tolerance	E.6.2	2	R	$\sqrt{3}$	1	1	1.1547	1.1547	∞
Probe Positioning with Respect to Phantom Shell	E.6..3	1	R	$\sqrt{3}$	1	1	0.57735	0.57735	∞
Extrapolation,interpolation and Integration Algorithms for Max. SAR Evaluation	E.5.2	1.5	R	$\sqrt{3}$	1	1	0.89603	0.89603	∞
Dipole									
Device Positioning	8,E.4.2	1	N	$\sqrt{3}$	1	1	0.57735	0.57735	N-1
Power Drift	8.6.6.2	2	R	$\sqrt{3}$	1	1	1.1547	1.1547	∞
Phantom and Tissue Parameters									
Phantom Uncertainty	E.3.1	4	R	$\sqrt{3}$	1	1	2.3094	2.3094	∞
Liquid Conductivity (target)	E.3.2	5	R	$\sqrt{3}$	0.64	0.43	1.84752	1.2413	∞
Liquid Conductivity (meas.)	E.3.3	2.5	N	1	0.64	0.43	1.6	1.075	∞
Liquid Permittivity (target)	E.3.2	3	R	$\sqrt{3}$	0.6	0.49	1.03923	0.8487	∞
Liquid Permittivity (meas.)	E.3.3	2.5	N	1	0.6	0.49	1.5	1.225	M
Combined Standard Uncertainty			RSS				8.09272	7.9296	
Expanded Uncertainty (95%CONFIDENCE INTERVAL)			k				16.18544	15.8594	

8. Conducted Power Measurement

Frequency (MHz)	Channel Spacing	Measured Conducted Output power	
		Max. Peak Power (dBm)	Avg. Power (dBm)
136.025	12.5KHz	36.93	35.84
155.000		36.96	35.86
173.975		36.91	35.81

9. Test Results

9.1. SAR Test Results Summary

9.1.1. Test position and configuration

Head SAR was performed with the device configured in the positions according to KDB 643646 and Body SAR was performed with the device configured with all accessories close to the Flat Phantom.

9.1.2. Operation Mode

Set the EUT to maximum output power level and transmit on lower, middle and top channel with 100% duty cycle individually during SAR measurement.

9.1.3. Co-located SAR

The following KDB was used for assessing this device.
KDB 447498, KDB 643646 and KDB450824

9.1.4. Test Result

SAR MEASUREMENT							
Ambient Temperature (°C) : 21 ±2				Relative Humidity (%) : 52			
Liquid Temperature (°C) : 21 ±2				Depth of Liquid (cm):>15			
Product: TWO WAY RADIO							
Test Mode: Hold to Face with 2.5 cm separation(VHF)							
Test Position	Frequency			Power Drift (±5%)	SAR 1g with 100% duty Cycle (W/kg)	SAR 1g with 50% duty cycle (W/Kg)	Limit (W/kg)
	channel	MHz	Separation (KHz)				
Face Up	Low	136.025	12.5	-1.05	0.216	0.108	8.0
Face Up	Middle	155.000	12.5	1.32	0.531	0.266	8.0
Face Up	Top	173.975	12.5	0.53	0.206	0.103	8.0
Note: when the 1-g SAR of middle channel is ≤ 3.5 W/kg, testing for other channel is optional. refer to KDB 643646.							

SAR MEASUREMENT							
Ambient Temperature (°C) : 21 ±2				Relative Humidity (%) : 52			
Liquid Temperature (°C) : 21 ±2				Depth of Liquid (cm):>15			
Product: TWO WAY RADIO							
Test Mode: Body worn with all accessories(VHF)							
Test Position	Frequency			Power Drift (±5%)	SAR 1g with 100% duty Cycle (W/kg)	SAR 1g with 50% duty cycle (W/Kg)	Limit (W/kg)
	channel	MHz	Separation (KHz)				
Back Touch	Low	136.025	12.5	2.54	0.363	0.182	8.0
Back Touch	Middle	155.000	12.5	1.25	1.087	0.544	8.0
Back Touch	Top	173.975	12.5	-2.53	0.594	0.297	8.0
Note: when the 1-g SAR of middle channel is ≤ 3.5 W/kg, testing for other channel is optional. refer to KDB 643646.							

Appendix A. SAR System Validation Data

Test Laboratory: AGC Lab

Test date: May 28, 2013

System Check Head 300MHz

DUT: Dipole 300 MHz Type: SID 300

Communication System: CW; Communication System Band: CW 300MHz; Duty Cycle: 1:1; Conv.F=4.58

Frequency: 300MHz; Medium parameters used: $f = 300\text{MHz}$; $\sigma=0.86 \text{ mho/m}$; $\epsilon_r = 46.70$; $\rho = 1000 \text{ kg/m}^3$;

Phantom Type: Elliptical Phantom; Input Power=20dBm

Ambient temperature (°C): 21.0, Liquid temperature (°C): 21.0

Satimo Configuration:

Probe: EP165; Calibrated: 01/31/2013

- Sensor-Surface: 4mm (Mechanical Surface Detection)
- Phantom: Flat Phantom; Type: Elliptical Phantom
- Measurement SW: OpenSAR V4_02_0

Configuration/System Check CW 300MHz Head/Area Scan: Measurement grid: dx=8mm,dy=8mm

Configuration/System Check CW 300MHz Head/Zoom Scan : Measurement grid: dx=8mm, dy=8mm, dz=5mm

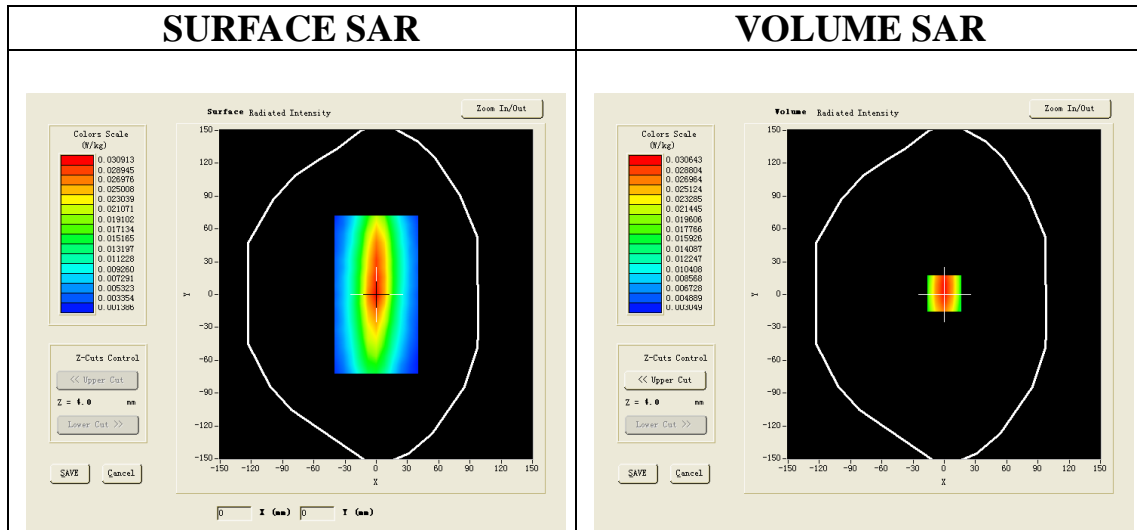

Maximum location: X=0.00, Y=1.00

SAR 10g (W/Kg)	0.018655
SAR 1g (W/Kg)	0.029619

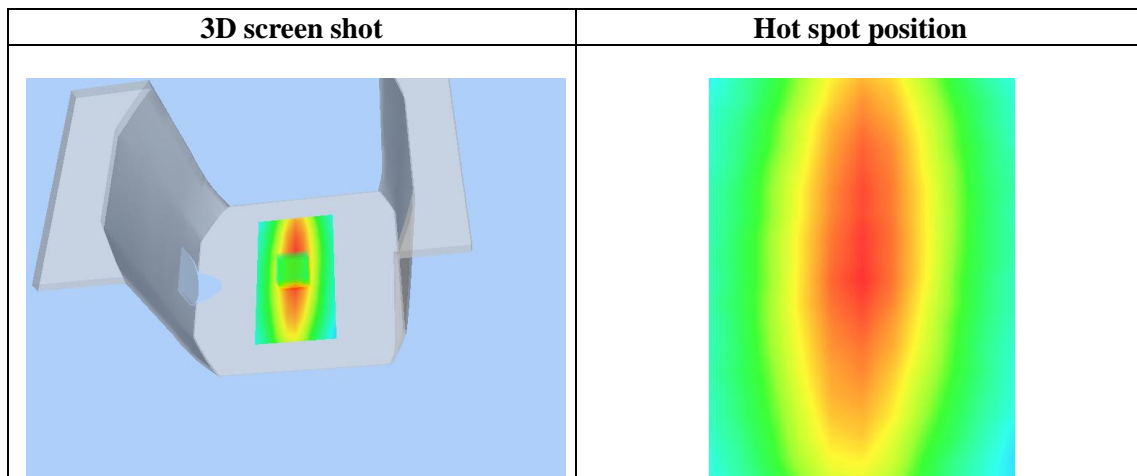
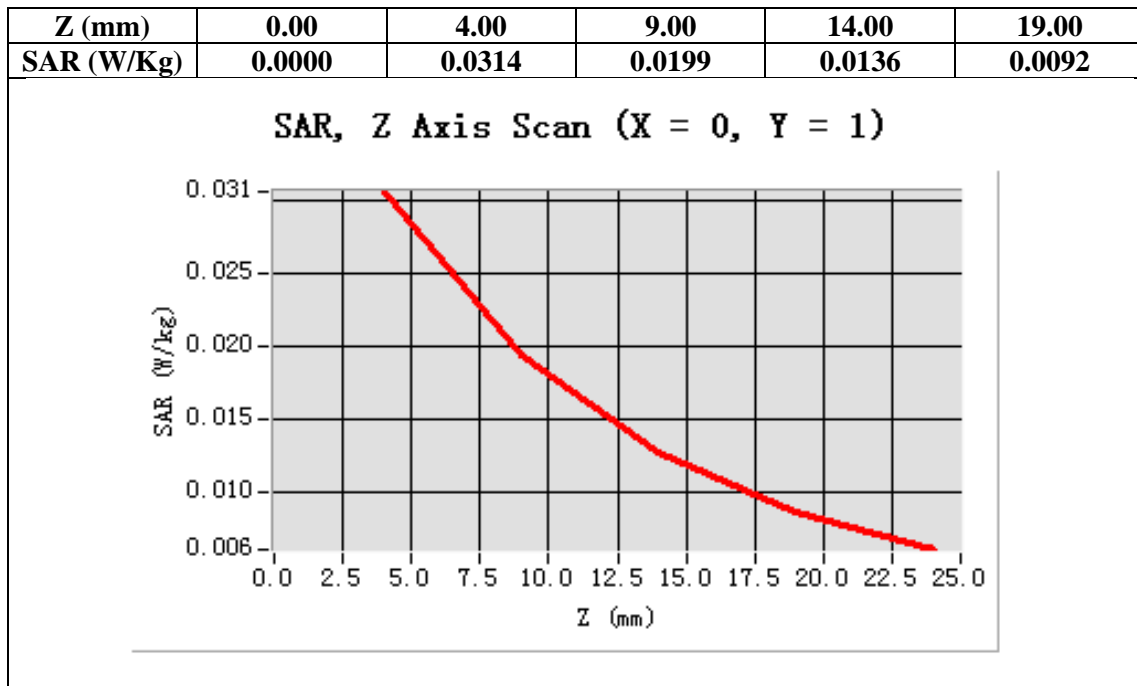

Appendix B. SAR measurement Data

Test Laboratory: AGC Lab
CW300Low-face up 2.5cm (12.5 KHz)
DUT: TWO WAY RADIO; Type: 289

Date: May 28, 2013

Communication System: CW; Communication System Band: CW 300MHz; Duty Cycle: 1:1; Conv.F=4.58
Frequency: 136.025 MHz; Medium parameters used: $f = 300\text{MHz}$; $\sigma=0.86\text{ mho/m}$; $\epsilon_r = 46.70$; $\rho = 1000\text{ kg/m}^3$;
Phantom Type: Elliptical Phantom
Ambient temperature ($^{\circ}\text{C}$): 21.5, Liquid temperature ($^{\circ}\text{C}$): 21.0

Satimo Configuration:

- Probe: EP165; Calibrated: 01/31/2013
- Sensor-Surface: 4mm (Mechanical Surface Detection)
- Phantom: Flat Phantom; Type: Elliptical Phantom
- Measurement SW: OpenSAR V4_02_0

Configuration/CW 300 for Low head/Area Scan (6x8x1): Measurement grid: dx=20mm, dy=20mm
Configuration/CW 300 for Low head/Zoom Scan (5x5x7)/Cube 0: Measurement grid: dx=8mm, dy=8mm,dz=5mm;

Area Scan	ep_direct_droit2_surf8mm.txt
ZoomScan	5x5x7,dx=8mm dy=8mm dz=5mm,Very fast
Phantom	Elliptical Phantom
Device Position	Face up 2.5 cm separation to Phantom
Band	CW 300
Channels	Low
Signal	Crest factor: 1

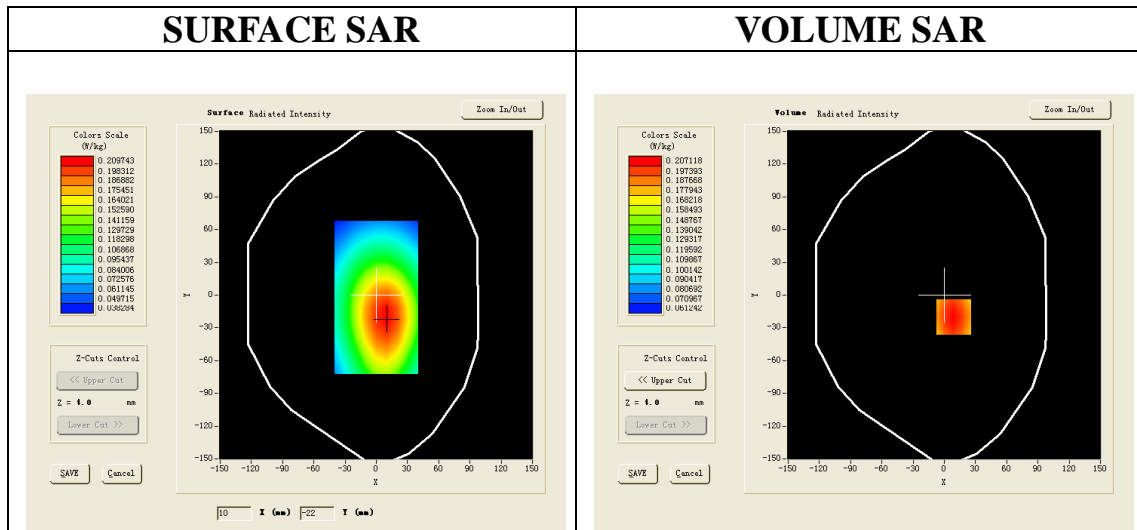

Maximum location: X=9.00, Y=-20.00

SAR 10g (W/Kg)	0.161041
SAR 1g (W/Kg)	0.216261

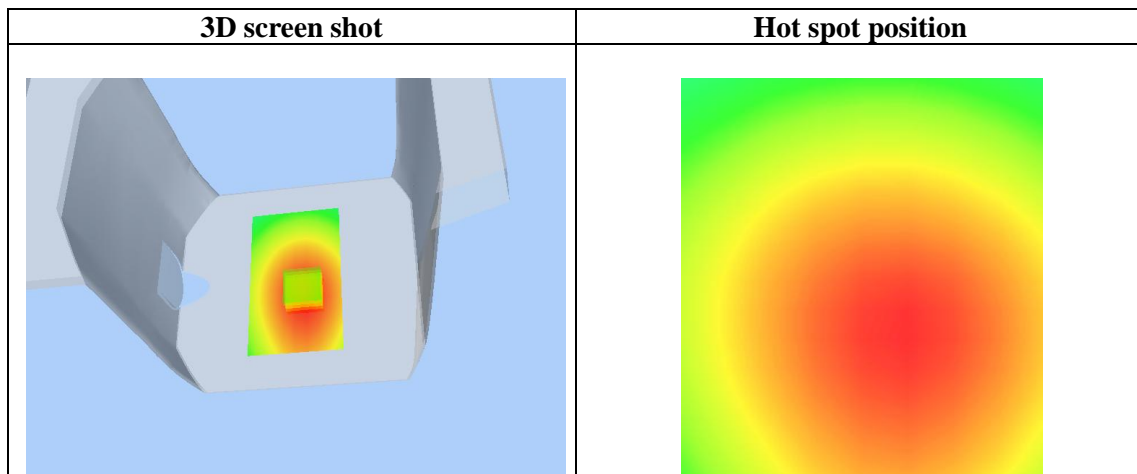
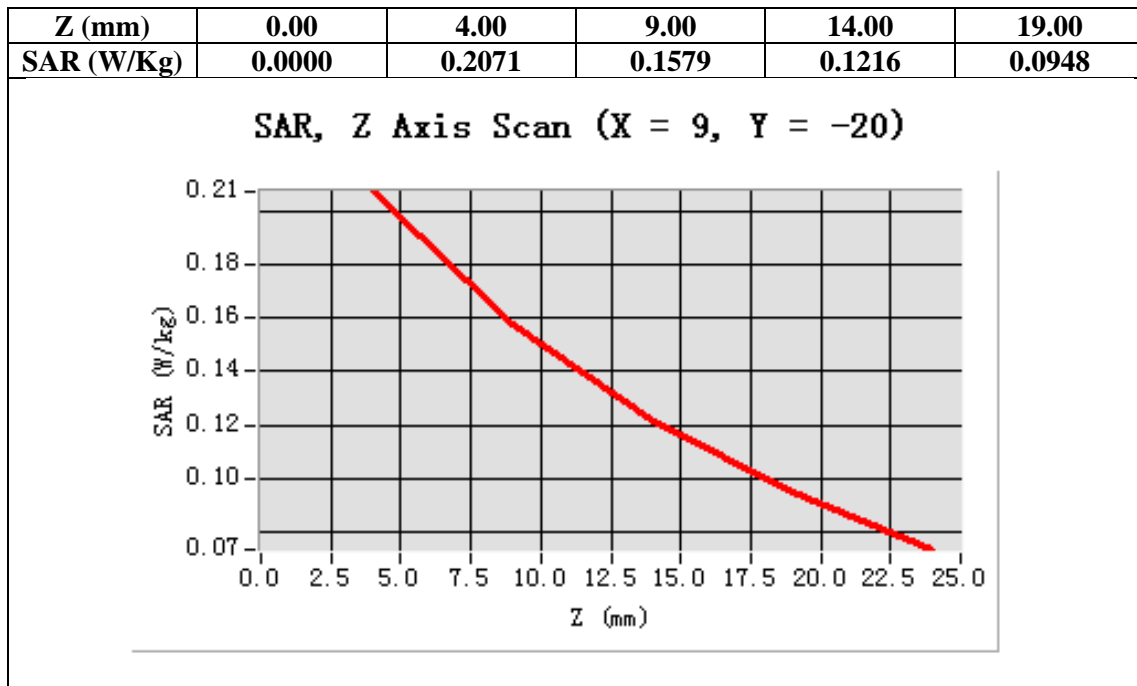

Test Laboratory: AGC Lab
CW300Mid- face up 2.5cm (12.5 KHz)
DUT: TWO WAY RADIO; Type: 289

Date: May 28, 2013

Communication System: CW; Communication System Band: CW 300MHz; Duty Cycle: 1:1; Conv.F=4.58
Frequency:155.000 MHz; Medium parameters used: $f = 300\text{MHz}$; $\sigma=0.86 \text{ mho/m}$; $\epsilon_r =46.70$; $\rho= 1000 \text{ kg/m}^3$;
Phantom Type: Elliptical Phantom
Ambient temperature ($^{\circ}\text{C}$): 21.5, Liquid temperature ($^{\circ}\text{C}$): 21.0

Satimo Configuration:

- Probe: EP165; Calibrated: 01/31/2013
- Sensor-Surface: 4mm (Mechanical Surface Detection)
- Phantom: Flat Phantom; Type: Elliptical Phantom
- Measurement SW: OpenSAR V4_02_0

Configuration/CW 300 for Mid head/Area Scan (6x8x1): Measurement grid: dx=20mm, dy=20mm
Configuration/CW 300 for Mid head/Zoom Scan (5x5x7)/Cube 0: Measurement grid: dx=8mm, dy=8mm,dz=5mm;

Area Scan	ep_direct_droit2_surf8mm.txt
ZoomScan	5x5x7,dx=8mm dy=8mm dz=5mm,Very fast
Phantom	Elliptical Phantom
Device Position	Face up 2.5 cm separation to Phantom
Band	CW 300
Channels	Middle
Signal	Crest factor: 1

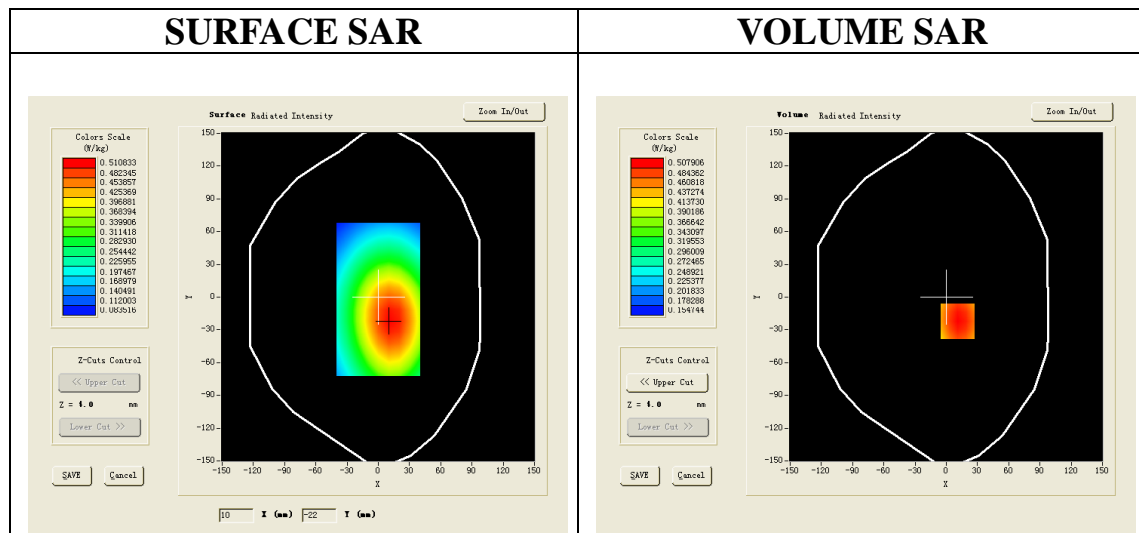

Maximum location: X=11.00, Y=-22.00

SAR 10g (W/Kg)	0.399295
SAR 1g (W/Kg)	0.531228

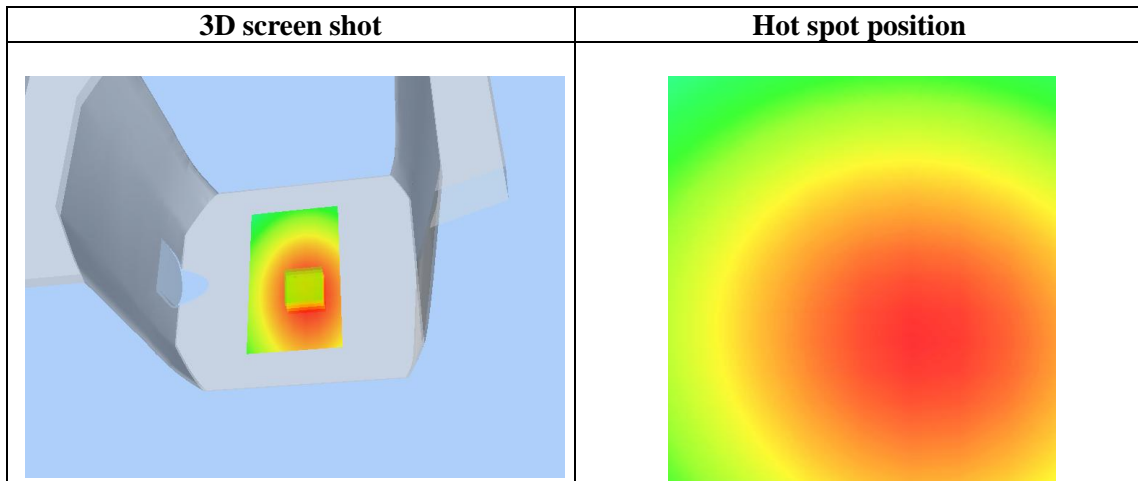
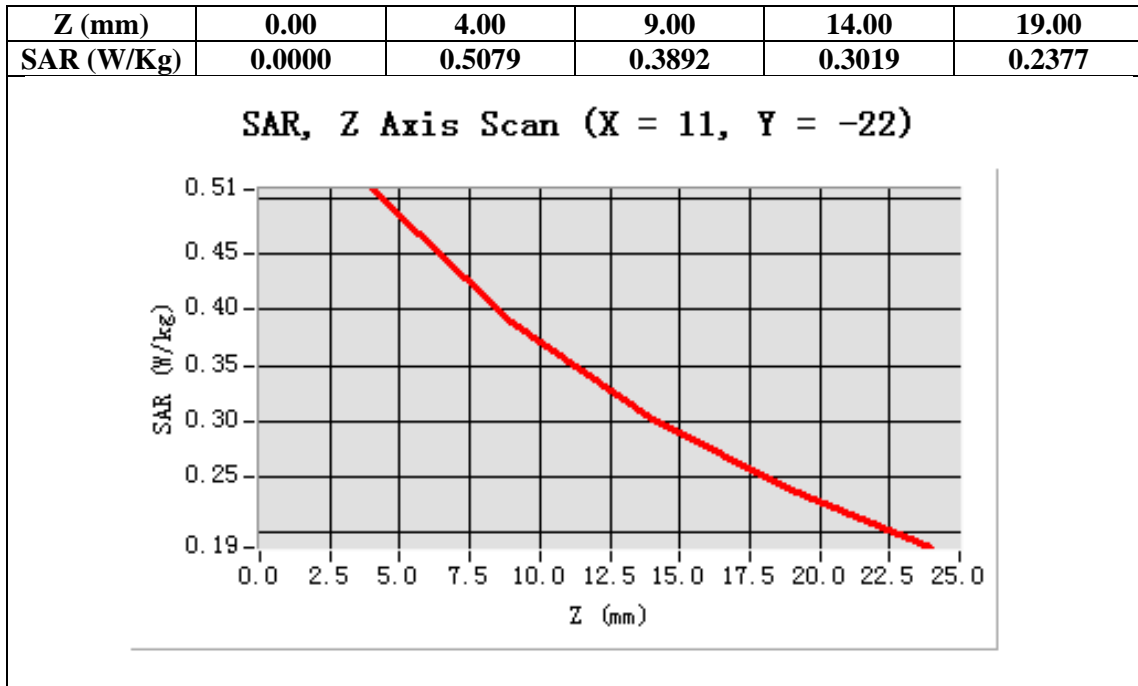

Test Laboratory: AGC Lab
CW300High- face up 2.5cm (12.5 KHz)
DUT: TWO WAY RADIO; Type: 289

Date: May 28, 2013

Communication System: CW; Communication System Band: CW 300MHz; Duty Cycle: 1:1; Conv.F=4.58
Frequency: 173.975MHz; Medium parameters used: $f = 300\text{MHz}$; $\sigma=0.86 \text{ mho/m}$; $\epsilon_r =46.70$; $\rho= 1000 \text{ kg/m}^3$;
Phantom Type: Elliptical Phantom
Ambient temperature ($^{\circ}\text{C}$): 21.5, Liquid temperature ($^{\circ}\text{C}$): 21.0

Satimo Configuration:

- Probe: EP165; Calibrated: 01/31/2013
- Sensor-Surface: 4mm (Mechanical Surface Detection)
- Phantom: Flat Phantom; Type: Elliptical Phantom
- Measurement SW: OpenSAR V4_02_0

Configuration/CW 300 for High head/Area Scan (6x8x1): Measurement grid: dx=20mm, dy=20mm
Configuration/CW 300 for High head/Zoom Scan (5x5x7)/Cube 0: Measurement grid: dx=8mm, dy=8mm,dz=5mm;

Area Scan	ep_direct_droit2_surf8mm.txt
ZoomScan	5x5x7,dx=8mm dy=8mm dz=5mm,Very fast
Phantom	Elliptical Phantom
Device Position	Face up 2.5 cm separation to Phantom
Band	CW 300
Channels	High
Signal	Crest factor: 1

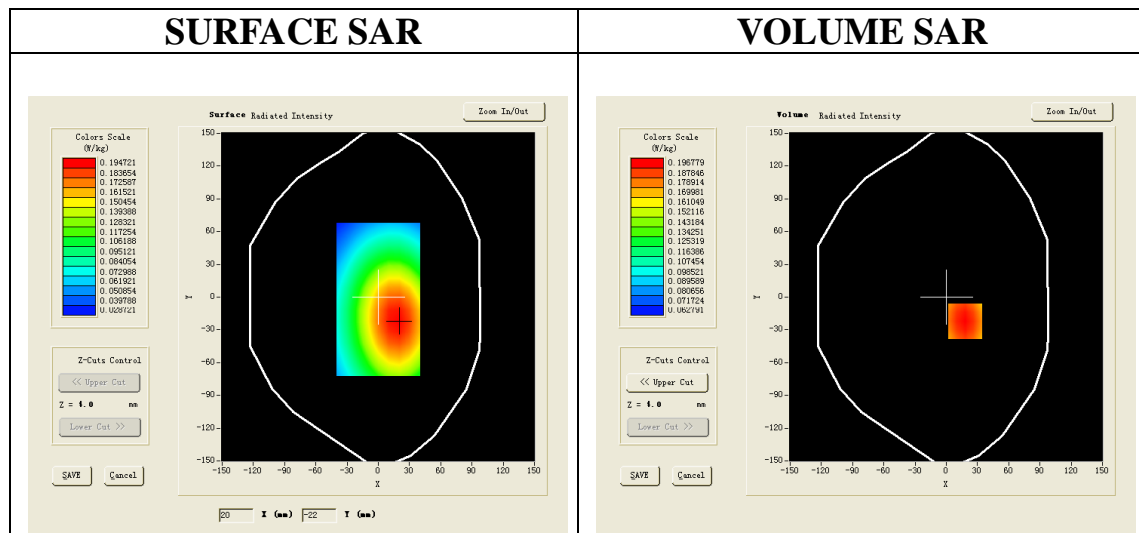

Maximum location: X=18.00, Y=-22.00

SAR 10g (W/Kg)	0.155923
SAR 1g (W/Kg)	0.205944

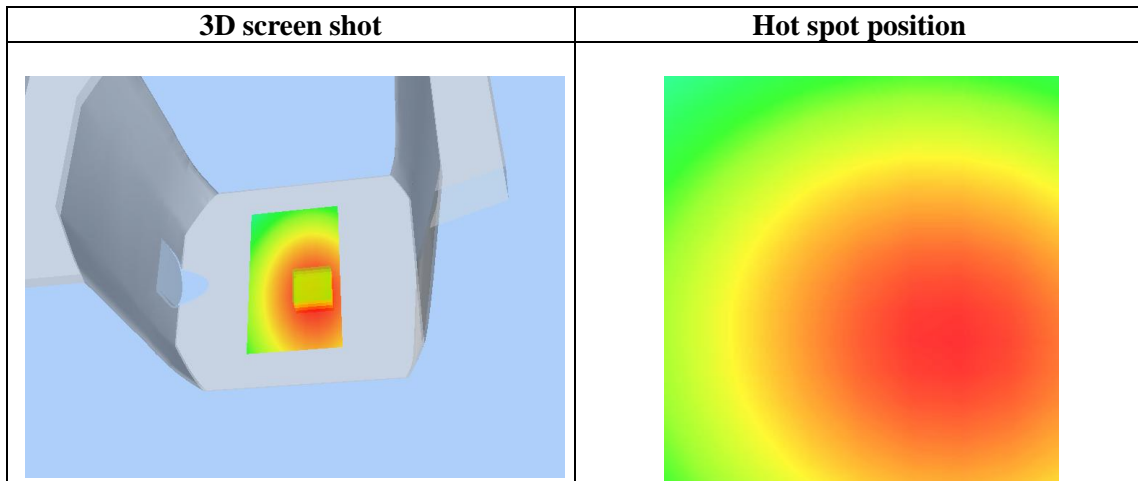
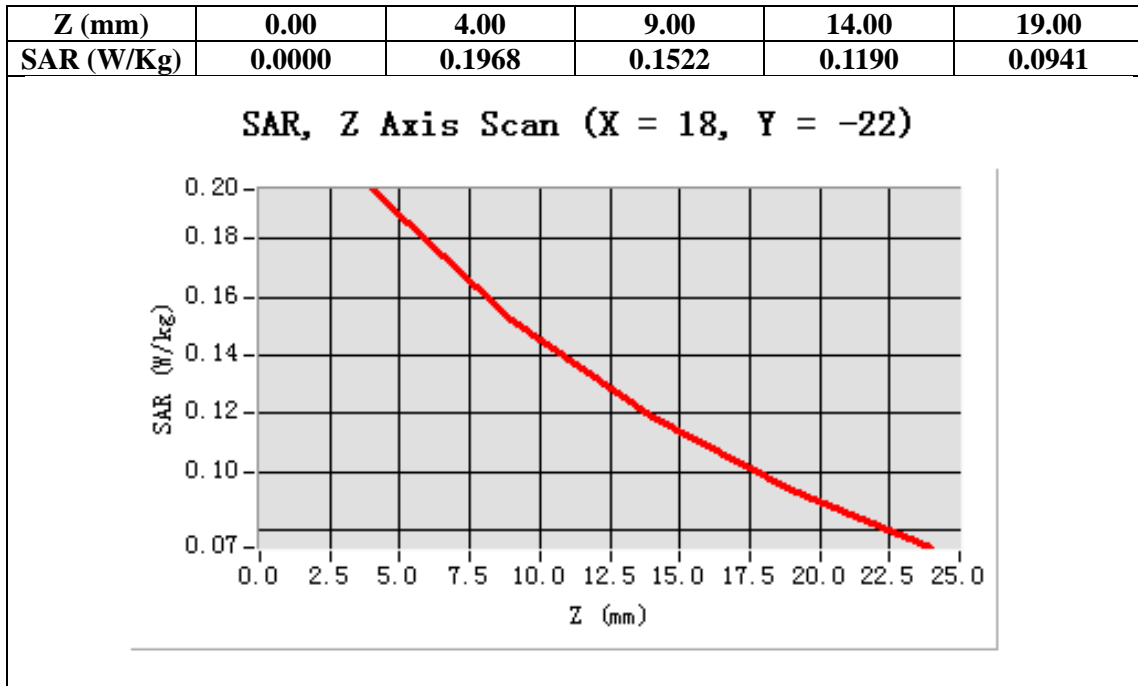

Test Laboratory: AGC Lab
CW300 Low -Body -Touch (12.5 KHz)
DUT: TWO WAY RADIO; Type: 289

Date: May 28, 2013

Communication System: CW; Communication System Band: CW 300.000 MHz; Duty Cycle: 1:1; Conv.F=4.58
Frequency:136.025MHz; Medium parameters used: $f = 300$ MHz; $\sigma=0.91$ mho/m; $\epsilon_r =45.79$; $\rho= 1000$ kg/m³ ;
Phantom Type: Elliptical Phantom
Ambient temperature (°C): 21.5, Liquid temperature(°C): 21.0

Satimo Configuration:

- Probe: EP165; Calibrated: 01/31/2013
- Sensor-Surface: 4mm (Mechanical Surface Detection)
- Phantom: Flat Phantom; Type: Elliptical Phantom
- Measurement SW: OpenSAR V4_02_0

Configuration/CW 300 for Low Touch/Area Scan: Measurement grid: dx=20mm, dy=20mm

Configuration/CW 300 for Low Touch/Zoom Scan: Measurement grid: dx=8mm, dy=8mm, dz=5mm,

Area Scan	ep_direct_droit2_surf8mm.txt
ZoomScan	5x5x7,dx=8mm dy=8mm dz=5mm,Very fast
Phantom	Elliptical Phantom
Device Position	Back close to Phantom with Accessories
Band	CW 300
Channels	Low
Signal	Crest factor: 1

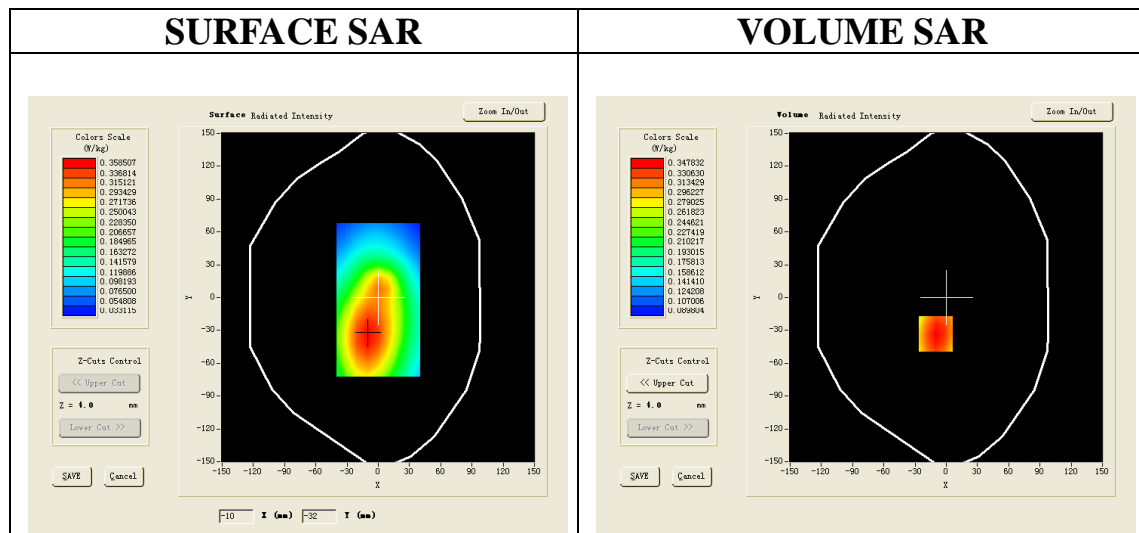

Maximum location: X=-10.00, Y=-33.00

SAR 10g (W/Kg)	0.265550
SAR 1g (W/Kg)	0.362856

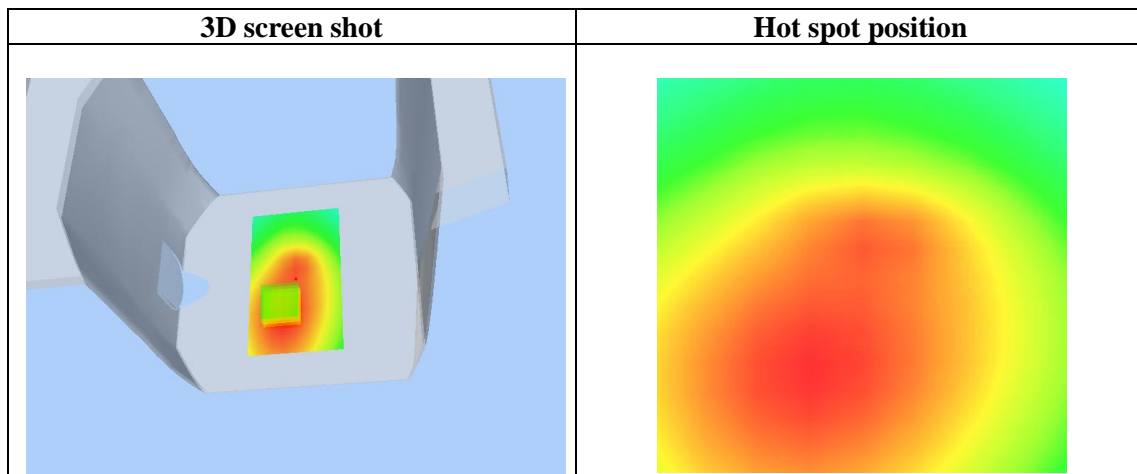
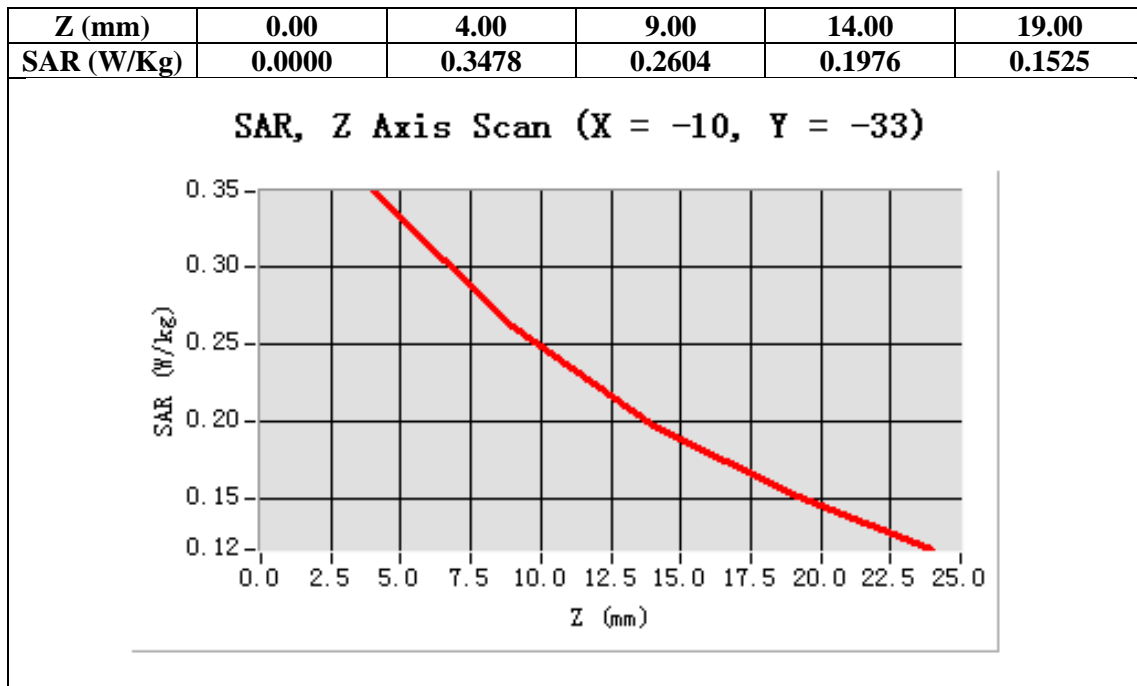

Test Laboratory: AGC Lab
CW300 Mid -Body –Touch (12.5 KHz)
DUT: TWO WAY RADIO; Type: 289

Date: May 28, 2013

Communication System: CW; Communication System Band: CW 300.000 MHz; Duty Cycle: 1:1; Conv.F=4.58
Frequency:155.000 MHz; Medium parameters used: $f = 300$ MHz; $\sigma=0.91$ mho/m; $\epsilon_r=45.79$; $\rho= 1000$ kg/m³ ;
Phantom Type: Elliptical Phantom
Ambient temperature (°C): 21.5, Liquid temperature(°C): 21.0

Satimo Configuration:

- Probe: EP165; Calibrated: 01/31/2013
- Sensor-Surface: 4mm (Mechanical Surface Detection)
- Phantom: Flat Phantom; Type: Elliptical Phantom
- Measurement SW: OpenSAR V4_02_0

Configuration/CW 300 for Mid Touch/Area Scan: Measurement grid: dx=20mm, dy=20mm

Configuration/CW 300 for Mid Touch/Zoom Scan: Measurement grid: dx=8mm, dy=8mm, dz=5mm,

Area Scan	ep_direct_droit2_surf8mm.txt
ZoomScan	5x5x7,dx=8mm dy=8mm dz=5mm,Very fast
Phantom	Elliptical Phantom
Device Position	Back close to Phantom with Accessories
Band	CW 300
Channels	Middle
Signal	Crest factor: 1

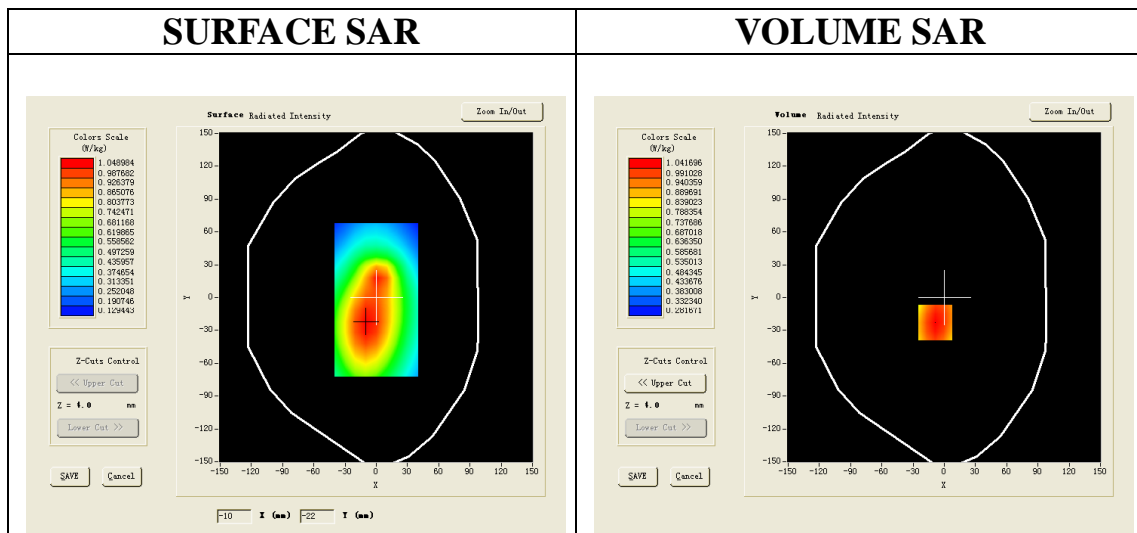

Maximum location: X=-9.00, Y=-23.00

SAR 10g (W/Kg)	0.801238
SAR 1g (W/Kg)	1.087240

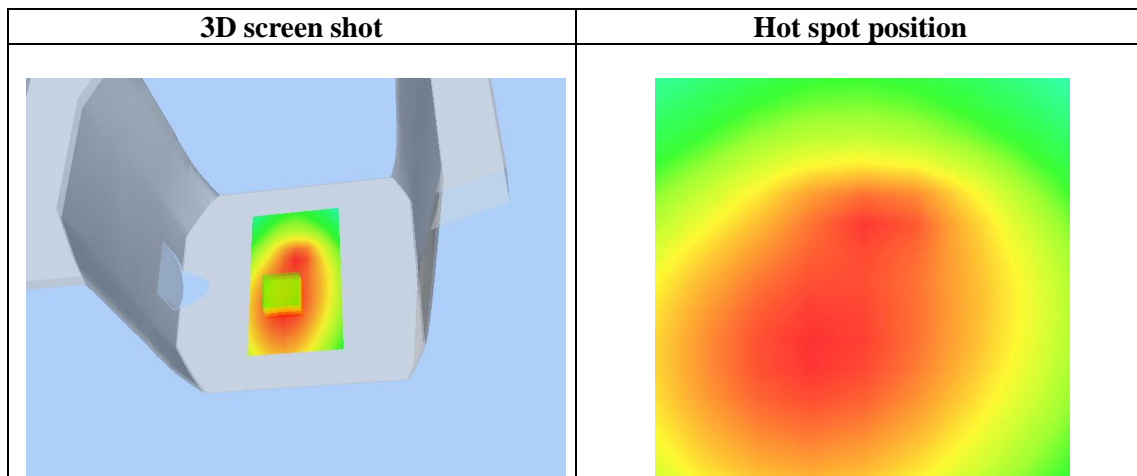
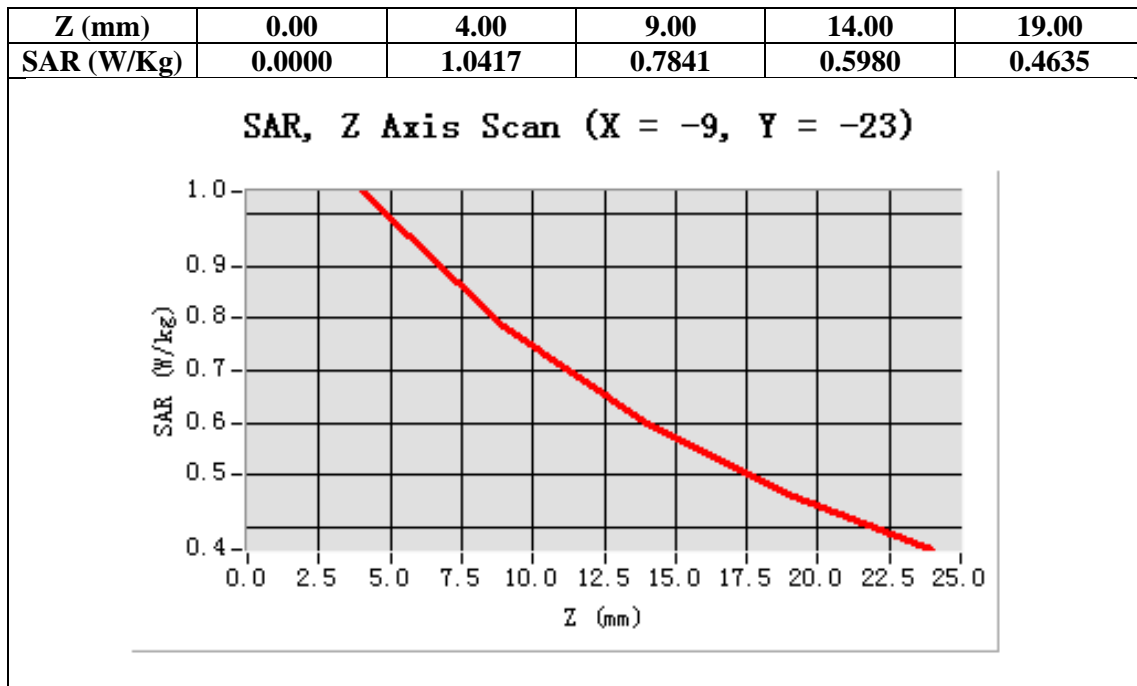

Test Laboratory: AGC Lab
CW300 High -Body –Touch (12.5 KHz)
DUT: TWO WAY RADIO; Type: 289

Date: May 28, 2013

Communication System: CW; Communication System Band: CW 300.000 MHz; Duty Cycle: 1:1; Conv.F=4.58
Frequency: 173.975MHz; Medium parameters used: $f = 300$ MHz; $\sigma=0.91$ mho/m; $\epsilon_r=45.79$; $\rho= 1000$ kg/m³ ;
Phantom Type: Elliptical Phantom
Ambient temperature (°C): 21.5, Liquid temperature(°C): 21.0

Satimo Configuration:

- Probe: EP165; Calibrated: 01/31/2013
- Sensor-Surface: 4mm (Mechanical Surface Detection)
- Phantom: Flat Phantom; Type: Elliptical Phantom
- Measurement SW: OpenSAR V4_02_0

Configuration/CW 300 for High Touch/Area Scan: Measurement grid: dx=20mm, dy=20mm

Configuration/CW 300 for High Touch/Zoom Scan: Measurement grid: dx=8mm, dy=8mm, dz=5mm,

Area Scan	ep_direct_droit2_surf8mm.txt
ZoomScan	5x5x7,dx=8mm dy=8mm dz=5mm,Very fast
Phantom	Elliptical Phantom
Device Position	Back close to Phantom with Accessories
Band	CW 300
Channels	High
Signal	Crest factor: 1

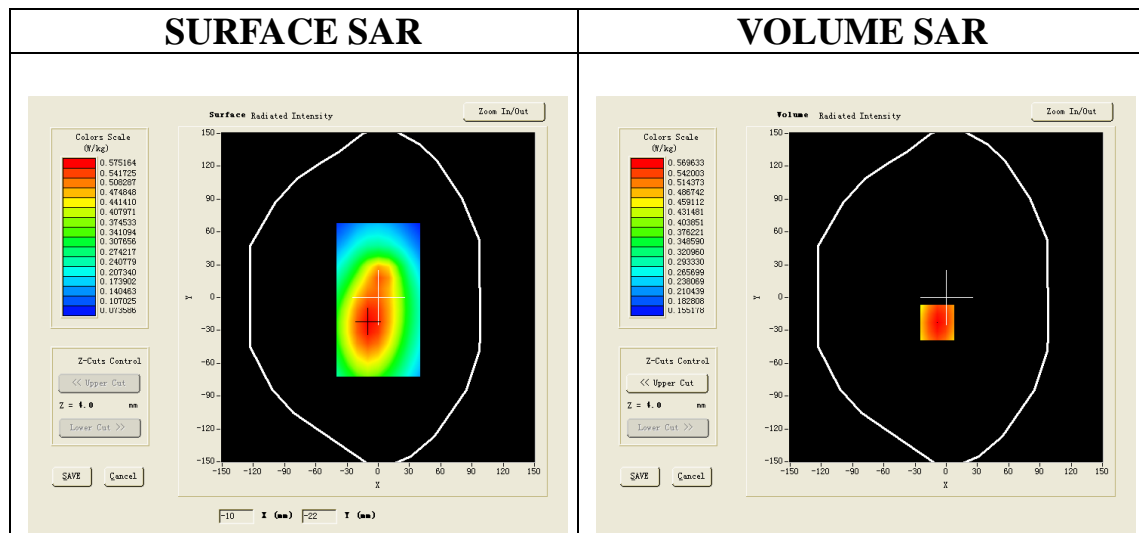

Maximum location: X=-9.00, Y=-23.00

SAR 10g (W/Kg)	0.438232
SAR 1g (W/Kg)	0.594497

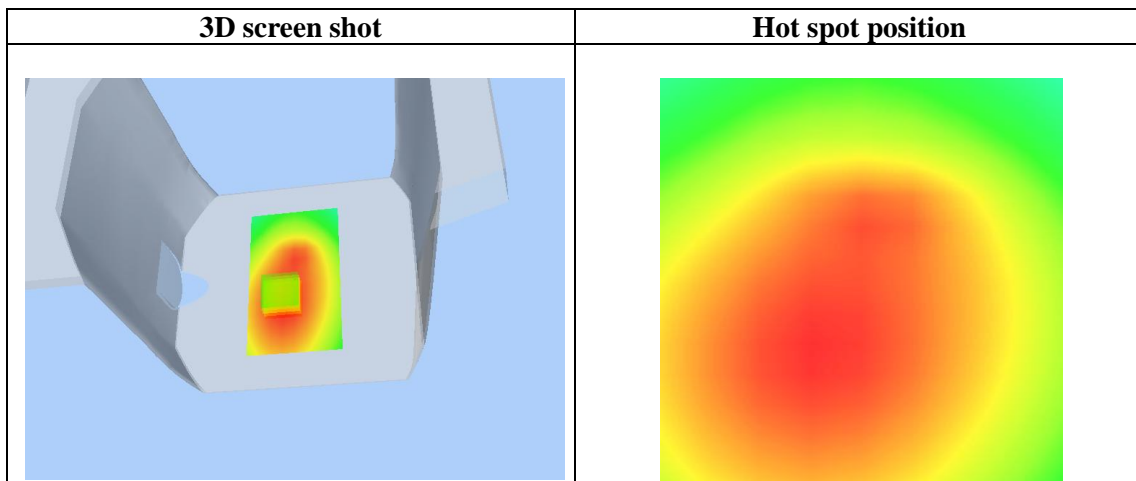
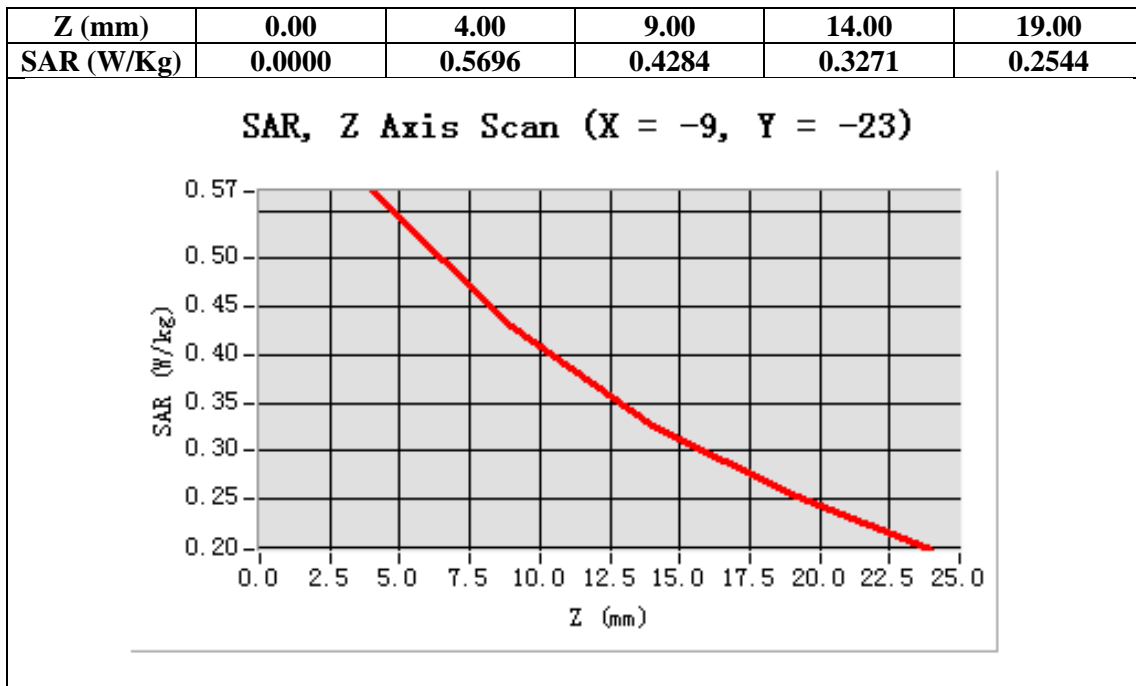

Appendix C. TEST SETUP PHOTOGRAPHS & EUT PHOTOGRAPHS

Test Setup Photographs

Body Front 15mm



Body back with Headset



DEPTH OF THE LIQUID IN THE PHANTOM—ZOOM IN

Note : The position used in the measurement were according to IEEE 1528-2003



EUT PHOTOGRAPHS
ALL VIEW OF EUT



TOP VIEW OF EUT



BOTTOM VIEW OF EUT



FRONT VIEW OF EUT



BACK VIEW OF EUT



LEFT VIEW OF EUT



RIGHT VIEW OF EUT



OPEN VIEW OF EUT-1



OPEN VIEW OF EUT-2



INTERNAL VIEW OF EUT-1

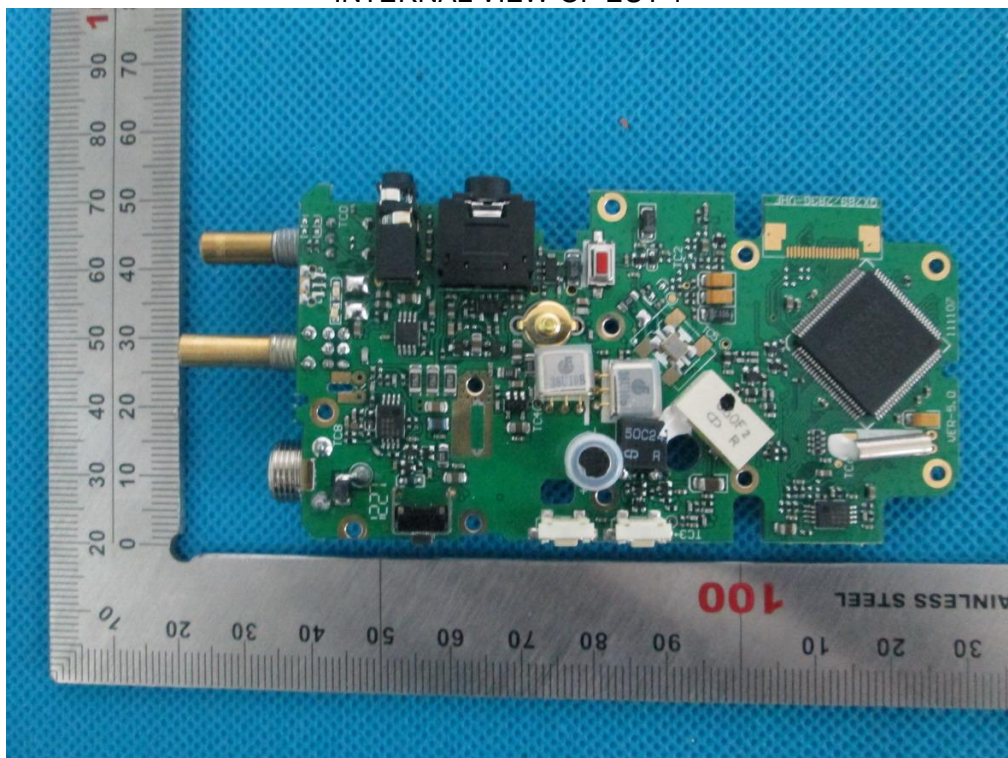

INTERNAL VIEW OF EUT-2

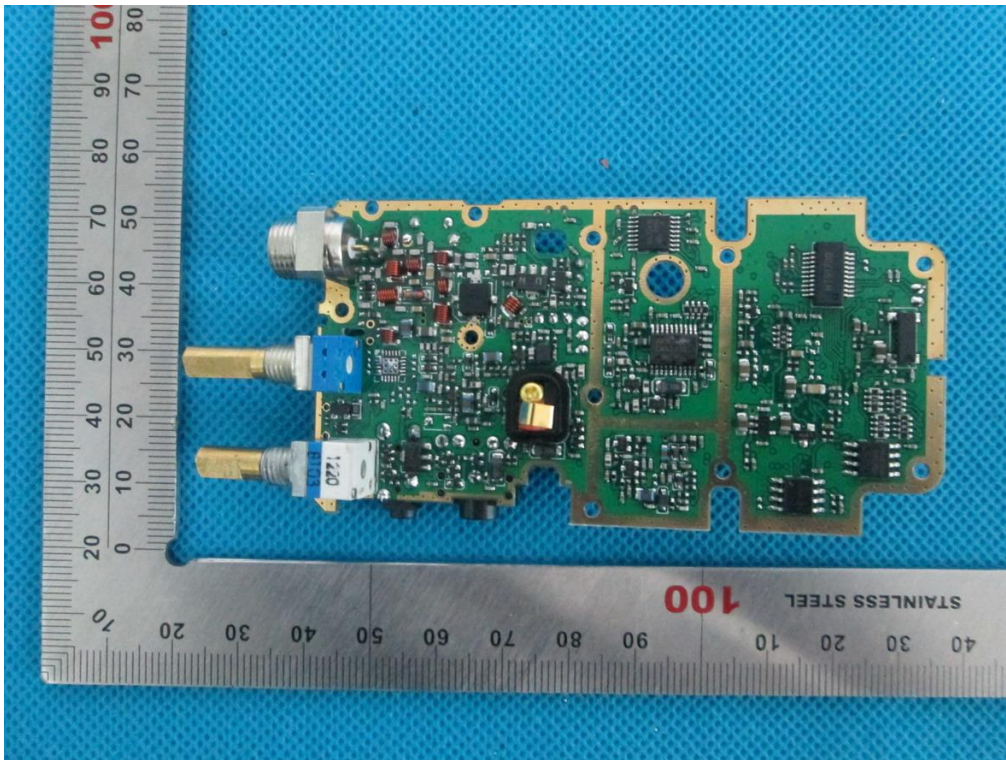

Appendix D. Probe Calibration Data



COMOSAR E-Field Probe Calibration Report

Ref : ACR.31.1.13.SATU.A

**ATTESTATION OF GLOBAL COMPLIANCE CO.
LTD.**

**1&2F, NO.2 BUILDING, HUAFENG NO.1 INDUSTRIAL
PARK, GUSHU COMMUNITY XIXIANG STREET
BAOAN DISTRICT, SHENZHEN, P.R. CHINA**

SATIMO COMOSAR DOSIMETRIC E-FIELD PROBE

SERIAL NO.: SN 04/13 EP165

**Calibrated at SATIMO US
2105 Barrett Park Dr. - Kennesaw, GA 30144**



01/31/13

Summary:

This document presents the method and results from an accredited COMOSAR Dosimetric E-Field Probe calibration performed in SATIMO USA using the CALISAR / CALIBAIR test bench, for use with a SATIMO COMOSAR system only. All calibration results are traceable to national metrology institutions.



	<i>Name</i>	<i>Function</i>	<i>Date</i>	<i>Signature</i>
<i>Prepared by :</i>	Jérôme LUC	Product Manager	1/31/2013	<i>JS</i>
<i>Checked by :</i>	Jérôme LUC	Product Manager	1/31/2013	<i>JS</i>
<i>Approved by :</i>	Kim RUTKOWSKI	Quality Manager	1/31/2013	<i>Kim Rutkowski</i>

	<i>Customer Name</i>
<i>Distribution :</i>	ATTESTATION OF GLOBAL COMPLIANCE CO. LTD.

<i>Issue</i>	<i>Date</i>	<i>Modifications</i>
A	1/31/2013	Initial release



TABLE OF CONTENTS

1	Device Under Test	4
2	Product Description.....	4
2.1	General Information	4
3	Measurement Method.....	4
3.1	Linearity	4
3.2	Sensitivity	5
3.3	Lower Detection Limit	5
3.4	Isotropy	5
3.5	Boundary Effect	5
4	Measurement Uncertainty	5
5	Calibration Measurement Results	6
5.1	Sensitivity in air	6
5.2	Linearity	7
5.3	Sensitivity in liquid	7
5.4	Isotropy	8
6	List of Equipment	10



1 DEVICE UNDER TEST

Device Under Test	
Device Type	COMOSAR DOSIMETRIC E FIELD PROBE
Manufacturer	Satimo
Model	SSE5
Serial Number	SN 04/13 EP165
Product Condition (new / used)	new
Frequency Range of Probe	0.03 GHz-3GHz
Resistance of Three Dipoles at Connector	Dipole 1: R1=0.239 MΩ Dipole 2: R2=0.224 MΩ Dipole 3: R3=0.223 MΩ

A yearly calibration interval is recommended.

2 PRODUCT DESCRIPTION

2.1 GENERAL INFORMATION

Satimo’s COMOSAR E field Probes are built in accordance to the IEEE 1528, OET 65 Bulletin C and CEI/IEC 62209 standards.



Figure 1 – Satimo COMOSAR Dosimetric E field Dipole

Probe Length	330 mm
Length of Individual Dipoles	4.5 mm
Maximum external diameter	8 mm
Probe Tip External Diameter	5 mm
Distance between dipoles / probe extremity	2.7 mm

3 MEASUREMENT METHOD

The IEEE 1528, OET 65 Bulletin C, CENELEC EN50361 and CEI/IEC 62209 standards provide recommended practices for the probe calibrations, including the performance characteristics of interest and methods by which to assess their affect. All calibrations / measurements performed meet the fore mentioned standards.

3.1 LINEARITY

The evaluation of the linearity was done in free space using the waveguide, performing a power sweep to cover the SAR range 0.01W/kg to 100W/kg.



3.2 SENSITIVITY

The sensitivity factors of the three dipoles were determined using a two step calibration method (air and tissue simulating liquid) using waveguides as outlined in the standards.

3.3 LOWER DETECTION LIMIT

The lower detection limit was assessed using the same measurement set up as used for the linearity measurement. The required lower detection limit is 10 mW/kg.

3.4 ISOTROPY

The axial isotropy was evaluated by exposing the probe to a reference wave from a standard dipole with the dipole mounted under the flat phantom in the test configuration suggested for system validations and checks. The probe was rotated along its main axis from 0 - 360 degrees in 15 degree steps. The hemispherical isotropy is determined by inserting the probe in a thin plastic box filled with tissue-equivalent liquid, with the plastic box illuminated with the fields from a half wave dipole. The dipole is rotated about its axis (0°-180°) in 15° increments. At each step the probe is rotated about its axis (0°-360°).

3.5 BOUNDARY EFFECT

The boundary effect is defined as the deviation between the SAR measured data and the expected exponential decay in the liquid when the probe is oriented normal to the interface. To evaluate this effect, the liquid filled flat phantom is exposed to fields from either a reference dipole or waveguide. With the probe normal to the phantom surface, the peak spatial average SAR is measured and compared to the analytical value at the surface.

4 MEASUREMENT UNCERTAINTY

The guidelines outlined in the IEEE 1528, OET 65 Bulletin C, CENELEC EN50361 and CEI/IEC 62209 standards were followed to generate the measurement uncertainty associated with an E-field probe calibration using the waveguide technique. All uncertainties listed below represent an expanded uncertainty expressed at approximately the 95% confidence level using a coverage factor of k=2, traceable to the Internationally Accepted Guides to Measurement Uncertainty.

Uncertainty analysis of the probe calibration in waveguide					
ERROR SOURCES	Uncertainty value (%)	Probability Distribution	Divisor	ci	Standard Uncertainty (%)
Incident or forward power	3.00%	Rectangular	$\sqrt{3}$	1	1.732%
Reflected power	3.00%	Rectangular	$\sqrt{3}$	1	1.732%
Liquid conductivity	5.00%	Rectangular	$\sqrt{3}$	1	2.887%
Liquid permittivity	4.00%	Rectangular	$\sqrt{3}$	1	2.309%
Field homogeneity	3.00%	Rectangular	$\sqrt{3}$	1	1.732%
Field probe positioning	5.00%	Rectangular	$\sqrt{3}$	1	2.887%
Field probe linearity	3.00%	Rectangular	$\sqrt{3}$	1	1.732%



Combined standard uncertainty					5.831%
Expanded uncertainty 95 % confidence level k = 2					11.662%

5 CALIBRATION MEASUREMENT RESULTS

Calibration Parameters	
Liquid Temperature	21 °C
Lab Temperature	21 °C
Lab Humidity	45 %

5.1 SENSITIVITY IN AIR

Normx dipole 1 ($\mu\text{V}/(\text{V}/\text{m})^2$)	Normy dipole 2 ($\mu\text{V}/(\text{V}/\text{m})^2$)	Normz dipole 3 ($\mu\text{V}/(\text{V}/\text{m})^2$)
5.66	5.98	5.64

DCP dipole 1 (mV)	DCP dipole 2 (mV)	DCP dipole 3 (mV)
94	90	90

Calibration curves $e_i=f(V)$ ($i=1,2,3$) allow to obtain H-field value using the formula:

$$E = \sqrt{E_1^2 + E_2^2 + E_3^2}$$

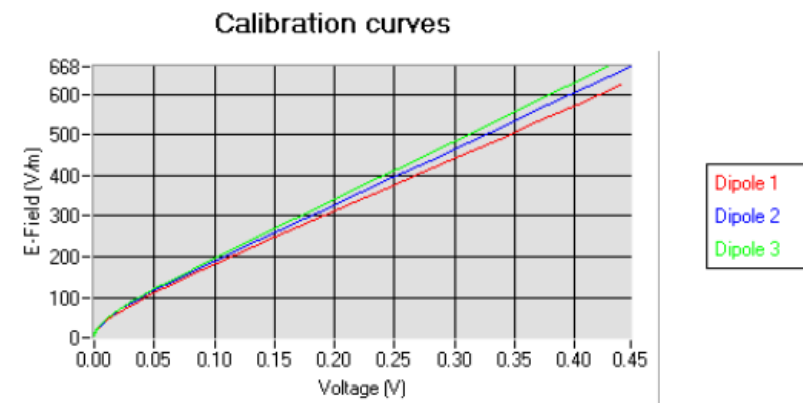



5.2 LINEARITY

Linearity

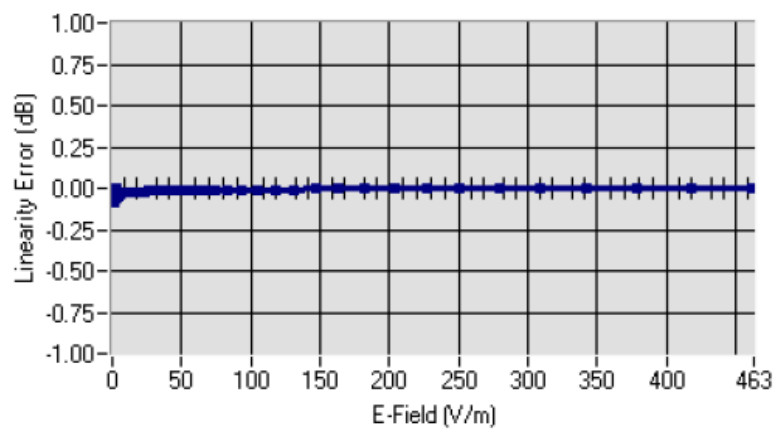

Linearity: $\pm 1.97\%$ ($\pm 0.09\text{dB}$)

5.3 SENSITIVITY IN LIQUID

Liquid	Frequency (MHz +/- 100MHz)*	Permittivity	Epsilon (S/m)	ConvF
HL150	150	50.12	0.77	4.36
BL150	150	60.56	0.79	4.56
HL300	300	44.75	0.84	4.58
BL300	300	57.99	0.93	4.70
HL450	450	42.08	0.90	4.75
BL450	450	57.63	0.96	4.89
HL850	835	40.96	0.90	5.30
BL850	835	54.22	0.98	5.46
HL900	900	39.90	0.97	5.16
BL900	900	55.99	1.06	5.29
HL1800	1750	38.96	1.37	4.54
BL1800	1750	52.34	1.51	4.66
HL1900	1880	38.67	1.40	4.72
BL1900	1880	52.12	1.52	4.84
HL2000	1950	38.97	1.43	4.24
BL2000	1950	54.01	1.54	4.39
HL2450	2450	37.97	1.83	4.19
BL2450	2450	53.04	1.96	4.32

* MHz +/- 50MHz for frequency below 300MHz

LOWER DETECTION LIMIT: 9mW/kg



5.4 ISOTROPY

HL900 MHz

- Axial isotropy: 0.04 dB
- Hemispherical isotropy: 0.07 dB

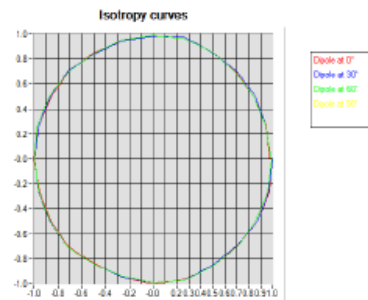

HL1800 MHz

- Axial isotropy: 0.08 dB
- Hemispherical isotropy: 0.11 dB

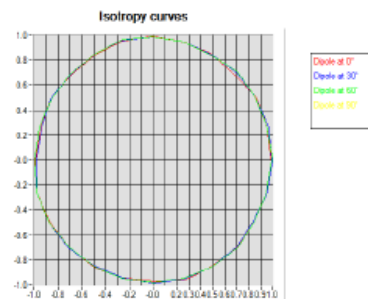



HL2450 MHz

- Axial isotropy: 0.09 dB
- Hemispherical isotropy: 0.13 dB

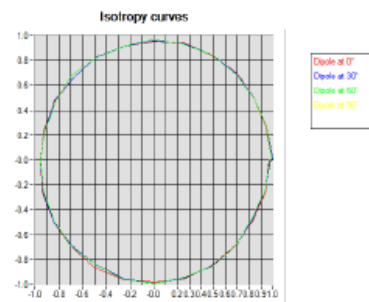



6 LIST OF EQUIPMENT

Equipment Summary Sheet				
Equipment Description	Manufacturer / Model	Identification No.	Current Calibration Date	Next Calibration Date
Flat Phantom	Satimo	SN-20/09-SAM71	Validated. No cal required.	Validated. No cal required.
COMOSAR Test Bench	Version 3	NA	Validated. No cal required.	Validated. No cal required.
Network Analyzer	Rhode & Schwarz ZVA	SN100132	02/2010	02/2013
Reference Probe	Satimo	EP 94 SN 37/08	Characterized prior to test. No cal required.	Characterized prior to test. No cal required.
Multimeter	Keithley 2000	1188656	11/2010	11/2013
Signal Generator	Agilent E4438C	MY49070581	12/2010	12/2013
Amplifier	Aethercomm	SN 046	Characterized prior to test. No cal required.	Characterized prior to test. No cal required.
Power Meter	HP E4418A	US38261498	11/2010	11/2013
Power Sensor	HP ECP-E26A	US37181460	11/2010	11/2013
Directional Coupler	Narda 4216-20	01386	Characterized prior to test. No cal required.	Characterized prior to test. No cal required.
Waveguide	Mega Industries	069Y7-158-13-712	Validated. No cal required.	Validated. No cal required.
Waveguide Transition	Mega Industries	069Y7-158-13-701	Validated. No cal required.	Validated. No cal required.
Waveguide Termination	Mega Industries	069Y7-158-13-701	Validated. No cal required.	Validated. No cal required.
Temperature / Humidity Sensor	Control Company	11-661-9	3/2012	3/2014

Appendix E. Dipole Calibration Data



SAR Reference Dipole Calibration Report

Ref : ACR.343.3.11.SATU.A

ATTESTATION OF GLOBAL COMPLIANCE CO. LTD.

**1&2F, NO.2 BUILDING, HUAFENG NO.1 INDUSTRIAL PARK, GUSHU
COMMUNITY XIXIANG STREET**

BAOAN DISTRICT, SHENZHEN, P.R. CHINA

SATIMO COMOSAR REFERENCE DIPOLE

FREQUENCY: 300 MHZ

SERIAL NO.: SN 46/11 DIP 0G300-183

Calibrated at SATIMO US

2105 Barrett Park Dr. - Kennesaw, GA 30144



12/09/11

Summary:

This document presents the method and results from an accredited SAR reference dipole calibration performed in SATIMO USA using the COMOSAR test bench. All calibration results are traceable to national metrology institutions.



SAR REFERENCE DIPOLE CALIBRATION REPORT

Ref: ACR.343.3.11.SATU.A

	<i>Name</i>	<i>Function</i>	<i>Date</i>	<i>Signature</i>
<i>Prepared by :</i>	Jérôme LUC	Product Manager	12/9/2011	<i>JS</i>
<i>Checked by :</i>	Jérôme LUC	Product Manager	12/9/2011	<i>JS</i>
<i>Approved by :</i>	Kim RUTKOWSKI	Quality Manager	12/9/2011	<i>Kim Rutkowski</i>

	<i>Customer Name</i>
<i>Distribution :</i>	ATTESTATION OF GLOBAL COMPLIANCE CO. LTD.

<i>Issue</i>	<i>Date</i>	<i>Modifications</i>
A	12/9/2011	Initial release



TABLE OF CONTENTS

1 Introduction.....4

2 Device Under Test4

3 Product Description4

 3.1 General Information4

4 Measurement Method5

 4.1 Return Loss Requirements5

 4.2 Mechanical Requirements5

5 Measurement Uncertainty5

 5.1 Return Loss5

 5.2 Dimension Measurement5

 5.3 Validation Measurement5

6 Calibration Measurement Results6

 6.1 Return Loss6

 6.2 Mechanical Dimensions6

7 Validation measurement7

 7.1 Measurement Condition7

 7.2 Head Liquid Measurement7

 7.3 Measurement Result8

8 List of Equipment8



1 INTRODUCTION

This document contains a summary of the requirements set forth by the IEEE 1528, OET 65 Bulletin C and CEI/IEC 62209 standards for reference dipoles used for SAR measurement system validations and the measurements that were performed to verify that the product complies with the fore mentioned standards.

2 DEVICE UNDER TEST

Device Under Test	
Device Type	COMOSAR 300 MHz REFERENCE DIPOLE
Manufacturer	Satimo
Model	SID300
Serial Number	SN 46/11 DIP 0G300-183
Product Condition (new / used)	new

A yearly calibration interval is recommended.

3 PRODUCT DESCRIPTION

3.1 GENERAL INFORMATION

Satimo's COMOSAR Validation Dipoles are built in accordance to the IEEE 1528, OET 65 Bulletin C and CEI/IEC 62209 standards. The product is designed for use with the COMOSAR test bench only.



Figure 1 – Satimo COMOSAR Validation Dipole



4 MEASUREMENT METHOD

The IEEE 1528, OET 65 Bulletin C and CEI/IEC 62209 standards provide requirements for reference dipoles used for system validation measurements. The following measurements were performed to verify that the product complies with the fore mentioned standards.

4.1 RETURN LOSS REQUIREMENTS

The dipole used for SAR system validation measurements and checks must have a return loss of -20 dB or better. The return loss measurement shall be performed against a liquid filled flat phantom, with the phantom constructed as outlined in the fore mentioned standards.

4.2 MECHANICAL REQUIREMENTS

The IEEE Std. 1528 and CEI/IEC 62209 standards specify the mechanical components and dimensions of the validation dipoles, with the dimensions frequency and phantom shell thickness dependent. The COMOSAR test bench employs a 2 mm phantom shell thickness therefore the dipoles sold for use with the COMOSAR test bench comply with the requirements set forth for a 2 mm phantom shell thickness.

5 MEASUREMENT UNCERTAINTY

All uncertainties listed below represent an expanded uncertainty expressed at approximately the 95% confidence level using a coverage factor of k=2, traceable to the Internationally Accepted Guides to Measurement Uncertainty.

5.1 RETURN LOSS

The following uncertainties apply to the return loss measurement:

Frequency band	Expanded Uncertainty on Return Loss
400-6000MHz	0.1 dB

5.2 DIMENSION MEASUREMENT

The following uncertainties apply to the dimension measurements:

Length (mm)	Expanded Uncertainty on Length
3 - 300	0.05 mm

5.3 VALIDATION MEASUREMENT

The guidelines outlined in the IEEE 1528, OET 65 Bulletin C, CENELEC EN50361 and CEI/IEC 62209 standards were followed to generate the measurement uncertainty for validation measurements.

Scan Volume	Expanded Uncertainty
1 g	16.19 %
10 g	15.86 %



6 CALIBRATION MEASUREMENT RESULTS

6.1 RETURN LOSS

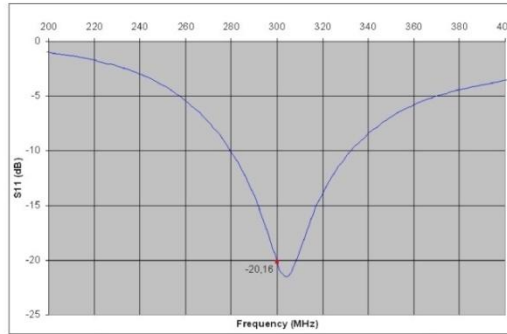

Frequency (MHz)	Return Loss (dB)	Requirement (dB)
300	-20.16	-20

6.2 MECHANICAL DIMENSIONS

Frequency MHz	L mm		h mm		d mm	
	required	measured	required	measured	required	measured
300	420.0 ±1 %	PASS	250.0 ±1 %	PASS	6.35 ±1 %	PASS
450	290.0 ±1 %		166.7 ±1 %		6.35 ±1 %	
750	176.0 ±1 %		100.0 ±1 %		6.35 ±1 %	
835	161.0 ±1 %		89.8 ±1 %		3.6 ±1 %	
900	149.0 ±1 %		83.3 ±1 %		3.6 ±1 %	
1450	89.1 ±1 %		51.7 ±1 %		3.6 ±1 %	
1500	80.5 ±1 %		50.0 ±1 %		3.6 ±1 %	
1640	79.0 ±1 %		45.7 ±1 %		3.6 ±1 %	
1750	75.2 ±1 %		42.9 ±1 %		3.6 ±1 %	
1800	72.0 ±1 %		41.7 ±1 %		3.6 ±1 %	
1900	68.0 ±1 %		39.5 ±1 %		3.6 ±1 %	
1950	66.3 ±1 %		38.5 ±1 %		3.6 ±1 %	
2000	64.5 ±1 %		37.5 ±1 %		3.6 ±1 %	
2100	61.0 ±1 %		35.7 ±1 %		3.6 ±1 %	
2300	55.5 ±1 %		32.6 ±1 %		3.6 ±1 %	
2450	51.5 ±1 %		30.4 ±1 %		3.6 ±1 %	
2600	48.5 ±1 %		28.8 ±1 %		3.6 ±1 %	
3000	41.5 ±1 %		25.0 ±1 %		3.6 ±1 %	
3500	37.0 ±1 %		26.4 ±1 %		3.6 ±1 %	
3700	34.7 ±1 %		26.4 ±1 %		3.6 ±1 %	



7 VALIDATION MEASUREMENT

The IEEE Std. 1528, OET 65 Bulletin C and CEI/IEC 62209 standards state that the system validation measurements must be performed using a reference dipole meeting the fore mentioned return loss and mechanical dimension requirements. The validation measurement must be performed against a liquid filled flat phantom, with the phantom constructed as outlined in the fore mentioned standards. Per the standards, the dipole shall be positioned below the bottom of the phantom, with the dipole length centered and parallel to the longest dimension of the flat phantom, with the top surface of the dipole at the described distance from the bottom surface of the phantom.

7.1 MEASUREMENT CONDITION

Software	OPENSAR V4
Phantom	SN 29/11 ELLI21
Probe	SN 18/11 EPG122
Liquid	Head Liquid Values: ϵ_r : 44.8 σ : 0.86
Distance between dipole center and liquid	15.0 mm
Area scan resolution	dx=8mm/dy=8mm
Zoon Scan Resolution	dx=8mm/dy=8m/dz=5mm
Frequency	300 MHz
Input power	30 dBm
Liquid Temperature	21 °C
Lab Temperature	21 °C
Lab Humidity	45 %

7.2 HEAD LIQUID MEASUREMENT

Frequency MHz	Relative permittivity (ϵ_r)		Conductivity (σ) S/m	
	required	measured	required	measured
300	45.3 ±5 %	PASS	0.87 ±5 %	PASS
450	43.5 ±5 %		0.87 ±5 %	
750	41.9 ±5 %		0.89 ±5 %	
835	41.5 ±5 %		0.90 ±5 %	
900	41.5 ±5 %		0.97 ±5 %	
1450	40.5 ±5 %		1.20 ±5 %	
1500	40.4 ±5 %		1.23 ±5 %	
1640	40.2 ±5 %		1.31 ±5 %	
1750	40.1 ±5 %		1.37 ±5 %	
1800	40.0 ±5 %		1.40 ±5 %	
1900	40.0 ±5 %		1.40 ±5 %	
1950	40.0 ±5 %		1.40 ±5 %	
2000	40.0 ±5 %		1.40 ±5 %	
2100	39.8 ±5 %		1.49 ±5 %	
2300	39.5 ±5 %		1.67 ±5 %	
2450	39.2 ±5 %		1.80 ±5 %	
2600	39.0 ±5 %		1.96 ±5 %	
3000	38.5 ±5 %		2.40 ±5 %	
3500	37.9 ±5 %		2.91 ±5 %	



7.3 MEASUREMENT RESULT

The IEEE Std. 1528 and CEI/IEC 62209 standards state that the system validation measurements should produce the SAR values shown below (for phantom thickness of 2 mm), within the uncertainty for the system validation. All SAR values are normalized to 1 W forward power. In bracket, the measured SAR is given with the used input power.

Frequency MHz	1 g SAR (W/kg/W)		10 g SAR (W/kg/W)	
	required	measured	required	measured
300	2.85	2.86 (2.86)	1.94	2.00 (2.00)
450	4.58		3.06	
750	8.49		5.55	
835	9.56		6.22	
900	10.9		6.99	
1450	29		16	
1500	30.5		16.8	
1640	34.2		18.4	
1750	36.4		19.3	
1800	38.4		20.1	
1900	39.7		20.5	
1950	40.5		20.9	
2000	41.1		21.1	
2100	43.6		21.9	
2300	48.7		23.3	
2450	52.4		24	
2600	55.3		24.6	
3000	63.8		25.7	
3500	67.1		25	

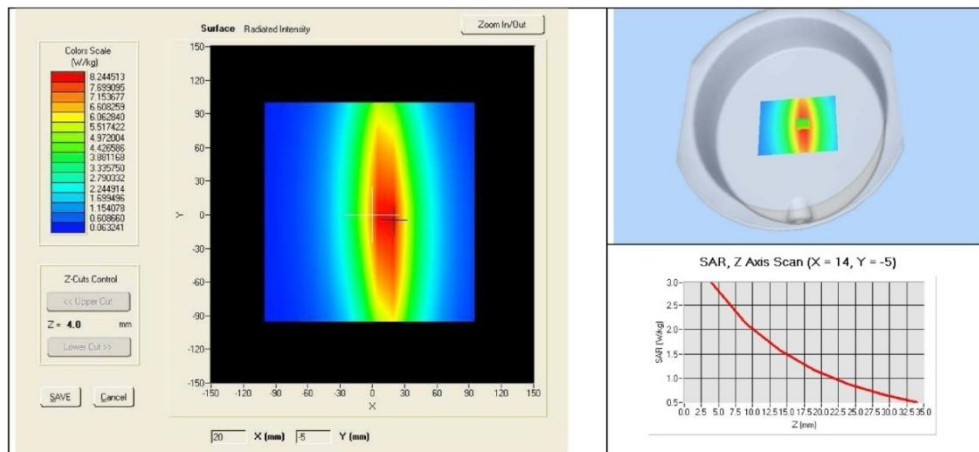



8 LIST OF EQUIPMENT

Equipment Summary Sheet				
Equipment Description	Manufacturer / Model	Identification No.	Current Calibration Date	Next Calibration Date
Flat Phantom	Satimo	SN-29/11-ELLI21	Validated. No cal required.	Validated. No cal required.
COMOSAR Test Bench	Version 3	NA	Validated. No cal required.	Validated. No cal required.
Network Analyzer	Rhode & Schwarz ZVA	SN100132	02/2010	02/2013
Calipers	Carrera	CALIPER-01	12/2010	12/2013
Reference Probe	Satimo	EPG122 SN 18/11	Characterized prior to test. No cal required.	Characterized prior to test. No cal required.
Multimeter	Keithley 2000	1188656	11/2010	11/2013
Signal Generator	Agilent E4438C	MY49070581	12/2010	12/2013
Amplifier	Aethercomm	SN 046	Characterized prior to test. No cal required.	Characterized prior to test. No cal required.
Power Meter	HP E4418A	US38261498	11/2010	11/2013
Power Sensor	HP ECP-E26A	US37181460	11/2010	11/2013
Directional Coupler	Narda 4216-20	01386	Characterized prior to test. No cal required.	Characterized prior to test. No cal required.
Temperature and Humidity Sensor	Control Company	11-661-9	3/2010	3/2012