FCC Test Report

Report No.: AGC00589160304FE01

FCC ID : T4K-UV8D
TYPE OF AUTHORIZATION : Certification
APPLICATION PURPOSE : Original Equipment
PRODUCT DESIGNATION : TWO WAY RADIO
BRAND NAME : Anytone
TEST MODEL : UV8 (Series model name please see page 4)
CLIENT : Qixiang Electron Science & Technology Co., Ltd. Quanzhou
DATE OF ISSUE : Mar.25, 2016
STANDARD(S) : FCC Part 15 Rules
REPORT VERSION : V 1.0

Attestation of Global Compliance (Shenzhen) Co., Ltd



CAUTION:

This report shall not be reproduced except in full without the written permission of the test laboratory and shall not be quoted out of context.



Report Revise Record

Report Version	Revise Time	Issued Date	Valid Version	Notes
V1.0	/	Mar.25, 2016	Valid	Original Report

TABLE OF CONTENTS

1. VERIFICATION OF COMPLIANCE	4
2. PRODUCT INFORMATION	5
3. TEST FACILITY	6
4. SUPPORT EQUIPMENT LIST	7
5. SYSTEM DESCRIPTION	7
6. SUMMARY OF TEST RESULTS	7
7. FCC LINE CONDUCTED EMISSION TEST	8
7.1. TEST EQUIPMENT OF LINE CONDUCTED EMISSION TEST	8
7.2 .LIMITS OF LINE CONDUCTED EMISSION TEST	8
7.3. BLOCK DIAGRAM OF LINE CONDUCTED EMISSION TEST	8
7.4. PROCEDURE OF LINE CONDUCTED EMISSION TEST	9
7.5 TEST RESULT OF LINE CONDUCTED EMISSION TEST	10
8. FCC RADIATED EMISSION TEST	12
8.1. TEST EQUIPMENT OF RADIATED EMISSION	12
8.2. LIMITS OF RADIATED EMISSION TEST	12
8.3 BLOCK DIAGRAM OF RADIATED EMISSION TEST.....	12
8.4 PROCEDURE OF RADIATED EMISSION TEST.....	13
8.5 TEST RESULT OF RADIATED EMISSION TEST	14
9. ANTENNA CONDUCTED POWER FOR RECEIVERS	16
APPENDIX 1:PHOTOGRAPHS OF TEST SETUP	21
APPENDIX 2:PHOTOGRAPHS OF EUT	23

1. VERIFICATION OF COMPLIANCE

Applicant	Qixiang Electron Science & Technology Co., Ltd. Quanzhou
Address	Qixiang Building, Tangxi Industrial Zone, Luojiang District, Quanzhou, Fujian, China
Manufacturer	Qixiang Electron Science & Technology Co., Ltd. Quanzhou
Address	Qixiang Building, Tangxi Industrial Zone, Luojiang District, Quanzhou, Fujian, China
Product Designation	TWO WAY RADIO
Brand name	Anytone
Test Model	UV8
Series Model	UV9, UV8A, UV8D, UV8E, UV9A, UV9D, UV9E, 3318UV, 398UV, 938UV, 318UV, 518UV, 3208UV, 298UV, 3318UVD, 398UVD, 298UVD
Model Difference	All the same except for the model name.
Hardware Version	V7.0
Software Version	N/A
Measurement Procedure	ANSI C63.4: 2009
Date of test	Mar.22, 2016 to Mar.23, 2016
Test Result	Pass

The above equipment was tested by Dong guan Precise Testing Service Co., Ltd and attested that this device compliance with the requirements set forth in the FCC Rules and Regulations Part 15, the measurement procedure according to ANSI C63.4:2009. This said equipment in the configuration described in this report shows the maximum emission levels emanating from equipment are within the compliance requirements.

The test results of this report relate only to the tested sample identified in this report.

Tested by

Steven Zhou

Steven Zhou(Zhou Pengyun) Mar.25, 2016

Reviewed by

Rock Huang

Rock Huang(Huang Dinglue) Mar.25, 2016

Approved by

Solger Zhang

Solger Zhang(Zhang Hongyi)
Authorized Officer Mar.25, 2016

2. PRODUCT INFORMATION

The EUT is a amateur radio with scanning function.

A major technical description of EUT is described as following:

Communication Type	Voice / Tone only
Modulation	FM
RX Frequency Range	136MHz to 174MHz, 400MHz to 512MHz
TX Frequency Range	144-148MHz,420-450MHz
Emission Type	11K ϕ F3E
Antenna Designation	Detachable
Antenna type	External SMA antenna
Antenna Model Name	QA09UV1
Antenna Gain	0dBi
Power Supply	DC 7.4V 1500mAh by battery .charging with DC 12V
Adapter parameter	INPUT: 100-240V/50Hz 0.3A ; OUTPUT: 12V~500mA

3. TEST FACILITY

Facility	Dong guan Precise Testing Service Co., Ltd
Location	Building D, Baoding Technology Park, Guangming Road2, Dongcheng District, Dongguan, Guangdong, China.
Description	The test site is constructed and calibrated to meet the FCC requirements in documents ANSI C63.4:2009.
Site Filing	The FCC Registration Number is 371540
Instrument Tolerance	All measuring equipment is in accord with ANSI C63.4 requirements that meet industry regulatory agency and accreditation agency requirement.

4. SUPPORT EQUIPMENT LIST

Device Type	Manufacturer	Model Name	Serial No.	Data Cable	Power Cable
--	--	--	--	--	--

5. SYSTEM DESCRIPTION

EUT test procedure:

1. Connect EUT and peripheral devices.
2. Power on the EUT, the EUT begins to work.
3. Running data transmission and make sure the EUT normal working.

EMC TEST MODES

No.	TEST MODES
1	Standby Mode + (Charging)

Note: Only the result of the worst case was recorded in the report.

6. SUMMARY OF TEST RESULTS

FCC Rules	Description Of Test	Result
§15.107	Conduction Emission	Compliant
§15.109	Radiated Emission	Compliant
§15.111	Antenna Conducted Power for receivers	Compliant

7. FCC LINE CONDUCTED EMISSION TEST

7.1. TEST EQUIPMENT OF LINE CONDUCTED EMISSION TEST

Conducted Emission Test Site					
Name of Equipment	Manufacturer	Model Number	Serial Number	Last Calibration	Due Calibration
EMI Test Receiver	Rohde & Schwarz	ESCI	101417	2015.07.04	2016.07.03
Artificial Mains Network	Narda	L2-16B	000WX31025	2015.07.08	2016.07.07
Artificial Mains Network (AUX)	Narda	L2-16B	000WX31026	2015.07.08	2016.07.07
RF Cable	SCHWARZBECK	AK9515E	96222	2015.07.04	2016.07.03
Shielded Room	CHENGYU	843	PTS-002	2015.06.06	2016.06.05

7.2 .LIMITS OF LINE CONDUCTED EMISSION TEST

Frequency	Maximum RF Line Voltage	
	Q.P.(dBuV)	A.V(dBuV)
150kHz~500kHz	66-56	56-46
500kHz~5MHz	56	46
5MHz~30MHz	60	50

**Note: 1. The lower limit shall apply at the transition frequency.

2. The limit decreases linearly with the logarithm of the frequency in the range 0.15 MHz to 0.50 MHz

7.3. BLOCK DIAGRAM OF LINE CONDUCTED EMISSION TEST

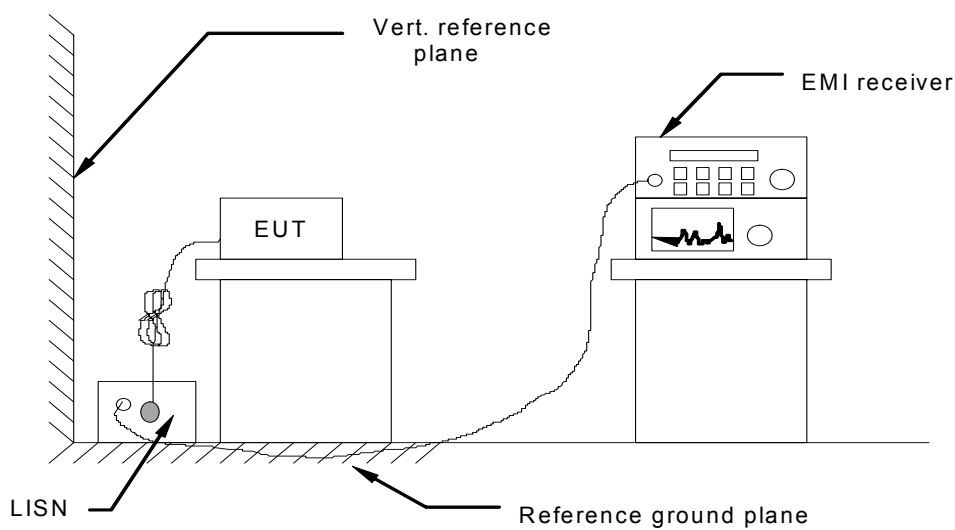

7.4. PROCEDURE OF LINE CONDUCTED EMISSION TEST

- 1) The equipment was set up as per the test configuration to simulate typical actual usage per the user's manual. When the EUT is a tabletop system, a wooden table with a height of 0.8 meters is used and is placed on the ground plane as per ANSI C63.4 (see Test Facility for the dimensions of the ground plane used). When the EUT is a floor-standing equipment, it is placed on the ground plane which has a 3-12 mm non-conductive covering to insulate the EUT from the ground plane.
- 2) Support equipment, if needed, was placed as per ANSI C63.4.
- 3) All I/O cables were positioned to simulate typical actual usage as per ANSI C63.4. The EUT received power through a Line Impedance Stabilization Network (LISN) that was grounded to the protect earth.
- 4) The EUT test program was started. Emissions were measured on each current carrying line of the EUT using a spectrum Analyzer / Receiver connected to the LISN powering the EUT. The LISN has two monitoring points: Line 1 (Hot Side) and Line 2 (Neutral Side). Two scans were taken: one with Line 1 connected to Analyzer / Receiver and Line 2 connected to a 50 ohm load; the second scan had Line 1 connected to a 50 ohm load and Line 2 connected to the Analyzer / Receiver.
- 5) Analyzer / Receiver scanned from 150 kHz to 30MHz for emissions in each of the test modes.
- 6) During the above scans, the emissions were maximized by cable manipulation.
- 7) A scan was taken on both power lines, Line 1 and Line 2, recording at least the six highest emissions.
- 8) Emission frequency and amplitude were recorded into a computer in which correction factors were used to calculate the emission level and compare reading to the applicable limit. If EUT emission level was less -2dB to the A.V. limit in Peak mode, then the emission signal was re-checked using Q.P and Average detector.

The test data of the worst case condition (mode 1) was reported on the following Data page.

7.5 TEST RESULT OF LINE CONDUCTED EMISSION TEST

CONDUCTED EMISSION TEST – LINE L1 (+12V)

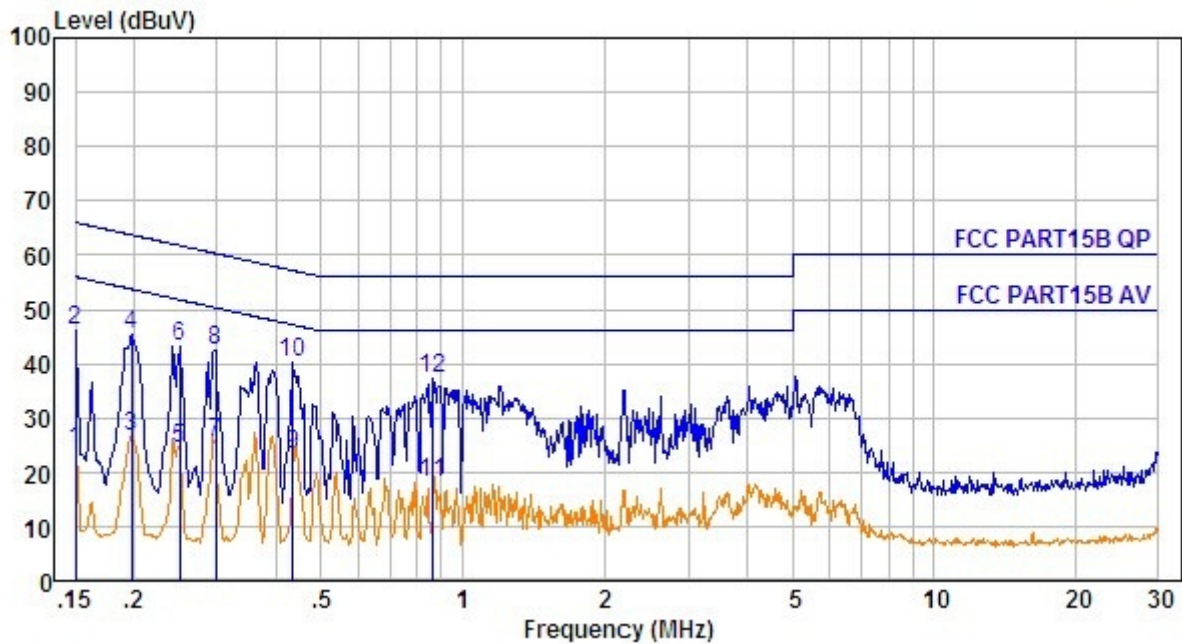

No.	Freq MHz	Cable Loss dB	AMN Factor dB	Receiver Reading dBuV	Emission Level dBuV	Limit dBuV	Over Limit dB	Remark
1.	0.150	10.60	0.60	12.94	24.14	56.00	-31.86	Average
2.	0.150	10.60	0.60	34.94	46.14	66.00	-19.86	Peak
3.	0.198	10.61	0.60	15.19	26.40	53.71	-27.31	Average
4.	0.198	10.61	0.60	34.19	45.40	63.71	-18.31	Peak
5.	0.249	10.62	0.60	12.98	24.20	51.78	-27.58	Average
6.	0.249	10.62	0.60	31.98	43.20	61.78	-18.58	Peak
7.	0.299	10.63	0.60	14.26	25.49	50.28	-24.79	Average
8.	0.299	10.63	0.60	31.26	42.49	60.28	-17.79	Peak
9.	0.435	10.64	0.60	12.01	23.25	47.15	-23.90	Average
10.	0.435	10.64	0.60	29.01	40.25	57.15	-16.90	Peak
11.	0.866	10.67	0.60	6.85	18.12	46.00	-27.88	Average
12.	0.866	10.67	0.60	25.85	37.12	56.00	-18.88	Peak

RESULT: PASS

CONDUCTED EMISSION TEST – LINE 2 (-12V)

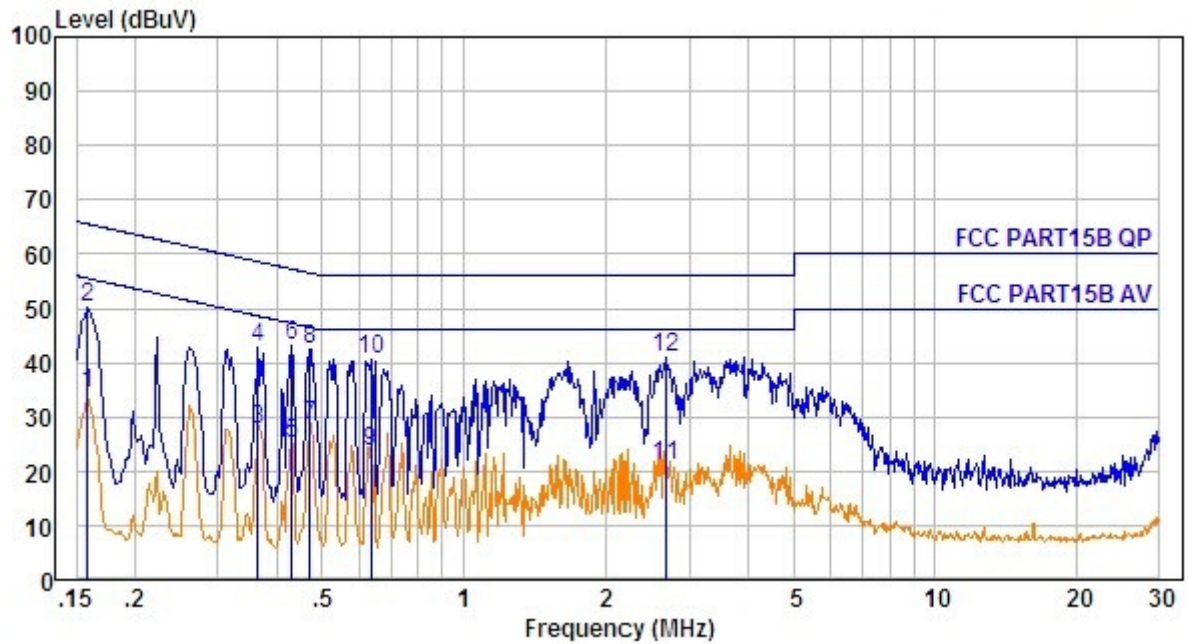

No.	Freq MHz	Cable Loss dB	AMN Factor dB	Receiver Reading dBuV	Emission Level dBuV	Limit dBuV	Over Limit dB	Remark
1.	0.158	10.60	0.60	22.97	34.17	55.56	-21.39	Average
2.	0.158	10.60	0.60	38.97	50.17	65.56	-15.39	Peak
3.	0.365	10.63	0.60	16.58	27.81	48.61	-20.80	Average
4.	0.365	10.63	0.60	31.58	42.81	58.61	-15.80	Peak
5.	0.431	10.64	0.60	14.04	25.28	47.24	-21.96	Average
6.	0.431	10.64	0.60	32.04	43.28	57.24	-13.96	Peak
7.	0.471	10.64	0.60	17.13	28.37	46.49	-18.12	Average
8.	0.471	10.64	0.60	31.13	42.37	56.49	-14.12	Peak
9.	0.634	10.66	0.60	12.36	23.62	46.00	-22.38	Average
10.	0.634	10.66	0.60	29.36	40.62	56.00	-15.38	Peak
11.	2.678	10.71	0.60	9.75	21.06	46.00	-24.94	Average
12.	2.678	10.71	0.60	29.75	41.06	56.00	-14.94	Peak

RESULT: PASS

8. FCC RADIATED EMISSION TEST

8.1. TEST EQUIPMENT OF RADIATED EMISSION

Description	Manufacturer	Model	Identifier	Cal. Date	Cal. Due
EMI Test Receiver	Rohde & Schwarz	ESCI	101417	2015.07.04	2016.07.03
Trilog Broadband Antenna (25M-1GHz)	SCHWARZBECK	VULB9160	9160-3355	2015.07.04	2016.07.03
Signal Amplifier	SCHWARZBECK	BBV 9475	9745-0013	2015.07.04	2016.07.03
RF Cable	SCHWARZBECK	AK9515E	96221	2015.07.04	2016.07.03
3m Anechoic Chamber	CHENGYU	966	PTS-001	2015.06.06	2016.06.05
MULTI-DEVICE Positioning Controller	Max-Full	MF-7802	MF780208339	N/A	N/A
Spectrum analyzer	Agilent	E4407B	MY46185649	2015.06.06	2016.06.05
Horn Antenna (1G-18GHz)	SCHWARZBECK	BBHA9120D	9120D-1246	2015.06.06	2016.06.05

8.2. LIMITS OF RADIATED EMISSION TEST

Frequency (MHz)	Distance (m)	Maximum Field Strength Limit (dBuV/m/ Q.P.)
30~88	3	40.0
88~216	3	43.5
216~960	3	46.0
Above 960	3	54.0

**Note: The lower limit shall apply at the transition frequency.

8.3 BLOCK DIAGRAM OF RADIATED EMISSION TEST

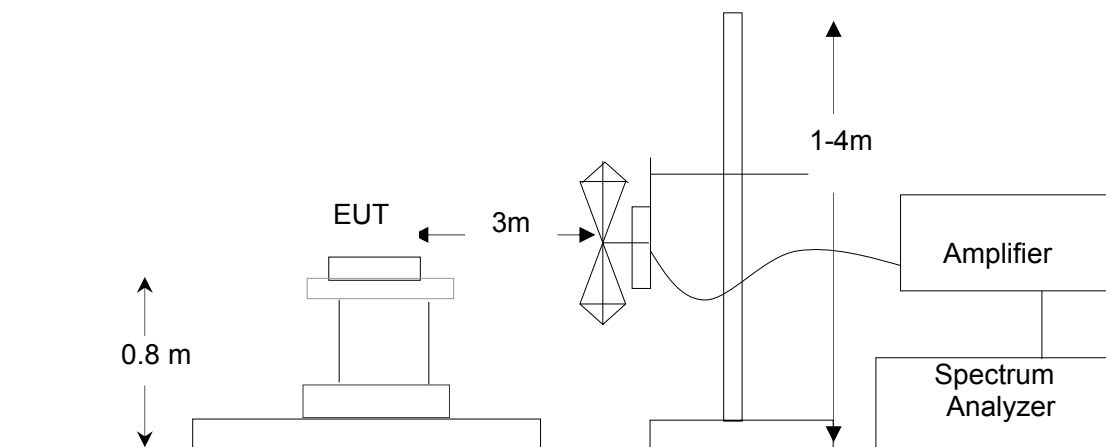

8.4 PROCEDURE OF RADIATED EMISSION TEST

- 1) The equipment was set up as per the test configuration to simulate typical actual usage per the user's manual. When the EUT is a tabletop system, a wooden turntable with a height of 0.8 meters is used which is placed on the ground plane as per ANSI C63.4 (see Test Facility for the dimensions of the ground plane used). When the EUT is floor-standing equipment, it is placed on the ground plane which has a 3-12 mm non-conductive covering to insulate the EUT from the ground plane.
- 2) Support equipment, if needed, was placed as per ANSI C63.4.
- 3) All I/O cables were positioned to simulate typical actual usage as per ANSI C63.4.
- 4) The EUT received DC 13.8V by DC source. All support equipments received AC 120V/60Hz power from socket under the turntable, if any.
- 5) The antenna was placed at 3 meter away from the EUT as stated in FCC Part 15. The antenna connected to the Analyzer via a cable and at times a pre-amplifier would be used.
- 6) The Analyzer / Receiver quickly scanned from 30MHz to 1000MHz. The EUT test program was started. Emissions were scanned and measured rotating the EUT to 360 degrees and positioning the antenna 1 to 4 meters above the ground plane, in both the vertical and the horizontal polarization, to maximize the emission reading level.
- 7) The test mode(s) were scanned during the test:
- 8) Recorded at least the six highest emissions. Emission frequency, amplitude, antenna position, polarization and turntable position were recorded into a computer in which correction factors were used to calculate the emission level and compare reading to the applicable limit and Q.P./Peak reading is presented.

The test data of the worst case condition(mode 1) was reported on the following Data page

8.5 TEST RESULT OF RADIATED EMISSION TEST

Radiated Emission Test –Horizontal -3m

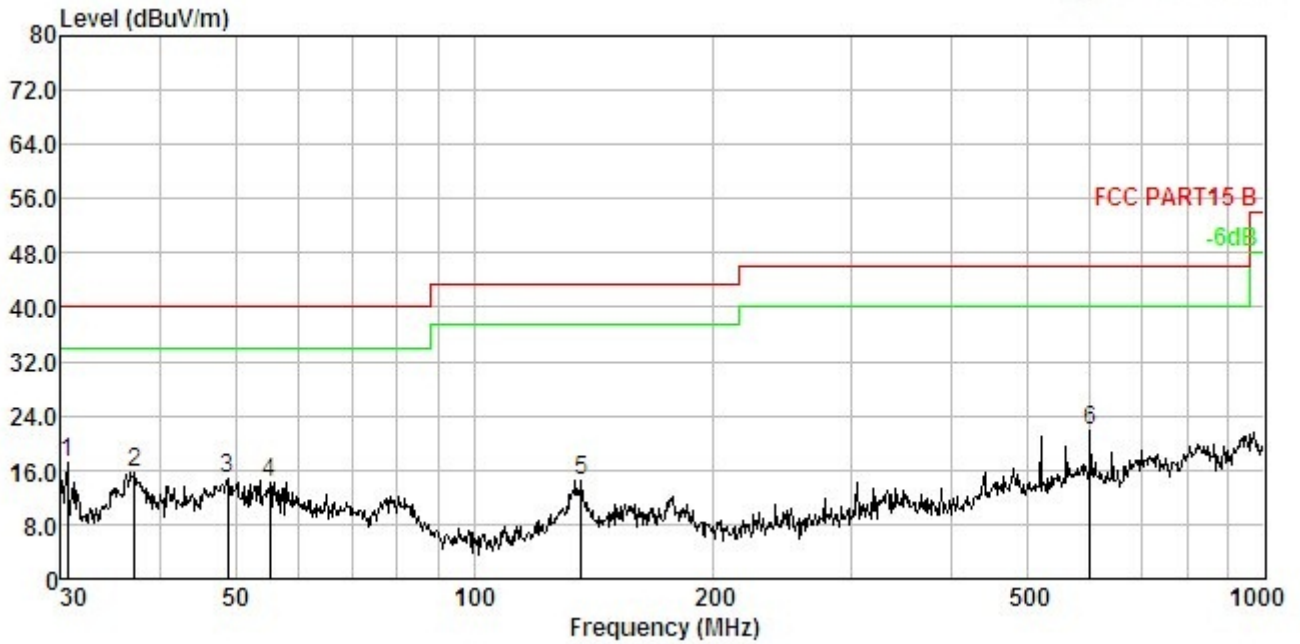

No.	Freq MHz	Cable Loss dB	ANT Factor dB/m	Receiver Reading dBuV	Preamplifier Factor dB	Emission Level dBuV/m	Limit dBuV/m	Over Limit dB	Remark
1.	30.531	1.07	13.24	32.90	29.98	17.23	40.00	-22.77	Peak
2.	37.155	1.25	13.50	30.88	30.04	15.59	40.00	-24.41	Peak
3.	48.843	1.50	12.49	30.84	30.14	14.69	40.00	-25.31	Peak
4.	55.221	1.61	11.91	30.90	30.18	14.24	40.00	-25.76	Peak
5.	136.939	2.43	13.14	29.30	30.50	14.37	43.50	-29.13	Peak
6.	601.427	3.77	19.16	30.02	31.01	21.94	46.00	-24.06	Peak

RESULT:PASS

Radiated Emission Test –Vertical -3m

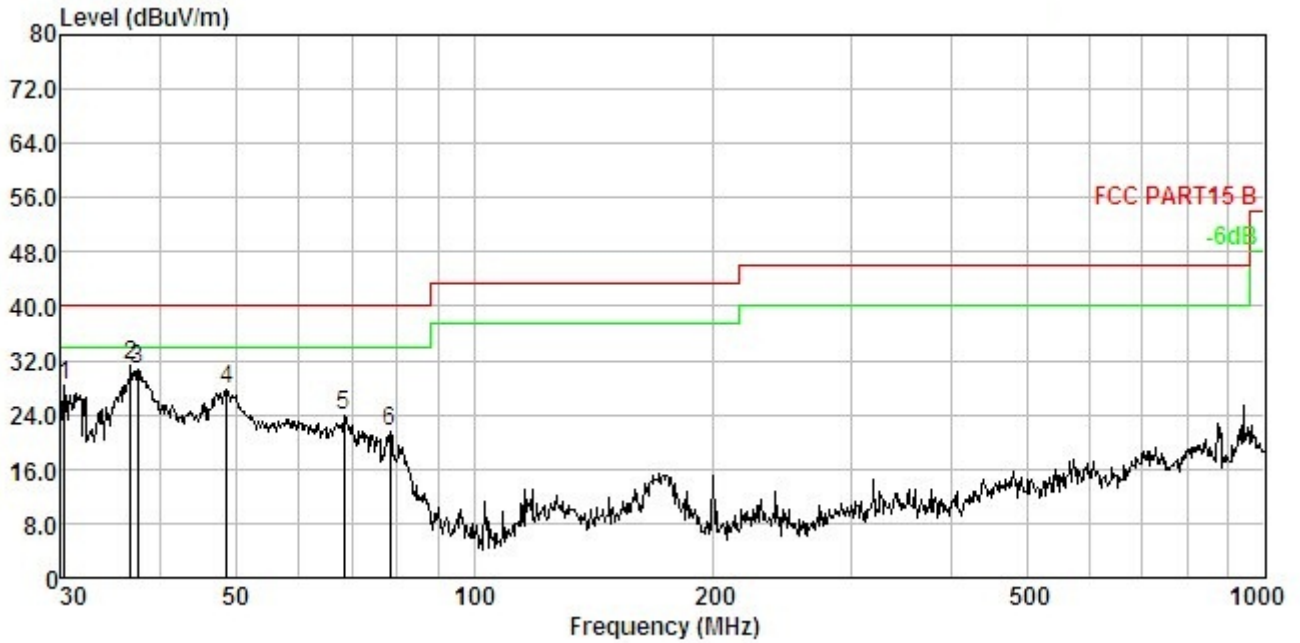

No.	Freq MHz	Cable Loss dB	ANT Factor dB/m	Receiver Reading dBuV	Preamp Factor dB	Emission Level dBuV/m	Limit dBuV/m	Over Limit dB	Remark
1.	30.317	1.06	13.24	43.96	29.97	28.29	40.00	-11.71	Peak
2.	36.766	1.24	13.48	46.55	30.04	31.23	40.00	-8.77	Peak
3.	37.548	1.26	13.51	46.11	30.05	30.83	40.00	-9.17	Peak
4.	48.672	1.49	12.52	43.75	30.14	27.62	40.00	-12.38	Peak
5.	68.391	1.80	10.57	41.84	30.26	23.95	40.00	-16.05	Peak
6.	78.413	1.93	9.11	40.86	30.30	21.60	40.00	-18.40	Peak

RESULT: PASS

NOTE: The test results of above 1G are all 20 dB margin below the limits.

9. ANTENNA CONDUCTED POWER FOR RECEIVERS

LIMIT

The antenna conducted power of the receiver as defined in §15.111 shall not exceed the values given in the following tables

Frequency Range	9 KHz to 2GHz
Limit	2.0 nW (-57 dBm)

TEST CONFIGURATION

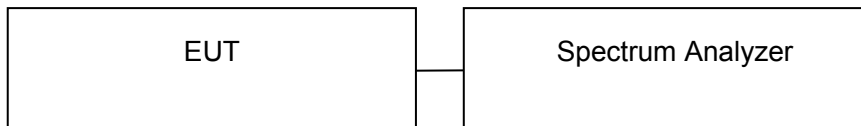

TEST PROCEDURE

1. The receiver antenna terminal connected to a spectrum analyzer.
2. The test data of the worst case condition(mode 1) was reported on the following Data page.

TEST RESULTS

VHF:

Conducted Measurement (9 KHz to 150 KHz)

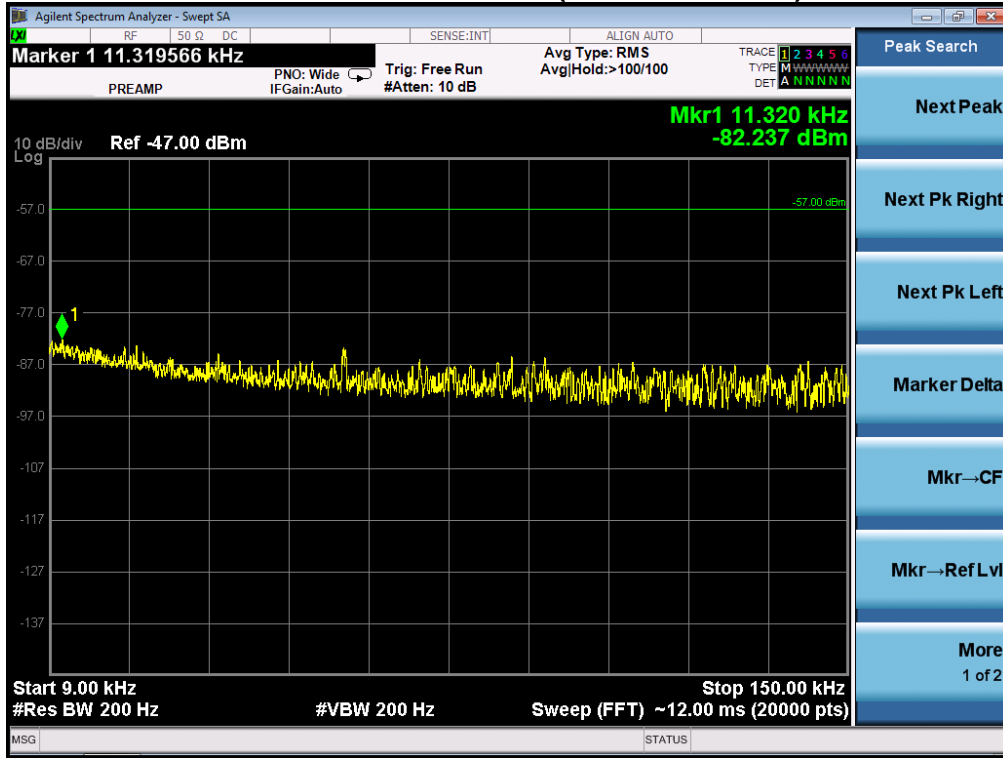

Conducted Measurement (150 KHz to 30 MHz)

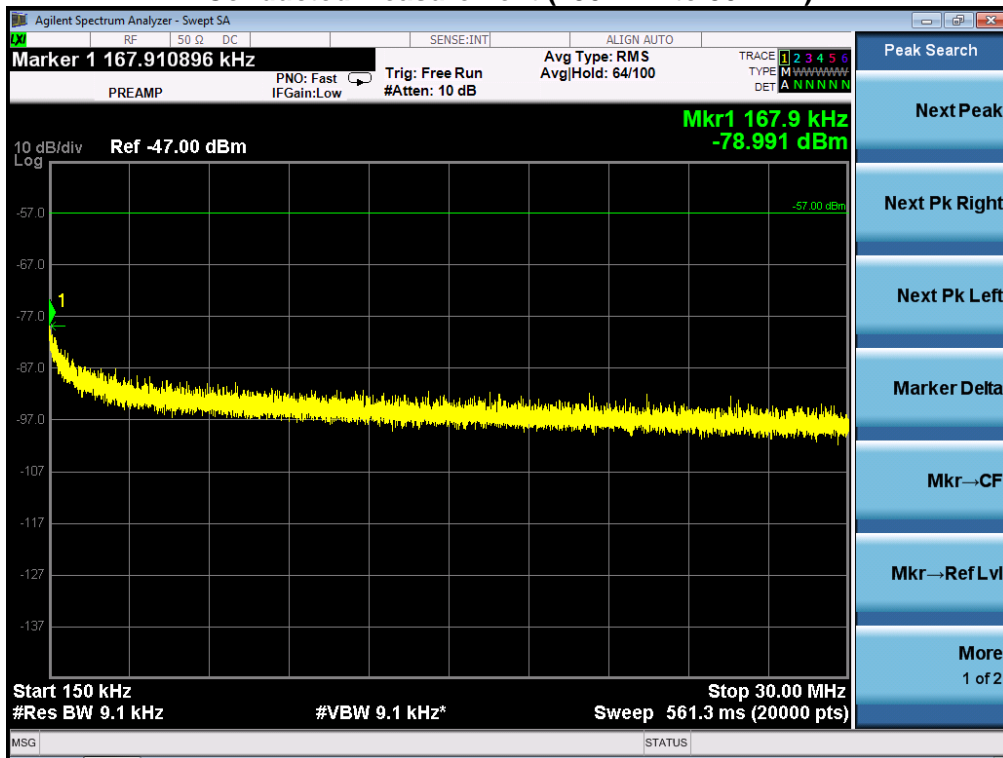

Conducted Measurement (30MHz to 1GHz)

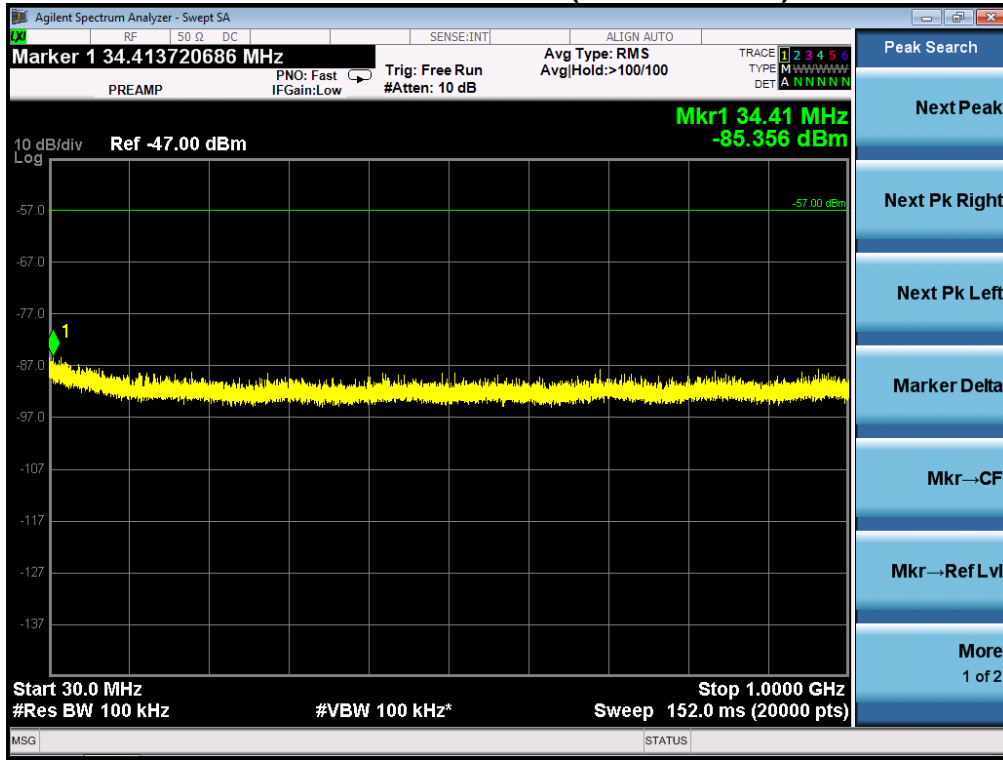

Conducted Measurement (1GHz to 2GHz)

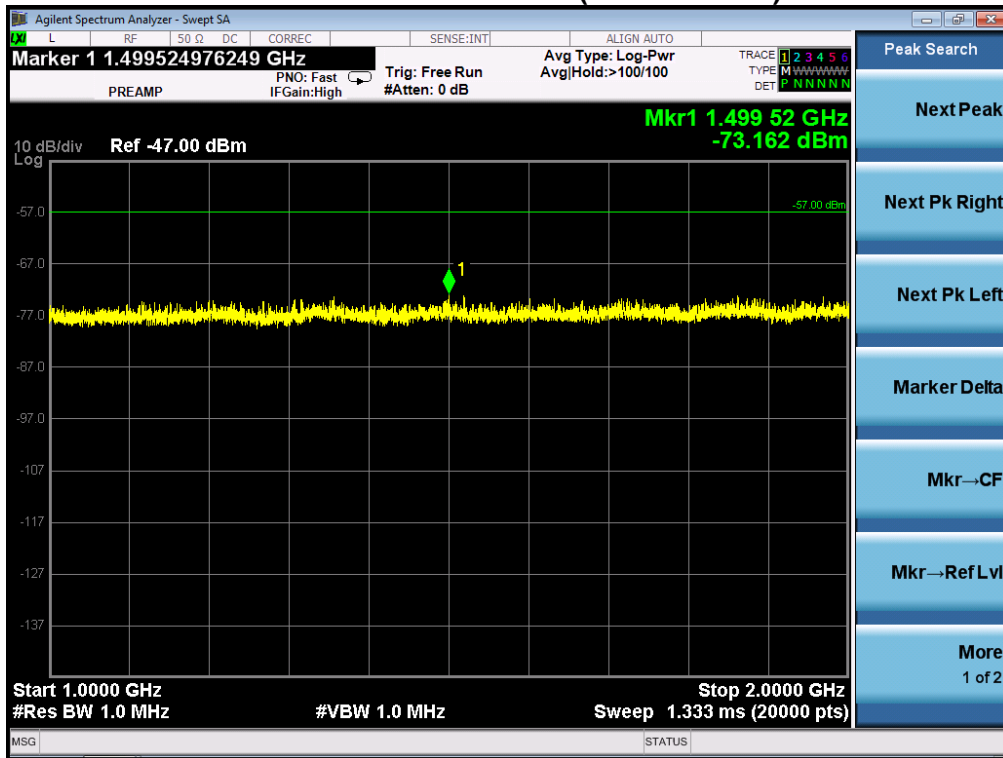

Conducted Measurement (30MHz to 1GHz)

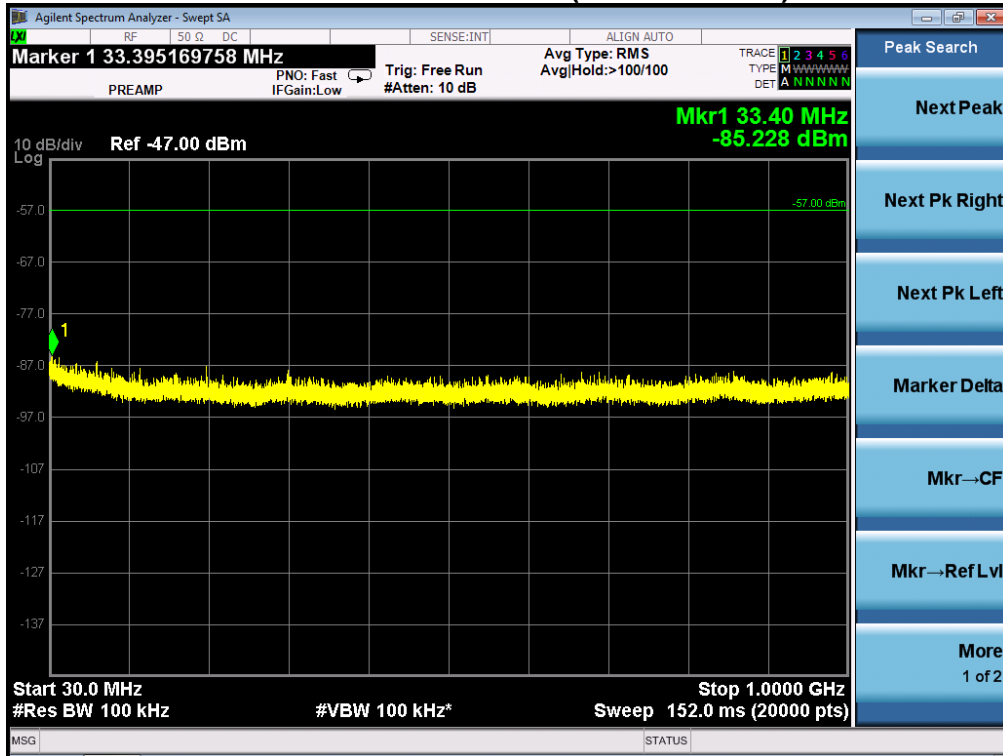

Conducted Measurement (1GHz to 2GHz)

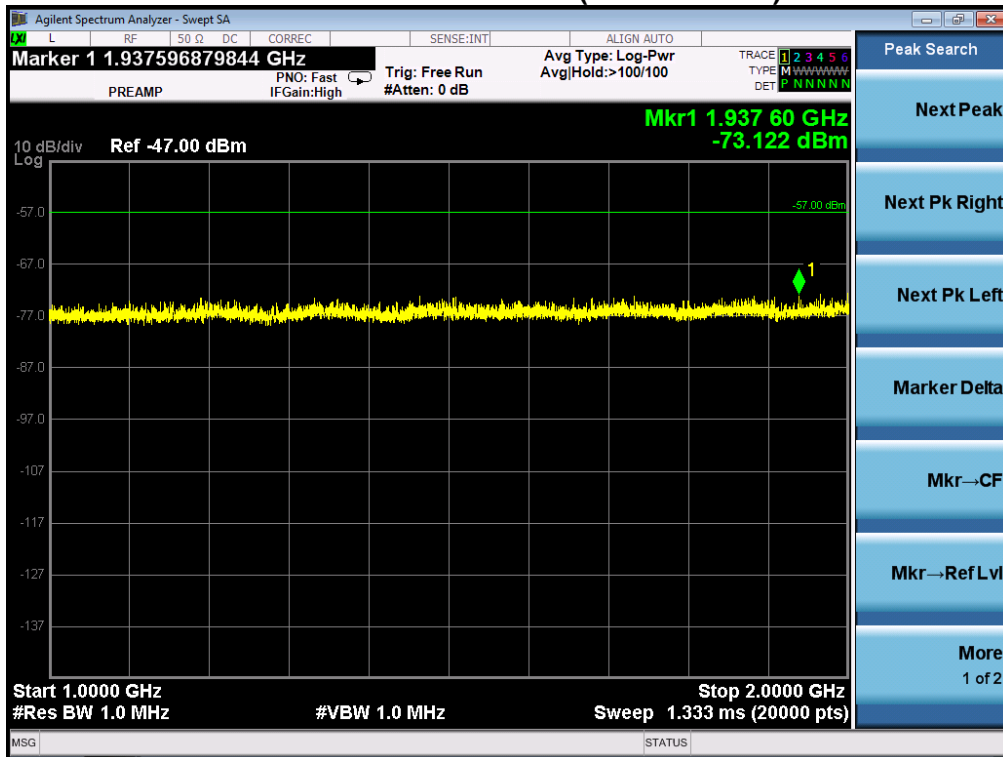

RESULT: PASS

APPENDIX 1: PHOTOGRAPHS OF TEST SETUP

CONDUCTED EMISSION TEST SETUP



RADIATED EMISSION BELOW 1GHz TEST SETUP

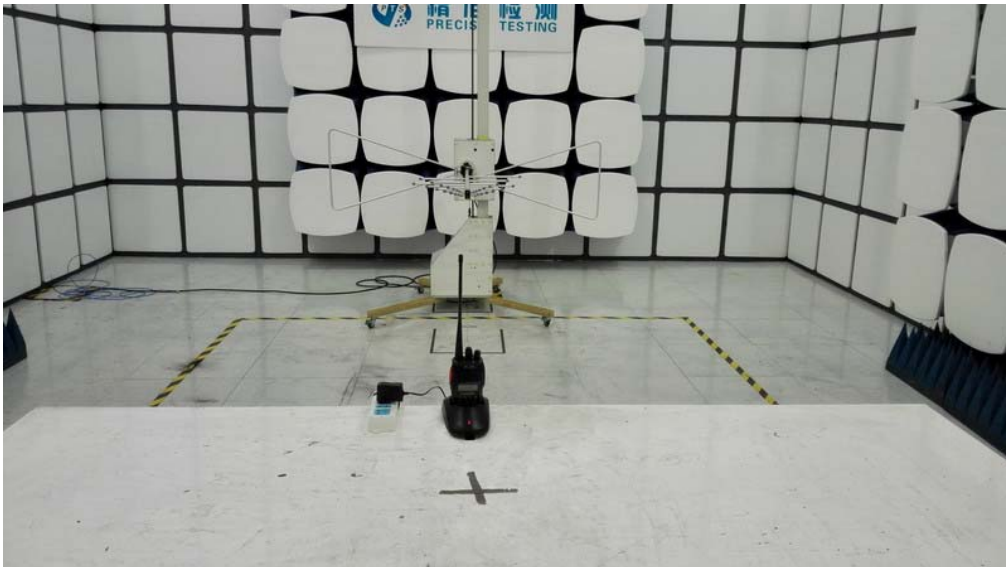

RADIATED EMISSION ABOVE 1GHz TEST SETUP

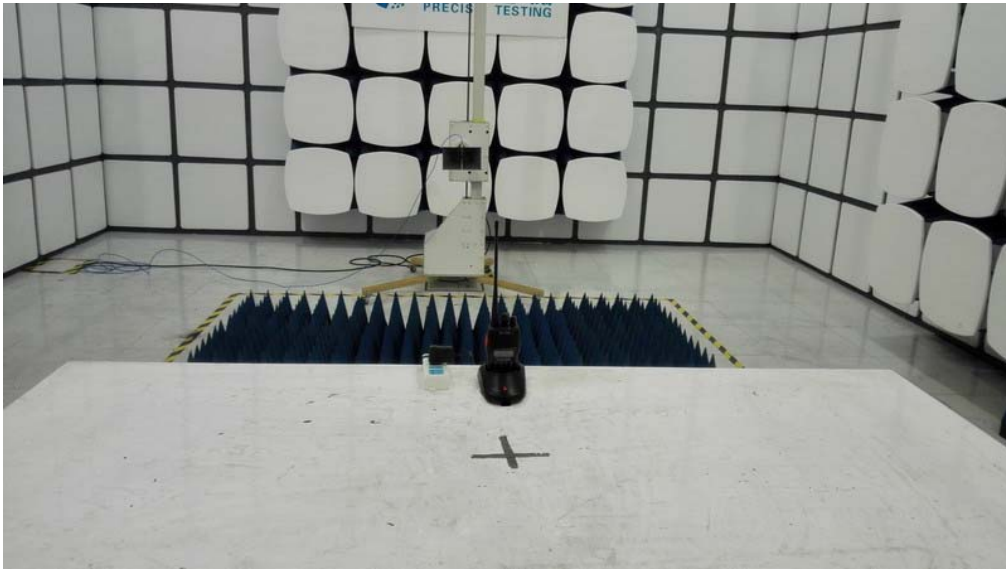

APPENDIX 2: PHOTOGRAPHS OF EUT

TOTAL VIEW OF EUT



TOP VIEW OF EUT



BOTTOM VIEW OF EUT



FRONT VIEW OF EUT



BACK VIEW OF EUT



LEFT VIEW OF EUT



RIGHT VIEW OF EUT



OPEN VIEW OF EUT-1



OPEN VIEW OF EUT-2



INTERNAL VIEW OF EUT-1

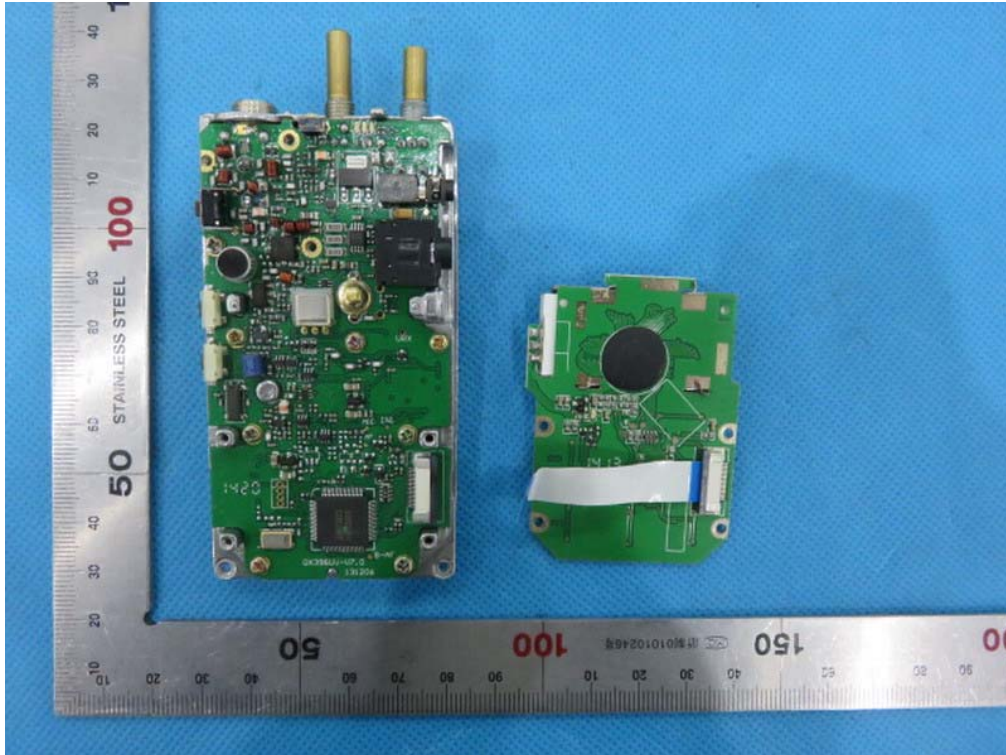

INTERNAL VIEW OF EUT-2

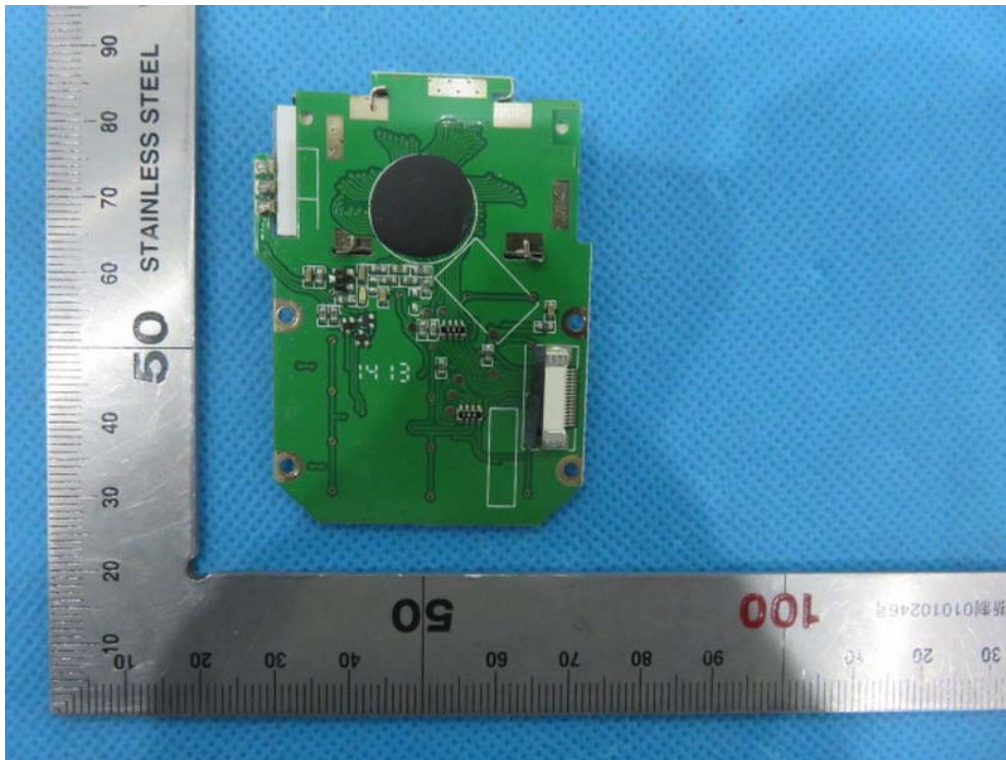

INTERNAL VIEW OF EUT-3

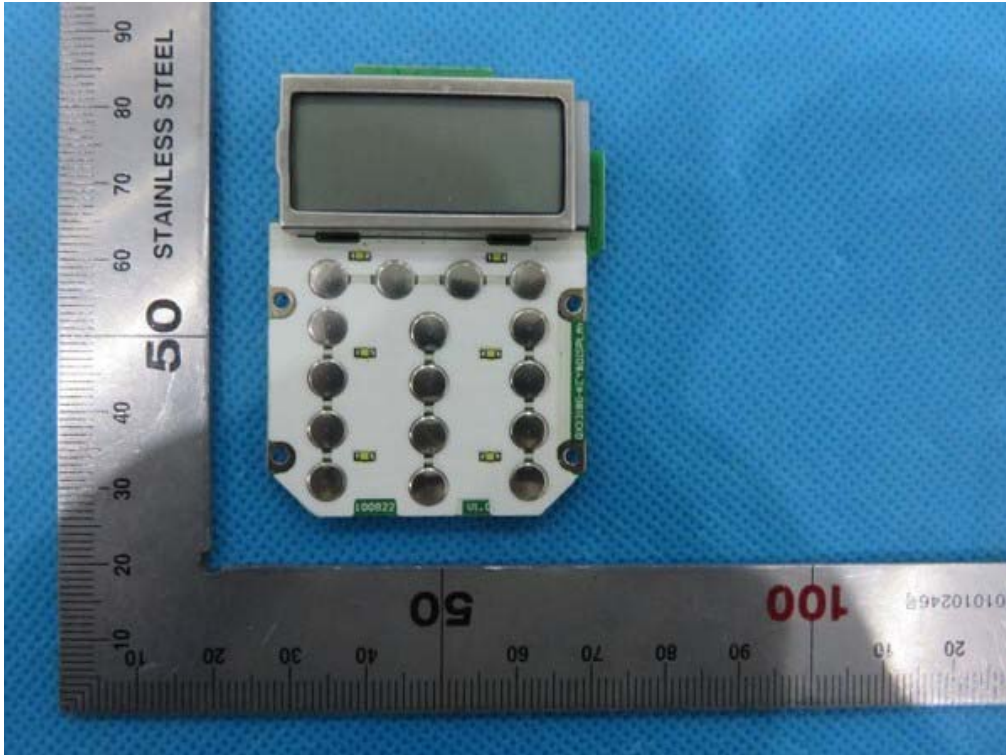

INTERNAL VIEW OF EUT-4

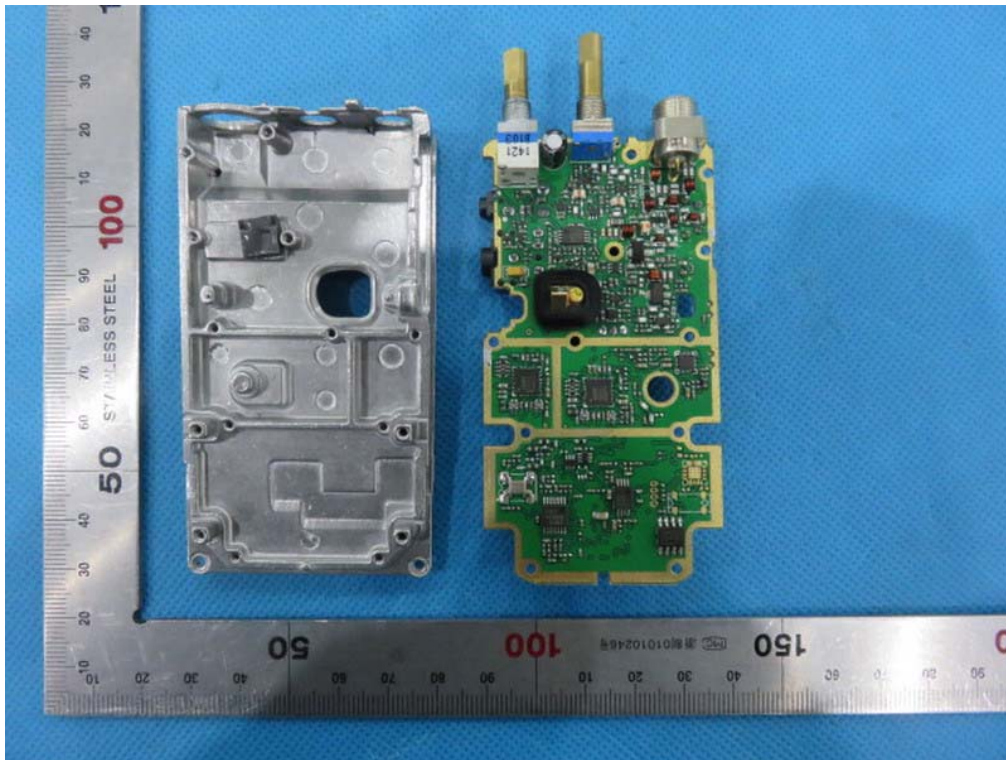

INTERNAL VIEW OF EUT-5

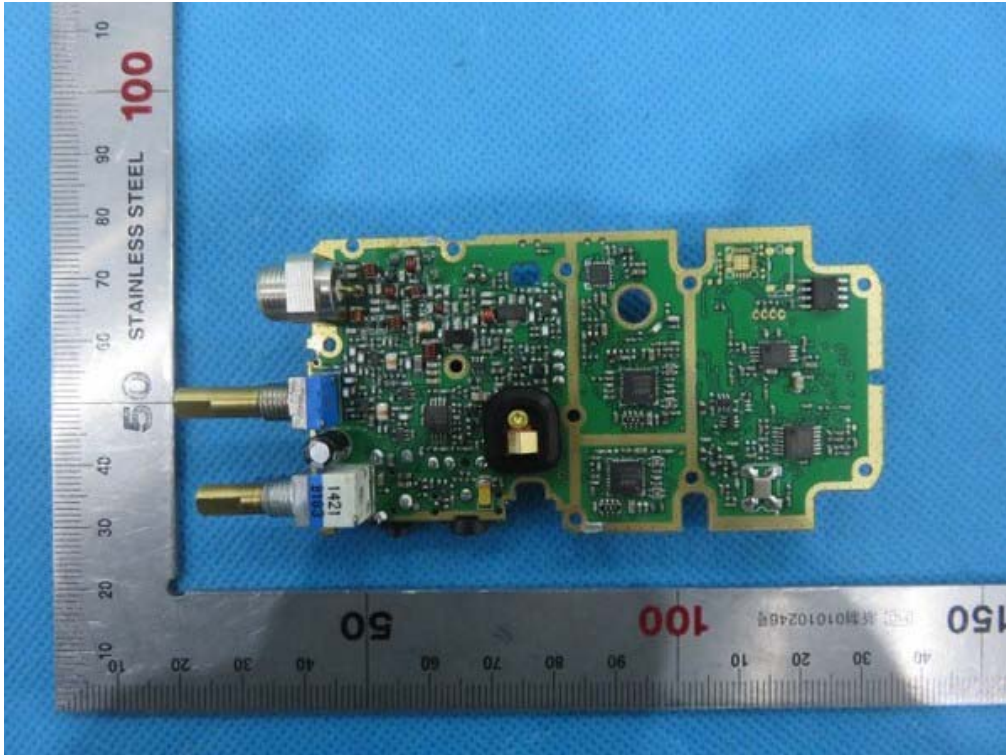

INTERNAL VIEW OF EUT-6

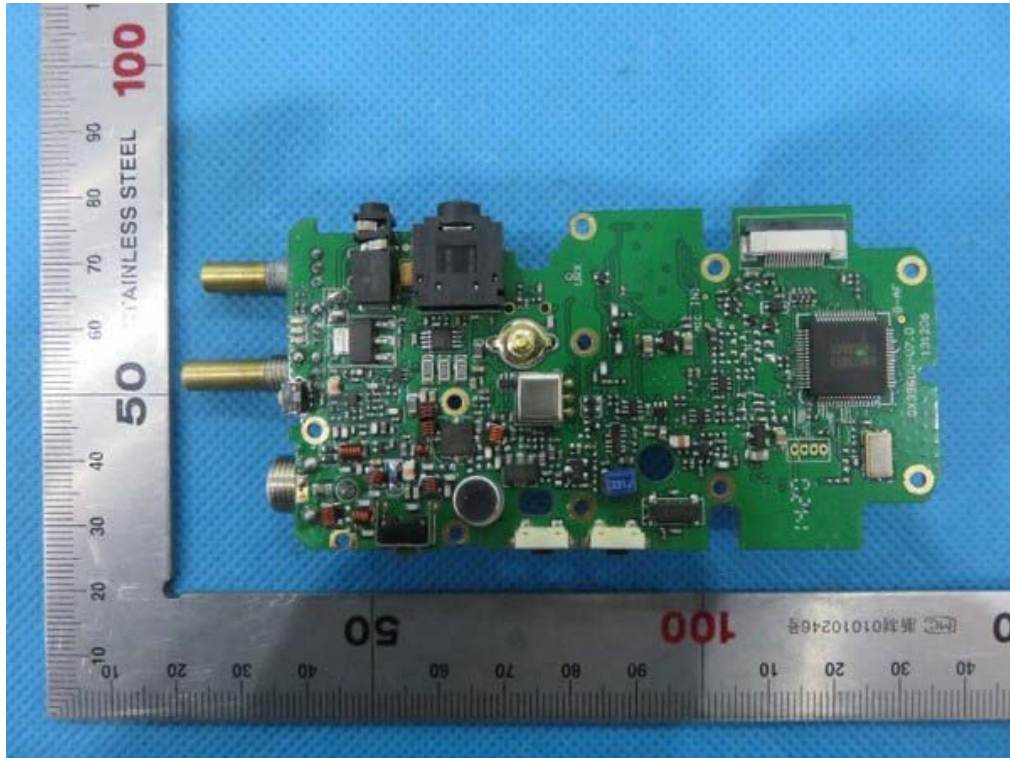

----END OF REPORT----