



FCC Part 90 Test Report

Report No.: AGC00589140206FE09

FCC ID : T4K-QZQX628G
PRODUCT DESIGNATION : TWO WAY RADIO
BRAND NAME : N/A
MODEL NAME : 628G
CLIENT : Qixiang Electron Science & Technology Co., Ltd. Quanzhou
DATE OF ISSUE : Feb.25, 2014
STANDARD(S) : FCC Part 90 Rules
REPORT VERSION : V 1.0

Attestation of Global Compliance (Shenzhen) Co., Ltd



CAUTION: This report shall not be reproduced except in full without the written permission of the test laboratory and shall not be quoted out of context.

REPORT REVISE RECORD

Report Version	Revise Time	Issued Date	Valid Version	Notes
V1.0	/	Feb.25, 2014	Valid	Original Report

VERIFICATION OF COMPLIANCE

Applicant:	Qixiang Electron Science & Technology Co., Ltd. Quanzhou
	Qixiang Building, Tangxi Industrial Zone, Luojiang District, Quanzhou, Fujian, China
Manufacturer:	Qixiang Electron Science & Technology Co., Ltd. Quanzhou
	Qixiang Building, Tangxi Industrial Zone, Luojiang District, Quanzhou, Fujian, China
Product Designation:	TWO WAY RADIO
Brand Name:	N/A
Model Name:	628, 628G
Model Difference:	All the same except for the model name and appearance. The main test model is 628G.
Hardware Version:	V2.02
software Version:	V2.02
Date of Test:	Feb.16, 2014 to Feb.24, 2014

WE HEREBY CERTIFY THAT:

The above equipment was tested by Attestation of Global Compliance (Shenzhen) Co., Ltd. The data evaluation, test procedures, and equipment configurations shown in this report were made in accordance with the procedures given in TIA/EIA 603. The sample tested as described in this report is in compliance with the FCC Rules Part 90 requirements

The test results of this report relate only to the tested sample identified in this report.

Tested by	
	_____ Wall Huang Feb.25, 2014
Checked By	
	_____ Kidd Yang Feb.25, 2014
Authorized By	
	_____ Solger Zhang Feb.25, 2014

TABLE OF CONTENTS

1. GENERAL INFORMATION	6
1.1 PRODUCT DESCRIPTION	6
1.3 TEST METHODOLOGY	7
1.4 TEST FACILITY	7
1.5 SPECIAL ACCESSORIES	7
1.6 EQUIPMENT MODIFICATIONS	7
2. SYSTEM TEST CONFIGURATION	8
2.1 EUT CONFIGURATION	8
2.2 EUT EXERCISE	8
2.3 GENERAL TECHNICAL REQUIREMENTS	8
2.4 CONFIGURATION OF TESTED SYSTEM	9
3. SUMMARY OF TEST RESULTS	10
4. DESCRIPTION OF TEST MODES	11
5. CONDUCTED LIMITS	12
5.1 PROVISIONS APPLICABLE	12
5.2 MEASUREMENT PROCEDURE	12
5.3 TEST SETUP BLOCK DIAGRAM	13
5.4 TEST EQUIPMENT USED	13
5.5 TEST RESULT	14
6. FREQUENCY TOLERANCE	16
6.1 PROVISIONS APPLICABLE	16
6.2 MEASUREMENT PROCEDURE	16
6.3 TEST SETUP BLOCK DIAGRAM	17
6.4 TEST EQUIPMENT USED:	17
6.5 TEST RESULT	17
7. EMISSION BANDWIDTH	19
7.1 PROVISIONS APPLICABLE	20
7.2 MEASUREMENT PROCEDURE	20
7.3 TEST SETUP BLOCK DIAGRAM	20
7.4 MEASUREMENT EQUIPMENT USED:	20
7.5 MEASUREMENT RESULT:	21
8. UNWANTED RADIATION	22
8.1 PROVISIONS APPLICABLE	22
8.2 MEASUREMENT PROCEDURE	22

8.3 TEST SETUP BLOCK DIAGRAM 23

8.4 MEASUREMENT EQUIPMENT USED: 25

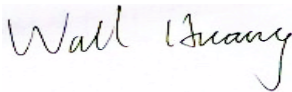
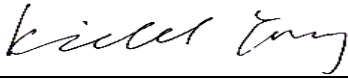
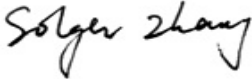
8.5 MEASUREMENT RESULTS: 25

8.6 EMISSION MASK PLOT 27

9. MODULATION CHARACTERISTICS 28

9.1 PROVISIONS APPLICABLE 28

9.2 MEASUREMENT METHOD 28

9.3 MEASUREMENT INSTRUMENTS 28

9.4 MEASUREMENT RESULT 29

10. MAXIMUM TRANSMITTER POWER (CONDUCTED OUTPUT POWER) 32

10.1 PROVISIONS APPLICABLE 32

10.2 TEST PROCEDURE 32

10.3 TEST INSTRUMENTS 32

10.4 TEST CONFIGURATION 32

10.5 TEST RESULT 33

10.6 CONDUCT SPURIOUS PLOT 35

11. TRANSMITTER FREQUENCY BEHAVIOR 36

11.1 PROVISIONS APPLICABLE 37

11.2 TEST METHOD 37

11.3 TEST INSTRUMENTS 37

11.4 DESCRIBE LIMIT LINE OF TRANSMITTER FREQUENCY BEHAVIOR 38

11.5 MEASURE RESULT 40

12. RADIATED EMISSION ON RECEIVING MODE 41

12.1 PROVISIONS APPLICABLE 41

12.2 TEST METHOD 41

12.3 TEST INSTRUMENTS 41

12.4 MEASURE RESULT (MEASURED AT 3M USING FCC PART15 B LIMITS) 42

13. AUDIO LOW PASS FILTER RESPONSE 44

13.1 LIMITS 44

13.2. METHOD OF MEASUREMENTS 44

13.3 TEST DATA 45

APPENDIX I 47

PHOTOGRAPHS OF SETUP 47

APPENDIX II 48

EXTERNAL VIEW OF EUT 48

1. GENERAL INFORMATION

1.1 PRODUCT DESCRIPTION

The EUT is a TWO WAY RADIO designed for voice communication. It is designed by way of utilizing the FM modulation achieves the system operating.

A major technical description of EUT is described as following:

Communication Type	Voice / Tone only
Modulation	FM
Emission Type	F3E
Emission Bandwidth	10.44KHz
Peak Frequency Deviation	1.89KHz
Audio Frequency Response	6.34dB
Maximum Transmitter Power	32.99dBm
Output power Modification	2W (It was fixed by the manufacturer, any individual can't arbitrarily change it.)
Antenna Designation	Detachable
Antenna Gain	2.15dBi
Power Supply	DC 7.4V, 1500mAh (by battery)
Adapter Parameter	Input: 100-240V, 50/60HZ, 0.3A Output: 5V, 0.5A
Limiting Voltage	DC 6.29V
Operation Frequency Range and Channel	Frequency Range: 400MHz to 480MHz Channel Separation: 12.5KHz
	Top Channel: 400.025MHz Centre Channel: 440.000MHz Bottom Channel: 479.975MHz
Frequency Tolerance	0.860ppm

1.2 RELATED SUBMITTAL(S) / GRANT (S)

This submittal(s) (test report) is intended for **FCC ID: T4K-QZQX628G**, filing to comply with the FCC Part 90 requirements and the.

1.3 TEST METHODOLOGY

The radiated emission testing was performed according to the procedures of ANSI C 63.4: 2009; TIA/EIA 603 and FCC CFR 47 Rules of 2.1046, 2.1047, 2.1049, 2.1051, 2.1053, 2.1055, 2.1057.

1.4 TEST FACILITY

The test site used to collect the radiated data is located on the address of Attestation of Global Compliance (Shenzhen) Co., Ltd. 2/F., Building 2, No.1-No.4, Chaxi Sanwei Technical Industrial Park, Gushu, Xixiang, Bao'an District, Shenzhen, Guangdong, China. The test site is constructed and calibrated to meet the FCC requirements in documents ANSI C63.4: 2003 and IC requirements in documents RS212.

FCC register No.: 259865

1.5 SPECIAL ACCESSORIES

Not available for this EUT intended for grant.

1.6 EQUIPMENT MODIFICATIONS

Not available for this EUT intended for grant.

2. SYSTEM TEST CONFIGURATION

2.1 EUT CONFIGURATION

The EUT configuration for testing is installed on RF field strength measurement to meet the Commission's requirement and operating in a manner which intends to maximize its emission characteristics in a continuous normal application.

2.2 EUT EXERCISE

The Transmitter was operated in the normal operating mode. The TX frequency was fixed which was for the purpose of the measurements.

2.3 GENERAL TECHNICAL REQUIREMENTS

For FCC Part 90 requirements:

- (1). Section 15.207: Conducted Limits
- (2). Section 90.205: Maximum ERP is dependent upon the station's antenna HAAT and required service area
- (3). Section 90.207: Modulation Characteristic
- (4). Section 90.209: Occupied Bandwidth
- (5). Section 90.210: Emission Mask
- (6). Section 90.213: Frequency Tolerance
- (7). Section 90.214: Transient Frequency Behavior
- (8). Section 15.109: Radiated Emission

2.4 CONFIGURATION OF TESTED SYSTEM

Fig. 2-1 Configuration of Tested System

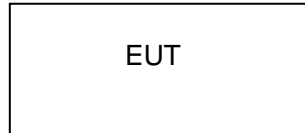

Table 2-1 Equipment Used in Tested System

Item	Equipment	Model No.	Identifier	Note
1	TWO WAY RADIO	628G	FCC ID: T4K-QZQX628G	EUT
2	Power Adapter	QPS-02	Input: AC 100-240V, 50/60HZ, 0.3A Output: 5V, 0.5A	Accessory
3	Battery	QB-27L	DV 7.4V, 1500mAh	Accessory

3. SUMMARY OF TEST RESULTS

FCC Rules	Description Of Test	Result
§15.207	Conducted Emission	Compliant
§90.205	Maximum Transmitter Power	Compliant
§90.207	Modulation Characteristic	Compliant
§90.209	Occupied Bandwidth	Compliant
§90.210	Emission Mask	Compliant
§90.213	Frequency Tolerance	Compliant
§90.214	Transient Frequency Behavior	Compliant
§15.109	Radiated Emission	Compliant

4. DESCRIPTION OF TEST MODES

RF TEST MODES

The EUT (VHF FM HANDHELD TRANSCEIVER) has been tested under normal operating condition. (The top channel, the middle channel and the bottom channel) are chosen for testing at each channel separation.

No.	TEST MODES	CHANNEL SEPARATION
1	Low Channel	12.5 KHz
2	Middle Channel	12.5 KHz
3	High Channel	12.5 KHz

EMC TEST MODES

No.	TEST MODES
1	Standby Mode + (Charging)

Note: Only the result of the worst case was recorded in the report.

5. CONDUCTED LIMITS

5.1 PROVISIONS APPLICABLE

For an intentional radiator that is designed to be connected to the public utility (AC) power line, the, the radio frequency voltage that is conducted back onto the AC power line on any frequencies within the band 150 KHz to 30 MHz shall not exceed the limits in the following table, as measured using a 50uH/50 ohms line impedance stabilization network (LISN). Compliance with the provisions of this paragraph shall be based on the measurement of the radio frequency voltage between each power line and ground at the power terminal. The lower limit applies at the boundary between the frequencies ranges.

Frequency of Emission (MHz)	Conducted Limit(dBuV)	
	Quasi-Peak	Average
0.15 – 0.5	66 to 56 *	56 to 46 *
0.5 – 5	56	46
5 – 30	60	50

* Decreases with the logarithm of the frequency.

5.2 MEASUREMENT PROCEDURE

- (1) The equipment was set up as per the test configuration to simulate typical actual usage per the user's manual. When the EUT is a tabletop system, a wooden table with a height of 0.8 meters is used and is placed on the ground plane as per ANSI C63.4 (see Test Facility for the dimensions of the ground plane used). When the EUT is a floor-standing equipment, it is placed on the ground plane which has a 3-12 mm non-conductive covering to insulate the EUT from the ground plane.
- (2) Support equipment, if needed, was placed as per ANSI C63.4.
- (3) All I/O cables were positioned to simulate typical actual usage as per ANSI C63.4.
- (4) The EUT received power through a Line Impedance Stabilization Network (LISN) which supplied power source and was grounded to the ground plane.
- (5) All support equipments received AC power from a second LISN, if any.
- (6) The EUT test program was started. Emissions were measured on each current carrying line of the EUT using a spectrum Analyzer / Receiver connected to the LISN powering the EUT. The LISN has two monitoring points: Line 1 (Hot Side) and Line 2 (Neutral Side). Two scans were taken: one with Line 1 connected to Analyzer / Receiver and Line 2 connected to a 50 ohm load; the second scan had Line 1 connected to a 50 ohm load and Line 2 connected to the Analyzer / Receiver.
- (7) Analyzer / Receiver scanned from 150 KHz to 30MHz for emissions in each of the test modes.
During the above scans, the emissions were maximized by cable manipulation.

5.3 TEST SETUP BLOCK DIAGRAM

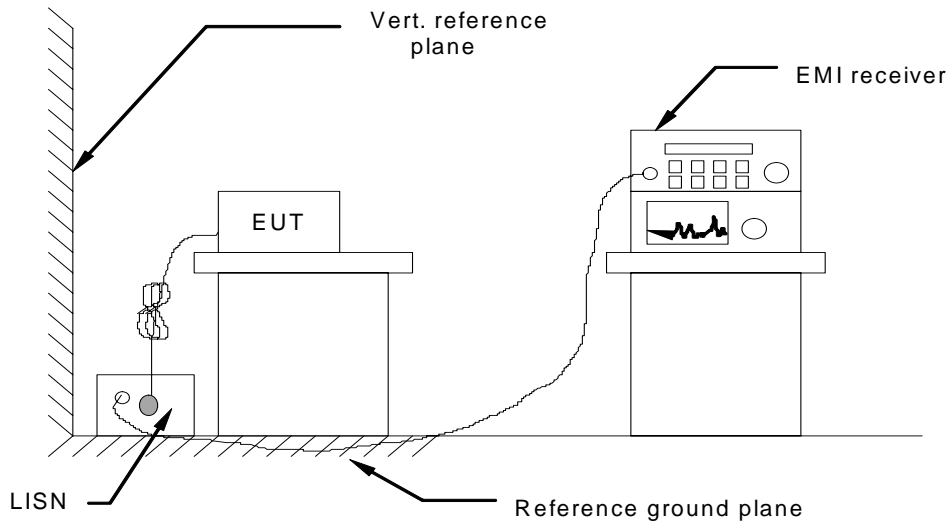

5.4 TEST EQUIPMENT USED

Conducted Emission Test Site					
Name of Equipment	Manufacturer	Model	Serial Number	Cal. Date	Cal. Due
TEST RECEIVER	R&S	ESCI	N/A	07/18/2013	07/17/2014
LISN	R&S	ESH3-Z5	N/A	07/18/2013	07/17/2014

5.5 TEST RESULT

CONDUCTED EMISSION TEST – LINE L1

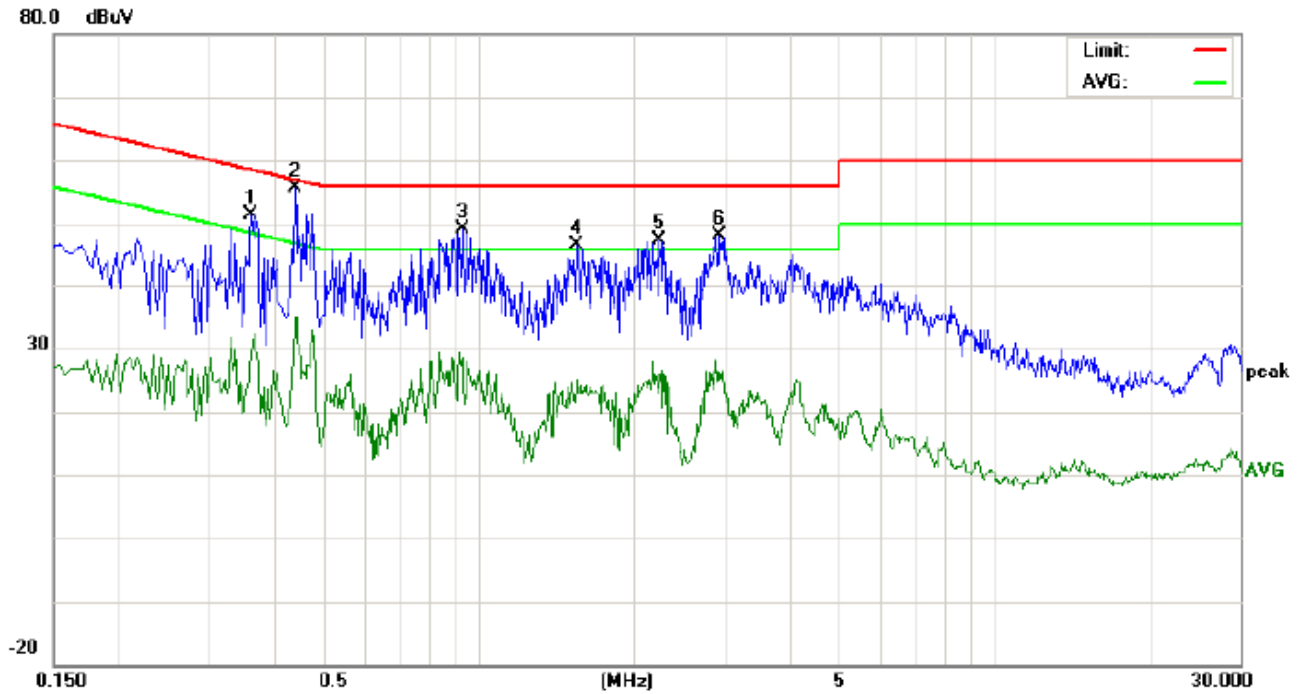

Site: Conduction Phase: **L1** Temperature: 26
 Limit: FCC Class B Conduction(QP) Power: Humidity: 60 %
 EUT: TWO WAY RADIO
 M/N: 628G
 Mode: Mode 1
 Note:

No.	Freq. (MHz)	Reading_Level (dBuV)			Correct Factor (dB)	Measurement (dBuV)			Limit (dBuV)		Margin (dB)		P/F	Comment
		Peak	QP	AVG		Peak	QP	AVG	QP	AVG	QP	AVG		
1	0.3620	41.18		19.04	10.31	51.49		29.35	58.68	48.68	-7.19	-19.33	P	
2	0.4420	45.17	36.80	22.53	10.36	55.53	47.16	32.89	57.02	47.02	-9.86	-14.13	P	
3	0.9300	38.76		18.28	10.40	49.16		28.68	56.00	46.00	-6.84	-17.32	P	
4	1.5540	36.19		14.84	10.36	46.55		25.20	56.00	46.00	-9.45	-20.80	P	
5	2.2460	37.13		14.12	10.32	47.45		24.44	56.00	46.00	-8.55	-21.56	P	
6	2.9380	37.68		14.58	10.54	48.22		25.12	56.00	46.00	-7.78	-20.88	P	

CONDUCTED EMISSION TEST – LINE N

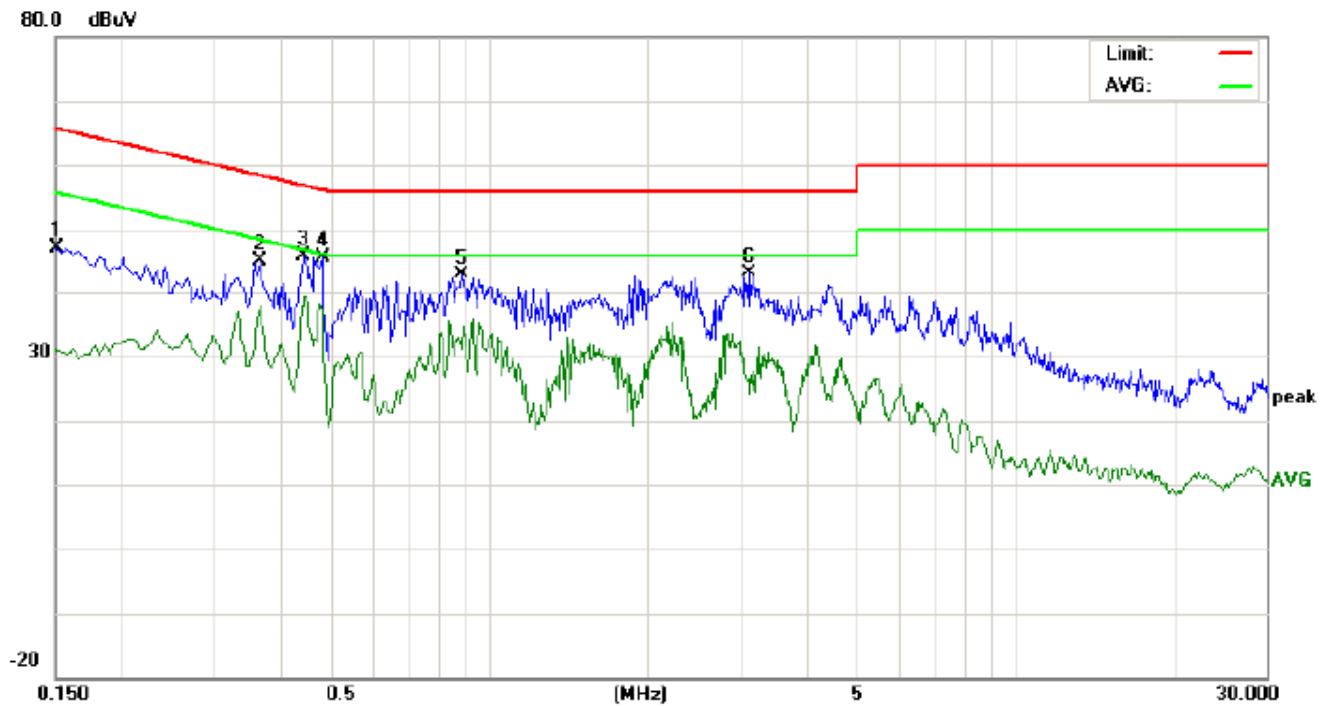

Site: Conduction Phase: **N** Temperature: 26
Limit: FCC Class B Conduction(QP) Power: Humidity: 60 %
EUT: TWO WAY RADIO
M/N: 628G
Mode: Mode 1
Note:

No.	Freq. (MHz)	Reading_Level (dBuV)			Correct Factor (dB)	Measurement (dBuV)			Limit (dBuV)		Margin (dB)		P/F	Comment
		Peak	QP	AVG		Peak	QP	AVG	QP	AVG	QP	AVG		
1	0.1500	36.94		20.94	10.16	47.10		31.10	65.99	55.99	-18.89	-24.89	P	
2	0.3660	34.86		27.59	10.32	45.18		37.91	58.59	48.59	-13.41	-10.68	P	
3	0.4460	35.53		29.00	10.36	45.89		39.36	56.95	46.95	-11.06	-7.59	P	
4	0.4820	35.34		26.64	10.39	45.73		37.03	56.30	46.30	-10.57	-9.27	P	
5	0.8860	32.56		20.80	10.39	42.95		31.19	56.00	46.00	-13.05	-14.81	P	
6	3.1140	32.48		16.19	10.54	43.02		26.73	56.00	46.00	-12.98	-19.27	P	

6. FREQUENCY TOLERANCE

6.1 PROVISIONS APPLICABLE

- a). According to FCC Part 2 Section 2.1055(a)(1), the frequency stability shall be measured with variation of ambient temperature from -30°C to $+50^{\circ}\text{C}$ centigrade.
- b). According to FCC Part 2 Section 2.1055(d)(2), for battery powered equipment, the frequency stability shall be measured with reducing primary supply voltage to the battery operating end point, which is specified by the manufacturer.
- c). According to FCC Part 90 Section 90.213, the frequency tolerance must be maintained within 0.00025% for 12.5 KHz channel separation and 0.0001% for 6.25 KHz channel separation.
- d). According to RSS-119 Section 119.5.3, the frequency tolerance must be maintained within 0.00025% for 12.5 KHz channel separation and 0.0005% for 25KHz channel separation.

6.2 MEASUREMENT PROCEDURE

6.2.1 Frequency stability versus environmental temperature

1. Setup the configuration per figure 1 for frequencies measurement inside an environment chamber, Install new battery in the EUT.
2. Turn on EUT and set SA center frequency to the EUT radiated frequency. Set SA Resolution Bandwidth to 1KHz and Video Resolution Bandwidth to 1KHz and Frequency Span to 50KHz. Record this frequency as reference frequency.
3. Set the temperature of chamber to 50°C . Allow sufficient time (approximately 30 min) for the temperature of the chamber to stabilize. While maintaining a constant temperature inside the chamber, turn the EUT on and measure the EUT operating frequency.
4. Repeat step 2 with a 10°C decreased per stage until the lowest temperature -30°C is measured, record all measured frequencies on each temperature step.

6.2.2 Frequency stability versus input voltage

1. Setup the configuration per figure 1 for frequencies measured at temperature if it is within 15°C to 25°C . Otherwise, an environment chamber set for a temperature of 20°C shall be used. The EUT shall be powered by DC 7.4V
2. Set SA center frequency to the EUT radiated frequency. Set SA Resolution Bandwidth to 1 KHz and Video Resolution Bandwidth to 1KHz. Record this frequency as reference frequency.
3. Supply the EUT primary voltage at the battery end point which is specified by manufacturer and record the frequency.

6.3 TEST SETUP BLOCK DIAGRAM

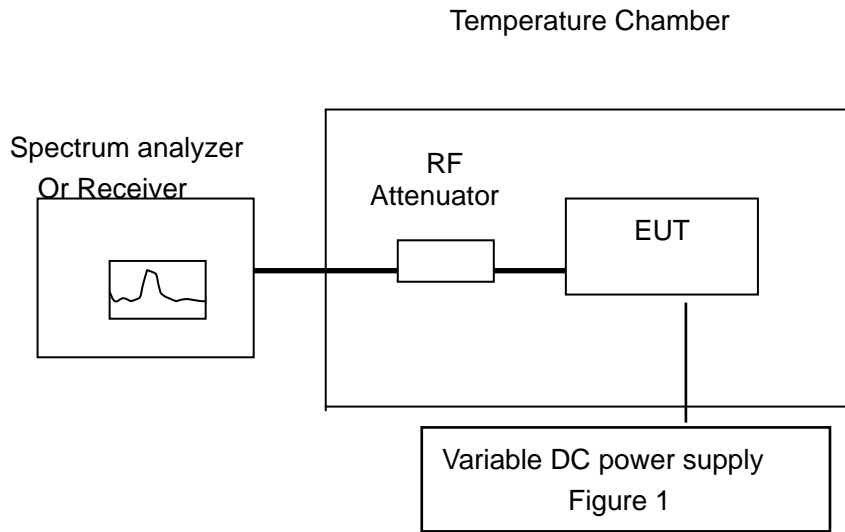

6.4 TEST EQUIPMENT USED:

NAME OF EQUIPMENT	MANUFACTURER	MODEL	SERIAL NUMBER	Cal. Date	Cal. Due
Receiver	R&S	ESCI	N/A	07/18/2013	07/17/2014
Climate Chamber	EXPERY	TN-400	N/A	07/18/2013	07/17/2014

6.5 TEST RESULT

Frequency stability versus input voltage (Supply nominal voltage is 7.4V)

Bottom Channel @ 12.5 KHz Channel Separation

Reference Frequency:	400.025 MHz	Limit:	2.5ppm
Environment Temperature	Power Supply	Frequency Deviation	
(°C)	(V)	(MHz)	ppm
50	7.4	400.025301	0.752
40	7.4	400.025317	0.792
30	7.4	400.025299	0.747
20	7.4	400.025282	0.705
10	7.4	400.025278	0.695
0	7.4	400.025226	0.565
-10	7.4	400.025334	0.835
-20	7.4	400.025341	0.852
-30	7.4	400.025309	0.772

Middle Channel @ 12.5 KHz Channel Separation

Reference Frequency:	440.000 MHz	Limit:	2.5ppm
Environment Temperature	Power Supply	Frequency Deviation	
(°C)	(V)	(MHz)	ppm
50	7.4	440.000357	0.811
40	7.4	440.000283	0.643
30	7.4	440.000285	0.648
20	7.4	440.000271	0.616
10	7.4	440.000269	0.611
0	7.4	440.000256	0.582
-10	7.4	440.000252	0.573
-20	7.4	440.000274	0.623
-30	7.4	440.000277	0.630

Top Channel @ 12.5 KHz Channel Separation

Reference Frequency:	479.975 MHz	Limit:	2.5ppm
Environment Temperature	Power Supply	Frequency Deviation	
(°C)	(V)	(MHz)	ppm
50	7.4	479.975374	0.779
40	7.4	479.975372	0.775
30	7.4	479.975355	0.740
20	7.4	479.975349	0.727
10	7.4	479.975342	0.713
0	7.4	479.975333	0.694
-10	7.4	479.975357	0.744
-20	7.4	479.975342	0.713
-30	7.4	479.975365	0.760

(2) Frequency stability versus input voltage (Battery Limiting voltage is 6.29V)

Low Channel @ 12.5 KHz Channel Separation

Reference Frequency:	400.025 MHz	Limit:	2.5ppm
Environment Temperature	Power Supply	Frequency Deviation	
(°C)	(V)	(MHz)	ppm
50	DC 6.29 V	400.025276	0.690
40	DC 6.29 V	400.025293	0.732
30	DC 6.29 V	400.025282	0.705
20	DC 6.29 V	400.025287	0.717
10	DC 6.29 V	400.025263	0.657
0	DC 6.29 V	400.025281	0.702
-10	DC 6.29 V	400.025275	0.687
-20	DC 6.29 V	400.025283	0.707
-30	DC 6.29 V	400.025252	0.630

Middle Channel @ 12.5 KHz Channel Separation

Reference Frequency:	440.000 MHz	Limit:	2.5ppm
Environment Temperature	Power Supply	Frequency Deviation	
(°C)	(V)	(MHz)	ppm
50	DC 6.29 V	440.000298	0.677
40	DC 6.29 V	440.000276	0.627
30	DC 6.29 V	440.000269	0.611
20	DC 6.29 V	440.000257	0.584
10	DC 6.29 V	440.000258	0.586
0	DC 6.29 V	440.000268	0.609
-10	DC 6.29 V	440.000284	0.645
-20	DC 6.29 V	440.000285	0.648
-30	DC 6.29 V	440.000279	0.634

High Channel @ 12.5 KHz Channel Separation

Reference Frequency:	479.975 MHz	Limit:	2.5ppm
Environment Temperature	Power Supply	Frequency Deviation	
(°C)	(V)	(MHz)	ppm
50	DC 6.29 V	479.975296	0.617
40	DC 6.29 V	479.975285	0.594
30	DC 6.29 V	479.975276	0.575
20	DC 6.29 V	479.975244	0.508
10	DC 6.29 V	479.975237	0.494
0	DC 6.29 V	479.975222	0.463
-10	DC 6.29 V	479.975229	0.477
-20	DC 6.29 V	479.975238	0.496
-30	DC 6.29 V	479.975257	0.535

7. EMISSION BANDWIDTH

7.1 PROVISIONS APPLICABLE

According to FCC Part 90 Section 90.209: The authorized bandwidth shall be 11.25 KHz for 12.5 KHz channel separation and 6 KHz for 6.25 KHz channel separation.

According to RSS-119 Section 119.5.5: The authorized bandwidth shall be 11.25 KHz for 12.5 KHz

7.2 MEASUREMENT PROCEDURE

- 1). The EUT was placed on a turntable which is 0.8m above ground plane.
- 2). The EUT was modulated by 2.5 KHz Sine wave audio signal, The level of the audio signal employed is 16 dB greater than that necessary to produce 50% of rated system deviation. Rated system deviation is 2.5 kHz (12.5 kHz channel spacing).
- 3). Set SPA Center Frequency = fundamental frequency, RBW=VBW= 300 Hz, Span =50 KHz.
- 4). Set SPA Max hold. Mark peak, -26 dB.

7.3 TEST SETUP BLOCK DIAGRAM

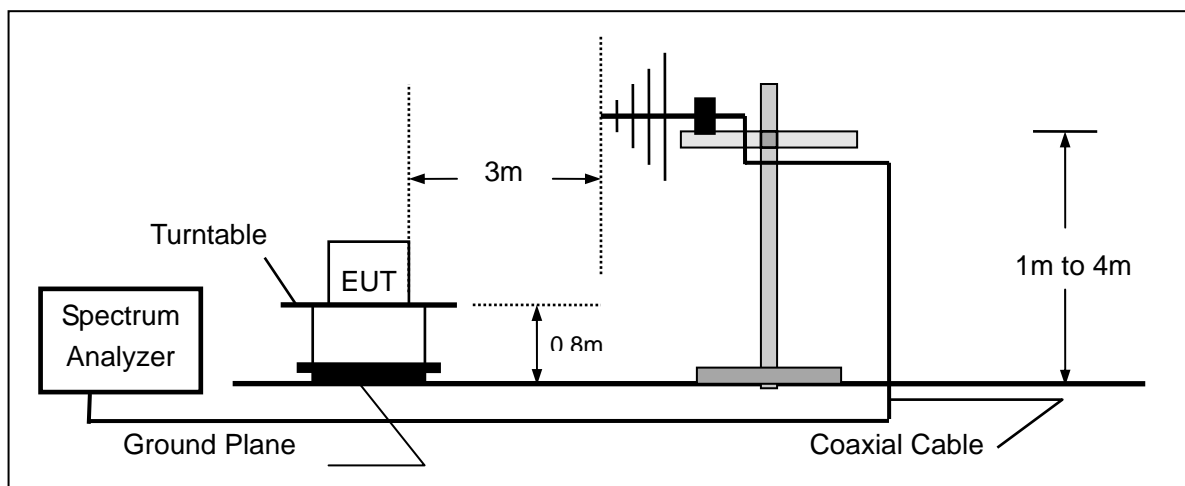

7.4 MEASUREMENT EQUIPMENT USED:

NAME OF EQUIPMENT	MANUFACTURER	MODEL	SERIAL NUMBER	Cal. Date	Cal. Due
SPECTRUM ANALYZER	AGILENT	E4440A	US44300399	07/18/2013	07/17/2014
MODULATION ANALYZER	HP	8920B	3104A03367	07/18/2013	07/17/2014
BROADBAND ANT.	A.H.	SAS-521-4	A0304224	06/08/2013	06/07/2014

7.5 MEASUREMENT RESULT:

26 dB Bandwidth Measurement Result			
Operating Frequency	12.5 KHz Channel Separation		
	Test Data	Limits	Result
136.025MHz	10.42KHz	11.25 KHz	Pass
155.000MHz	10.44KHz	11.25 KHz	Pass
173.975MHz	10.40KHz	11.25 KHz	Pass

Occupied bandwidth of Middle Channel (Maximum) @ 12.5 KHz Channel Separation

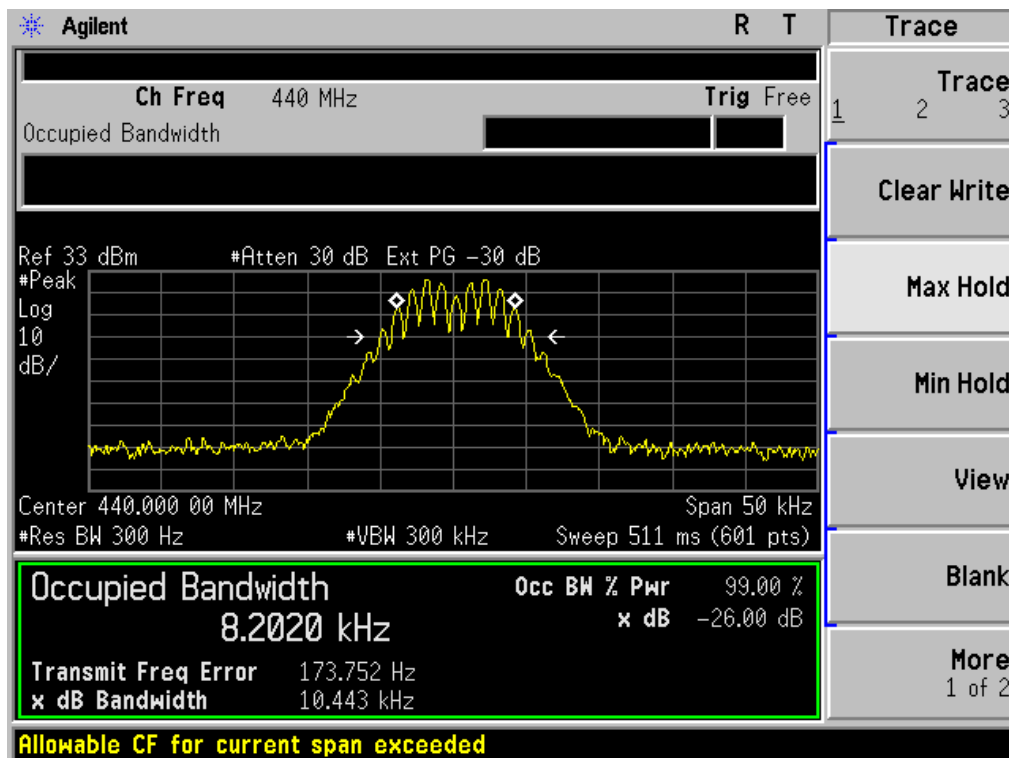

8. UNWANTED RADIATION

8.1 PROVISIONS APPLICABLE

8.1.1 According to Section 90.210, the power of each unwanted emission shall be less than Transmitted Power as specified below for transmitters designed to operate with each channel separation.

According to RSS-119 Section 119.5.8, the power of each unwanted emission shall be less than Transmitted Power as specified below for transmitters with each channel separation.

For 12.5 KHz Channel Separation:

- (1). On any frequency removed from the center of the authorized bandwidth f_0 to 5.625 KHz removed from f_0 : Zero dB.
- (2). On any frequency removed from the center of the authorized bandwidth by a displacement Frequency (f_d in KHz) f_0 of more than 5.625 KHz but no more than 12.5 KHz: At least $7.27(f_d - 2.88 \text{ KHz})$ dB
- (3). On any frequency removed from the center of the authorized bandwidth by a displacement Frequency (f_d in KHz) f_0 of more than 12.5 KHz: At least $50 + 10 \log(P)$ dB or 70 dB, whichever is lesser attenuation.

For 6.25 KHz Channel Separation:

- (1). On any frequency from the center of the authorized bandwidth f_0 to 3.0 kHz removed from f_0 : Zero dB.
- (2). On any frequency removed from the center of the authorized bandwidth by a displacement frequency (f_d in kHz) of more than 3.0 kHz but no more than 4.6 kHz: At least $30 + 16.67(f_d - 3 \text{ kHz})$ or $55 + 10 \log(P)$ or 65 dB, whichever is the lesser attenuation.
- (3). On any frequency removed from the center of the authorized bandwidth by more than 4.6 kHz: At least $55 + 10 \log(P)$ or 65 dB, whichever is the lesser attenuation.

8.2 MEASUREMENT PROCEDURE

- (1) On a test site, the EUT shall be placed on a turntable, and in the position closest to the normal use as declared by the user.
- (2) The test antenna shall be oriented initially for vertical polarization located 3m from the EUT to correspond to the transmitter.
- (3) The output of the antenna shall be connected to the measuring receiver and either a peak or quasi-peak detector was used for the measurement as indicated on the report. The detector selection is based on how close the emission level was approaching the limit.
- (4) The transmitter shall be switched on; if possible, without the modulation and the measurement receiver shall be tuned to the frequency of the transmitter under test.
- (5) The test antenna shall be raised and lowered through the specified range of height until the measuring receiver detects a maximum signal level.
- (6) The transmitter shall then be rotated through 360° in the horizontal plane, until the maximum signal level is detected by the measuring receiver.
- (7) The test antenna shall be raised and lowered again through the specified range of height until the

measuring receiver detects a maximum signal level.

- (8) The maximum signal level detected by the measuring receiver shall be noted.
- (9) The measurement shall be repeated with the test antenna set to horizontal polarization.
- (10) Replace the antenna with a proper Antenna (substitution antenna).
- (11) The substitution antenna shall be oriented for vertical polarization and, if necessary, the length of the substitution antenna shall be adjusted to correspond to the frequency of transmitting.
- (12) The substitution antenna shall be connected to a calibrated signal generator.
- (13) If necessary, the input attenuator setting of the measuring receiver shall be adjusted in order to increase the sensitivity of the measuring receiver.
- (14) The test antenna shall be raised and lowered through the specified range of the height to ensure that the maximum signal is received.
- (15) The input signal to substitution antenna shall be adjusted to the level that produces a level detected by the measuring receiver, that is equal to the level noted while the transmitter radiated power was measured, corrected for the change of input attenuation setting of the measuring receiver.
- (16) The input level to the substitution antenna shall be recorded as power level in dBm, corrected for any change of input attenuator setting of the measuring receiver.
- (17) The measurement shall be repeated with the test antenna and the substitution antenna oriented for horizontal polarization.

8.3 TEST SETUP BLOCK DIAGRAM

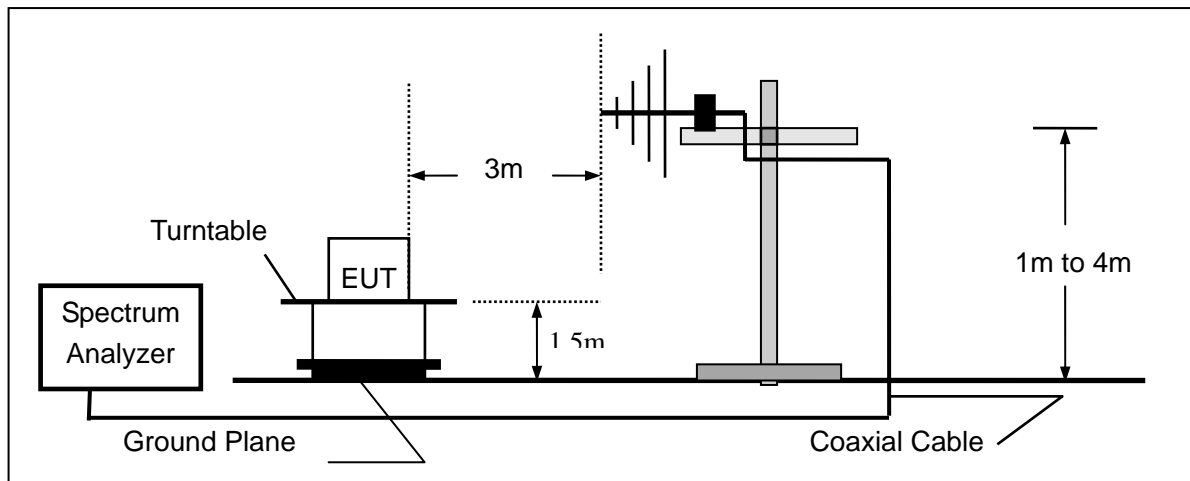

SUBSTITUTION METHOD: (Radiated Emissions)

Radiated Below 1GHz

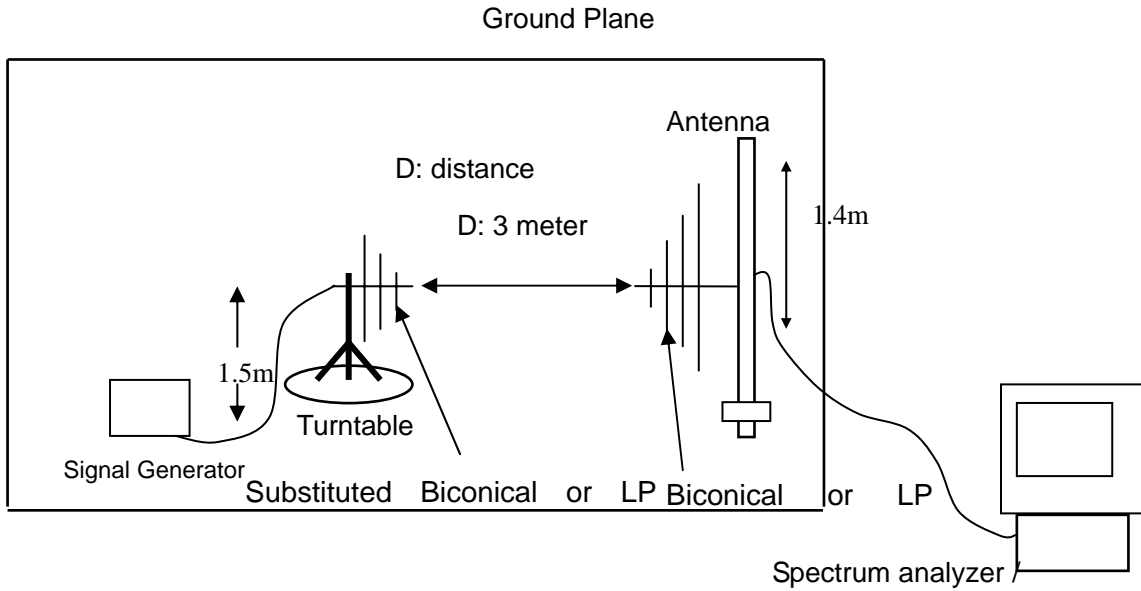

Radiated Above 1 GHz

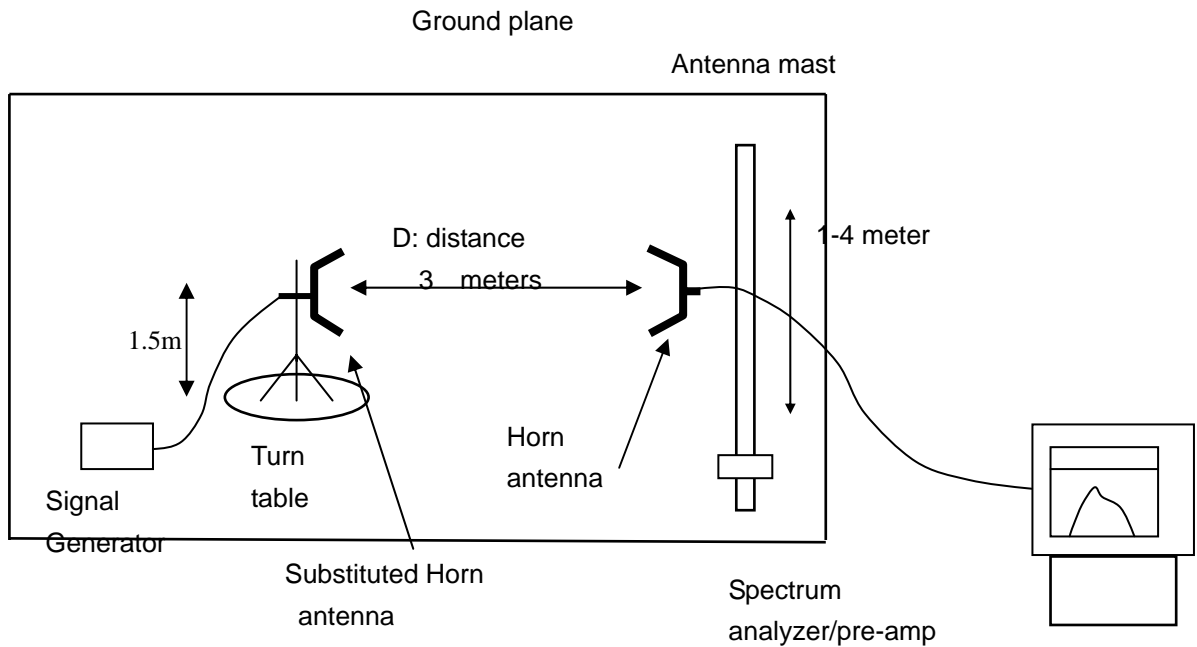

8.4 MEASUREMENT EQUIPMENT USED:

NAME OF EQUIPMENT	MANUFACTURER	MODEL	SERIAL NUMBER	Cal. Date	Cal. Due
SPECTRUM ANALYZER	AGILENT	E4440A	US44300399	07/18/2013	07/17/2014
HORN ANT.	EM	EM-AH-10180	100150	04/21/2013	04/20/2014
BROADBAND ANT.	A.H.	SAS-521-4	A0304224	06/08/2013	06/07/2014
AMPLIFIER	EM	EM30180	0607030	07/18/2013	07/17/2014
POSITIONING CONTROLLER	MF	MF-7802	MF780208147	--	--
Horn Antenna	A.H. Systems Inc.	SAS-574	--	07/17/2013	07/16/2014
SIGNAL GENERATOR	Agilent	E4421B	122501288	07/17/2013	07/16/2014

8.5 MEASUREMENT RESULTS:

Measurement Result for 12.5 KHz Channel Separation

On any frequency removed from the center of the authorized bandwidth by a displacement

Frequency (f_d in KHz) f_o of more than 12.5 KHz: At least $50 + 10 \log(P)$ dB or 70 dB, which ever is lesser attenuation.

Limit: At least $50 + 10 \log(P) = 50 + 10 \log(2) = 53$ (dB)

TEST RESULT FOR UHF

Measurement Result for 12.5 KHz Channel Separation @ 400.025MHz

Emission Frequency (MHz)	Ant. Polarity(H/V)	Measurement Result Below carrier(dBc)	Limit below carrier(dBc)	Result(P/F)
400.075	V	0		pass
800.150	V	66.11(-33.10dBm)	53	pass
1200.23	V	69.4	53	pass
1600.300	V	70.4	53	pass
2000.375	V	71.56	53	pass
2400.450	V	74.06	53	pass
2800.525	V	74.86	53	pass
3200.600	V	76.58	53	pass
3600.675	V	77.84	53	pass
4000.750	V	79.38	53	pass

Measurement Result for 12.5 KHz Channel Separation @ 440.000MHz

Emission Frequency (MHz)	Ant. Polarity(H/V)	Measurement Result Below carrier(dBc)	Limit below carrier(dBc)	Result(P/F)
440.000	V	0		pass
880.000	V	66.64(-33.63dBm)	53	pass
1320.000	V	66.85(-33.84dBm)	53	pass
1760.000	V	69.56	53	pass
2200.000	V	72.92	53	pass
2640.000	V	73.14	53	pass
3080.000	V	74.75	53	pass
3520.000	V	76.31	53	pass
3960.000	V	77.27	53	pass
4400.000	V	78.93	53	pass

Measurement Result for 12.5 KHz Channel Separation @ 479.975MHz

Emission Frequency (MHz)	Ant. Polarity(H/V)	Measurement Result Below carrier(dBc)	Limit below carrier(dBc)	Result(P/F)
479.975	V	0		pass
959.950	V	65.79(-32.78dBm)	53	pass
1439.925	V	69.58	53	pass
1919.900	V	70.83	53	pass
2399.875	V	71.48	53	pass
2879.850	V	72.86	53	pass
3359.825	V	75.61	53	pass
3839.800	V	76.51	53	pass
4319.775	V	77.42	53	pass
4799.750	V	78.79	53	pass

Notes: The emissions were scanned from 30 MHz to 10th harmonics.

8.6 EMISSION MASK PLOT

The detailed procedure employed for Emission Mask measurements are specified as following:

- The transmitter shall be modulated by a 2.5 kHz audio signal,
- The level of the audio signal employed is 16 dB greater than that necessary to produce 50% of rated system deviation. Rated system deviation is 2.5 kHz.

The Worst Emission Mask for 12.5 KHz channel Separation (2W)

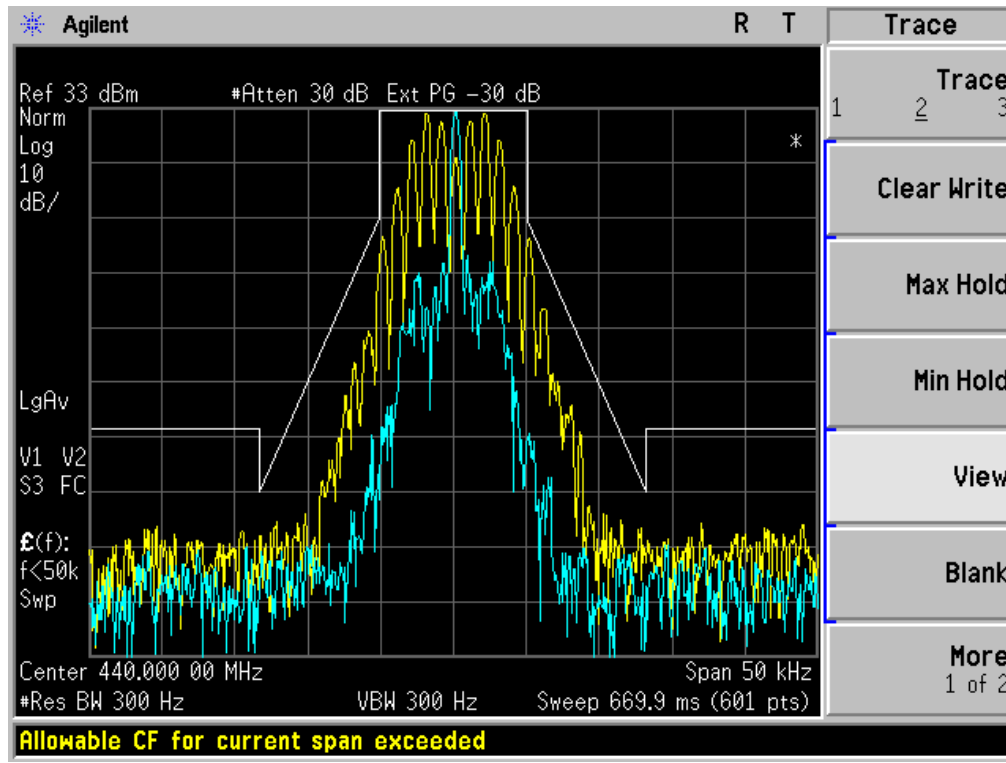

9. MODULATION CHARACTERISTICS

9.1 PROVISIONS APPLICABLE

According to CFR 47 section 2.1047(a), for Voice Modulation Communication Equipment, the frequency response of the audio modulation circuit over a range of 100 to 5000Hz shall be measured.

9.2 MEASUREMENT METHOD

9.2.1 Modulation Limit

- (1). Configure the EUT as shown in figure 1, adjust the audio input for 60% of rated system deviation at 1KHz using this level as a reference (0dB) and vary the input level from -20 to +20dB. Record the frequency deviation obtained as a function of the input level.
- (2). Repeat step 1 with input frequency changing to 300, 1000, 1500 and 3000Hz in sequence.

9.2.2 Audio Frequency Response

- (1). Configure the EUT as shown in figure 1.
- (2). Adjust the audio input for 20% of rated system deviation at 1 KHz using this level as a reference (0 dB).
- (3). Vary the Audio frequency from 100 Hz to 10 KHz and record the frequency deviation.
- (4). Audio Frequency Response = $20\log_{10}(\text{Deviation of test frequency}/\text{Deviation of 1 KHz reference})$.

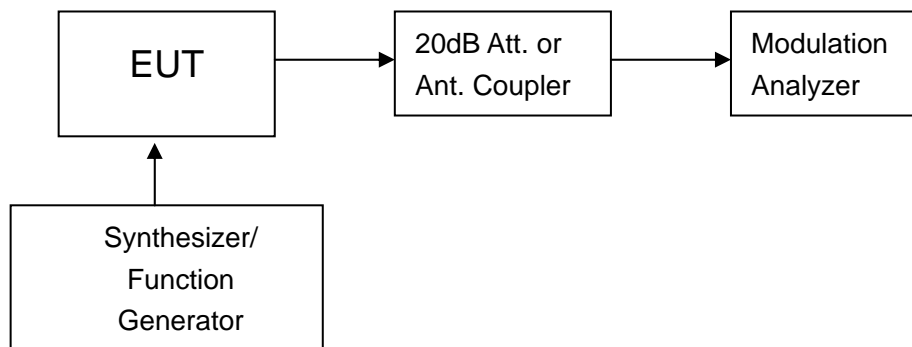

Figure 1: Modulation characteristic measurement configuration

9.3 MEASUREMENT INSTRUMENTS

NAME OF EQUIPMENT	MANUFACTURER	MODEL	SERIAL NUMBER	Cal. Date	Cal. Due
Modulation Analyzer	HP	8920B	3104A03367	07/18/2013	07/17/2014

NOTE: 8920B can generate audio modulation frequency.

9.4 MEASUREMENT RESULT

(A). MODULATION LIMIT:

Middle Channel @ 12.5 KHz Channel Separations (VHF)

Modulation Level (dB)	Peak Freq. Deviation At 300 Hz	Peak Freq. Deviation At 1000 Hz	Peak Freq. Deviation At 1500 Hz	Peak Freq. Deviation At 3000 Hz
-20	0.25	0.84	0.89	0.91
-15	0.38	0.96	1.01	1.12
-10	0.49	1.27	1.31	1.38
-5	0.56	1.36	1.46	1.51
0	0.69	1.52	1.57	1.61
+5	0.75	1.64	1.76	1.88
+10	0.85	1.76	1.81	1.89
+15	0.99	1.67	1.75	1.85
+20	0.87	1.57	1.66	1.76

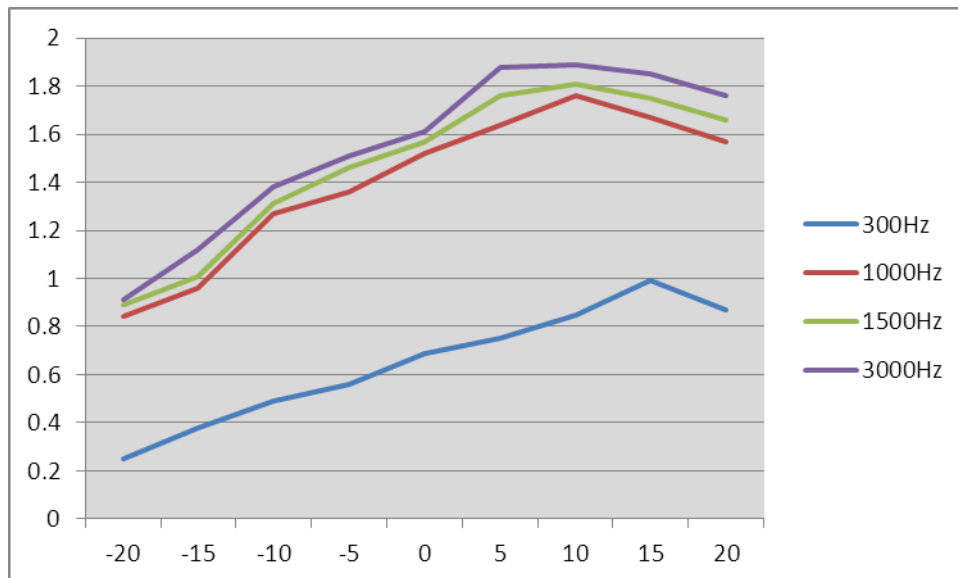

Note: All the modes had been tested, but only the worst data recorded in the report.

(B). AUDIO FREQUENCY RESPONSE:

Middle Channel @ 12.5 KHz Channel Separations (VHF)

Frequency (Hz)	Deviation (KHz)	Audio Frequency Response(dB)
100	--	--
200	--	--
300	0.21	-11.62
400	0.29	-8.81
500	0.41	-5.81
600	0.49	-4.26
700	0.57	-2.94
800	0.62	-2.21
900	0.72	-0.92
1000	0.84	0.42
1200	0.99	1.85
1400	1.28	4.08
1600	1.39	4.80
1800	1.45	5.17
2000	1.5	5.46
2400	1.55	5.74
2500	1.6	6.02
2800	1.63	6.18
3000	1.66	6.34
3200	1.50	5.46
3600	1.45	5.17
4000	1.19	3.45
4500	0.91	1.12
5000	0.66	-1.67
5500	0.46	-4.81
6000	0.35	-7.18
6500	0.24	-10.46
7000	0.16	-13.98
7500	0.08	-16.99
9000	--	--
10000	--	--
14000	--	--
18000	--	--
20000	--	--
30000	--	--

Frequency Response of Middle Channel (VHF)

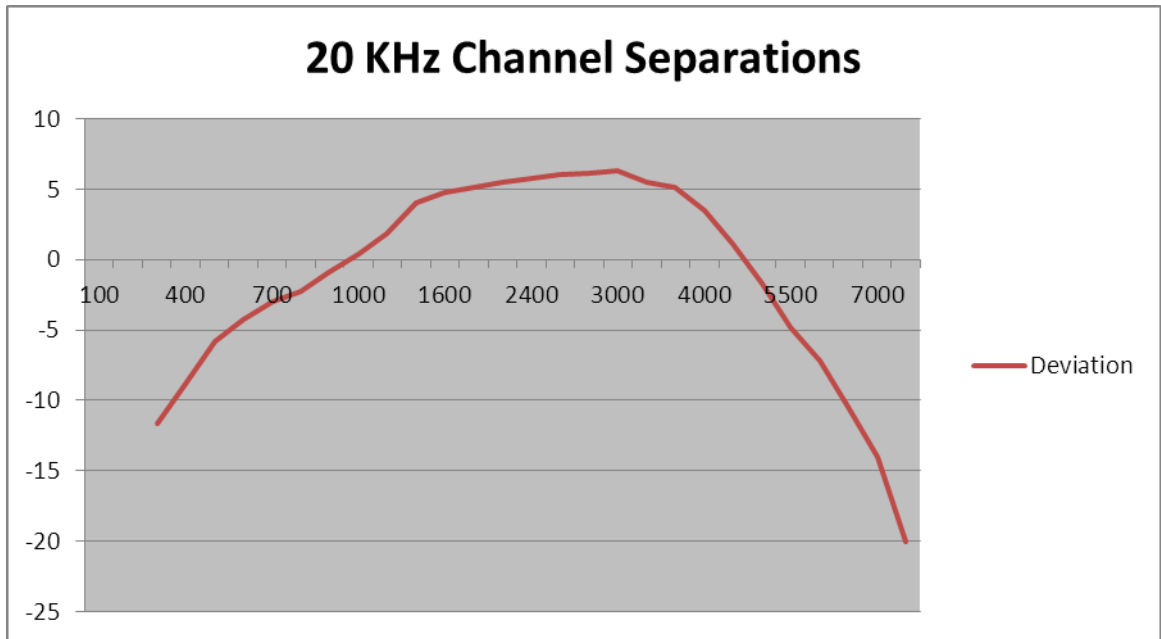

Note: All the modes had been tested, but only the worst data recorded in the report.

10. MAXIMUM TRANSMITTER POWER (CONDUCTED OUTPUT POWER)

10.1 PROVISIONS APPLICABLE

Per FCC §2.1046 and §90.205 AND RSS 119 Part 4.1: Maximum ERP is dependent upon the station's antenna HAAT and required service area.

10.2 TEST PROCEDURE

The RF output of Two-way Radio was conducted to a spectrum analyzer through an appropriate attenuator.

10.3 TEST INSTRUMENTS

NAME OF EQUIPMENT	MANUFACTURER	MODEL	SERIAL NUMBER	Cal. Date	Cal. Due
SPECTRUM ANALYZER	AGILENT	E4440A	US44300399	07/18/2013	07/17/2014

10.4 TEST CONFIGURATION

Conducted Output Power:

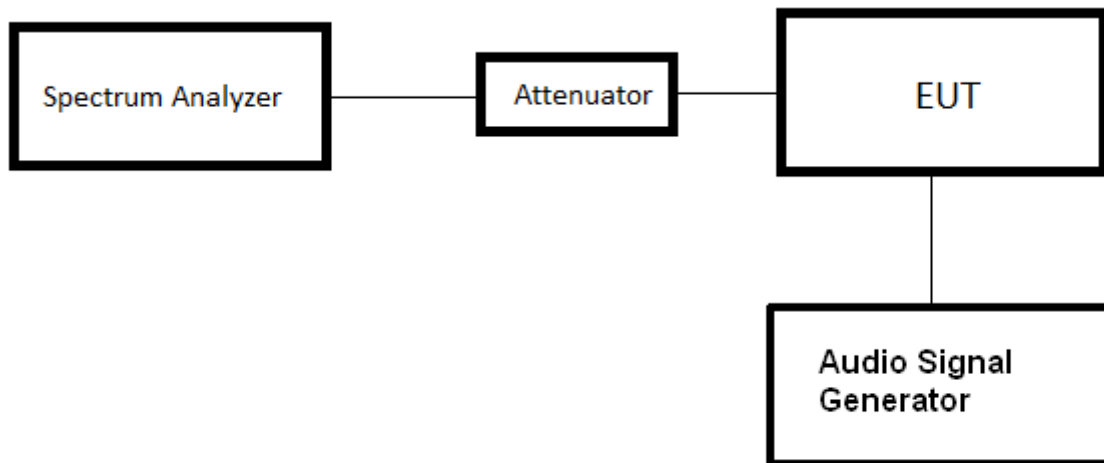

Effective Radiated Power measurement Below 1GHz

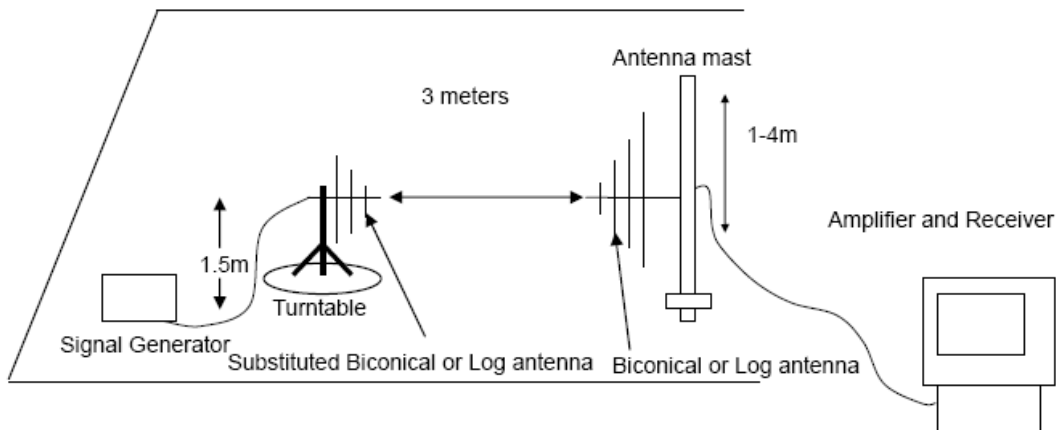
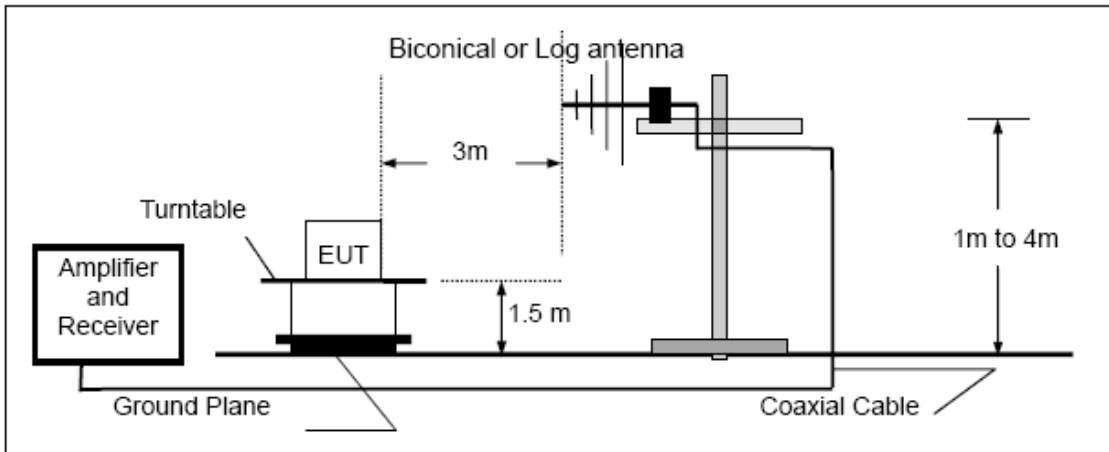

Above 1GHz

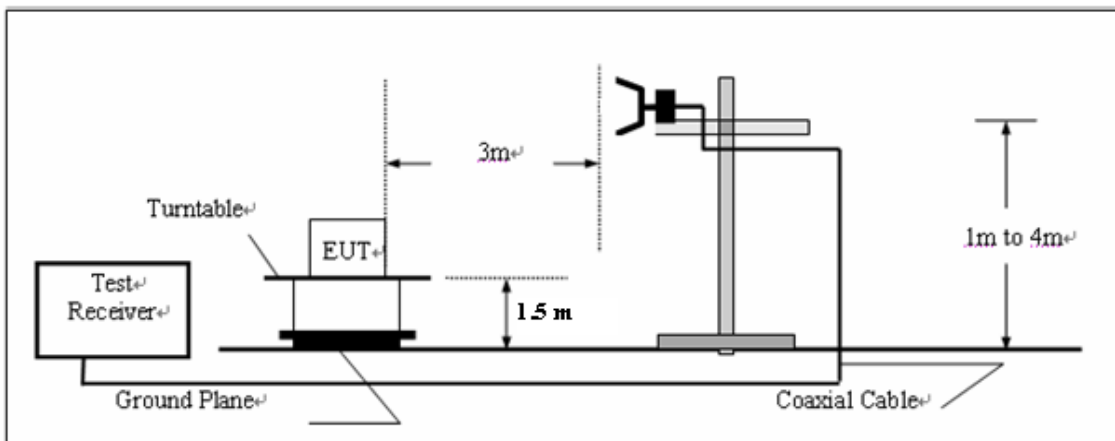

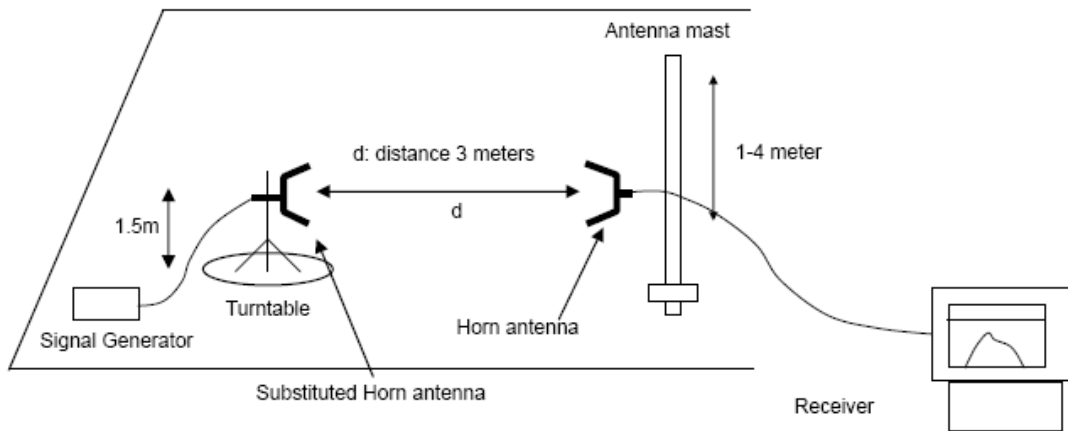

10.5 TEST RESULT

The maximum Conducted Power (CP) is
 60 W for 12.5 KHz Channel Separation

Calculation Formula: $CP = R + A + L$

* Note:

- CP: The final Conducted Power
- R : The reading value from spectrum analyzer
- A : The attenuation value of the used attenuator
- L : The loss of all connection cables

Conducted Power Measurement Results		
Channel Separation	Channel	Measurement Result (dBm)
		For 33.01dBm(2W)
12.5 KHz	Bottom(400.000MHz)	32.96
	Middle(440000MHz)	32.99
	Top (480.000MHz)	32.95

10.6 CONDUCT SPURIOUS PLOT

Conducted Spurious Emission (worst) @ 440.000MHz With 12.5 KHz Channel Separation 30MHz-1GHz

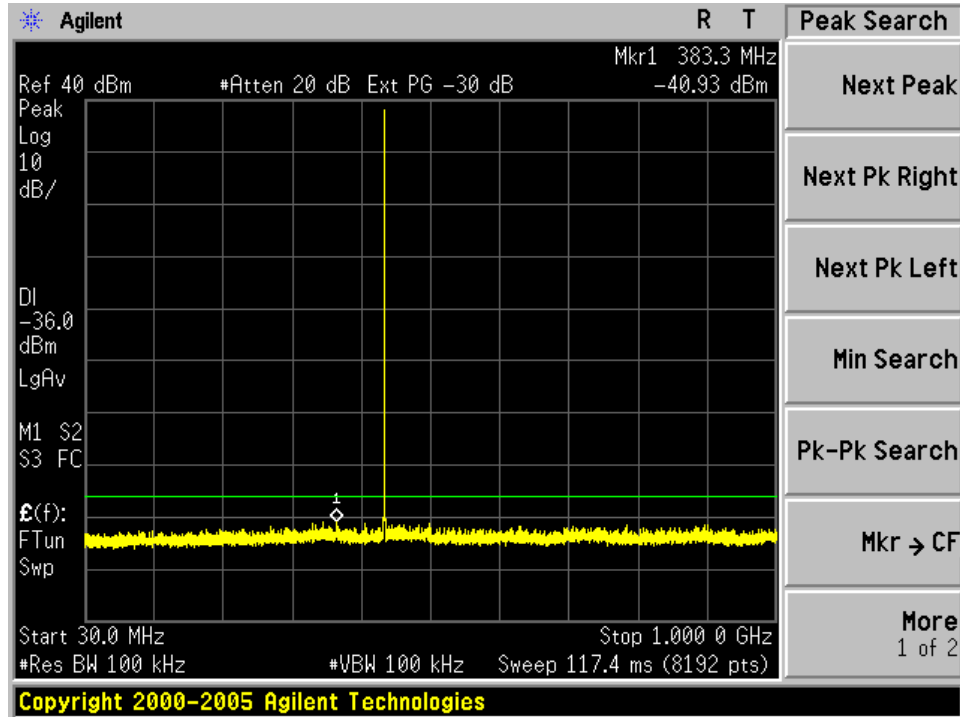

Conduct Spurious Emission (worst) @ 440.000MHz With 12.5 KHz Channel Separation 1GHz-9GHz

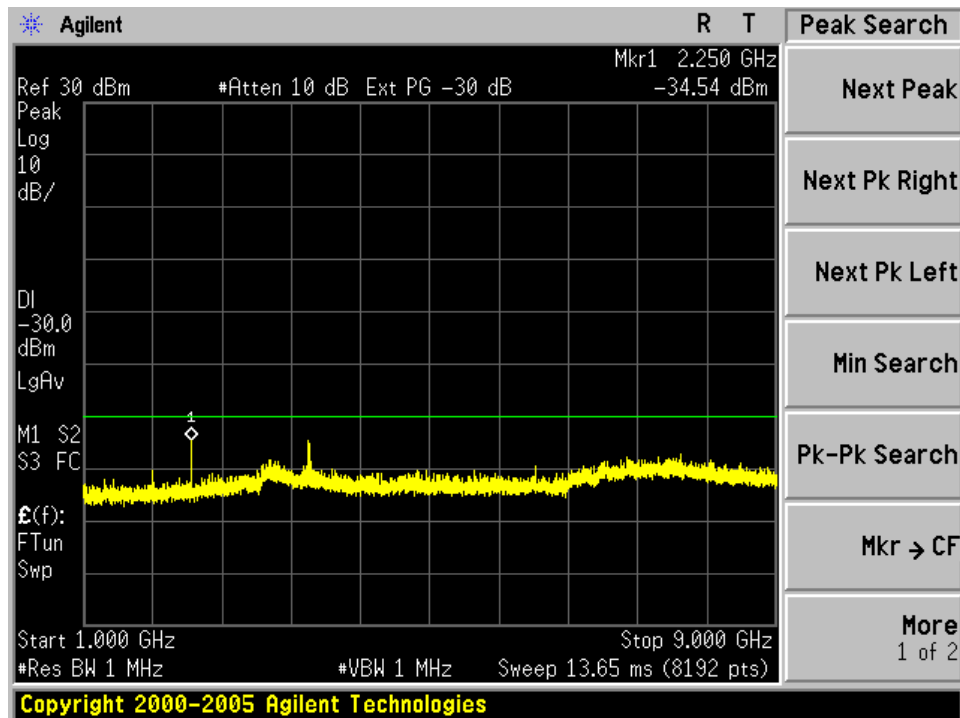

Conduct Spurious Emission (worst) @ 440.000MHz With 12.5 KHz Channel Separation
9GHz-12.75GHz

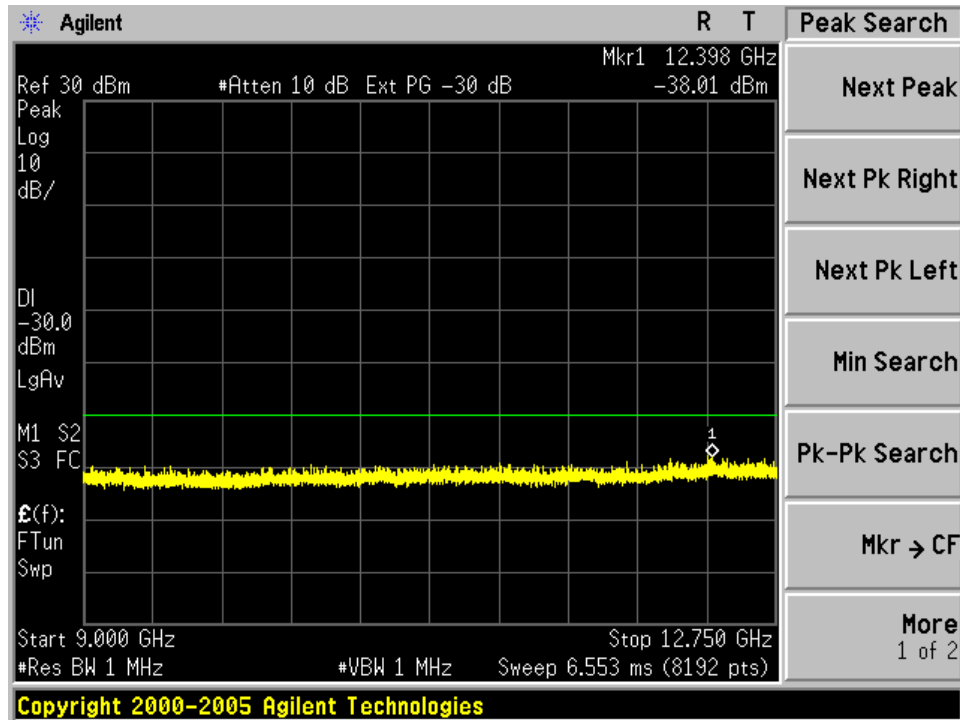

11. TRANSMITTER FREQUENCY BEHAVIOR

11.1 PROVISIONS APPLICABLE

Section 90.214

Time intervals ^{1, 2}	Maximum frequency difference ³	All equipment	
		150 to 174 MHz	421 to 512 MHz
Transient Frequency Behavior for Equipment Designed to Operate on 25 kHz Channels			
t ₁ ⁴	± 25.0 kHz	5.0 ms	10.0 ms
t ₂	± 12.5 kHz	20.0 ms	25.0 ms
t ₃ ⁴	± 25.0 kHz	5.0 ms	10.0 ms
Transient Frequency Behavior for Equipment Designed to Operate on 12.5 kHz Channels			
t ₁ ⁴	± 12.5 kHz	5.0 ms	10.0 ms
t ₂	± 6.25 kHz	20.0 ms	25.0 ms
t ₃ ⁴	± 12.5 kHz	5.0 ms	10.0 ms
Transient Frequency Behavior for Equipment Designed to Operate on 6.25 kHz Channels			
t ₁ ⁴	± 6.25 kHz	5.0 ms	10.0 ms
t ₂	± 3.125 kHz	20.0 ms	25.0 ms
t ₃ ⁴	± 6.25 kHz	5.0 ms	10.0 ms

¹ t_{on} is the instant when a 1 kHz test signal is completely suppressed, including any capture time due to phasing.

t₁ is the time period immediately following t_{on}.

t₂ is the time period immediately following t₁.

t₃ is the time period from the instant when the transmitter is turned off until t_{off}.

t_{off} is the instant when the 1 kHz test signal starts to rise.

² During the time from the end of t₂ to the beginning of t₃, the frequency difference must not exceed the limits specified in §90.213.

³ Difference between the actual transmitter frequency and the assigned transmitter frequency.

⁴ If the transmitter carrier output power rating is 6 watts or less, the frequency difference during this time period may exceed the maximum frequency difference for this time period.

11.2 TEST METHOD

TIA/EIA-603 2.2.19

11.3 TEST INSTRUMENTS

NAME OF EQUIPMENT	MANUFACTURER	MODEL	SERIAL NUMBER	Cal. Date	Cal. Due
Signal Generator	AGILENT	E4412B	LR114196	05/29/2013	05/28/2014
Storage Oscilloscope	Tektronix	TDS3052	B017447	07/18/2013	07/17/2014

11.4 DESCRIBE LIMIT LINE OF TRANSMITTER FREQUENCY BEHAVIOR

ton: The switch-on instant of a transmitter is defined by the condition when the output power, measured at the antenna terminal, exceeds 0,1 % of the full output power (-30 dBc).

t1: period of time starting at ton and finishing according to above 11.1

t2: period of time starting at the end of t1 and finishing according to above 11.1

toff: switch-off instant defined by the condition when the output power falls below 0,1 % of the full output power (-30 dBc).

t3: period of time that finishing at toff and starting according to above 11.1

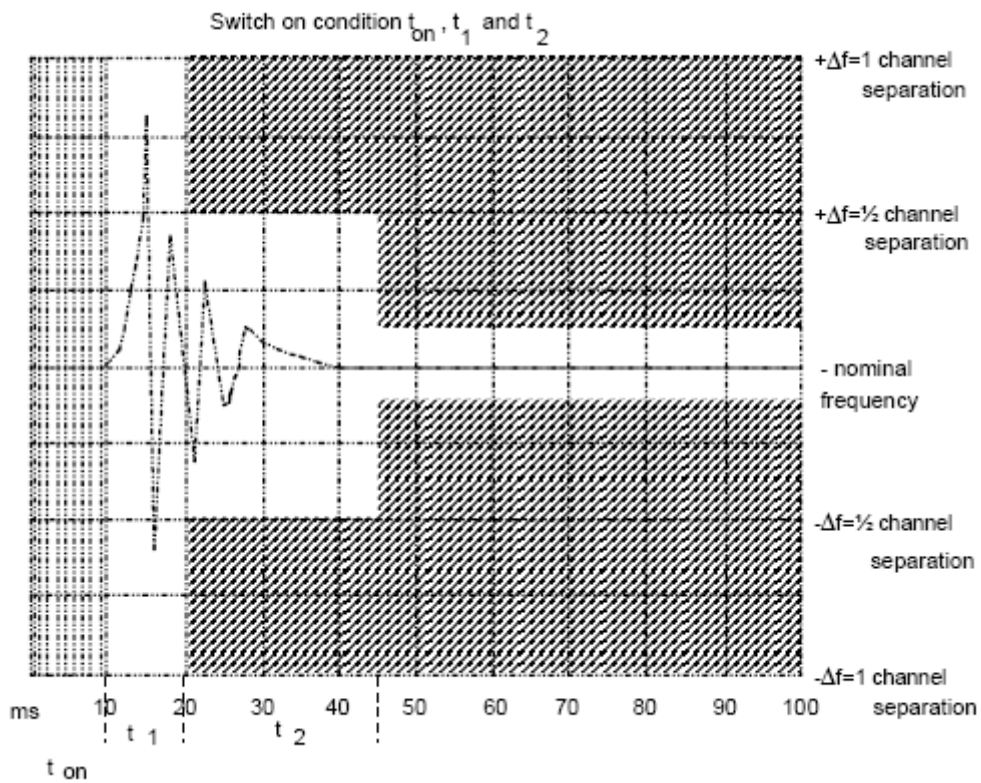

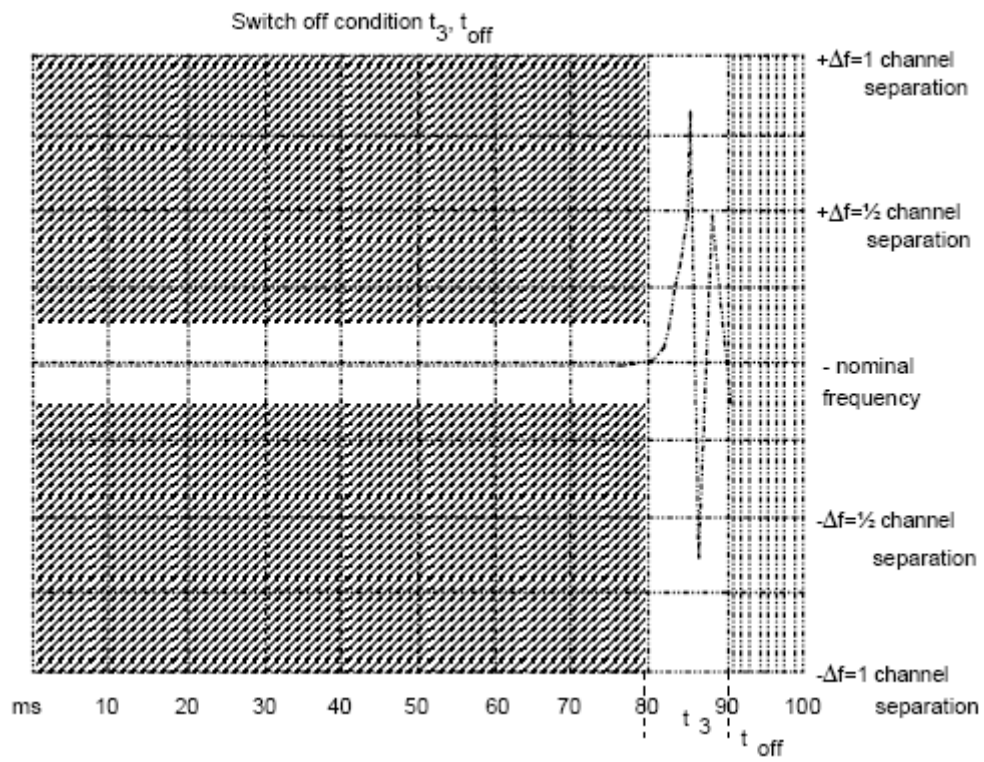

11.5 MEASURE RESULT

Transmitter Frequency Behaviour @ 12.5 KHz Channel Separation--Off to On

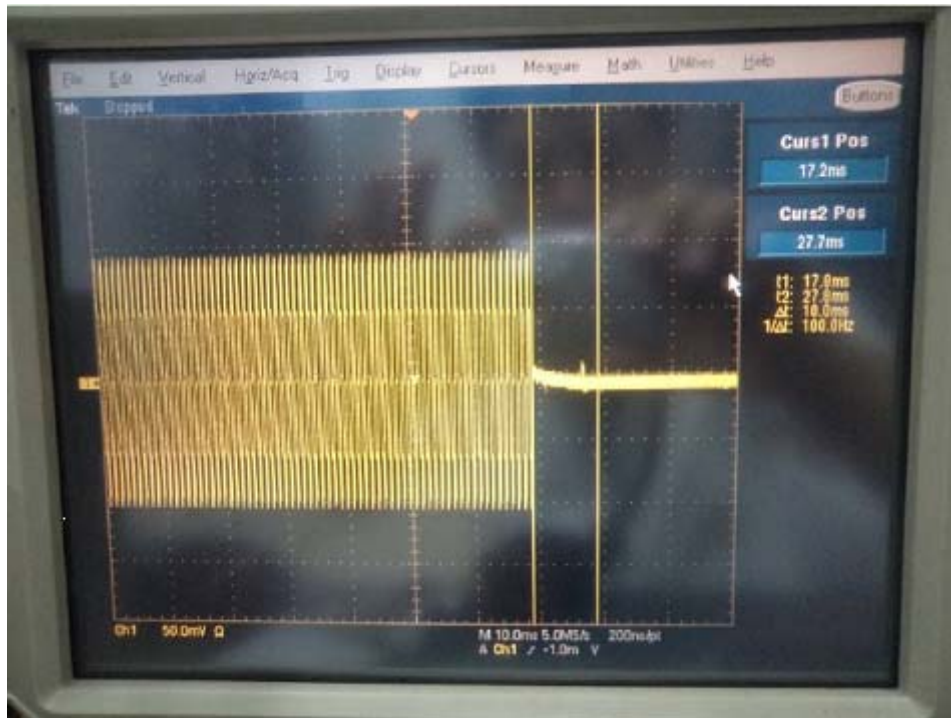

Transmitter Frequency Behaviour @ 12.5 KHz Channel Separation--On to Off

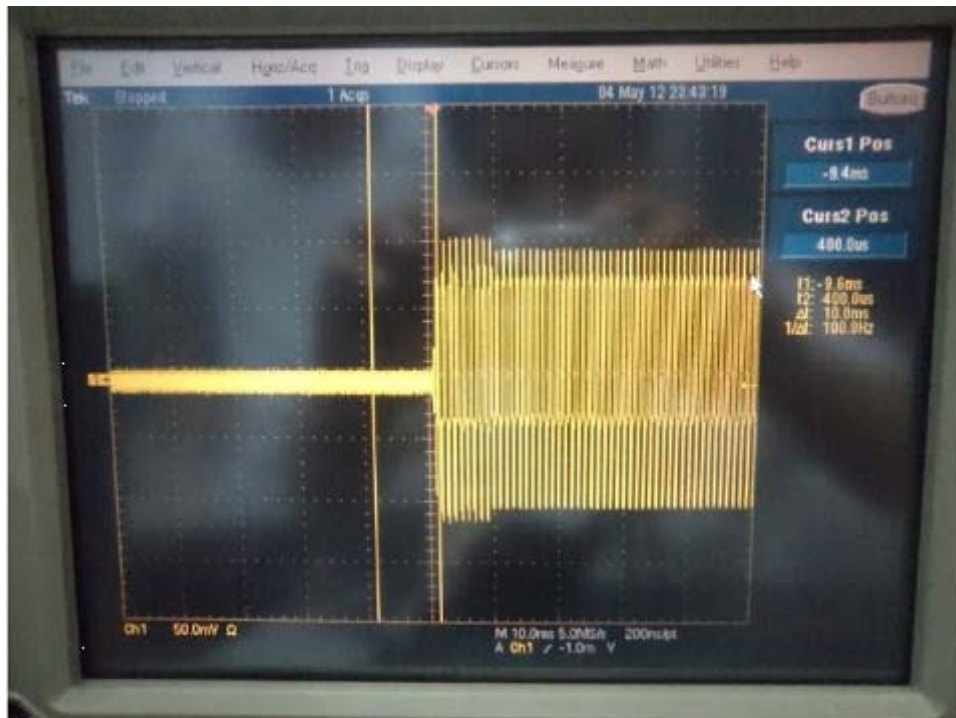

12. RADIATED EMISSION ON RECEIVING MODE

12.1 PROVISIONS APPLICABLE

FCC Part 15 Subpart B Section 15.109

RSS-Gen Subpart B Section RSS-Gen.6.1

12.2 TEST METHOD

ANSI C 63.4: 2003

12.3 TEST INSTRUMENTS

NAME OF EQUIPMENT	MANUFACTURER	MODEL	SERIAL NUMBER	Cal. Date	Cal. Due
SPECTRUM ANALYZER	AGILENT	E4440A	US44300399	07/18/2013	07/17/2014
HORN ANT.	EM	EM-AH-10180	100150	04/21/2013	04/20/2014
BROADBAND ANT.	A.H.	SAS-521-4	A0304224	06/08/2013	06/07/2014
AMPLIFIER	EM	EM30180	0607030	07/18/2013	07/17/2014
POSITIONING CONTROLLER	MF	MF-7802	MF780208147	--	--

12.4 MEASURE RESULT (MEASURED AT 3M USING FCC PART15 B LIMITS)

RADIATED EMISSION TEST RESULTS – HORIZONTAL

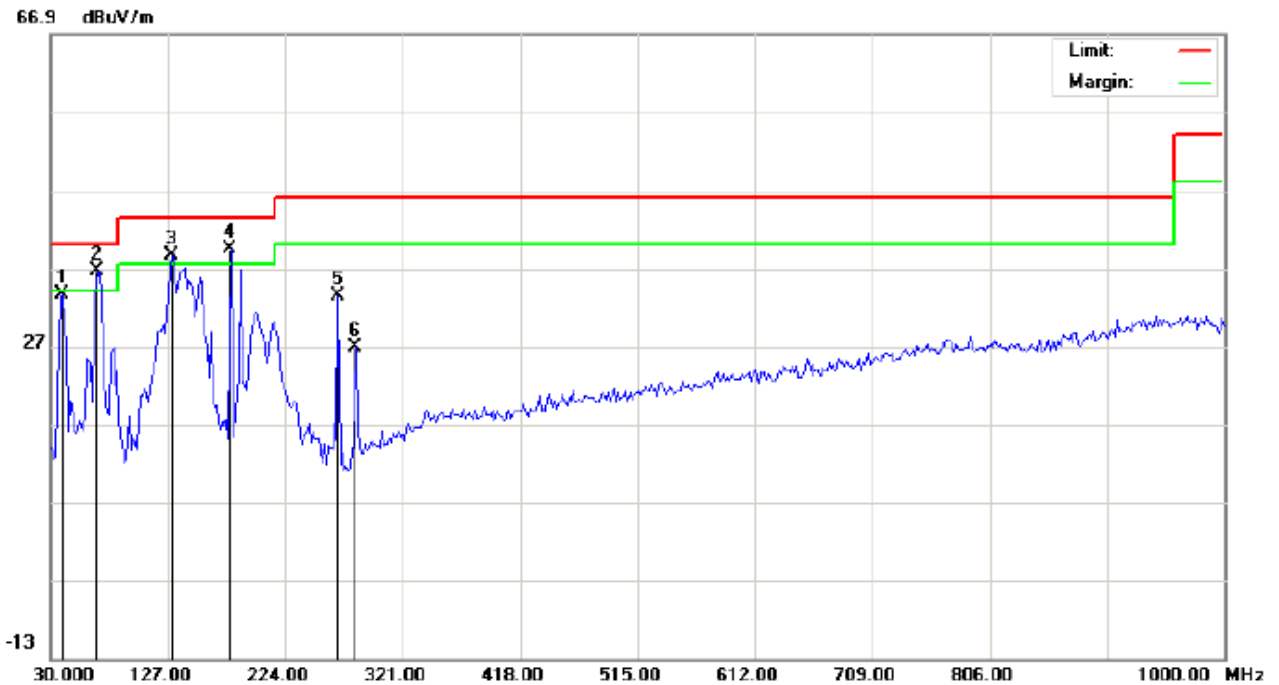

Site: site #1
Limit: FCC Class B 3M Radiation
EUT: TWO WAY RADIO
M/N: 628G
Mode: Mode 1
Note:

Polarization: *Horizontal*
Power:
Distance:

Temperature: 26
Humidity: 60 %

No.	Mk	Freq.	Reading	Factor	Measurement	Limit	Over	Detector	Antenna Height	Table Degree	Comment
		MHz	dBuV	dB/m	dBuV/m	dBuV/m	dB		cm	degree	
1		39.7000	22.19	11.51	33.70	40.00	-6.30	peak			
2	*	68.7997	26.21	10.37	36.58	40.00	-3.42	peak			
3	!	130.2332	25.12	13.57	38.69	43.50	-4.81	peak			
4	!	178.7332	27.97	11.34	39.31	43.50	-4.19	peak			
5		267.6499	18.92	14.43	33.35	46.00	-12.65	peak			
6		282.1999	11.92	14.87	26.79	46.00	-19.21	peak			

RADIATED EMISSION TEST RESULTS – VERTICAL

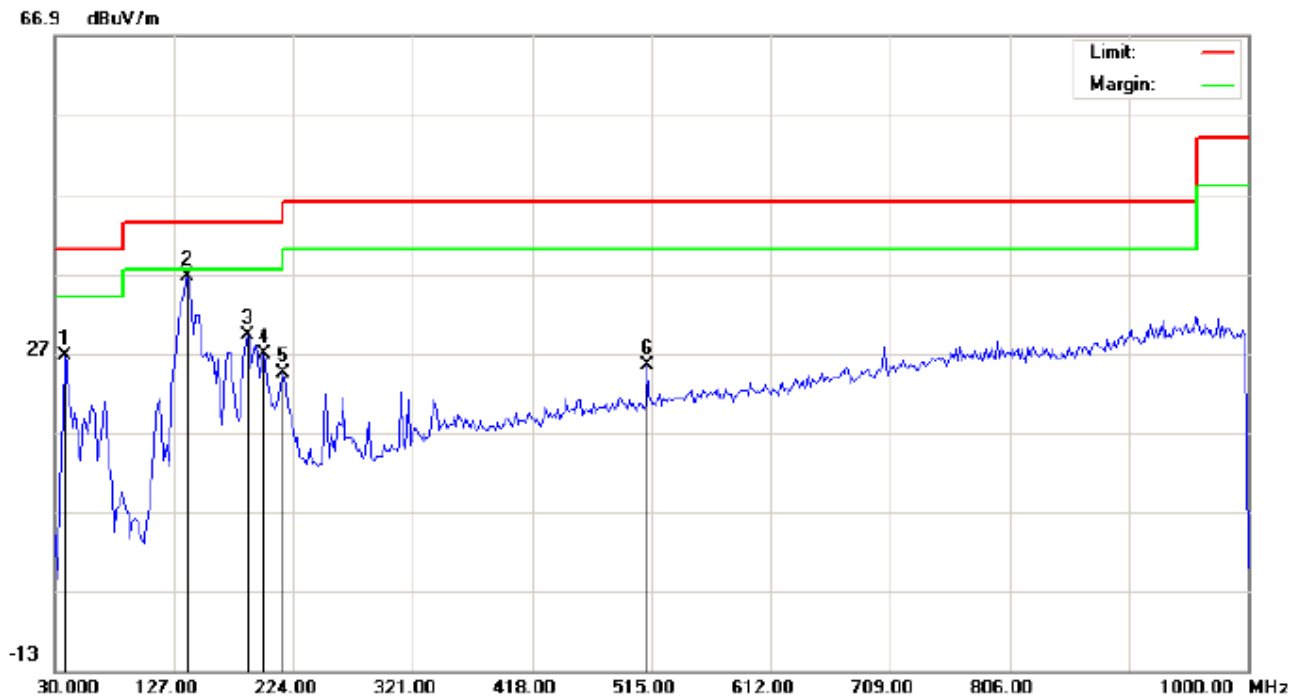

Site: site #1
Limit: FCC Class B 3M Radiation
EUT: TWO WAY RADIO
M/N: 628G
Mode: Mode 1
Note:

Polarization: *Vertical*
Power:
Distance:

Temperature: 26
Humidity: 60 %

No.	Mk	Freq.	Reading	Factor	Measurement	Limit	Over	Detector	Antenna	Table	Comment
		MHz	dBuV	dB/m	dBuV/m	dBuV/m	dB		Height	Degree	
									cm	degree	
1		38.0833	20.16	6.39	26.55	40.00	-13.45	peak			
2	*	138.3167	22.11	14.50	36.61	43.50	-6.89	peak			
3		186.8167	16.82	12.34	29.16	43.50	-14.34	peak			
4		199.7500	17.78	9.06	26.84	43.50	-16.66	peak			
5		215.9167	13.90	10.56	24.46	43.50	-19.04	peak			
6		511.7667	4.03	21.45	25.48	46.00	-20.52	peak			

13. AUDIO LOW PASS FILTER RESPONSE

13.1 LIMITS

2.1047(a): Voice modulated communication equipment. A curve or equivalent data showing the frequency response of the audio modulating circuit over a range of 100 to 5000 Hz shall be submitted. For equipment required to have an audio low-pass filter, a curve showing the frequency response of the filter or of all circuitry installed between the modulation limiter and the modulated stage shall be submitted.

90.242(b)(8): Recommended audio filter attenuation characteristics are given below:

Audio band	Minimum Attenuation Rel. to 1 KHz Attenuation
3 –20 KHz	$60 \log_{10}(f/3)$ dB where f is in KHz
20 – 30 KHz	50dB

13.2. METHOD OF MEASUREMENTS

The rated audio input signal was applied to the input of the audio low-pass filter (or of all modulation stages) using an audio oscillator, this input signal level and its corresponding output signal were then measured and recorded using the FFT Digital Spectrum Analyzer. Tests were repeated at different audio signal frequencies from 0 to 50 KHz.

13.3 TEST DATA

12.5 KHZ CHANNEL SPACING, F3E, FREQUENCY OF ALL MODULATION STATES

Frequency (KHz)	Audio In (dBV)	Audio out (dBV)	Attenuation (Out_In) dB	Attenuation Rel.to 3 KHz (dB)	Recommended Attenuation (dB)
0.1	-76.16	-31.2	46.39	-36.52	
0.2	-76.16	-17.35	58.26	-25.62	
0.4	-76.16	-6.27	71.66	-12.82	
0.6	-76.16	0.38	74.26	-6.42	
0.8	-76.16	4.18	78.96	-2.92	
1.0	-76.16	7.21	83.66	-0.02	
1.5	-76.16	8.28	84.86	2.18	
2.0	-76.16	8.97	85.36	1.58	
2.5	-76.16	7.53	83.86	0.68	
3.0	-76.16	6.28	82.56	-1.82	0
3.5	-76.16	2.64	78.46	-4.92	-4
4.0	-76.16	-2.6	74.66	-9.42	-7
4.5	-76.16	-9.24	68.26	-16.52	-12
5.0	-76.16	-15.2	60.66	-21.72	-15
6.0	-76.16	-21.26	54.16	-28.62	-18
7.0	-76.16	-31.64	46.26	-36.42	-22
8.0	-76.16	-39.25	37.96	-47.62	-26
9.0	-76.16	-61.94	15.16	-66.92	-28
10.0	-76.16	-61.94	15.16	-66.42	-31
12.0	-76.16	-61.94	15.16	-66.42	-37
14.0	-76.16	-61.94	15.16	-66.42	-40
16.0	-76.16	-61.94	15.16	-66.42	-44
18.0	-76.16	-61.94	15.16	-66.42	-47
20.0	-76.16	-61.94	15.16	-66.42	-49
25.0	-76.16	-61.94	15.16	-66.42	-49
30.0	-76.16	-61.94	15.16	-66.42	-49
35.0	-76.16	-61.94	15.16	-66.42	-49
40.0	-76.16	-61.94	15.16	-66.42	-49
45.0	-76.16	-61.94	15.16	-66.42	-49
50.0	-76.16	-61.94	15.16	-66.42	-49

Note: Due to the difficulty of measuring the Frequency Response of the internal low-pass filter, the Frequency Response of All Modulation States is performed to show the roll-off at 3 KHz in comparison with the recommended audio filter attenuation.

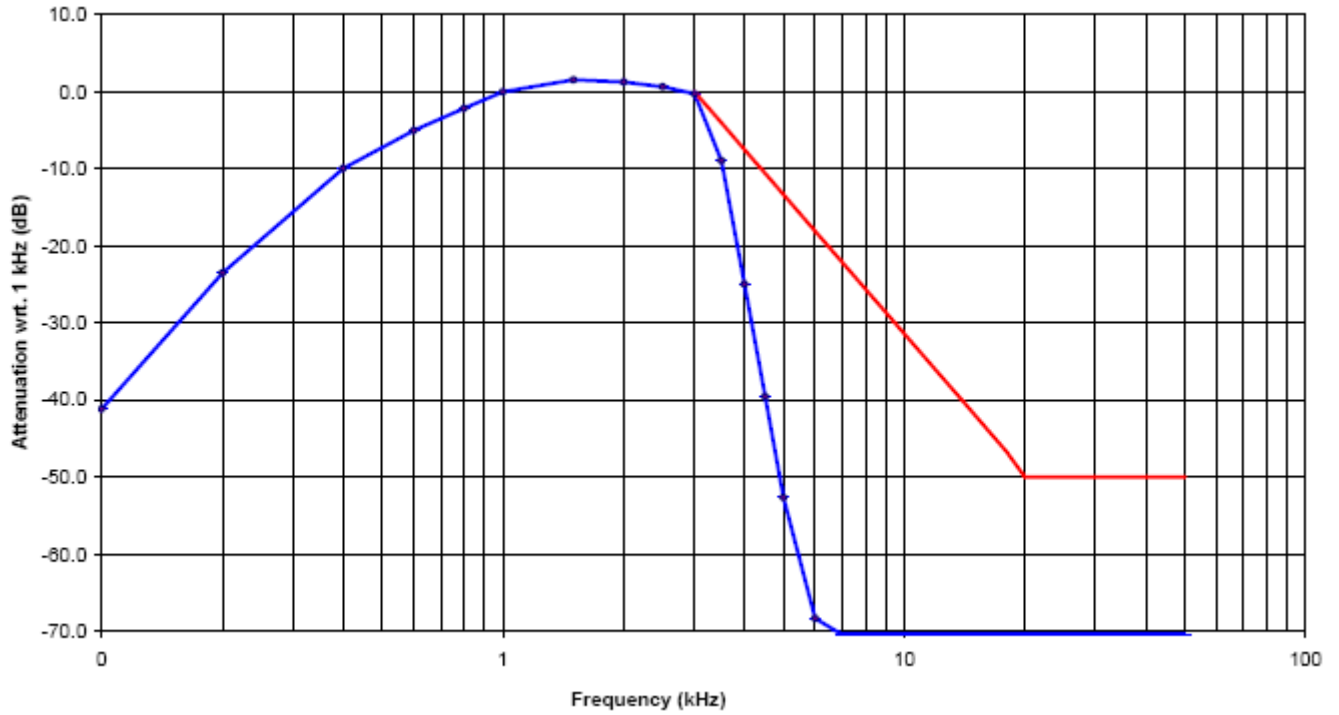

APPENDIX I: PHOTOGRAPHS OF SETUP
RADIATED EMISSION TEST SETUP

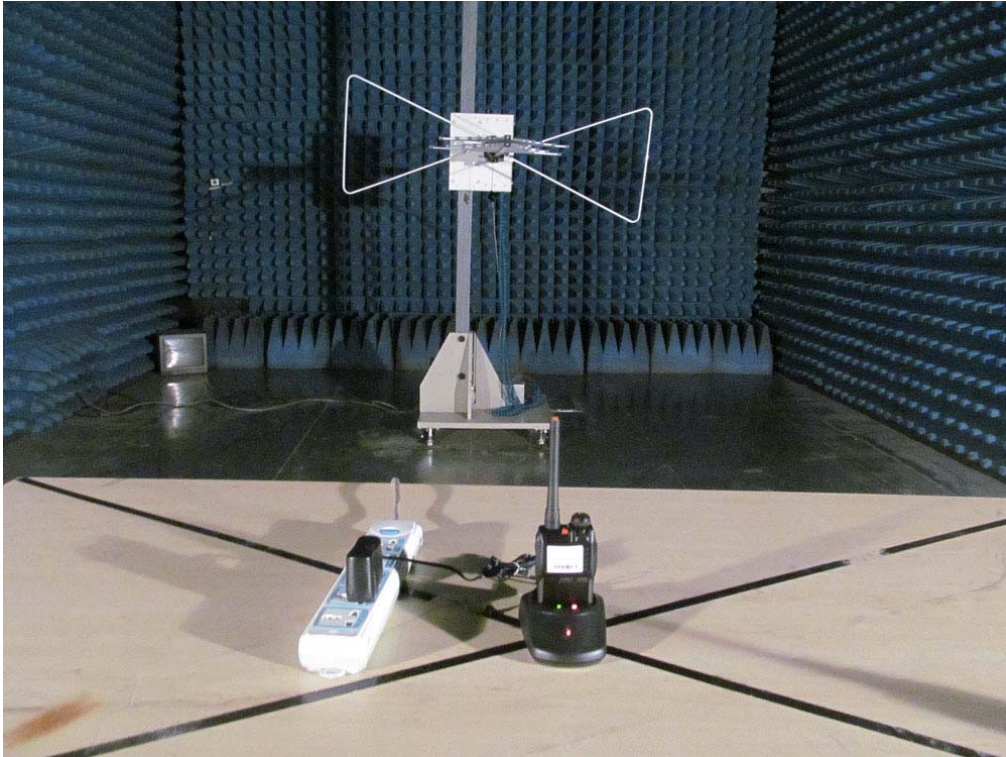

CONDUCTED EMISSION TEST SETUP



APPENDIX II
EXTERNAL VIEW OF EUT
TOTAL VIEW OF EUT



TOP VIEW OF EUT



BOTTOM VIEW OF EUT



FRONT VIEW OF EUT



BACK VIEW OF EUT



LEFT VIEW OF EUT



RIGHT VIEW OF EUT



OPEN VIEW-1 OF EUT



OPEN VIEW-2 OF EUT

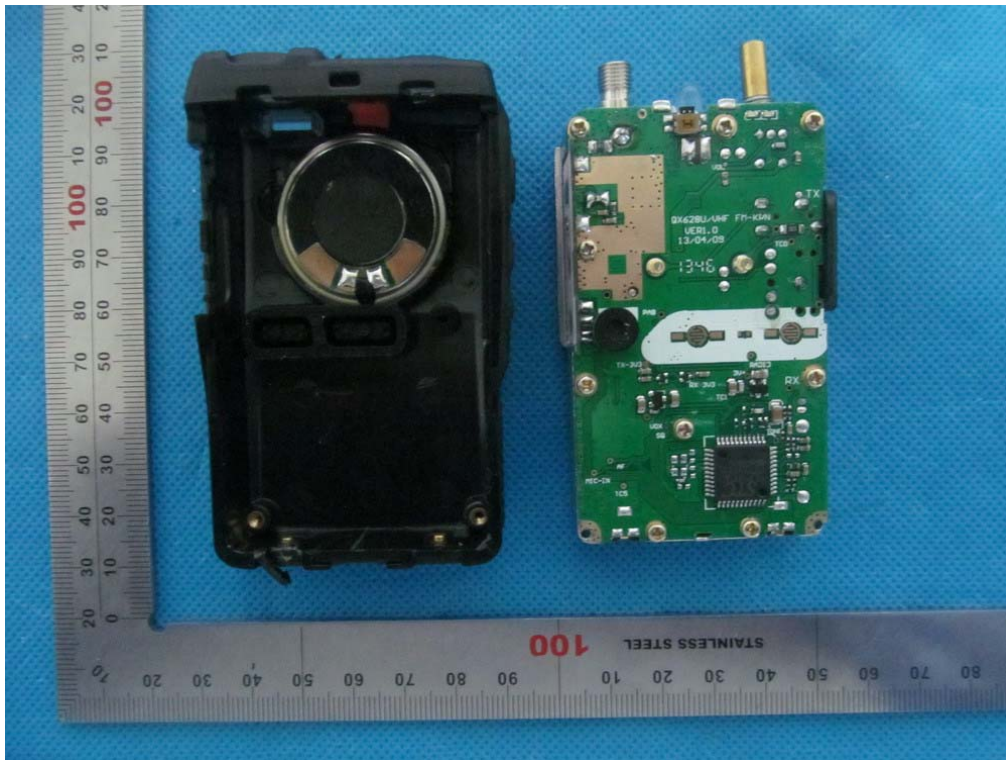

INTERNAL VIEW-1 OF EUT

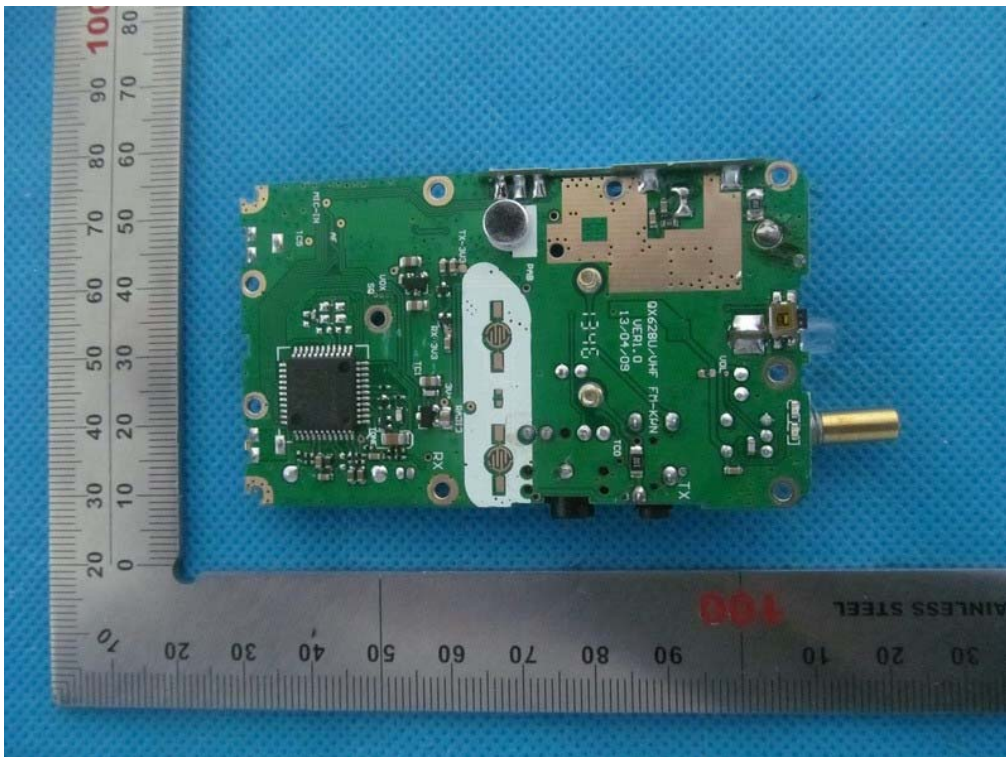

INTERNAL VIEW-2 OF EUT

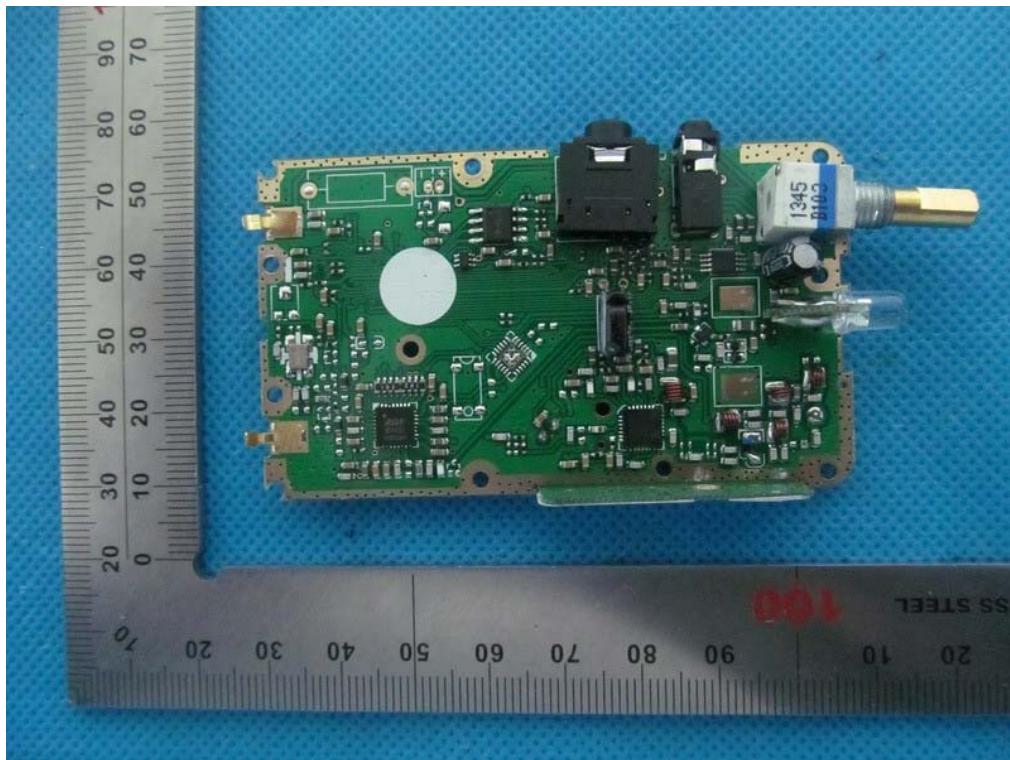

----END OF REPORT----