



SAR Test Report

Report No.: AGC00589140206FH01

FCC ID : T4K-QZQX628G

APPLICATION PURPOSE : Original Equipment

Product Designation : TWO WAY RADIO

Brand Name : N/A

Model Name : 628,628G

Client : Qixiang Electron Science & Technology Co., Ltd. Quanzhou

Date of Issue : Mar.31,2014

STANDARD(S) : IEEE Std. 1528:2003
47CFR § 2.1093
IEEE/ANSI C95.1

REPORT VERSION : V1.0

Attestation of Global Compliance (Shenzhen) Co., Ltd.



CAUTION:

This report shall not be reproduced except in full without the written permission of the test laboratory and shall not be quoted out of context.

Report Revise Record

Report Version	Revise Time	Issued Date	Valid Version	Notes
V1.0	/	Mar.31,2014	Valid	Original Report

Test Report Certification

Applicant Name	Qixiang Electron Science & Technology Co., Ltd. Quanzhou
Applicant Address	Qixiang Building, Tangxi Industrial Zone, Luojiang District, Quanzhou, Fujian, China
Manufacturer Name	Qixiang Electron Science & Technology Co., Ltd. Quanzhou
Manufacturer Address	Qixiang Building, Tangxi Industrial Zone, Luojiang District, Quanzhou, Fujian, China
Product Name	TWO WAY RADIO
Brand Name	N/A
Model Name	628, 628G
Difference Description	All the same except for the model name and appearance, the main test model is 628G.
EUT Voltage	DC7.4V by battery
Applicable Standard	IEEE Std. 1528:2003 47CFR § 2.1093 IEEE/ANSI C95.1
Test Date	Mar.19,2014
Performed Location	Attestation of Global Compliance (Shenzhen)Co., Ltd.
	2F, Building 2, No.1-No.4, Chaxi Sanwei Technical Industrial Park, Gushu, Xixiang Street, Bao'an District, Shenzhen, China
Report Template	AGCRT-EC-PPT/SAR (2013-03-01)

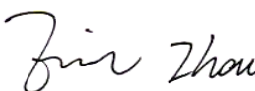
Tested By 
Eric Zhou Mar.31,2014

Checked By 
Angela Li Mar.31,2014

Authorized By 
Solger Zhang Mar.31,2014

TABLE OF CONTENTS

1. SUMMARY OF MAXIMUM SAR VALUE	5
2. GENERAL INFORMATION	6
2.1. EUT Description	6
2.2. Test Procedure	7
2.3. Test Environment.....	7
3. SAR MEASUREMENT SYSTEM	8
3.1. Specific Absorption Rate (SAR)	8
3.2. SAR Measurement Procedure	9
3.3. COMOSAR System Description	10
3.4. COMOSAR E-Field Probe	12
3.5. Isotropic E-Field Probe Specification.....	12
3.6. Robot	12
3.7. Video Positioning System	13
3.8. Device Holder.....	13
3.9. Elliptic Phantom	14
4. TISSUE SIMULATING LIQUID.....	15
4.1. The composition of the tissue simulating liquid	15
4.2. Tissue Calibration Result	16
4.3. Tissue Dielectric Parameters for Head and Body Phantoms	17
5. SAR MEASUREMENT PROCEDURE	18
5.1. SAR System Validation Procedures	18
5.2. SAR System Validation.....	19
6. EUT TEST POSITION.....	21
6.1. Body Worn Position	21
7. SAR EXPOSURE LIMITS	22
8. TEST EQUIPMENT LIST	23
9. CONDUCTED POWER MEASUREMENT	24
10. TEST RESULTS	25
10.1. SAR Test Results Summary.....	25
APPENDIX A. SAR SYSTEM VALIDATION DATA	27
APPENDIX B. SAR MEASUREMENT DATA	31
APPENDIX C. TEST SETUP PHOTOGRAPHS &EUT PHOTOGRAPHS	43
APPENDIX D. PROBE CALIBRATION DATA	51
APPENDIX E. DIPOLE CALIBRATION DATA.....	61

1. SUMMARY OF MAXIMUM SAR VALUE

The maximum results of Specific Absorption Rate (SAR) found during testing for EUT are as follows:

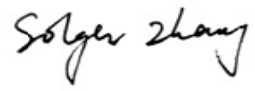
Highest Report standalone SAR Summary (with 50% duty cycle)

UHF:

Exposure Position	Separation	Highest Reported 1g-SAR(W/Kg)
Face Up	12.5 KHz	1.869
Back Touch	12.5 KHz	3.125

This device is compliance with Specific Absorption Rate (SAR) for Occupational / Controlled Exposure Environment limits (8.0W/Kg) specified in FCC 47 CFR part 2 (2.1093) and ANSI/IEEE C95.1, and had been tested in accordance with measurement methods and procedures specified in IEEE 1528-2003 and the relevant KDB files like KDB 941225 D01 , KDB 941225 D03 ,KDB 865664 D02....etc.

2. GENERAL INFORMATION

2.1. EUT Description

General Information	
Product Name	TWO WAY RADIO
Test Model	628G
Hardware Version	V2.02
Software Version	V2.02
Exposure Category:	Occupational/Controlled Exposure
Device Category	FM UHF Portable Transceiver
Modulation Type	FM
TX Frequency Range	400-480MHz
Rated Power	2Watt
Max. Average Power	31.93dBm
Channel Spacing	12.5 KHz
Antenna Type	External Antenna
Antenna Gain	2.15dB
Body-Worn Accessories:	Belt Clip with headset
Face-Head Accessories:	None
Battery Type (s) Tested:	DC7.4V by battery

Note: The sample used for testing is end product.

2.2. Test Procedure

1	Setup the EUT for two typical configuration of hold to face and body worn individually
2	Power on the EUT and make it continuously transmitting on required operating channel
3	Make sure the EUT work normally during the test

2.3. Test Environment

Ambient conditions in the laboratory:

Items	Required	Actual
Temperature (°C)	18-25	21 ± 2
Humidity (%RH)	30-70	56

3. SAR MEASUREMENT SYSTEM

3.1. Specific Absorption Rate (SAR)

SAR is related to the rate at which energy is absorbed per unit mass in object exposed to a radio field. The SAR distribution in a biological body is complicated and is usually carried out by experimental techniques or numerical modeling. The standard recommends limits for two tiers of groups, occupational/controlled and occupational/uncontrolled, based on a person's awareness and ability to exercise control over his or her exposure. In general, occupational/controlled exposure limits are higher than the limits for general population/uncontrolled.

The SAR definition is the time derivative (rate) of the incremental energy (dW) absorbed by (dissipated in) an incremental mass (dm) contained in a volume (dv) of given mass density (ρ). The equation description is as below:

$$SAR = \frac{d}{dt} \left(\frac{dW}{dm} \right) = \frac{d}{dt} \left(\frac{dW}{\rho dV} \right)$$

SAR is expressed in units of Watts per kilogram (W/Kg)

SAR can be obtained using either of the following equations:

$$SAR = \frac{\sigma E^2}{\rho}$$

$$SAR = c_h \left. \frac{dT}{dt} \right|_{t=0}$$

Where

SAR	is the specific absorption rate in watts per kilogram;
E	is the r.m.s. value of the electric field strength in the tissue in volts per meter;
σ	is the conductivity of the tissue in siemens per metre;
ρ	is the density of the tissue in kilograms per cubic metre;
c_h	is the heat capacity of the tissue in joules per kilogram and Kelvin;

$\left. \frac{dT}{dt} \right|_{t=0}$ is the initial time derivative of temperature in the tissue in kelvins per second

3.2. SAR Measurement Procedure

The EUT is set to transmit at the required power in line with product specification, at each frequency relating to the LOW, MID, and HIGH channel settings.

Pre-scans are made on the device to establish the location for the transmitting antenna, using a large area scan in either air or tissue simulation fluid.

The EUT is placed against the Universal Phantom where the maximum area scan dimensions are larger than the physical size of the resonating antenna. When the scan size is not large enough to cover the peak SAR distribution, it is modified by either extending the area scan size in both the X and Y directions, or the device is shifted within the predefined area.

The area scan is then run to establish the peak SAR location (interpolated resolution set at 1mm^2) which is then used to orient the center of the zoom scan. The zoom scan is then executed and the 1g and 10g averages are derived from the zoom scan volume (interpolated resolution set at 1mm^3).

When multiple peak SAR location were found during the same configuration or test mode, Zoom scan shall performed on each peak SAR location, only the peak point with maximum SAR value will be reported for the configuration or test mode.

3.3. COMOSAR System Description

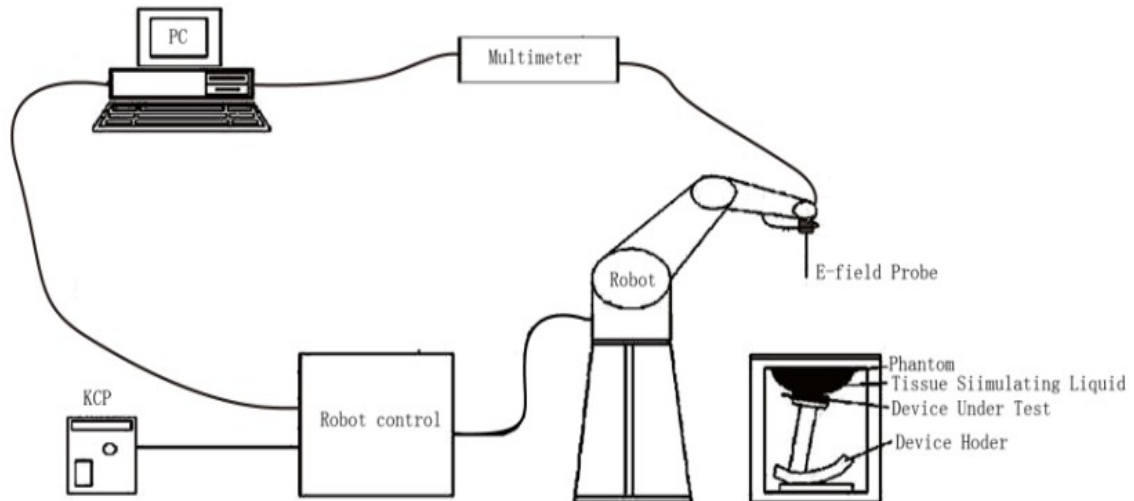

The COMOSAR system for performing compliance tests consists of the following items:

- The PC. It controls most of the bench devices and stores measurement data. A computer running WinXP and the Opensar software.
- The E-Field probe. The probe is a 3-axis system made of 3 distinct dipoles. Each dipole returns a voltage in function of the ambient electric field.
- The Keithley multimeter measures each probe dipole voltages.
- The SAM phantom simulates a human head. The measurement of the electric field is made inside the phantom.
- The liquids simulate the dielectric properties of the human head tissues.
- The network emulator controls the mobile phone under test.
- The validation dipoles are used to measure a reference SAR. They are used to periodically check the bench to make sure that there is no drift of the system characteristics over time.
- The phantom, the device holder and other accessories according to the targeted measurement.

3.3.1. Applications

Predefined procedures and evaluations for automated compliance testing with all worldwide standards, e.g., IEEE 1528, OET 65, IEC 62209-1, IEC 62209-2, EN 50360, EN 50383 and others.

3.3.2. Area Scans

Area scans are defined prior to the measurement process being executed with a user defined variable spacing between each measurement point (integral) allowing low uncertainty measurements to be conducted. Scans defined for FCC applications utilize a 10mm² step integral, with 1mm interpolation used to locate the peak SAR area used for zoom scan assessments. When an Area Scan has measured all reachable points, it computes the field maxima found in the scanned area, within a range of the global maximum. The range (in dB) is specified in the standards for compliance testing. For example, a 2 dB range is required in IEEE 1528-2003, EN 50361 and IEC 62209 standards, whereby 3 dB is a requirement when compliance is assessed in accordance with the ARIB standard (Japan).

3.3.3. Zoom Scan (Cube Scan Averaging)

Zoom Scans are used to assess the peak spatial SAR values within a cubic averaging volume containing 1 g and 10 g of simulated tissue. A density of 1000 kg/m³ is used to represent the head and body tissue density and not the phantom liquid density, in order to be consistent with the definition of the liquid dielectric properties, i.e. the side length of the 1 g cube is 10mm, with the side length of the 10 g cube 21,5mm. The zoom scan integer steps can be user defined so as to reduce uncertainty, but normal practice for typical test applications utilize a physical step of 7x7x7 (5mmx5mmx5mm) providing a volume of 30mm in the X & Y axis, and 30mm in the Z axis.

3.3.4. Uncertainty of Inter-/Extrapolation and Averaging

In order to evaluate the uncertainty of the interpolation, extrapolation and averaged SAR calculation algorithms of the Post processor, COMOSAR allows the generation of measurement grids which are artificially predefined by analytically based test functions. Therefore, the grids of area scans and zoom scans can be filled with uncertainty test data, according to the SAR benchmark functions of IEEE 1528. The three analytical functions shown in equations as below are used to describe the possible range of the expected SAR distributions for the tested handsets. The field gradients are covered by the spatially flat distribution f1, the spatially steep distribution f3 and f2 accounts for H-field cancellation on the phantom/tissue surface.

$$f_1(x, y, z) = A e^{-\frac{z}{2a}} \cos^2 \left(\frac{\pi}{2} \frac{\sqrt{x'^2 + y'^2}}{5a} \right)$$

$$f_2(x, y, z) = A e^{-\frac{z}{a}} \frac{a^2}{a^2 + x'^2} \left(3 - e^{-\frac{2z}{a}} \right) \cos^2 \left(\frac{\pi}{2} \frac{y'}{3a} \right)$$

$$f_3(x, y, z) = A \frac{a^2}{\frac{a^2}{4} + x'^2 + y'^2} \left(e^{-\frac{2z}{a}} + \frac{a^2}{2(a + 2z)^2} \right)$$

3.4. COMOSAR E-Field Probe

The SAR measurement is conducted with the dissymmetric probe manufactured by SATIMO. The probe is specially designed and calibrated for use in liquid with high permittivity. The dissymmetric probe has special calibration in liquid at different frequency. SATIMO conducts the probe calibration in compliance with international and national standards (e.g. IEEE 1528, EN62209-1, IEC 62209, etc.) Under ISO17025. The calibration data are in Appendix D.

3.5. Isotropic E-Field Probe Specification

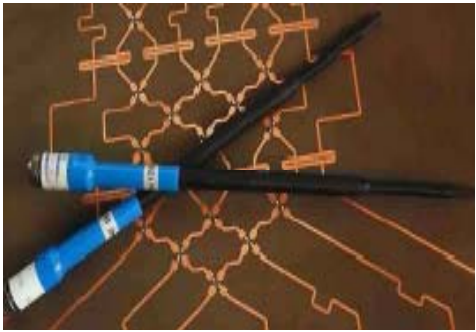
Model	EP159	
Manufacture	SATIMO	
Frequency	0.3GHz-3 GHz Linearity:±0.09dB(300 MHz-3 GHz)	
Dynamic Range	0.01W/Kg-100W/Kg Linearity:±0.09dB	
Dimensions	Overall length:330mm Length of individual dipoles:4.5mm Maximum external diameter:8mm Probe Tip external diameter:5mm Distance between dipoles/ probe extremity:2.7mm	
Application	High precision dosimetric measurements in any exposure scenario (e.g., very strong gradient fields). Only probe which enables compliance testing for frequencies up to 3 GHz with precision of better 30%.	

3.6. Robot

<p>The COMOSAR system uses the KUKA robot from SATIMO SA (France).For the 6-axis controller COMOSAR system, the KUKA robot controller version from SATIMO is used. The XL robot series have many features that are important for our application:</p> <ul style="list-style-type: none"> High precision (repeatability 0.02 mm) High reliability (industrial design) Jerk-free straight movements Low ELF interference (the closed metallic construction shields against motor control fields) 6-axis controller 	
---	---

3.7. Video Positioning System

The video positioning system is used in OpenSAR to check the probe. Which is composed of a camera, LED, mirror and mechanical parts. The camera is piloted by the main computer with firewire link.

During the process, the actual position of the probe tip with respect to the robot arm is measured, as well as the probe length and the horizontal probe offset. The software then corrects all movements, such that the robot coordinates are valid for the probe tip.

The repeatability of this process is better than 0.1 mm. If a position has been taught with an aligned probe, the same position will be reached with another aligned probe within 0.1 mm, even if the other probe has different dimensions. During probe rotations, the probe tip will keep its actual position.

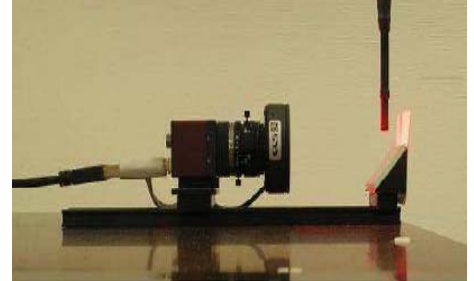

3.8. Device Holder

The COMOSAR device holder is designed to cope with different positions given in the standard. It has two scales for the device rotation (with respect to the body axis) and the device inclination (with respect to the line between the ear reference points). The rotation center for both scales is the ear reference point (EPR).

Thus the device needs no repositioning when changing the angles.

The COMOSAR device holder has been made out of low-loss POM material having the following dielectric parameters: relative permittivity $\epsilon_r = 3$ and loss tangent $\delta = 0.02$. The amount of dielectric material has been reduced in the closest vicinity of the device, since measurements have suggested that the influence of the clamp on the test results could thus be lowered.

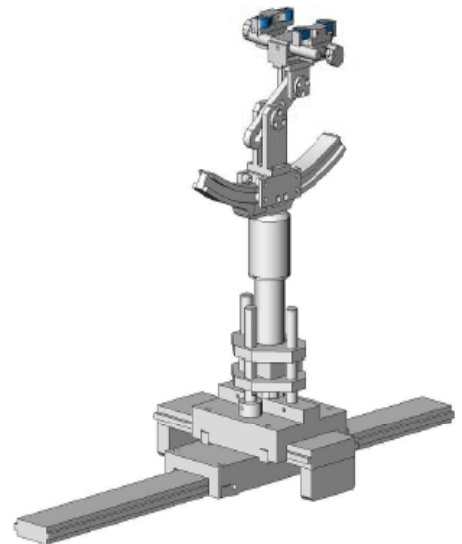

3.9. Elliptic Phantom

The Elliptic Phantom is a fiberglass shell flat phantom with 2mm \pm 0.2 mm shell thickness. It has only one measurement area for Flat phantom



4. TISSUE SIMULATING LIQUID

For SAR measurement of the field distribution inside the phantom, the phantom must be filled with homogeneous tissue simulating liquid to a depth of at least 15cm. For head SAR testing the liquid height from the ear reference point (ERP) of the phantom to the liquid top surface is larger than 15cm For body SAR testing, the liquid height from the center of the flat phantom to the liquid top surface is larger than 15cm. The nominal dielectric values of the tissue simulating liquids in the phantom and the tolerance of 5% are listed in 4.2

4.1. The composition of the tissue simulating liquid

Ingredient (% Weight) Tissue Type	450 MHz
Water	38.56
Salt (NaCl)	3.95
Sugar	56.32
HEC	0.98
Bactericide	0.19
Triton X-100	0.0
DGBE	0.0

4.2. Tissue Calibration Result

The dielectric parameters of the liquids were verified prior to the SAR evaluation using COMOSAR Dielectric Probe Kit and R&S Network Analyzer ZVL6 .

Tissue Stimulant Measurement for 450MHz							
Fr. (MHz)	Ch.	Dielectric Parameters ($\pm 5\%$)				Tissue Temp [$^{\circ}$ C]	Test time
		head		body			
		ϵ_r 43.50 41.325 to 45.675	δ [s/m] 0.87 0.8265 to 0.9135	ϵ_r 56.7 53.865 to 59.535	δ [s/m] 0.94 0.893 to 0.987		
450	Low	44.37	0.85	54.40	0.91	21	Mar.19,2014
450	Mid	43.06	0.88	55.29	0.95	21	Mar.19,2014
450	High	43.84	0.86	56.19	0.94	21	Mar.19,2014

4.3. Tissue Dielectric Parameters for Head and Body Phantoms

The head tissue dielectric parameters recommended by the IEEE SCC-34/SC-2 in P1528 have been incorporated in the following table. These head parameters are derived from planar layer models simulating the highest expected SAR for the dielectric properties and tissue thickness variations in a human head. Other head and body tissue parameters that have not been specified in P1528 are derived from the tissue dielectric parameters computed from the 4-Cole-Cole equations described in Reference [12] and extrapolated according to the head parameters specified in P1528.

Target Frequency (MHz)	head		body	
	ϵ_r	σ (S/m)	ϵ_r	σ (S/m)
300	45.3	0.87	58.2	0.92
450	43.5	0.87	56.7	0.94
835	41.5	0.90	55.2	0.97
900	41.5	0.97	55.0	1.05
915	41.5	0.98	55.0	1.06
1450	40.5	1.20	54.0	1.30
1610	40.3	1.29	53.8	1.40
1800 – 2000	40.0	1.40	53.3	1.52
2450	39.2	1.80	52.7	1.95
3000	38.5	2.40	51.6	2.73
5800	35.3	5.27	48.2	6.00

(ϵ_r = relative permittivity, σ = conductivity and $\rho = 1000 \text{ kg/m}^3$)

5. SAR MEASUREMENT PROCEDURE

5.1. SAR System Validation Procedures

Each SATIMO system is equipped with one or more system validation kits. These units, together with the predefined measurement procedures within the SATIMO software, enable the user to conduct the system performance check and system validation. System kit includes a dipole, and dipole device holder.

The system check verifies that the system operates within its specifications. It's performed daily or before every SAR measurement. The system check uses normal SAR measurement in the flat section of the phantom with a matched dipole at a specified distance. The system validation setup is shown as below.

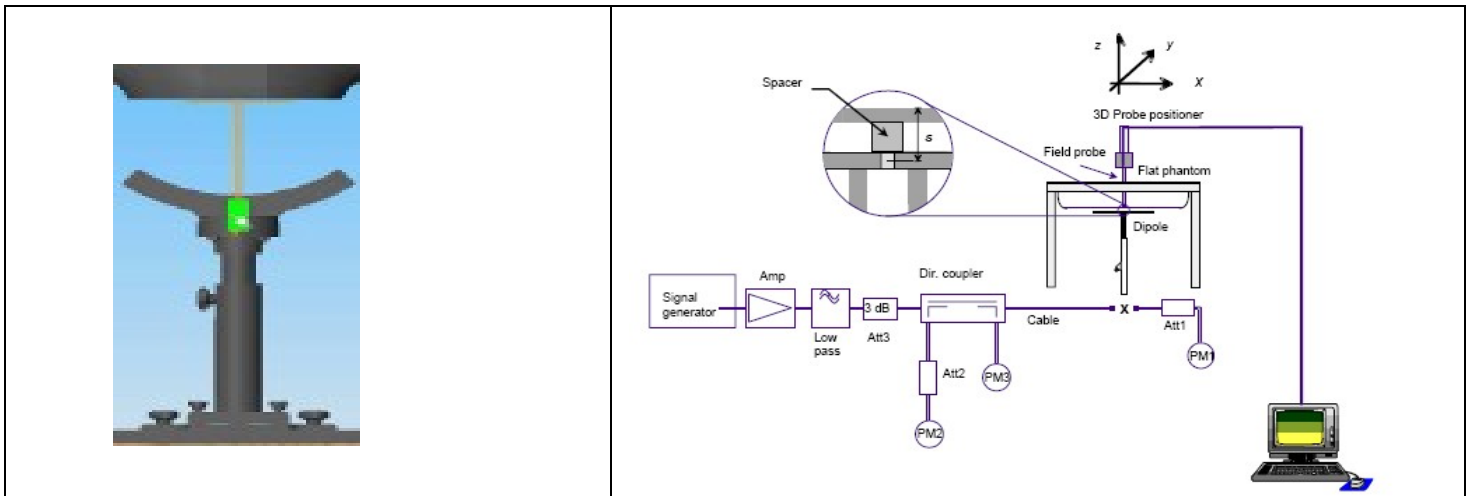

5.2. SAR System Validation

5.2.1. Validation Dipoles

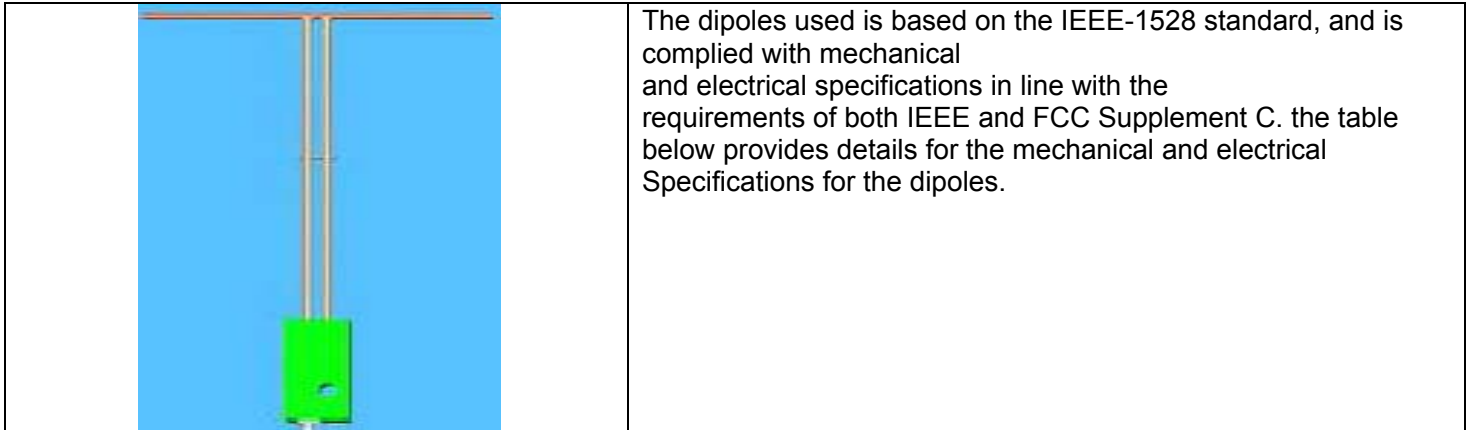

Frequency	L (mm)	h (mm)	d (mm)
450MHz	290	166.7	6.35

5.2.2. Validation Result

System Performance Check at 450MHz								
Validation Kit: SN 46/11DIP 0G450-184								
Frequency [MHz]	Target Value(W/Kg)		Reference Result ($\pm 10\%$)		Tested Value(W/Kg)		Tissue Temp. [°C]	Test time
	1g	10g	1g	10g	1g	10g		
450 head	4.91	3.13	4.419-5.401	2.817-3.443	4.86	3.02	21	Mar.19,2014
450 body	5.07	3.25	4.563-5.577	2.925-3.575	4.97	3.18	21	Mar.19,2014

6. EUT TEST POSITION

This EUT was tested in **Front Face and Rear Face**.

6.1. Body Worn Position

- (1) To position the EUT parallel to the phantom surface.
- (2) To adjust the EUT parallel to the flat phantom.
- (3) To adjust the distance between the EUT surface and the flat phantom to **25mm**.

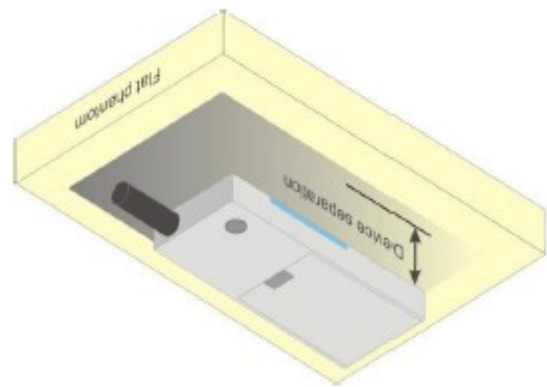
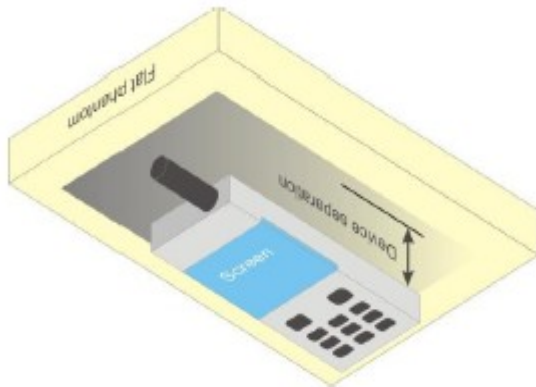

7. SAR EXPOSURE LIMITS

SAR assessments have been made in line with the requirements of IEEE-1528, FCC Supplement C, and comply with ANSI/IEEE C95.1-1992 “Controlled Exposure Environment” limits. These limits apply to a location which is deemed as “Controlled Exposure Environment” which can be described as a situation where the general public may be exposed to an RF source with no prior knowledge or control over their exposure.

Limits for Occupational / Controlled Exposure Environment

Type Exposure Limits	Occupational / Controlled Exposure Environment(W/Kg)
Spatial Average SAR (whole body)	8.0

8. TEST EQUIPMENT LIST

Equipment description	Manufacturer/Model	Identification No.	Current calibration date	Next calibration date
SAR Probe	SATIMO	SN 22/12 EP159	01/12/2014	01/11/2015
Phantom	SATIMO	SN_4511_SAM90	Validated. No cal required.	Validated. No cal required.
Liquid	SATIMO	-	Validated. No cal required.	Validated. No cal required.
Comm Tester	R&S - CMU200	069Y7-158-13-712	02/17/2014	02/16/2015
Comm Tester	Agilent-8960	GB46310822	02/17/2014	02/16/2015
Multimeter	Keithley 2000	1188656	02/17/2014	02/16/2015
Dipole	SATIMO SID450	SN46/11 DIP 0G450-184	11/14/2013	11/13/2015
Amplifier	Aethercomm	SN 046	12/08/2013	12/07/2014
Signal Generator	Agilent-E4421B	MY43351603	05/13/2013	05/12/2014
Power Probe	NRP-Z23	US38261498	02/17/2014	02/16/2015
SPECTRUM ANALYZER	Agilent/E4440A	MY44303916	10/22/2013	10/21/2014
Power Attenuator	BED	DLA-5W	07/30/2013	07/29/2014
Network Analyzer	Rhode & Schwarz ZVA	SN100132	02/17/2014	02/16/2015

Note: Per KDB 50824 Dipole SAR Validation Verification, AGC Lab has adopted 3 years calibration intervals. On annual basis, every measurement dipole has been evaluated and is in compliance with the following criteria:

1. There is no physical damage on the dipole;
2. System validation with specific dipole is within 10% of calibrated value;
3. Return-loss is within 20% of calibrated measurement;
4. Impedance is within 5Ω of calibrated measurement.

9. CONDUCTED POWER MEASUREMENT

Frequency (MHz)	Channel Spacing	Measured Conducted Output power	
		Max. Peak Power (dBm)	Avg. Power (dBm)
400.025	12.5KHz	32.96	31.80
440.000		32.99	31.93
479.975		32.95	31.79

10. TEST RESULTS

10.1. SAR Test Results Summary

10.1.1. Test position and configuration

Head SAR was performed with the device configured in the positions according to KDB 643646 and Body SAR was performed with the device configured with all accessories close to the Flat Phantom.

10.1.2. Operation Mode

Set the EUT to maximum output power level and transmit on lower, middle and top channel with 100% duty cycle individually during SAR measurement.

10.1.3. Co-located SAR

The following KDB was used for assessing this device.

KDB 447498, KDB 643646 and KDB450824

10.1.4. Test Result

SAR MEASUREMENT							
Ambient Temperature (°C) : 21 ±2				Relative Humidity (%): 52			
Liquid Temperature (°C) : 21 ±2				Depth of Liquid (cm):>15			
Product: TWO WAY RADIO							
Test Mode: Hold to Face with 2.5 cm separation and Body worn with all accessories (UHF)							
Test Position	Frequency			Power Drift (±5%)	SAR 1g with 100% duty Cycle (W/kg)	SAR 1g with 50% duty cycle (W/Kg)	Limit (W/kg)
	channel	MHz	Separation (KHz)				
Face Up	Low	400.025	12.5	0.73	3.738	1.869	8.0
Face Up	Middle	440.000	12.5	-1.11	3.300	1.650	8.0
Face Up	Top	479.975	12.5	0.95	3.218	1.609	8.0
Back Touch	Low	400.025	12.5	0.08	6.249	3.125	8.0
Back Touch	Middle	440.000	12.5	0.17	5.739	2.870	8.0
Back Touch	Top	479.975	12.5	-0.61	6.131	3.066	8.0

Note: when the 1-g SAR of middle channel is ≤ 3.5 W/kg, testing for other channel is optional. refer to KDB 643646.

APPENDIX A. SAR SYSTEM VALIDATION DATA

Test Laboratory: AGC Lab
System Check Head 450MHz

Date: Mar.19,2014

DUT: Dipole 450 MHz Type: SID 450

Communication System: CW; Communication System Band: CW 450 MHz; Duty Cycle: 1:1; Conv.F=4.71
Frequency: 450 MHz; Medium parameters used: $f = 450$ MHz; $\sigma = 0.88$ mho/m; $\epsilon_r = 43.06$; $\rho = 1000$ kg/m³ ;
Phantom Type: Elliptical Phantom; Input Power=10dBm
Ambient temperature (°C): 21.0, Liquid temperature (°C): 21.0

SATIMO Configuration:

- Probe: EP159; Calibrated: 01/12/2014
- Sensor-Surface: 4mm (Mechanical Surface Detection)
- Phantom: Flat Phantom; Type: Elliptical Phantom
- Measurement SW: OpenSAR V4_02_0

Configuration/System Check CW 450 MHz Head/Area Scan: Measurement grid: dx=8mm,dy=8mm

Configuration/System Check CW 450 MHz Head/Zoom Scan : Measurement grid: dx=8mm,
dy=8mm, dz=5mm,

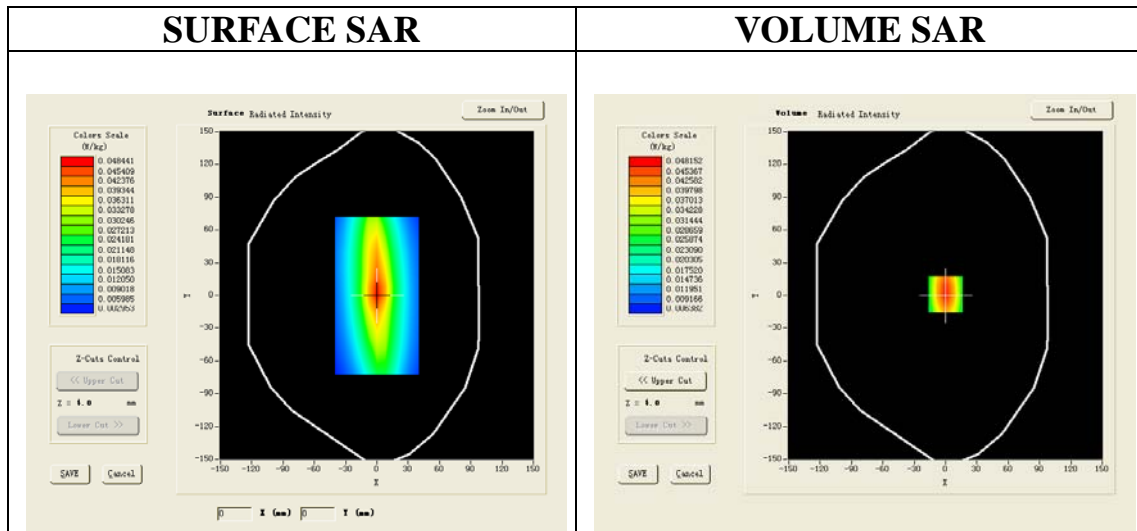

Maximum location: X=0.00, Y=1.00

SAR 10g (W/Kg)	0.030241
SAR 1g (W/Kg)	0.048617

Z (mm)	0.00	4.00	9.00	14.00	19.00
SAR (W/Kg)	0.0000	0.0467	0.0332	0.0216	0.0124

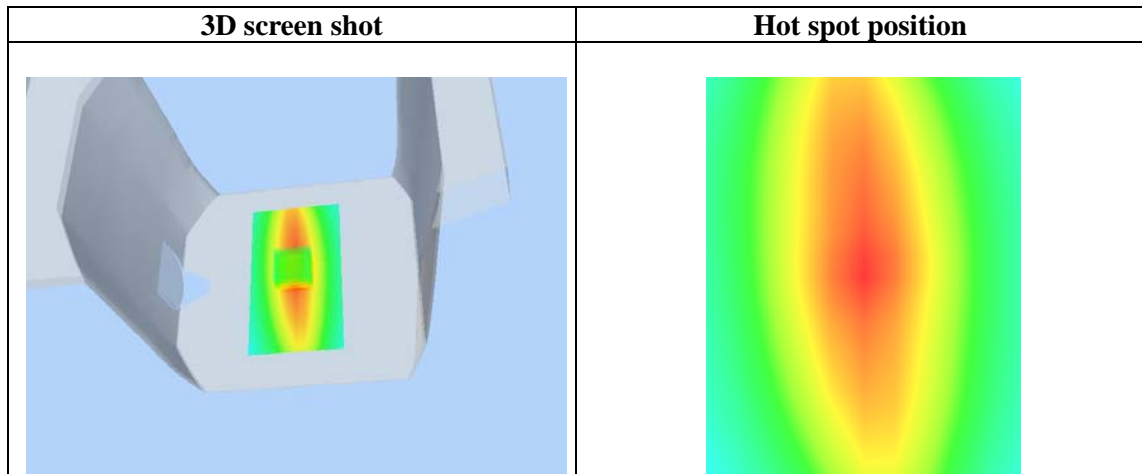
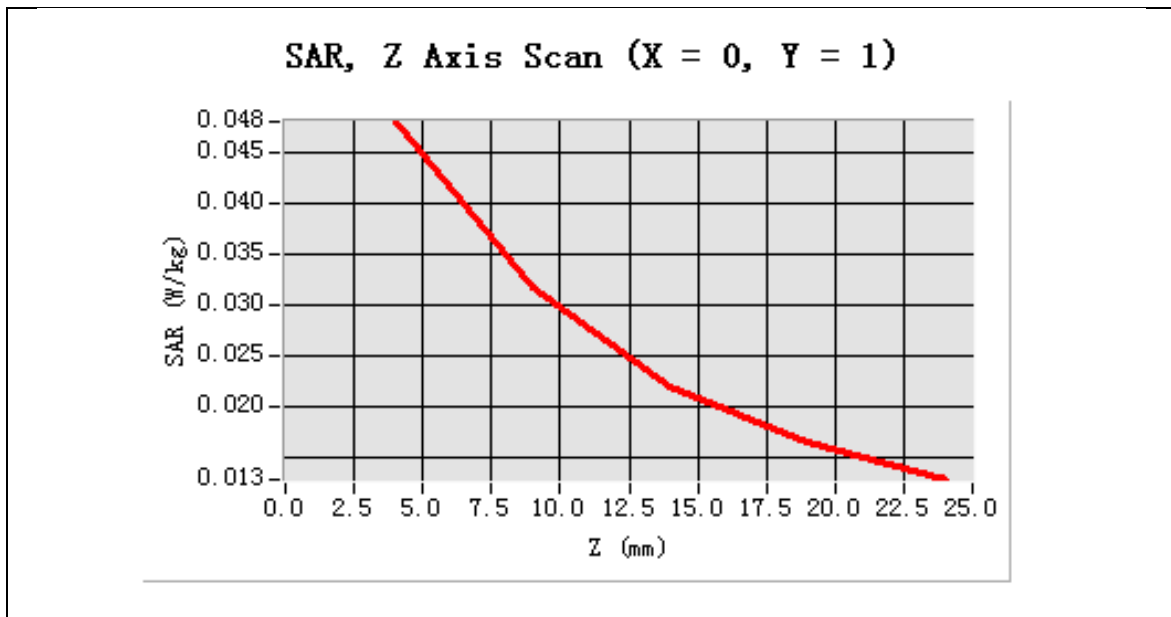

Test Laboratory: AGC Lab
System Check Body 450MHz
DUT: Dipole 450 MHz Type: SID 450

Date: Mar.19,2014

Communication System: CW; Communication System Band: CW 450 MHz; Duty Cycle: 1:1; Conv.F=4.83
Frequency: 450MHz; Medium parameters used: $f = 450$ MHz; $\sigma = 0.95$ mho/m; $\epsilon_r = 55.29$; $\rho = 1000$ kg/m³ ;
Phantom Type: Elliptical Phantom; Input Power=10dBm
Ambient temperature (°C): 21.0, Liquid temperature (°C): 21.0

SATIMO Configuration:

- Probe: EP159; Calibrated: 01/12/2014
- Sensor-Surface: 4mm (Mechanical Surface Detection)
- Phantom: Flat Phantom; Type: Elliptical Phantom
- Measurement SW: OpenSAR V4_02_0

Configuration/System Check CW 450 MHz Body/Area Scan: Measurement grid: dx=8mm,dy=8mm
Configuration/System Check CW 450 MHz Body/Zoom Scan : Measurement grid: dx=8mm,
dy=8mm, dz=5mm,

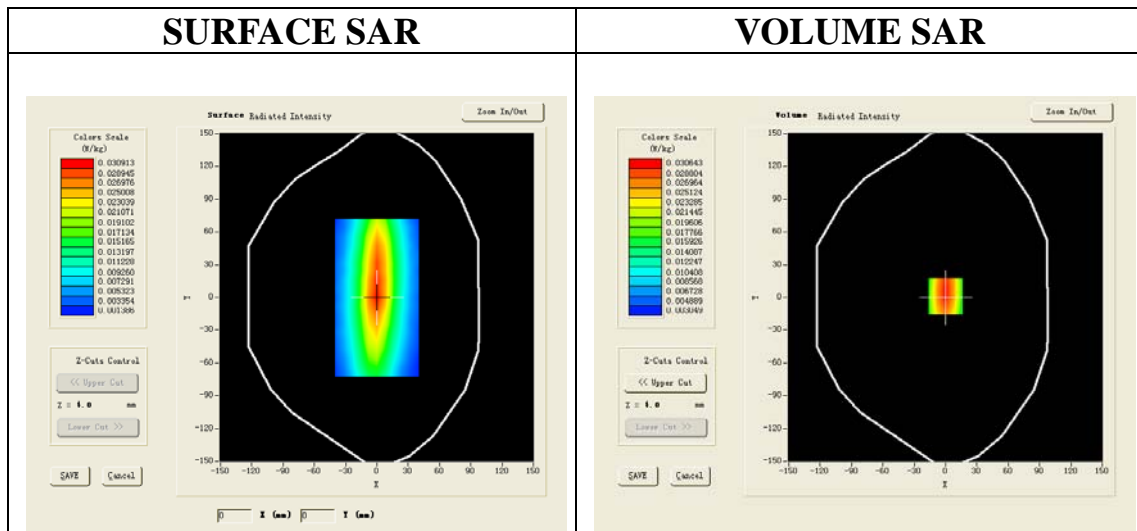

Maximum location: X=0.00, Y=1.00

SAR 10g (W/Kg)	0.031785
SAR 1g (W/Kg)	0.049745

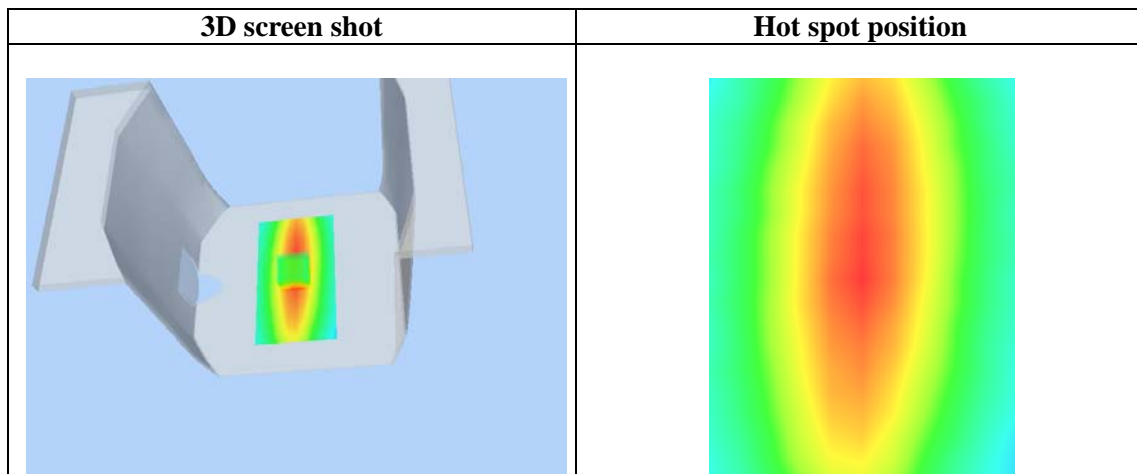
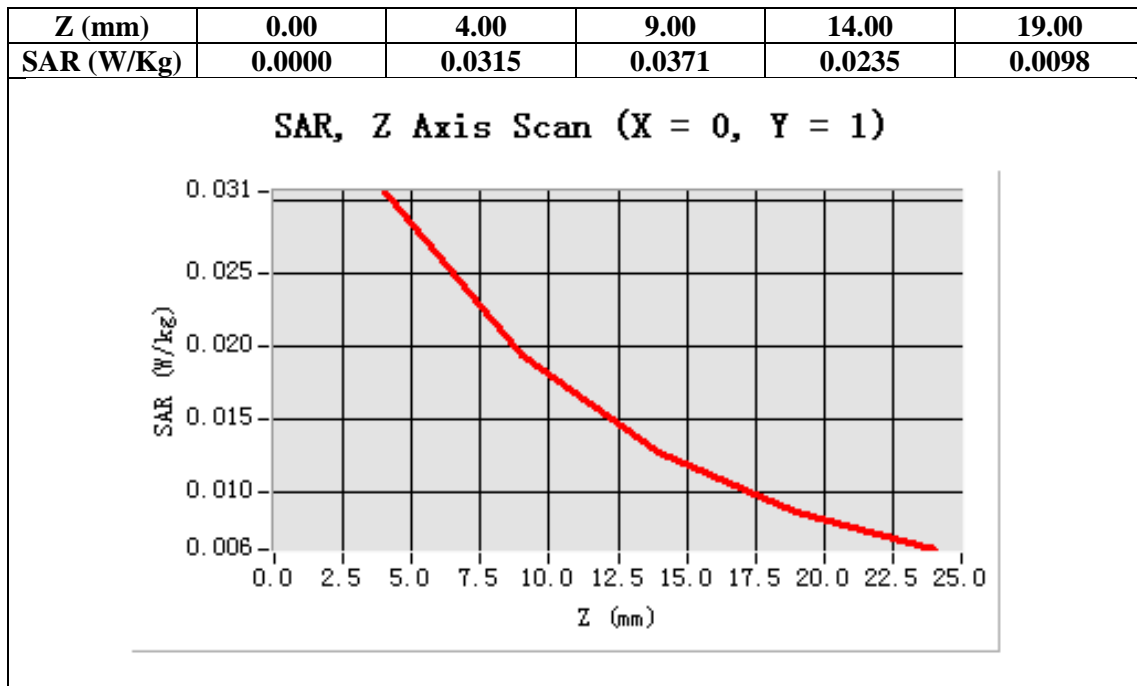

APPENDIX B. SAR MEASUREMENT DATA

Test Laboratory: AGC Lab
CW450 Low- Face up 2.5 cm separation (12.5 KHz)
DUT: TWO WAY RADIO; Type: 628G

Date: Mar.19,2014

Communication System: CW; Communication System Band: CW 450 MHz; Duty Cycle: 1:1; Conv.F=4.71
Frequency: 400.025MHz; Medium parameters used: $f = 450$ MHz; $\sigma = 0.85$ mho/m; $\epsilon_r = 44.37$; $\rho = 1000$ kg/m³ ;
Phantom Type: Elliptical Phantom
Ambient temperature (°C): 21.5, Liquid temperature (°C): 21.0

SATIMO Configuration:

- Probe: EP159; Calibrated: 01/12/2014
- Sensor-Surface: 4mm (Mechanical Surface Detection)
- Phantom: Flat Phantom; Type: Elliptical Phantom
- Measurement SW: OpenSAR V4_02_0

Configuration/CW 450 for Low head/Area Scan (6x8x1): Measurement grid: dx=8mm, dy=8mm
Configuration/CW 450 for Low head/Zoom Scan (5x5x7)/Cube 0: Measurement grid: dx=8mm, dy=8mm,dz=5mm;

Area Scan	ep_direct_droit2_surf8mm.txt
ZoomScan	5x5x7,dx=8mm dy=8mm dz=5mm,Very fast
Phantom	Elliptical Phantom
Device Position	Face up 2.5 cm separation to Phantom
Band	CW 450
Channels	Low
Signal	Crest factor: 1

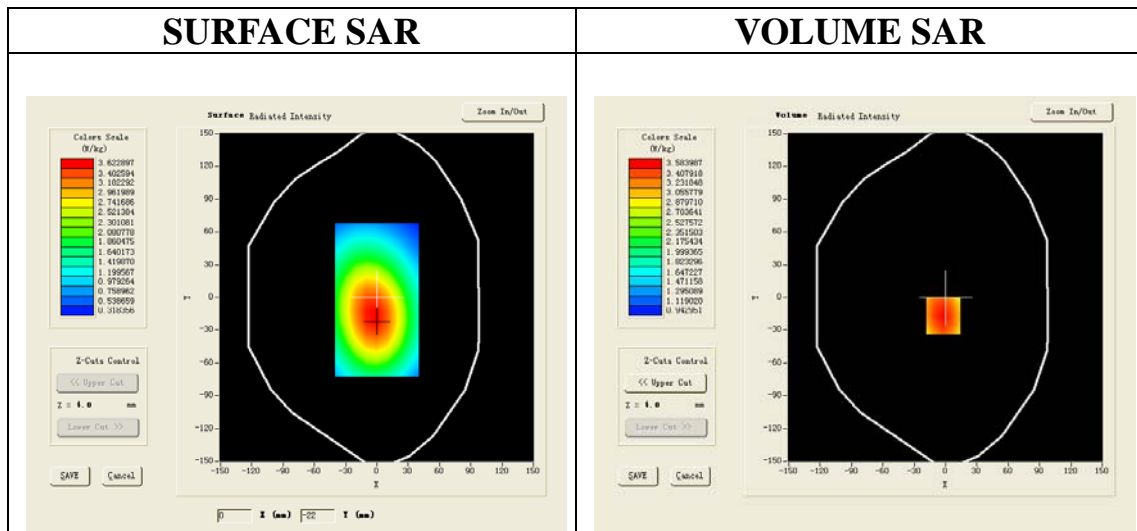

Maximum location: X=-2.00, Y=-17.00

SAR 10g (W/Kg)	2.738069
SAR 1g (W/Kg)	3.737547

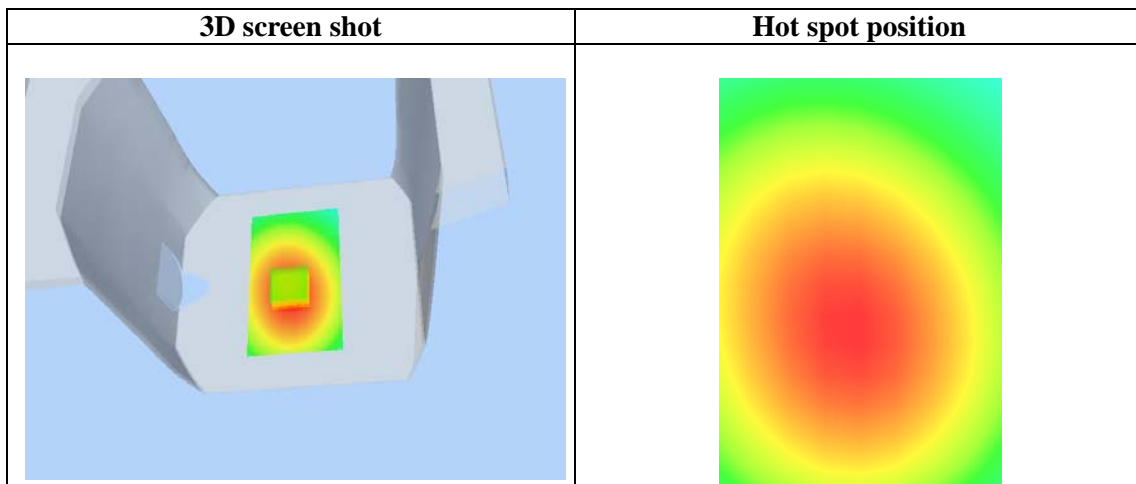
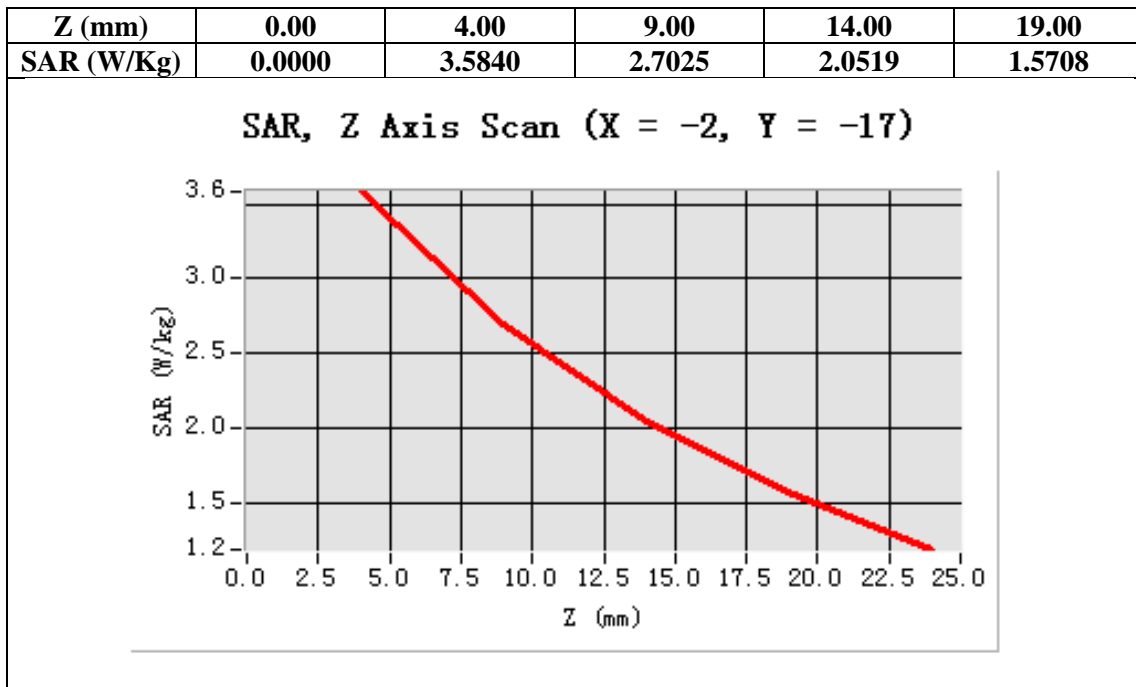

Test Laboratory: AGC Lab
CW450 Mid- Face up 2.5 cm separation (12.5 KHz)
DUT: TWO WAY RADIO; Type: 628G

Date: Mar.19,2014

Communication System: CW; Communication System Band: CW 450 MHz; Duty Cycle: 1:1; Conv.F=4.71
Frequency: 440.000 MHz; Medium parameters used: $f = 450$ MHz; $\sigma = 0.88$ mho/m; $\epsilon_r = 43.06$; $\rho = 1000$ kg/m³ ;
Phantom Type: Elliptical Phantom
Ambient temperature (°C): 21.5, Liquid temperature (°C): 21.0

SATIMO Configuration:

- Probe: EP159; Calibrated: 01/12/2014
- Sensor-Surface: 4mm (Mechanical Surface Detection)
- Phantom: Flat Phantom; Type: Elliptical Phantom
- Measurement SW: OpenSAR V4_02_0

Configuration/CW 450 for Mid head/Area Scan (6x8x1): Measurement grid: dx=8mm, dy=8mm
Configuration/CW 450 for Mid head/Zoom Scan (5x5x7)/Cube 0: Measurement grid: dx=8mm, dy=8mm,dz=5mm;

Area Scan	ep_direct_droit2_surf8mm.txt
ZoomScan	5x5x7,dx=8mm dy=8mm dz=5mm,Very fast
Phantom	Elliptical Phantom
Device Position	Face up 2.5 cm separation to Phantom
Band	CW 450
Channels	Middle
Signal	Crest factor: 1

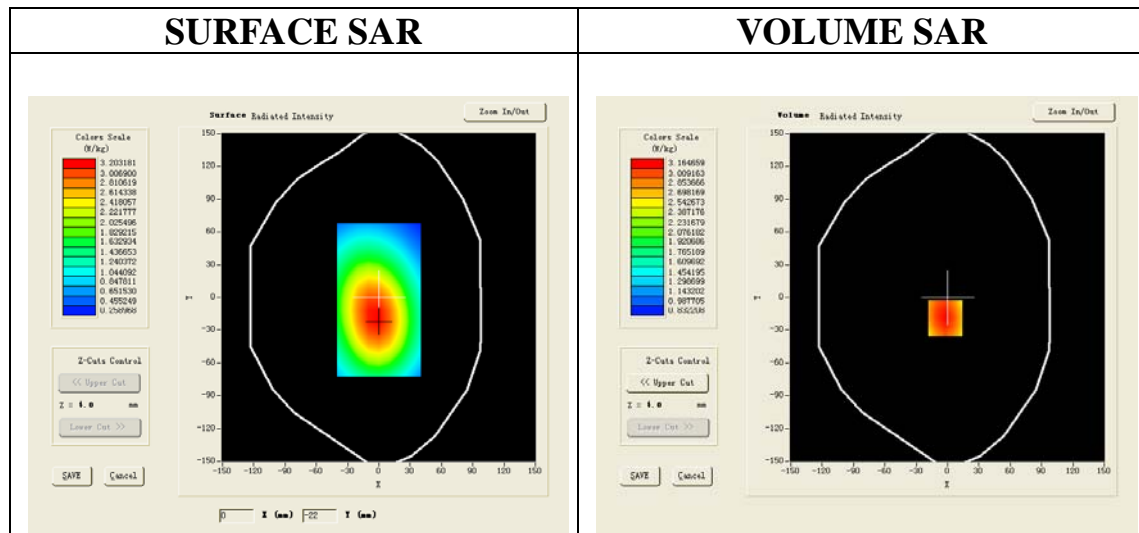

Maximum location: X=-2.00, Y=-19.00

SAR 10g (W/Kg)	2.415171
SAR 1g (W/Kg)	3.300423

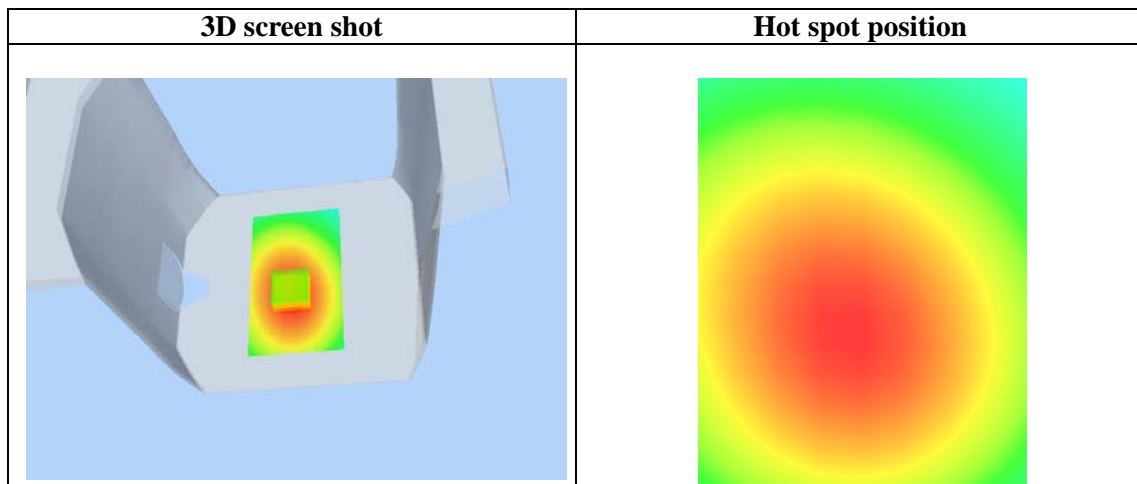
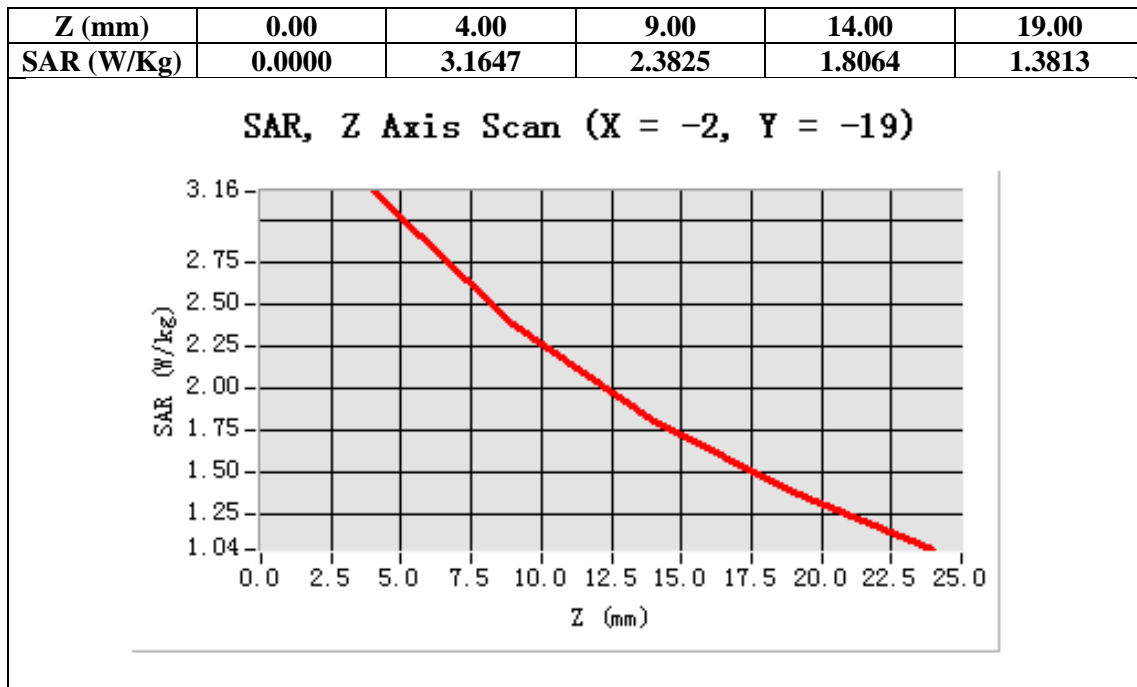

Test Laboratory: AGC Lab
CW450 High- Face up 2.5 cm separation (12.5 KHz)
DUT: TWO WAY RADIO; Type: 628g

Date: Mar.19,2014

Communication System: CW; Communication System Band: CW 450 MHz; Duty Cycle: 1:1; Conv.F=4.71
Frequency: 479.975MHz; Medium parameters used: $f = 450$ MHz; $\sigma = 0.86$ mho/m; $\epsilon_r = 43.84$; $\rho = 1000$ kg/m³ ;
Phantom Type: Elliptical Phantom
Ambient temperature (°C): 21.5, Liquid temperature (°C): 21.0

SATIMO Configuration:

- Probe: EP159; Calibrated: 01/12/2014
- Sensor-Surface: 4mm (Mechanical Surface Detection)
- Phantom: Flat Phantom; Type: Elliptical Phantom
- Measurement SW: OpenSAR V4_02_0

Configuration/CW 450 for High head/Area Scan (6x8x1): Measurement grid: dx=8mm, dy=8mm
Configuration/CW 450 for High head/Zoom Scan (5x5x7)/Cube 0: Measurement grid: dx=8mm, dy=8mm,dz=5mm;

Area Scan	ep_direct_droit2_surf8mm.txt
ZoomScan	5x5x7,dx=8mm dy=8mm dz=5mm,Very fast
Phantom	Elliptical Phantom
Device Position	Face up 2.5 cm separation to Phantom
Band	CW 450
Channels	High
Signal	Crest factor: 1

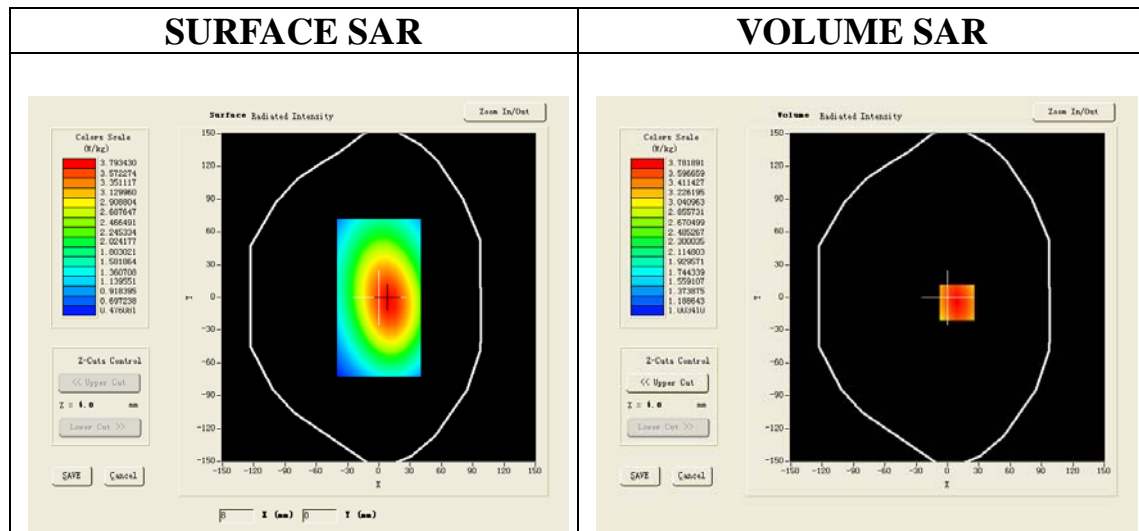

Maximum location: X=9.00, Y=-5.00

SAR 10g (W/Kg)	2.421624
SAR 1g (W/Kg)	3.218092

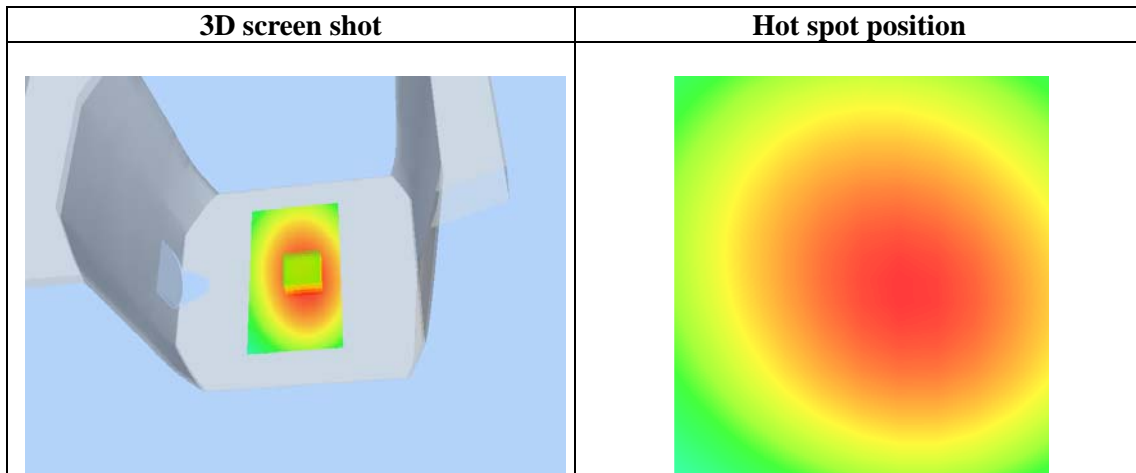
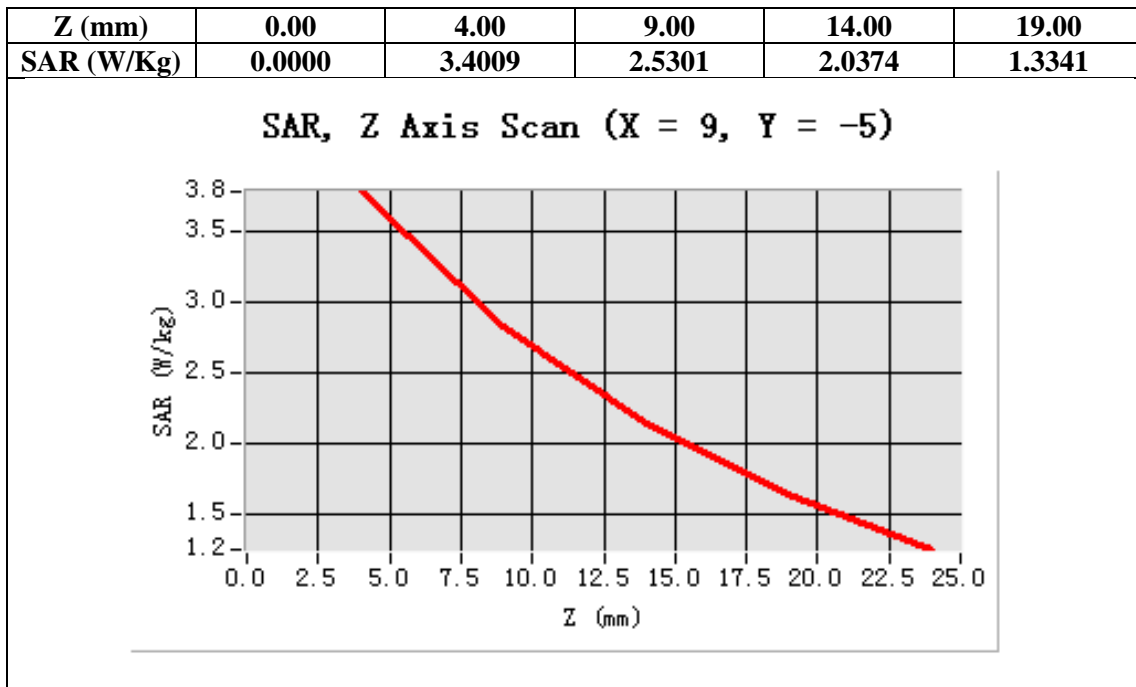

Test Laboratory: AGC Lab
CW450 Low -Body -Touch (12.5 KHz)
DUT: TWO WAY RADIO; Type: 628G

Date: Mar.19,2014

Communication System: CW; Communication System Band: CW 450 MHz; Duty Cycle: 1:1; Conv.F=4.83
Frequency: 400.025MHz; Medium parameters used: $f = 450$ MHz; $\sigma = 0.91$ mho/m; $\epsilon_r = 54.40$; $\rho = 1000$ kg/m³ ;
Phantom Type: Elliptical Phantom
Ambient temperature (°C): 21.5, Liquid temperature(°C): 21.0

SATIMO Configuration:

- Probe: EP159; Calibrated: 01/12/2014
- Sensor-Surface: 4mm (Mechanical Surface Detection)
- Phantom: Flat Phantom; Type: Elliptical Phantom
- Measurement SW: OpenSAR V4_02_0

Configuration/CW 450 for Low Touch/Area Scan: Measurement grid: dx=8mm, dy=8mm
Configuration/CW 450 for Low Touch/Zoom Scan: Measurement grid: dx=8mm, dy=8mm, dz=5mm,

Area Scan	ep_direct_droit2_surf8mm.txt
ZoomScan	5x5x7,dx=8mm dy=8mm dz=5mm,Very fast
Phantom	Elliptical Phantom
Device Position	Back close to Phantom with Accessories
Band	CW 450
Channels	Low
Signal	Crest factor: 1

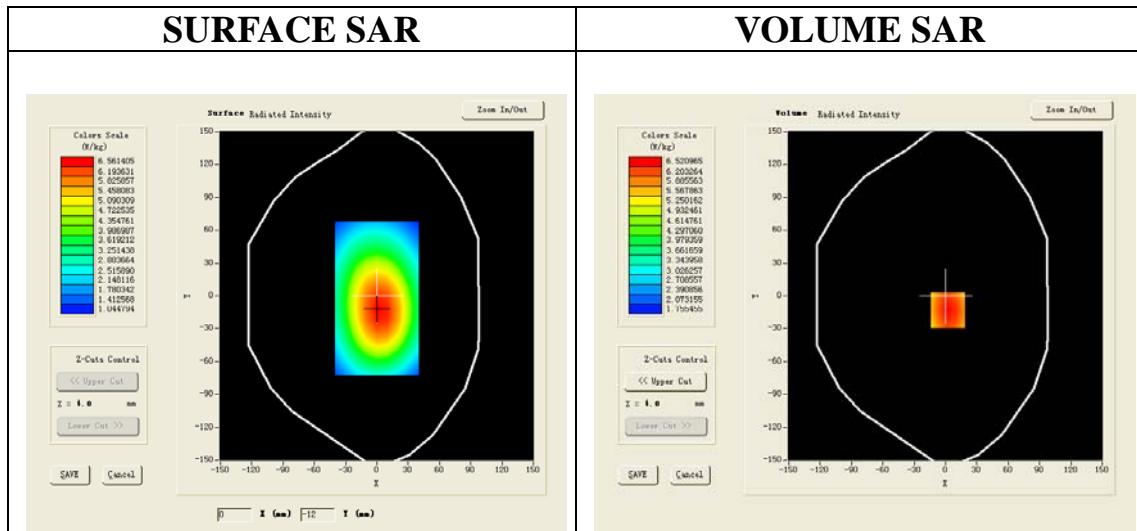

Maximum location: X=2.00, Y=-13.00

SAR 10g (W/Kg)	4.031277
SAR 1g (W/Kg)	6.249351

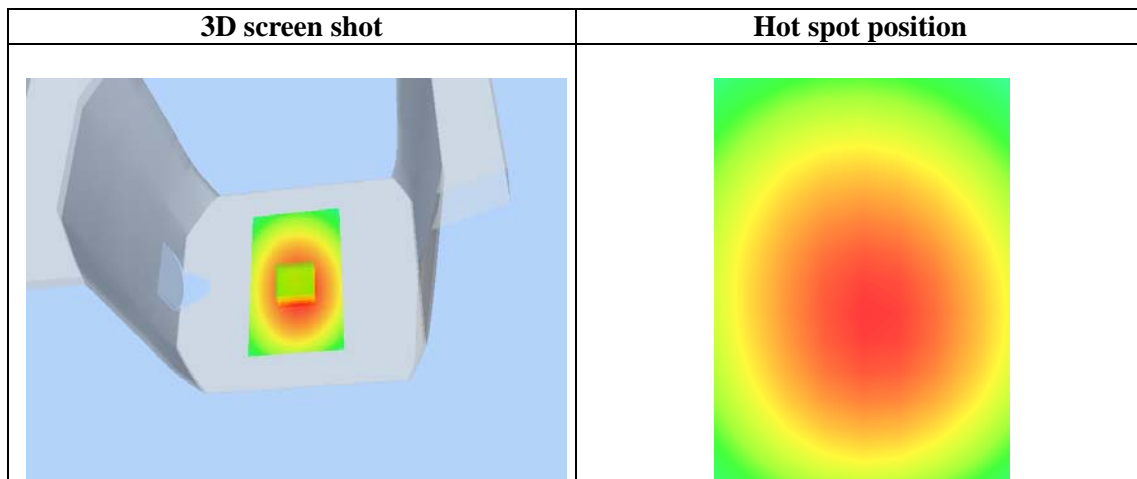
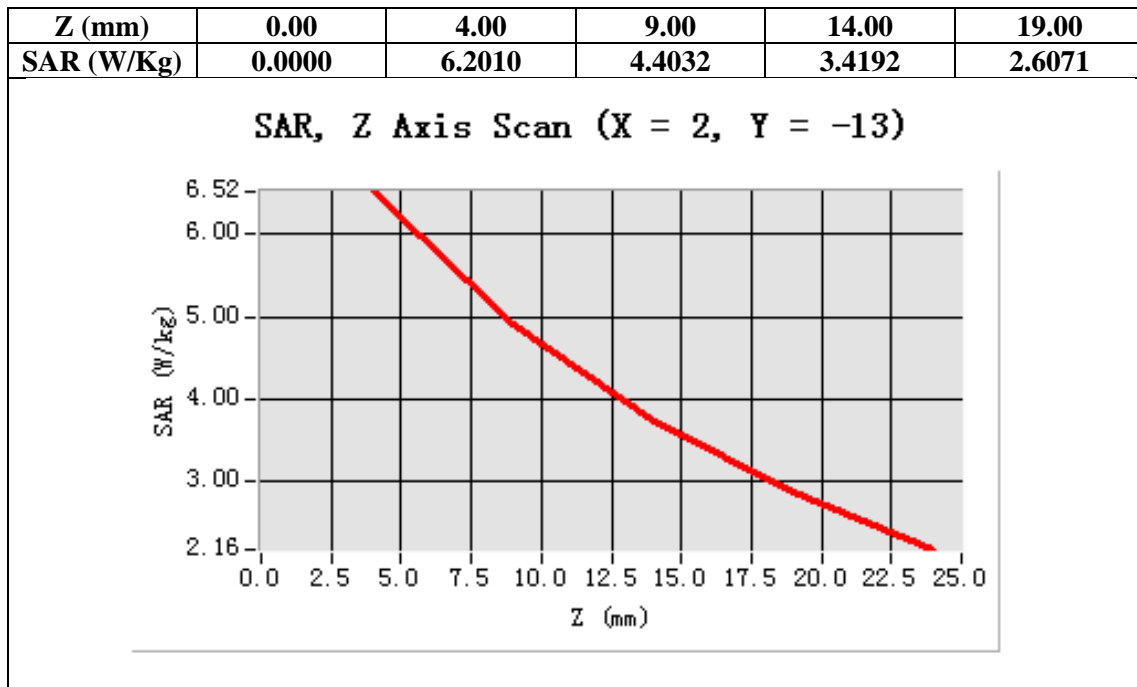

Test Laboratory: AGC Lab
CW450 Mid -Body –Touch (12.5 KHz)
DUT: TWO WAY RADIO; Type: 628G

Date: Mar.19,2014

Communication System: CW; Communication System Band: CW 450 MHz; Duty Cycle: 1:1; Conv.F=4.83
Frequency: 440.000 MHz; Medium parameters used: $f = 450$ MHz; $\sigma = 0.95$ mho/m; $\epsilon_r = 55.29$; $\rho = 1000$ kg/m³ ;
Phantom Type: Elliptical Phantom
Ambient temperature (°C): 21.5, Liquid temperature(°C): 21.0

SATIMO Configuration:

- Probe: EP159; Calibrated: 01/12/2014
- Sensor-Surface: 4mm (Mechanical Surface Detection)
- Phantom: Flat Phantom; Type: Elliptical Phantom
- Measurement SW: OpenSAR V4_02_0

Configuration/CW 450 for Mid Touch/Area Scan: Measurement grid: dx=8mm, dy=8mm

Configuration/CW 450 for Mid Touch/Zoom Scan: Measurement grid: dx=8mm, dy=8mm, dz=5mm,

Area Scan	ep_direct_droit2_surf8mm.txt
ZoomScan	5x5x7,dx=8mm dy=8mm dz=5mm,Very fast
Phantom	Elliptical Phantom
Device Position	Back close to Phantom with Accessories
Band	CW 450
Channels	Middle
Signal	Crest factor: 1

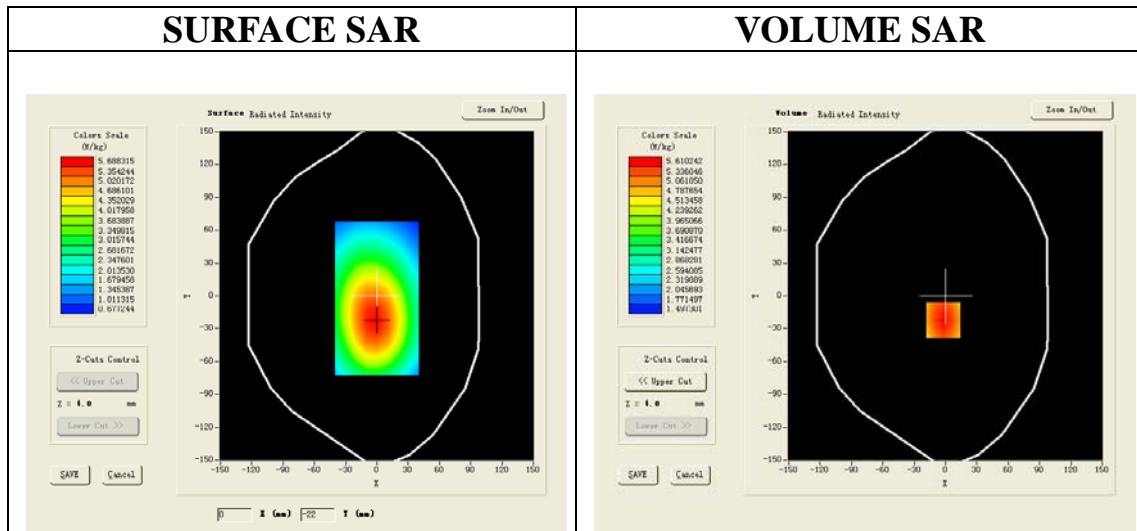

Maximum location: X=-2.00, Y=-22.00

SAR 10g (W/Kg)	4.185961
SAR 1g (W/Kg)	5.739018

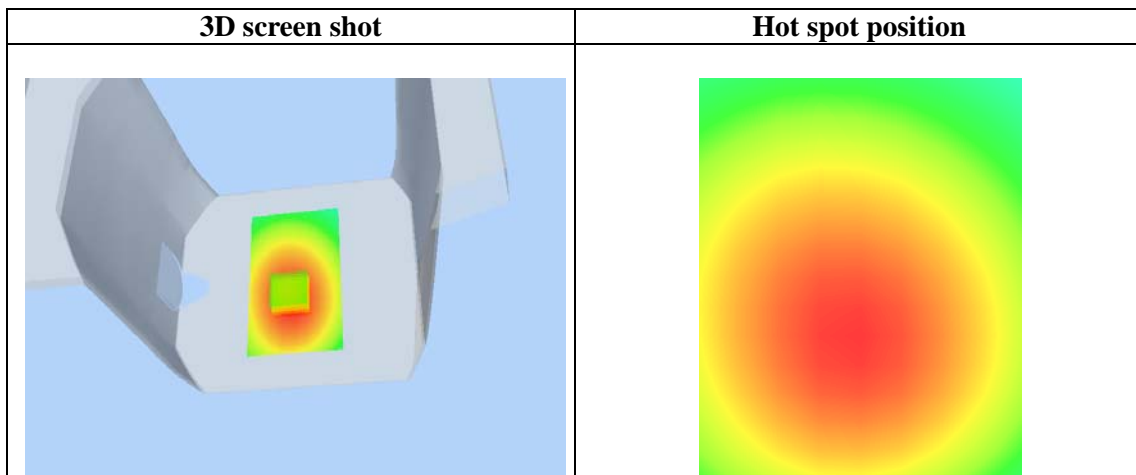
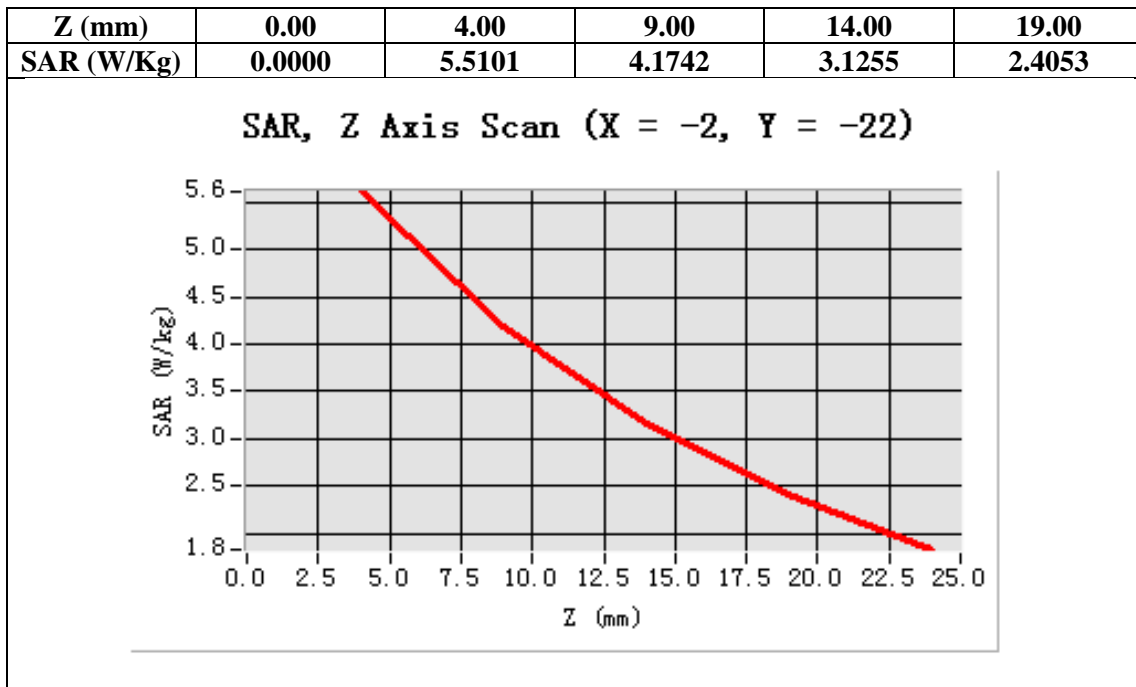

Test Laboratory: AGC Lab
CW450 High -Body –Touch (12.5 KHz)
DUT: TWO WAY RADIO; Type: 628G

Date: Mar.19,2014

Communication System: CW; Communication System Band: CW 450 MHz; Duty Cycle: 1:1; Conv.F=4.83
Frequency: 479.975MHz; Medium parameters used: $f = 450$ MHz; $\sigma = 0.94$ mho/m; $\epsilon_r = 56.19$; $\rho = 1000$ kg/m³ ;
Phantom Type: Elliptical Phantom
Ambient temperature (°C): 21.5, Liquid temperature(°C): 21.0

SATIMO Configuration:

- Probe: EP159; Calibrated: 01/12/2014
- Sensor-Surface: 4mm (Mechanical Surface Detection)
- Phantom: Flat Phantom; Type: Elliptical Phantom
- Measurement SW: OpenSAR V4_02_0

Configuration/CW 450 for High Touch/Area Scan: Measurement grid: dx=8mm, dy=8mm

Configuration/CW 450 for High Touch/Zoom Scan: Measurement grid: dx=8mm, dy=8mm, dz=5mm,

Area Scan	ep_direct_droit2_surf8mm.txt
ZoomScan	5x5x7,dx=8mm dy=8mm dz=5mm,Very fast
Phantom	Elliptical Phantom
Device Position	Back close to Phantom with Accessories
Band	CW 450
Channels	High
Signal	Crest factor: 1

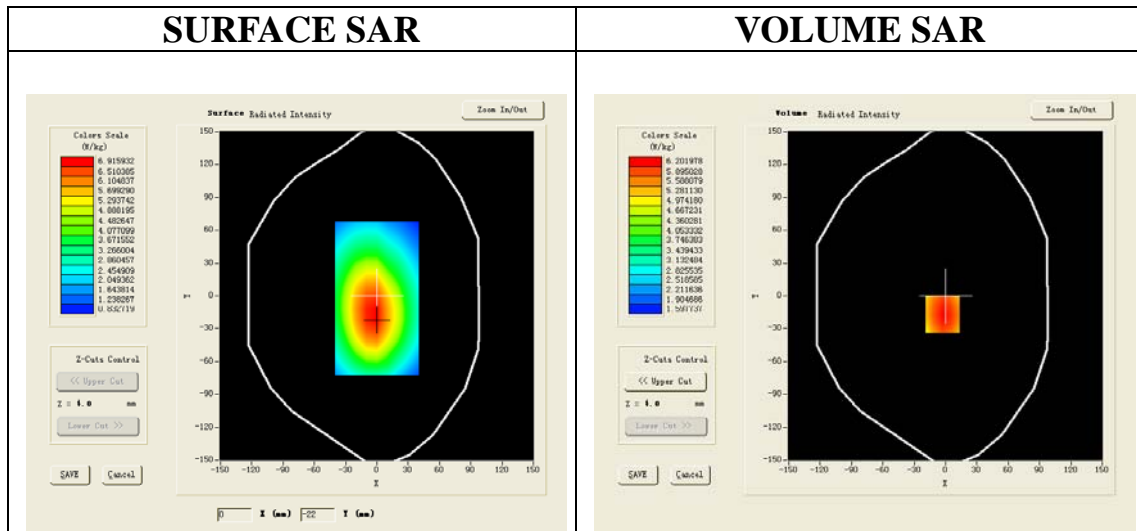

Maximum location: X=-3.00, Y=-17.00

SAR 10g (W/Kg)	4.526180
SAR 1g (W/Kg)	6.130549

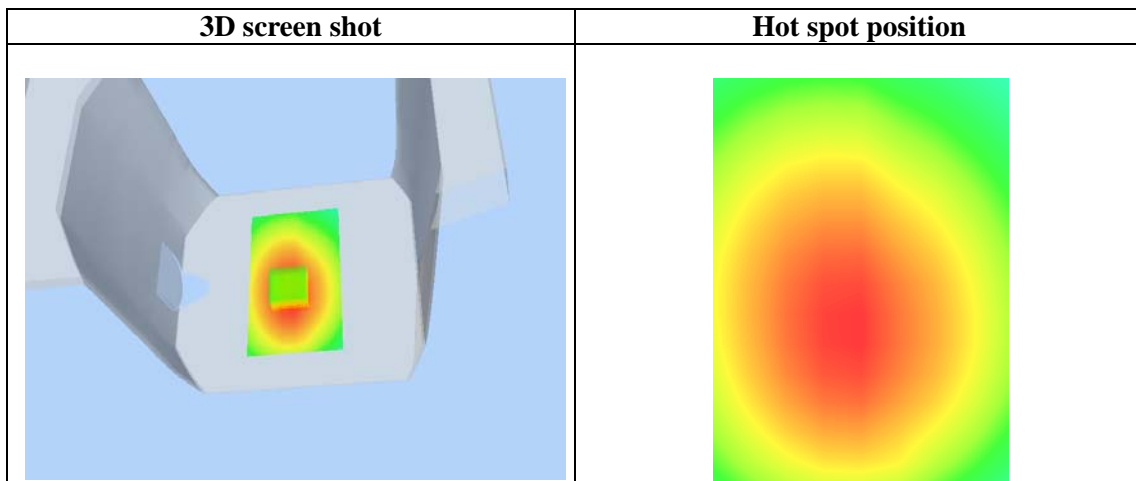
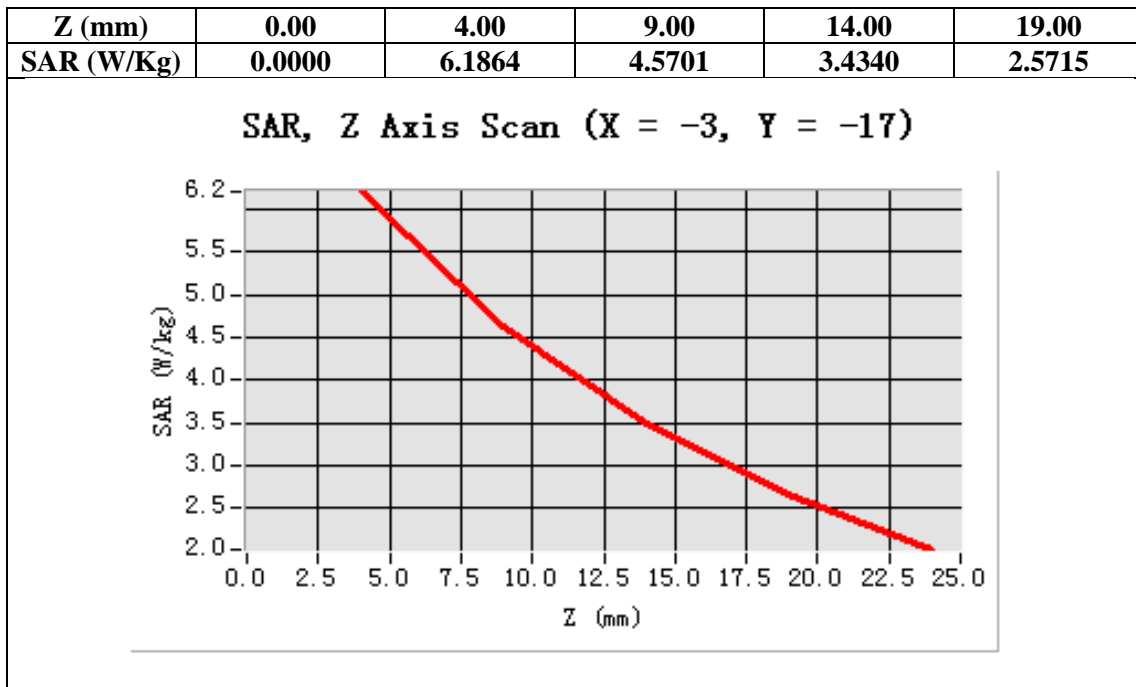

APPENDIX C. TEST SETUP PHOTOGRAPHS & EUT PHOTOGRAPHS

Test Setup Photographs

Face Up with 2.5 cm Separation Distance.

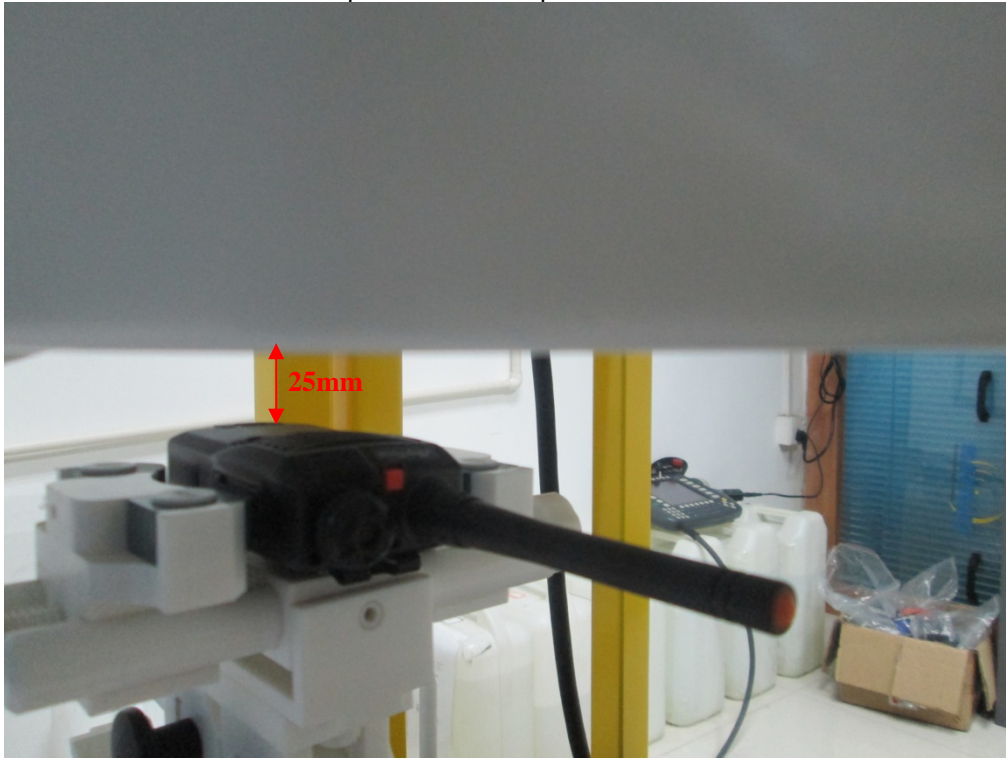

Body Back Touch with all accessories



DEPTH OF THE LIQUID IN THE PHANTOM—ZOOM IN

Note : The position used in the measurement were according to IEEE 1528-2003



EUT PHOTOGRAPHS
TOTAL VIEW OF EUT



TOP VIEW OF EUT



BOTTOM VIEW OF EUT



FRONT VIEW OF EUT

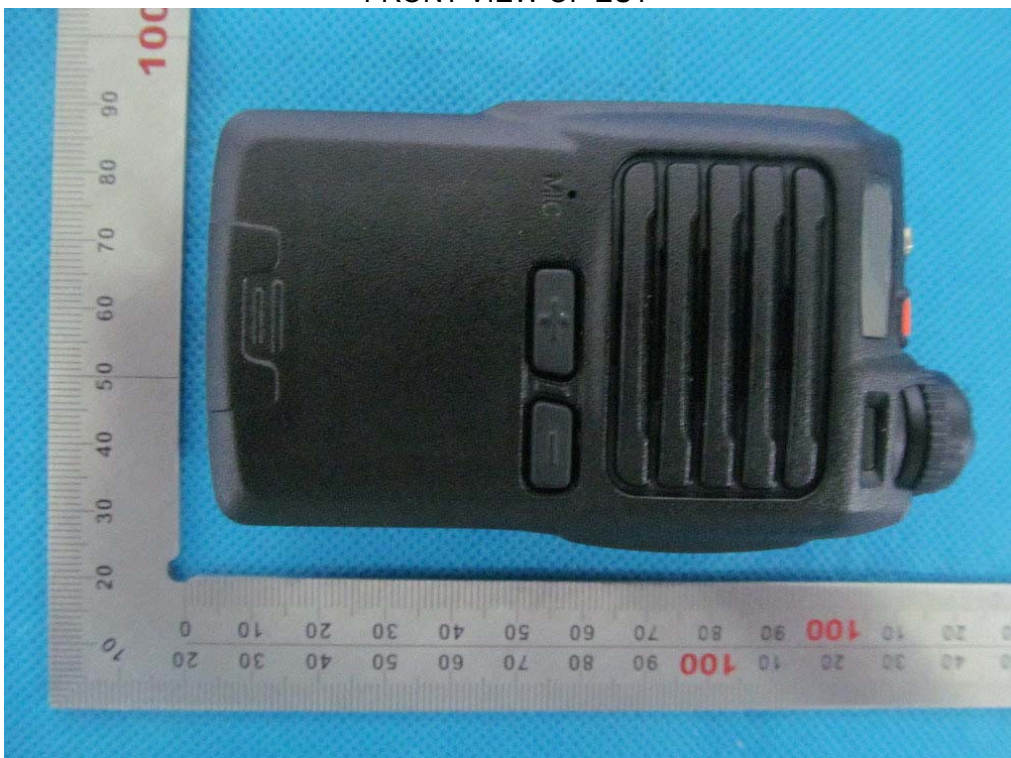

BACK VIEW OF EUT



LEFT VIEW OF EUT



RIGHT VIEW OF EUT



OPEN VIEW-1 OF EUT



OPEN VIEW-2 OF EUT

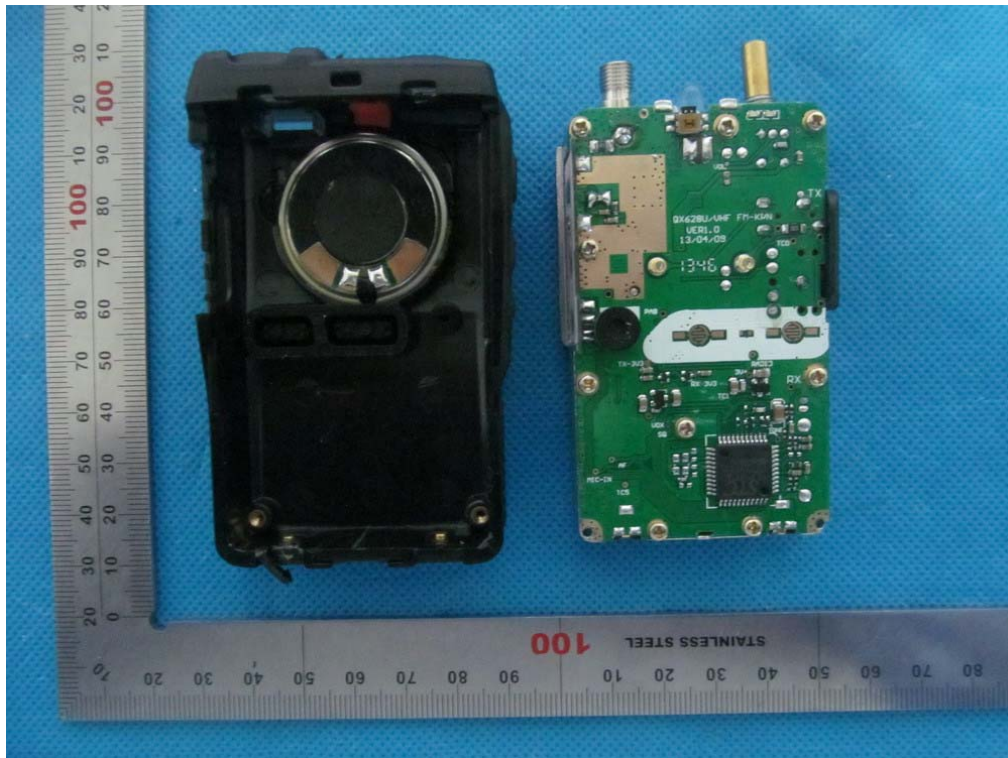

INTERNAL VIEW-1 OF EUT

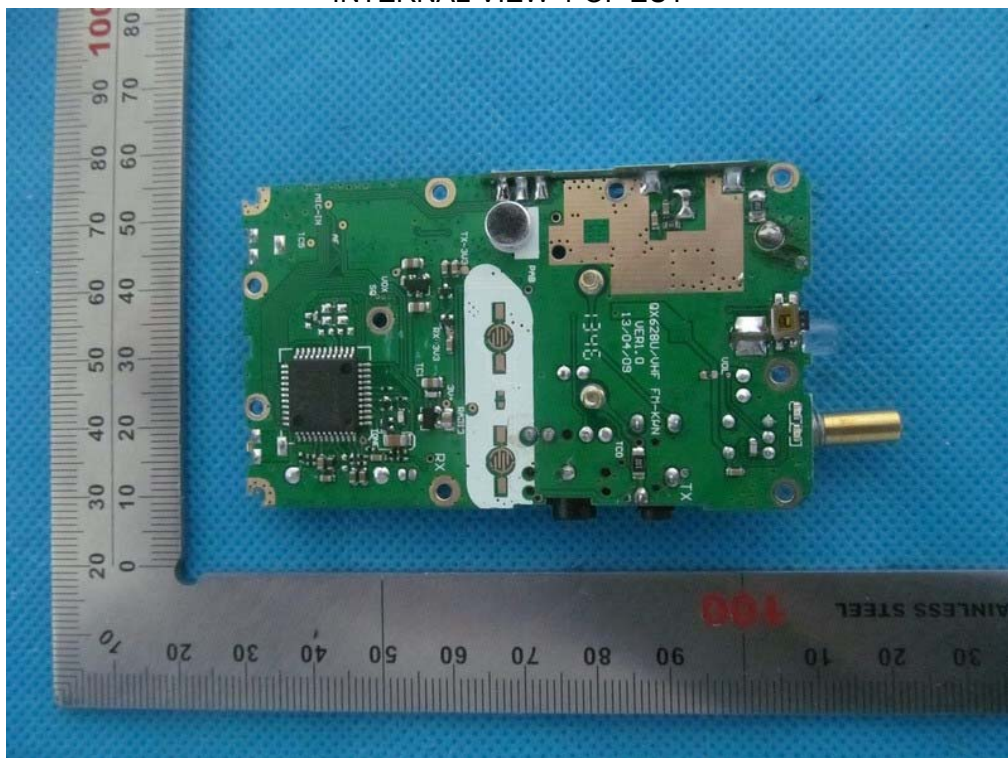

INTERNAL VIEW-2 OF EUT

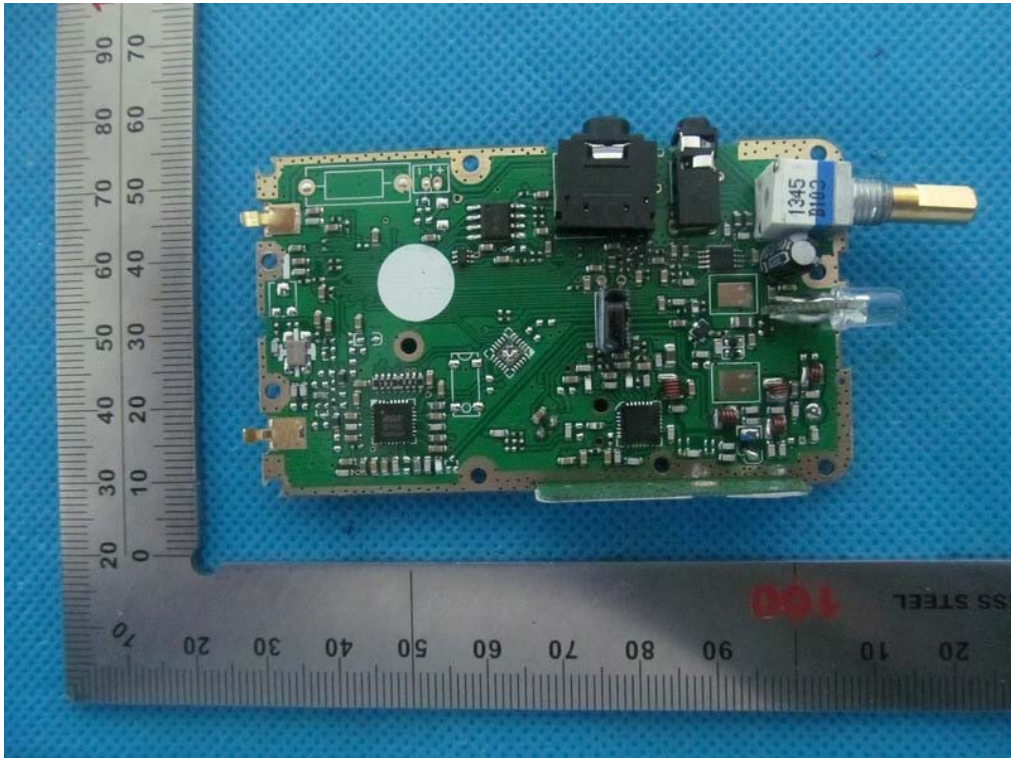

APPENDIX D. PROBE CALIBRATION DATA



COMOSAR E-Field Probe Calibration Report

Ref : ACR.351.1.14.SATU.A

**ATTESTATION OF GLOBAL COMPLIANCE CO.
LTD.**

**1&2F, NO.2 BUILDING, HUAFENG NO.1 INDUSTRIAL
PARK, GUSHU COMMUNITY XIXIANG STREET
BAOAN DISTRICT, SHENZHEN, P.R. CHINA
SATIMO COMOSAR DOSIMETRIC E-FIELD PROBE**

SERIAL NO.: SN 22/12 EP159

**Calibrated at SATIMO US
2105 Barrett Park Dr. - Kennesaw, GA 30144**



01/12/14

Summary:

This document presents the method and results from an accredited COMOSAR Dosimetric E-Field Probe calibration performed in SATIMO USA using the CALISAR / CALIBAIR test bench, for use with a SATIMO COMOSAR system only. All calibration results are traceable to national metrology institutions.



	<i>Name</i>	<i>Function</i>	<i>Date</i>	<i>Signature</i>
<i>Prepared by :</i>	Jérôme LUC	Product Manager	1/12/2014	<i>JS</i>
<i>Checked by :</i>	Jérôme LUC	Product Manager	1/12/2014	<i>JS</i>
<i>Approved by :</i>	Kim RUTKOWSKI	Quality Manager	1/12/2014	<i>Kim Rutkowski</i>

Customer Name
ATTESTATION
OF GLOBAL
COMPLIANCE
CO. LTD.

Distribution :

<i>Issue</i>	<i>Date</i>	<i>Modifications</i>
A	1/12/2014	Initial release



TABLE OF CONTENTS

1	Device Under Test	4
2	Product Description.....	4
2.1	General Information	4
3	Measurement Method.....	4
3.1	Linearity	4
3.2	Sensitivity	5
3.3	Lower Detection Limit	5
3.4	Isotropy.....	5
3.5	Boundary Effect	5
4	Measurement Uncertainty	5
5	Calibration Measurement Results	6
5.1	Sensitivity in air	6
5.2	Linearity	7
5.3	Sensitivity in liquid	7
5.4	Isotropy.....	8
6	List of Equipment	10



1 DEVICE UNDER TEST

Device Under Test	
Device Type	COMOSAR DOSIMETRIC E FIELD PROBE
Manufacturer	Satimo
Model	SSE5
Serial Number	SN 22/12 EP159
Product Condition (new / used)	used
Frequency Range of Probe	0.3 GHz-3GHz
Resistance of Three Dipoles at Connector	Dipole 1: R1=0.230 MΩ Dipole 2: R2=0.226 MΩ Dipole 3: R3=0.231 MΩ

A yearly calibration interval is recommended.

2 PRODUCT DESCRIPTION

2.1 GENERAL INFORMATION

Satimo’s COMOSAR E field Probes are built in accordance to the IEEE 1528, OET 65 Bulletin C and CEI/IEC 62209 standards.



Figure 1 – Satimo COMOSAR Dosimetric E field Dipole

Probe Length	330 mm
Length of Individual Dipoles	4.5 mm
Maximum external diameter	8 mm
Probe Tip External Diameter	5 mm
Distance between dipoles / probe extremity	2.7 mm

3 MEASUREMENT METHOD

The IEEE 1528, OET 65 Bulletin C, CENELEC EN50361 and CEI/IEC 62209 standards provide recommended practices for the probe calibrations, including the performance characteristics of interest and methods by which to assess their affect. All calibrations / measurements performed meet the fore mentioned standards.

3.1 LINEARITY

The evaluation of the linearity was done in free space using the waveguide, performing a power sweep to cover the SAR range 0.01W/kg to 100W/kg.



3.2 SENSITIVITY

The sensitivity factors of the three dipoles were determined using a two step calibration method (air and tissue simulating liquid) using waveguides as outlined in the standards.

3.3 LOWER DETECTION LIMIT

The lower detection limit was assessed using the same measurement set up as used for the linearity measurement. The required lower detection limit is 10 mW/kg.

3.4 ISOTROPY

The axial isotropy was evaluated by exposing the probe to a reference wave from a standard dipole with the dipole mounted under the flat phantom in the test configuration suggested for system validations and checks. The probe was rotated along its main axis from 0 - 360 degrees in 15 degree steps. The hemispherical isotropy is determined by inserting the probe in a thin plastic box filled with tissue-equivalent liquid, with the plastic box illuminated with the fields from a half wave dipole. The dipole is rotated about its axis (0°–180°) in 15° increments. At each step the probe is rotated about its axis (0°–360°).

3.5 BOUNDARY EFFECT

The boundary effect is defined as the deviation between the SAR measured data and the expected exponential decay in the liquid when the probe is oriented normal to the interface. To evaluate this effect, the liquid filled flat phantom is exposed to fields from either a reference dipole or waveguide. With the probe normal to the phantom surface, the peak spatial average SAR is measured and compared to the analytical value at the surface.

4 MEASUREMENT UNCERTAINTY

The guidelines outlined in the IEEE 1528, OET 65 Bulletin C, CENELEC EN50361 and CEI/IEC 62209 standards were followed to generate the measurement uncertainty associated with an E-field probe calibration using the waveguide technique. All uncertainties listed below represent an expanded uncertainty expressed at approximately the 95% confidence level using a coverage factor of k=2, traceable to the Internationally Accepted Guides to Measurement Uncertainty.

Uncertainty analysis of the probe calibration in waveguide					
ERROR SOURCES	Uncertainty value (%)	Probability Distribution	Divisor	ci	Standard Uncertainty (%)
Incident or forward power	3.00%	Rectangular	$\sqrt{3}$	1	1.732%
Reflected power	3.00%	Rectangular	$\sqrt{3}$	1	1.732%
Liquid conductivity	5.00%	Rectangular	$\sqrt{3}$	1	2.887%
Liquid permittivity	4.00%	Rectangular	$\sqrt{3}$	1	2.309%
Field homogeneity	3.00%	Rectangular	$\sqrt{3}$	1	1.732%
Field probe positioning	5.00%	Rectangular	$\sqrt{3}$	1	2.887%
Field probe linearity	3.00%	Rectangular	$\sqrt{3}$	1	1.732%



Combined standard uncertainty					5.831%
Expanded uncertainty 95 % confidence level k = 2					11.662%

5 CALIBRATION MEASUREMENT RESULTS

Calibration Parameters	
Liquid Temperature	21 °C
Lab Temperature	21 °C
Lab Humidity	45 %

5.1 SENSITIVITY IN AIR

Normx dipole 1 ($\mu\text{V}/(\text{V}/\text{m})^2$)	Normy dipole 2 ($\mu\text{V}/(\text{V}/\text{m})^2$)	Normz dipole 3 ($\mu\text{V}/(\text{V}/\text{m})^2$)
5.41	4.68	5.48

DCP dipole 1 (mV)	DCP dipole 2 (mV)	DCP dipole 3 (mV)
102	99	95

Calibration curves $e_i=f(V)$ ($i=1,2,3$) allow to obtain H-field value using the formula:

$$E = \sqrt{E_1^2 + E_2^2 + E_3^2}$$

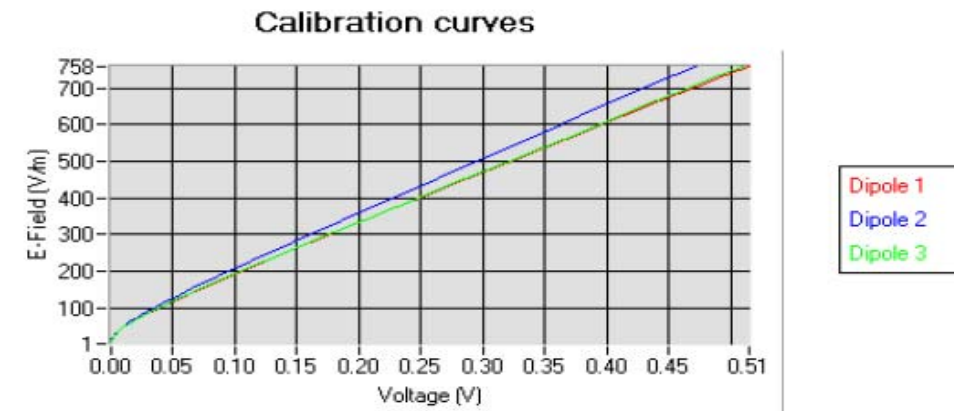



5.2 LINEARITY

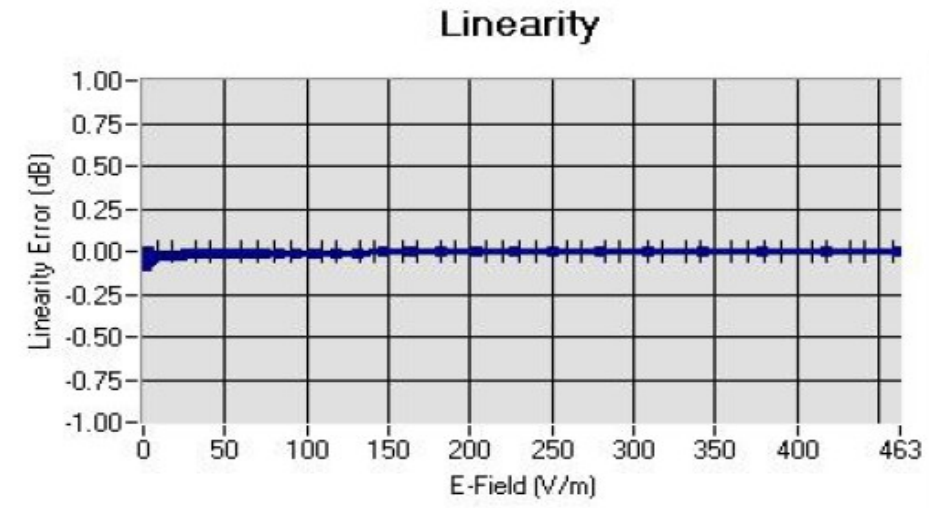

Linearity: $\pm 1.97\%$ ($\pm 0.09\text{dB}$)

5.3 SENSITIVITY IN LIQUID

Liquid	Frequency (MHz +/- 100MHz)*	Permittivity	Epsilon (S/m)	ConvF
HL300	300	45.27	0.85	4.60
BL300	300	58.01	0.94	4.68
HL450	450	42.87	0.89	4.71
BL450	450	56.37	0.93	4.83
HL850	835	41.12	0.91	5.27
BL850	835	55.03	0.97	5.48
HL900	900	40.77	0.98	5.20
BL900	900	55.49	1.04	5.28
HL1800	1750	39.22	1.38	4.58
BL1800	1750	53.27	1.51	4.71
HL1900	1880	39.54	1.41	4.51
BL1900	1880	52.88	1.55	4.45
HL2000	1950	38.97	1.45	4.31
BL2000	1950	52.01	1.58	4.33
HL2450	2450	39.17	1.85	4.42
BL2450	2450	52.47	1.99	4.31

LOWER DETECTION LIMIT: 9mW/kg



5.4 ISOTROPY

HL900 MHz

- Axial isotropy: 0.04 dB
- Hemispherical isotropy: 0.08 dB

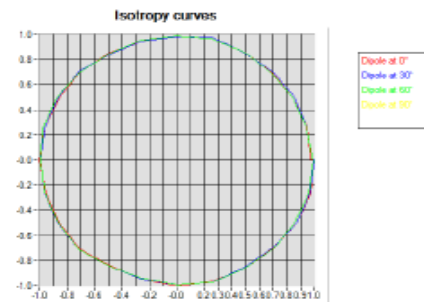

HL1800 MHz

- Axial isotropy: 0.07 dB
- Hemispherical isotropy: 0.12 dB

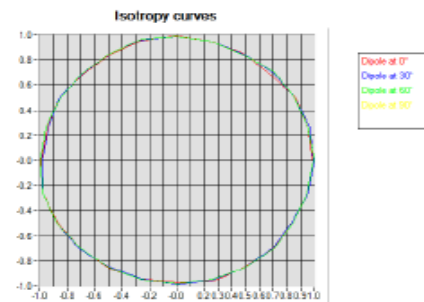



HL2450 MHz

- Axial isotropy: 0.09 dB
- Hemispherical isotropy: 0.14 dB

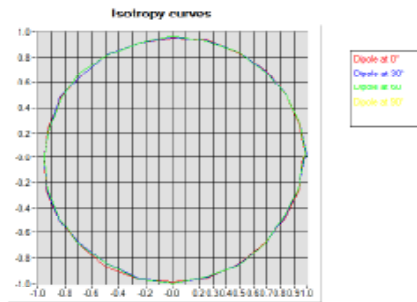



6 LIST OF EQUIPMENT

Equipment Summary Sheet				
Equipment Description	Manufacturer / Model	Identification No.	Current Calibration Date	Next Calibration Date
Flat Phantom	Satimo	SN-20/09-SAM71	Validated. No cal required.	Validated. No cal required.
COMOSAR Test Bench	Version 3	NA	Validated. No cal required.	Validated. No cal required.
Network Analyzer	Rhode & Schwarz ZVA	SN100132	02/2013	02/2016
Reference Probe	Satimo	EP 94 SN 37/08	Characterized prior to test. No cal required.	Characterized prior to test. No cal required.
Multimeter	Keithley 2000	1188656	11/2013	11/2016
Signal Generator	Agilent E4438C	MY49070581	12/2013	12/2016
Amplifier	Aethercomm	SN 046	Characterized prior to test. No cal required.	Characterized prior to test. No cal required.
Power Meter	HP E4418A	US38261498	11/2013	11/2016
Power Sensor	HP ECP-E26A	US3/181460	11/2013	11/2016
Directional Coupler	Narda 4216-20	01386	Characterized prior to test. No cal required.	Characterized prior to test. No cal required.
Waveguide	Mega Industries	069Y7-158-13-712	Validated. No cal required.	Validated. No cal required.
Waveguide Transition	Mega Industries	069Y7-158-13-701	Validated. No cal required.	Validated. No cal required.
Waveguide Termination	Mega Industries	069Y7-158-13-701	Validated. No cal required.	Validated. No cal required.
Temperature / Humidity Sensor	Control Company	11-661-9	3/2012	3/2014

APPENDIX E. DIPOLE CALIBRATION DATA



SAR Reference Dipole Calibration Report

Ref: ACR.318.4.13.SATU.A

**ATTESTATION OF GLOBAL COMPLIANCE CO.
LTD.**

**1&2F, NO.2 BUILDING, HUAFENG NO.1 INDUSTRIAL
PARK, GUSHU COMMUNITY XIXIANG STREET
BAOAN DISTRICT, SHENZHEN, P.R. CHINA
SATIMO COMOSAR REFERENCE DIPOLE**

FREQUENCY: 450 MHZ

SERIAL NO.: SN 46/11 DIP 0G450-184

**Calibrated at SATIMO US
2105 Barrett Park Dr. - Kennesaw, GA 30144**



11/14/13

Summary:

This document presents the method and results from an accredited SAR reference dipole calibration performed in SATIMO USA using the COMOSAR test bench. All calibration results are traceable to national metrology institutions.



SAR REFERENCE DIPOLE CALIBRATION REPORT

Ref. ACR.318.4.13.SATU.A

	<i>Name</i>	<i>Function</i>	<i>Date</i>	<i>Signature</i>
<i>Prepared by :</i>	Jérôme LUC	Product Manager	11/14/2013	<i>JS</i>
<i>Checked by :</i>	Jérôme LUC	Product Manager	11/14/2013	<i>JS</i>
<i>Approved by :</i>	Kim RUTKOWSKI	Quality Manager	11/14/2013	<i>Kim Rutkowski</i>

	<i>Customer Name</i>
<i>Distribution :</i>	ATTESTATION OF GLOBAL COMPLIANCE CO. LTD.

<i>Issue</i>	<i>Date</i>	<i>Modifications</i>
A	11/14/2013	Initial release



TABLE OF CONTENTS

1 Introduction..... 4

2 Device Under Test 4

3 Product Description 4

 3.1 General Information 4

4 Measurement Method 5

 4.1 Return Loss Requirements 5

 4.2 Mechanical Requirements 5

5 Measurement Uncertainty 5

 5.1 Return Loss 5

 5.2 Dimension Measurement 5

 5.3 Validation Measurement 5

6 Calibration Measurement Results 6

 6.1 Return Loss and Impedance 6

 6.2 Mechanical Dimensions 6

7 Validation measurement 7

 7.1 Measurement Condition 7

 7.2 Head Liquid Measurement 7

 7.3 Measurement Result 8

 7.4 Body Measurement Result 9

8 List of Equipment 10



1 INTRODUCTION

This document contains a summary of the requirements set forth by the IEEE 1528, OET 65 Bulletin C and CEI/IEC 62209 standards for reference dipoles used for SAR measurement system validations and the measurements that were performed to verify that the product complies with the fore mentioned standards.

2 DEVICE UNDER TEST

Device Under Test	
Device Type	COMOSAR 450 MHz REFERENCE DIPOLE
Manufacturer	Satimo
Model	SID450
Serial Number	SN 46/11 DIP 0G450-184
Product Condition (new / used)	Used

A yearly calibration interval is recommended.

3 PRODUCT DESCRIPTION

3.1 GENERAL INFORMATION

Satimo's COMOSAR Validation Dipoles are built in accordance to the IEEE 1528, OET 65 Bulletin C and CEI/IEC 62209 standards. The product is designed for use with the COMOSAR test bench only.



Figure 1 – Satimo COMOSAR Validation Dipole



4 MEASUREMENT METHOD

The IEEE 1528, OET 65 Bulletin C and CEI/IEC 62209 standards provide requirements for reference dipoles used for system validation measurements. The following measurements were performed to verify that the product complies with the fore mentioned standards.

4.1 RETURN LOSS REQUIREMENTS

The dipole used for SAR system validation measurements and checks must have a return loss of -20 dB or better. The return loss measurement shall be performed against a liquid filled flat phantom, with the phantom constructed as outlined in the fore mentioned standards.

4.2 MECHANICAL REQUIREMENTS

The IEEE Std. 1528 and CEI/IEC 62209 standards specify the mechanical components and dimensions of the validation dipoles, with the dimensions frequency and phantom shell thickness dependent. The COMOSAR test bench employs a 2 mm phantom shell thickness therefore the dipoles sold for use with the COMOSAR test bench comply with the requirements set forth for a 2 mm phantom shell thickness.

5 MEASUREMENT UNCERTAINTY

All uncertainties listed below represent an expanded uncertainty expressed at approximately the 95% confidence level using a coverage factor of k=2, traceable to the Internationally Accepted Guides to Measurement Uncertainty.

5.1 RETURN LOSS

The following uncertainties apply to the return loss measurement:

Frequency band	Expanded Uncertainty on Return Loss
400-6000MHz	0.1 dB

5.2 DIMENSION MEASUREMENT

The following uncertainties apply to the dimension measurements:

Length (mm)	Expanded Uncertainty on Length
3 - 300	0.05 mm

5.3 VALIDATION MEASUREMENT

The guidelines outlined in the IEEE 1528, OET 65 Bulletin C, CENELEC EN50361 and CEI/IEC 62209 standards were followed to generate the measurement uncertainty for validation measurements.

Scan Volume	Expanded Uncertainty
1 g	20.3 %
10 g	20.1 %



6 CALIBRATION MEASUREMENT RESULTS

6.1 RETURN LOSS AND IMPEDANCE

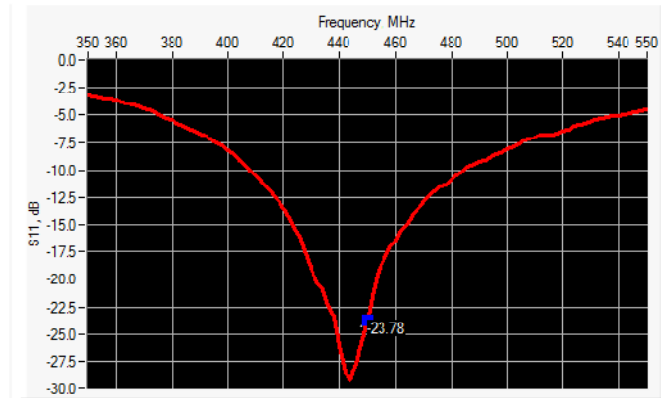

Frequency (MHz)	Return Loss (dB)	Requirement (dB)	Impedance
450	-23.78	-20	54.9 Ω + 5.1 jΩ

6.2 MECHANICAL DIMENSIONS

Frequency MHz	l mm		h mm		d mm	
	required	measured	required	measured	required	measured
300	420.0 ±1 %		250.0 ±1 %		6.35 ±1 %	
450	290.0 ±1 %	PASS	166.7 ±1 %	PASS	6.35 ±1 %	PASS
750	176.0 ±1 %		100.0 ±1 %		6.35 ±1 %	
835	167.0 ±1 %		89.8 ±1 %		3.6 ±1 %	
900	149.0 ±1 %		83.3 ±1 %		3.6 ±1 %	
1450	89.1 ±1 %		51.7 ±1 %		3.6 ±1 %	
1500	80.5 ±1 %		50.0 ±1 %		3.6 ±1 %	
1640	79.0 ±1 %		45.7 ±1 %		3.6 ±1 %	
1750	75.2 ±1 %		42.9 ±1 %		3.6 ±1 %	
1800	72.0 ±1 %		41.7 ±1 %		3.6 ±1 %	
1900	68.0 ±1 %		39.5 ±1 %		3.6 ±1 %	
1950	66.3 ±1 %		38.5 ±1 %		3.6 ±1 %	
2000	64.5 ±1 %		37.5 ±1 %		3.6 ±1 %	
2100	61.0 ±1 %		35.7 ±1 %		3.6 ±1 %	
2300	55.5 ±1 %		32.6 ±1 %		3.6 ±1 %	
2450	51.5 ±1 %		30.4 ±1 %		3.6 ±1 %	
2600	48.5 ±1 %		28.8 ±1 %		3.6 ±1 %	
3000	41.5 ±1 %		25.0 ±1 %		3.6 ±1 %	
3500	37.0 ±1 %		26.4 ±1 %		3.6 ±1 %	
3700	34.7 ±1 %		26.4 ±1 %		3.6 ±1 %	



7 VALIDATION MEASUREMENT

The IEEE Std. 1528, OET 65 Bulletin C and CEI/IEC 62209 standards state that the system validation measurements must be performed using a reference dipole meeting the fore mentioned return loss and mechanical dimension requirements. The validation measurement must be performed against a liquid filled flat phantom, with the phantom constructed as outlined in the fore mentioned standards. Per the standards, the dipole shall be positioned below the bottom of the phantom, with the dipole length centered and parallel to the longest dimension of the flat phantom, with the top surface of the dipole at the described distance from the bottom surface of the phantom.

7.1 MEASUREMENT CONDITION

Software	OPENSAR V4
Phantom	SN 20/09 SAM71
Probe	SN 18/11 EPG122
Liquid	Head Liquid Values: ϵ_p' : 42.5 σ : 0.86
Distance between dipole center and liquid	: 5.0 mm
Area scan resolution	$dx=8mm/dy=8mm$
Zoon Scan Resolution	$dx=8mm/dy=8mm/dz=5mm$
Frequency	450 MHz
Input power	20 dBm
Liquid Temperature	21 °C
Lab Temperature	21 °C
Lab Humidity	45 %

7.2 HEAD LIQUID MEASUREMENT

Frequency MHz	Relative permittivity (ϵ_r')		Conductivity (σ) S/m	
	required	measured	required	measured
300	45.3 ±5 %		0.87 ±5 %	
450	43.5 ±5 %	PASS	0.87 ±5 %	PASS
750	41.9 ±5 %		0.89 ±5 %	
835	41.5 ±5 %		0.90 ±5 %	
900	41.5 ±5 %		0.97 ±5 %	
1450	40.5 ±5 %		1.20 ±5 %	
1500	40.4 ±5 %		1.23 ±5 %	
1640	40.2 ±5 %		1.31 ±5 %	
1750	40.1 ±5 %		1.37 ±5 %	
1800	40.0 ±5 %		1.40 ±5 %	
1900	40.0 ±5 %		1.40 ±5 %	
1950	40.0 ±5 %		1.40 ±5 %	
2000	40.0 ±5 %		1.40 ±5 %	
2100	39.8 ±5 %		1.49 ±5 %	
2300	39.5 ±5 %		1.67 ±5 %	
2450	39.2 ±5 %		1.80 ±5 %	
2600	39.0 ±5 %		1.96 ±5 %	
3000	38.5 ±5 %		2.40 ±5 %	
3500	37.9 ±5 %		2.91 ±5 %	

Page: 7/10

This document shall not be reproduced, except in full or in part, without the written approval of SATIMO. The information contained herein is to be used only for the purpose for which it is submitted and is not to be released in whole or part without written approval of SATIMO.



7.3 MEASUREMENT RESULT

The IEEE Std. 1528 and CEI/EC 62209 standards state that the system validation measurements should produce the SAR values shown below (for phantom thickness of 2 mm), within the uncertainty for the system validation. All SAR values are normalized to 1 W forward power. In bracket, the measured SAR is given with the used input power.

Frequency MHz	1 g SAR (W/kg/W)		10 g SAR (W/kg/W)	
	required	measured	required	measured
300	2.85		1.94	
450	4.58	4.91 (0.49)	3.06	3.13 (0.31)
750	8.49		5.55	
835	9.56		6.22	
900	10.9		6.99	
1450	29		16	
1500	30.5		16.8	
1640	34.2		18.4	
1750	36.4		19.3	
1000	30.4		20.1	
1900	39.7		20.5	
1950	40.5		20.9	
2000	41.1		21.1	
2100	43.6		21.9	
2300	48.7		23.3	
2450	52.4		24	
2600	55.3		24.6	
3000	63.8		25.7	
3500	67.1		25	

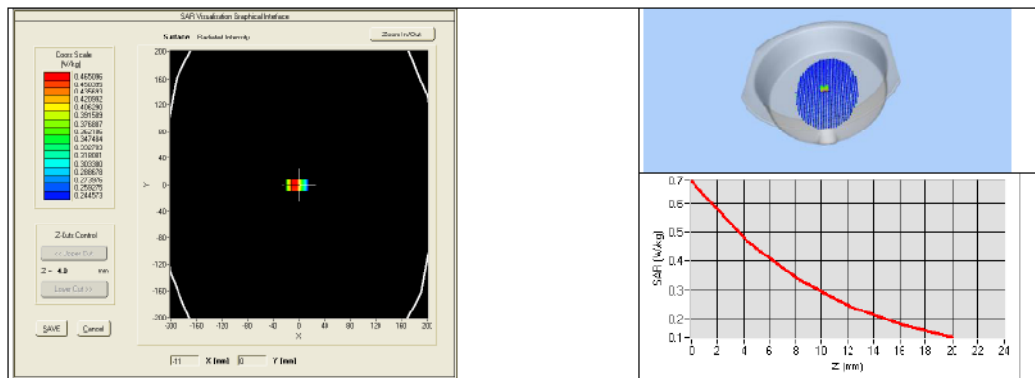



7.4 BODY MEASUREMENT RESULT

Software	OPENSAR V4
Phantom	SN 20/09 SAM71
Probe	SN : 8/11 EPG122
Liquid	Body Liquid Values: $\epsilon_p' : 57.6$ σ : 0.98
Distance between dipole center and liquid	15.0 mm
Area scan resolution	$dx=8mm/dy=8mm$
Zoon Scan Resolution	$dx=8mm/dy=8m/dz=5mm$
Frequency	450 MHz
Input power	20 dBm
Liquid Temperature	21 °C
Lab Temperature	21 °C
Lab Humidity	45 %

Frequency MHz	1 g SAR (W/kg/W)	10 g SAR (W/kg/W)
	measured	measured
450	5.07 (0.51)	3.25 (0.3E)

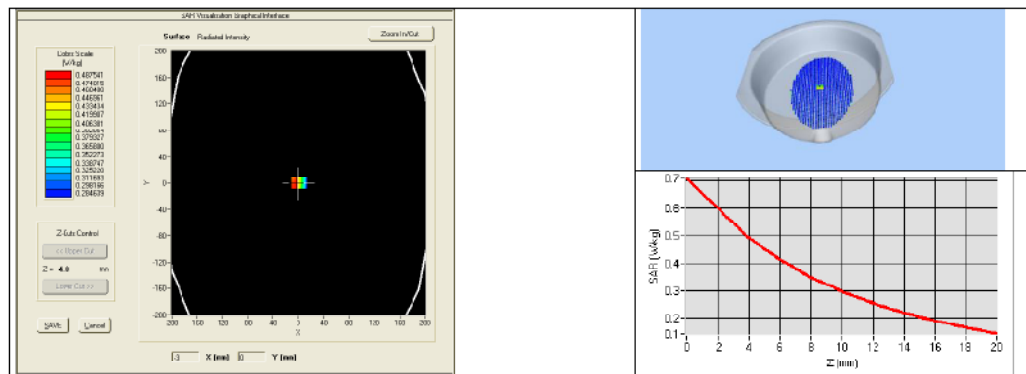



8 LIST OF EQUIPMENT

Equipment Summary Sheet				
Equipment Description	Manufacturer / Model	Identification No.	Current Calibration Date	Next Calibration Date
SAM Phantom	Satimo	SN-20/09-SAM71	Validated. No cal required.	Validated. No cal required.
COMOSAR Test Bench	Versicn 3	NA	Validated. No cal required.	Validated. No cal required.
Network Analyzer	Rhode & Schwarz ZVA	SN10C132	02/2013	02/2016
Calipers	Carrera	CALIPER-01	12/2010	12/2013
Reference Probe	Satimo	EPG122 SN 18/11	Characterized prior to test. No cal required.	Characterized prior to test. No cal required.
Multimeter	Keithley 2000	1188556	11/2010	11/2013
Signal Generator	Agilent E4438C	MY49070581	12/2010	12/2013
Amplifier	Aethercomm	SN 046	Characterized prior to test. No cal required.	Characterized prior to test. No cal required.
Power Meter	HP E4418A	US38261498	11/2010	11/2013
Power Sensor	HP ECP-E26A	US37181460	11/2010	11/2013
Directional Coupler	Narda 4216-20	01386	Characterized prior to test. No cal required.	Characterized prior to test. No cal required.
Temperature and Humidity Sensor	Control Company	11-661-9	3/2012	3/2014