

AnyTone[®]

Qixiang Electron Science & Technology Co., Ltd.
www.anytone.net

AnyTone[®]

AT-D278

**Digital DMR and Analog
Two Way Radio**

Operating Manual

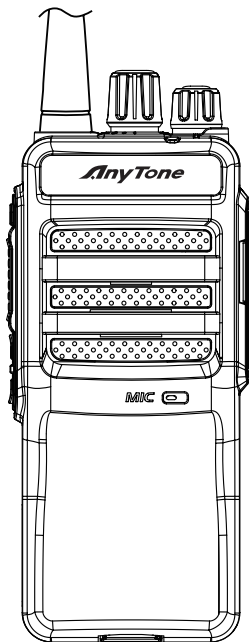

DMR
DIGITAL MOBILE RADIO ASSOCIATION

THANK YOU!

Thank you very much for choosing our *AnyTone* Digital DMR and Analog two way radio.

This radio adopts the latest advances in technology, providing reliable communication in today's demanding communication environment.

This radio offers both DMR digital and analog communication, introduces innovative DMR digital processing system to achieve high-audio quality and digital encryption. It offers great stability, and reliability, together with long distance communication as well as fashionable design and compact exterior lines. AT-D278 has Recording, Voice Message, Digital Encryption, Emergency Alarm, Man Down Alarm, Work Alone, Vibration, Analog DTMF, 2TONE, 5TONE, CTCSS/DCS encode/decode functions.



NOTE

» **When programming the radio, start by reading the factory software data, and then rewrite this data with your frequency etc., to a new saved code plug, otherwise errors may occur.**

» **You can use the programming cable with a PC to program the frequency, channel type, power etc. your programming must comply with your FCC (or other country) license certification.**

CONTENTS

1.UNPACKING AND CHECKING THE EQUIPMENT.....	1
1.1 Supplied Accessories.....	1
1.2 Standard Accessories	2
1.3 Optional Accessories	2
2.BATTERY INFORMATION	3
2.1 Charging the Battery Pack	3
2.2 Charger Supplied.....	3
2.3 Use Caution with the Li-ion Battery.....	3
2.4 How to Charge.....	4
2.5 Normal Charging Tips	5
2.6 How to Store the Battery.....	6
3. PREPARATION	7
3.1 Installing / Removing the Battery	7
3.2 Installing / Removing the Antenna	7
3.3 Installing / Removing the Belt Clip	8
3.4 Installing the Additional Speaker/Microphone (Optional).....	8
4. Radio Overview.....	9
4.1 Status Indications.....	10
5.BASIC OPERATIONS.....	11
5.1 Power on the Radio	11
5.2 Adjust Volume	11
5.3 Select a Zone.....	11
5.4 Select a Channel.....	11
5.5 Receiving and Responding to a Radio Call	11
5.6 Making a Call	11
5.7 Monitor	11
5.8 Emergency Alarm.....	12
5.9 Man Down Alarm.....	12
5.10 Battery Voltage Test	12
6. PROGRAMMABLE FUNCTIONS	13

7.RESET.....	17
8.TROUBLE SHOOTING GUIDE.....	18
9.ON-LINE SERVICE AND SUPPORT	19
SAFETY	20
EU DECLARATION OF CONFORMITY	22
10.TECHNICAL SPECIFICATIONS.....	23

1. UNPACKING AND CHECKING THE EQUIPMENT

Unpack the radio carefully. We recommend that you identify the items listed in the following table before discarding the packing materials. If any items are missing or have been damaged during shipment, please contact the carrier or the dealers immediately.

1.1 Supplied Accessories

Item	Number	Quantity
Antenna		1
Li-ion Battery Pack		1
Battery Charger		1
AC Adaptor		1
Belt Clip		1
Hand Strap		1
Instruction Manual		1

1. UNPACKING AND CHECKING THE EQUIPMENT

1.2 Standard Accessories

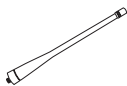

Antenna*1

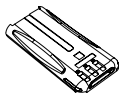

Li-ion Battery Pack
QB-55HL (2600mAh) or
QB-55L (1800mAh)



Charger
QBC-55L



AC Adaptor
QPS-17



Belt Clip
BC-05



Wrist strap



Instruction Manual

* **Note:** For frequency band of antenna, please refer to label indicated in the bottom of the antenna.

* **Note:** Car Charger and QBC-55L Charger should be used together.

1.3 Optional Accessories



Earphone
EJX-023



Li-ion Battery Pack
QB-55HL (2600mAh) or
QB-55L (1800mAh)

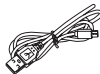

TYPE C program cable



Car Charger
CPL-01



Battery Eliminator
CPL-02

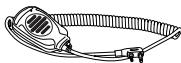

Speaker Microphone
QHM-024

2. BATTERY INFORMATION

2.1 Charging the Battery Pack

The Li-ion battery pack is not charged at the factory; please charge it before use.

Charging the battery pack for the first time after purchase or extended storage (more than 2 months) may not bring the battery pack to its normal maximum operating capacity. Best operation will require fully charging/discharging the battery two or three times before the operating capacity will reach its best performance. The battery pack life may be depleted when its operating time decreases even though it has been fully and correctly charged. If this is the case, replace the battery pack.

2.2 Charger Supplied

Please use the specified charger provided by AnyTone. Other models may cause explosion and personal injury. After installing the battery pack, and if the radio displays low battery with a red flashing lamp or voice prompt, please charge the battery.

2.3 Use Caution with the Li-ion Battery

- a. Do not short the battery terminals or throw the battery into a fire. Never attempt to remove the casing from the battery pack, as AnyTone cannot be held responsible for any accident caused by modifying the battery.
- b. The ambient temperature should be between 5°C-40°C (40°F - 105°F) while charging the battery. Charging outside this range may not fully charge the battery.
- c. Please turn off the radio before inserting it into the charger. It may otherwise interfere with correct charging.
- d. To avoid interfering with the charging cycle, please do not cut off the power or remove the battery during charging until the green light is on.
- e. Do not recharge the battery pack if it is fully charged. This may shorten the life of the battery pack or damage the battery pack.
- f. Do not charge the battery or the radio if it is damp. Dry it before charging to avoid damage.

2. BATTERY INFORMATION

WARNING:

» When keys, ornamental chain or other electric metals contact the battery terminal, the battery may become damage or injure a human. If the battery terminals are short circuited it will generate a lot of heat. Take care when carrying and using the battery. Remember to put the battery or radio into an insulated container. Do not put it into a metal container.

2.4 How to Charge

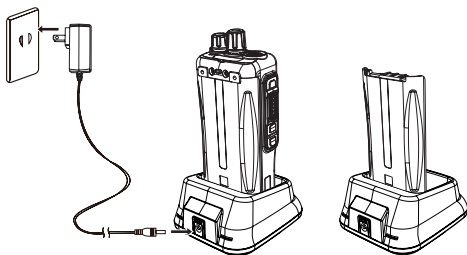

- Plug the AC adaptor into the AC outlet, and then plug the cable of the AC adaptor into the DC jack located on the back of the charger. The indicator light blinks orange and is then ready to charge a battery.
- Plug the battery or the radio into the charger. Make sure the battery terminals are good in contact with charging terminals. The indicator light turns to red--- charging begins.
- It takes approximately 2-5 hours to fully charge the battery. When the lamp lights green, the charging is completed. Remove the battery or the radio unit with its battery from socket



NOTE » when charging a radio (with battery) the indicating lamp will not turn into green to show the fully charged status if the radio is powered on. Only when the radio is switched off will the lamp indicate normal operation. The radio consumes energy when it is power-on, and the charger cannot detect the correct battery voltage when the battery has been fully charged. So the charger will charge the battery in constant voltage mode and fail to indicate correctly when the battery has been fully charged.

2. BATTERY INFORMATION

e. Charging Process

Charging Status	Indicator Status
Standby	 Red and green light flash alternately
Charging (Charge in a constant current)	 Lights red
Fully charged (Charge in a constant voltage)	 Lights green

f. LED Indicator:

STATUS	LED
No Battery	Red and green light flash alternately
Charge Normally	Red
Fully Charged	Green
Trouble	Red and green light flash alternately when put the battery on charger

 » **Trouble means battery too warm, battery short-circuited or charger short-circuited.**
NOTE

2.6 How to Store the Battery

- a. If the battery needs to be stored, keep it in status of 80% discharged.
- b. It should be kept in low temperature and dry environment.
- c. Keep it away from hot places and direct sunlight.

 » **Do not short circuit the battery terminals.**
NOTE
» **Never attempt to remove the casing from the battery pack.**
» **Never store the battery in unsafe surroundings, as a short may cause an explosion.**
» **Do not put the battery in a hot environment or throw it into a fire, as it may cause an explosion.**

3. PREPARATION

3.1 Installing / Removing the Battery

- a. Match the two bottom grooves of the battery pack with the corresponding guides on the back of the radio and then push it.
- b. To remove the battery pack, slide the release latch at the top away from the battery and remove the pack away from the transceiver.

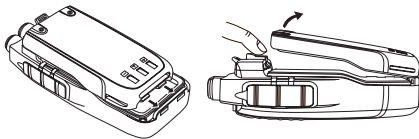

3.2 Installing / Removing the Antenna

- a. Installing the Antenna: Screw the antenna into the connector on the top of the transceiver by holding the antenna at its base and turning it clockwise until secure.
- b. Removing the Antenna: Turn the antenna counter-clockwise to remove it.

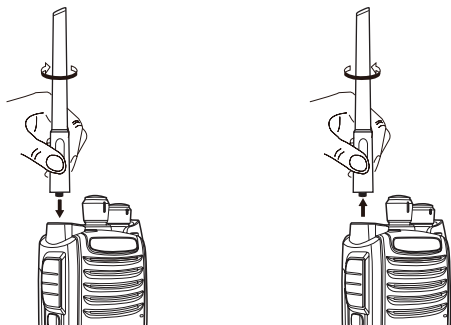

3. PREPARATION

3.3 Installing / Removing the Belt Clip

- a. Installing the Belt Clip: Place the belt clip above the corresponding holes on the back of the radio, and screw it into place clockwise with the two supplied screws.
- b. Removing the Belt Clip: Unscrew counter-clockwise to remove the belt clip.

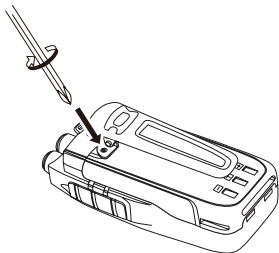

3.4 Installing the Additional Speaker/Microphone (Optional)

Pry open the rubber MIC-Headset jack cover and then insert the Speaker / Microphone plug into the double jack.

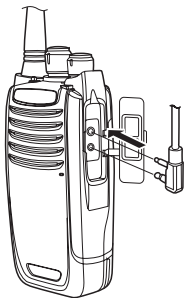

4. Getting Acquaint

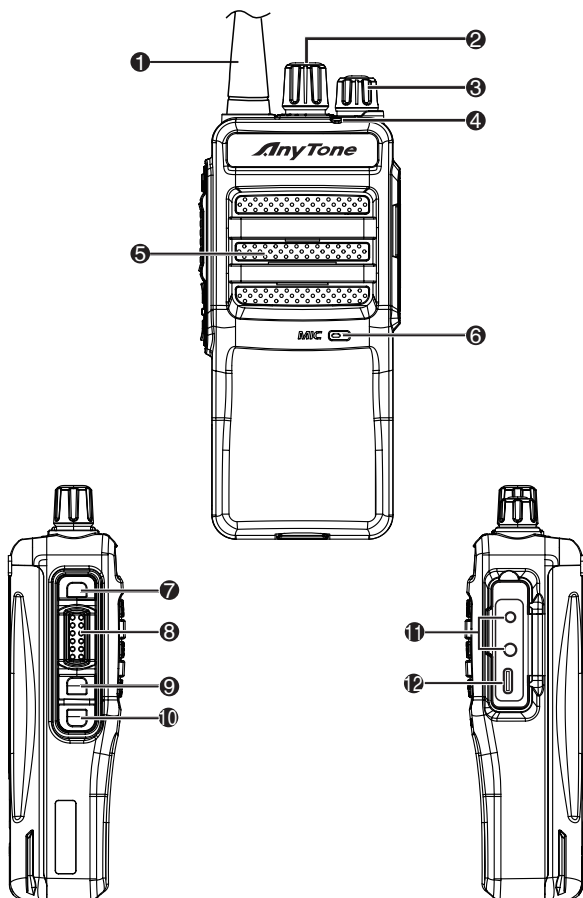

4. Getting Acquaint

- ① Antenna
- ② Channel Switch
- ③ Power/Volume switch
Turn the switch in clockwise direction to power on the walkie-talkie and increase the volume, and turn it counterclockwise to decrease the volume and finally power off the walkie-talkie.
- ④ Status indicator
Indicate the different status of walkie talkie
- ⑤ Speaker
- ⑥ MIC
Talk to MIC when make a call.
- ⑦ Emergency Alarm [PF3] button
Allows to assign the required function in PC software
- ⑧ [PTT] Button
Press and hold the button to make a call, release the button to receive a call.
- ⑨ [PF1] Button
Allows to assign the required function in PC software
- ⑩ [PF2] Button
Allows to assign the required function in PC software
- ⑪ Headset Jack (Kenwood type)
- ⑫ Type C Jack (Program use)

Status Indicator

- 1.Flash red light: Low battery voltage
- 2.Constant red light: Transmitting
- 3.Flash orange light: Scanning
- 4.Constant green light: Receiving with matched carrier
- 5.Constant blue light: Receiving with matched digital signal
- 6.Constant purple light: The programming data is saving to radio. DO NOT power off radio.
- 7.Orange light: Power ON indicator

5. BASIC OPERATIONS

5.1 Power on the Radio

Turn on the radio by turning the [Power/Volume] switch clockwise till a click is heard, and the orange LED light up, and you will hear a beep and the voice prompt for channel number and channel type.

5.2 Adjust Volume

Rotate the [Power/Volume] knob to adjust the volume. Turn clockwise to increase the volume and counterclockwise to decrease the volume.

5.3 Select a Zone

Assign a key to Zone Switch function in CPS, press the key to select the zone.

5.4 Select a Channel

Turn the channel switch to select a channel.

5.5 Receiving and Responding to a Radio Call

When the radio is in the digital mode, it can receive and respond to a call with the same frequency/color code/ slot. When receiving a call:

- a. If the radio is programmed with Call Alert in CPS-Optional Setting-Alert Tone, when receiving a call, the radio will ring briefly.
- b. The blue LED lights up.
- c. When the call is ended, you can press [PTT] to respond the call.

5.6 Making a Call

Turn the channel switch to choose a programmed channel.

Hold the radio vertical 2.5-5cm from your mouth, press the [PTT] key to start the call, the red LED lights up, if the radio is programmed with "talk permit", the radio will ring briefly, later you can start the talk.

Release [PTT] key to receive the reply.

5.7 Monitor

In standby, press the [PF2] key to enter Monitor. When receiving matched carrier but the signaling / ID is unmatched or the signal is too weak, this function allows monitor the weak signal and signal with unmatched ID.

Press the [PF2] key again to shut off speaker and return to standby.



» **When in analog mode, if no signal, it will emit noise when press the Monitor Key.**

5. BASIC OPERATIONS

5.8 Emergency Alarm

Press top PF3 key to enable alarm function, then press this key again to exit alarm.

5.9 Man Down Alarm

In CPS - Public - Alarm Setting, check on the "Man Down" alarm box, it will enable the Man Down Alarm function.

When the function is on, the radio will start an alarm if the radio is falling to the ground. Raise the radio to stop the alarm.

Note: When GPS is on and positioning successfully, it will auto send out the GPS information when the radio starts the alarm.

5.10 Battery Voltage Test

Press the key programmed as Voltage function to check the current battery voltage, press this key again to return.

6. PROGRAMMABLE FUNCTIONS

Top PF3 key, PF1 and PF2 key are programmable in CPS, it allows you assign the key as short, Long1 or Long2 function.

1)Short : Press the programmed key to activate the assigned function.

2)Long 1: Hold pressing the programmed key until the radio emits “Du” beep, release the key to activate the assigned function

3)Long 2: Hold pressing the programmed key, do not release the key even when the radio emits “Du” beep, the radio will activate the assigned function.

Please refer to below assigned functions for the programmable key.

(1) Voltage

Check the current battery capacity voltage.

(2) Power Switch

Switch the power between super high, high, middle and low power.

(3) Repeater

Switch between Talk Around and Repeater mode. Talk around function will make the radio disconnect with repeater, two radios can communicate directly without repeater.

(4) Reverse

Turn on/off the frequency reverse function. Reverse function is only valid in analog channel, the RX/TX frequency and CTCSS/DCS encode/decode will exchange when turn on Reverse function.

(5) Digital Encryption

Press the programmed key, radio will pronounce with turn on the Digital Encryption or the digital encryption group. Repeat press the key to choose the digital encryption group or turn off the function.

This function is only valid in digital channel.

(6) Call1, Call2, Call3

In Analog mode, press the programmed key to send the DTMF/5TONE/2TONE/MDC1200 encode set in the analog channel. Each analog channel allows setting call1/call2/call3 for DTMF/5TONE/2TONE/MDC1200. This function is only valid for analog channel.

(7) VOX Level

Set up the VOX level, radio will pronounce the vox level.

VOX function will allow the user start the TX by voice instead of pressing PTT.

6. PROGRAMMABLE FUNCTIONS

(8) Scan

Enable/disable the scan function.

(9) Emergency Alarm

Press the programmed key to start or exit the emergency alarm. Emergency alarm should be set up in CPS-Public-Alarm Setting first.

(10) Record Switch

Enable/disable the recording function.

The radio is with standard 30hours recording for RX/TX communication in digital mode.

Also it has optional 500hours or 1000hours digital/analog recording, please contact with your dealers for the options..

(11) Monitor

Monitor the weak signal or the signal with unmatched ID.

If you use this function in analog channel, the radio will emit the background noise.

(12) Send Alarm

In digital channel, press the programmed "Send Alarm" key, the radio will pronounce "alarm" and the number, repeat press the key, the number will change between 1-5. Press PTT key to send out the selected alarm in current channel.

This function is only valid in digital channel.

(13) Hot Key 1-6

Press the programmed hot key to activate the assigned function. Hot key should be set up in CPS-Public-Hot key first.

(14) Work Alone

Turn on/off the work alone function. When work alone function is turned on, the radio will start alarm when the response time is reached. Press any key or voice transmit will shut off the alarm.

Work Alone function should be set in CPS-Public-Alarm setting first.

(15) Phrase Record

In digital channel, press the programmed "phrase record" key, the radio will pronounce "record" and the number, repeat press the key, the number will change between 1-25.

Stay at the selected number, press PTT to talk and start recording, release PTT to end recording.

It will allow you make 25records.

6. PROGRAMMABLE FUNCTIONS

This function is only valid in digital channel.

(16) Phrase Playback/Delete

In digital channel, press the programmed “Phrase Playback/Delete” key, the radio pronounce “Record playback” and the number. Radio will start at the number with recording, it will pronounce the recording.

Press PTT key to transmit the recording at current channel.

Hold pressing PTT key to delete the recording.

This function is only valid in digital channel.

(17) RX&TX Record Replay

Press the programmed “RX&TX Record Replay” key, the radio will pronounce the last TX or RX recording.

The radio is with standard 30hours recording for RX/TX communication in digital mode.

Also it has optional 500hours or 1000hours digital/analog recording, please contact with your dealers for the options.

(18) Next Zone/ Prev Zone

Press the programmed key to switch the zone.

Maximum 16zones, each zone with maximum 16channels.

(19) Mic Level

Allow to switch the microphone gain level, total 5levels for optional.

(20) Mic Quality

Allow to adjust the sound to high pitch or low pitch, the RX radio will hear better sound.

This function is only valid in digital channel.

(21) Scene Mode

When radio is receiving, press the programmed “scene Mode” key to get best sound quality.

This function is only valid in digital channel.

(22) GPS Report

Press the programmed key to turn on or turn off the GPS function.

This function is only valid in digital channel.

(23) Status Info Report

Press the programmed key to turn on/off the function. The status information will be transmitted when the function is on.

This function is only valid in digital channel.

6. PROGRAMMABLE FUNCTIONS

(24) Record Report

Press the programmed key to turn on/off the function. The phrase record will be transmitted when the function is on.

This function is only valid in digital channel.

(25) BT On_Off

Press the programmed key to turn on/off the bluetooth function. Bluetooth is an optional function requires additional parts on the circuit, please consult with sales before the purchase.

(26) BT Match

Press the programmed key to pair the bluetooth with BT headset. Bluetooth is an optional function requires additional parts on the circuit, please consult with sales before the purchase.

(27) BT PTT Match

Press the programmed key to pair the bluetooth with BP02 BT PTT button. Bluetooth is an optional function requires additional parts on the circuit, please consult with sales before the purchase.

(28) Auto Repeater Check

Press the programmed "auto repeater check" key to turn on/off the function. Turn on this function will allow the radio to check the repeater status, it will broadcast "Repeater is out of range" if the repeater is not in range.

(29) Roaming

In standby, press the key programmed as "Roaming" to search and lock on the repeater with strongest signal. (Note: After lock on a repeater, the radio will return to last frequency only after channel or frequency is changed. The repeater frequency list must be preprogrammed in CPS.)

(30) NR Level

Press the programmed "NR Level" key to switch the noise reduction level. Noise reduction is an optional function requires additional parts on the circuit, please consult with sales before the purchase.

(31) PF_APRS_SEND

Press the programmed "PF_APRS_SEND" key to send the GPS location to aprs.fi, GPS is an optional function requires additional parts on the circuit, please consult with sales before the purchase.

7. RESET

- a.** Power off the radio first.
- b.** Then power it on while holding the [PTT] and the [PF1] button below the PTT at the same time.
- c.** Release the keys until the indicator lights blue color.
- d.** The reset is done when radio finish reboot.

8. TROUBLE SHOOTING GUIDE

Problems	Solutions
The radio cannot be switched on or no display after being switched on.	<p>A. Battery pack may not be installed properly. Remove the battery pack and install it again.</p> <p>B. Battery power may be insufficient. Recharge or replace the battery pack.</p>
The battery doesn't last very long after charging.	The battery is defective; please replace it with a new battery pack.
Cannot talk to or hear other members in your group.	<ol style="list-style-type: none">1. Make sure the frequency and CTCSS are the same as other members.2. Make sure you are within range, and not too far away from your member.3. Make sure you are set in correct digital mode, and frequency.4. In digital mode, make sure set correct code and encrypt group is used in current channel.5. In digital mode, make sure set correct receiving contacts and receiving group is used.
Other voices from non-group members are heard on the channel.	Analog: Change the CTCSS/DCS Tone, and make sure to change the tone on all radios in your group.

9. ON-LINE SERVICE AND SUPPORT

The Anytone website provides additional information about obtaining service or support for the Anytone line of two-way radios and accessories. Visit: www.anytone.net

Warning Notes

Every effort has been made to ensure that the information in this document is complete, accurate, and up to-date. Anytone Radio assumes no responsibility for the results of errors beyond its control. The manufacturer of this equipment also cannot guarantee that changes in the equipment made by non-authorized users will not affect the information in it.

FCC Licensing Information

This Anytone radio operates on Commercial / Land Mobile frequencies which require a license from the Federal Communications Commission (FCC) for business, personal, education and recreational use. To obtain forms, call the FCC forms hotline at: 1-800-418-3676 or go to <http://www.fcc.gov>

For questions concerning commercial licensing, contact the FCC at 1-888-CALL-FCC (1-888-225-5322).

SAFETY

The Anytone AT-D278 DMR handheld transceiver has been carefully designed to provide you with years of safe, reliable operation. As with all electrical equipment, however, there are a few basic precautions you should take to avoid hurting yourself or damaging the radio:

- Read the instructions in this handbook carefully. Be sure to save it for future reference.
- Read and follow all warning and instruction labels on the radio and owner's manual.
- Do not carry the transceiver by the antenna. This may damage the antenna or antenna terminal. Grasp the handheld by its base (not the antenna) when you need to place or remove it.
- Do not keep the radio with the antenna very close to, or touching exposed parts of the body, while transmitting. Anytone radios will perform best, if you speak 2-4 inches away from the microphone and the radio is vertical.
- Be sure the "PTT" key is not pressed when you do not need to transmit.
- Do not operate the radio near unshielded electrical blasting caps or in an explosive atmosphere.
- Do not transmit without the antenna fitted on the radio. Though it is provided with a protection, it may damage the TX output final stage.
- Respect the environment conditions. The radio is designed to be used in heavy environments, however avoid exposing it to extremely hot or cold temperature (out of the range between -20°C to $+55^{\circ}\text{C}$). Do not expose the transceiver to excessive vibrations as well as dusty or rainy locations.
- Never try to disassemble or service the radio by yourself (aside from the routine maintenance described in this handbook). It may cause damage to the radio transceiver and void your warranty requiring extensive repair work. Always contact your local dealer for assistance.
- Use only authorized accessories. Using non Anytone radio brand accessories may seriously damage your handheld transceiver and void your warranty.
- Do not spill liquid of any kind into your radio. If the transceiver gets wet, immediately dry it by a soft and clean cloth.
- Switch the radio off before you clean it. Follow the directions described in the paragraph "Care and maintenance".

SAFETY

- Handle the battery properly. Never place the LI-ion battery in your pocket or purse with loose coins. This could result in short circuiting the battery.
- Be certain that your power source matches the rating listed for the supplied battery charger (AC adapter). If you are not sure, check with your authorized Anytone dealer.
- Avoid damaging the power cable of the battery charger. Do not step on or place anything on it as this could result in a damaged charger power cord. This product complies with the requirements of the Council Directives 89/336/EEC and 73/23/EEC on the approximation of the laws of the member states relating to electromagnetic compatibility and low voltage.

WARNING

Your wireless hand-held portable transceiver contains a low power transmitter. When the Push-to-Talk (PTT) button is pressed it sends out radio frequency (RF) signals. The device is authorized to operate at a duty factor not to exceed 50% TX and 50% RX.

In August 1996, the Federal Communications Commission (FCC) adopted RF exposure guidelines with safety levels for hand-held wireless devices. To maintain compliance with the FCC's RF exposure guidelines, this transmitter and its antenna must maintain a separation distance of least 2 inches from your face. Speak in a normal voice, with the antenna pointed up and away from the face at the required separation distance. The belt clip is for storage purposes only.

AVOID TRANSMITTING ON HIGH POWER WHILE RADIO IS ATTACHED TO YOUR BELT. To transmit, hold the device away from your body and ensure the antenna is at least 2 inches from your body when transmitting.

EU DECLARATION OF CONFORMITY

In accordance with EU Directives and Regulations, the undersigned hereby declare that the following equipment is in conformity with the essential requirements of the RE Directive 2014/53/EU.

1. INFORMATION ON THE EQUIPMENT

Product:	Digital DMR and Analog UHF Two Way Radio
Model Name:	AT-D278

2. INFORMATION ON THE MANUFACTURER

Manufacturer:	Qixiang Electron Science & Technology Co., Ltd.
Address:	Qixiang Building, Tangxi Industrial Zone, Luojiang District, Quanzhou, Fujian, China
Name:	Ken XU (General Manager)
Tel:	+86 595 22656926
Mail:	ken6833@qxdz.cn

3. INFORMATION ON THE STANDARDS

RF	EN 300 086 V2.1.2(2016-08) EN 300 219 V2.1.1(2016-08) EN 300 113 V3.1.1(2020-06) EN 300 328 V2.2.2(2019-07)
EMC	EN 301 489-1 V2.2.3:2019-11 EN 301 489-5 V2.2.1:2019-04 EN 301 489-17 V3.2.4:2020-09
LVD/Safety	EN IEC62368-1:2020+A11:2020
SAR	EN62209-2:2010 EN50566:2017 EN50663:2017 EN62479:2010

The notified body MiCOM Labs Inc., (EU Identification Number: 2280) performed a conformity assessment according to Annex III, Module B. Signed on behalf of Qixiang Electron Science & Technology Co., Ltd.

Signature: 

Date: 2023-Nov-27

10. TECHNICAL SPECIFICATIONS

General	
Frequency Range	400-480MHz (UHF)
Channel Capacity	4000 channels
Channel Spacing	12.5KHz
Phase-locked Step	5KHz, 6.25KHz
Operating Voltage	7.4V DC \pm 20%
Frequency Stability	\pm 2.5ppm
Operating Temperature	-20 $^{\circ}$ C ~ +55 $^{\circ}$ C
Size	60 \times 40 \times 142mm (with battery pack)
Weight	282g (with battery pack, antenna)
Receiver	
Sensitivity(12dB SINAD)	\leq 0.35 μ V
Digital Sensitivity	0.3uV/-117.4dBm (BER 5%) 0.7uV/-110dBm (BER 1%)
Adjacent Channel Selectivity	\geq 60dB
Spurious Emission	\leq -57dB
Spurious Rejection	\geq 70dB
Blocking	84db
Hum & Noise	\geq 40dB
Audio Distortion	\leq 5%
Audio Power Output	1000mW/16 Ω
Transmitter	
Power Output	5/1W
Modulation	\pm 2.5KHz@12.5KHz
Adjacent Channel Power	\geq 60dB
Hum & Noise	\geq 36dB
Spurious Emission	\leq -36dBm
4FSK Digital Modulation	12.5KHz (data) 12.5KHz (data+voice)
Audio Distortion	\leq 5%
Error rate	\leq 3%

BT Transmitter	
Frequency	2402-2480MHz
Power Output	BR/EDR 6.112 dBm , Ble 4.526dBm

European Users should note that operation of this unit in Transmit mode requires the operator to have a valid Amateur Radio Licence from their respective Countries Amateur Radio Licencing Authority for the Frequencies and Transmitter Power levels that this Radio transmits on. Failure to comply may be unlawful and liable for prosecution. *At this subject, refer to the "EU" specification guide 2014/53/EU.*

Disposal of your Electronic and Electric Equipment

Products with the symbol (crossed-out wheeled bin) cannot be disposed as household waste. Electronic and Electric Equipment should be recycled at a facility capable of handling these items and their waste by products.

In EU countries, please contact your local equipment supplier representative or service center for information about the waste collection system in your country.



Attention in case of use

This transceiver works on frequencies which are not generally permitted. As for the actual usage, the user has to possess an amateur radio licence. Usage is allowed only in the frequency bands which are allocated for amateur radios.

List of national codes					
AT	BE	BG	CY	CZ	DE
DK	ES	EE	FI	FR	GB
GR	HR	HU	IE	IT	LT
LU	LV	MT	NL	PL	PT
RO	SK	SI	SE	CH	IS
LI	NO	-	-	-	-

FCC Compliance Statements:

This device complies with part 15 of the FCC Rules.

Operation is subject to the following two conditions:

- (1) This device may not cause harmful interference, and
- (2) this device must accept any interference received, including interference that may cause undesired operation.

Changes or modifications not expressly approved by the party responsible for compliance could void the user's authority to operate the equipment.

Note: This equipment has been tested and found to comply with the limits for a Class B digital device, pursuant to part 15 of the FCC Rules. These limits are designed to provide reasonable protection against harmful interference in a residential installation. This equipment generates, uses and can radiate radio frequency energy and, if not installed and used in accordance with the instructions, may cause harmful interference to radio communications. However, there is no guarantee that interference will not occur in a particular installation. If this equipment does cause harmful interference to radio or television reception, which can be determined by turning the equipment off and on, the user is encouraged to try to correct the interference by one or more of the following measures:

- Reorient or relocate the receiving antenna.
- Increase the separation between the equipment and receiver.
- Connect the equipment into an outlet on a circuit different from that to which the receiver is connected.
- Consult the dealer or an experienced radio/TV technician for help.

Licensing Information

Use our radio in USA is subject to the rules & regulations of FCC. Changes or modifications not expressly approved by our may void the user authority granted by the FCC to operate this radio and should not be made. To comply with FCC requirements, transmitter adjustments should be made only by or under the supervision of a person certified as technically qualified to perform transmitter maintenance and repairs in the private land mobile and fixed services as certified by an organization representative of the user of those services. Replacement of any transmitter component (crystal, semiconductor, etc) not authorized by the FCC equipment authorization for this radio could violate FCC rules.

Note: Use of this radio outside the country where it was intended to be distributed is subject to government regulations and may be prohibited.

Important: Any changes or modifications not expressly approved by the party responsible for compliance could void the user's authority to operate this device.

Your radio is set up to transmit a regulated signal on an assigned frequency. It is against the law to alter or adjust the settings inside the radio to exceed those limitations. Any adjustments to your radio must be made by qualified technicians.

Our radio generates RF electromagnetic energy during transmit mode. This radio is designed for and classified as "Occupational Use Only", meaning it must be used only during the course of employment by individuals aware of the hazards, and the ways to minimize such hazards.

This radio is NOT intended for use by the "General Population" in an uncontrolled environment. This radio has been tested and complies with the FCC RF exposure limits for "Occupational Use Only".

In addition, our radio complies with the following Standards and Guidelines with regard to RF energy and electromagnetic energy levels and evaluation of such levels for exposure to humans:

---IEEE Std. 1528:2013 and KDB447498, Evaluating Compliance with FCC Guidelines for Human Exposure to Radio Frequency Electromagnetic Fields.

---American National Standards Institute (C95.1-1992), IEEE Standard for Safety Levels with Respect to Human Exposure to Radio Frequency Electromagnetic Fields, 3 kHz to 300 GHz.

---American National Standards Institute (C95.3-1992), IEEE Recommended Practice for the Measurement of Potentially Hazardous Electromagnetic Fields- RF and Microwave.

The information listed above provides the user with the information needed to make him or her aware of RF exposure, and what to do to assure that this radio operates within the FCC RF exposure limits of this radio.

Electromagnetic Interference/Compatibility

During transmissions, the radio generates RF energy that can possibly cause interference with other devices or systems. To avoid such interference, turn off the radio in areas where signs are posted to do so. DO NOT operate the transmitter in areas that are sensitive to electromagnetic radiation such as hospitals, aircraft, and blasting sites.

Occupational/Controlled Use

The radio transmitter is used in situations in which persons are exposed as a consequence of their employment provided those persons are fully aware of the potential for exposure and can exercise control over their exposure.

WARNING: MODIFICATION OF THIS DEVICE TO RECEIVE CELLULAR RADIOTELEPHONE SERVICE SIGNALS IS PROHIBITED UNDER FCC RULES AND FEDERAL LAW.