

## SAR EVALUATION REPORT

For

### Qixiang Electron Science & Technology Co., Ltd.

Qixiang Building, Tangxi Industrial Zone, Luojiang District, Quanzhou, Fujian, China

**FCC ID: T4K-8RSERIES**

<b>Report Type:</b> Original report	<b>Product Type:</b> FM HANDHELD TRANSCEIVER
<b>Test Engineer:</b> <u>Wilson Chen</u>	<i>Wilson Chen</i>
<b>Report Number:</b> <u>RSZ150204003-20</u>	
<b>Report Date:</b> <u>2015-02-11</u>	
<b>Reviewed By:</b> <u>SAR Engineer</u>	<i>Bell Hu</i>
<b>Prepared By:</b> Bay Area Compliance Laboratories Corp. (Shenzhen) 6/F, the 3rd Phase of WanLi Industrial Building, ShiHua Road, FuTian Free Trade Zone Shenzhen, Guangdong, China Tel: +86-755-33320018 Fax: +86-755-33320008 <a href="http://www.baclcorp.com.cn">www.baclcorp.com.cn</a>	

**Note:** This test report is prepared for the customer shown above and for the device described herein. It may not be duplicated or used in part without prior written consent from Bay Area Compliance Laboratories Corp.

Attestation of Test Results				
<b>EUT Information</b>		<b>Company Name</b>	Qixiang Electron Science & Technology Co., Ltd.	
		<b>EUT Description</b>	DUAL BAND FM TRANSCEIVER	
		<b>FCC ID</b>	T4K-8RSERIES	
		<b>Model Number</b>	Main test Model: TERMN-8R, Adding Model: OBLTR-8R	
		<b>Test Date</b>	2015-02-07	
Frequency (MHz)	Modulation	Max. SAR Level(s) Reported (1g)		Limit (W/Kg)
151.82-154.6	FM (MURS)	12.5kHz	Face up: 0.056 W/kg ( <i>corrected by Multiplying 50%.</i> ) Body-Back: 0.095 W/kg ( <i>corrected by Multiplying 50%.</i> )	1.6
		25kHz	Face up: 0.061 W/kg ( <i>corrected by Multiplying 50%.</i> ) Body-Back: 0.109 W/kg ( <i>corrected by Multiplying 50%.</i> )	
<b>Applicable Standards</b>		<b>ANSI / IEEE C95.1: 2005</b> IEEE Standard for Safety Levels with Respect to Human Exposure to Radio Frequency Electromagnetic Fields, 3 kHz to 300 GHz.		
		<b>ANSI / IEEE C95.3: 2002</b> IEEE Recommended Practice for Measurements and Computations of Radio Frequency Electromagnetic Fields With Respect to Human Exposure to Such Fields, 100 kHz—300 GHz.		
		<b>IEEE 1528:2013</b> IEEE Recommended Practice for Determining the Peak Spatial-Average Specific Absorption Rate (SAR) in the Human Head from Wireless Communications Devices: Measurement Techniques		
		<b>KDB procedures</b> KDB 447498 D01 v05r02: Mobile and Portable Devices RF Exposure Procedures and Equipment Authorization Policies. KDB 865664 D01v01r03: SAR measurement 100 MHz to 6 GHz v01. KDB 643646D01 v01r01: SAR test Reduction Considerations for Occupational PTT Radios. KDB Inquiry: Tracking Number 316436 for SAR VHF system validation.		
<p><b>Note:</b> This wireless device has been shown to be capable of compliance for localized specific absorption rate (SAR) for General Population/Uncontrolled Exposure limits specified in ANSI/IEEE Standards and has been tested in accordance with the measurement procedures specified in IEEE 1528-2013 and RF exposure KDB procedures.</p> <p><b>The results and statements contained in this report pertain only to the device(s) evaluated.</b></p>				

## TABLE OF CONTENTS

<b>DOCUMENT REVISION HISTORY .....</b>	<b>4</b>
<b>EUT DESCRIPTION .....</b>	<b>5</b>
TECHNICAL SPECIFICATION .....	5
<b>REFERENCE, STANDARDS, AND GUIDELINES .....</b>	<b>6</b>
SAR LIMITS .....	7
<b>FACILITIES .....</b>	<b>8</b>
<b>DESCRIPTION OF TEST SYSTEM .....</b>	<b>9</b>
<b>EQUIPMENT LIST AND CALIBRATION .....</b>	<b>16</b>
EQUIPMENTS LIST & CALIBRATION INFORMATION .....	16
<b>SAR MEASUREMENT SYSTEM VERIFICATION .....</b>	<b>17</b>
LIQUID VERIFICATION .....	17
SYSTEM ACCURACY VERIFICATION .....	19
SAR SYSTEM VALIDATION DATA .....	20
<b>EUT TEST STRATEGY AND METHODOLOGY .....</b>	<b>24</b>
TEST POSITIONS FOR DEVICE OPERATING NEXT TO A PERSON’S EAR .....	24
CHEEK/TOUCH POSITION .....	25
EAR/TILT POSITION .....	25
TEST POSITIONS FOR BODY-WORN AND OTHER CONFIGURATIONS .....	26
SAR EVALUATION PROCEDURE .....	27
TEST METHODOLOGY .....	27
<b>CONDUCTED OUTPUT POWER MEASUREMENT .....</b>	<b>28</b>
PROVISION APPLICABLE .....	28
TEST PROCEDURE .....	28
MAXIMUM OUTPUT POWER AMONG PRODUCTION UNITS .....	28
TEST RESULTS: .....	28
<b>SAR MEASUREMENT RESULTS .....</b>	<b>29</b>
SAR TEST DATA .....	29
TEST RESULT: .....	29
SAR PLOTS (SUMMARY OF THE HIGHEST SAR VALUES) .....	30
<b>APPENDIX A – MEASUREMENT UNCERTAINTY .....</b>	<b>34</b>
<b>APPENDIX B – PROBE CALIBRATION CERTIFICATES .....</b>	<b>35</b>
<b>APPENDIX C – DIPOLE CALIBRATION CERTIFICATES .....</b>	<b>46</b>
<b>APPENDIX D – EUT TEST POSITION PHOTOS .....</b>	<b>54</b>
LIQUID DEPTH ≥ 15CM .....	54
FACE-UP 2.5 CM SEPARATION TO FLAT PHANTOM SETUP PHOTO .....	54
BODY-BACK 0.0 CM SEPARATION TO FLAT PHANTOM SETUP PHOTO .....	55
<b>APPENDIX E – EUT PHOTOS .....</b>	<b>56</b>
EUT – FRONT VIEW .....	56
EUT – BACK VIEW .....	56
EUT – LEFT VIEW .....	57
EUT – RIGHT VIEW .....	57
EUT – TOP VIEW .....	58
EUT – BOTTOM VIEW .....	58
EUT – UNCOVERED VIEW .....	59
BATTERY VIEW .....	59
EUT – ANTENNA .....	60
EUT – BELT CLIP .....	60
<b>APPENDIX F – INFORMATIVE REFERENCES .....</b>	<b>61</b>

---

## DOCUMENT REVISION HISTORY

---

Revision Number	Report Number	Description of Revision	Date of Revision
0	RSZ150204003-20	Original Report	2015-02-11

## EUT DESCRIPTION

This report has been prepared on behalf of Qixiang Electron Science & Technology Co., Ltd. and their product and their product, FCC ID: T4K-8RSERIES, Model: TERMN-8R or the EUT (Equipment Under Test) as referred to in the rest of this report. The EUT is a DUAL BAND FM TRANSCEIVER.

**\*Note:** This series products model: TERMN-8R and OBLTR-8R, we select model: TERMN-8R to test, there is no electrical change has been made to the equipment, please refer to the product similarity letter.

### Technical Specification

<b>Product Type</b>	Portable
<b>Exposure Category:</b>	Population / Uncontrolled
<b>Antenna Type(s):</b>	External Antenna
<b>Body-Worn Accessories:</b>	Belt Clip and Headset Cable
<b>Face-Head Accessories:</b>	None
<b>Operation Mode :</b>	MURS
<b>Modulation Type:</b>	FM
<b>Frequency Band:</b>	151.820MHz-154.600MHz
<b>Conducted RF Power:</b>	32.76dBm
<b>Dimensions (L*W*H):</b>	105mm (L)×65mm (W)×40mm (H)
<b>Power Source:</b>	7.4V Rechargeable Li-ION Battery
<b>Normal Operation:</b>	Face Up and Body-worn

---

## REFERENCE, STANDARDS, AND GUIDELINES

---

### **FCC:**

The Report and Order requires routine SAR evaluation prior to equipment authorization of portable transmitter devices, including portable telephones. For consumer products, the applicable limit is 1.6 mW/g as recommended by the ANSI/IEEE standard C95.1-1992 [6] for an uncontrolled environment (Paragraph 65). According to 447498 D03 Supplement C Cross-Reference "Evaluating Compliance with FCC Guide-lines for Human Exposure to Radio frequency Electromagnetic Fields", released on Jun 29, 2001 by the FCC, the device should be evaluated at maximum output power (radiated from the antenna) under "worst-case" conditions for normal or intended use, incorporating normal antenna operating positions, device peak performance frequencies and positions for maximum RF energy coupling.

This report describes the methodology and results of experiments performed on wireless data terminal. The objective was to determine if there is RF radiation and if radiation is found, what is the extent of radiation with respect to safety limits. SAR (Specific Absorption Rate) is the measure of RF exposure determined by the amount of RF energy absorbed by human body (or its parts) – to determine how the RF energy couples to the body or head which is a primary health concern for body worn devices. The limit below which the exposure to RF is considered safe by regulatory bodies in North America is 1.6 mW/g average over 1 gram of tissue mass.

### **CE:**

The order requires routine SAR evaluation prior to equipment authorization of portable transmitter devices, including portable telephones. For consumer products, the applicable limit is 2 mW/g as recommended by EN62209-1 for an uncontrolled environment. According to the Standard, the device should be evaluated at maximum output power (radiated from the antenna) under "worst-case" conditions for normal or intended use, incorporating normal antenna operating positions, device peak performance frequencies and positions for maximum RF energy coupling.

This report describes the methodology and results of experiments performed on wireless data terminal. The objective was to determine if there is RF radiation and if radiation is found, what is the extent of radiation with respect to safety limits. SAR (Specific Absorption Rate) is the measure of RF exposure determined by the amount of RF energy absorbed by human body (or its parts) – to determine how the RF energy couples to the body or head which is a primary health concern for body worn devices. The limit below which the exposure to RF is considered safe by regulatory bodies in Europe is 2 mW/g average over 10 gram of tissue mass.

The test configurations were laid out on a specially designed test fixture to ensure the reproducibility of measurements. Each configuration was scanned for SAR. Analysis of each scan was carried out to characterize the above effects in the device.

**SAR Limits**

FCC Limit (1g Tissue)

EXPOSURE LIMITS	SAR (W/kg)	
	(General Population / Uncontrolled Exposure Environment)	(Occupational / Controlled Exposure Environment)
Spatial Average (averaged over the whole body)	0.08	0.4
Spatial Peak (averaged over any 1 g of tissue)	1.60	8.0
Spatial Peak (hands/wrists/feet/ankles averaged over 10 g)	4.0	20.0

CE Limit (10g Tissue)

EXPOSURE LIMITS	SAR (W/kg)	
	(General Population / Uncontrolled Exposure Environment)	(Occupational / Controlled Exposure Environment)
Spatial Average (averaged over the whole body)	0.08	0.4
Spatial Peak (averaged over any 10 g of tissue)	2.0	10
Spatial Peak (hands/wrists/feet/ankles averaged over 10 g)	4.0	20.0

Population/Uncontrolled Environments are defined as locations where there is the exposure of individual who have no knowledge or control of their exposure.

Occupational/Controlled Environments are defined as locations where there is exposure that may be incurred by people who are aware of the potential for exposure (i.e. as a result of employment or occupation).

Occupational/Controlled environments Spatial Peak limit 8.0W/kg (FCC/IC) & 10 W/kg (CE) applied to the EUT.

## **FACILITIES**

---

The test site used by Bay Area Compliance Laboratories Corp. (Shenzhen) to collect data is located at 6/F, the 3rd Phase of WanLi Industrial Building, Shi Hua Road, Fu Tian Free Trade Zone, Shenzhen, Guangdong, P.R. of China



## DESCRIPTION OF TEST SYSTEM

These measurements were performed with ALSAS 10 Universal Integrated SAR Measurement system from APREL Laboratories.

### ALSAS-10U System Description

ALSAS-10-U is fully compliant with the technical and scientific requirements of IEEE 1528, IEC 62209, CENELEC, ARIB, ACA, and the Federal Communications Commission. The system comprises of a six axes articulated robot which utilizes a dedicated controller. ALSAS-10U uses the latest methodologies. And FDTD modeling to provide a platform which is repeatable with minimum uncertainty.

### Applications

Predefined measurement procedures compliant with the guidelines of CENELEC, IEEE, IEC, FCC, etc are utilized during the assessment for the device. Automatic detection for all SAR maxima are embedded within the core architecture for the system, ensuring that peak locations used for centering the zoom scan are within a 1mm resolution and a 0.05mm repeatable position. System operation range currently available up-to 6 GHz in simulated tissue.

### Area Scans

Area scans are defined prior to the measurement process being executed with a user defined variable spacing between each measurement point (integral) allowing low uncertainty measurements to be conducted. Scans defined for FCC applications utilize a 10mm<sup>2</sup> step integral, with 1mm interpolation used to locate the peak SAR area used for zoom scan assessments.

Where the system identifies multiple SAR peaks (which are within 25% of peak value) the system will provide the user with the option of assessing each peak location individually for zoom scan averaging.

### Zoom Scan (Cube Scan Averaging)

The averaging zoom scan volume utilized in the ALSAS-10U software is in the shape of a cube and the side dimension of a 1 g or 10 g mass is dependent on the density of the liquid representing the simulated tissue. A density of 1000 kg/m<sup>3</sup> is used to represent the head and body tissue density and not the phantom liquid density, in order to be consistent with the definition of the liquid dielectric properties, i.e. the side length of the 1 g cube is 10mm, with the side length of the 10 g cube 21,5mm.

When the cube intersects with the surface of the phantom, it is oriented so that 3 vertices touch the surface of the shell or the center of a face is tangent to the surface. The face of the cube closest to the surface is modified in order to conform to the tangent surface.

The zoom scan integer steps can be user defined so as to reduce uncertainty, but normal practice for typical test applications (including FCC) utilize a physical step of 5x5x8 (8mmx8mmx5mm) providing a volume of 32mm<sup>3</sup> in the X & Y axis, and 35mm in the Z axis.



### ALSAS-10U Interpolation and Extrapolation Uncertainty

The overall uncertainty for the methodology and algorithms the used during the SAR calculation was evaluated using the data from IEEE 1528 based on the example f3 algorithm:

$$f_3(x, y, z) = A \frac{a^2}{\frac{a^2}{4} + x'^2 + y'^2} \cdot \left( e^{-\frac{2z}{a}} + \frac{a^2}{2(a + 2z)^2} \right)$$

### Isotropic E-Field Probe

The isotropic E-Field probe has been fully calibrated and assessed for isotropicity, and boundary effect within a controlled environment. Depending on the frequency for which the probe is calibrated the method utilized for calibration will change.

The E-Field probe utilizes a triangular sensor arrangement as detailed in the diagram below:

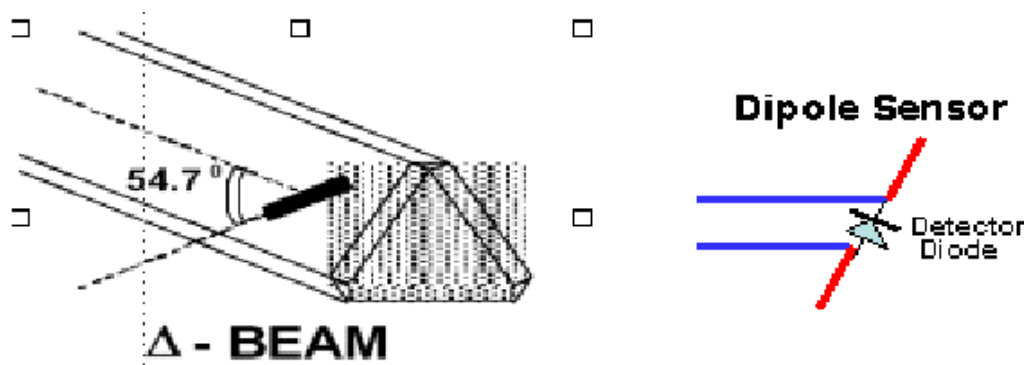

SAR is assessed with a calibrated probe which moves at a default height of 5mm from the center of the diode, which is mounted to the sensor, to the phantom surface (in the Z Axis). The 5mm offset height has been selected so as to minimize any resultant boundary effect due to the probe being in close proximity to the phantom surface.

The following algorithm is an example of the function used by the system for linearization of the output from the probe when measuring complex modulation schemes.

$$V_i = U_i + U_i^2 \cdot \frac{cf}{dcp_i}$$

## Isotropic E-Field Probe Specification

<b>Calibration Method</b>	Frequency Dependent Below 1 GHz Calibration in air performed in a TEM Cell Above 1 GHz Calibration in air performed in waveguide
<b>Sensitivity</b>	0.70 $\mu\text{V}/(\text{V}/\text{m})^2$ to 0.85 $\mu\text{V}/(\text{V}/\text{m})^2$
<b>Dynamic Range</b>	0.0005 W/kg to 100 W/kg
<b>Isotropic Response</b>	Better than 0.1 dB
<b>Diode Compression Point (DCP)</b>	Calibration for Specific Frequency
<b>Probe Tip Diameter</b>	< 2.9 mm
<b>Sensor Offset</b>	1.56 (+/- 0.02 mm)
<b>Probe Length</b>	289 mm
<b>Video Bandwidth</b>	@ 500 Hz: 1 dB @ 1.02 kHz: 3 dB
<b>Boundary Effect</b>	Less than 2.1% for distance greater than 0.58 mm
<b>Spatial Resolution</b>	The spatial resolution uncertainty is less than 1.5% for 4.9mm diameter probe. The spatial resolution uncertainty is less than 1.0% for 2.5mm diameter probe

## Boundary Detection Unit and Probe Mounting Device

ALSAS-10U incorporates a boundary detection unit with a sensitivity of 0.05mm for detecting all types of surfaces. The robust design allows for detection during probe tilt (probe normalize) exercises, and utilizes a second stage emergency stop. The signal electronics are fed directly into the robot controller for high accuracy surface detection in lateral and axial detection modes (X, Y, & Z).

The probe is mounted directly onto the Boundary Detection unit for accurate tooling and displacement calculations controlled by the robot kinematics. The probe is connect to an isolated probe interconnect where the output stage of the probe is fed directly into the amplifier stage of the Daq-Paq.

## Daq-Paq (Analog to Digital Electronics)

ALSAS-10U incorporates a fully calibrated Daq-Paq (analog to digital conversion system) which has a 4 channel input stage, sent via a 2 stage auto-set amplifier module. The input signal is amplified accordingly so as to offer a dynamic range from 5 $\mu\text{V}$  to 800mV. Integration of the fields measured is carried out at board level utilizing a Co-Processor which then sends the measured fields down into the main computational module in digitized form via an RS232 communications port. Probe linearity and duty cycle compensation is carried out within the main Daq-Paq module.

<b>ADC</b>	12 Bit
<b>Amplifier Range</b>	20 mV to 200 mV and 150 mV to 800 mV
<b>Field Integration</b>	Local Co-Processor utilizing proprietary integration algorithms
<b>Number of Input Channels</b>	4 in total 3 dedicated and 1 spare
<b>Communication</b>	Packet data via RS232

**Axis Articulated Robot**

ALSAS-10U utilizes a six axis articulated robot, which is controlled using a Pentium based real-time movement controller. The movement kinematics engine utilizes proprietary (Thermo CRS) interpolation and extrapolation algorithms, which allow full freedom of movement for each of the six joints within the working envelope. Utilization of joint 6 allows for full probe rotation with a tolerance better than 0.05mm around the central axis.



<b>Robot/Controller Manufacturer</b>	Thermo CRS
<b>Number of Axis</b>	Six independently controlled axis
<b>Positioning Repeatability</b>	0.05 mm
<b>Controller Type</b>	Single phase Pentium based C500C
<b>Robot Reach</b>	710 mm
<b>Communication</b>	RS232 and LAN compatible

**ALSAS Universal Workstation**

ALSAS Universal workstation allows for repeatability and fast adaptability. It allows users to do calibration, testing and measurements using different types of phantoms with one set up, which significantly speeds up the measurement process.

**Universal Device Positioner**

The universal device positioner allows complete freedom of movement of the EUT. Developed to hold a EUT in a free-space scenario any additional loading attributable to the material used in the construction of the positioner has been eliminated. Repeatability has been enhanced through the linear scales which form the design used to indicate positioning for any given test scenario in all major axes. A 15° tilt indicator is included for the of aid cheek to tilt movements for head SAR analysis. Overall uncertainty for measurements have been reduced due to the design of the Universal device positioner, which allows positioning of a device in as near to a free-space scenario as possible, and by providing the means for complete repeatability.



**Phantom Types**

The ALSAS-10U allows the integration of multiple phantom types. SAM Phantoms fully compliant with IEEE 1528, Universal Phantom, and Universal Flat.

**APREL SAM Phantoms**

The SAM phantoms developed using the IEEE SAM CAD file. They are fully compliant with the requirements for both IEEE 1528 and FCC Supplement C. Both the left and right SAM phantoms are interchangeable, transparent and include the IEEE 1528 grid with visible NF and MB lines.

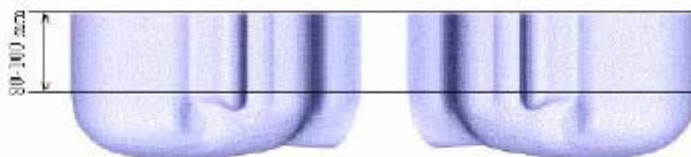

**APREL Laboratories Universal Phantom**

The Universal Phantom is used on the ALSAS-10U as a system validation phantom. The Universal Phantom has been fully validated both experimentally from 30MHz to 6GHz and numerically using XFDTD numerical software.

The shell thickness is 2mm overall, with a 4mm spacer located at the NF/MB intersection providing an overall thickness of 6mm in line with the requirements of IEEE-1528.

The design allows for fast and accurate measurements, of handsets, by allowing the conservative SAR to be evaluated at on frequency for both left and right head experiments in one measurement.



### Tissue Dielectric Parameters for Head and Body Phantoms

The head tissue dielectric parameters recommended by the IEEE SCC-34/SC-2 in P1528 have been incorporated in the following table. These head parameters are derived from planar layer models simulating the highest expected SAR for the dielectric properties and tissue thickness variations in a human head. Other head and body tissue parameters that have not been specified in P1528 are derived from the tissue dielectric parameters computed from the 4-Cole-Cole equations described in Reference [12] and extrapolated according to the head parameters specified in P1528.

Ingredients (% by weight)	Frequency (MHz)									
	450		835		915		1900		2450	
Tissue Type	Head	Body	Head	Body	Head	Body	Head	Body	Head	Body
Water	38.56	51.16	41.45	52.4	41.05	56.0	54.9	40.4	62.7	73.2
Salt (Nacl)	3.95	1.49	1.45	1.4	1.35	0.76	0.18	0.5	0.5	0.04
Sugar	56.32	46.78	56.0	45.0	56.5	41.76	0.0	58.0	0.0	0.0
HEC	0.98	0.52	1.0	1.0	1.0	1.21	0.0	1.0	0.0	0.0
Bactericide	0.19	0.05	0.1	0.1	0.1	0.27	0.0	0.1	0.0	0.0
Triton x-100	0.0	0.0	0.0	0.0	0.0	0.0	0.0	0.0	36.8	0.0
DGBE	0.0	0.0	0.0	0.0	0.0	0.0	44.92	0.0	0.0	26.7
Dielectric Constant	43.42	58.0	42.54	56.1	42.0	56.8	39.9	54.0	39.8	52.5
Conductivity (s/m)	0.85	0.83	0.91	0.95	1.0	1.07	1.42	1.45	1.88	1.78

### Recommended Tissue Dielectric Parameters for Head and Body

Frequency (MHz)	Head Tissue		Body Tissue	
	$\epsilon_r$	$\sigma$ (S/m)	$\epsilon_r$	$\sigma$ (S/m)
150	52.3	0.76	61.9	0.80
300	45.3	0.87	58.2	0.92
450	43.5	0.87	56.7	0.94
835	41.5	0.90	55.2	0.97
900	41.5	0.97	55.0	1.05
915	41.5	0.98	55.0	1.06
1450	40.5	1.20	54.0	1.30
1610	40.3	1.29	53.8	1.40
1800-2000	40.0	1.40	53.3	1.52
2450	39.2	1.80	52.7	1.95
3000	38.5	2.40	52.0	2.73
5800	35.3	5.27	48.2	6.00

## EQUIPMENT LIST AND CALIBRATION

### Equipments List & Calibration Information

Equipment	Model	Calibration Date	S/N
CRS F3 robot	ALS-F3	N/A	RAF0805352
CRS F3 Software	ALS-F3-SW	N/A	N/A
CRS C500C controller	ALS-C500	N/A	RCF0805379
Probe mounting device & Boundary Detection Sensor System	ALS-PMDPS-3	N/A	120-00270
Universal Work Station	ALS-UWS	N/A	100-00157
Data Acquisition Package	ALS-DAQ-PAQ-3	2014-10-14	110-00212
Miniature E-Field Probe	E-020	2014-10-14	500-00283
Loop, 150 MHz	CLA150	2014-05-08	4004
Device holder/Positioner	ALS-H-E-SET-2	N/A	170-00510
Left ear SAM phantom	ALS-P-SAM-L	N/A	130-00311
Right ear SAM phantom	ALS-P-SAM-R	N/A	140-00359
UniPhantom	ALS-UM-FLAT	N/A	153-00104
Simulated Tissue 150 MHz Head	ALS-TS-150-H	Each Time	250-01302
Simulated Tissue 150 MHz Body	ALS-TS-150-B	Each Time	250-01304
Dielectric probe kit	HP85070B	2014-06-13	N/A
Power Amplifier	5S1G4	N/A	71377
Attenuator	3dB	2014-05-08	5402
Network analyzer	8752C	2014-06-03	3410A02356
Synthesized Sweeper	HP 8341B	2014-06-03	2624A00116
Directional couple	DC6180A	2014-06-13	0325849
EMI Test Receiver	ESCI	2014-06-13	101746



# SAR MEASUREMENT SYSTEM VERIFICATION

## Liquid Verification

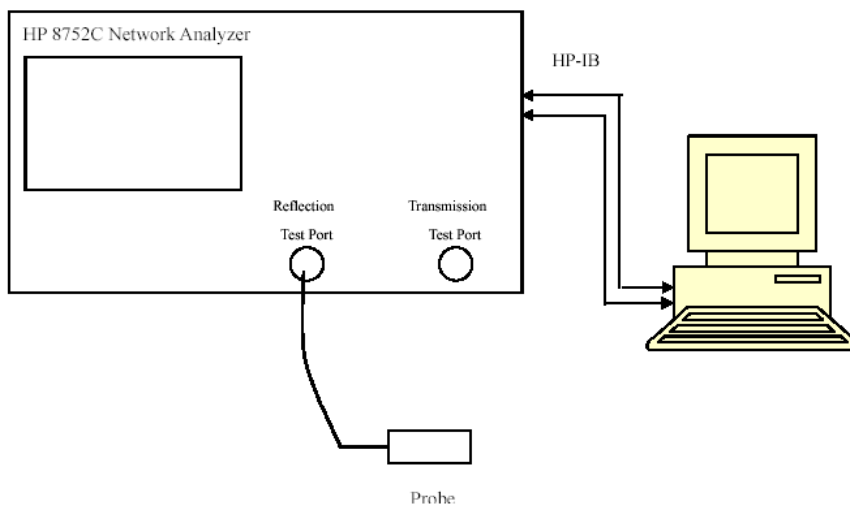

Liquid Verification Setup Block Diagram

## Liquid Verification Results

Frequency (MHz)	Liquid Type	Liquid Parameter		Target Value		Delta (%)		Tolerance (%)
		$\epsilon_r$	$\sigma$ (S/m)	$\epsilon_r$	$\sigma$ (S/m)	$\Delta\epsilon_r$	$\Delta\sigma$ (S/m)	
151.880	Head	50.57	0.78	52.30	0.76	-3.308	2.632	±5
	Body	61.27	0.81	61.90	0.80	-1.018	1.250	±5
154.600	Head	50.47	0.78	52.30	0.76	-3.499	2.632	±5
	Body	61.81	0.81	61.90	0.80	-0.145	1.250	±5

\*Liquid Verification was performed on 2015-02-07

Please refer to the following tables.

150MHz Head			150MHz Body		
Frequency (MHz)	e'	e''	Frequency (MHz)	e'	e''
136.00	51.7614	101.2108	136.00	61.4363	105.1380
136.76	51.8031	100.1521	136.76	62.4600	105.4271
137.52	51.7414	100.1193	137.52	62.0969	104.8038
138.28	52.0188	99.2437	138.28	61.3328	104.7748
139.04	51.4696	98.9868	139.04	60.9828	104.2036
139.80	51.3093	98.8940	139.80	61.9982	103.7178
140.56	51.3538	98.1619	140.56	62.9968	102.3023
141.32	51.4062	97.1740	141.32	60.9708	102.1167
142.08	51.0719	97.4748	142.08	61.7638	102.3732
142.84	51.1739	97.0042	142.84	60.9250	101.7329
143.60	50.8378	96.4946	143.60	61.8174	101.3338
144.36	50.9013	96.0866	144.36	62.6126	100.1322
145.12	50.6170	95.6600	145.12	61.1836	100.3551
145.88	50.6417	95.7175	145.88	60.7503	99.7605
146.64	50.5825	95.1257	146.64	61.9501	99.7358
147.40	50.5631	94.6516	147.40	62.2656	98.6325
148.16	50.6630	94.2676	148.16	60.7171	98.7177
148.92	50.5350	92.3985	148.92	60.7940	97.7602
149.68	50.5184	93.1377	149.68	60.8845	97.3744
150.44	50.6859	92.4813	150.44	60.7571	96.9898
151.20	50.5922	93.0283	151.20	62.4171	95.9046
151.96	50.5691	91.8258	151.96	61.2693	96.4040
152.72	50.5193	91.9708	152.72	60.4283	95.4187
153.48	50.4961	91.6645	153.48	62.5020	95.4408
154.24	50.5499	91.1061	154.24	62.1120	94.5887
155.00	50.4294	89.5438	155.00	61.3960	93.0265
155.76	50.2394	90.0944	155.76	61.3920	93.6910
156.52	50.1292	90.6608	156.52	62.1441	92.6020
157.28	49.8135	89.7901	157.28	61.9754	92.4828
158.04	50.3878	88.5906	158.04	62.3383	92.6331
158.80	50.2525	88.8649	158.80	60.6967	91.9823
159.56	50.4553	88.0126	159.56	61.7713	92.0335
160.32	50.3630	87.3887	160.32	60.7125	92.1373
161.08	50.6419	87.4920	161.08	60.5336	90.4168
161.84	50.7228	87.5037	161.84	60.9049	90.6208
162.60	50.6964	87.2849	162.60	62.6263	88.5603
163.36	51.0121	86.0283	163.36	61.7319	90.0818
164.12	50.4423	85.4560	164.12	60.7098	89.6797
164.88	50.6949	86.1706	164.88	62.3485	90.0672
165.64	50.7911	85.2907	165.64	60.4581	89.2871
166.40	50.5348	84.9662	166.40	61.3439	88.1234
167.16	50.2534	84.6249	167.16	61.2436	88.0587
167.92	50.3904	84.1720	167.92	61.8358	87.1716
168.68	50.5223	83.9445	168.68	61.5615	87.1058
169.44	50.7564	83.5580	169.44	61.5534	87.7207
170.20	50.9500	83.9628	170.20	62.4272	87.0181
170.96	50.6064	82.7963	170.96	61.0749	86.5391
171.72	50.8440	82.7887	171.72	60.2520	87.1596
172.48	50.7341	82.7138	172.48	61.1586	85.8243
173.24	51.0711	82.2787	173.24	60.7665	85.0766
174.00	51.0103	81.9430	174.00	60.8826	84.6949

### System Accuracy Verification

Prior to the assessment, the system validation kit was used to test whether the system was operating within its specifications of  $\pm 10\%$ . The validation results are tabulated below. And also the corresponding SAR plot is attached as well in the SAR plots files.

### System Verification Setup Block Diagram

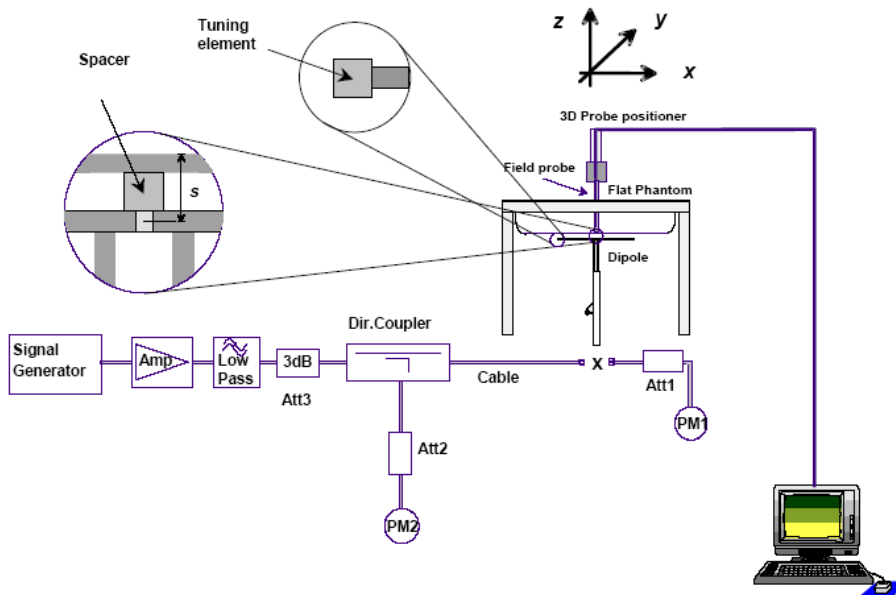

### Probe and dipole antenna List and Detail

Manufacturer	Description	Model	Serial Number	Calibration Date	Calibration Due Date
APREL	Probe	ALS-E-020	500-00283	2013-10-08	2014-10-07
Speag	Loop antenna(150MHz)	CLA150	4004	2014-05-08	2017-05-07

### System Accuracy Check Results

Date	Frequency (MHz)	Liquid Type	Measured SAR (W/Kg)	Target Value (W/Kg)	Delta (%)	Tolerance (%)
2015-02-07	150	Head	1g	3.402	3.750	-9.280
		Body	1g	3.496	3.810	-8.241

\*All SAR values are normalized to 1 Watt forward power.

**SAR SYSTEM VALIDATION DATA****Test Laboratory: Bay Area Compliance Lab Corp. (Shenzhen)****System Performance Check 150 MHz Head Liquid****Loop150 MHz; Type: CLA150; S/N:4004**

## Product Data

Device Name : Loop 150 MHz  
Serial No. : 4004  
Type : Loop  
Model : CLA150  
Frequency Band : 150  
Max. Transmit Pwr : 1 W  
Drift Time : 3 min(s)  
Power Drift-Start : 3.103 W/kg  
Power Drift-Finish : 3.145 W/kg  
Power Drift (%) : 1.412

## Phantom Data

Name : APREL-Uni  
Type : Uni-Phantom  
Serial No. : System Default  
Location : Center  
Description : Default  
Phantom Data

## Tissue Data

Type : Head  
Serial No. : 250-01302  
Frequency : 150.00MHz  
Last Calib. Date : 07-Feb-2015  
Temperature : 20.00 °C  
Ambient Temp. : 21.00 °C  
Humidity : 56.00 RH%  
Epsilon : 50.61 F/m  
Sigma : 0.78 S/m  
Density : 1000.00 kg/cu. m

## Probe Data

Name : E-Field  
Model : E-020  
Type : E-Field Triangle  
Serial No. : 500-00283  
Last Calib. Date : 14-Oct-2014  
Frequency Band : 150  
Duty Cycle Factor : 1  
Conversion Factor : 6.0  
Probe Sensitivity : 1.20 1.20 1.20  $\mu\text{V}/(\text{V}/\text{m})^2$   
Compression Point : 95.00 mV  
Offset : 1.56 mm

## Measurement Data

Crest Factor : 1  
Scan Type : Complete  
Tissue Temp. : 21.00 °C  
Ambient Temp. : 21.00 °C  
Area Scan : 8x10x1 : Measurement x=10mm, y=10mm, z=4mm  
Zoom Scan : 7x7x7 : Measurement x=5mm, y=5mm, z=5mm

1 gram SAR value : 3.402 W/kg  
10 gram SAR value : 2.241 W/kg  
Area Scan Peak SAR : 3.437 W/kg  
Zoom Scan Peak SAR : 5.243 W/kg

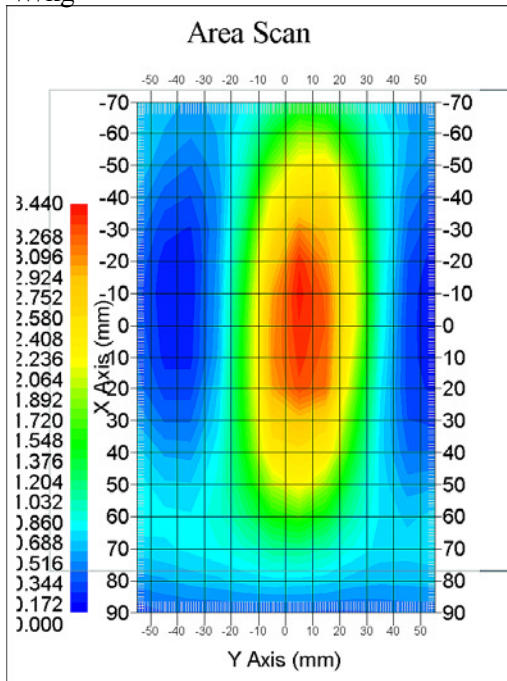

150 MHz System Validation with Head Tissue

**Test Laboratory: Bay Area Compliance Lab Corp. (Shenzhen)****System Performance Check 150 MHz Body Liquid****Loop 150 MHz; Type: CLA150; S/N: 4004**

## Product Data

Device Name : Loop 150 MHz  
Serial No. : 4004  
Type : Loop  
Model : CAL150  
Frequency Band : 150  
Max. Transmit Pwr : 1 W  
Drift Time : 3 min(s)  
Power Drift-Start : 3.002 W/kg  
Power Drift-Finish : 3.049 W/kg  
Power Drift (%) : 1.546

## Phantom Data

Name : APREL-Uni  
Type : Uni-Phantom  
Serial No. : System Default  
Location : Center  
Description : Default  
Phantom Data

## Tissue Data

Type : Body  
Serial No. : 250-01304  
Frequency : 150.00MHz  
Last Calib. Date : 07-Feb-2015  
Temperature : 20.00 °C  
Ambient Temp. : 21.00 °C  
Humidity : 56.00 RH%  
Epsilon : 60.81 F/m  
Sigma : 0.81 S/m  
Density : 1000.00 kg/cu. m

## Probe Data

Name : E-Field  
Model : E-020  
Type : E-Field Triangle  
Serial No. : 500-00283  
Last Calib. Date : 14-Oct-2014  
Frequency Band : 150  
Duty Cycle Factor : 1  
Conversion Factor : 6.0  
Probe Sensitivity : 1.20 1.20 1.20  $\mu\text{V}/(\text{V}/\text{m})^2$   
Compression Point : 95.00 mV  
Offset : 1.56 mm

## Measurement Data

Crest Factor : 1  
Scan Type : Complete  
Tissue Temp. : 21.00 °C  
Ambient Temp. : 21.00 °C  
Area Scan : 8x10x1 : Measurement x=10mm, y=10mm, z=4mm  
Zoom Scan : 7x7x7 : Measurement x=5mm, y=5mm, z=5mm

1 gram SAR value : 3.496 W/kg  
10 gram SAR value : 2.263 W/kg  
Area Scan Peak SAR : 3.477 W/kg  
Zoom Scan Peak SAR : 5.238 W/kg

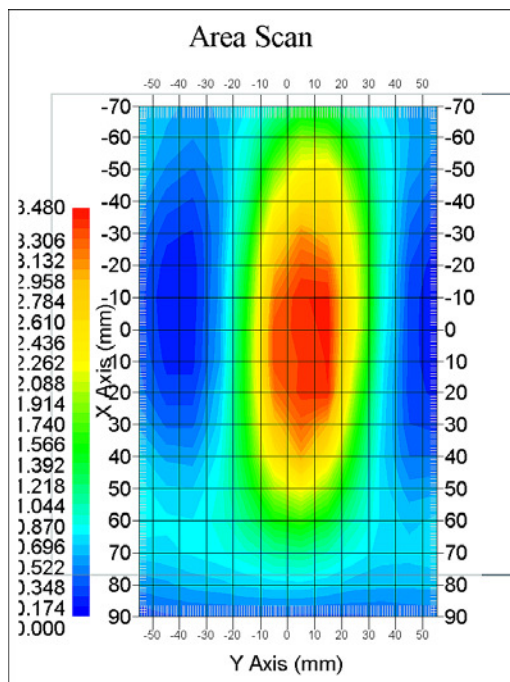

150 MHz System Validation with Body Tissue

## EUT TEST STRATEGY AND METHODOLOGY

### Test Positions for Device Operating Next to a Person’s Ear

This category includes most wireless handsets with fixed, retractable or internal antennas located toward the top half of the device, with or without a foldout, sliding or similar keypad cover. The handset should have its earpiece located within the upper ¼ of the device, either along the centerline or off-centered, as perceived by its users. This type of handset should be positioned in a normal operating position with the “test device reference point” located along the “vertical centerline” on the front of the device aligned to the “ear reference point”. The “test device reference point” should be located at the same level as the center of the earpiece region. The “vertical centerline” should bisect the front surface of the handset at its top and bottom edges. A “ear reference point” is located on the outer surface of the head phantom on each ear spacer. It is located 1.5 cm above the center of the ear canal entrance in the “phantom reference plane” defined by the three lines joining the center of each “ear reference point” (left and right) and the tip of the mouth.

A handset should be initially positioned with the earpiece region pressed against the ear spacer of a head phantom. For the SCC-34/SC-2 head phantom, the device should be positioned parallel to the “N-F” line defined along the base of the ear spacer that contains the “ear reference point”. For interim head phantoms, the device should be positioned parallel to the cheek for maximum RF energy coupling. The “test device reference point” is aligned to the “ear reference point” on the head phantom and the “vertical centerline” is aligned to the “phantom reference plane”. This is called the “initial ear position”. While maintaining these three alignments, the body of the handset is gradually adjusted to each of the following positions for evaluating SAR:

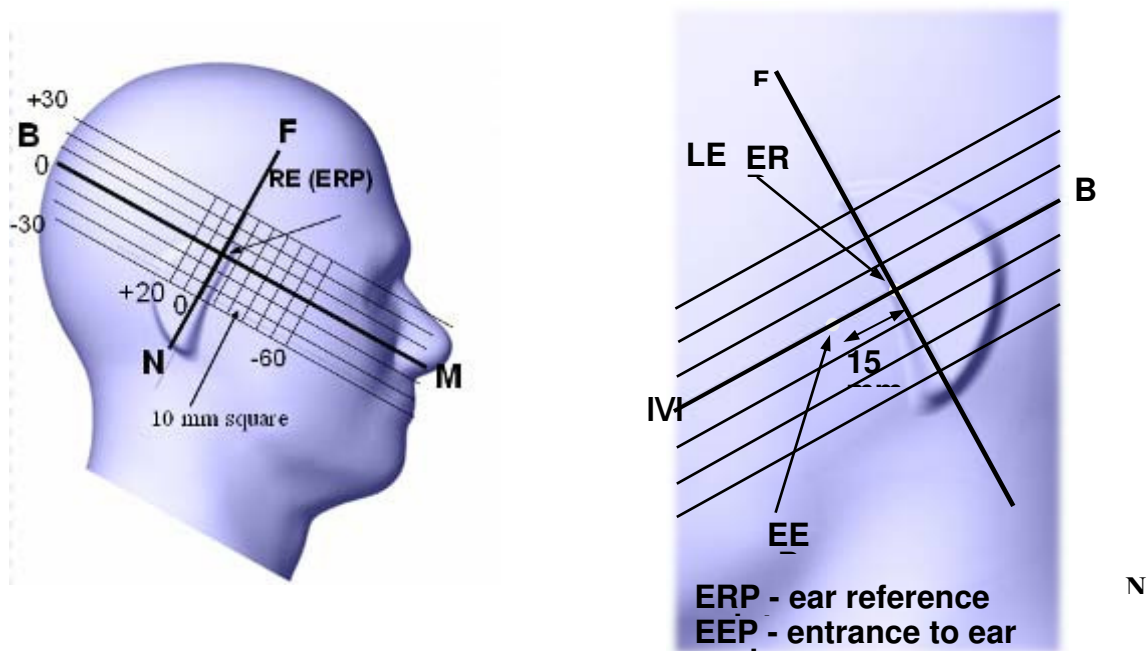



## Cheek/Touch Position

The device is brought toward the mouth of the head phantom by pivoting against the “ear reference point” or along the “N-F” line for the SCC-34/SC-2 head phantom.

This test position is established:

- When any point on the display, keypad or mouthpiece portions of the handset is in contact with the phantom.
- (or) When any portion of a foldout, sliding or similar keypad cover opened to its intended self-adjusting normal use position is in contact with the cheek or mouth of the phantom.

For existing head phantoms – when the handset loses contact with the phantom at the pivoting point, rotation should continue until the device touches the cheek of the phantom or breaks its last contact from the ear spacer.

### Cheek /Touch Position

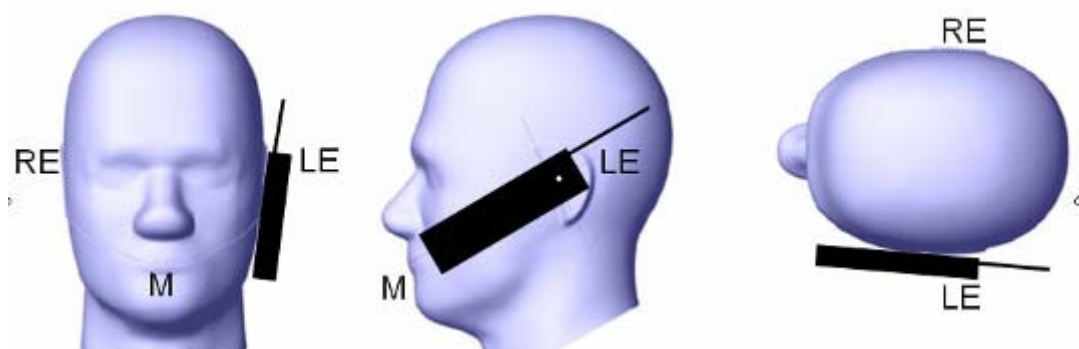

## Ear/Tilt Position

With the handset aligned in the “Cheek/Touch Position”:

1) If the earpiece of the handset is not in full contact with the phantom’s ear spacer (in the “Cheek/Touch position”) and the peak SAR location for the “Cheek/Touch” position is located at the ear spacer region or corresponds to the earpiece region of the handset, the device should be returned to the “initial ear position” by rotating it away from the mouth until the earpiece is in full contact with the ear spacer.

2) (otherwise) The handset should be moved (translated) away from the cheek perpendicular to the line passes through both “ear reference points” (note: one of these ear reference points may not physically exist on a split head model) for approximate 2-3 cm. While it is in this position, the device handset is tilted away from the mouth with respect to the “test device reference point” until the inside angle between the vertical centerline on the front surface of the phone and the horizontal line passing through the ear reference point is by  $15^{\circ}$  to  $80^{\circ}$ . After the tilt, it is then moved (translated) back toward the head perpendicular to the line passes through both “ear reference points” until the device touches the phantom or the ear spacer. If the antenna touches the head first, the positioning process should be repeated with a tilt angle less than  $15^{\circ}$  so that the device and its antenna would touch the phantom simultaneously. This test position may require a device holder or positioner to achieve the translation and tilting with acceptable positioning repeatability.

If a device is also designed to transmit with its keypad cover closed for operating in the head position, such positions should also be considered in the SAR evaluation. The device should be tested on the left and right side of the head phantom in the “Cheek/Touch” and “Ear/Tilt” positions. When applicable, each configuration should be tested with the antenna in its fully extended and fully retracted positions. These test configurations should be tested at the high, middle and low frequency channels of each operating mode; for example, AMPS, CDMA, and TDMA. If the SAR measured at the middle channel for each test configuration (left, right, Cheek/Touch, Tile/Ear, extended and retracted) is at least 2.0 dB lower than the SAR limit, testing at the high and low channels is optional for such test configuration(s). If the transmission band of the test device is less than 10 MHz, testing at the high and low frequency channels is optional.

**Ear /Tilt 15° Position**

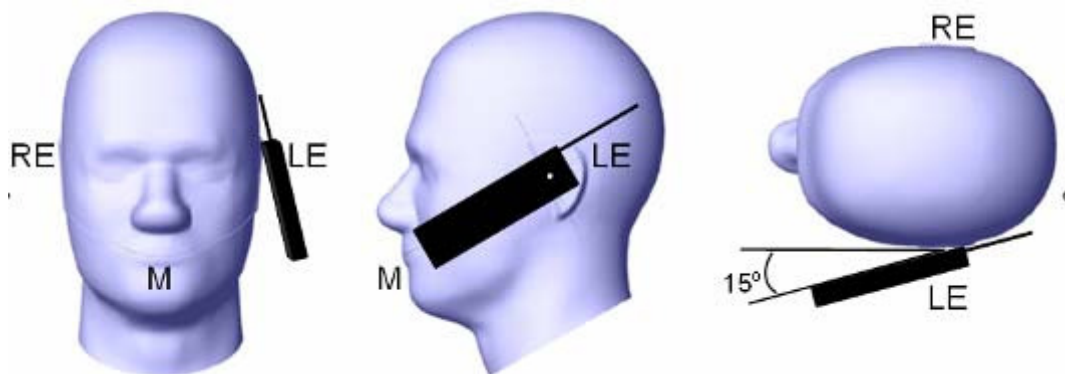

**Test positions for body-worn and other configurations**

Body-worn operating configurations should be tested with the belt-clips and holsters attached to the device and positioned against a flat phantom in normal use configurations. Devices with a headset output should be tested with a headset connected to the device. When multiple accessories that do not contain metallic components are supplied with the device, the device may be tested with only the accessory that dictates the closest spacing to the body. When multiple accessories that contain metallic components are supplied with the device, the device must be tested with each accessory that contains a unique metallic component. If multiple accessories share an identical metallic component (e.g., the same metallic belt-clip used with different holsters with no other metallic components), only the accessory that dictates the closest spacing to the body must be tested.

Body-worn accessories may not always be supplied or available as options for some devices that are intended to be authorized for body-worn use. A separation distance of 1.5 cm between the back of the device and a flat phantom is recommended for testing body-worn SAR compliance under such circumstances. Other separation distances may be used, but they should not exceed 2.5 cm. In these cases, the device may use body-worn accessories that provide a separation distance greater than that tested for the device provided however that the accessory contains no metallic components.

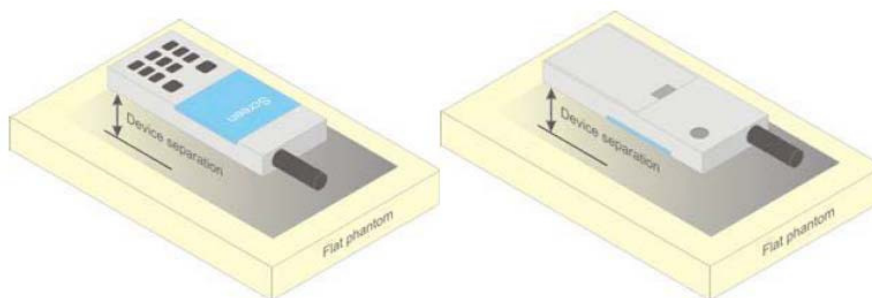

**Figure 5 – Test positions for body-worn devices**

## SAR Evaluation Procedure

The evaluation was performed with the following procedure:

Step 1: Measurement of the SAR value at a fixed location above the ear point or central position was used as a reference value for assessing the power drop. The SAR at this point is measured at the start of the test and then again at the end of the testing.

Step 2: The SAR distribution at the exposed side of the head was measured at a distance of 4 mm from the inner surface of the shell. The area covered the entire dimension of the head or EUT and the horizontal grid spacing was 10 mm x 10 mm. Based on these data, the area of the maximum absorption was determined by spline interpolation. The first Area Scan covers the entire dimension of the EUT to ensure that the hotspot was correctly identified.

Step 3: Around this point, a volume of 35 mm x 35 mm x 35 mm was assessed by measuring 7x 7 x 7 points. On the basis of this data set, the spatial peak SAR value was evaluated under the following procedure:

- 1) The data at the surface were extrapolated, since the center of the dipoles is 1.2 mm away from the tip of the probe and the distance between the surface and the lowest measuring point is 1.3 mm. The extrapolation was based on a least square algorithm. A polynomial of the fourth order was calculated through the points in z-axes. This polynomial was then used to evaluate the points between the surface and the probe tip.
- 2) The maximum interpolated value was searched with a straightforward algorithm. Around this maximum the SAR values averaged over the spatial volumes (1 g or 10 g) were computed by the 3D-Spline interpolation algorithm. The 3D-Spline is composed of three one dimensional splines with the "Not a knot"-condition (in x, y and z-directions). The volume was integrated with the trapezoidal-algorithm. One thousand points (10 x 10 x 10) were interpolated to calculate the averages.

All neighboring volumes were evaluated until no neighboring volume with a higher average value was found.

Step 4: Re-measurement of the SAR value at the same location as in Step 1. If the value changed by more than 5%, the evaluation was repeated.

## Test methodology

IEEE1528:2013  
KDB 447498 D01 v05r02  
KDB 865664 D01 v01r03  
KDB 643646 D01 v01r01  
KDB Inquiry: Tracking Number 316436

## CONDUCTED OUTPUT POWER MEASUREMENT

### Provision Applicable

The measured peak output power should be greater and within 5% than EMI measurement.

### Test Procedure

The RF output of the transmitter was connected to the input of the Signal Analyzer through sufficient attenuation.

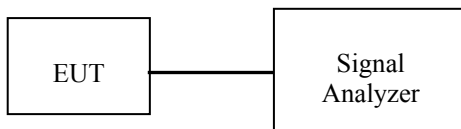

### Maximum Output Power among production units

Max. tune-up tolerance power limit for Production Unit (dBm)	
PTT/Mode	Frequency(151.820-154.600)MHz
FM	33.00

### Test Results:

Mode	Channel Bandwidth (kHz)	Frequency (MHz)	Output(dBm)	Output Power(W)	Power level
Analog	12.5	151.820	32.73	1.875	High
		151.880	<b>32.76</b>	1.888	High
		151.940	32.74	1.879	High
	25	154.570	32.66	1.845	High
		154.600	<b>32.72</b>	1.871	High

## SAR MEASUREMENT RESULTS

This page summarizes the results of the performed dosimetric evaluation.

### SAR Test Data

#### Environmental Conditions

<b>Temperature:</b>	21 °C
<b>Relative Humidity:</b>	50%
<b>ATM Pressure:</b>	1002 mbar

\* Testing was performed by Wilson Chen on 2015-02-07

### Test Result:

#### Analog (Modulation FM);

Frequency (MHz)	Power Drift (%)	Max. Meas. Power (dBm)	Max. Rated Power (dBm)	1 g SAR Value(W/Kg)				
				Scaled Factor	Meas. SAR	Scaled SAR	50%	Plot
Face up (2.5cm)								
151.880	-0.329	32.76	33.00	1.057	0.106	0.112	0.056	1#
154.600	-2.743	32.72	33.00	1.067	0.178	0.190	0.095	2#
Body-Back with Belt Clip(0.0cm)								
151.880	2.612	32.76	33.00	1.057	0.115	0.122	0.061	3#
154.600	3.021	32.72	33.00	1.067	0.204	0.218	0.109	4#

#### Note:

1. When the 1-g SAR tested using the default battery and default accessories is  $\leq 3.5W/Kg$  (corrected by Multiplying 50% for FM mode), testing for other channels are optional.
2. For a analog PTT, only simplex communication technology was supported, so the SAR value need to be corrected by Multiplying 50%.
3. Passive body-worn and audio accessories generally do not apply to the head SAR of PTT radios.
4. The whole antenna and radiating structures that may contribute to the measured SAR or influence the SAR distribution has been included in the area scan.

**SAR Plots (Summary of the Highest SAR Values)**

**Test Laboratory: Bay Area Compliance Lab Corp. (Shenzhen)**

**Face-Up 2.5cm (Analog 12.5k-151.880MHz)**

**Measurement Data**

Modulation mode : FM  
 Crest Factor : 1  
 Scan Type : Complete  
 Area Scan : 15x8x1: Measurement x=10mm, y=10mm, z=4mm  
 Zoom Scan : 7x7x7: Measurement x=5mm, y=5mm, z=5mm  
 Power Drift-Start : 0.075 W/kg  
 Power Drift-Finish : 0.075W/kg  
 Power Drift (%) :-0.329

**Tissue Data**

Type : Head  
 Frequency : 151.88 MHz  
 Epsilon : 50.57 F/m  
 Sigma : 0.78 S/m  
 Density : 1000.00 kg/cu. m

**Probe Data**

Serial No. : 500-00283  
 Frequency Band : 150  
 Duty Cycle Factor : 1  
 Conversion Factor : 6.0  
 Probe Sensitivity : 1.20 1.20 1.20  $\mu\text{V}/(\text{V}/\text{m})^2$   
 Compression Point : 95.00 mV  
 Offset : 1.56 mm

1 gram SAR value : 0.106 W/kg  
 10 gram SAR value : 0.074 W/kg  
 Area Scan Peak SAR : 0.111 W/kg  
 Zoom Scan Peak SAR : 0.149 W/kg

**Plot 1#**

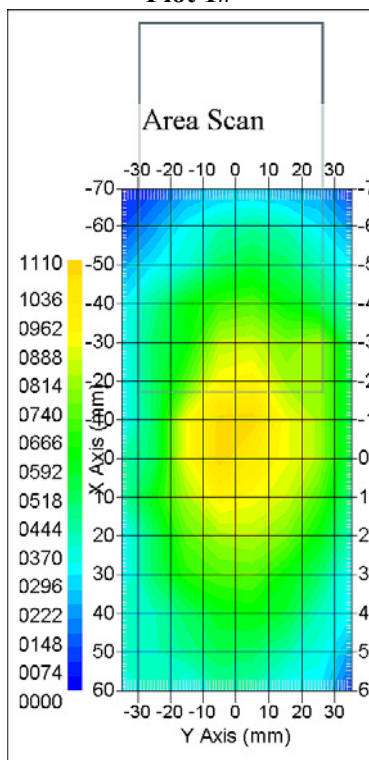

**Test Laboratory: Bay Area Compliance Lab Corp. (Shenzhen)**

**Body-back 0.0cm (Analog 12.5k-151.88MHz)**

Measurement Data

Modulation mode : FM  
 Crest Factor : 1  
 Scan Type : Complete  
 Area Scan : 15x8x1: Measurement x=10mm, y=10mm, z=4mm  
 Zoom Scan : 7x7x7: Measurement x=5mm, y=5mm, z=5mm  
 Power Drift-Start : 0.125 W/kg  
 Power Drift-Finish : 0.122 W/kg  
 Power Drift (%) : -2.743

Tissue Data

Type : Body  
 Frequency : 151.88 MHz  
 Epsilon : 61.27 F/m  
 Sigma : 0.81 S/m  
 Density : 1000.00 kg/cu. m

Probe Data

Serial No. : 500-00283  
 Frequency Band : 150  
 Duty Cycle Factor : 1  
 Conversion Factor : 6.0  
 Probe Sensitivity : 1.20 1.20 1.20  $\mu\text{V}/(\text{V}/\text{m})^2$   
 Compression Point : 95.00 mV  
 Offset : 1.56 mm

1 gram SAR value : 0.178 W/kg  
 10 gram SAR value : 0.127 W/kg  
 Area Scan Peak SAR : 0.181 W/kg  
 Zoom Scan Peak SAR : 0.321 W/kg

**Plot 2#**

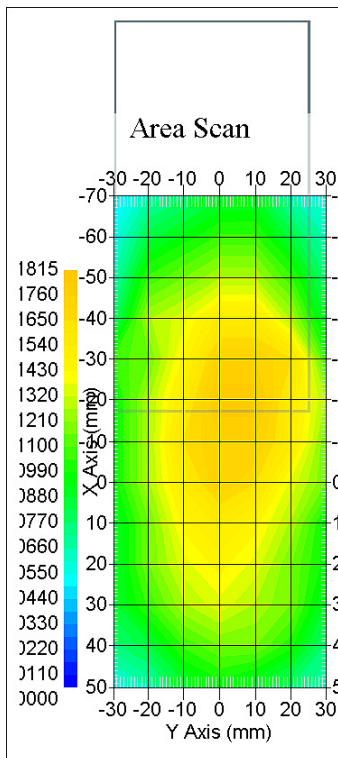

**Test Laboratory: Bay Area Compliance Lab Corp. (Shenzhen)**

**Face-Up 2.5cm (Analog 25k-154.60MHz)**

Measurement Data

Modulation mode : FM  
 Crest Factor : 1  
 Scan Type : Complete  
 Area Scan : 15x8x1: Measurement x=10mm, y=10mm, z=4mm  
 Zoom Scan : 7x7x7: Measurement x=5mm, y=5mm, z=5mm  
 Power Drift-Start : 0.078 W/kg  
 Power Drift-Finish : 0.080W/kg  
 Power Drift (%) : 2.612

Tissue Data

Type : Head  
 Frequency : 154.60 MHz  
 Epsilon : 50.47 F/m  
 Sigma : 0.78 S/m  
 Density : 1000.00 kg/cu. m

Probe Data

Serial No. : 500-00283  
 Frequency Band : 150  
 Duty Cycle Factor : 1  
 Conversion Factor : 6.0  
 Probe Sensitivity : 1.20 1.20 1.20  $\mu\text{V}/(\text{V}/\text{m})^2$   
 Compression Point : 95.00 mV  
 Offset : 1.56 mm

1 gram SAR value : 0.115 W/kg  
 10 gram SAR value : 0.081 W/kg  
 Area Scan Peak SAR : 0.118 W/kg  
 Zoom Scan Peak SAR : 0.163 W/kg

**Plot 3#**

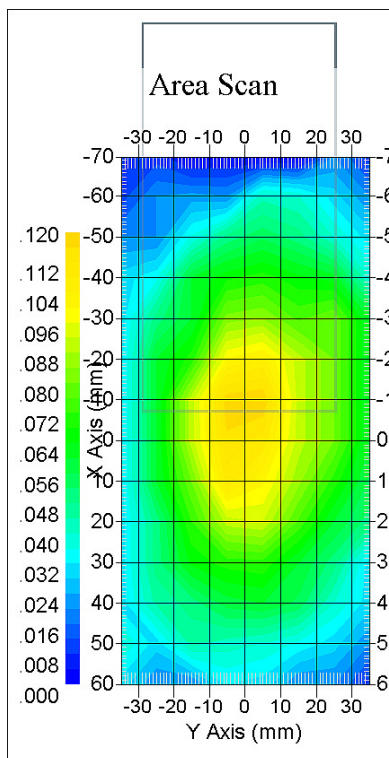



**Test Laboratory: Bay Area Compliance Lab Corp. (Shenzhen)**

**Body-back 0.0cm (Analog 25k-154.60MHz)**

Measurement Data

Modulation mode : FM  
 Crest Factor : 1  
 Scan Type : Complete  
 Area Scan : 15x8x1: Measurement x=10mm, y=10mm, z=4mm  
 Zoom Scan : 7x7x7: Measurement x=5mm, y=5mm, z=5mm  
 Power Drift-Start : 0.136 W/kg  
 Power Drift-Finish : 0.140 W/kg  
 Power Drift (%) : 3.021

Tissue Data

Type : Body  
 Frequency : 154.600 MHz  
 Epsilon : 61.81 F/m  
 Sigma : 0.81 S/m  
 Density : 1000.00 kg/cu. m

Probe Data

Serial No. : 500-00283  
 Frequency Band : 150  
 Duty Cycle Factor : 1  
 Conversion Factor : 6.0  
 Probe Sensitivity : 1.20 1.20 1.20  $\mu\text{V}/(\text{V}/\text{m})^2$   
 Compression Point : 95.00 mV  
 Offset : 1.56 mm

1 gram SAR value : 0.204 W/kg  
 10 gram SAR value : 0.147 W/kg  
 Area Scan Peak SAR : 0.211 W/kg  
 Zoom Scan Peak SAR : 0.376 W/kg

**Plot 4#**

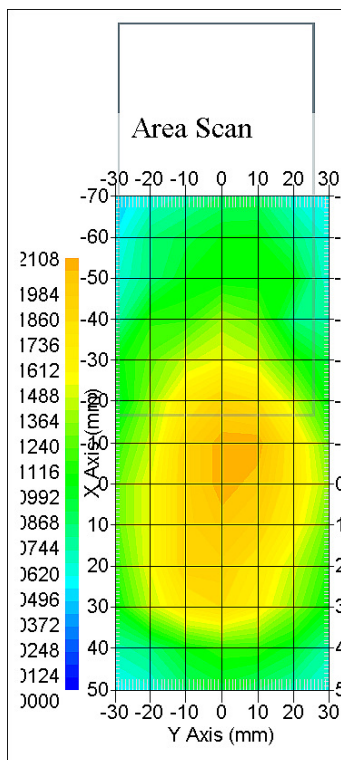

## APPENDIX A – MEASUREMENT UNCERTAINTY

The uncertainty budget has been determined for the measurement system and is given in the following Table.

**Measurement Uncertainty for 30 MHz to 6 GHz**

Source of Uncertainty	Tolerance Value	Probability Distribution	Divisor	$c_i^1$ (1-g)	$c_i^1$ (10-g)	Standard Uncertainty (1-g) %	Standard Uncertainty (10-g) %
<b>Measurement System</b>							
Probe Calibration	3.5	normal	1	1	1	3.5	3.5
Axial Isotropy	3.7	rectangular	$\sqrt{3}$	$(1-cp)^{1/2}$	$(\frac{1-cp}{2})^{1/2}$	1.5	1.5
Hemispherical Isotropy	10.9	rectangular	$\sqrt{3}$	$\sqrt{cp}$	$\sqrt{cp}$	4.4	4.4
Boundary Effect	1.0	rectangular	$\sqrt{3}$	1	1	0.6	0.6
Linearity	4.7	rectangular	$\sqrt{3}$	1	1	2.7	2.7
Detection Limit	1.0	rectangular	$\sqrt{3}$	1	1	0.6	0.6
Readout Electronics	1.0	normal	1	1	1	1.0	1.0
Response Time	0.8	rectangular	$\sqrt{3}$	1	1	0.5	0.5
Integration Time	1.7	rectangular	$\sqrt{3}$	1	1	1.0	1.0
RF Ambient Condition -Noise	0.6	rectangular	$\sqrt{3}$	1	1	0.3	0.3
RF Ambient Condition -Reflections	3.0	rectangular	$\sqrt{3}$	1	1	1.7	1.7
Probe Positioner Mech. Restrictions	0.4	rectangular	$\sqrt{3}$	1	1	0.2	0.2
<b>Restriction</b>							
Probe Positioning with respect to Phantom Shell	2.9	rectangular	$\sqrt{3}$	1	1	1.7	1.7
Extrapolation and Integration	3.7	rectangular	$\sqrt{3}$	1	1	2.1	2.1
Test Sample Positioning	2.3	normal	1	1	1	2.3	2.3
Device Holder Uncertainty	6.215	normal	1	1	1	6.215	6.215
Drift of Output Power	4.627	rectangular	$\sqrt{3}$	1	1	2.67	2.67
<b>Phantom and Setup</b>							
Phantom Uncertainty(shape & thickness tolerance)	3.4	rectangular	$\sqrt{3}$	1	1	2.0	2.0
Liquid Conductivity(target)	5.0	rectangular	$\sqrt{3}$	0.7	0.5	2.0	1.4
Liquid Conductivity(meas.)	1.938	normal	1	0.7	0.5	1.36	0.97
Liquid Permittivity(target)	5.0	rectangular	$\sqrt{3}$	0.6	0.5	1.7	1.4
Liquid Permittivity(meas.)	3.093	normal	1	0.6	0.5	1.86	1.55
Combined Uncertainty		RSS				10.78	10.55
Expanded uncertainty (coverage factor=2)		Normal(k=2)				21.56	21.10

## APPENDIX B – PROBE CALIBRATION CERTIFICATES

### NCL CALIBRATION LABORATORIES

Calibration File No.: PC-1598

Task No: BACL-5778

## CERTIFICATE OF CALIBRATION

It is certified that the equipment identified below has been calibrated in the  
**NCL CALIBRATION LABORATORIES** by qualified personnel following recognized  
procedures and using transfer standards traceable to NRC/NIST.

Equipment: Miniature Isotropic RF Probe

Record of Calibration

Head and Body

Manufacturer: APREL Laboratories

Model No.: E-020

Serial No.: 500-00283

Calibration Procedure: D01-032-E020-V2, D22-012-Tissue, D28-002-Dipole  
Project No: BACL-5745

Calibrated: 14<sup>th</sup> October 2014

Released on: 14<sup>th</sup> October 2014

This Calibration Certificate is Incomplete Unless Accompanied with the Calibration Results Summary

Released By: \_\_\_\_\_



Art Brennan, Quality Manager

### **NCL** CALIBRATION LABORATORIES

Suite 102, 303 Terry Fox Dr,  
OTTAWA, ONTARIO  
CANADA K2K 3J1

Division of APREL Lab.  
TEL: (613) 435-8300  
FAX: (613) 435-8306

## **NCL Calibration Laboratories**

Division of APREL Inc.

### **Introduction**

This Calibration Report reproduces the results of the calibration performed in line with the references listed below. Calibration is performed using accepted methodologies as per the references listed below. Probes are calibrated for air, and tissue and the values reported are the results from the physical quantification of the probe through meteorological practices.

### **Calibration Method**

Probes are calibrated using the following methods.

<800 MHz

TEM Cell for sensitivity in air

Standard phantom using temperature transfer method for sensitivity in tissue

>800 MHz

Waveguide\* method to determine sensitivity in air and tissue

\*Waveguide is numerically (simulation) assessed to determine the field distribution and power

The boundary effect for the probe is assessed using a standard flat phantom where the probe output is compared against a numerically simulated series of data points

### **References**

- o IEEE Standard 1528:2013  
IEEE Recommended Practice for Determining the Peak Spatial-Average Specific Absorption Rate (SAR) in the Human Head from Wireless Communications Devices: Measurement Techniques
- o EN 62209-1:2006  
Human Exposure to RF Fields from hand-held and body-mounted wireless communication devices - Human models, instrumentation, and procedures - Part 1: Procedure to measure the Specific Absorption Rate (SAR) for hand-held mobile wireless devices
- o IEC 62209-2:2010  
Human exposure to RF fields from hand-held and body-mounted wireless devices - Human models, instrumentation, and procedures - Part 2: specific absorption rate (SAR) for wireless communication devices (30 MHz - 6 GHz)
- o TP-D01-032-E020-V2 E-Field probe calibration procedure
- o D22-012-Tissue dielectric tissue calibration procedure
- o D28-002-Dipole procedure for validation of SAR system using a dipole
- o IEEE 1309 Standard for Calibration of Electromagnetic Field Sensors and Probes, Excluding Antennas, from 9kHz to 40GHz

---

Page 2 of 10

This page has been reviewed for content and attested to on Page 2 of this document.

**NCL Calibration Laboratories**

Division of APREL Inc.

**Conditions**

Probe 500-00283 was a recalibration.

**Ambient Temperature of the Laboratory:** 22 °C +/- 1.5°C  
**Temperature of the Tissue:** 21 °C +/- 1.5°C  
**Relative Humidity:** < 60%

**Primary Measurement Standards**

Instrument	Serial Number	Cal due date
Tektronix USB Power Meter	11C940	May 14, 2015
Signal Generator HP 83640B	3844A00689	Feb 12, 2015

**Secondary Measurement Standards**

Network Analyzer Anritsu 37347C	002106	Feb. 20, 2015
---------------------------------	--------	---------------

**Attestation**

The below named signatories have conducted the calibration and review of the data which is presented in this calibration report.

**We the undersigned attest that to the best of our knowledge the calibration of this subject has been accurately conducted and that all information contained within the results pages have been reviewed for accuracy.**



Art Brennan, Quality Manager



Dan Brooks, Test Engineer

Page 3 of 10

This page has been reviewed for content and attested to on Page 2 of this document.

**NCL Calibration Laboratories**

Division of APREL Inc.

**Probe Summary**

<b>Probe Type:</b>	E-Field Probe E020
<b>Serial Number:</b>	500-00283
<b>Frequency:</b>	As presented on page 5
<b>Sensor Offset:</b>	1.56
<b>Sensor Length:</b>	2.5
<b>Tip Enclosure:</b>	Composite*
<b>Tip Diameter:</b>	< 2.9 mm
<b>Tip Length:</b>	55 mm
<b>Total Length:</b>	289 mm

\*Resistive to recommended tissue recipes per IEEE-1528

**Sensitivity in Air**

<b>Channel X:</b>	1.2 $\mu\text{V}/(\text{V}/\text{m})^2$
<b>Channel Y:</b>	1.2 $\mu\text{V}/(\text{V}/\text{m})^2$
<b>Channel Z:</b>	1.2 $\mu\text{V}/(\text{V}/\text{m})^2$
<b>Diode Compression Point:</b>	95 mV

---

Page 4 of 10  
This page has been reviewed for content and attested to on Page 2 of this document.



**NCL Calibration Laboratories**

Division of APREL Inc.

Calibration for Tissue (Head H, Body B)

Frequency	Tissue Type	Measured Epsilon	Measured Sigma	Standard Uncertainty (%)	Calibration Frequency Range (MHz)	Conversion Factor
450 H	Head	43.59	0.86	3.5	±50	5.7
450 B	Body	56.74	0.94	3.5	±50	5.8
750 H	Head	42.98	0.92	3.5	±50	6.0
750 B	Body	43.05	0.93	3.5	±50	5.5
835 H	Head	43.42	0.94	3.5	±50	5.9
835 B	Body	55.77	1.01	3.5	±50	5.9
900 H	Head	41.87	1.06	3.5	±50	6.0
900 B	Body	55.62	1.05	3.5	±50	5.9
1450 H	Head	X	X	X	X	X
1450 B	Body	X	X	X	X	X
1500 H	Head	X	X	X	X	X
1500 B	Body	X	X	X	X	X
1640 H	Head	X	X	X	X	X
1640 B	Body	X	X	X	X	X
1750 H	Head	38.23	1.38	3.5	±75	5.4
1750 B	Body	52.86	1.54	3.5	±75	5.3
1800 H	Head	X	X	X	X	X
1800 B	Body	X	X	X	X	X
1900 H	Head	40.20	1.38	3.5	±75	4.8
1900 B	Body	52.63	1.46	3.5	±75	4.5
2000 H	Head	X	X	X	X	X
2000 B	Body	X	X	X	X	X
2100 H	Head	X	X	X	X	X
2100 B	Body	X	X	X	X	X
2300 H	Head	X	X	X	X	X
2300 B	Body	X	X	X	X	X
2450 H	Head	37.26	1.84	3.5	±75	4.9
2450 B	Body	53.61	1.9	3.5	±75	4.3
3000 H	Head	X	X	X	X	X
3000 B	Body	X	X	X	X	X
3600 H	Head	37.49	3.16	3.5	±100	4.5
3600 B	Body	49.94	3.86	3.5	±100	4.0
5250 H	Head	35.51	4.78	3.5	±100	3.0
5250 B	Body	47.54	5.11	3.5	±100	2.8
5600 H	Head	36.05	5.15	3.5	±100	2.8
5600 B	Body	46.49	5.72	3.5	±100	2.2
5800 H	Head	45.99	6.01	3.5	±100	3.2
5800 B	Body	35.6	5.37	3.5	±100	2.5

**NCL Calibration Laboratories**

Division of APREL Inc.

**Boundary Effect:**

Uncertainty resulting from the boundary effect is less than 2.1% for the distance between the tip of the probe and the tissue boundary, when less than 0.58mm.

**Spatial Resolution:**

The spatial resolution uncertainty is less than 1.5% for 4.9mm diameter probe.  
 The spatial resolution uncertainty is less than 1.0% for 2.5mm diameter probe.

**DAQ-PAQ Contribution**

To minimize the uncertainty calculation all tissue sensitivity values were calculated using a load impedance of 5 MΩ.

**Probe Calibration Uncertainty**

Uncertainty component	Tolerance (±%)	Probability distribution	Divisor	Standard uncertainty (±%)
Incident or forward power	2.5	R	√3	1.44
Reflected power	2	R	√3	1.15
Liquid conductivity measurement	1	R	√3	0.58
Liquid permittivity measurement	1	R	√3	0.58
Liquid conductivity deviation	1.5	R	√3	0.87
Liquid permittivity deviation	1.5	R	√3	0.87
Frequency deviation	2.25	R	√3	1.30
Field homogeneity	2.5	R	√3	1.44
Field-probe positioning	2.5	R	√3	1.44
Field-probe linearity	1.55	R	√3	0.89
<b>Combined standard uncertainty</b>		<b>RSS</b>		<b>3.50</b>



**NCL Calibration Laboratories**

Division of APREL Inc.

**Receiving Pattern Air**

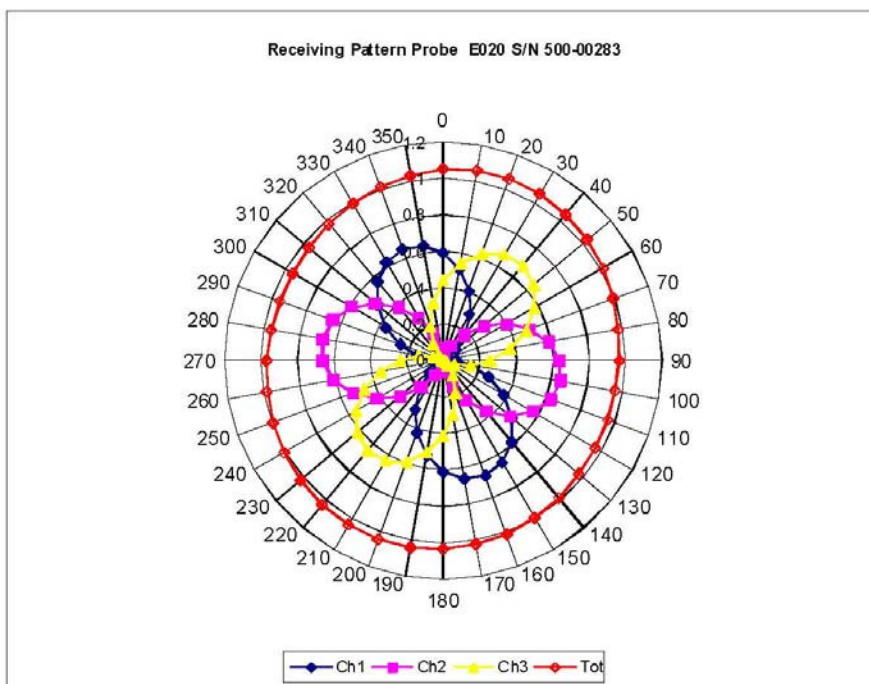

Page 7 of 10

This page has been reviewed for content and attested to on Page 2 of this document.

**NCL Calibration Laboratories**

Division of APREL Inc.

**Isotropy Error Air**

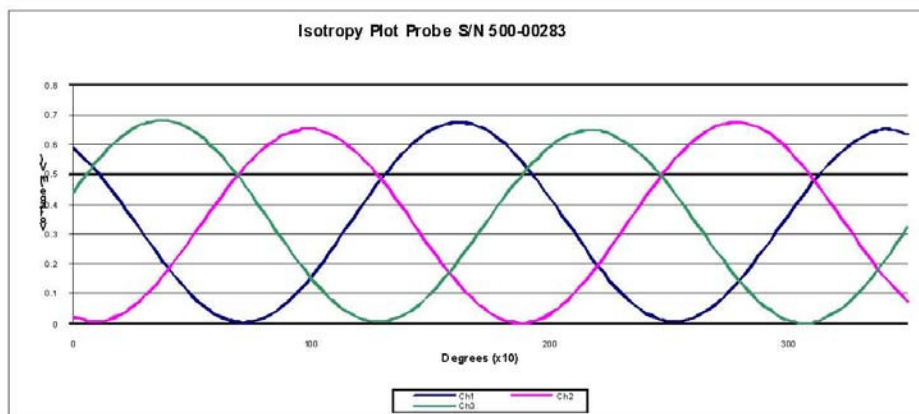
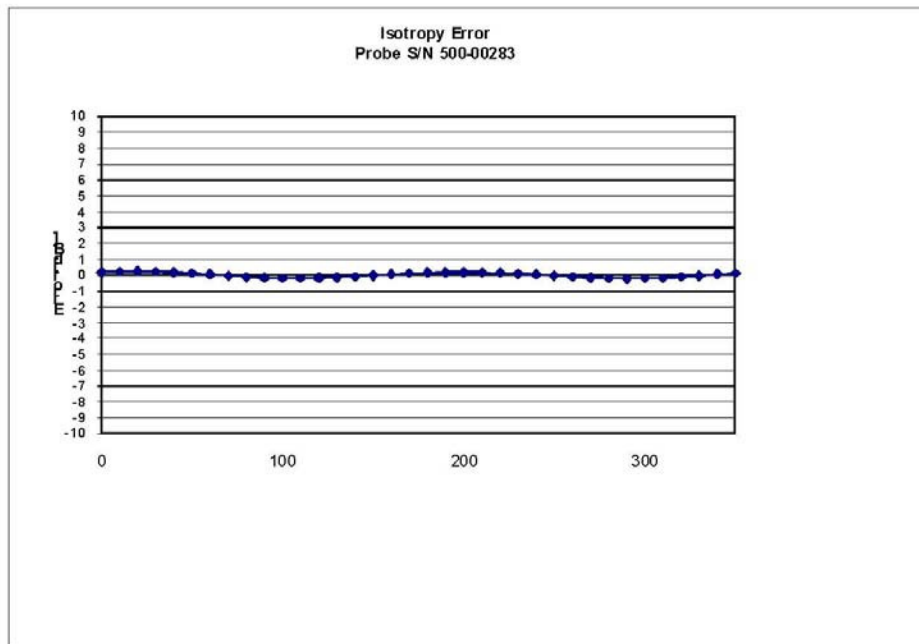

**Isotropicity Tissue: 0.10 dB**

Page 8 of 10  
This page has been reviewed for content and attested to on Page 2 of this document.

**NCL Calibration Laboratories**

Division of APREL Inc.

**Dynamic Range**

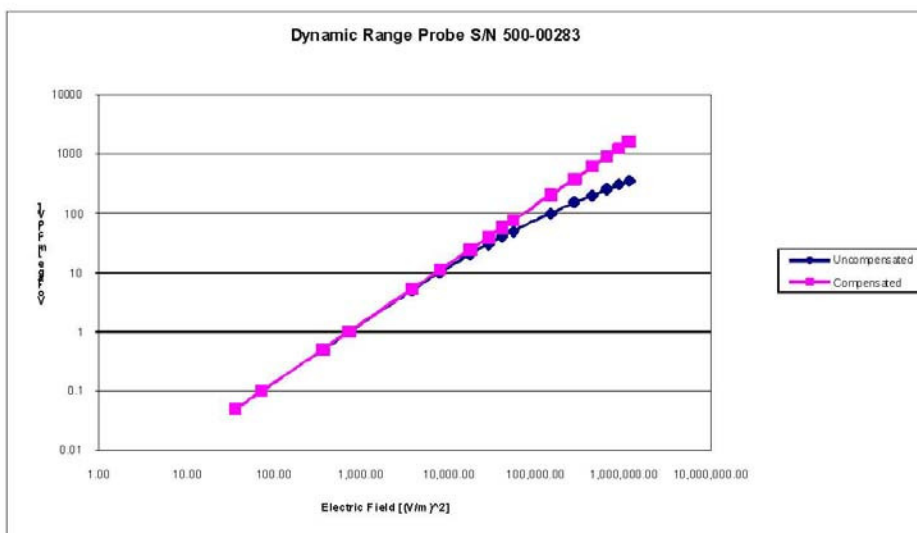

**NCL Calibration Laboratories**

Division of APREL Inc.

**Video Bandwidth**

**Probe Frequency Characteristics**

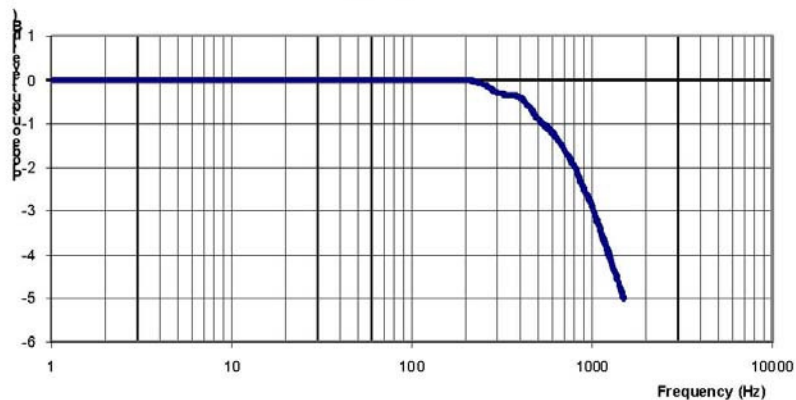

**Video Bandwidth at 500 Hz**                      1 dB  
**Video Bandwidth at 1.02 KHz:**                3 dB

**Test Equipment**

The test equipment used during Probe Calibration, manufacturer, model number and, current calibration status are listed and located on the main APREL server R:\NCL\Calibration Equipment\Instrument List May 2014.

---

Page 10 of 10  
This page has been reviewed for content and attested to on Page 2 of this document.

**ANNEX**

**PROBE ALS-E020 S/N 500-00283 CALIBRATION**

**Conditions**

Ambient Temperature of the laboratory: 20 °C +/- 1.5°C  
 Temperature of the Tissue: 21 °C +/- 1.5°C  
 Relative Humidity: < 55%

Frequency	Tissue Type	Measured Epsilon	Measured Sigma	Standard Uncertainty (%)	Calibration Frequency Range (MHz)	Conversion Factor
150 H	Head	50.6	0.78	3.5	±50	6.0
150 B	Body	60.8	0.82	3.5	±50	6.0

**Probe Calibration Uncertainty**

Uncertainty component	Tolerance (± %)	Probability distribution	Divisor	Standard uncertainty (± %)
Incident or forward power	2.5	R	√3	1.44
Reflected power	2	R	√3	1.15
Liquid conductivity measurement	1	R	√3	0.58
Liquid permittivity measurement	1	R	√3	0.58
Liquid conductivity deviation	1.5	R	√3	0.87
Liquid permittivity deviation	1.5	R	√3	0.87
Frequency deviation	2.25	R	√3	1.30
Field homogeneity	2.5	R	√3	1.44
Field-probe positioning	2.5	R	√3	1.44
Field-probe linearity	1.55	R	√3	0.89
<b>Combined standard uncertainty</b>		RSS		3.50

# APPENDIX C – DIPOLE CALIBRATION CERTIFICATES

**Calibration Laboratory of  
Schmid & Partner  
Engineering AG**  
Zeughausstrasse 43, 8004 Zurich, Switzerland



**S** Schweizerischer Kalibrierdienst  
**C** Service suisse d'étalonnage  
**S** Servizio svizzero di taratura  
**S** Swiss Calibration Service

Accredited by the Swiss Accreditation Service (SAS)  
The Swiss Accreditation Service is one of the signatories to the EA  
Multilateral Agreement for the recognition of calibration certificates

Accreditation No.: **SCS 108**

Client **BACL**

Certificate No: **CLA150-4004\_May14**

## CALIBRATION CERTIFICATE

Object	CLA150 - SN: 4004
Calibration procedure(s)	QA CAL-15.v8 Calibration procedure for system validation sources below 700 MHz
Calibration date:	May 08, 2014

This calibration certificate documents the traceability to national standards, which realize the physical units of measurements (SI).  
The measurements and the uncertainties with confidence probability are given on the following pages and are part of the certificate.

All calibrations have been conducted in the closed laboratory facility: environment temperature (22 ± 3)°C and humidity < 70%.

Calibration Equipment used (M&TE critical for calibration)

Primary Standards	ID #	Cal Date (Certificate No.)	Scheduled Calibration
Power meter E4419B	GB41293874	03-Apr-14 (No. 217-01911)	Apr-15
Power sensor E4412A	MY41498087	03-Apr-14 (No. 217-01911)	Apr-15
Reference 3 dB Attenuator	SN: S5054 (3c)	03-Apr-14 (No. 217-01915)	Apr-15
Reference 20 dB Attenuator	SN: S5058 (20k)	03-Apr-14 (No. 217-01918)	Apr-15
Type-N mismatch combination	SN: 5047.2 / 06327	03-Apr-14 (No. 217-01921)	Apr-15
Reference Probe EX3DV4	SN: 3877	06-Jan-14 (No. EX3-3877_Jan14)	Jan-15
DAE4	SN: 654	18-Jul-13 (No. DAE4-654_Jul13)	Jul-14
Secondary Standards	ID #	Check Date (in house)	Scheduled Check
RF generator HP 8648C	US3642U01700	04-Aug-99 (in house check Apr-13)	In house check: Apr-16
Network Analyzer HP 8753E	US37390585 S4206	18-Oct-01 (in house check Oct-13)	In house check: Oct-14

	Name	Function	Signature
Calibrated by:	Israe El-Naouq	Laboratory Technician	
Approved by:	Katja Pokovic	Technical Manager	

Issued: May 8, 2014

This calibration certificate shall not be reproduced except in full without written approval of the laboratory.



**Calibration Laboratory of  
Schmid & Partner  
Engineering AG**  
Zeughausstrasse 43, 8004 Zurich, Switzerland



**S** Schweizerischer Kalibrierdienst  
**C** Service suisse d'étalonnage  
**S** Servizio svizzero di taratura  
**S** Swiss Calibration Service

Accredited by the Swiss Accreditation Service (SAS)  
The Swiss Accreditation Service is one of the signatories to the EA  
Multilateral Agreement for the recognition of calibration certificates

Accreditation No.: **SCS 108**

**Glossary:**

TSL tissue simulating liquid  
ConvF sensitivity in TSL / NORM x,y,z  
N/A not applicable or not measured

**Calibration is Performed According to the Following Standards:**

- a) IEC 62209-2, "Procedure to measure the Specific Absorption Rate (SAR) for hand-held devices used in close proximity to the ear (frequency range of 300 MHz to 3 GHz)", February 2013
- b) KDB 865664, "SAR Measurement Requirements for 100 MHz to 6 GHz"

**Additional Documentation:**

- c) DASY4/5 System Handbook

**Methods Applied and Interpretation of Parameters:**

- *Measurement Conditions:* Further details are available from the Validation Report at the end of the certificate. All figures stated in the certificate are valid at the frequency indicated.
- *Antenna Parameters with TSL:* The source is mounted in a touch configuration below the center marking of the flat phantom.
- *Return Loss:* This parameter is measured with the source positioned under the liquid filled phantom (as described in the measurement condition clause). The Return Loss ensures low reflected power. No uncertainty required.
- *SAR measured:* SAR measured at the stated antenna input power.
- *SAR normalized:* SAR as measured, normalized to an input power of 1 W at the antenna connector.
- *SAR for nominal TSL parameters:* The measured TSL parameters are used to calculate the nominal SAR result.

The reported uncertainty of measurement is stated as the standard uncertainty of measurement multiplied by the coverage factor k=2, which for a normal distribution corresponds to a coverage probability of approximately 95%.

**Measurement Conditions**

DASY system configuration, as far as not given on page 1.

DASY Version	DASY5	V52.8.8
Extrapolation	Advanced Extrapolation	
Phantom	ELI4 Flat Phantom	Shell thickness: 2 ± 0.2 mm
EUT Positioning	Touch Position	
Zoom Scan Resolution	dx, dy, dz = 5.0 mm	
Frequency	150 MHz ± 1 MHz	

**Head TSL parameters**

The following parameters and calculations were applied.

	Temperature	Permittivity	Conductivity
Nominal Head TSL parameters	22.0 °C	52.3	0.76 mho/m
Measured Head TSL parameters	(22.0 ± 0.2) °C	49.9 ± 6 %	0.76 mho/m ± 6 %
Head TSL temperature change during test	< 0.5 °C	----	----

**SAR result with Head TSL**

SAR averaged over 1 cm <sup>3</sup> (1 g) of Head TSL	Condition	
SAR measured	1 W input power	3.79 W/kg
SAR for nominal Head TSL parameters	normalized to 1W	<b>3.75 W/kg ± 18.4 % (k=2)</b>

SAR averaged over 10 cm <sup>3</sup> (10 g) of Head TSL	condition	
SAR measured	1 W input power	2.51 W/kg
SAR for nominal Head TSL parameters	normalized to 1W	<b>2.49 W/kg ± 18.0 % (k=2)</b>

**Body TSL parameters**

The following parameters and calculations were applied.

	Temperature	Permittivity	Conductivity
Nominal Body TSL parameters	22.0 °C	61.9	0.80 mho/m
Measured Body TSL parameters	(22.0 ± 0.2) °C	62.5 ± 6 %	0.80 mho/m ± 6 %
Body TSL temperature change during test	< 0.5 °C	----	----

**SAR result with Body TSL**

SAR averaged over 1 cm <sup>3</sup> (1 g) of Body TSL	Condition	
SAR measured	1 W input power	3.80 W/kg
SAR for nominal Body TSL parameters	normalized to 1W	<b>3.81 W/kg ± 18.4 % (k=2)</b>

SAR averaged over 10 cm <sup>3</sup> (10 g) of Body TSL	condition	
SAR measured	1 W input power	2.55 W/kg
SAR for nominal Body TSL parameters	normalized to 1W	<b>2.55 W/kg ± 18.0 % (k=2)</b>



**Appendix****Antenna Parameters with Head TSL**

Impedance, transformed to feed point	45.5 $\Omega$ - 10.6 j $\Omega$
Return Loss	- 18.4 dB

**Antenna Parameters with Body TSL**

Impedance, transformed to feed point	46.0 $\Omega$ - 14.6 j $\Omega$
Return Loss	- 16.2 dB

**Additional EUT Data**

Manufactured by	SPEAG
Manufactured on	August 23, 2013

**DASY5 Validation Report for Head TSL**

Date: 08.05.2014

Test Laboratory: SPEAG, Zurich, Switzerland

**DUT: CLA150; Type: CLA150; Serial: CLA150 - SN: 4004**

Communication System: UID 0 - CW; Frequency: 150 MHz

Medium parameters used:  $f = 150$  MHz;  $\sigma = 0.76$  S/m;  $\epsilon_r = 49.9$ ;  $\rho = 1000$  kg/m<sup>3</sup>

Phantom section: Flat Section

Measurement Standard: DASY5 (IEEE/IEC/ANSI C63.19-2007)

DASY52 Configuration:

- Probe: EX3DV4 - SN3877; ConvF(11.76, 11.76, 11.76); Calibrated: 06.01.2014;
- Sensor-Surface: 2mm (Mechanical Surface Detection)
- Electronics: DAE4 Sn654; Calibrated: 18.07.2013
- Phantom: ELI v4.0; Type: QDOVA001BB; Serial: TP:1003
- DASY52 52.8.8(1222); SEMCAD X 14.6.10(7331)

**CLA Calibration for HSL-LF Tissue/CLA150, touch configuration, Pin=1W/Area Scan**

**(81x81x1):** Interpolated grid: dx=1.500 mm, dy=1.500 mm

Maximum value of SAR (interpolated) = 4.91 W/kg

**CLA Calibration for HSL-LF Tissue/CLA150, touch configuration, Pin=1W/Zoom Scan**

**(7x7x7)/Cube 0:** Measurement grid: dx=5mm, dy=5mm, dz=5mm

Reference Value = 80.11 V/m; Power Drift = -0.05 dB

Peak SAR (extrapolated) = 6.11 W/kg

**SAR(1 g) = 3.79 W/kg; SAR(10 g) = 2.51 W/kg**

Maximum value of SAR (measured) = 4.89 W/kg

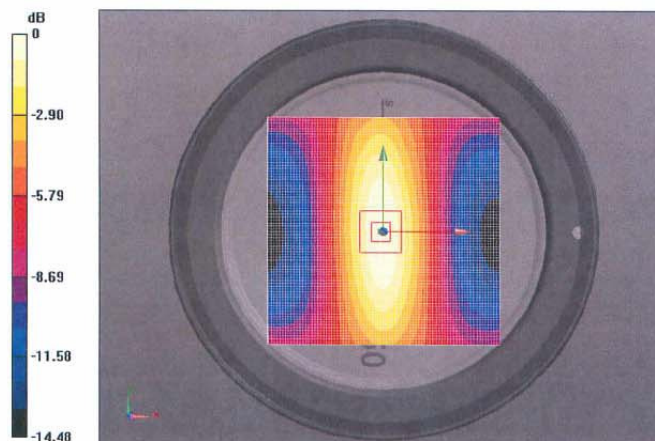

0 dB = 4.91 W/kg = 6.91 dBW/kg

### Impedance Measurement Plot for Head TSL

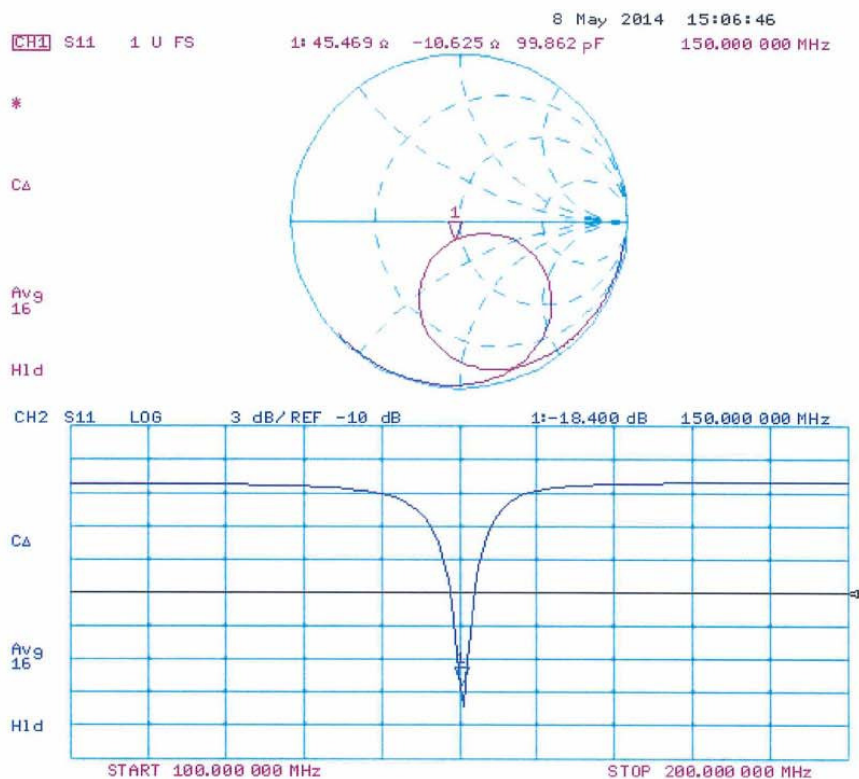

**DASY5 Validation Report for Body TSL**

Date: 08.05.2014

Test Laboratory: SPEAG, Zurich, Switzerland

**DUT: CLA150; Type: CLA150; Serial: CLA150 - SN: 4004**

Communication System: UID 0 - CW; Frequency: 150 MHz

Medium parameters used:  $f = 150$  MHz;  $\sigma = 0.8$  S/m;  $\epsilon_r = 62.5$ ;  $\rho = 1000$  kg/m<sup>3</sup>

Phantom section: Flat Section

Measurement Standard: DASY5 (IEEE/IEC/ANSI C63.19-2007)

DASY52 Configuration:

- Probe: EX3DV4 - SN3877; ConvF(11.45, 11.45, 11.45); Calibrated: 06.01.2014;
- Sensor-Surface: 2mm (Mechanical Surface Detection)
- Electronics: DAE4 Sn654; Calibrated: 18.07.2013
- Phantom: ELI v4.0; Type: QDOVA001BB; Serial: TP:1003
- DASY52 52.8.8(1222); SEMCAD X 14.6.10(7331)

**CLA Calibration for MSL-LF Tissue/CLA150, touch configuration, Pin=1W/Area Scan****(81x81x1):** Interpolated grid: dx=1.500 mm, dy=1.500 mm

Maximum value of SAR (interpolated) = 4.87 W/kg

**CLA Calibration for MSL-LF Tissue/CLA150, touch configuration, Pin=1W/Zoom Scan****(7x7x7)/Cube 0:** Measurement grid: dx=5mm, dy=5mm, dz=5mm

Reference Value = 77.84 V/m; Power Drift = -0.03 dB

Peak SAR (extrapolated) = 6.05 W/kg

**SAR(1 g) = 3.8 W/kg; SAR(10 g) = 2.55 W/kg**

Maximum value of SAR (measured) = 4.88 W/kg

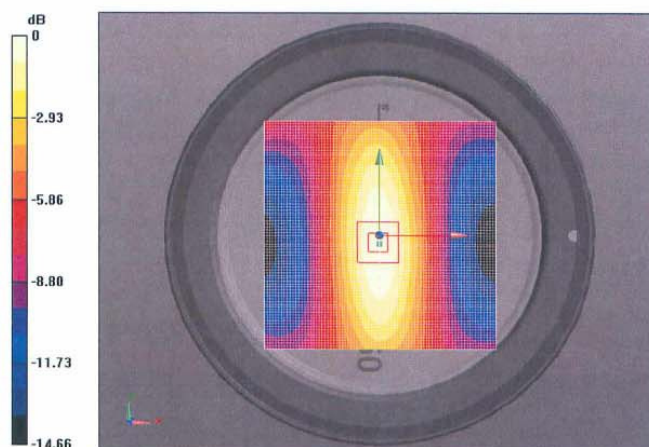

0 dB = 4.87 W/kg = 6.88 dBW/kg

### Impedance Measurement Plot for Body TSL

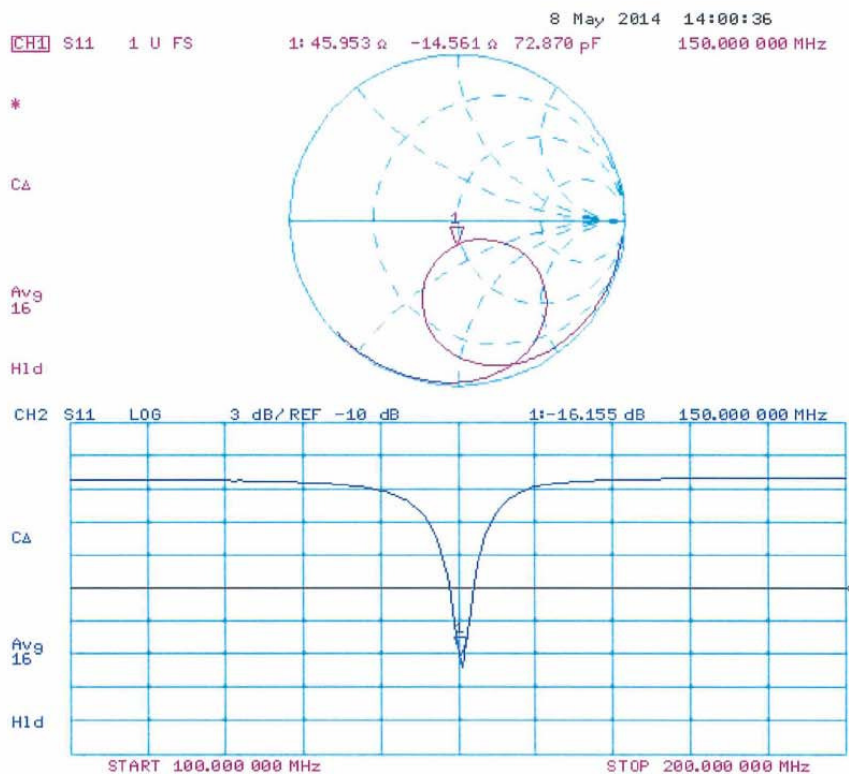



## APPENDIX D – EUT TEST POSITION PHOTOS

Liquid depth  $\geq 15\text{cm}$

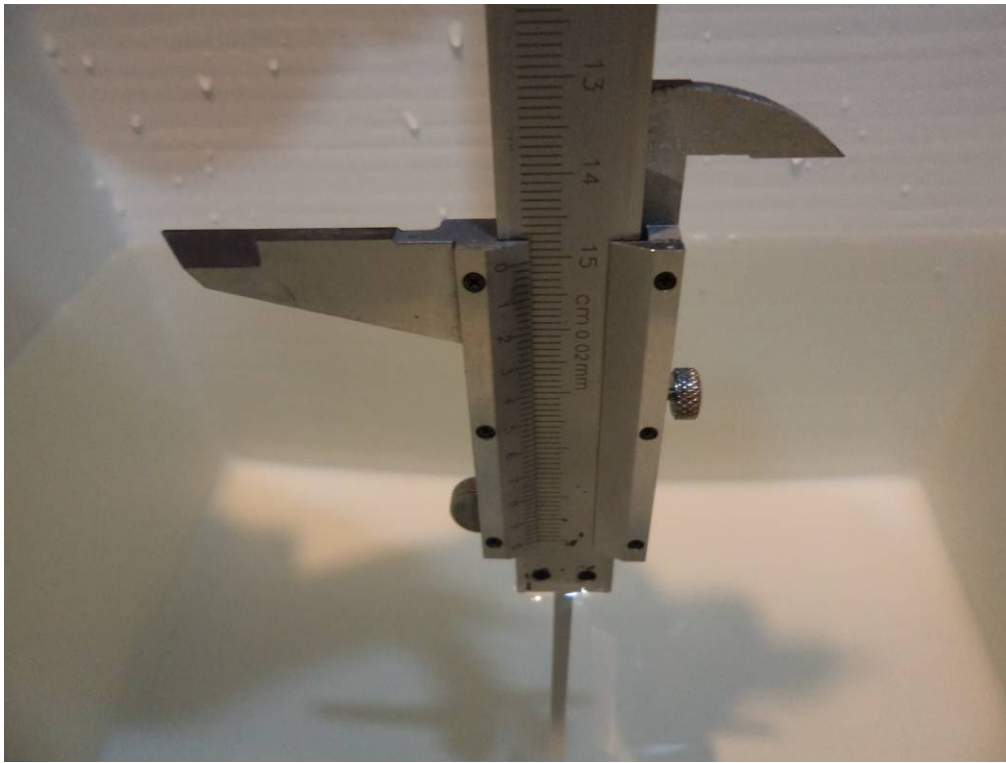

Face-Up 2.5 cm Separation to Flat Phantom Setup Photo

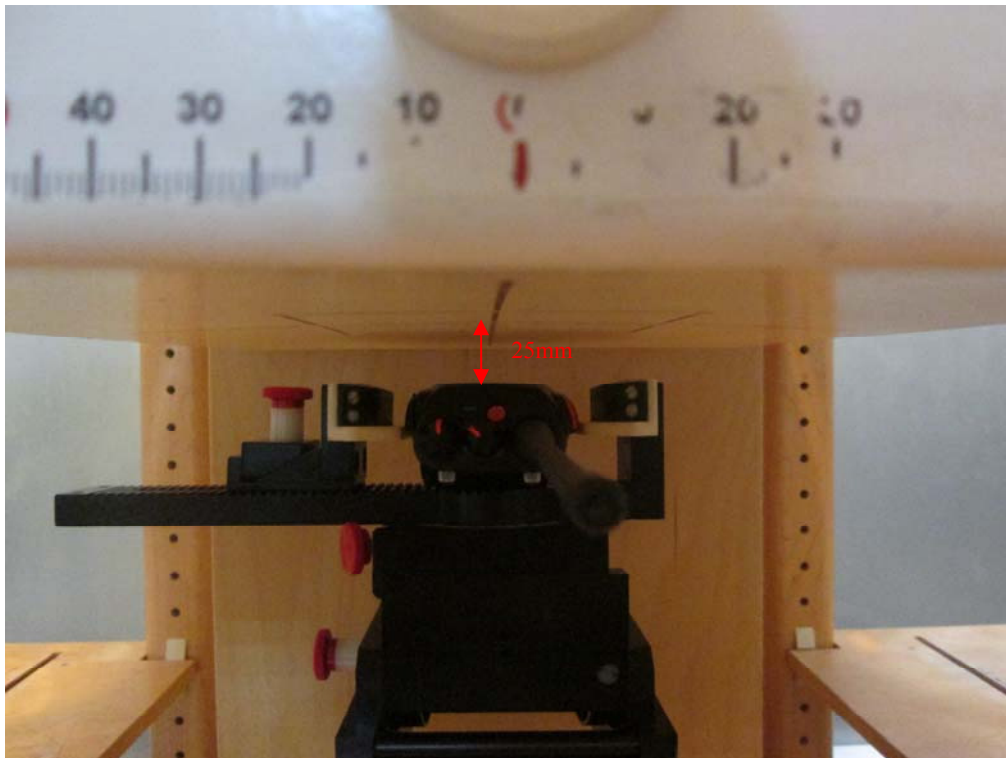

**Body-Back 0.0 cm Separation to Flat Phantom Setup Photo**

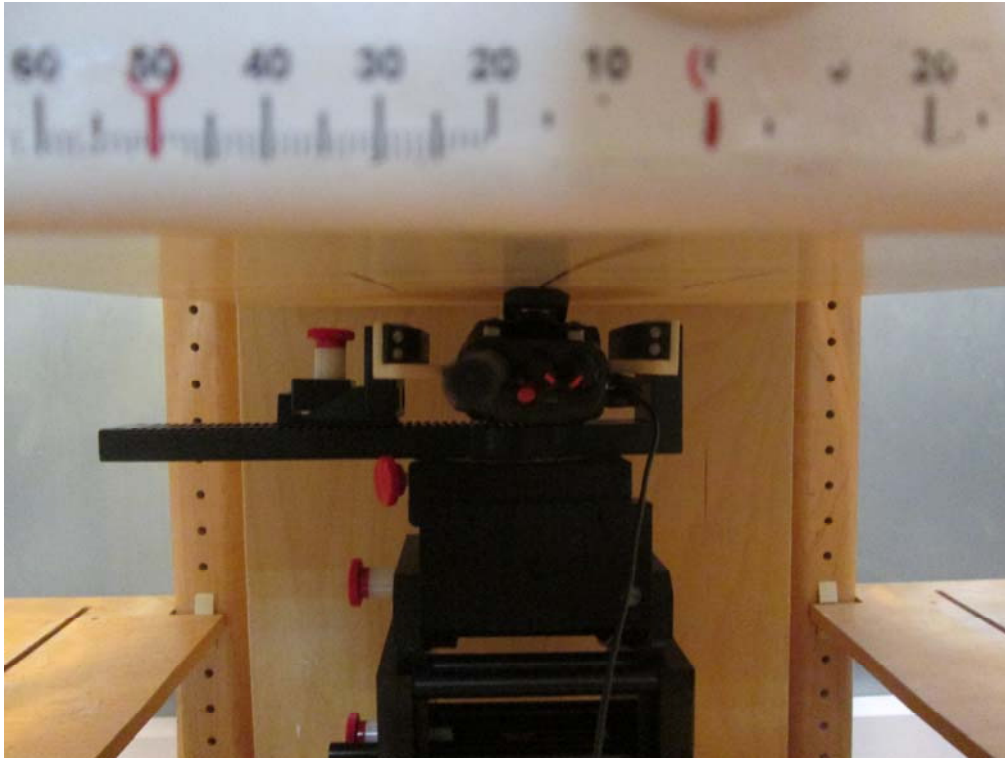

## APPENDIX E – EUT PHOTOS

---

**EUT – Front View**



**EUT – Back View**





**EUT – Left View**



**EUT – Right View**



**EUT – Top View**



**EUT – Bottom View**



**EUT – Uncovered View**



**Battery View**





**EUT – Antenna**



**EUT – Belt Clip**



## APPENDIX F – INFORMATIVE REFERENCES

---

- [1] Federal Communications Commission, "Report and order: Guidelines for evaluating the environmental effects of radiofrequency radiation", Tech. Rep. FCC 96-326, FCC, Washington, D.C. 20554, 1996.
- [2] David L. Means Kwok Chan, Robert F. Cleveland, "Evaluating compliance with FCC guidelines for human exposure to radiofrequency electromagnetic fields", Tech. Rep., Federal Communication Commission, Office of Engineering & Technology, Washington, DC, 1997.
- [3] Thomas Schmid, Oliver Egger, and Niels Kuster, "Automated E-field scanning system for dosimetric assessments", IEEE Transactions on Microwave Theory and Techniques, vol. 44, pp. 105-113, Jan. 1996.
- [4] Niels Kuster, Ralph Kastle, and Thomas Schmid, "Dosimetric evaluation of mobile communications equipment with known precision", IEEE Transactions on Communications, vol. E80-B, no. 5, pp. 645-652, May 1997.
- [5] CENELEC, "Considerations for evaluating of human exposure to electromagnetic fields (EMFs) from mobile telecommunication equipment (MTE) in the frequency range 30MHz - 6GHz", Tech. Rep., CENELEC, European Committee for Electrotechnical Standardization, Brussels, 1997.
- [6] ANSI, ANSI/IEEE C95.1-1992: IEEE Standard for Safety Levels with Respect to Human Exposure to Radio Frequency Electromagnetic Fields, 3 kHz to 300 GHz, The Institute of Electrical and Electronics Engineers, Inc., New York, NY 10017, 1992.
- [7] Katja Pokovic, Thomas Schmid, and Niels Kuster, "Robust setup for precise calibration of E-field probes in tissue simulating liquids at mobile communications frequencies", in ICECOM '97, Dubrovnik, October 15-17, 1997, pp. 120-24.
- [8] Katja Pokovic, Thomas Schmid, and Niels Kuster, "E-field probe with improved isotropy in brain simulating liquids", in Proceedings of the ELMAR, Zadar, Croatia, 23-25 June, 1996, pp. 172-175.
- [9] Volker Hombach, Klaus Meier, Michael Burkhardt, Eberhard Kuhn, and Niels Kuster, "The dependence of EM energy absorption upon human head modeling at 900 MHz", IEEE Transactions on Microwave Theory and Techniques, vol. 44, no. 10, pp. 1865-1873, Oct. 1996.
- [10] Klaus Meier, Ralf Kastle, Volker Hombach, Roger Tay, and Niels Kuster, "The dependence of EM energy absorption upon human head modeling at 1800 MHz", IEEE Transactions on Microwave Theory and Techniques, Oct. 1997, in press.
- [11] W. Gander, Computermathematik, Birkhaeuser, Basel, 1992.
- [12] W. H. Press, S. A. Teukolsky, W. T. Vetterling, and B. P. Flannery, Numerical Recipes in C, The Art of Scientific Computing, Second Edition, Cambridge University Press, 1992. Dosimetric Evaluation of Sample device, month 1998 9
- [13] NIS81 NAMAS, "The treatment of uncertainty in EMC measurement", Tech. Rep., NAMAS Executive, National Physical Laboratory, Teddington, Middlesex, England, 1994.
- [14] Barry N. Taylor and Christ E. Kuyatt, "Guidelines for evaluating and expressing the uncertainty of NIST measurement results", Tech. Rep., National Institute of Standards and Technology, 1994. Dosimetric Evaluation of Sample device, month 1998 10.
- [15] FCC OET KDB643646 SAR Test Reduction Considerations for Occupational PTT Radios.

\*\*\*\*\* END OF REPORT \*\*\*\*\*