



**WUS MOTO Gen3 HD
Mounting process**

Ref : **C 317 109 0000**
Version : **A1**

Distribution: Internal External
Status: Confidential Restricted Extended

Document is the property of LDL- Technology and cannot be reproduced or transmitted without written consent

TITLE: WUS MOTO Gen3 HD Mounting process

Reference : C 317 109 0000

Version A1



Internal Approval			
	<i>Author</i>	<i>Check</i>	<i>Approver</i>
Name and Department	L.LAFRANCHIS (MD)	D.LUCE (MD)	P. GABAUDAN (PL)
Date	28/08/2019	28/08/2019	28/08/2019
Signature			

Table des matières

<u>1.PURPOSE.....</u>	<u>4</u>
<u>2.TERMINOLOGY, ACRONYMS AND ABBREVIATIONS.....</u>	<u>4</u>
2.1.Terminology.....	4
2.2.Acronyms.....	4
<u>3.DESCRPTION.....</u>	<u>5</u>
<u>4.UTILISATION RULES.....</u>	<u>5</u>
4.1. Specifications.....	6
<u>5.WUS MOUNTING.....</u>	<u>6</u>
5.1.Precautions during mounting operation.....	6
5.2.WUS mounting.....	7
5.3.WUS screwing recommendations.....	8
5.4.Detailed views of WUS assembly.....	9
5.5.Method to verify the screwing torque.....	11
<u>6.TIRE MOUNTING.....</u>	<u>12</u>
6.1.Precautions.....	12
6.2.Mounting.....	12
<u>7.DISMOUNTING A TIRE EQUIPPED WITH A WUS.....</u>	<u>15</u>
<u>8.WUS DISMOUNTING.....</u>	<u>18</u>
8.1.Replacing valve seal.....	18
<u>9.REGULATIONS.....</u>	<u>19</u>

1. PURPOSE

This document describes the requirements for the mounting of WUS.

2. TERMINOLOGY, ACRONYMS AND ABBREVIATIONS

2.1. TERMINOLOGY

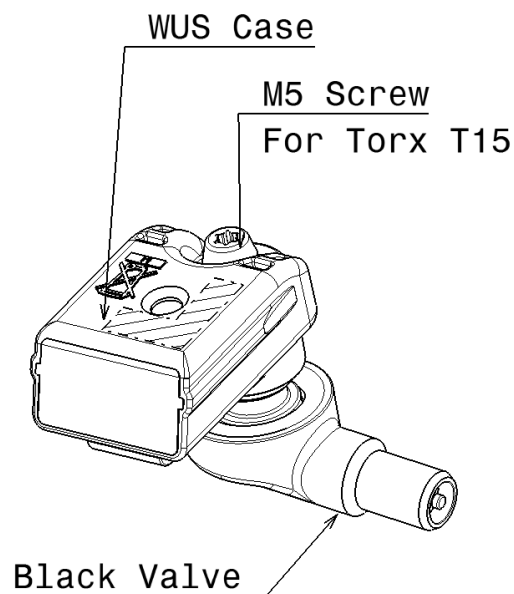

2.2. ACRONYMS

App	Approval
NA	Non Available
NR	Non Relevant
TBD	To Be Defined
TBC	To Be Confirmed
HW	Hardware
Q	Quality
SW	Software
RF	Radio Frequency
WUS	Wheel Unit Sensor
PL	Project Leader
WL	Wireless
MD	Mechanical Design

3. DESCRIPTION

The wheel unit sensor (WUS) is a pressure and temperature sensor composed with:

- A molded black plastic housing,
- A metal Screw M5 with Torx T15 head, with a captive washer.
- An anodized aluminum valve oriented at 90°; including an EPDM seal and a short core mechanism.

4. UTILISATION RULES

The Wheel Unit Sensor can be mounted on all Harley-Davidson motorcycle rims listed below :

- 40900528_20181127
- 40900594_20181127
- 43300533_20181127 (pending modification)
- 43300618_20181127
- T40900026_20181127
- T40900036_20181127
- T40900041_20181127
- T40900046_20181127
- T43300024_20181127
- T43300037_20181127
- T43300041_20181127
- T43300045_20181127

For other mounting interface ask to LDL the confirmation.

Typical mounting

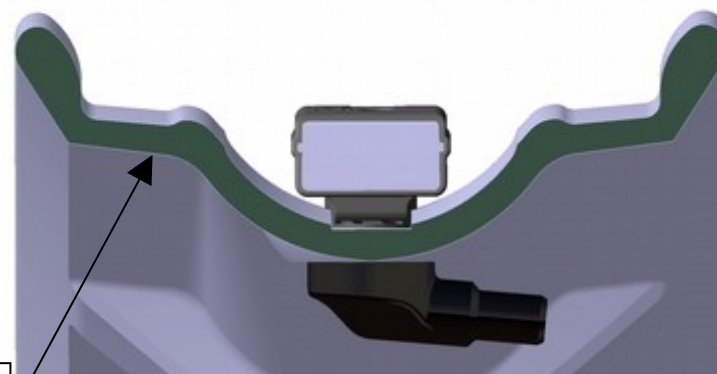

External part
of the rim

4.1. SPECIFICATIONS

Screwing torque for valve core mechanism:	0.3 +/- 0.1 Nm.
Screwing torque for valve cap:	0.2 to 0.35 Nm.
Manual screwing torque for T15 Screw:	2,1Nm +/- 0.1 Nm.
Operating Relative Pressure Range:	0 to 3,5 bars.
Relative Maximum pressure range non destructive:	0 to 10 bars
Compatible Inflating Fluid:	Air or Nitrogen
Anti-puncture Fluid utilisation:	Utilisation without any consequence. Just introduce Fluid when the valve is down, close to the ground
Maximum speed of the vehicle:	250 Km/h on rim 17"

NOTA :

Part 15 Clause 15.21 [Do not Modify warning]:

"Changes or modifications not expressly approved by the party responsible for compliance could void the user's authority to operate the equipment"

FCC Part 15.19(a) [interference compliance statement]:

"This device complies with part 15 of the FCC Rules. Operation is subject to the following two conditions: (1) This device may not cause harmful interference, and (2) this device must accept any interference received, including interference that may cause undesired operation."

5. WUS MOUNTING

5.1. PRECAUTIONS DURING MOUNTING OPERATION

- ◆ Do NOT use WUS after a drop of more than 1 meter on a hard ground
- ◆ Do NOT generate an electrostatic discharge higher than 6 Kilovolts by air onto the WUS, during mounting and disassembly of the WUS or at any time during utilization (avoid the use of nylon worksuit, and in general way, avoid all textile rubbing before handling WUS)
- ◆ Do NOT store WUS at temperatures higher than 30°C and lower than 0°C
- ◆ When removing the core from the valve, it has to be replaced by a new chromed short core (brass without chrome is forbidden) of the same type, according to V0.07.1 ETRTO core chamber specification.

- ◆ The valve cap must always be in place (except for inflating, pressure release or pressure checks).

5.2. WUS MOUNTING

- ◆ Check the external surface of the rim cleanness ; remove grits and other paint marks
- ◆ Orientation of the Wheel Unit Sensor on the rim: the WUS Case laser marked must be visible after mounting. Always use specific HD rims with pocket to receive the HD WUS case.
- ◆ The L Valve should be oriented right side of the motorbike to authorize an easy inflating when motorbike is on park stand.
- ◆ Shove the valve into the valve hole, the seal must face the rim.
- ◆ Maintain the WUS Case and push onto the valve when the keying with the valve is aligned (90° between housing and Valve).
- ◆ While screwing keep the WUS Case in place.

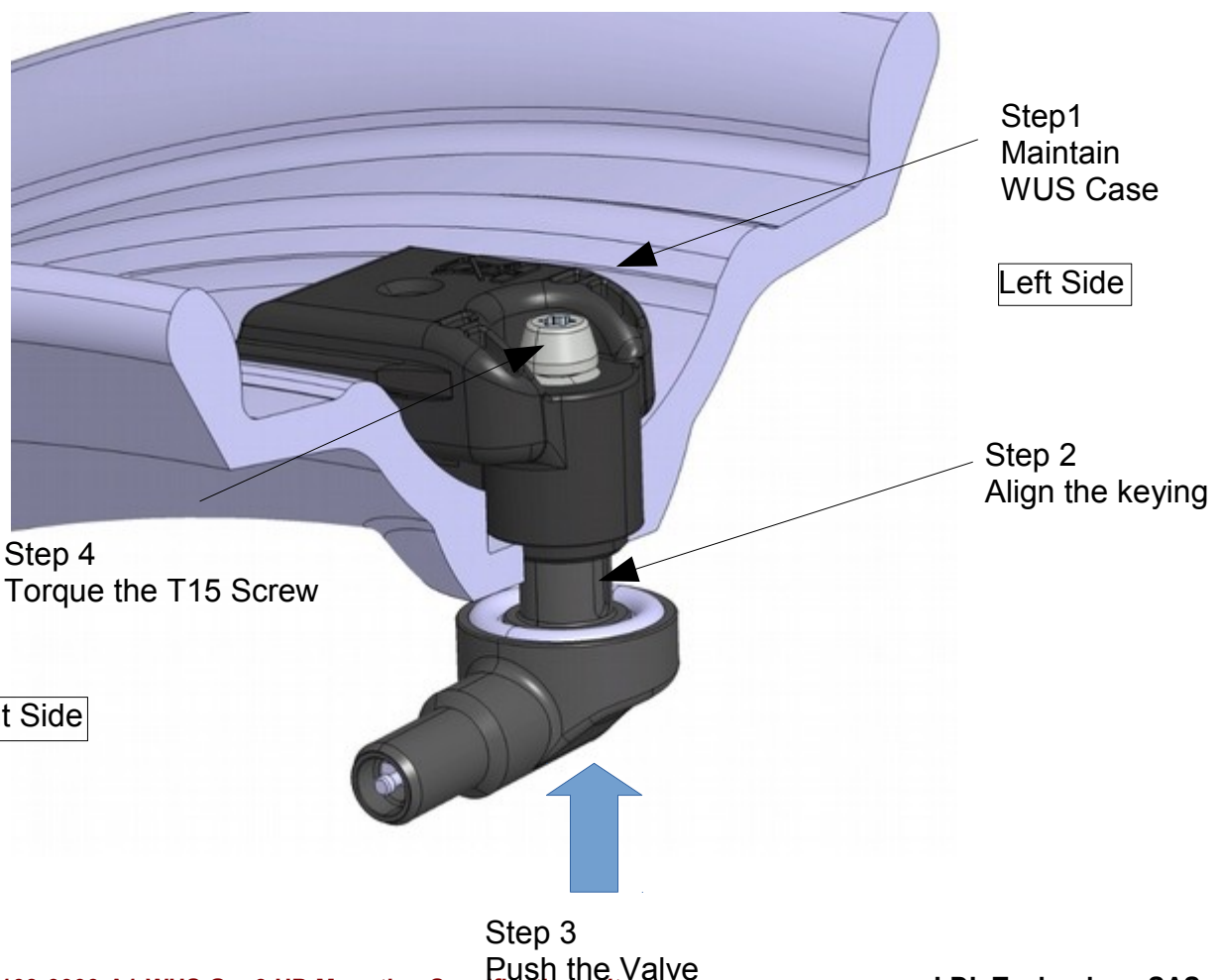

5.3. WUS SCREWING RECOMMENDATIONS

Make sure the following recommendations are respected :

Screwing speed : max of 2 turns in 1 second.

- ◆ Apply a torque of 2,1 Nm +/- 0,1 Nm with the good **screwing speed**.
- ◆ For the manual process please use a torque controlled tool.
- ◆ The valve and the screw have to be screwed on **3 complete threads (3 Screw T15 rounds) Minimum**,
- ◆ Under no circumstance the wus case has to be in contact with the rim surface. You must be able to introduce a feeler gauge between the sensor and the rim (minimum slack of 0,2mm is required).
- ◆ Once mounted, the WUS must be distant from the rim as illustrated here under ; the distance between them can reach 2mm.

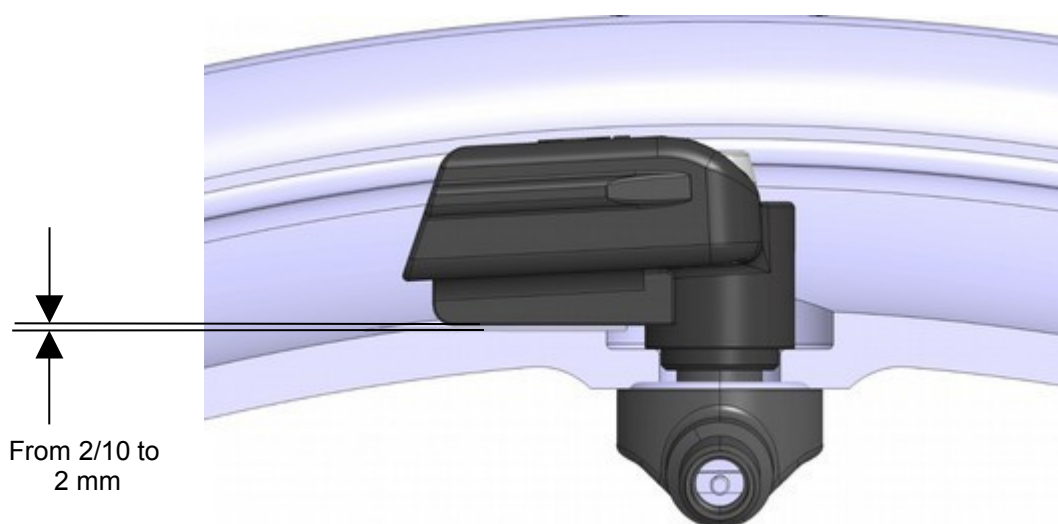

Document is the property of LDL-Technology and cannot be reproduced or transmitted without written consent

Electronic part. This part is situated inside the wheel

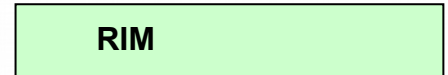
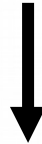
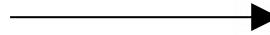

Valve including the seal ; is situated on the external part of the wheel

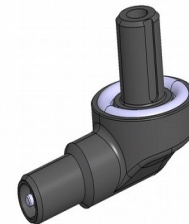
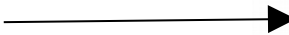

5.4. DETAILED VIEWS OF WUS ASSEMBLY

Step N° 1



The plastic round shape shall go inside the valve hole

Step N°2



The valve seal must face the rim valve hole on the external side.

Step N°3



Maintain the WUS Case and push on the valve (schema page 7).

Step N°4

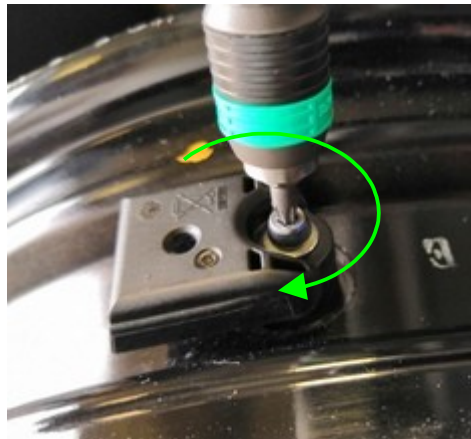

*- Torque the T15 Srew with a torque screwdriver (T15). Do note exceed 2 rounds per second.
- Final torque 2,1 Nm +/- 0,1 Nm.*

**Maintain WUS Case during screwing*

AVOID ANY SCREWING IF PLASTIC HOUSING IS IN CONTACT WITH THE RIM EXCEPT IN THE VALVE HOLE
(the introduction of feeler gauge 0,2mm between the rim and the plastic parts make you sure that there is no contact).

Step N°6

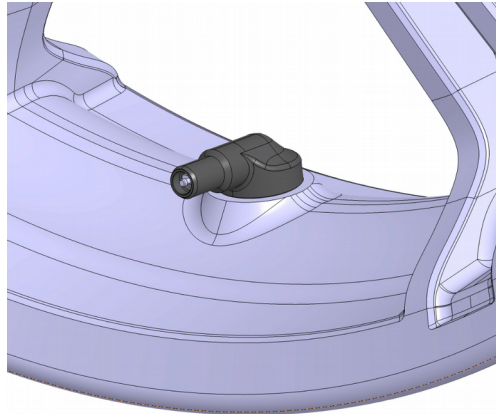

- Check that the external part of the valve does not meet any obstacle during rim rotation (like break system).

- Check that the external seal is correctly set and that the valve is in contact with the rim.

5.5. METHOD TO VERIFY THE SCREWING TORQUE

- ◆ The measurement of the residual torque is done by retightening the valve screw by a ¼ turn maximum in reduced speed (1/4 of a turn in 10 seconds). Therefore use a torque-controlled tool which is able to memorize the maximum torque. IF the torque mandatory to start the rotation of the screw in the measurement is equal to 2,1 Nm, stop the procedure, the Torque is correct.
- ◆ The retightening torque may not be smaller than 2 Nm.
- ◆ It is recommended to verify the screwing torque at each tire mounting.

6. TIRE MOUNTING

6.1. *PRECAUTIONS*

- ◆ Before any mounting operation of the tire, make sure that the Wheel Unit Sensor has been correctly mounted and tightened to the rim.
- ◆ The tire must be lubricated so as to facilitate its mounting. Respect manufacturer recommendations.
- ◆ ***NO lubrication product, tire ease or any other matter may partially or completely cover the pressure measuring hole or the inflation hole of the wheel unit. In general, it is forbidden to coat the wheel unit with a soap for tire mounting***
- ◆ The tire must never be allowed to put mechanical constraints onto the wheel unit sensor during the mounting operation; only a dynamic slide touch is acceptable, constant pressure stress is forbidden.
- ◆ Make sure that the tire does not get trapped between the rim and the wheel unit sensor during mounting procedure.
- ◆ It's mandatory to check the screwing torque before any tire mounting.

6.2. *MOUNTING*

- ◆ The bead of the tire must be engaged approximately 80° beyond the valve.
- ◆ Do not introduce a mounting tool between the valve and the point of engagement of the tire.
- ◆ Tire mounting must be done while ***moving away from the valve.***
- ◆ Beyond this point starts the final engagement operation, which finishes in the zone of the valve.
- ◆ During this phase, only fast sliding touch is allowed during final tire jumping onto the rim. Process to be validated by LDL Technology.

For manual mounting only – standard dealer shop machine

Document is the property of LDL-Technology and cannot be reproduced or transmitted without written consent



For clockwise tire mounting machine

First sidewall :

Step N°1



Start putting the tire on the rim on the opposite side of the valve

Step N°2



The first sidewall is now introduced

Second sidewall :

Step N°3

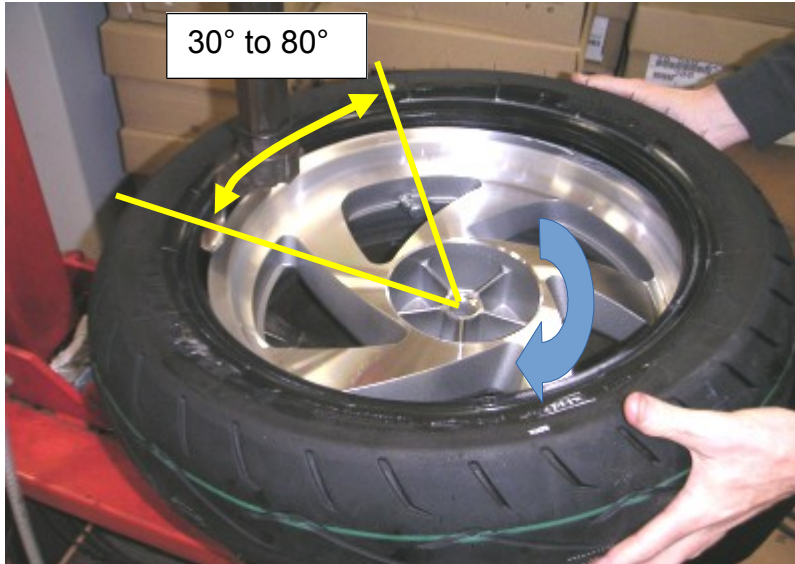

*Start introducing manually
the second sidewall
At almost 50° far away the
valve*

Step N°4



*At the end of the mounting process, the second
sidewall end climbing on the rim when the shoe
is in front of the valve*

7. DISMOUNTING A TIRE EQUIPPED WITH A WUS

- ◆ Before detaching the tire, make sure that the Wheel Unit Sensor is still correctly mounted and tightened on the rim, by checking that the valve is tightened.
- ◆ Before any introduction of tools between the tire and the rim, make sure that both sidewalls of the tire are completely detached from the rim.

For clockwise tire mounting machine

Step N°1



*Grip the tire with the press
at 50° minimum from the
valve*

Step N°2



*With a tire iron, raise the first
sidewall at 50° from the valve
according to scheme next page*

Scheme: Universal tire mounting and dismounting procedure

Document is the property of LDL-Technology and cannot be reproduced or transmitted without written consent

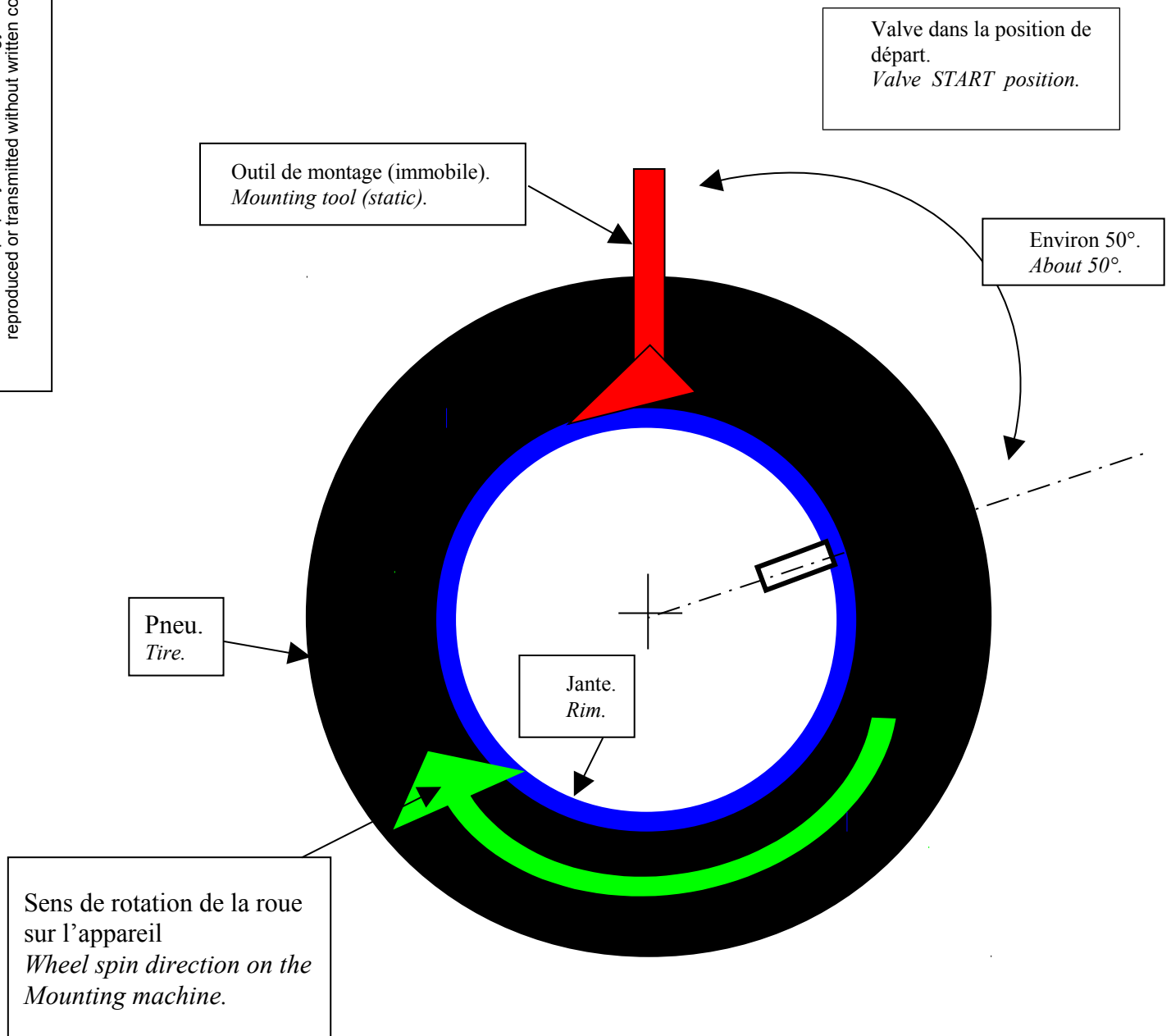

Step N°3



*Slide the tool head
under the tire*

Step N°4



*Then make the tire turn
to disengage the first sidewall*

Document is the property of LDL- Technology and cannot be reproduced or transmitted without written consent

Disassembly of the second sidewall.

Step N°5

Overview



Rear View

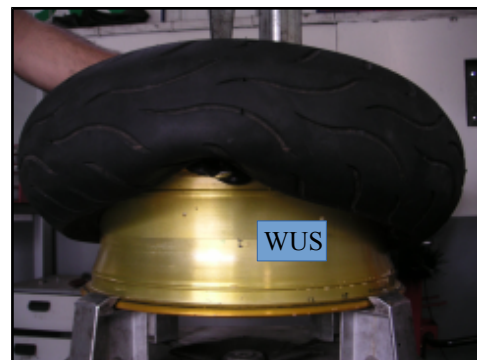

With a tire iron, raise the second sidewall at 50° from the valve

- ◆ Repeat the disassembly operations of the first sidewall until the tire is completely separated from the rim.
- ◆ **At any time the hand Tool or machine Tool must get in touch with the sensor.**

8. WUS DISMOUNTING

It is **MANDATORY** to interchange the seal if a complete disassembly of the WUS is done (if you change the rim for example), all unscrewing action on the T15 Screw is equivalent to a complete disassembly.

8.1. REPLACING VALVE SEAL

For the used valve seal dismounting, use a **PLASTIC TOOL** to disengage the seal from its case (in order to avoid damaging the valve).



Disengage the seal from its groove

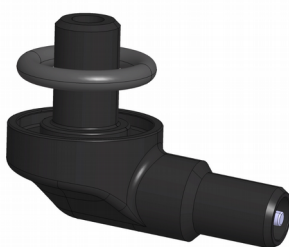

Slide the seal along the valve body



Remove the used seal



IT IS MANDATORY TO CHANGE THE VALVE IF THERE IS ANY SCRATCH OR HIT IN THIS AREA

NEW VALVE SEAL MOUNTING

- ◆ *Do not use lubricant, solvent, grease or oil.*
- ◆ *Check that the valve can be used again (no impact, no bending).*



Present the seal

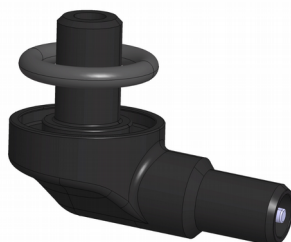

Shove the seal into the valve



Check that the seal is in its lower position

9. REGULATIONS

FCC:

“Changes or modifications not expressly approved by the manufacturer could void the user’s authority to operate the equipment”.

“This device complies with Part 15 of the FCC rules. Operation is subject to the following two conditions:

- (1) This device may not cause harmful interference, and
- (2) this device must accept any interference received, including interference that may cause undesired operation.”

IC:

“This device complies with Industry Canada licence-exempt RSS standard(s). Operation is subject to the following two conditions:

- (1) This device may not interference, and
- (2) this device must accept any interference, including interference that may cause undesired operation of the device.”

“Le présent appareil est conforme aux CNR d'Industrie Canada applicables aux appareils radio exempts de licence. L'exploitation est autorisée aux deux conditions suivantes :

- (1) l'appareil ne doit pas produire de brouillage, et
- (2) l'utilisateur de l'appareil doit accepter tout brouillage radioélectrique subi, même si le brouillage est susceptible d'en compromettre le fonctionnement.”

This device contains licence-exempt transmitter(s)/receiver(s) that comply with Innovation, Science and Economic Development Canada’s licence-exempt RSS(s). Operation is subject to the following two conditions:

This device may not cause interference.

This device must accept any interference, including interference that may cause undesired operation of the device.

L'émetteur/récepteur exempt de licence contenu dans le présent appareil est conforme aux CNR d'Innovation, Sciences et Développement économique Canada applicables aux appareils radio exempts de licence. L'exploitation est autorisée aux deux conditions suivantes :

L'appareil ne doit pas produire de brouillage;

L'appareil doit accepter tout brouillage radioélectrique subi, même si le brouillage est susceptible d'en compromettre le fonctionnement.