

Electromagnetic Compatibility

EMC Report

for



Description: Intrusion Detector

Model: ISP-PDL1-WA18G

Applicant: Bosch Security Systems

The test results contained in this report refer exclusively to the product(s) presented for testing. No liability may be assumed for models or products not referred to herein. This test report may not be published or duplicated in part without permission of the testing body. This test report by itself does not constitute authorization for the use of any TÜV Rheinland test mark. This report must not be used by the applicant to claim product endorsement by TÜV Rheinland, NVLAP or any agency of the U.S. Government.

TÜV Rheinland of North America, Inc., North American Headquarters, 12 Commerce Road, Newtown, CT 06470 - Tel (203)426-0888 - Fax (203)426-4009

Test Report Number:		30860166.001 G		Test Report Summary	
Prübericht Nr.:					
Applicant:	Bosch Security Systems	Tel: (585) 223-4060			
Auftraggeber:	130 Perinton Parkway	Fax: (585) 289-4263	Frank Mioduszewski		
	Fairport NY, 14450	e-mail: Leigh.Laughlin@us.bosch.com			
Type of Equipment:	Dual Technology Intrusion Detector				
Gegenstand der Prüfung:					
Model Numbers:	ISP-PDL1-WA18G		Trademark:	 BOSCH	
Bezeichnung:			Urprungszeichen:		
Standards:	See details below		Date Of Testing:	May 2008	
Prufgrundlage:					
Standard Number	Description	Severity Level or Limit	Measurement	Summary Result	
FCC Part 15.203	Antenna Requirement	Permanently Attached	NA	Complies	
FCC Part 15.245 / RSS -210 Issue 7	Field Strength	2500mV/m	15.52 mw	Complies	
FCC Part 15.215(c) / RSS-GEN Issue 2	Bandwidth	20dB	455kHz	Complies	
FCC Part 15.215(c)	Band Edge	Contained in band		Complies	
FCC Part 15.215(c)	Frequency Stability	-20°C to +50°C		Complies	
FCC Part 15.215(c)	Frequency Stability	Voltage Variations 85%, Nominal and 115%		Complies	
FCC Part 15.245(b)	Spurious Emissions	25 mV/m	21.13mV @ 31.575 GHz	Complies	
FCC 15.35	Duty Cycle		≤1%	Complies	
RSS-GEN 4.6.1	99% Bandwidth		2.52 MHz	Complies	
FCC §15.209(g) and 15.207(b)	Radiated Emissions and Conducted Emissions	Class A Class A	NA	Complies Complies	
AS/NZS	Radiated Emissions and Conducted Emissions	Class A Class A	NA	Complies Complies	
Place of Test:	TUV Rheinland of North America Inc.		 FOR THE SCOPE OF ACCREDITATION UNDER NVLAP LAB CODE: 200313-0		
Prüfart:	336 Initiative Drive, Building 5 Rochester, NY 14624				
	E-mail: info-new@tuv.com	Web: http://www.tuv.com			
	Phone: (585) 426-5555	Fax: (585) 568-8338			
Test Result:	Unit presented for testing complied with criteria shown above. Additional information is contained in the following pages.				
Prüfergebnis					
Tested By:	Randy Masline				
Der Sachverständige					
October 9, 2008 <hr/> Date, Signature Datum, Unterschrift					

The test results contained in this report refer exclusively to the product(s) presented for testing. No liability may be assumed for models or products not referred to herein. This test report may not be published or duplicated in part without permission of the testing body. This test report by itself does not constitute authorization for the use of any TÜV Rheinland test mark. This report must not be used by the applicant to claim product endorsement by TÜV Rheinland, NVLAP or any agency of the U.S. Government.



1. Table of Contents

1.	Table of Contents	3
2.	Measuring Equipment Used	4
2.1	Traceability	5
2.2	Calibration	6
2.3	Measurement Uncertainty	6
2.4	Location of original data	6
2.5	Status of facility used for testing	6
2.6	Software and templates	7
3.	Test Plan	8
4.	Description of Equipment Tested	8
4.1	Photo of EUT	8
4.2	General Description of Equipment	8
5.	Equipment Specifications	9
5.1	Technical Data	9
5.2	Antenna	9
5.3	Physical Data	9
6.	Reason for this Test	9
7.	Configuration and Mode of Operation	9
7.1	Configuration	9
7.2	Mode of Operation	9
8.	Performance Criteria	10
8.1	Pass Criteria	10
8.2	Fail Criteria	10
9.	Measurements	11
9.1	Conducted Emissions	11
9.2	Radiated Emissions	12
9.3	Field Strength	13
9.4	20dB Bandwidth	14
9.5	Occupied Bandwidth 99%	15
9.6	Band Edge	16
9.7	Duty Cycle of Pulsed Transmissions	17
10.	Test Plan Summary	19
10.1	Test Plan Overview	19
10.2	General description	19
10.3	Equipment Specifications	19
10.4	Configuration and Mode of Operation	20
APPENDIX A: TEST PLAN		18
APPENDIX B: TEST DATA		21
APPENDIX C: CONSTRUCTIONAL DATA FORM		35

The test results contained in this report refer exclusively to the product(s) presented for testing. No liability may be assumed for models or products not referred to herein. This test report may not be published or duplicated in part without permission of the testing body. This test report by itself does not constitute authorization for the use of any TUV Rheinland test mark. This report must not be used by the applicant to claim product endorsement by TUV Rheinland, NVLAP or any agency of the U.S. Government.

2. Measuring Equipment Used

Used	Ref #	Serial #	Manufacture	Model	Description	INT	Last Cal
	C004	1502	EMCO	3110	Biconical	365	15-Jun-07
	C005	1246	EMCO	3110	Biconical	365	17-Oct-06
	C010	4558	EMCO	3104C	Biconical	365	11-Dec-06
	C018	1006	Chase	CBL 6121	BiLog	0	N/A
	C019	1005	Chase	CBL 6121	BiLog	0	N/A
		2125	Chase	CBL6112A	BiLog	0	N/A
X		1169	Chase	CBL111	BiLog	730	29-June-07
X		1170	Chase	CBL111	BiLog	730	29-June-07
	C023	1369	EMCO	3147	Log Periodic	365	22-Sep-06
	C024	1370	EMCO	3147	Log Periodic	365	22-Nov-06
	C025	9512-4630	EMCO	3115	Horn	730	14-Jun-06
X	C031	9812-5635	EMCO	3115	Horn	365	08-Dec-06
	C032	9203-3389	EMCO	3146	Log Periodic Antenna	365	17-May-06
X	C102	200	Schwarzbeck	8121-200	LISN	365	21-Nov-06
	C111	131	Schwarzbeck	8121-131	LISN	730	13-Oct-06
X	C114	128	Schwarzbeck	8128-128	LISN	730	20-Sep-06
	C200	1495	Schaffner	NSG 435	ESD Simulator	365	11-Sep-07
	C210		California Instruments	MDL 225500L/5	Precision Power Source	0	N/A
	C211	8992	Voltech	PM3000A	Power Analyzer	365	29-Mar-07
	C212	A295-0497	IFI	M75	Wideband (.01-230)	0	N/A
	C213	112223122	Marconi	2024	Signal Generator	365	20-Oct-06
	C214	312A04354	HP	8657A	Signal Generator	365	14-Nov-06
	C215	3125010240	HP	437B	Power Meter	365	14-Nov-06
	C219	049-4146	IFI	PS 5000/28/40	Power Supply & Control Module	0	N/A
	C220	0492-4146	IFI	M5580	Wideband Amp (.01-1000)	0	N/A
	C221	106	FCC	FCC-801-M3-32	Coupling Decoupling 1 PH	365	20-Dec-06
	C222	108	FCC	FCC-801-M5-32	Coupling Decoupling 3PH	365	20-Dec-06
	C223		JFW		Attenuator 6dB (0-1000MHz) 100W	0	N/A
	C224	5326		62630	Directional Coupler	0	N/A
	C225	752/753	FCC	801-150-50 CDN	CDN Adapter Kit	365	20-Dec-06
	C226	135	FCC	801-2031-CF	Calibration Fixture	365	20-Dec-06
	C227	259	FCC	F-2031	EM Injection Clamp	365	21-Dec-06
	C228	2245-1296	IFI	5000/28/40	PS/Control Module	0	N/A
	C229	2244-1296	IFI	CMX5001	Wideband Amp	0	N/A
	C230	2265-1296	IFI	LPA-5B	Leveling PreAmplifier	0	N/A
	C231	12728	Amplifier Research	FM1000	Field Monitor	0	N/A
		308114	Amplifier Research	FM5004	Field Monitor	0	N/A
	C240	1026	Schaffner	CPM9830	RF 900MHz Pulse Modulator	0	N/A
	C241		Haefely		Induction Coil (2.0m x 2.6m)	0	N/A
	C243	080-136-03	Haefely	MAG 100.1	Magnetic Field Test System	0	N/A
	C244		F.W.BELL	4080	Triaxial Field Meter	365	25-Apr-07
	C250	307360	Amplifier Research	15S1G3	Amplifier (.8-3GHz) 15W	365	N/A

The test results contained in this report refer exclusively to the product(s) presented for testing. No liability may be assumed for models or products not referred to herein. This test report may not be published or duplicated in part without permission of the testing body. This test report by itself does not constitute authorization for the use of any TÜV Rheinland test mark. This report must not be used by the applicant to claim product endorsement by TÜV Rheinland, NVLAP or any agency of the U.S. Government.



Used	Ref #	Serial #	Manufacture	Model	Description	INT	Last Cal
	C251	307343	Amplifier Research	DC7144A	Directional Coupler 0.8-4.2GHz	0	N/A
	C254	B010847	Tektronix	TDS 784C	Digitizing Oscilloscope 1GHz	365	16-Nov-06
	C255	305319	Amplifier Research	FP6001	Field sensor	365	10 Apr 07
	C256	MY41093835	Agilent	8482A	Power Sensor (100KHz-4.2GHz)	365	14-Nov-06
	C257	1828546	Gigatronix	8541B	Power Meter	356	18-Apr-07
	C258	1829770	Gigatronix	80350A	Peak Power Sensor	356	18-Apr-07
	C260	07005	FCC	FCC-801-M4-16	Coupling Decoupling 2 PH	365	26-Feb-07
	C261	07021	FCC	FCC-801-M3 -16	Coupling Decoupling 1 PH	365	26-Feb-07
X	C310	826006/015	Rohde & Schwarz	ESVS 30	EMI Receiver	365	17-Oct-06
X	C311	3325A00127	HP	8546A	Analyzer w RF Filter Section 85460A	365	06-Sep-06
	C320	839283/005	Rohde & Schwarz	ESI 40	Receiver (20Hz.-40G)	365	27-Jul-07
X	C321	100180	Rohde & Schwarz	ESIB 40	Receiver (20Hz-40GHz)	365	01-Nov-06
	C322	826006/002	Rohde & Schwarz	ESVS 30	EMI Receiver	365	18 Jul 06
X	C405		Fluke	87	Multimeter	356	16-Mar-07
	C410		Amprobe	RS-3	Clamp On Meter	365	17-Dec-06
	C413	76549	Rohde & Schwarz	MDS-21	Absorbing Clamp	365	14-Mar-06
	C418		Honeywell		Temp./Humidity Chart Recorder	365	11-Jan-06
	C419	639971	Honeywell		Temp./Humidity Chart Recorder	365	23-Jan-07
	C434		Fluke	80K-40	Passive HV Probe 100X	365	09-Jun-06
	C435	8010532	Tektronics	2430	Oscilloscope	365	14-Aug-07
	C437		Fluke	83	True RMS Multimeter	365	23-Oct-06
X	C438	3008A01842	Agilent	8449B	Amplifier (1-26.5 GHz.)	365	28-Mar-07
	C439	122002/001	Rohde & Schwarz	TS-PR18	Amplifier 1 - 18GHz	365	21-Dec-06
	C440	100195	Rohde & Schwarz	SMR40	Signal Generator (10M-40GHz)	365	12-Feb-07
	C441		Electro Mechanics		Control Antenna Mask B/13	365	24-May-06
	C442		Electro Mechanics		Control Turntable B/13	365	24-May-06
X	C444	40917	Davis	Perception II	Digital Pressure/Temp/RH	365	28-Dec-06
	C445	59890224	Fluke	87	Multimeter	356	13-Nov-06
	D004	3625A00356	HP	8546A	Analyzer w RF Filter Section 85460A	365	29-May-07
	D005	1891	Schaffner	NSG 435	ESD Gun	365	25-Aug-06
	D007	109	Schaffner	NSG2025	Fast Transient / Burst Generator	365	18-Sep-07
	D008	199930-007SC	Schaffner	NSG2050	Surge Immunity Test System	365	18-Sep-07
	D009	102	Schaffner	CDN 133	Pulse Coupling Network	365	24-Sep-07
		9904227	Keytec	CE Master	Fast Transient / Burst Generator	365	20-Mar-07

2.1 Traceability

All measurement equipment calibrations are traceable to NIST or where calibration is performed outside the United States, to equivalent nationally recognized standards organizations

The test results contained in this report refer exclusively to the product(s) presented for testing. No liability may be assumed for models or products not referred to herein. This test report may not be published or duplicated in part without permission of the testing body. This test report by itself does not constitute authorization for the use of any TUV Rheinland test mark. This report must not be used by the applicant to claim product endorsement by TUV Rheinland, NVLAP or any agency of the U.S. Government.

2.2 Calibration

Equipment requiring calibration is calibrated periodically by the manufacturer or according to manufacturer's specifications. Additionally all equipment is verified for proper performance on a regular basis using in house standards or comparisons.

2.3 Measurement Uncertainty

<input checked="" type="checkbox"/>	The estimated combined standard uncertainty for radiated emissions measurements is ± 4.6 dB.
<input checked="" type="checkbox"/>	The estimated combined standard uncertainty for conducted emissions measurements is ± 2.6 dB.

As described in QP09G002

2.4 Location of original data

The original copies of all test data taken during actual testing were either contained within the body of this report or were attached at Appendix B. The originals were delivered to the applicant. A copy has been retained in the TUV Rheinland file for certification follow-up purposes.

2.5 Status of facility used for testing

The TUV Rheinland of North America EMC test facility located at 336 Initiative Drive, Rochester, NY, USA is listed on the US Federal Communications Commission list of facilities approved to perform measurements.

The test results contained in this report refer exclusively to the product(s) presented for testing. No liability may be assumed for models or products not referred to herein. This test report may not be published or duplicated in part without permission of the testing body. This test report by itself does not constitute authorization for the use of any TUV Rheinland test mark. This report must not be used by the applicant to claim product endorsement by TUV Rheinland, NVLAP or any agency of the U.S. Government.

TUV Rheinland of North America, Inc., North American Headquarters, 12 Commerce Road, Newtown, CT 06470 - Tel (203)426-0888 - Fax (203)426-4009

2.6 Software and templates

List of Software and Templates used for EMC Testing

✓	Description	Type *	Version	File Name	Date	Author
<input checked="" type="checkbox"/>	EN55022 / FCC 15.107(b) Class A conducted emissions	A	A.01.45	E7415A	8-Mar-01	Agilent
<input type="checkbox"/>	EN55022 / FCC 15.107(a) Class B conducted emissions	A	A.01.45	E7415A	8-Mar-01	Agilent
<input type="checkbox"/>	EN55022A Conducted emissions for Telecom Class A	ET	20050413	CE22A_TELCO_xl t	13-Apr-05	Baldamus
<input type="checkbox"/>	EN55022B Conducted emissions for Telecom Class B	ET	A.01.45	E7415A	8-Mar-01	Agilent
<input type="checkbox"/>	EN55022A Conducted emissions for Telecom Class A for Category 5 Lan	ET	20050413	CE22A_TELCO_ CAT5.xlt	13-Apr-05	Baldamus
<input type="checkbox"/>	EN55022B Conducted emissions for Telecom Class B for Category 5 Lan	ET	20050413	CE22B_TELCO_ CAT5.xlt	13-Apr-05	Baldamus
<input type="checkbox"/>	EN55011 Class A conducted emissions Group 1	A	A.01.45	E7415A	8-Mar-01	Agilent
<input type="checkbox"/>	EN55011 Class A conducted emissions Group 2	ET	20050413	CE11_2A.xlt	13-Apr-05	Baldamus
<input type="checkbox"/>	EN55011 Class B conducted emissions Group 1	ET	20050413	CE11_1B.xlt	13-Apr-05	Baldamus
<input type="checkbox"/>	EN55011 Class B conducted emissions Group 2	ET	20050413	CE11_2B.xlt	13-Apr-05	Baldamus
<input type="checkbox"/>	EN55014 Conducted emissions	ET	20050413	CE14-1.xlt	13-Apr-05	Baldamus
<input type="checkbox"/>	EN55103-1 Magnetic Fields Emissions	ET	20050413	MagF55103.xlt	13-Apr-05	Baldamus
<input type="checkbox"/>	EN55014 Disturbance Power Measurements for Household and Similar Equipments	ET	20050413	DP14-1.xlt	13-Apr-05	Baldamus
<input type="checkbox"/>	CISPR12 Radiated Emissions	ET	20050413	CISPR12.xlt	13-Apr-05	Baldamus
<input checked="" type="checkbox"/>	EN55022 / FCC 15.109(b) Class A Radiated Emissions	ET	20050413	RE22_1A.xlt	13-Apr-05	Baldamus
<input type="checkbox"/>	EN55022 / FCC 15.109(g) Class B Radiated Emissions	ET	20050413	RE22_1B.xlt	13-Apr-05	Baldamus
<input type="checkbox"/>	EN55022 / FCC 15.109(b) Class A Radiated Emissions	A	A.01.45	E7415A	8-Mar-01	Agilent
<input type="checkbox"/>	EN55022 / FCC 15.109(g) Class B Radiated Emissions	ET	9.0.8948 SP-3	T200deltmp1.xls	2000	TUV Rheinland
<input type="checkbox"/>	EN55011 Class A Group 1 Radiated Emissions test	ET	9.0.8948 SP-3	T200deltmp1.xls	2000	TUV Rheinland
<input type="checkbox"/>	EN55011 Class B Group 1 Radiated Emissions test	ET	9.0.8948 SP-3	T200deltmp1.xls	2000	TUV Rheinland
<input type="checkbox"/>	EN55011 Class A Group 2 Radiated Emissions test	ET	20050413	RE11_2A.xlt	13-Apr-05	Baldamus
<input type="checkbox"/>	EN55011 Class B Group 2 Radiated Emissions test	ET	20050413	RE11_2B.xlt	13-Apr-05	Baldamus
<input type="checkbox"/>	IEC 61000-4-3 Radiated immunity test	AR	1.0	SW 1006	11/21/05	AR
<input type="checkbox"/>	IEC 61000-4-4 Burst (Fast Transient) test	S	Ver 5.00	Win 2025	19-Jan-05	Schaffner
<input type="checkbox"/>	IEC 61000-4-4 Burst (Fast Transient) test	K	Ver3.00	CEWare 32	4-Jun-98	Keytec
<input type="checkbox"/>	IEC 61000-4-5 Surge test	S	Ver 6.00	Win 2050	11-Jun-04	Schaffner
<input type="checkbox"/>	IEC 61000-4-6 Conducted immunity test	IFI	4.3b	IFI System 55	17 Dec-97	IFI
<input type="checkbox"/>	IEC 61000-4-11 Voltage dip/short Interruptions	CI	1.4	AC Source GUI	28-Mar-96	Cal. Inst.
<input type="checkbox"/>	IEC 61000-3-2 Harmonics	V	IEC1000-3	iec1000-3	3-Jul-04	Voltech.
<input type="checkbox"/>	IEC 61000-3-3 Flicker	V	IEC1000-3	iec1000-3	3-Jul-04	Voltech

- ET = Excel Template, A = Agilent (HP) Program, S= Schaffner Program, CI = California Instruments, H= Haefely Trench, CE= CE Master Program, V = Voltech, IFI, Instruments for Industry Inc. Program

The test results contained in this report refer exclusively to the product(s) presented for testing. No liability may be assumed for models or products not referred to herein. This test report may not be published or duplicated in part without permission of the testing body. This test report by itself does not constitute authorization for the use of any TÜV Rheinland test mark. This report must not be used by the applicant to claim product endorsement by TÜV Rheinland, NVLAP or any agency of the U.S. Government.

3. Test Plan

Refer to the test plan at appendix A.

4. Description of Equipment Tested

4.1 *Photo of EUT*



Front of Sensor

4.2 *General Description of Equipment*

The product is a dual-technology intrusion detector employing overlapping patterns of active microwave and passive infrared.

The test results contained in this report refer exclusively to the product(s) presented for testing. No liability may be assumed for models or products not referred to herein. This test report may not be published or duplicated in part without permission of the testing body. This test report by itself does not constitute authorization for the use of any TÜV Rheinland test mark. This report must not be used by the applicant to claim product endorsement by TÜV Rheinland, NVLAP or any agency of the U.S. Government.

TÜV Rheinland of North America, Inc., North American Headquarters, 12 Commerce Road, Newtown, CT 06470 - Tel (203)426-0888 - Fax (203)426-4009

5. Equipment Specifications

5.1 *Technical Data*

See Technical Data in the test plan at Appendix A.

5.2 *Antenna*

The patch antenna with a gain of 5.8 dBi is a PC daughter board permanently mounted and attached to the sensor motherboard.

See Photographs in the test plan at Appendix C

5.3 *Physical Data*

See Technical Data in the test plan at Appendix A.

6. Reason for this Test

New Product

7. Configuration and Mode of Operation

7.1 *Configuration*

The equipment was configured as shown in the test plan at appendix A.

7.2 *Mode of Operation*

The EUT was operated as described in the test plan at appendix A.

The test results contained in this report refer exclusively to the product(s) presented for testing. No liability may be assumed for models or products not referred to herein. This test report may not be published or duplicated in part without permission of the testing body. This test report by itself does not constitute authorization for the use of any TÜV Rheinland test mark. This report must not be used by the applicant to claim product endorsement by TÜV Rheinland, NVLAP or any agency of the U.S. Government.

8. Performance Criteria

8.1 *Pass Criteria*

For emissions tests, the EUT is considered to pass a test or standard if the measured level is less than or equal to the applicable limit.

8.2 *Fail Criteria*

For emissions tests, the EUT is considered to fail a test or standard if the measured level is greater than the applicable limit.

9. Measurements

9.1 Conducted Emissions

9.1.1 Test Basis

FCC 15.207(b)
ANSI C63.4
CNS 13438:2006

9.1.2 Test Specifications

Class A
FCC Part 15 Class A per section 15.207(b)

9.1.3 Test Procedure

Conducted emissions tests were performed using the procedures of ANSI C63.4 including methods for signal maximizations and EUT configuration. The photos included with the report show the EUT in its maximized configuration. The frequency range from 0.15 to 30 MHz was investigated for conducted emissions.

Conducted emissions were performed at AC230V/50Hz (For EN & AS/NZS compliance), at AC110V/60Hz (for FCC & IC compliance)

Conducted Emissions measurements were performed in the shielded room using procedures specified in the test plan and standard. The photographs at appendix C show the worst-case emissions configuration.

9.1.4 Deviations from Standard Test Procedures

None

9.1.5 Test Results

All final conducted emissions measurements, were below (in compliance with) the specified limits. The results of the conducted emissions measurements and the maximum emissions are shown in a table.

A plot and the tabulated data are at Appendix B.

9.2 Radiated Emissions

9.2.1 Test Basis

FCC 15.209(b)
EN 55022
ANSI C63.4

9.2.2 Test Specifications

Class A
FCC Part 15 Class A per section 15.109(b)

9.2.3 Test Procedure

Radiated emissions tests were performed using the procedures of ANSI C63.4 including methods for signal maximizations and EUT configuration.

Photos will be included with the report show the EUT in its maximized configuration.

Radiated emissions testing was first performed at a distance of 3 meters in the semi-anechoic chamber in order to identify the specific frequencies at which measurement should be made in the OATS. The photographs at appendix C show the worst-case emissions configuration. The EUT was then taken for measurements at 10 meters in OATS. The results of both tests can be found in appendix B.

9.2.4 Deviations from Standard Test Procedures

None

9.2.5 Test Results

All final radiated emissions measurements were below (in compliance) the limits.

The result of the preliminary (semi-anechoic chamber), final (OATS) measurements and the maximum emissions measurements are shown in a tables.

Plots and the tabulated data are at Appendix B.

9.3 Field Strength

9.3.1 Test Basis

FCC 15.245(b) and RSS-210 Issue 7
ANSI C63.4

9.3.2 Test Specifications

FCC Part 15.245(b)

9.3.3 Test Procedure

Radiated emissions tests were performed using the procedures of ANSI C63.4 including methods for signal maximizations and EUT configuration.

The EUT was placed on a wooden table 80cm in height at a distance of 3 Meters from the receive antenna. All 3 orthogonal positions were tested for the highest field strength measurement. The highest field strength measurement was calculated by adding antenna factors, amplifier gains and cable losses. The limit at 10.500 – 10.525 GHz is 2500 mV/m @ 3 Meters using an average detector.

9.3.4 Deviations from Standard Test Procedures

None

9.3.5 Test Results

All final field strength measurements were below (in compliance) the limits.

The test results contained in this report refer exclusively to the product(s) presented for testing. No liability may be assumed for models or products not referred to herein. This test report may not be published or duplicated in part without permission of the testing body. This test report by itself does not constitute authorization for the use of any TÜV Rheinland test mark. This report must not be used by the applicant to claim product endorsement by TÜV Rheinland, NVLAP or any agency of the United States Government.

TÜV Rheinland of North America, Inc., North American Headquarters, 12 Commerce Road, Newtown, CT 06470 - Tel (203)426-0888 - Fax (203)426-4009

9.4 20dB Bandwidth

9.4.1 Test Basis

FCC 15.215(c)
RSS-GEN
ANSI C63.4

9.4.2 Test Specifications

FCC Part 15.215(c)

9.4.3 Test Procedure

(c) Intentional radiators operating under the alternative provisions to the general emission limits, as contained in Sec. Sec. 15.217 through 15.257 and in Subpart E of this part, must be designed to ensure that the 20 dB bandwidth of the emission, or whatever bandwidth may otherwise be specified in the specific rule section under which the equipment operates, is contained within the frequency band designated in the rule.

9.4.4 Deviations from Standard Test Procedures

None

9.4.5 Test Results

All final 20dB Bandwidth measurements were below (in compliance) the limits.

9.5 Occupied Bandwidth 99%

9.5.1 Test Basis

FCC 15.202(a)
RSS-GEN
ANSI C63.4

9.5.2 Test Specifications

FCC Part 15.202(a)
RSS-GEN 4.6.1

9.5.3 Test Procedure

The transmitter shall be operated at its maximum carrier power measured under normal test conditions.

The span of the analyzer shall be set to capture all products of the modulation process, including the emission skirts. The resolution bandwidth shall be set to as close to 1% of the selected span as is possible without being below 1%. The video bandwidth shall be set to 3 times the resolution bandwidth. Video averaging is not permitted. Where practical, a sampling detector shall be used since a peak or, peak hold, may produce a wider bandwidth than actual.

The trace data points are recovered and are directly summed in linear terms. The recovered amplitude data points, beginning at the lowest frequency, are placed in a running sum until 0.5% of the total is reached and that frequency recorded. The process is repeated for the highest frequency data points. This frequency is recorded.

The span between the two recorded frequencies is the occupied bandwidth.

9.5.4 Deviations from Standard Test Procedures

None

9.5.5 Test Results

All final 99% Bandwidth measurements were below (in compliance) the limits.

9.6 **Band Edge**

9.6.1 **Test Basis**

FCC 15.2159(c)
RSS-GEN
ANSI C63.4

9.6.2 **Test Specifications**

FCC Part 15.215(c)

9.6.3 **Test Procedure**

(c) Intentional radiators operating under the alternative provisions to the general emission limits, as contained in Sec. Sec. 15.217 through 15.257 and in Subpart E of this part, must be designed to ensure that the 20 dB bandwidth of the emission, or whatever bandwidth may otherwise be specified in the specific rule section under which the equipment operates, is contained within the frequency band designated in the rule. section under which the equipment is operated. The requirement to contain the designated bandwidth of the emission within the specified frequency band includes the effects from frequency sweeping, frequency hopping and other modulation techniques that may be employed as well as the frequency stability of the transmitter over expected variations in temperature and supply voltage. If a frequency stability is not specified in the regulations, it is recommended that the fundamental emission be kept within at least the central 80% of the permitted band in order to minimize the possibility of out-of-band operation.

9.6.4 **Deviations from Standard Test Procedures**

None

9.6.5 **Test Results**

All final Band Edge measurements were within (in compliance) the limits.

The test results contained in this report refer exclusively to the product(s) presented for testing. No liability may be assumed for models or products not referred to herein. This test report may not be published or duplicated in part without permission of the testing body. This test report by itself does not constitute authorization for the use of any TUV Rheinland test mark. This report must not be used by the applicant to claim product endorsement by TUV Rheinland, NVLAP or any agency of the United States Government.

TUV Rheinland of North America, Inc., North American Headquarters, 12 Commerce Road, Newtown, CT 06470 - Tel (203)426-0888 - Fax (203)426-4009

9.7 Duty Cycle of Pulsed Transmissions

9.7.1 Test Basis

FCC 15.35(c)
ANSI C63.4
RSS-GEN

9.7.2 Test Specifications

FCC Part 15.35(c)
RSS-GEN 4.5

9.7.3 Test Procedure

(c) Unless otherwise specified, e.g. Sec. 15.255(b), when the radiated emission limits are expressed in terms of the average value of the emission, and pulsed operation is employed, the measurement field strength shall be determined by averaging over one complete pulse train, including blanking intervals, as long as the pulse train does not exceed 0.1 seconds. As an alternative (provided the transmitter operates for longer than 0.1 seconds) or in cases where the pulse train exceeds 0.1 seconds, the measured field strength shall be determined from the average absolute voltage during a 0.1 second interval during which the field strength is at its maximum value. The exact method of calculating the average field strength shall be submitted with any application for certification or shall be retained in the measurement data file for equipment subject to notification or verification.

9.7.4 Deviations from Standard Test Procedures

None

9.7.5 Test Results

All final Duty Cycle measurements were below (in compliance) the limits.

The test results contained in this report refer exclusively to the product(s) presented for testing. No liability may be assumed for models or products not referred to herein. This test report may not be published or duplicated in part without permission of the testing body. This test report by itself does not constitute authorization for the use of any TÜV Rheinland test mark. This report must not be used by the applicant to claim product endorsement by TÜV Rheinland, NVLAP or any agency of the United States Government.

TÜV Rheinland of North America, Inc., North American Headquarters, 12 Commerce Road, Newtown, CT 06470 - Tel (203)426-0888 - Fax (203)426-4009

APPENDIX A: TEST PLAN

**Electro-Magnetic Compatibility
Test Plan
For
Applicant: Bosch Security Systems Inc.
Models: ISP-PDL1-WA18G**

The test results contained in this report refer exclusively to the product(s) presented for testing. No liability may be assumed for models or products not referred to herein. This test report may not be published or duplicated in part without permission of the testing body. This test report by itself does not constitute authorization for the use of any TUV Rheinland test mark. This report must not be used by the applicant to claim product endorsement by TUV Rheinland, NVLAP or any agency of the United States Government.

TUV Rheinland of North America, Inc., North American Headquarters, 12 Commerce Road, Newtown, CT 06470 - Tel (203)426-0888 - Fax (203)426-4009

10. Test Plan Summary

Product Description: Intrusion Detectors

Models: ISP-PDL1-WA18G

Applicant: Bosch Security Stems
130 Perinton Parkway
Fairport NY, 14450

Tel: (585) 223-4060 Mr. Frank Mioduszewski

10.1 Test Plan Overview

The purpose of this testing is to meet the FCC and Industry Canada requirements for an Intentional Radiator operating at 10.525 Ghz.

10.2 General description

The products are dual-technology intrusion detectors employing overlapping patterns of active microwave and passive infrared.

10.3 Equipment Specifications

10.3.1 Technical Data

Input Voltage Rating:	Input Voltage 12VDC for EUT
Input Current Rating:	Input Current 5 milliamps Max
Frequency Rating	Input Frequency DC for EUT
Power Rating:	Transmit Power Rating 15.52 milliwatts

Voltage and frequency of supply during test: 120V/60Hz (for FCC), The EUT is supplied 12VDC power from the power panel operating at 120V/60Hz

10.3.2 Physical Data

EUT Dimensions:	69 cm x 136 mm x 58 mm
EUT Weight:	Weight 220 grams

EUT tested will be Configured as shown in the following diagram:

The test results contained in this report refer exclusively to the product(s) presented for testing. No liability may be assumed for models or products not referred to herein. This test report may not be published or duplicated in part without permission of the testing body. This test report by itself does not constitute authorization for the use of any TÜV Rheinland test mark. This report must not be used by the applicant to claim product endorsement by TÜV Rheinland, NVLAP or any agency of the United States Government.

TÜV Rheinland of North America, Inc., North American Headquarters, 12 Commerce Road, Newtown, CT 06470 - Tel (203)426-0888 - Fax (203)426-4009

10.4 Configuration and Mode of Operation

10.4.1 Configuration

DIAGRAM OF EQUIPMENT CONFIGURATION FOR TESTING

Legend:

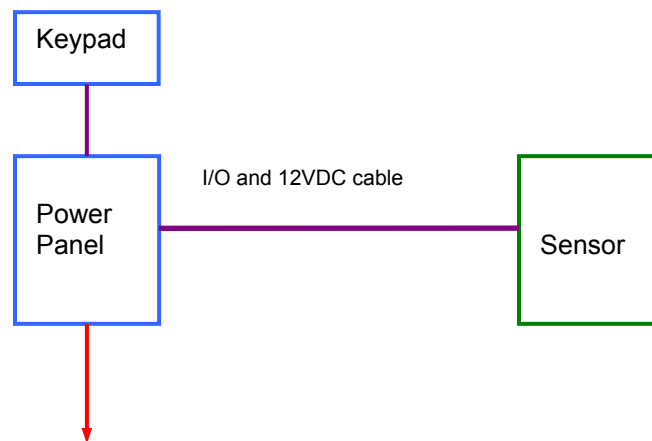
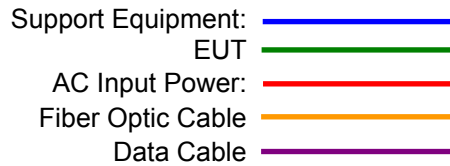

Cable Description	Length	Shielding	Tested Y/N
AC Power Cable	180 cm	Unshielded	Y
I/O and 12VDC Cable	>3m	NA	Y

Photographs of each setup shall be made and documented at appendix C. Emission tests setup shall show the worst-case configuration.

10.4.2 Mode of operation

Continuously scanning for movement

The test results contained in this report refer exclusively to the product(s) presented for testing. No liability may be assumed for models or products not referred to herein. This test report may not be published or duplicated in part without permission of the testing body. This test report by itself does not constitute authorization for the use of any TÜV Rheinland test mark. This report must not be used by the applicant to claim product endorsement by TÜV Rheinland, NVLAP or any agency of the United States Government.

APPENDIX B: TEST DATA

The test results contained in this report refer exclusively to the product(s) presented for testing. No liability may be assumed for models or products not referred to herein. This test report may not be published or duplicated in part without permission of the testing body. This test report by itself does not constitute authorization for the use of any TÜV Rheinland test mark. This report must not be used by the applicant to claim product endorsement by TÜV Rheinland, NVLAP or any agency of the United States Government.

TUV Rheinland of North America, Inc., North American Headquarters, 12 Commerce Road, Newtown, CT 06470 - Tel (203)426-0888 - Fax (203)426-4009

NOTES:

Radiated Emissions
110 VAC / 60 Hz

G Sensor Max hold low end - H

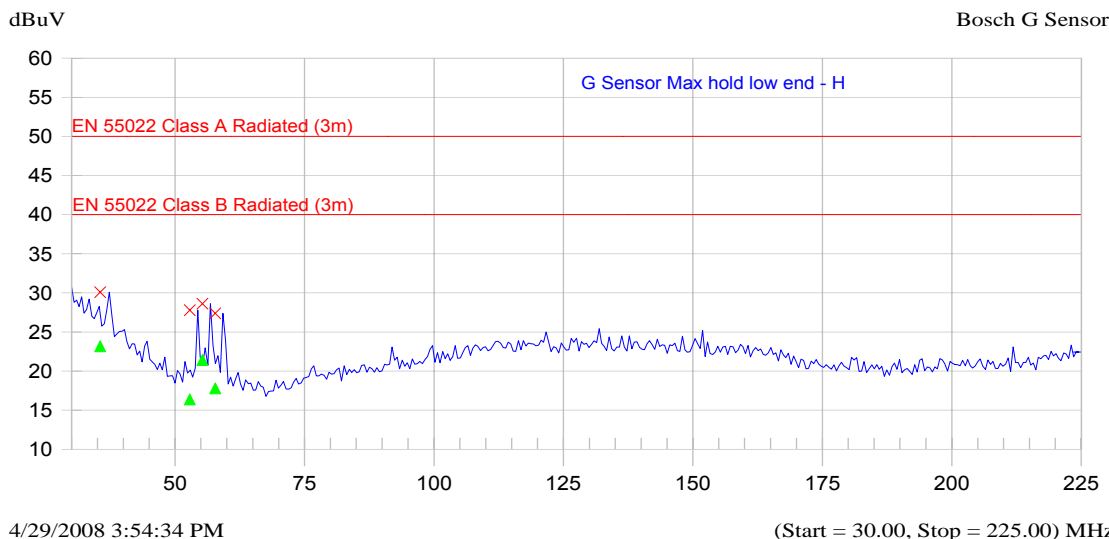

Frequency MHz	Peak dBuV	QP dBuV	Class B-QP dB	Class A-QP dB	Trace Name
35.549	30.1	23.2	-16.8	-26.8	G Sensor Max hold low end - H
52.854	27.8	16.4	-23.6	-33.6	G Sensor Max hold low end - H
55.299	28.6	21.4	-18.6	-28.6	G Sensor Max hold low end - H
57.761	27.4	17.8	-22.2	-32.2	G Sensor Max hold low end - H

ANTENNA/COUPLER:

- | | | | |
|---------------------------------------|---|---|--|
| <input type="checkbox"/> 9124 Bicon | <input type="checkbox"/> 3110 Bicon | <input type="checkbox"/> CBL6140 X-Wing | <input type="checkbox"/> NNB-4/63TL LISN |
| <input type="checkbox"/> 3147 Log Per | <input type="checkbox"/> 3115 Horn | <input type="checkbox"/> MDS-21 Clamp | <input type="checkbox"/> NNB-4/200X LISN |
| <input type="checkbox"/> 3106 Horn | <input checked="" type="checkbox"/> CBL6111 Bilog | <input type="checkbox"/> NSLK 8128 LISN | <input type="checkbox"/> NNLK 8121 LISN |

MEAS TYPE:

- Radiated Prescan
- Radiated Final
- Conducted
- Disturbance Power
- Other _____

POLARIZATION:

- Vertical
- Horizontal
- Line 1
- Line 2
- Line 3

DISTANCE:

- 3 Meter
- 10 Meter
- _____ Meter
- NA

LOCATION:

- OATS
- Semi-Anechoic
- Shielded Room
- Factory Floor
- Other _____

The test results contained in this report refer exclusively to the product(s) presented for testing. No liability may be assumed for models or products not referred to herein. This test report may not be published or duplicated in part without permission of the testing body. This test report by itself does not constitute authorization for the use of any TÜV Rheinland test mark. This report must not be used by the applicant to claim product endorsement by TÜV Rheinland, NVLAP or any agency of the United States Government.

NOTES:

**Radiated Emissions
110 VAC / 60 Hz**

G Sensor Max hold low end - V

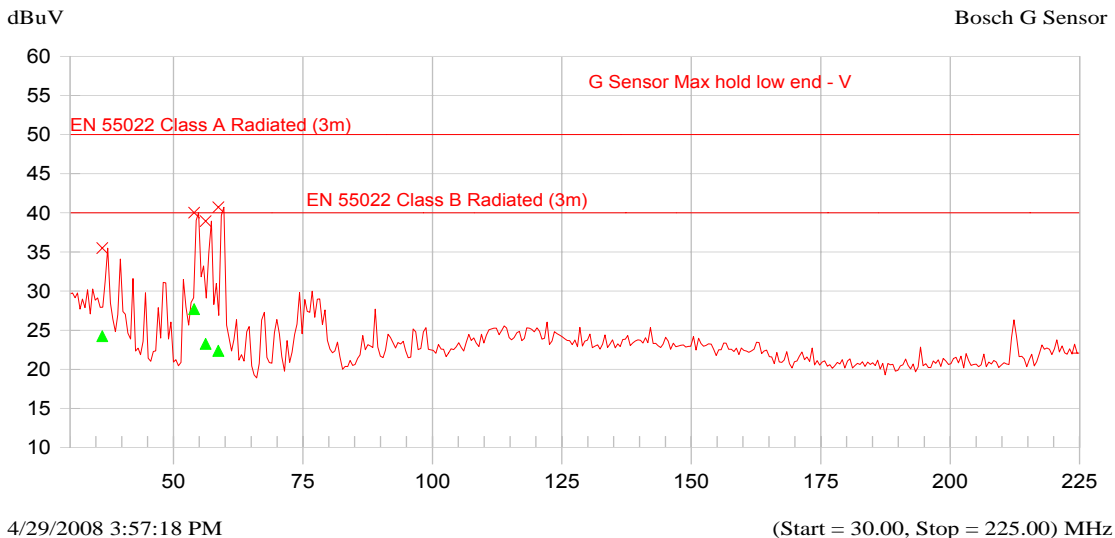

Frequency MHz	Peak dBuV	QP dBuV	Class B-QP dB	Class A-QP dB	Trace Name
36.247	35.5	24.2	-15.8	-25.8	G Sensor Max hold low end - V
53.968	40.0	27.7	-12.3	-22.3	G Sensor Max hold low end - V
56.225	38.9	23.3	-16.7	-26.7	G Sensor Max hold low end - V
58.669	40.7	22.4	-17.6	-27.6	G Sensor Max hold low end - V

ANTENNA/COUPLER:

- | | | | |
|---------------------------------------|---|---|--|
| <input type="checkbox"/> 9124 Bicon | <input type="checkbox"/> 3110 Bicon | <input type="checkbox"/> CBL6140 X-Wing | <input type="checkbox"/> NNB-4/63TL LISN |
| <input type="checkbox"/> 3147 Log Per | <input type="checkbox"/> 3115 Horn | <input type="checkbox"/> MDS-21 Clamp | <input type="checkbox"/> NNB-4/200X LISN |
| <input type="checkbox"/> 3106 Horn | <input checked="" type="checkbox"/> CBL6111 Bilog | <input type="checkbox"/> NSLK 8128 LISN | <input type="checkbox"/> NNLK 8121 LISN |

MEAS TYPE:

- Radiated Prescan
- Radiated Final
- Conducted
- Disturbance Power
- Other _____

POLARIZATION:

- Vertical
- Horizontal
- Line 1
- Line 2
- Line 3

DISTANCE:

- 3 Meter
- 10 Meter
- _____ Meter
- NA

LOCATION:

- OATS
- Semi-Anechoic
- Shielded Room
- Factory Floor
- Other _____

The test results contained in this report refer exclusively to the product(s) presented for testing. No liability may be assumed for models or products not referred to herein. This test report may not be published or duplicated in part without permission of the testing body. This test report by itself does not constitute authorization for the use of any TÜV Rheinland test mark. This report must not be used by the applicant to claim product endorsement by TÜV Rheinland, NVLAP or any agency of the United States Government.

NOTES: **Radiated Emissions**
110 VAC / 60 Hz

G Sensor Max hold high end - H

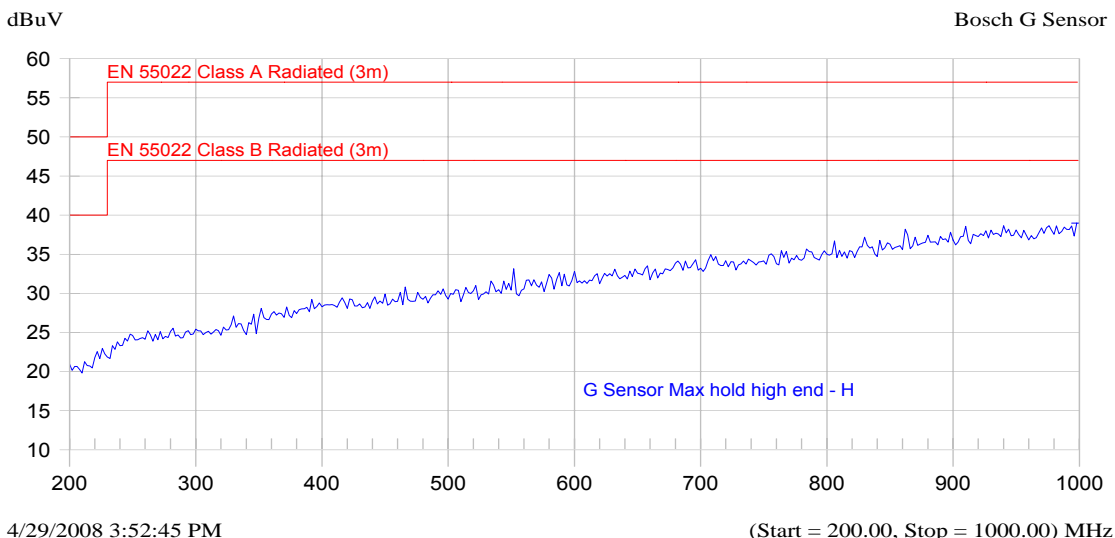

Frequency MHz	Peak dBuV	QP dBuV	Class B-QP dB	Class A-QP dB	Trace Name
------------------	--------------	------------	------------------	------------------	------------

ANTENNA/COUPLER:

- | | | | |
|---------------------------------------|---|---|--|
| <input type="checkbox"/> 9124 Bicon | <input type="checkbox"/> 3110 Bicon | <input type="checkbox"/> CBL6140 X-Wing | <input type="checkbox"/> NNB-4/63TL LISN |
| <input type="checkbox"/> 3147 Log Per | <input type="checkbox"/> 3115 Horn | <input type="checkbox"/> MDS-21 Clamp | <input type="checkbox"/> NNB-4/200X LISN |
| <input type="checkbox"/> 3106 Horn | <input checked="" type="checkbox"/> CBL6111 Bilog | <input type="checkbox"/> NSLK 8128 LISN | <input type="checkbox"/> NNLK 8121 LISN |

MEAS TYPE:

- Radiated Prescan
- Radiated Final
- Conducted
- Disturbance Power
- Other _____

POLARIZATION:

- Vertical
- Horizontal
- Line 1
- Line 2
- Line 3

DISTANCE:

- 3 Meter
- 10 Meter
- _____ Meter
- NA

LOCATION:

- OATS
- Semi-Anechoic
- Shielded Room
- Factory Floor
- Other _____

The test results contained in this report refer exclusively to the product(s) presented for testing. No liability may be assumed for models or products not referred to herein. This test report may not be published or duplicated in part without permission of the testing body. This test report by itself does not constitute authorization for the use of any TÜV Rheinland test mark. This report must not be used by the applicant to claim product endorsement by TÜV Rheinland, NVLAP or any agency of the United States Government.

NOTES: **Radiated Emissions**
110 VAC / 60 Hz

G Sensor Max hold high end - V

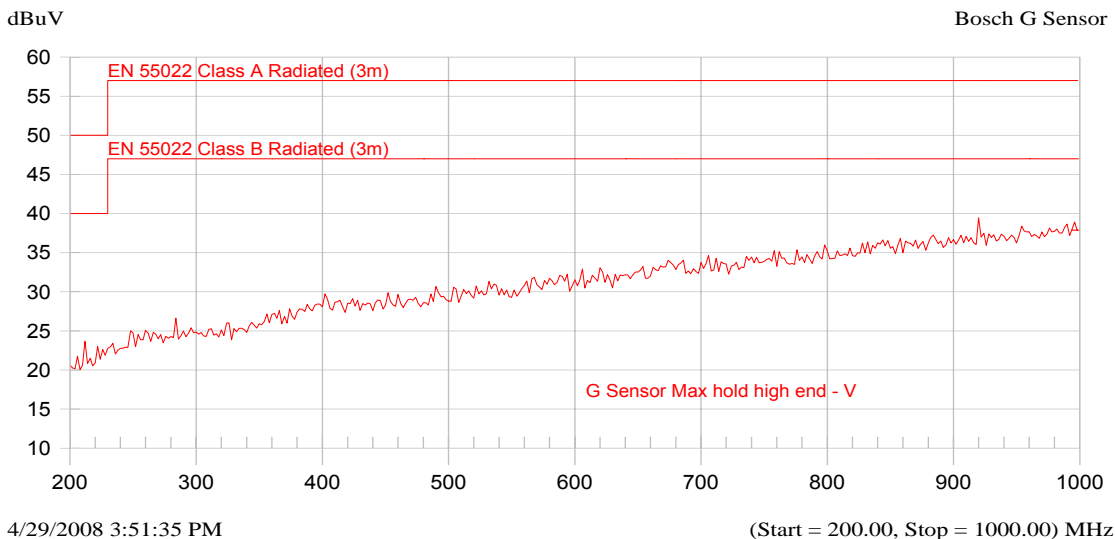

Frequency MHz	Peak dBuV	QP dBuV	Class B-QP dB	Class A-QP dB	Trace Name
------------------	--------------	------------	------------------	------------------	------------

ANTENNA/COUPLER:

- | | | | |
|---------------------------------------|---|---|--|
| <input type="checkbox"/> 9124 Bicon | <input type="checkbox"/> 3110 Bicon | <input type="checkbox"/> CBL6140 X-Wing | <input type="checkbox"/> NNB-4/63TL LISN |
| <input type="checkbox"/> 3147 Log Per | <input type="checkbox"/> 3115 Horn | <input type="checkbox"/> MDS-21 Clamp | <input type="checkbox"/> NNB-4/200X LISN |
| <input type="checkbox"/> 3106 Horn | <input checked="" type="checkbox"/> CBL6111 Bilog | <input type="checkbox"/> NSLK 8128 LISN | <input type="checkbox"/> NNLK 8121 LISN |

MEAS TYPE:

- Radiated Prescan
- Radiated Final
- Conducted
- Disturbance Power
- Other _____

POLARIZATION:

- Vertical
- Horizontal
- Line 1
- Line 2
- Line 3

DISTANCE:

- 3 Meter
- 10 Meter
- _____ Meter
- NA

LOCATION:

- OATS
- Semi-Anechoic
- Shielded Room
- Factory Floor
- Other _____

The test results contained in this report refer exclusively to the product(s) presented for testing. No liability may be assumed for models or products not referred to herein. This test report may not be published or duplicated in part without permission of the testing body. This test report by itself does not constitute authorization for the use of any TÜV Rheinland test mark. This report must not be used by the applicant to claim product endorsement by TÜV Rheinland, NVLAP or any agency of the United States Government.



10 Meter OATS Radiated Emissions Measurements

Radiated Emissions Measurements												
Standard:		47 CFR 15.245(b)			PRESCAN or FINAL:				Final		Date:	
Device Tested:		Bosch G Sensor			Distance:				3.0m		File: 30860166	
Meas #	Freq (MHz)	Peak	Average	Peak Limit	Peak Δ	Average Limit	Average Δ	Result	Antenna Polarization	Antenna Height (meters)	Angle (degrees)	Comment
1	10525.0000	118.90	99.70	148.00	-29.10	128.00	-28.3	Complied	Vertical	1	0.00	Fundamental
2	21050.0000	60.43	40.43	107.95	-47.52	87.95	-47.52	Complied	Vertical	1	0.00	Harmonics
3	31575.0000	66.50	46.50	107.95	-41.45	87.95	-41.45	Complied	Vertical	1	0.00	Harmonics

Field Strength: 118.9 dBuV = 882mV
 FCC 15.245 (b) Limit from 10.500 to 10.550 GHz is 2500 mV/meter

Fundamental and Spurious Emissions taken at 3 Meters at OATS site

Antenna factors and Cable losses are already factored into the measurements

Radiated Emissions Measurements												
Standard:		47 CFR 15.245(b)			PRESCAN or FINAL:				Final		Date:	
Device Tested:		Bosch G Sensor			Distance:				3.0m		File: 30860166	
Meas #	Freq (MHz)	Peak	Average	Peak Limit	Peak Δ	Average Limit	Average Δ	Result	Antenna Polarization	Antenna Height (meters)	Angle (degrees)	Comment
1	10525.0000	118.90	99.70	148.00	-29.10	128.00	-28.3	Complied	Vertical	1	0.00	Fundamental
2	21050.0000	60.43	40.43	107.95	-47.52	87.95	-41.45	Complied	Vertical	1	0.00	Harmonics
3	31575.0000	66.50	46.50	107.95	-47.45	87.95	-41.45	Complied	Vertical	1	0.00	Harmonics

The test results contained in this report refer exclusively to the product(s) presented for testing. No liability may be assumed for models or products not referred to herein. This test report may not be published or duplicated in part without permission of the testing body. This test report by itself does not constitute authorization for the use of any TÜV Rheinland test mark. This report must not be used by the applicant to claim product endorsement by TÜV Rheinland, NVLAP or any agency of the United States Government.

FCC 215(c) Frequency Stability over Temperature Variations

Standard:	FCC Part 15.215 (ANSI 63.4:2003)								Date:	5/28/2008
Device Tested:	SP-Pxx1-WA1xx - with G Sensor (10.525 GHz)								File:	08052801 Temp.xls
Customer:	Bosch Security Systems									
Temperature	Frequency in MHz measured 20dB below Peak								Permitted Band Edge in MHz	Results
	Start-up		2min		5min		10min			
	-dB20	+20dB	-dB20	+20dB	-dB20	+20dB	-dB20	+20dB		
-20°C	10,523.16	10,527.91	10,527.72	10,528.81	10,527.96	10,528.39	10,528.32	10,528.35	10500 – 10550	Complied
0° C	10,523.13	10,523.50	10,523.53	10,523.82	10,523.95	10,523.47	10,524.30	10,524.59	10500 – 10550	Complied
55° C	10,516.17	10,516.90	10,516.61	10,516.86	10,516.55	10,516.78	10,516.53	10,516.75	10500 – 10550	Complied
Tested by:	Dieter Baldamus									
TUV Rheinland of North America, Inc. 12 Commerce Road Newtown, CT 06470 Tel:(203) 426-0888 Fax: (203) 426-4009										
<small>FCC TempStab.xls Revised 24APR08</small>										

FCC 215(c) Frequency Stability over Voltage Variations

Frequency Stability Test (Voltage Variations)						
Standard:	FCC Part 15.215 (ANSI 63.4:2003)				Date:	5/28/2008
Device Te	SP-Pxx1-WA1xx - with G Sensor (10.525 G				File:	08052801 Temp.xls
Customer:	Bosch Security Systems					
Voltage	Frequency in MHz measured 20dB below Peak				Permitted Band Edge in MHz	Results
	-dB20	+20dB				
85%	10,523.16	10,527.91			10500 – 10550	Complied
Nom	10,523.13	10,523.50			10500 – 10550	Complied
115%	10,516.17	10,516.90			10500 – 10550	Complied
Tested by	Randy Masline					
TUV Rheinland of North America, Inc. 336 Initiative Dr Rochester , NY 14624						
Tel:(585) 426-5555 Fax: (585) 568-8338						
<small>FCC TempStab.xls Revised 24APR08</small>						

The test results contained in this report refer exclusively to the product(s) presented for testing. No liability may be assumed for models or products not referred to herein. This test report may not be published or duplicated in part without permission of the testing body. This test report by itself does not constitute authorization for the use of any TÜV Rheinland test mark. This report must not be used by the applicant to claim product endorsement by TÜV Rheinland, NVLAP or any agency of the United States Government.

NOTES:

Conducted Emissions
120VAC/60 Hz

Neutral - G

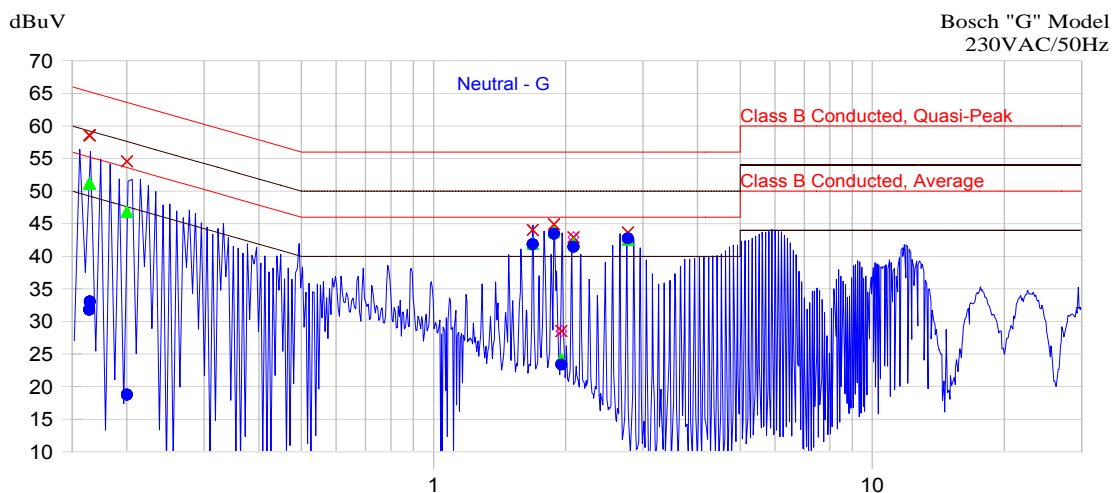

4/14/2008 10:36:43 AM

(Start = 0.15, Stop = 30.00) MHz

Frequency MHz	Peak dBuV	QP dBuV	Delta QP-QP dB	Limit dB	Avg dBuV	Delta Avg-Avg dB	Limit dB	Transducer Correction dB	Cable Correction dB
0.164	58.6	51.2	-14.1		31.8	-23.4		0.1	0.0
0.165	58.5	51.2	-14.1		33.1	-22.1		0.1	0.0
0.200	54.6	46.8	-16.8		18.8	-34.8		0.1	0.0
1.682	44.0	42.0	-14.0		41.8	-4.2		0.4	0.1
1.881	44.9	43.8	-12.2		43.5	-2.5		0.4	0.1
1.954	28.5	24.3	-31.7		23.4	-22.6		0.4	0.1
2.086	42.9	42.0	-14.0		41.5	-4.5		0.4	0.1
2.776	43.6	42.5	-13.5		42.7	-3.3		0.4	0.1

ANTENNA/COUPLER:

- | | | | |
|---------------------------------------|--|---|--|
| <input type="checkbox"/> 9124 Bicon | <input type="checkbox"/> 3110 Bicon | <input type="checkbox"/> CBL6140 X-Wing | <input type="checkbox"/> NNB-4/63TL LISN |
| <input type="checkbox"/> 3147 Log Per | <input type="checkbox"/> 3115 Horn | <input type="checkbox"/> MDS-21 Clamp | <input type="checkbox"/> NNB-4/200X LISN |
| <input type="checkbox"/> 3106 Horn | <input type="checkbox"/> CBL6111 Bilog | <input type="checkbox"/> NSLK 8128 LISN | <input checked="" type="checkbox"/> NNLK 8121 LISN |

MEAS TYPE:

- Radiated Prescan
- Radiated Final
- Conducted
- Disturbance Power
- Other _____

POLARIZATION:

- Vertical
- Horizontal
- Line
- Neutral
- NA

DISTANCE:

- 3 Meter
- 10 Meter
- _____ Meter
- NA

LOCATION:

- OATS
- Semi-Anechoic
- Shielded Room
- Factory Floor
- Other _____

The test results contained in this report refer exclusively to the product(s) presented for testing. No liability may be assumed for models or products not referred to herein. This test report may not be published or duplicated in part without permission of the testing body. This test report by itself does not constitute authorization for the use of any TÜV Rheinland test mark. This report must not be used by the applicant to claim product endorsement by TÜV Rheinland, NVLAP or any agency of the United States Government.

NOTES:

**Conducted Emissions
120VAC/60 Hz**

Line 1 - G

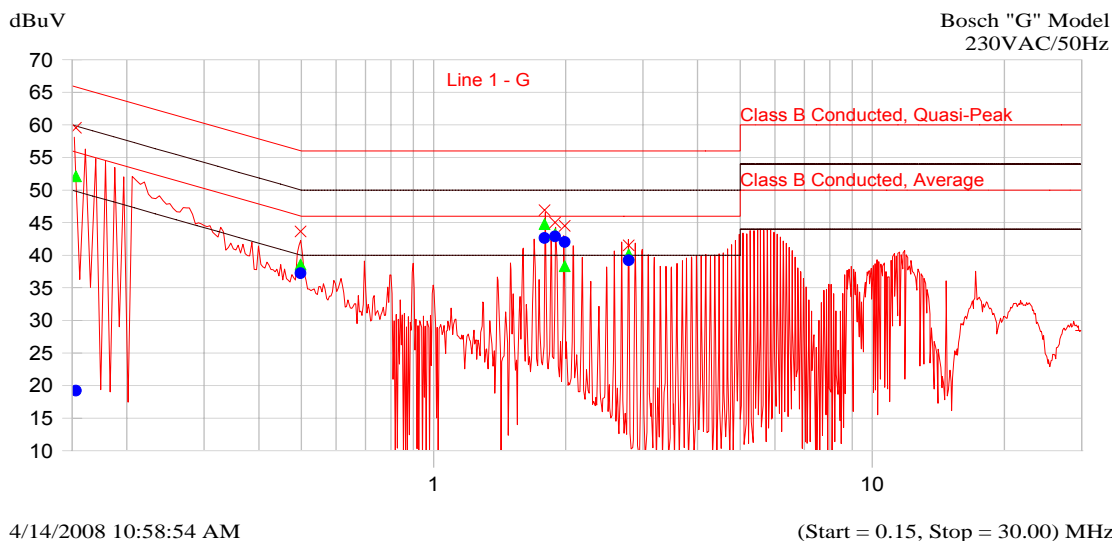

4/14/2008 10:58:54 AM

(Start = 0.15, Stop = 30.00) MHz

Frequency MHz	Peak dBuV	QP dBuV	Delta QP-QP dB	Limit	Avg dBuV	Delta Avg-Avg dB	Limit	Transducer Correction dB	Cable Correction dB
0.153	59.6	52.1	-13.7		19.2	-36.6		0.1	0.0
0.498	43.6	38.6	-17.5		37.2	-8.8		0.1	0.1
1.791	46.9	44.8	-11.2		42.7	-3.3		0.1	0.1
1.893	45.0	43.2	-12.8		42.9	-3.1		0.1	0.1
1.991	44.5	38.3	-17.7		42.0	-4.0		0.1	0.1
2.785	41.5	40.1	-15.9		39.2	-6.8		0.1	0.1

ANTENNA/COUPLER:

- | | | | |
|---------------------------------------|---|---|--|
| <input type="checkbox"/> 9124 Bicon | <input type="checkbox"/> 3110 Bicon | <input type="checkbox"/> CBL6140 X-Wing | <input type="checkbox"/> NNB-4/63TL LISN |
| <input type="checkbox"/> 3147 Log Per | <input type="checkbox"/> 3115 Horn | <input type="checkbox"/> MDS-21 Clamp | <input type="checkbox"/> NNB-4/200X LISN |
| <input type="checkbox"/> 3106 Horn | <input checked="" type="checkbox"/> CBL6111 Bilog | <input type="checkbox"/> NSLK 8128 LISN | <input type="checkbox"/> NNLK 8121 LISN |

MEAS TYPE:

- Radiated Prescan
 Radiated Final
 Conducted
 Disturbance Power
 Other _____

POLARIZATION:

- Vertical
 Horizontal
 Line
 Neutral
 NA

DISTANCE:

- 3 Meter
 10 Meter
 _____ Meter
 NA

LOCATION:

- OATS
 Semi-Anechoic
 Shielded Room
 Factory Floor
 Other _____

The test results contained in this report refer exclusively to the product(s) presented for testing. No liability may be assumed for models or products not referred to herein. This test report may not be published or duplicated in part without permission of the testing body. This test report by itself does not constitute authorization for the use of any TÜV Rheinland test mark. This report must not be used by the applicant to claim product endorsement by TÜV Rheinland, NVLAP or any agency of the United States Government.

Field Strength: 11.91dBm = 15.52 mw = 882mV
 FCC 15.245 (b) Limit from 10.500 to 10.550 GHz is 2500 mV/meter

Bandwidth: 455kHz

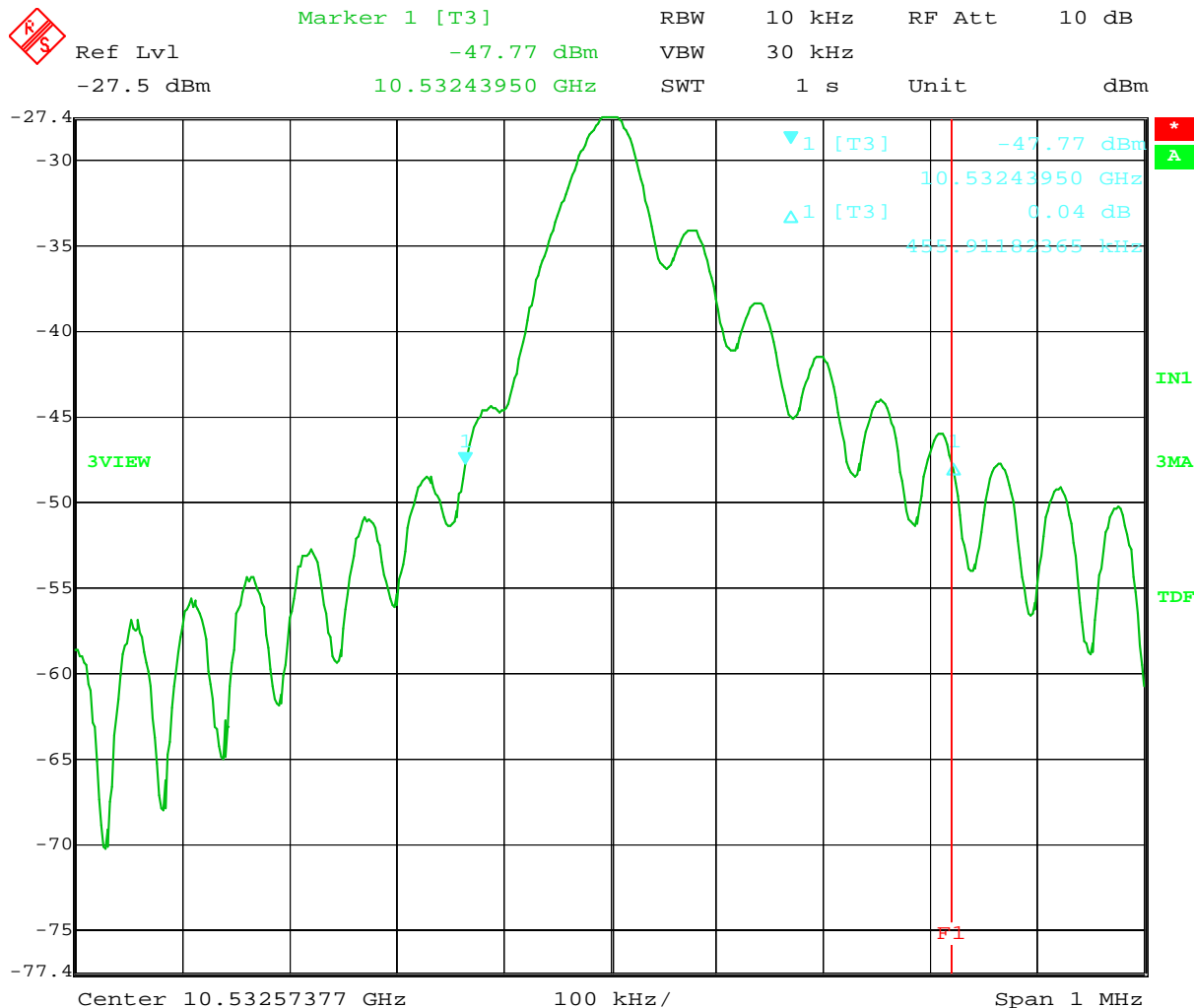

Date: 8.MAY.2008 13:40:47

The test results contained in this report refer exclusively to the product(s) presented for testing. No liability may be assumed for models or products not referred to herein. This test report may not be published or duplicated in part without permission of the testing body. This test report by itself does not constitute authorization for the use of any TÜV Rheinland test mark. This report must not be used by the applicant to claim product endorsement by TÜV Rheinland, NVLAP or any agency of the United States Government.

TÜV Rheinland of North America, Inc., North American Headquarters, 12 Commerce Road, Newtown, CT 06470 - Tel (203)426-0888 - Fax (203)426-4009

99% Occupied Bandwidth: 2.52 MHz

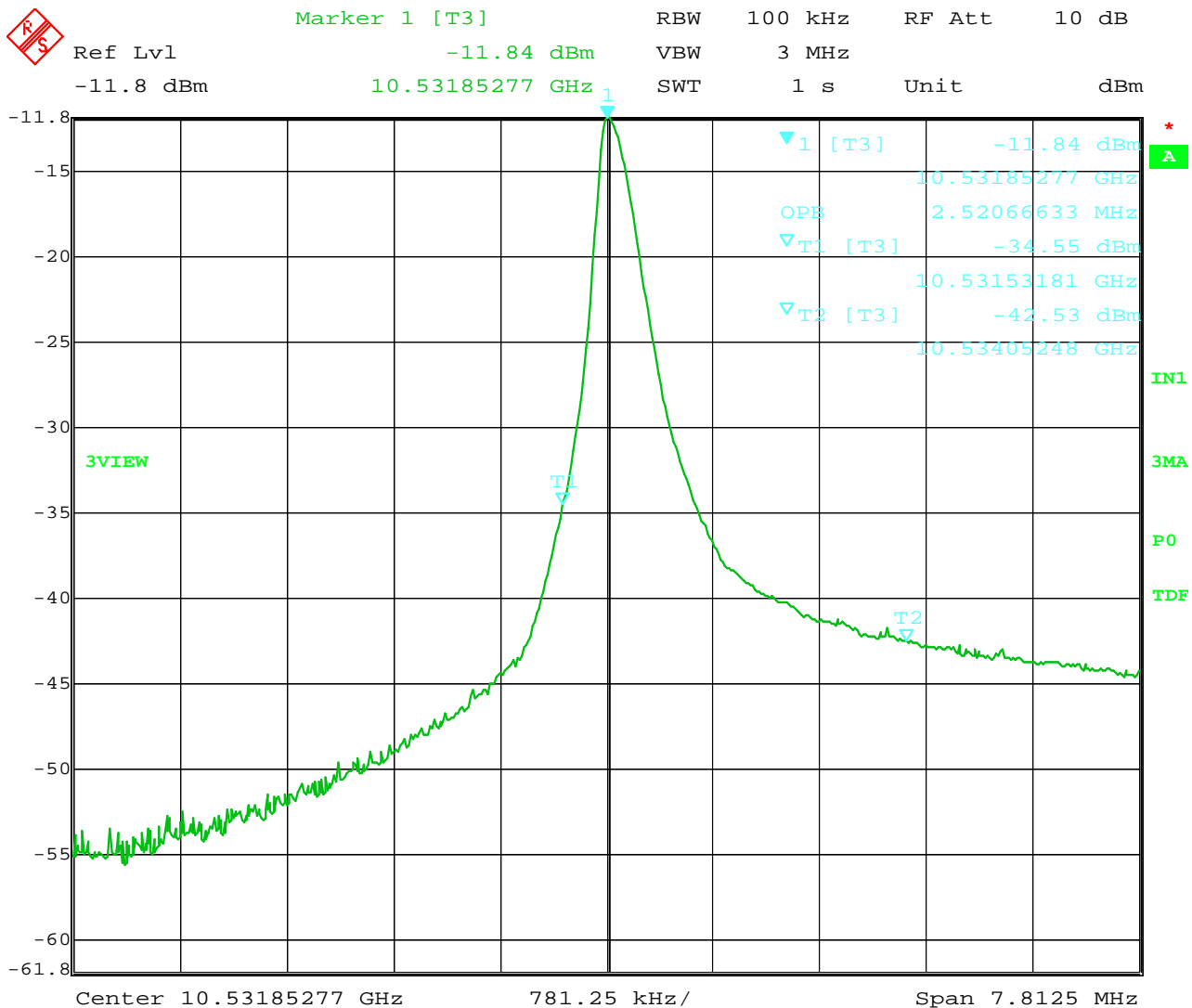

Date: 8.MAY.2008 14:38:10

The test results contained in this report refer exclusively to the product(s) presented for testing. No liability may be assumed for models or products not referred to herein. This test report may not be published or duplicated in part without permission of the testing body. This test report by itself does not constitute authorization for the use of any TÜV Rheinland test mark. This report must not be used by the applicant to claim product endorsement by TÜV Rheinland, NVLAP or any agency of the United States Government.

TÜV Rheinland of North America, Inc., North American Headquarters, 12 Commerce Road, Newtown, CT 06470 - Tel (203)426-0888 - Fax (203)426-4009

Band Edge:

	Marker 3 [T1]	RBW	300 kHz	RF Att	30 dB
	Ref Lvl	90.66 dBµV	VBW	300 kHz	
	107 dBµV	10.53306613 GHz	SWT	5 ms	Unit dBµV

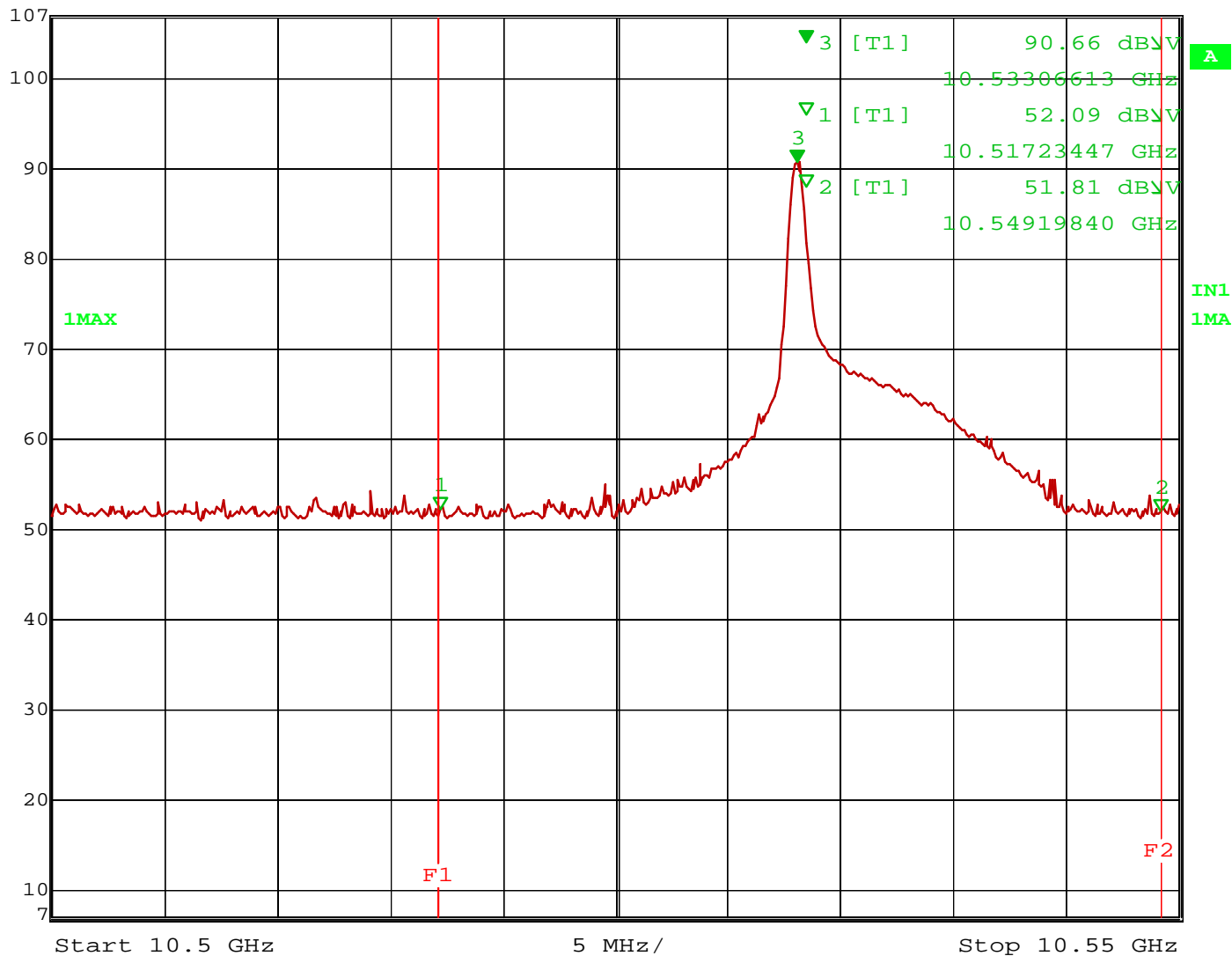

Date: 29.MAY.2008 15:54:28

The test results contained in this report refer exclusively to the product(s) presented for testing. No liability may be assumed for models or products not referred to herein. This test report may not be published or duplicated in part without permission of the testing body. This test report by itself does not constitute authorization for the use of any TÜV Rheinland test mark. This report must not be used by the applicant to claim product endorsement by TÜV Rheinland, NVLAP or any agency of the United States Government.

TÜV Rheinland of North America, Inc., North American Headquarters, 12 Commerce Road, Newtown, CT 06470 - Tel (203)426-0888 - Fax (203)426-4009

Duty Cycle: Pulse Train

8 on times over 10ms period = 80 pulses in 100ms

One on time = 16.83µs (next page)



Ref Lvl
 107 dBµV

RBW	1 MHz	RF Att	30 dB
VBW	10 MHz		
SWT	10 ms	Unit	dBµV

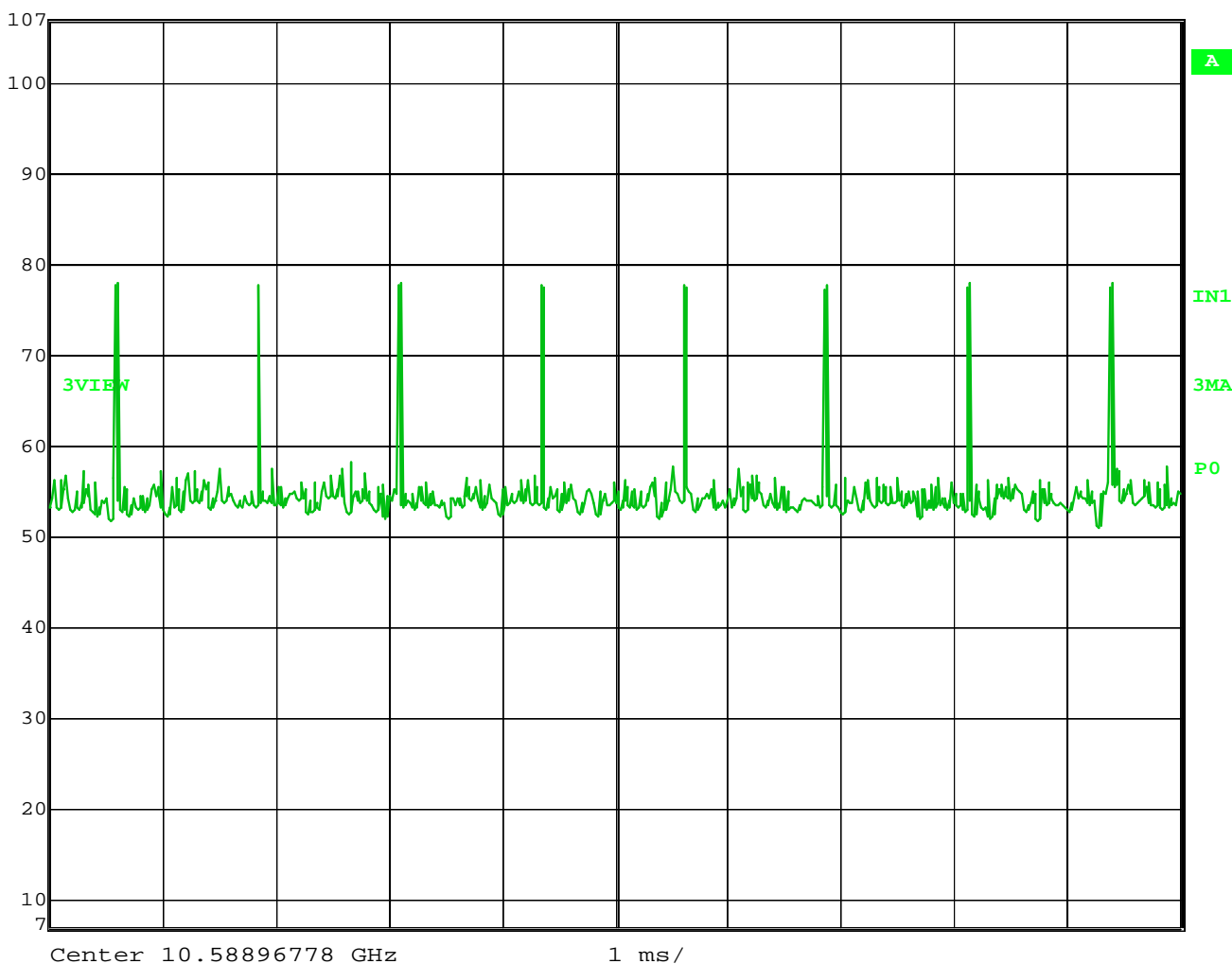

Date: 8.MAY.2008 17:29:29

The test results contained in this report refer exclusively to the product(s) presented for testing. No liability may be assumed for models or products not referred to herein. This test report may not be published or duplicated in part without permission of the testing body. This test report by itself does not constitute authorization for the use of any TÜV Rheinland test mark. This report must not be used by the applicant to claim product endorsement by TÜV Rheinland, NVLAP or any agency of the United States Government.

TÜV Rheinland of North America, Inc., North American Headquarters, 12 Commerce Road, Newtown, CT 06470 - Tel (203)426-0888 - Fax (203)426-4009

Duty Cycle: Single Pulse = 16.83μs

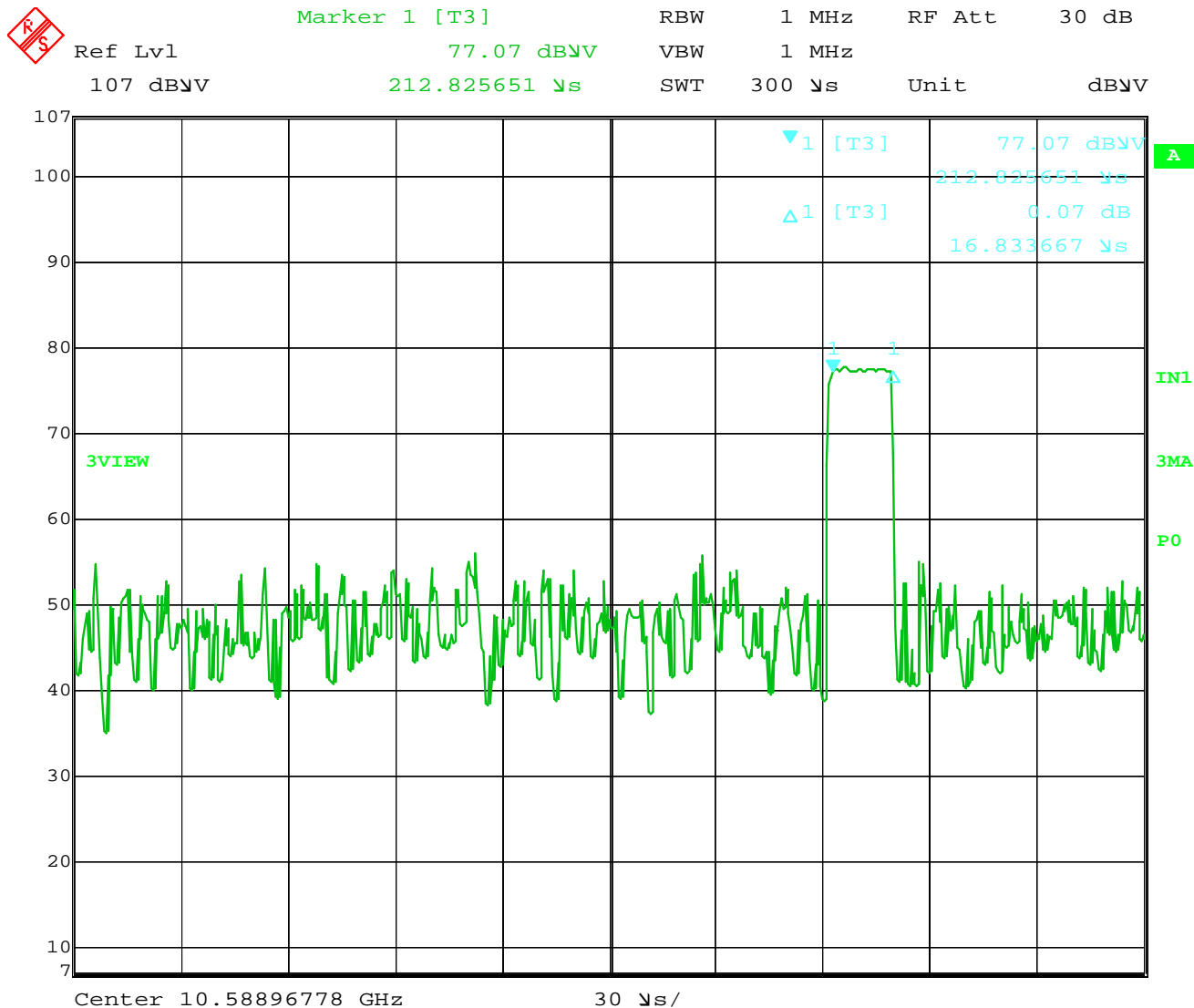

Date: 8.MAY.2008 17:26:31

Duty Cycle Correction per FCC 15.35: 20 dB Max Allowance
 80 * 16.83μs Pulses = 1.3464ms

$$20 \log (0.0013464/100) = 20 \log (0.000013464) = -97.4165$$

The test results contained in this report refer exclusively to the product(s) presented for testing. No liability may be assumed for models or products not referred to herein. This test report may not be published or duplicated in part without permission of the testing body. This test report by itself does not constitute authorization for the use of any TUV Rheinland test mark. This report must not be used by the applicant to claim product endorsement by TUV Rheinland, NVLAP or any agency of the United States Government.

APPENDIX C: CONSTRUCTIONAL DATA FORM

The test results contained in this report refer exclusively to the product(s) presented for testing. No liability may be assumed for models or products not referred to herein. This test report may not be published or duplicated in part without permission of the testing body. This test report by itself does not constitute authorization for the use of any TÜV Rheinland test mark. This report must not be used by the applicant to claim product endorsement by TÜV Rheinland, NVLAP or any agency of the United States Government.

TUV Rheinland of North America, Inc., North American Headquarters, 12 Commerce Road, Newtown, CT 06470 - Tel (203)426-0888 - Fax (203)426-4009

TUV Rheinland D-51101 Köln 91 Am Grauen Stein/ Konstantin-Wille-Str. 1	Please submit in duplicate		
	Gen-Ausw-Nr.	Aktenzeichen: 30860166.001 G	Anlage-Nr. 1 bl. 2
EMC/EMV			
Constructional Data Form			
	Applicant	Factory	Representative in Canada
Name:	Frank Mioduszewski	Same	Norm Hoefler
Company:	Bosch Security Systems Inc.		Robert Bosch Inc./Security Systems Division
Address:	130 Perinton Parkway Fairport NY, 14450		6811 Century Ave. Mississauga ON L5N 1R1 Canada
Phone/Fax	(585) 223-4060 / (585) 421-4263		(905) 201-4582/ (905) 886-7923
Product Description/Application:			
Dual Technolgy Intrusion Detector			
Model.:			
ISP-PDL1-WA18G			
Serial No.:			
092003488137400000			
Operating Modes:			
EUT will be operated at 12VDC through a power supply operating at 120V/60Hz			
Type of EMI (i.e., wide band, narrow band, clicks): NA		Rated Voltage, Current, and Frequency: Input Voltage VAC, Input Frequency Hz, Input Current Amps, Power Rating Watts	
Protection Class: I		Repetition Frequency (<10kHz, >10kHz): >10kHz	
TUV Rheinland Prüfstelle für Gerätesicherheit		Applicant	
Köln, den:	Ort/place:	Datum/date:	
TUV Rheinland Prüfstelle für Gerätesicherheit		(Stempel und Unterschrift des Antragstellers/ stamp and signature of applicant)	

The test results contained in this report refer exclusively to the product(s) presented for testing. No liability may be assumed for models or products not referred to herein. This test report may not be published or duplicated in part without permission of the testing body. This test report by itself does not constitute authorization for the use of any TÜV Rheinland test mark. This report must not be used by the applicant to claim product endorsement by TÜV Rheinland, NVLAP or any agency of the United States Government.

