

Test Report

Report Number:

F212055E1

Equipment under Test (EUT):

**Infrared and radar motion detector
CDL2-A15G**

Applicant:

Bosch Security System, Inc.

Manufacturer:

Bosch Security Systems - Sistemas de Segurança, S.A.



Deutsche
Akkreditierungsstelle
D-PL-17186-01-00

References

- [1] **ANSI C63.10 – 2020 + Corrigendum 1 – 2023**, American National Standard for Compliance Testing of Transmitters Used in Licensed Radio Services
- [2] **FCC CFR 47 Part 15**, Radio Frequency Devices
- [3] **RSS-210 Issue 10 – April 2019 + Amendment 1 – March 2010 + Amendment 2 – February 2021**, Licence-Exempt Radio Apparatus: Category I Equipment
- [4] **RSS-Gen Issue 5 – December 2019 + Amendment 2 – April 2020**, General Requirements for Compliance of Radio Apparatus

TEST RESULT

The requirements of the tests performed as shown in the overview (clause 4) were fulfilled by the equipment under test. The complete test results are presented in the following. “Passed” indicates that the equipment under test conforms with the relevant limits of the testing standard without taking any measurement uncertainty into account as stated in clause 1.4 of ANSI C63.10 (2020). However, the measurement uncertainty is calculated and shown in this test report.

Tested and
written by:

Signature

Reviewed and
approved by:

Signature

This test report is only valid in its original form.

Any reproduction of its contents in extracts without written permission of the accredited test laboratory PHOENIX TESTLAB GmbH is prohibited.

The test results herein refer only to the tested sample. PHOENIX TESTLAB GmbH is not responsible for any generalisations or conclusions drawn from these test results concerning further samples. Any modification of the tested samples is prohibited and leads to the invalidity of this test report. Each page necessarily contains the PHOENIX TESTLAB Logo and the TEST REPORT NUMBER.

Contents:	Page
1 Identification	4
1.1 Applicant.....	4
1.2 Manufacturer	4
1.3 Test laboratory	4
1.4 EUT (Equipment Under Test).....	5
1.5 Technical data of equipment	5
1.6 Dates	6
2 Operational states	6
3 Additional information	6
4 Overview.....	7
5 Test results	8
5.1 Bandwidth.....	8
5.1.1 Method of measurement (bandwidth)	8
5.2 Test results (20 dB bandwidth)	9
5.2.1 Test results (99 % bandwidth)	10
5.3 Band-edge compliance	11
5.3.1 Method of measurement (band-edge compliance)	11
5.3.2 Test results (band-edge compliance).....	12
5.4 Radiated emissions	14
5.4.1 Method of measurement (radiated emissions)	14
5.4.2 Test results (radiated emissions)	21
5.4.2.1 Preliminary radiated emission measurement (1 MHz to 60 GHz)	21
5.4.2.2 Final radiated emission measurement (9 kHz to 30 MHz)	25
5.4.2.3 Final radiated emission measurement (30 MHz to 1 GHz)	25
5.4.2.4 Final radiated emission measurement (1 GHz to 60 GHz).....	27
5.5 Conducted emissions on power supply lines (150 kHz to 30 MHz).....	28
5.5.1 Method of measurement	28
5.5.2 Test results (conducted emissions on power supply lines)	29
6 Test equipment and ancillaries used for tests	30
7 Test site Validation	31
8 Measurement uncertainties	31
9 Report history	32
10 List of annexes	32

1 Identification

1.1 Applicant

Name:	Bosch Security System, Inc.
Address:	130 Perinton Pkwy Fairport, NY 14450
Country:	USA
Name for contact purposes:	Mr. Markus MEICHELBECK
Phone:	+49 89 62 90 - 13 64
eMail Address:	Markus.meichelbeck@de.bosch.com
Applicant represented during the test by the following person:	---

1.2 Manufacturer

Name:	Bosch Security Systems - Sistemas de Segurança, S.A.
Address:	EN109/IC1, Zona Industrial de Ovar Lugar da Pardala - S. João de Ovar 3880-728 Ovar
Country:	Portugal
Name for contact purposes:	Mr. Antonio PEREIRA
Phone:	+351 256 596 - 110
eMail Address:	AntonioMaria.Pereira@pt.bosch.com
Manufacturer represented during the test by the following person:	---

1.3 Test laboratory

The tests were carried out at: **PHOENIX TESTLAB GmbH**
Königswinkel 10
32825 Blomberg
Germany

Accredited by Deutsche Akkreditierungsstelle GmbH (DAkKS) in compliance with DIN EN ISO/IEC 17025 under Reg. No. D-PL-17186-01-05 and D-PL-17186-01-06, FCC Test Firm Designation Number DE0004, FCC Test Firm Registration Number 469623, CAB Identifier DE0003 and ISED# 3469A.

1.4 EUT (Equipment Under Test)

Test object: *	Infrared and radar motion detector
PMN: *	CDL2
HVIN: *	CDL2-A15G
FCC ID: *	T3X-CDL2
IC: *	1249A-CDL2
Serial number: *	042207937704030022
PCB identifier: *	F01U416491_01
Software version / FVIN: *	V1.2
Receiver mixer diode: *	Diode F01U415953; Onsemi NSR201MX
Lowest internal frequency: *	32 MHz

*: Declared by the applicant.

Note: PHOENIX TESTLAB GmbH does not take samples. The samples used for tests are provided exclusively by the applicant.

1.5 Technical data of equipment

Duty cycle: *	<0.5 %		
Rated RF output power: *	<20 mW (e.i.r.p.)		
Antenna type:	Integral patch antenna		
Operating frequency range: *	10.510 GHz to 10.550 GHz		
Modulation: *	Pulsed CW		
Bit rate of transmitter: *	N/A		
Supply Voltage (EUT): *	$U_{Nom} = 12.0 V_{DC}$	$U_{Min} = 9.0 V_{DC}$	$U_{Max} = 15.0 V_{DC}$
Power Supply: *	External		
Temperature range: *	-20 °C to +55 °C		
Ancillaries to be tested with:	None		
Equipment used for testing:	AC/DC adaptor type enercell CAT.NO. 273-316** for conducted emission on supply lines		

*: Declared by the applicant.

** : Provided by the laboratory.

Ports/Connectors

Identification	Connector type		Length *
	EUT	Ancillary	
DC in and relays outputs	8-pole terminal block	-	5.0 m
-	-	-	-
-	-	-	-

*: Length during test

1.6 Dates

Date of receipt of test sample:	04.12.2023
Start of test:	31.01.2024
End of test:	12.02.2024

2 Operational states

The EUT is an infrared and radar movement detector intended to be used in indoor alarm applications. All tests were carried out with an unmodified test sample, operating in normal operation mode (infrared and radar detection active).

The EUT was supplied with 12.0 V_{DC} by an external power supply during all tests.

If not otherwise stated, the tests were carried out in normal position of the EUT as it is stated in the installation instruction.

3 Additional information

None

4 Overview

Application	Frequency range	FCC 47 CFR Part 15 section [2]	RSS-Gen [4] and RSS 210 [3]	Status	Refer page
Bandwidth	10.500 GHz to 10.550 GHz	15.215 (c)	6.7 [4]	Passed	8 et seq.
Band edge compliance	10.500 GHz to 10.550 GHz	15.215 (c)	-	Passed	11 et seq.
Field strength of fundamental	10.500 GHz to 10.550 GHz	15.245 (b)	F.1 (a) [3]	Passed	14 et seq.
Field strength of harmonics	Up to 60 GHz	15.245 (b) (1) (ii)	F.1 (b) [3] F.1 (c) (ii) [3]	Passed	14 et seq.
Emissions outside the specified bands	10 MHz to 60 GHz	15.205 (a), 15.209 (a), 15.245 (3)	8.9 [4] 8.10 [4] F.1 (e) [3]	Passed	14 et seq.
Conducted emissions	150 kHz to 30 MHz	15.207	8.8 [4]	Passed	28 et seq.
Antenna requirement	-	15.203	-	Passed *	-

*: Integrated antenna only, requirement fulfilled.

5 Test results

5.1 Bandwidth

5.1.1 Method of measurement (bandwidth)

The calibration of the spectrum analyser has to be checked with the help of a known signal from a signal generator. The EUT has to be connected to the spectrum analyser via a low loss cable. If the EUT is not equipped with an antenna connector, a temporary antenna connector has to be installed or a test fixture shall be used. Alternatively the measurement could also be carried out with the setup used for the radiated emission measurement. The EUT has to be switched on, the transmitter shall work with its maximum data rate.

The following spectrum analyser settings shall be used:

- Span: App. 2 to 3 times the 20 dB bandwidth, centred on the actual channel.
- Resolution bandwidth: App. 1 % of the emission bandwidth.
- Video bandwidth: equal or greater than the RBW.
- Sweep: Auto.
- Detector function: peak.
- Trace mode: Max hold.

20 dB bandwidth:

After trace stabilisation the marker shall be set on the signal peak. The first display line has to be set on this value. The second display line has to be set 20 dB below the first line (or the peak marker). The frequency lines shall be set on the intersection points between the second display line and the measured curve.

99 % bandwidth:

After trace stabilisation the marker shall be set on the signal peak. Use the 99 % bandwidth functionality of the spectrum analyser to integrate the requested bandwidth.

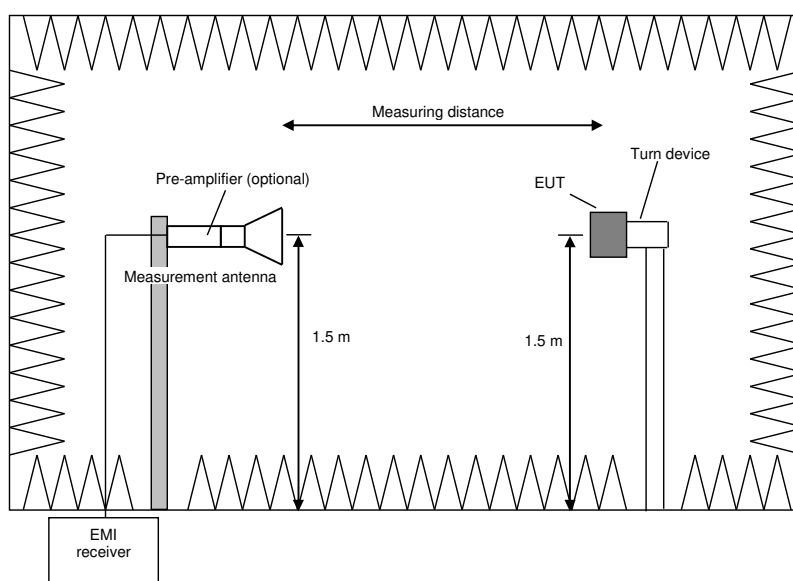

5.1.2 Test results (20 dB bandwidth)

Ambient temperature	22 °C
Relative humidity:	31 %

Date:	31.01.2024
Tested by:	Thomas KÜHN

Position of EUT: The EUT was set-up 3 m in front of the measuring antenna.

Supply voltage: 12 V_{DC} by an external power supply.

231953_5.png: 20 dB bandwidth:

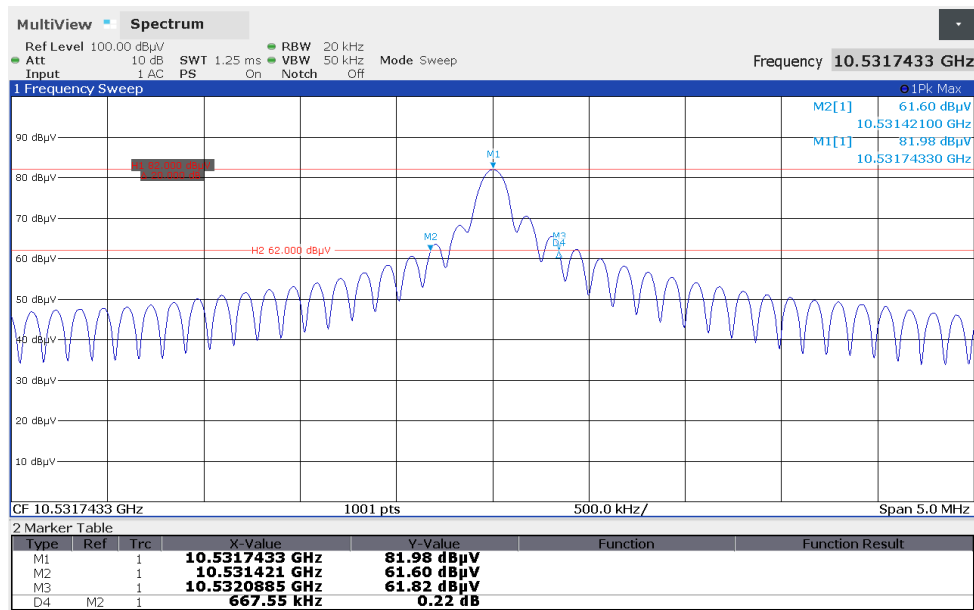

F _L	Limit F _L	F _U	Limit F _U	20 dB Bandwidth	Test result
10.531421	10.500	10.532089	10.550	0.668 MHz	Passed

Test equipment (please refer to chapter 6 for details)
16, 18 – 28

5.1.3 Test results (99 % bandwidth)

Ambient temperature:	22 °C
Relative humidity:	31 %

Date:	31.01.2024
Tested by:	Thomas KÜHN

Position of EUT: The EUT was set-up 3 m in front of the measuring antenna.

Supply voltage: 12 V_{DC} by an external power supply.

231953_6.png: 99 % bandwidth:

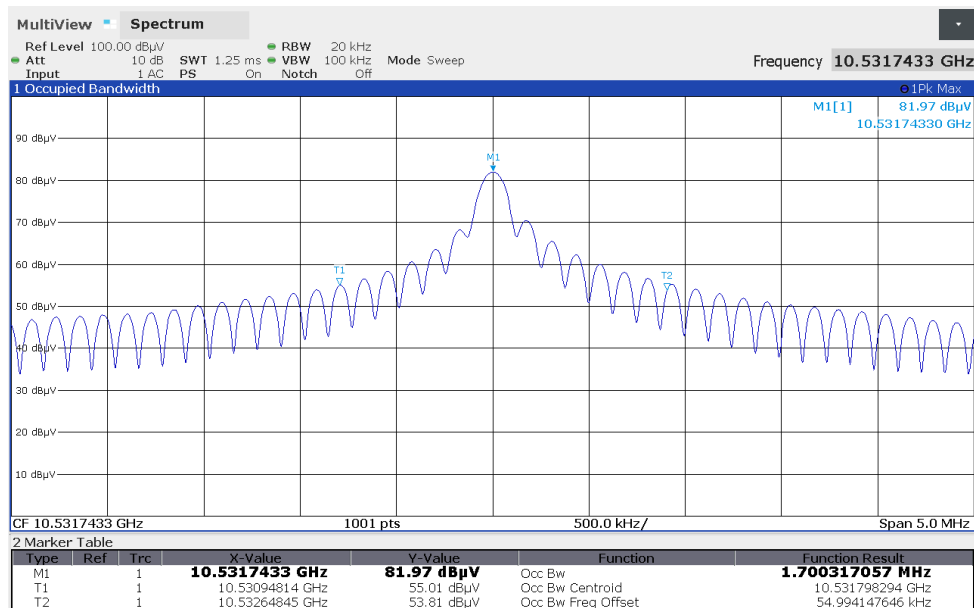

F _L	Limit F _L	F _U	Limit F _U	99 % Bandwidth	Test result
10.530948	10.500	10.532648	10.550	1.700 MHz	Passed

Test equipment (please refer to chapter 6 for details)
16, 18 – 28

5.2 Band-edge compliance

5.2.1 Method of measurement (band-edge compliance)

The same test set-up as used for the final radiated emission measurement shall be used. The measurements shall be carried out with using a resolution bandwidth of 100 kHz.

The following spectrum analyser settings shall be used:

- Span: Wide enough to capture the peak level of the emission on the channel closest to the band-edge, as well as any modulation products, which fall outside the assigned frequency band.
- Resolution bandwidth: 100 kHz.
- Video bandwidth: \geq the resolution bandwidth.
- Sweep: Auto.
- Detector function: Peak.
- Trace mode: Max hold.

After trace stabilisation the marker shall be set on the signal peak. The display line has to be set 50 dB below the peak marker. The frequency line shall be set on the edge of the assigned frequency band. Set the second marker on the emission at the band-edge, or on the highest modulation product outside of the band, if this level is higher than that at the band-edge. This frequency shall be measured with the EMI receiver as described in subclause 5.3.1 of this test report, but 100 kHz resolution bandwidth shall be used.

The measurement will be performed at the lower and upper end of the assigned frequency band.

5.2.2 Test results (band-edge compliance)

Ambient temperature:	22 °C
Relative humidity:	31 %

Date:	31.01.2024
Tested by:	Thomas KÜHN

231953_7.png: Band-edge compliance, lower band edge:

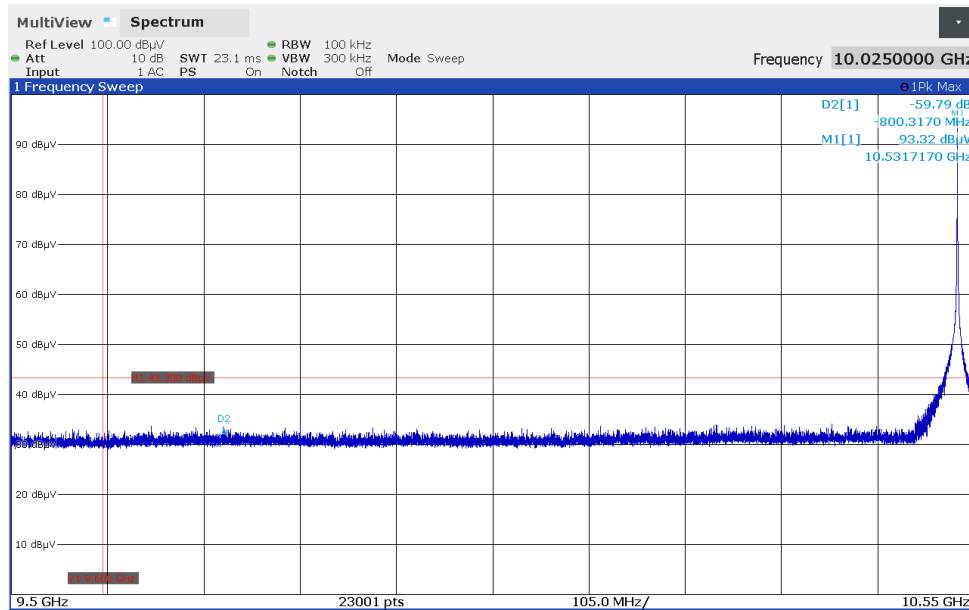

231953_8.png: Band-edge compliance, upper band edge:

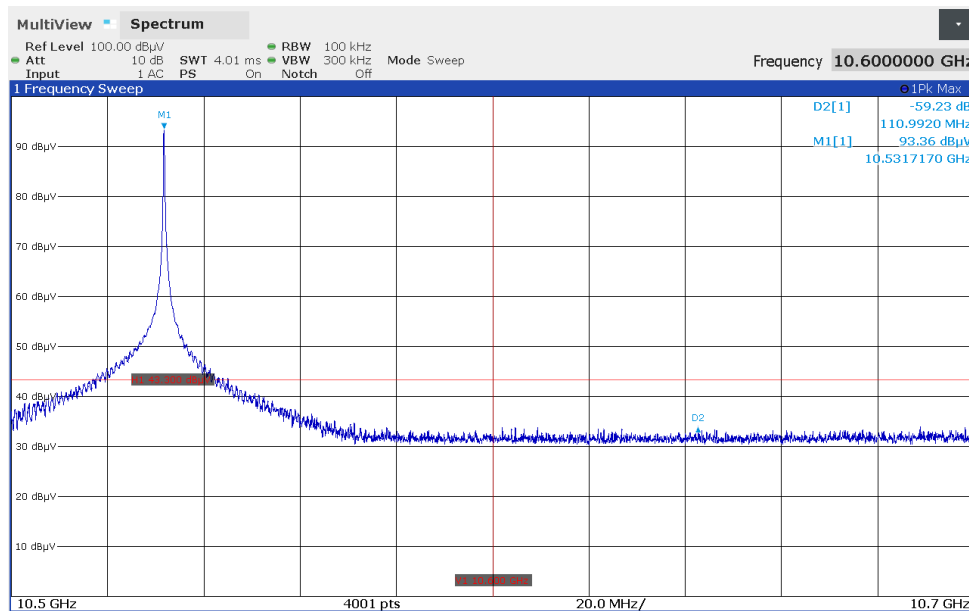

The plots on the previous page are showing the band-edge compliance for the lower and upper band-edge.

The Marker 1 represents the highest level within the assigned frequency band. The delta marker shows the difference to this peak. The display line 1 (H1) represents the -50 dB offset to this highest level and shows the compliance with FCC 47 CFR Part 15.245 (b) (3). The frequency line 1 (V1) shows the edge of the assigned frequency.

The following calculations were used:

$$\text{Correction [dB]} = \text{Antenna factor [dBm/m]} - \text{Preamplifier gain [dB]} + \text{Cable attenuation [dB]}$$

$$\text{Result [dB}\mu\text{V/m]} = \text{reading [dB}\mu\text{V]} + \text{correction [dB]}$$

Band-edge compliance (lower band edge)							
Result measured with the peak detector:							
Frequency [GHz]	Result [dB μ V/m]	Limit [dB μ V/m]	Margin [dB]	Readings [dB μ V]	Correction [dB]	Restr. Band	Test result
9.731400	41.5	74.0	32.5	34.8	6.8	No	Passed
Result measured with the average detector:							
Frequency [GHz]	Result [dB μ V/m]	Limit [dB μ V/m]	Margin [dB]	Readings [dB μ V]	Correction [dB]	Restr. Band	Test result
9.731400	-6.1	54.0	60.1	-12.9	6.8	No	Passed

Band-edge compliance (upper band edge)							
Result measured with the peak detector:							
Frequency [GHz]	Result [dB μ V/m]	Limit [dB μ V/m]	Margin [dB]	Readings [dB μ V]	Correction [dB]	Restr. Band	Test result
10.642709	42.1	74.0	31.9	35.3	6.8	Yes	Passed
Result measured with the average detector:							
Frequency [GHz]	Result [dB μ V/m]	Limit [dB μ V/m]	Margin [dB]	Readings [dB μ V]	Correction [dB]	Restr. Band	Test result
10.642709	-5.5	54.0	59.5	-12.3	6.8	Yes	Passed

Test equipment (please refer to chapter 6 for details)
16, 18 – 28

5.3 Radiated emissions

5.3.1 Method of measurement (radiated emissions)

The radiated emission measurement is subdivided into 5 stages.

- A preliminary measurement carried out in a fully anechoic chamber with a fixed antenna height in the frequency range 9 kHz to 1 GHz.
- A final measurement carried out on an outdoor test side without reflecting ground plane and a fixed antenna height in the frequency range 9 kHz to 30 MHz.
- A final measurement carried out on an open area test side with reflecting ground plane and various antenna heights in the frequency range 30 MHz to 1 GHz.
- A preliminary measurement carried out in a fully anechoic chamber with a variable antenna distance and height in the frequency range 1 GHz to 60 GHz.
- A final measurement carried out in a fully anechoic chamber with a fixed antenna height in the frequency range 1 GHz to 60 GHz.

Preliminary measurement (9 kHz to 30 MHz):

In the first stage a preliminary measurement will be performed in a shielded room with a measuring distance of 3 meters. Tabletop devices will set up on a non-conducting support with a size of 1 m by 1.5 m and a height of 80 cm. Floor-standing devices will be placed directly on the turntable/ground plane. The setup of the Equipment under test will be in accordance to [1].

The frequency range 9 kHz to 30 MHz will be monitored with a spectrum analyser while the system and its cables will be manipulated to find out the configuration with the maximum emission levels if applicable. The EMI Receiver will be set to MAX Hold mode. The EUT and the measuring antenna will be rotated around their vertical axis to found the maximum emissions.

The resolution bandwidth of the spectrum analyser will be set to the following values:

Frequency range	Resolution bandwidth
9 kHz to 150 kHz	200 Hz
150 kHz to 30 MHz	10 kHz

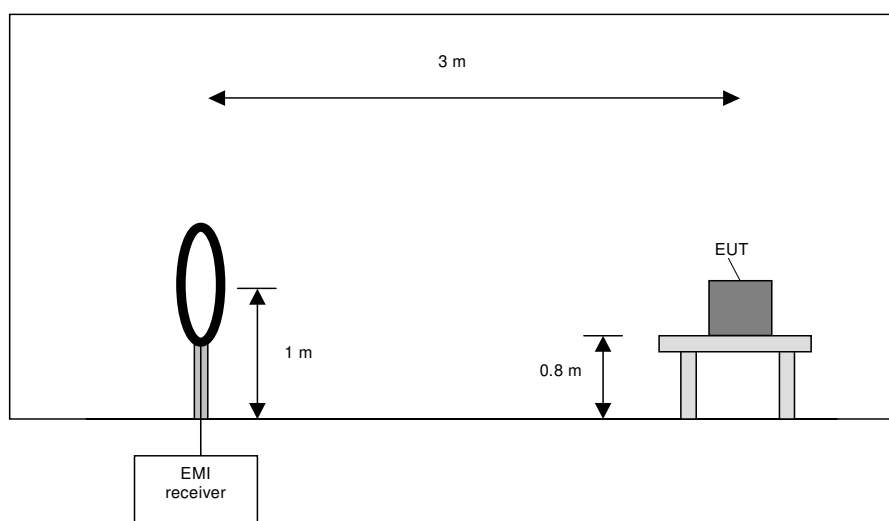

Preliminary measurement procedure:

Prescans were performed in the frequency range 9 kHz to 150 kHz and 150 kHz to 30 MHz.

The following procedure will be used:

- 1) Monitor the frequency range at horizontal polarisation and a EUT azimuth of 0 °.
- 2) Manipulate the system cables within the range to produce the maximum level of emission.
- 3) Rotate the EUT by 360 ° to maximize the detected signals.
- 4) Make a hardcopy of the spectrum.
- 5) Measure the frequencies of highest detected emission with a lower span and resolution bandwidth to increase the accuracy and note the frequency value.
- 6) Repeat steps 1) to 5) with the other orthogonal axes of the EUT (only if the EUT is a module or is used in a handheld application).
- 7) Rotate the measuring antenna and repeat steps 1) to 5).

Final measurement (9 kHz to 30 MHz):

In the second stage a final measurement will be performed on an open area test site with no conducting ground plane in a measuring distances of 3 m, 10 m and 30 m whichever is appropriate. In the case where larger measuring distances were required the results will be extrapolated based on the values measured on the closer distances according to [2]. The final measurement will be performed with a EMI Receiver set to Quasi Peak detector except for the frequency bands 30 kHz to 90 kHz and 110 kHz to 490 kHz where an average detector will be used according to [2].

On the during the preliminary measurement detected frequencies the final measurement will be performed while rotating the EUT and the measuring antenna in the range of 0 ° to 360 ° around their vertical axis until the maximum value is found.

The resolution bandwidth of the EMI Receiver will be set to the following values:

Frequency range	Resolution bandwidth
9 kHz to 150 kHz	200 Hz
150 kHz to 30 MHz	9 kHz

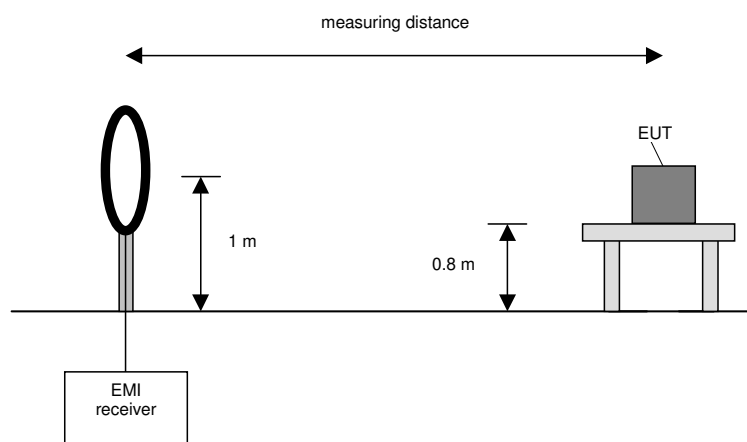

Final measurement procedure:

The following procedure will be used:

- 1) Monitor the frequency range with the measuring antenna at vertical orientation parallel to the EUT at an azimuth of 0 °.
- 2) Rotate the EUT by 360 ° to maximize the detected signals and note the azimuth and orientation.
- 3) Rotate the measuring antenna to find the maximum and note the value.
- 4) Rotate the measuring antenna and repeat steps 1) to 3) until the maximum value is found.
- 5) Repeat steps 1) to 4) with the other orthogonal axes of the EUT (only if the EUT is a module or is used in a handheld application).

Preliminary measurement (30 MHz to 1 GHz)

In the first stage a preliminary measurement will be performed in a fully anechoic chamber with a measuring distance of 3 meter. Table top devices will set up on a non-conducting support with a size of 1 m by 1.5 m and a height of 80 cm. Floor-standing devices will be placed directly on the turntable/ground plane. The setup of the Equipment under test will be in accordance to [1].

The frequency range 30 MHz to 1 GHz will be measured with an EMI Receiver set to MAX Hold mode and a resolution bandwidth of 100 kHz. The measurement will be performed in horizontal and vertical polarisation of the measuring antenna and while rotating the EUT in its vertical axis in the range of 0 ° to 360 °.

The resolution bandwidth of the EMI Receiver will be set to the following values:

Frequency range	Resolution bandwidth
30 MHz to 1 GHz	100 kHz

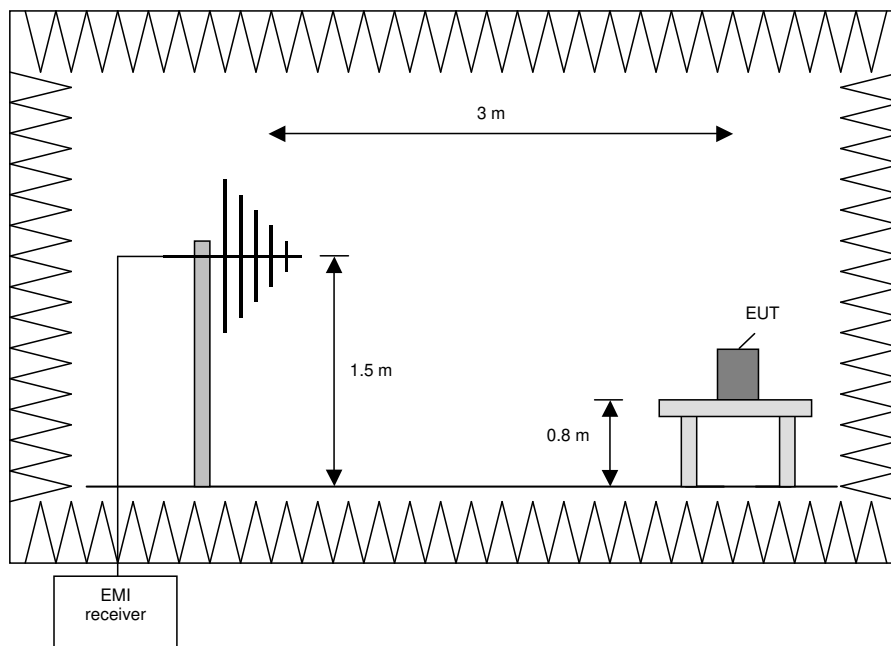

Procedure preliminary measurement:

Prescans were performed in the frequency range 30 MHz to 1 GHz.

The following procedure will be used:

1. Monitor the frequency range at horizontal polarisation and a EUT azimuth of 0 °.
2. Manipulate the system cables within the range to produce the maximum level of emission.
3. Rotate the EUT by 360 ° to maximize the detected signals.
4. Make a hardcopy of the spectrum.
5. Measure the frequency of the detected emissions with a lower span and resolution bandwidth to increase the accuracy and note the frequency value.
6. Repeat 1) to 4) with the other orthogonal axes of the EUT (only if the EUT is a module or is used in a handheld application).
7. Repeat 1) to 5) with the vertical polarisation of the measuring antenna.

Final measurement (30 MHz to 1 GHz)

A final measurement on an open area test site will be performed on selected frequencies found in the preliminary measurement. During this test the EUT will be rotated in the range of 0 ° to 360 °, the measuring antenna will be set to horizontal and vertical polarisation and raised and lowered in the range from 1 m to 4 m to find the maximum level of emissions.

The resolution bandwidth of the EMI Receiver will be set to the following values:

Frequency range	Resolution bandwidth
30 MHz to 1 GHz	120 kHz

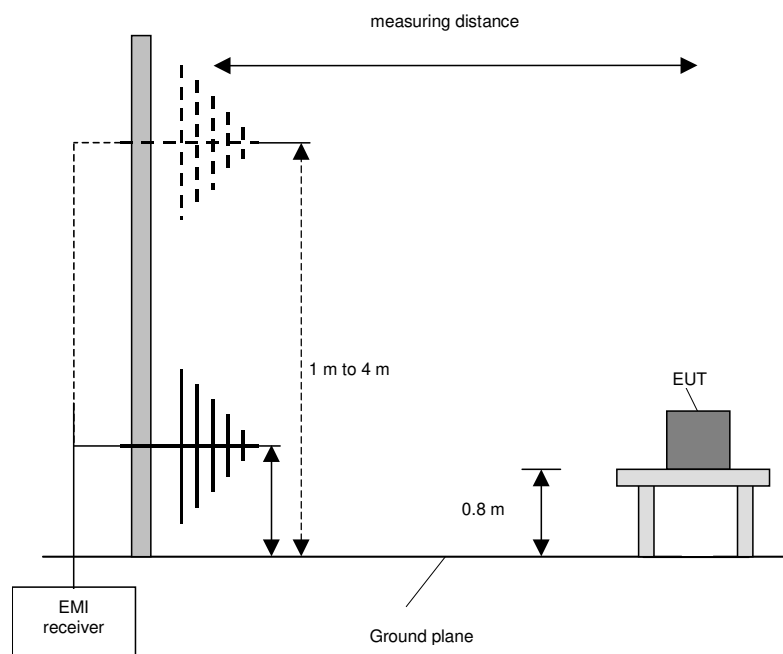

Procedure final measurement:

The following procedure will be used:

- 1) Measure on the selected frequencies at an antenna height of 1 m and a EUT azimuth of 23 °.
- 2) Move the antenna from 1 m to 4 m and note the maximum value at each frequency.
- 3) Rotate the EUT by 45 ° and repeat 2) until an azimuth of 337 ° is reached.
- 4) Repeat 1) to 3) for the other orthogonal antenna polarization.
- 5) Move the antenna and the turntable to the position where the maximum value is detected.
- 6) Measure while moving the antenna slowly +/- 1 m.
- 7) Set the antenna to the position where the maximum value is found.
- 8) Measure while moving the turntable +/- 45 °.
- 9) Set the turntable to the azimuth where the maximum value is found.
- 10) Measure with Final detector (QP and AV) and note the value.
- 11) Repeat 5) to 10) for each frequency.
- 12) Repeat 1) to 11) for each orthogonal axes of the EUT (only if the EUT is a module or is used in a handheld application).

Preliminary and final measurement 1 GHz to 40 GHz

The preliminary and final measurements are performed in a fully anechoic chamber at a measuring distance of 3 meters. Table-top devices are set up on a non-conducting turn device at the height of 1.5 m. The setup of the equipment under test is in accordance with [1].

During the tests the EUT is rotated in the range of 0 ° to 360 ° and the measuring antenna is set to horizontal and vertical polarization to find the maximum level of emissions. After these steps, the measurement is repeated after reorientating the EUT in 30 ° steps.

The resolution bandwidth of the EMI receiver is set to the following values:

Test	Frequency range	Step-size	Resolution bandwidth	Measuring time	Detector
Preliminary measurement	1 - 40 GHz	250 kHz	1 MHz	-	Peak Average
Final measurement	1 - 40 GHz	-	1 MHz	100 ms	Peak Average

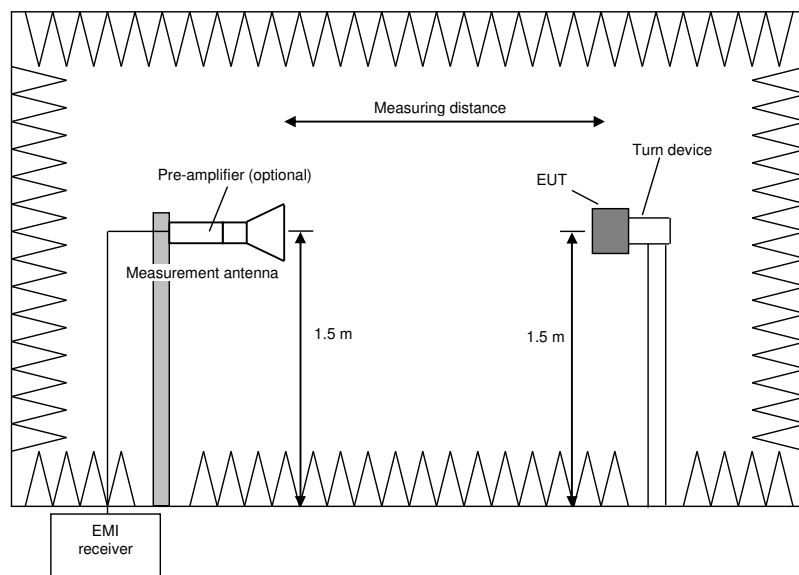

Procedure preliminary measurement:

The following procedure is used:

- 1) Monitor the frequency range at horizontal polarisation of the measuring antenna and an EUT / turntable azimuth of 0 °.
- 2) Rotate the EUT by 360° to maximize the detected signals.
- 3) Repeat steps 1 to 2 with the vertical polarisation of the measuring antenna.
- 4) Repeat steps 1 to 3 with the EUT reorientated by an angle of 30° (60°, 90°, 120° and 150°), according to 6.6.5.4 in [1].
- 5) The highest values for each frequency are saved by the software, including the measuring antenna polarization, the turntable azimuth and the turn device elevation for that value.

Procedure final measurement:

The following procedure is used:

- 1) Set the turntable and the turn device to the position which leads to the highest emission for the first frequency identified in the preliminary measurements.
- 2) Set the measurement antenna to the polarisation which leads to the highest emission for the first frequency identified in the preliminary measurements.
- 3) Set the spectrum analyser to EMI mode with Peak and Average detector activated.
- 4) The worst-case turntable position is found via varying the turntable azimuth by +/- 30° from the value obtained in the preliminary measurement while monitoring the emission level.
- 5) The final measurement is performed at the worst-case turntable azimuth.
- 6) Repeat steps 1 to 5 for each frequency detected during the preliminary measurements.

Preliminary and final measurement (40 GHz to 200 GHz)

The frequency range will be divided into different sub ranges depending on the frequency range of the used horn antennas and frequency mixers. The spectrum analyser set to MAX Hold mode and a resolution bandwidth of 1 MHz. The measurement will be performed in horizontal and vertical polarisation of the measuring antenna, the antenna close to the EUT and while moving the antenna over all sides of the EUT. With the spectrum analyser in CLEAR / WRITE mode the cone of the emission should be found. After that the measuring distance will be set to the final measurement distance with the receiving antenna moving in this cone of emission. At this position the final measurement will be carried out with using the Auto ID functionality of the analyser. The used measuring distance for the used antenna has to be above the minimum measuring distance calculated for accreditation.

The resolution bandwidth of the EMI Receiver will be set to the following values:

Test	Frequency range	Resolution bandwidth	Measuring time	Detector
Preliminary measurement	40 GHz - 200 GHz	1 MHz	-	Peak
Final measurement	40 GHz - 200 GHz	1 MHz	At least 1 ms per sweep point	Peak and average

Set up preliminary measurement:

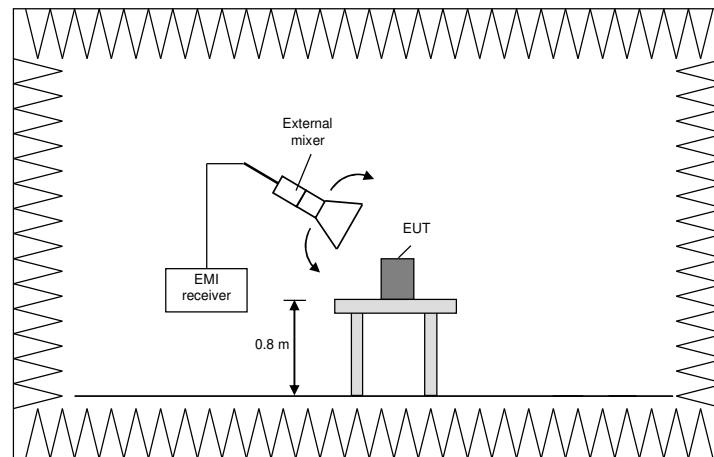

Set up final measurement:

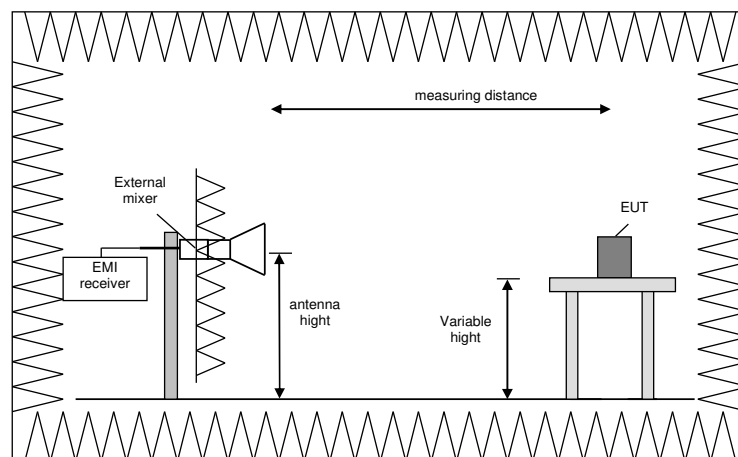

Procedure of measurement:

The measurements were performed in the frequency range 40 GHz to 50 GHz, 50 GHz to 75 GHz, 75 GHz to 110 GHz, 110 GHz to 155 GHz and 155 GHz to 200 GHz.

The following procedure will be used:

- 1) Monitor the frequency range at horizontal polarisation and move the antenna over all sides of the EUT (if necessary) move the EUT to another orthogonal axis).
 - 2) Change the antenna polarisation and repeat 1) with vertical polarisation.
 - 3) Make a hardcopy of the spectrum.
 - 4) Measure the frequency of the detected emissions with a lower span and resolution bandwidth to increase the accuracy and note the frequency value.
 - 5) Change the analyser mode to Clear / Write and found the cone of emission.
 - 6) Rotate and move the EUT, so that the measuring distance can be enlarged to 3 m and the antenna will be still inside the cone of emission.
 - 7) Measure the level of the detected frequency with the correct resolution bandwidth, with the antenna polarisation and azimuth and the peak and average detector, which causes the maximum emission.
 - 8) Repeat steps 1) to 7) for the next antenna spot if the EUT is larger than the antenna beamwidth.
- Step 1) to 6) are defined as preliminary measurement.

5.3.2 Test results (radiated emissions)

5.3.2.1 Preliminary radiated emission measurement (1 MHz to 60 GHz)

Ambient temperature:	19 °C to 22 °C
Relative humidity:	31 % to 41 %

Date:	31.01.2024 til 13.02.2024
Tested by:	Thomas KÜHN

Position of EUT: The EUT was set-up on a non-conducting turn device of a height of 1.5 m (1 GHz to 40 GHz) and on a non-conducting table of a height of 80 cm (below 1 GHz and 40 GHz to 60 GHz). The distance between EUT and the antenna was 3 m (below 1 GHz and 1 GHz to 12 GHz), 1 m (12 GHz to 40 GHz) and 30 cm (40 GHz to 60 GHz).

Cable guide: For further information refer to the pictures in annex A of this test report.

Test record: The test was carried out in normal operation mode of the EUT.

Supply voltage: During all measurements the EUT was supplied with 12 V_{DC} by an external power supply.

Radiated emissions from 1 MHz to 30 MHz:

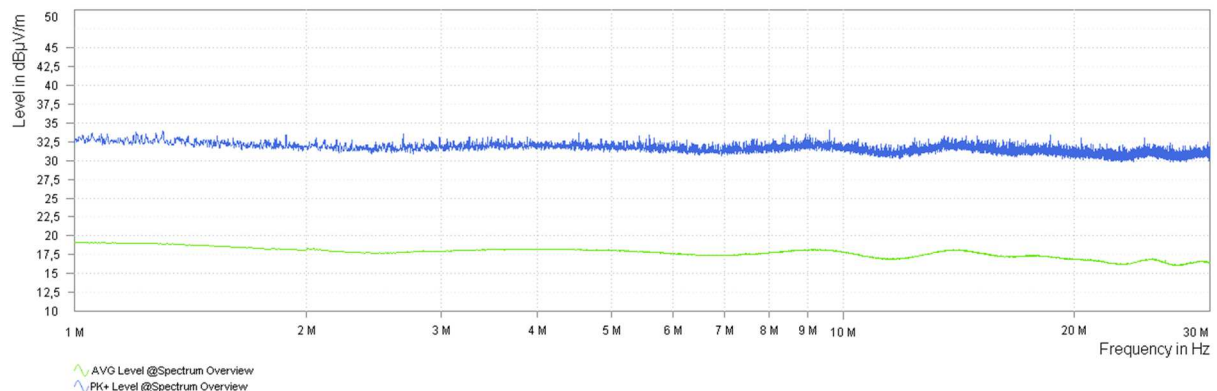

No emissions above the noise floor of the measurement system (max. 33.8 dBµV/m (measured with peak detector at 3 m distance)) found during the preliminary measurement. So, no final measurements on the outdoor test site were carried out.

Test equipment (please refer to chapter 6 for details)
6 – 38

Radiated emissions from 30 MHz to 1000 MHz:

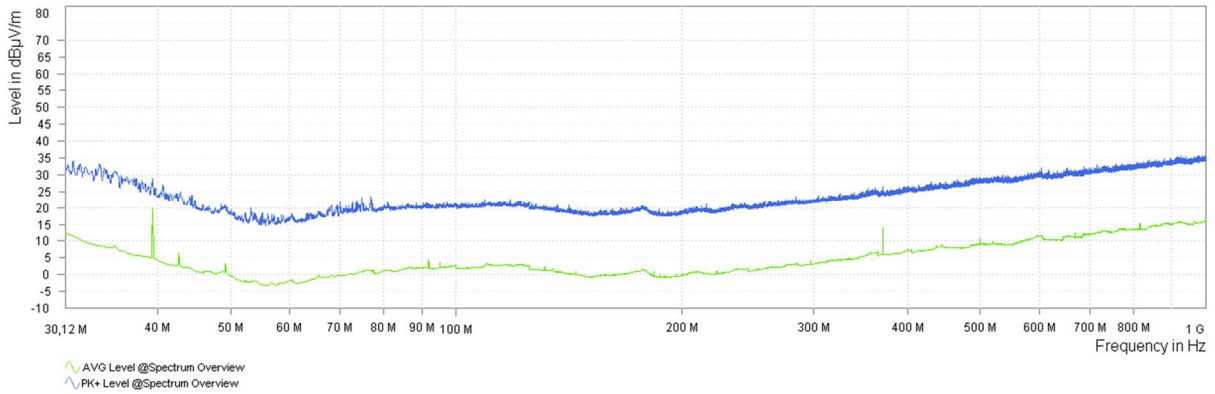

The following frequencies were found during the preliminary radiated emission measurement:

- 30.690 MHz, 39.360 MHz, 42.540 MHz, 42.810 MHz, 371.280 MHz, 602.460 MHz and 926.370 MHz.

On these frequencies a final measurement has to be carried out. The result of this final measurement is presented in the following.

Radiated emissions from 1 GHz to 12 GHz:

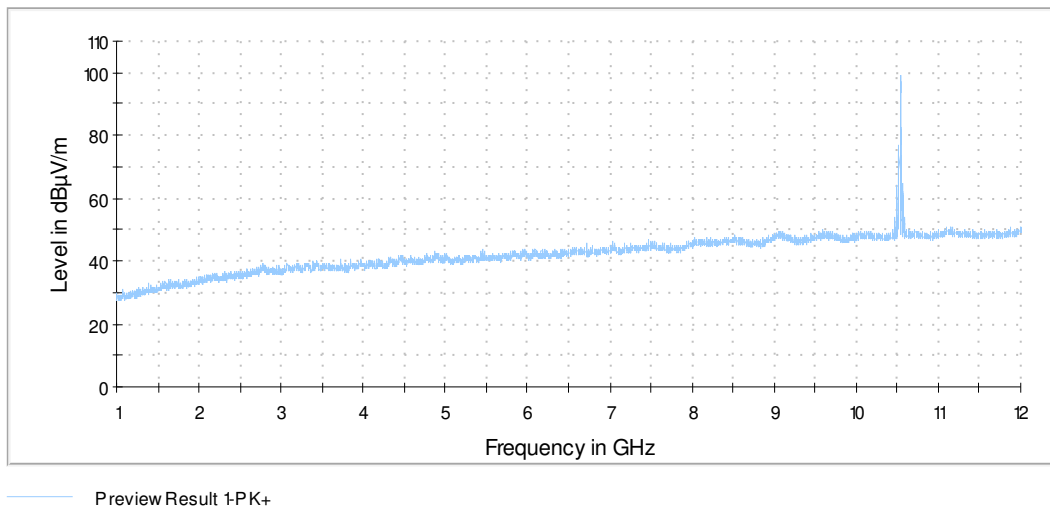

Radiated emissions from 12 GHz to 18 GHz:

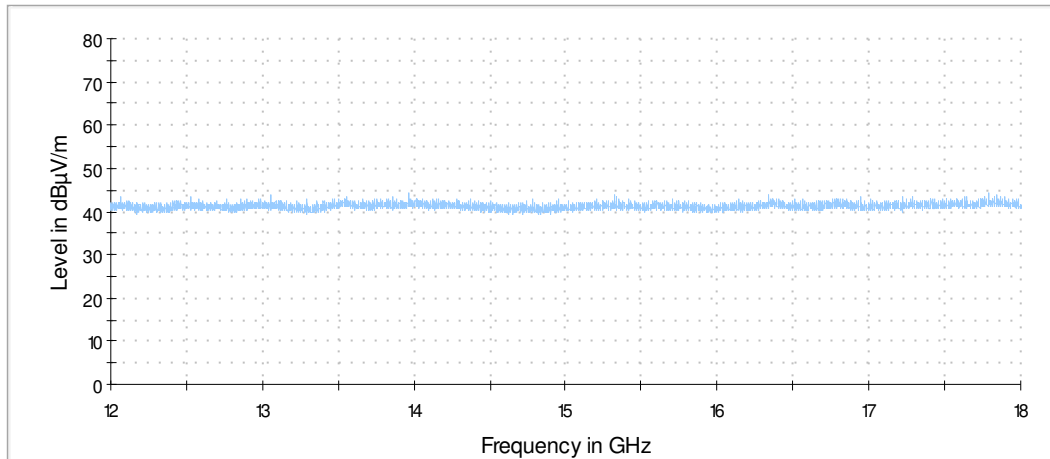

Preview Result 1PK+

Radiated emissions from 18 GHz to 26.5 GHz:

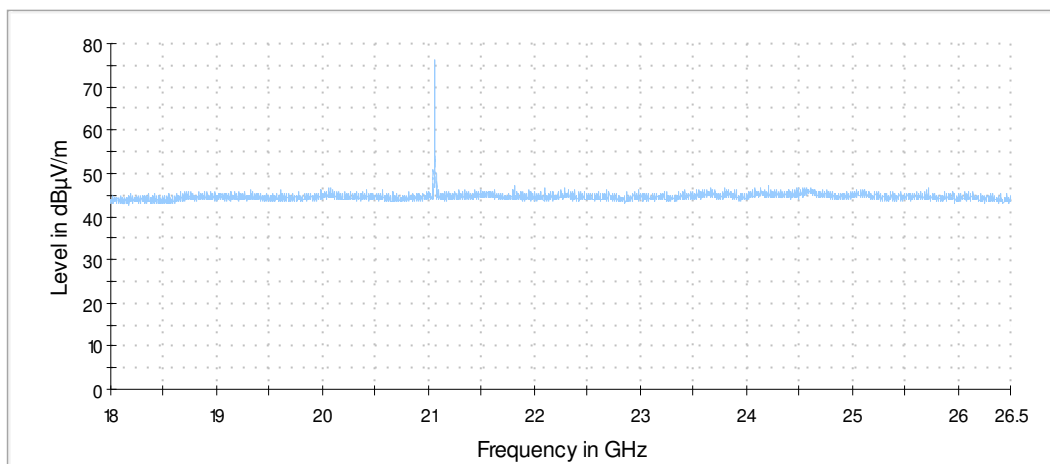

Preview Result 1PK+

Radiated emissions from 26.5 GHz to 40 GHz:

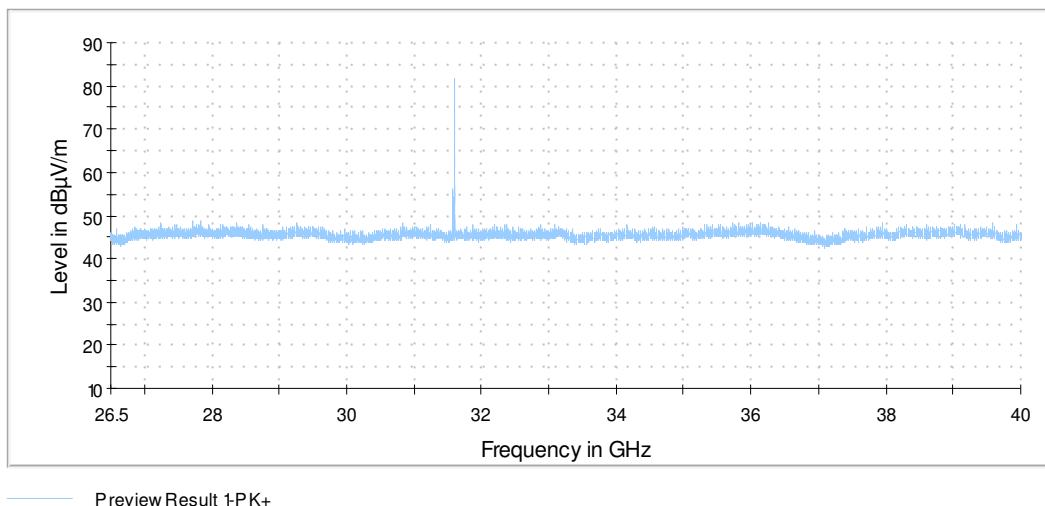

231953 10.png: Radiated emissions from 40 GHz to 60 GHz:

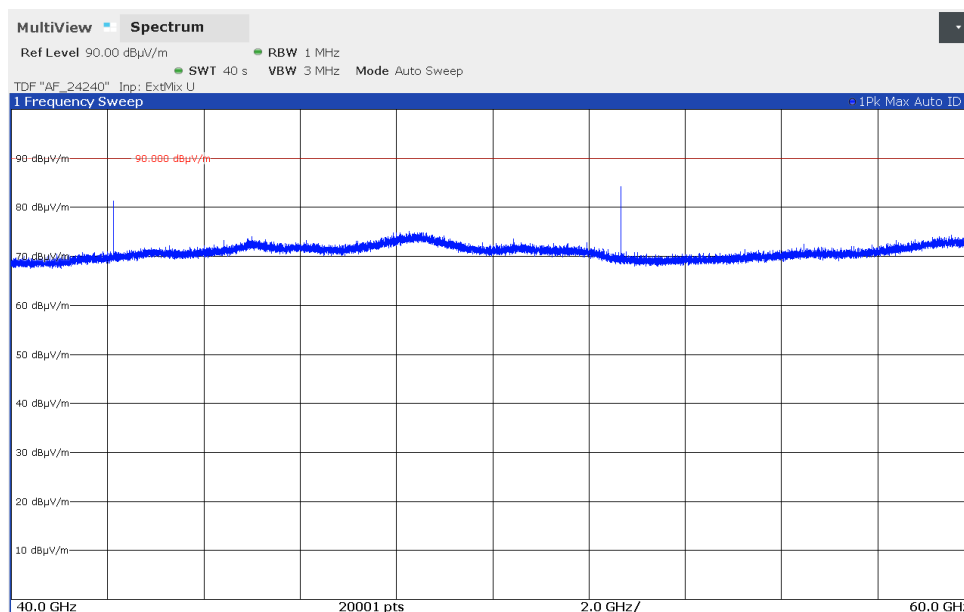

The following fundamental frequency was found during the preliminary radiated emission measurement:

- 10.532 GHz.

The following harmonic emission frequencies were found during the preliminary radiated emission measurement:

- 21.064 GHz, 31.596 GHz, 42.128 GHz, and 52.660 GHz.

The following other emission was found during the preliminary radiated emission measurement:

- 9.509 GHz.

These frequencies have to be measured in a final measurement. The results were presented in the following.

5.3.2.2 Final radiated emission measurement (1 MHz to 30 MHz)

No emissions above the noise floor of the measurement system (max. 33.8 dB μ V/m (measured with peak detector at 3 m distance)) found during the preliminary measurement. So, no final measurements on the outdoor test site were carried out.

5.3.2.3 Final radiated emission measurement (30 MHz to 1 GHz)

Ambient temperature:	18 °C
Relative humidity:	41 %

Date:	13.02.2024
Tested by:	Thomas KÜHN

Position of EUT: The EUT was set-up on a non-conducting table of a height of 0.8 m. The distance between EUT and antenna was 3 m.

Test record: All results are shown in the following.

Supply voltage: 12.0 V_{DC} by an external power supply.

Test results: The test results were calculated with the following formula:

$$\text{Result [dB}\mu\text{V/m]} = \text{reading [dB}\mu\text{V]} + \text{level correction [dB]}$$

$$\text{Level correction [dB]} = + \text{cable loss [dB]} + \text{antenna factor [dB/m]} - \text{Preamp [dB]}$$

The measured points and the limit line in the following diagram refer to the standard measurement of the emitted interference in compliance with the above-mentioned standard. The measured points marked with "◇" are the measured results of the standard subsequent measurement on the semi anechoic chamber.

Final radiated emissions from 30 MHz to 1000 MHz:

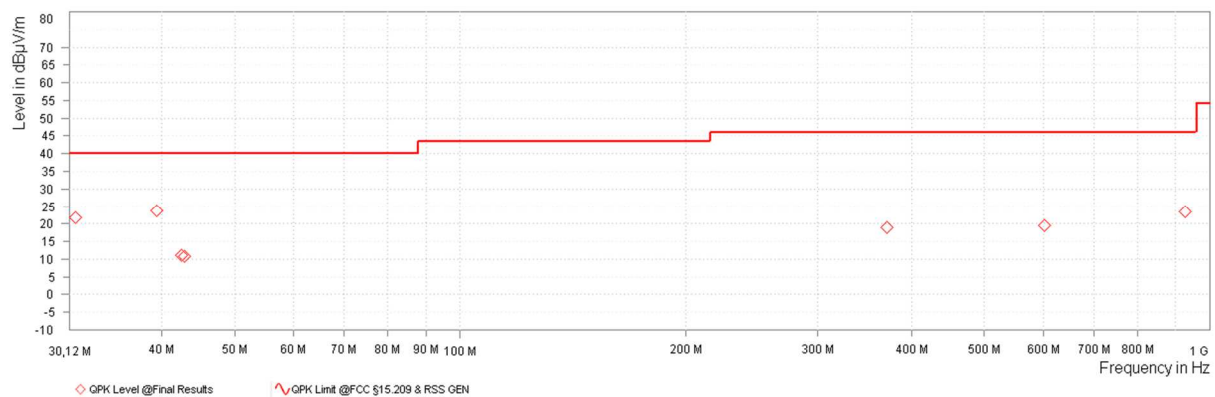

The results of the standard subsequent measurement inside the semi anechoic chamber are indicated in the table below. The limits as well as the measured results (levels) refer to the above-mentioned standard while taking account of the specified requirements for a 3 m measuring distance.

The measurement time with the quasi-peak measuring detector is 1 second.

Result measured with the quasi-peak detector:
(These values were marked in the diagram by an \diamond)

Spurious emissions inside restricted bands									
Frequency MHz	Result dB μ V/m	Limit dB μ V/m	Margin dB	Readings dB μ V	Level correction [dB]	Height cm	Azimuth deg	Pol.	Test result
30.690	21.7	40.0	18.3	-3.8	25.5	109	327	Hor.	Passed
39.360	23.8	40.0	16.2	3.4	20.4	101	328	Vert.	Passed
42.540	11.0	40.0	29.0	-7.4	18.4	102	330	Hor.	Passed
42.810	10.8	40.0	29.2	-7.4	18.2	132	332	Hor.	Passed
371.280	18.9	46.0	27.1	-2.0	20.9	239	265	Vert.	Passed
602.460	19.5	46.0	26.5	-6.2	25.7	378	64	Vert.	Passed
926.370	23.5	46.0	22.5	-6.2	29.7	425	234	Vert.	Passed

Test equipment (please refer to chapter 6 for details)

6 – 12, 14, 15, 27, 28

5.3.2.4 Final radiated emission measurement (1 GHz to 60 GHz)

Ambient temperature:	20 °C
Relative humidity:	34 %

Date:	02.02.2024
Tested by:	Thomas KÜHN

Position of EUT: The EUT was set-up on a non-conducting turn device of a height of 1.5 m (1 GHz to 40 GHz) and on a non-conducting table of a height of 80 cm (40 GHz to 60 GHz). The distance between EUT and the antenna was 3 m (1 GHz and 1 GHz to 26.5 GHz), 1 m (26.5 GHz to 40 GHz) and 30 cm (40 GHz to 60 GHz).

Test record: All results are shown in the following.

Supply voltage: During all measurements the EUT was supplied with 12.0 V_{DC}.

Resolution bandwidth: For all measurements a resolution bandwidth of 1 MHz was used.

Test results: The test results were calculated with the following formulas:

Result [dB μ V/m] = reading [dB μ V] + level correction [dB] + measuring distance correction factor [dB]

Level correction [dB] = + cable loss [dB] + antenna factor [dB/m] – Preamp [dB]

Result measured with the peak detector:

Frequency [GHz]	Result [dB μ V/m]	Limit [dB μ V/m]	Margin [dB]	Reading [dB μ V]	Pol.	Azimuth [deg]	Elevation [deg]	Level correction [dB]	Dist. [m]	Dist corr. [dB] *	Test result
9.509	51.0	74.0	23.0	44.3	Vert.	256	0	6.7	3	---	Passed
10.532 ***	101.3	148.0	46.7	94.5	Hor.	47	30	6.8	3	---	Passed
21.064 ****	76.2	97.5	21.3	72.4	Vert.	358	60	3.8	3	---	Passed
31.596 ****	72.8	97.5	24.7	75.9	Hor.	297	30	6.4	1	-9.5	Passed
42.128 ****	66.9	97.5	30.6	86.9 **	Vert.	17	0	---	0.3	-20	Passed
52.660 ****	67.4	97.5	30.1	87.4 **	Vert.	19	92	---	0.3	-20	Passed

*: Measuring distance correction factor calculated with 20 dB / decade

** : Reading in dB μ V/m at the measurement distance

***: Wanted signal, no spurious

****: Harmonic emission.

Result measured with the average detector:

Frequency [GHz]	Result [dB μ V/m]	Limit [dB μ V/m]	Margin [dB]	Reading [dB μ V]	Pol.	Azimuth [deg]	Elevation [deg]	Level correction [dB]	Dist. [m]	Dist corr. [dB] *	Test result
9.509	40.7	54.0	13.3	34.0	Vert.	256	0	6.7	3	---	Passed
10.532 ***	53.7	128.0	74.3	56.9	Hor.	47	30	6.8	3	---	Passed
21.064 ****	35.1	77.5	42.4	31.3	Vert.	358	60	3.8	3	---	Passed
31.596 ****	28.9	77.5	48.6	32.0	Hor.	297	30	6.4	1	-9.5	Passed
42.128 ****	44.2	77.5	33.3	64.2 **	Vert.	17	0	---	0.3	-20	Passed
52.660 ****	44.2	77.5	33.3	64.2 **	Vert.	19	92	---	0.3	-20	Passed

*: Measuring distance correction factor calculated with 20 dB / decade

** : Reading in dB μ V/m at the measurement distance

***: Wanted signal, no spurious

****: Harmonic emission.

Test equipment (please refer to chapter 6 for details)
16 – 38

5.4 Conducted emissions on power supply lines (150 kHz to 30 MHz)

5.4.1 Method of measurement

This test will be carried out in a shielded chamber. Tabletop devices will set up on a non-conducting support with a size of 1 m by 1.5 m and a height of 80 cm above the ground plane. Floor-standing devices will be placed directly on the ground plane. The setup of the Equipment under test will be in accordance to [1].

The frequency range 150 kHz to 30 MHz will be measured with an EMI Receiver set to MAX Hold mode with peak and average detector and a resolution bandwidth of 9 kHz. A scan will be carried out on the phase (or plus pole in case of DC powered devices) of the AC mains network. If levels detected 10 dB below the appropriate limit, this emission will be measured with the average and quasi-peak detector on all lines.

Frequency range	Resolution bandwidth
150 kHz to 30 MHz	9 kHz

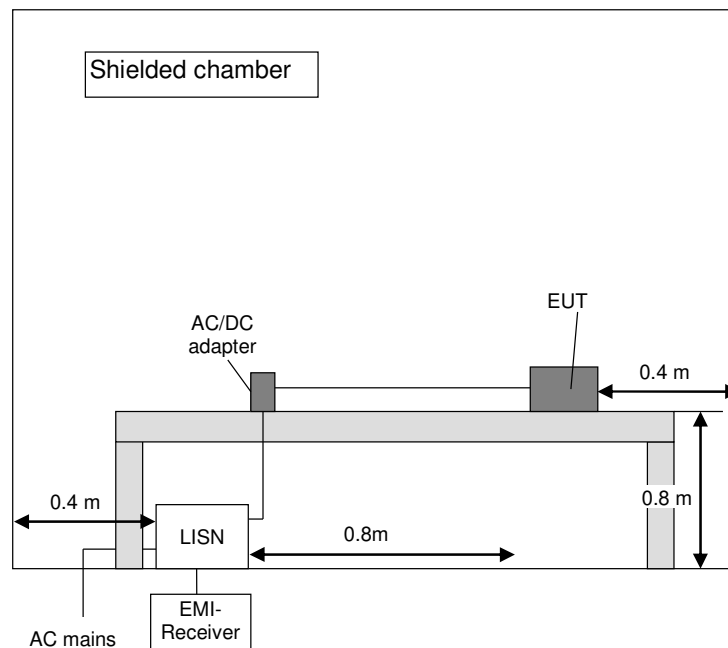

5.4.2 Test results (conducted emissions on power supply lines)

Ambient temperature:	21 °C
Relative humidity:	37 %

Date:	02.02.2024
Tested by:	Thomas KÜHN

- Position of EUT: The EUT was set-up on a non-conducting table of a height of 0.8 m.
- Cable guide: The cable of the EUT was fixed on the non-conducting table. For further information of the cable guide refer to the pictures in annex A of this test report.
- Test record: All results are shown in the following.
- Supply voltage: The EUT was supplied with 12 V_{DC} by an AC/DC adaptor type enercell CAT.NO. 273-316, which was connected to an AC mains network with 120 V_{AC} / 60 Hz.

The curves in the diagram only represent for each frequency point the maximum measured value of all preliminary measurements, which were made for each power supply line. The top measured curve represents the peak measurement and the bottom measured curve the average measurement.

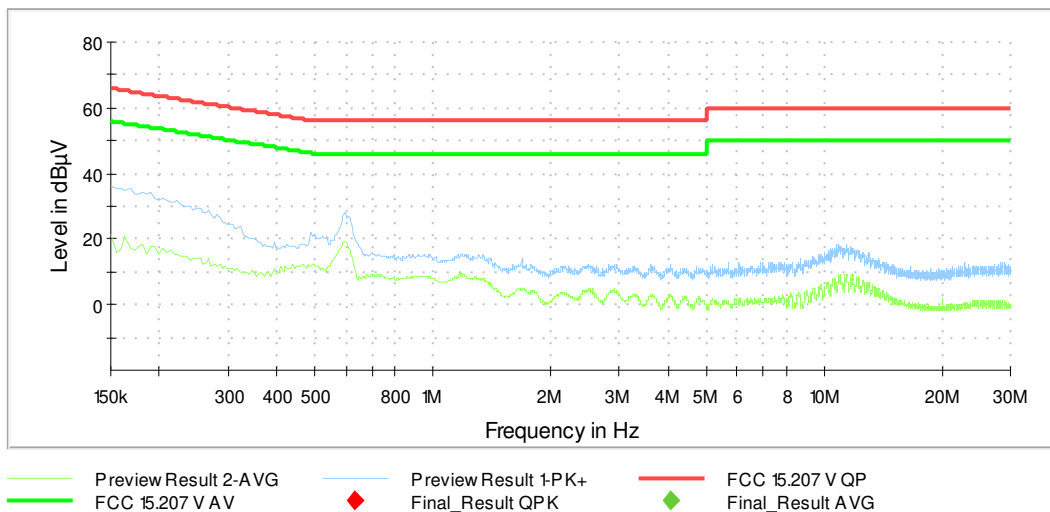

Remark: No final measurements with quasi peak or average detector were carried out, because the preliminary measurement results (measured with peak detector) already were at least 30 dB below the limit.

Test: Passed

Test equipment (please refer to chapter 6 for details)

1 – 5

6 Test equipment and ancillaries used for tests

No.	Test equipment	Type	Manufacturer	Serial No.	PM. No.	Cal. Date	Cal. due
1	Shielded chamber M4	-	Siemens AG	B83117-S1-X158	480088	Calibration not necessary	
2	EMI Receiver	ESIB 26	Rohde & Schwarz	1088.7490	481182	16.02.2022	02.2024
3	LISN	NSLK8128	Schwarzbeck	8128161	480138	15.02.2022	02.2024
4	Transient Limiter	CFL 9206A	Teseq GmbH	38268	481982	Calibration not necessary	
5	System software EMC32 M4	EMC32	Rohde & Schwarz	100061	481022	Calibration not necessary	
6	Semi anechoic chamber M276	SAC5-2	Albatross Projects	C62128-A540-A138-10-0006	483227	Calibration not necessary	
7	RF Switch Matrix	OSP220	Rohde & Schwarz	-	482976	Calibration not necessary	
8	Turntable	TT3.0-3t	Maturo	825/2612/.01	483224	Calibration not necessary	
9	Controller	NCD	Maturo	474/2612.01	483226	Calibration not necessary	
10	Antenna support	BAM 4.5-P-10kg	Maturo	222/2612.01	483225	Calibration not necessary	
11	System software EMC32 M276	EMC32	Rohde & Schwarz	100970	482972	Calibration not necessary	
12	Antenna (Bilog)	HL562E	Rohde & Schwarz	101079	482978	18.03.2021	03.2024
13	Loop antenna	HFH2-Z2	Rohde & Schwarz	832609/014	480059	22.02.2022	02.2024
14	EMI Test receiver ESW	ESW44	Rohde & Schwarz	101819	482979	08.12.2021	02.2024
15	Cable C416	Sucoflex 118	Huber+Suhner	500654/118	-	Calibration not necessary	
16	Fully anechoic chamber M20	-	Albatross Projects	B83107-E2439-T232	480303	Calibration not necessary	
17	System software EMC32 M20	EMC32	Rohde & Schwarz	-	483261	Calibration not necessary	
18	EMI Receiver / Spectrum Analyser	ESW44	Rohde & Schwarz	101635	482467	22.02.2022	02.2024
19	Controller	MCU	Maturo	MCU/043/971107	480832	Calibration not necessary	
20	Turntable	DS420HE	Deisel	420/620/80	480315	Calibration not necessary	
21	Turn device	TDF 1.5-10Kg	Maturo	15920215	482034	Calibration not necessary	
22	Antenna support	AS615P	Deisel	615/310	480187	Calibration not necessary	
23	Log.-Per. Antenna	HL050	Rohde & Schwarz	100977	483511	05.03.2021	03.2024
24	RF-cable No. 36	Sucoflex 106B	Suhner	0587/6B	480865	Calibration not necessary	
25	RF-cable No. 38	Sucoflex 106B	Suhner	500218/6B	482415	Calibration not necessary	
26	Preamplifier 100 MHz – 16 GHz	AFS6-00101600-23-10P-6-R	MITEQ	2011215	482333	17.02.2022	02.2024

No.	Test equipment	Type	Manufacturer	Serial No.	PM. No.	Cal. Date	Cal. due
27	Power supply	TOE 8752	Toellner	31566	480010	Calibration not necessary	
28	Multimeter	971A	Hewlett Packard	JP39009365	480722	29.06.2023	06.2024
29	Standard Gain Horn 11.9 GHz – 18 GHz	18240-20	Flann Microwave	483	480294	Calibration not necessary	
30	Preamplifier 12 GHz - 18 GHz	JS3- 12001800- 16-5A	MITEQ	571667	480343	17.02.2022	02.2024
31	Standard Gain Horn 17.9 GHz – 26.7 GHz	20240-20	Flann Microwave	410	480296	Calibration not necessary	
32	Preamplifier 18 GHz - 26 GHz	JS4- 18002600- 20-5A	MITEQ	658697	480342	17.02.2022	02.2024
33	Standard Gain Horn 26.4 GHz – 40.1 GHz	22240-20	Flann Microwave	469	480299	Calibration not necessary	
34	Preamplifier 26 GHz - 40 GHz	JDM2- 26004000- 25-10P	MITEQ	128746	482806	17.02.2022	02.2024
35	RF-cable 2 m	KPS-1533- 800-KPS	Insulated Wire	-	480302	Calibration not necessary	
36	Spectrum Analyser	FSW43	Rohde & Schwarz	100586 & 100926	481720	17.03.2023	03.2025
37	Harmonic mixer 40 GHz - 60 GHz	FS-Z60	Radiometer Physics	100980	482708	22.03.2023	03.2025
38	Standard Gain Horn 40 GHz - 60 GHz	24240-20	Flann	263442	482858	Calibration not necessary	

7 Test site Validation

Test equipment	PM. No.	Frequency range	Type of validation	According to	Val. Date	Val Due
Shielded chamber M4	480088	9 kHz – 30 MHz	GND-Plane	ANSI C63.4-2014 + ANSI C63.4a-2017 +	08.11.2022	07.11.2025
Semi anechoic chamber M276	483227	30 – 1000 MHz	NSA/RSM	CISPR 16-1-4 + Cor1:2010 + A1:2012 +A2:2017	01.03.2023	28.02.2026
Fully anechoic chamber M20	480303	1 -18 GHz	SVSWR	CISPR 16-1-4 Amd. 1	17.08.2022	08.2025

8 Measurement uncertainties

Measurement method	Standard used for calculating measurement uncertainty	Expanded measurement uncertainty (95 %) U_{lab}
Conducted measurements		
Conducted emissions from 150 kHz to 30 MHz with LISN	CISPR 16-4-2	2.8 dB
Radiated measurements		
Frequency error		
(Semi-) Anechoic chamber	ETSI TR 100 028	4.5×10^{-8}
OATS	ETSI TR 100 028	4.5×10^{-8}
Test fixture	ETSI TR 100 028	4.5×10^{-8}
Bandwidth measurements		
(Semi-) Anechoic chamber	-	9.0×10^{-8}
OATS	-	9.0×10^{-8}
Test fixture	-	9.1×10^{-8}
Radiated field strength M20		
R&S HL050 @ 3 m		
1 GHz – 6 GHz	CISPR 16-4-2	5.1 dB
6 GHz – 18 GHz	CISPR 16-4-2	5.4 dB
Flann Standard Gain Horns 12 GHz – 40 GHz	-	5.9 dB
Radiated field strength M276		
R&S HL562E @ 3 m 30 MHz – 1 GHz	CISPR 16-4-2	4.8 dB
Radiated field strength outdoor test site		
R&S HFH2-Z2 9 kHz to 30 MHz	CISPR 25	4.4 dB
Radiated emissions above 40 GHz		
40 GHz – 60 GHz	-	7.0 dB

9 Report history

Report Number	Date	Comment
F231953E1	23.02.2024	Document created

10 List of annexes

Annex A	Test setup photos	9 pages
Annex B	External EUT photos	6 pages
Annex C	Internal EUT photos	5 pages