



FCC PART 15, SUBPART C
TEST AND MEASUREMENT REPORT

For

CentraLite Systems Inc.

1000 Cody Road, Suite A,
 Mobile, Alabama 36695, USA

FCC ID: T3L-SS009

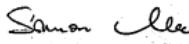
Report Type: Original Report	Product Type: Home Automation Gateway
Prepared By: <u>Bo Li</u> 	
Report Number: <u>R1412054-247 ZigBee</u>	
Report Date: <u>2015-04-21</u>	
Reviewed By: <u>Simon Ma</u> 	
Reviewed By: <u>RF Lead</u>	
Bay Area Compliance Laboratories Corp. 1274 Anvilwood Avenue, Sunnyvale, CA 94089, USA Tel: (408) 732-9162 Fax: (408) 732-9164	

Note: This test report is prepared for the customer shown above and for the device described herein. It may not be duplicated or used in part without prior written consent from Bay Area Compliance Laboratories Corp. This report **must not** be used by the customer to claim product certification, approval, or endorsement by A2LA*, NIST, or any agency of the Federal Government.

* This report may contain data that are not covered by the A2LA accreditation and are marked with an asterisk "*" en-02

TABLE OF CONTENTS

1	General Description.....	5
1.1	Product Description for Equipment under Test (EUT)	5
1.2	Mechanical Description of EUT	5
1.3	Objective.....	5
1.4	Related Submittal(s)/Grant(s)	5
1.5	Test Methodology	5
1.6	Measurement Uncertainty	5
1.7	Test Facility	6
2	System Test Configuration.....	7
2.1	Justification	7
2.2	EUT Exercise Software.....	7
2.3	Special Equipment	7
2.4	Equipment Modifications.....	7
2.5	Local Support Equipment	7
2.6	External Support Equipment.....	7
2.7	EUT Internal Configuration Details.....	8
2.8	Interface Ports and Cables	8
2.9	Power Supply List and Details.....	8
3	Summary of Test Results	9
4	FCC §15.247(i) & §2.1091– RF Exposure.....	10
4.1	Applicable Standard.....	10
4.2	MPE Prediction.....	10
4.3	MPE Results	10
5	FCC §15.203– Antenna Requirements.....	11
5.1	Applicable Standard.....	11
5.2	Antenna Description	11
6	FCC §15.207– AC Line Conducted Emissions	12
6.1	Applicable Standards	12
6.2	Test Setup	12
6.3	Test Procedure	12
6.4	Test Setup Block Diagram	13
6.5	Corrected Amplitude & Margin Calculation.....	13
6.6	Test Equipment List and Details.....	14
6.7	Test Environmental Conditions	14
6.8	Summary of Test Results.....	14
6.9	Conducted Emissions Test Plots and Data.....	15
7	FCC §15.205 §15.209, §15.247(d)– Spurious Radiated Emissions.....	17
7.1	Applicable Standard.....	17
7.2	Test Setup	18
7.3	Test Procedure	18
7.4	Corrected Amplitude & Margin Calculation.....	19
7.5	Test Equipment List and Details.....	19
7.6	Test Environmental Conditions	19
7.7	Summary of Test Results.....	20
7.8	Radiated Emissions Test Results	21
8	FCC §15.247(a)(2)– 6 dB & 99% Emission Bandwidth	24
8.1	Applicable Standard.....	24
8.2	Measurement Procedure.....	24
8.3	Test Equipment List and Details.....	24

8.4 Test Environmental Conditions 24

8.5 Test Results and Plots 25

9 FCC §15.247(b) – Peak Output Power Measurement 26

9.1 Applicable Standard..... 26

9.2 Measurement Procedure..... 26

9.3 Test Equipment List and Details..... 26

9.4 Test Environmental Conditions 26

9.5 Test Results..... 27

10 FCC §15.247(d)– 100 kHz Bandwidth of Band Edges..... 28

10.1 Applicable Standard..... 28

10.2 Measurement Procedure..... 28

10.3 Test Equipment List and Details..... 28

10.4 Test Environmental Conditions 28

10.5 Test Results..... 29

11 FCC §15.247(e) – Power Spectral Density 30

11.1 Applicable Standard..... 30

11.2 Measurement Procedure..... 30

11.3 Test Equipment List and Details..... 30

11.4 Test Environmental Conditions 30

11.5 Test Results..... 31

12 Exhibit A – FCC Equipment Labeling Requirements..... 32

12.1 FCC ID Label Requirements 32

12.2 FCC ID Label and Location..... 32

13 Exhibit B – Test Setup Photographs 34

13.1 Radiated Emission below 1 GHz Front View 34

13.2 Radiated Emission below 1 GHz Rear View 34

13.3 Radiated Emission above 1 GHz Front View 35

13.4 Radiated Emission above 1 GHz Rear View 35

13.5 AC Line Conducted Emission Front View 36

13.6 AC Line Conducted Emission Side View..... 36

14 Exhibit C – EUT Photographs..... 37

14.1 EUT Top View..... 37

14.2 EUT Rear View 37

14.4 Main Board Top View 38

14.5 Main Board Rear View 39

14.6 Power Adapter 39

DOCUMENT REVISION HISTORY

Revision Number	Report Number	Description of Revision	Date of Revision
0	R1412054-247 ZigBee	Original Report	2015-04-21

1 General Description

1.1 Product Description for Equipment under Test (EUT)

This test and measurement report was prepared on behalf of *CentraLite Systems, Inc.*, and their product *IC: I2192A-SS009; model number: 9402*, as the “EUT” (Equipment under Testing) as referred to in this report. The EUT is a Home automation gateway.

1.2 Mechanical Description of EUT

The EUT measures approximately 10.7 cm (L) x 12.3 cm (W) x 3.4 cm (H) and weighs 0.05 kg.

Note: The EUT was tested without enclosure.

The test data gathered are from typical production sample, serial number: R1412054-01 assigned by BACL.

1.3 Objective

This report is prepared on behalf of *SmartThings Inc.* in accordance with Part 2, Subpart J, and Part 15, Subparts B and C of the Federal Communication Commission’s rules

The objective is to determine compliance with FCC Part 15.247 rules for Output Power, Antenna Requirements, 6 dB Bandwidth, and power spectral density, 100 kHz Bandwidth of Band Edges Measurement, Spurious Emissions, Conducted and Radiated Spurious Emissions.

1.4 Related Submittal(s)/Grant(s)

N/A

1.5 Test Methodology

All measurements contained in this report were conducted in accordance with ANSI C63.10-2009, American National Standard of Procedures for Compliance Testing of Unlicensed Wireless Devices and FCC KDB 558074 D01 DTS Meas Guidance v03r02: Guidance for Performing Compliance Measurements on Digital Transmission Systems (DTS) Operating Under §15.247

1.6 Measurement Uncertainty

All measurements involve certain levels of uncertainties, especially in the field of EMC. The factors contributing to uncertainties are spectrum analyzer, cable loss, antenna factor calibration, antenna directivity, antenna factor variation with height, antenna phase center variation, antenna factor frequency interpolation, measurement distance variation, site imperfections, mismatch (average), and system repeatability.

The following calculation follows the procedures as set forth in clause 7.2.3, ETSI TR 100 028-1 V1.4.1 (2001-12), the expression of Uncertainty in Radiated RF Testing is in accordance to ISO/IEC 17025 and TR 100 028-1 V1.4.1 (2001-12).

The expanded Measurement Uncertainty value having a confidence factor of 95%, is within a range of 5.48 dB. This means that the value of conducted RF carrier power test will be within +/- 2.74 dB of the measuring radiated emissions power versus the expected value.

The expected value is defined as the power at the antenna of the Transmitter under Test.

1.7 Test Facility

Bay area compliance Laboratories Corp. (BACL) is:

1- An independent Commercial Test Laboratory accredited to **ISO 17025: 2005** by **A2LA**, in the fields of: Electromagnetic Compatibility & Telecommunications covering Emissions, Immunity, Radio, RF Exposure, Safety and Telecom. This includes NEBS (Network Equipment Building System), Wireless RF, Telecommunications Terminal Equipment (TTE); Network Equipment; Information Technology Equipment (ITE); Medical Electrical Equipment; Industrial, Commercial, and Medical Test Equipment; Professional Audio and Video Equipment; Electronic (Digital) Products; Industrial and Scientific Instruments; Cabled Distribution Systems and Energy Efficiency Lighting.

2- An ENERGY STAR Recognized Laboratory, for the LM80 Testing, a wide variety of Luminaires and Computers.

3- A NIST Designated Phase-I and Phase-II CAB including: ACMA (Australian Communication and Media Authority), BSMI (Bureau of Standards, Metrology and Inspection of Taiwan), IDA (Infocomm Development Authority of Singapore), IC(Industry Canada), Korea (Ministry of Communications Radio Research Laboratory), NCC (Formerly DGT; Directorate General of Telecommunication of Chinese Taipei) OFTA (Office of the Telecommunications Authority of Hong Kong), Vietnam, VCCI - Voluntary Control Council for Interference of Japan and a designated EU CAB (Conformity Assessment Body) (Notified Body) for the EMC and R&TTE Directives.

4- A Product Certification Body accredited to **ISO Guide 65: 1996** by **A2LA** to certify:

1- Unlicensed, Licensed radio frequency devices and Telephone Terminal Equipment for the FCC. Scope A1, A2, A3, A4, B1, B2, B3, B4 & C.

2. Radio Standards Specifications (RSS) in the Category I Equipment Standards List and All Broadcasting Technical Standards (BETS) in Category I Equipment Standards List for Industry Canada.

3. Radio Communication Equipment for Singapore.

4. Radio Equipment Specifications, GMDSS Marine Radio Equipment Specifications, and Fixed Network Equipment Specifications for Hong Kong.

5. Japan MIC Telecommunication Business Law (A1, A2) and Radio Law (B1, B2 and B3).

6. Audio/Video, Battery Charging Systems, Computers, Displays, Enterprise Servers, Imaging Equipment, Set-Top Boxes, Telephony, Televisions, Ceiling Fans, CFLs (Including GU24s), Decorative Light Strings, Integral LED Lamps, Luminaires, Residential Ventilating Fans.

The test site used by BACL Corp. to collect radiated and conducted emissions measurement data is located at its facility in Sunnyvale, California, USA.

The test site at BACL Corp. has been fully described in reports submitted to the Federal Communication Commission (FCC) and Voluntary Control Council for Interference (VCCI). The details of these reports have been found to be in compliance with the requirements of Section 2.948 of the FCC Rules on February 11 and December 10, 1997, and Article 8 of the VCCI regulations on December 25, 1997. The test site also complies with the test methods and procedures set forth in CISPR 22:2008 §10.4 for measurements below 1 GHz and §10.6 for measurements above 1 GHz as well as ANSI C63.10-2013, ANSI C63.10-2013, TIA/EIA-603 & CISPR 24:2010.

The Federal Communications Commission and Voluntary Control Council for Interference have the reports on file and they are listed under FCC registration number: 90464 and VCCI Registration No.: A-0027. The test site has been approved by the FCC and VCCI for public use and is listed in the FCC Public Access Link (PAL) database.

Additionally, BACL Corp. is an American Association for Laboratory Accreditation (A2LA) accredited laboratory (Lab Code 3297-02). The current scope of accreditations can be found at

<http://www.a2la.org/scopepdf/3297-02.pdf?CFID=1132286&CFTOKEN=e42a3240dac3f6ba-6DE17DCB-1851-9E57-477422F667031258&jsessionid=8430d44f1f47cf2996124343c704b367816b>

2 System Test Configuration

2.1 Justification

The EUT was configured for testing according to ANSI C63.10-2009 and FCC KDB 558074 D01 DTS Meas Guidance v03r02.

The EUT was tested in a testing mode to represent worst-case results during the final qualification test.

The worst-case data rates are determined to be as follows for each mode based upon investigation by measuring the average power, peak power and PPSD across all data rates bandwidths, and modulations.

2.2 EUT Exercise Software

EUT was exercised using putty.exe and verified by Bo Li.

2.3 Special Equipment

There were no special accessories required, included, or intended for use with EUT during these tests.

2.4 Equipment Modifications

No modifications were made to the EUT.

2.5 Local Support Equipment

Manufacturer	Description	Model	Serial Number
Keysight Technologies	Vector Signal Generator	N5182B	MY51350070
Hewlett-Packard	Power Supply	623B	2003A05705
Dell	Laptop	Latitude D 610	-

Note: Signal generator was used before every testing to verify the loss of cables and filters.

2.6 External Support Equipment

Manufacturer	Description	Model	Serial Number
Texas Instruments	Evaluation Board	Rev: 1.8.1.3	0x5C3F

2.7 EUT Internal Configuration Details

Manufacturer	Description	Model	Serial Number
Silicon Labs	ZigBee Transceiver IC	EM3585	-
Texas Instruments	BLE Transceiver IC	-	-
Sigma Designs	Z-Wave Transceiver IC	-	-

2.8 Interface Ports and Cables

Description	Length	From	To
6-pin cable	1M	Evaluation Board	EUT
USB cable	1M	Evaluation Board	Laptop

2.9 Power Supply List and Details

Manufacturer	Description	Model	Serial Number
CUI	Wall Transformer	EP5A050200UH-P5P-DB-C1	-

3 Summary of Test Results

Results reported relate only to the product tested.

FCC Rules	Description of Test	Results
§15.247(i), §2.1091	RF Exposure	Compliant
§15.203	Antenna Requirement	Compliant
§15.207(a)	AC Line Conducted Emissions	Compliant
§15.205 §15.209, §15.247(d)	Restricted Bands, Radiated Spurious Emissions	Compliant
§15.247(d)	Conducted Transmitter Spurious Emission	N/A ¹
§15.247(a)(2)	6 dB Emission Bandwidth	Compliant
§15.247(b)(3)	Maximum Peak Output Power	Compliant
§15.247(d)	100 kHz Bandwidth of Frequency Band Edge	Compliant
§15.247(e)	Power Spectral Density	Compliant

¹ The EUT did not have an antenna port.

4 FCC §15.247(i) & §2.1091– RF Exposure

4.1 Applicable Standard

According to FCC §15.247(i) and §1.1307(b)(1), systems operating under the provisions of this section shall be operated in a manner that ensures that the public is not exposed to radio frequency energy level in excess of the Commission’s guidelines.

Limits for General Population/Uncontrolled Exposure

Frequency Range (MHz)	Electric Field Strength (V/m)	Magnetic Field Strength (A/m)	Power Density (mW/cm ²)	Averaging Time (minutes)
Limits for General Population/Uncontrolled Exposure				
0.3-1.34	614	1.63	* (100)	30
1.34-30	824/f	2.19/f	* (180/f ²)	30
30-300	27.5	0.073	0.2	30
300-1500	/	/	f/1500	30
1500-100,000	/	/	1.0	30

f = frequency in MHz

* = Plane-wave equivalent power density

4.2 MPE Prediction

Predication of MPE limit at a given distance, Equation from OET Bulletin 65, Edition 97-01

$$S = PG/4\pi R^2$$

Where: S = power density

P = power input to antenna

G = power gain of the antenna in the direction of interest relative to an isotropic radiator

R = distance to the center of radiation of the antenna

4.3 MPE Results

<u>Maximum peak output power at antenna input terminal (dBm):</u>	<u>3.362</u>
<u>Maximum peak output power at antenna input terminal (mW):</u>	<u>2.1687</u>
<u>Prediction distance (cm):</u>	<u>20</u>
<u>Prediction frequency (MHz):</u>	<u>2440</u>
<u>Maximum Antenna Gain, typical (dBi):</u>	<u>4</u>
<u>Maximum Antenna Gain (numeric):</u>	<u>2.512</u>
<u>Power density of prediction frequency at 20.0 cm (mW/cm²):</u>	<u>0.001084</u>
<u>MPE limit for uncontrolled exposure at prediction frequency (mW/cm²):</u>	<u>1.0</u>

The device is compliant with the requirement MPE limit for uncontrolled exposure. The maximum power density at the distance of 20 cm is 0.001084 mW/cm². Limit is 1.0 mW/cm²

5 FCC §15.203– Antenna Requirements

5.1 Applicable Standard

According to FCC §15.203, an intentional radiator shall be designed to ensure that no antenna other than that furnished by the responsible party shall be used with the device. The use of a permanently attached antenna or of an antenna that uses a unique coupling to the intentional radiator shall be considered sufficient to comply with the provisions of this Section. The manufacturer may design the unit so that a broken antenna can be replaced by the user, but the use of a standard antenna jack or electrical connector is prohibited.

5.2 Antenna Description

The EUT uses a trace antenna, which complies with the antenna requirement. And the antenna gain is 4 dBi. Please refer to the internal photos.

6 FCC §15.207– AC Line Conducted Emissions

6.1 Applicable Standards

As per FCC §15.207 Conducted limits:

For an intentional radiator that is designed to be connected to the public utility (AC) power line, the radio frequency voltage that is conducted back onto the AC power line on any frequency or frequencies within the band 150 kHz to 30 MHz shall not exceed the limits in the following table, as measured using a 50 μH/50 ohms line impedance stabilization network (LISN). Compliance with the provisions of this paragraph shall be based on the measurement of the radio frequency voltage between each power line and ground at the power terminal. The lower limit applies at the boundary between the frequencies ranges.

Frequency of Emission (MHz)	Conducted Limit (dBuV)	
	Quasi-Peak	Average
0.15-0.5	66 to 56 *	56 to 46 *
0.5-5	56	46
5-30	60	50

**Decreases with the logarithm of the frequency.*

6.2 Test Setup

The measurement was performed at shield room, using the setup per ANSI C63.10-2009 measurement procedure. The specification used was FCC §15.207 limits.

External I/O cables were draped along the edge of the test table and bundle when necessary.

The power adapter of the EUT was connected with LISN which provided 120 V / 60 Hz AC power.

6.3 Test Procedure

Maximizing procedure was performed on the highest emissions of the EUT.

All data was recorded in the peak detection mode, quasi-peak and average. Quasi-Peak readings are distinguished with a “QP.” Average readings are distinguished with an “Ave”.

6.4 Test Setup Block Diagram

AC/DC Adaptor:

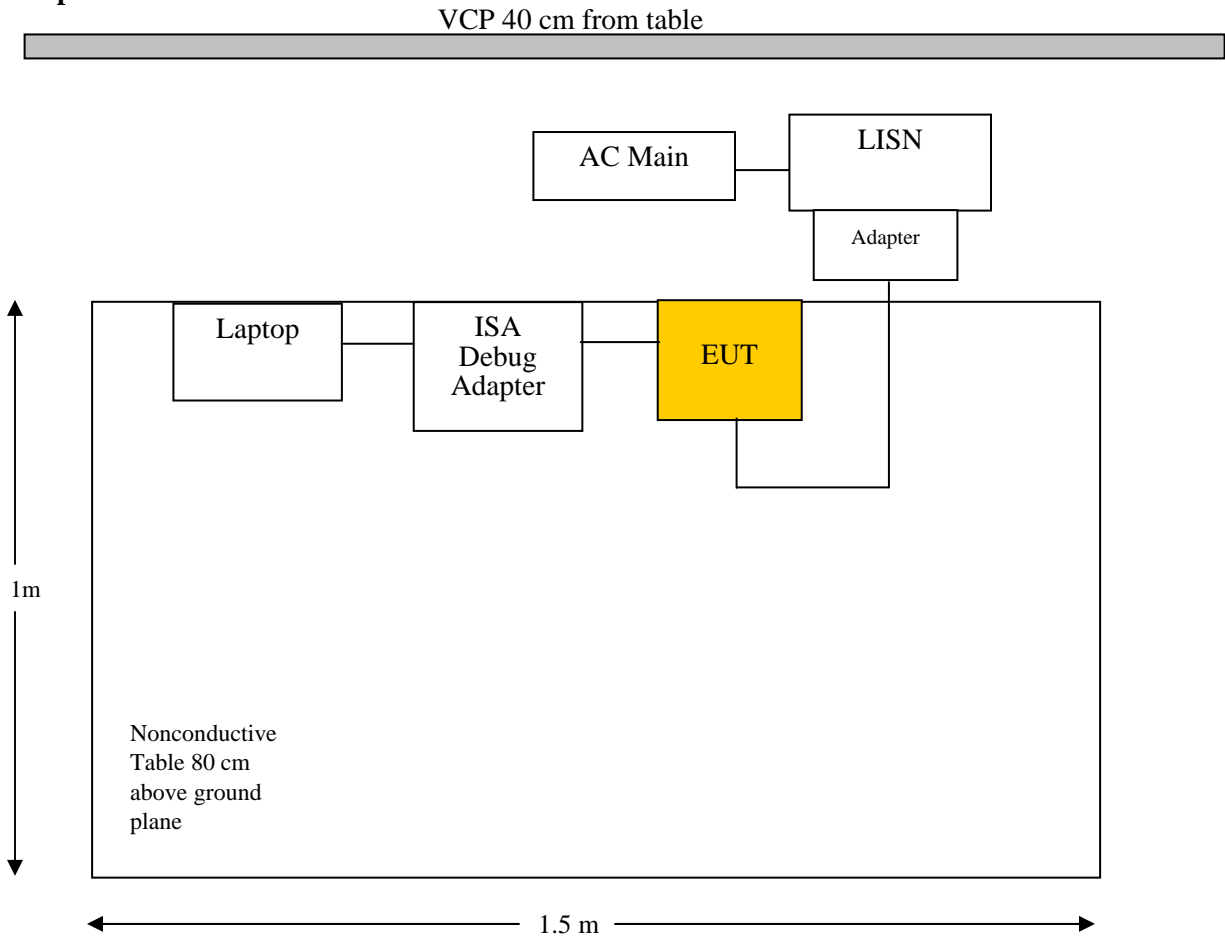

6.5 Corrected Amplitude & Margin Calculation

The Corrected Amplitude (CA) is calculated by adding the Cable Loss (CL), the Attenuator Factor (Atten) to indicated Amplitude (Ai) reading. The basic equation is as follows:

$$CA = Ai + CL + Atten$$

For example, a corrected amplitude of 46.2 dBuV = Indicated Reading (32.5 dBuV) + Cable Loss (3.7 dB) + Attenuator (10 dB)

The “**Margin**” column of the following data tables indicates the degree of compliance within the applicable limit. For example, a margin of -7 dB means the emission is 7 dB below the maximum limit. The equation for margin calculation is as follows:

$$\text{Margin} = \text{Corrected Amplitude} - \text{Limit}$$

6.6 Test Equipment List and Details

Manufacturer	Description	Model No.	Serial No.	Calibration Date	Calibration Interval
Rohde & Schwarz	EMI Receiver	ESCI 1166.5950K03	100044	2014-07-17	1 year
Solar Electronics	High Pass Filter	Type 7930-100	7930150204	2015-03-06	1 Year
Rohde & Schwarz	Impulse Limiter	ESH3-Z2	101962	2014-07-08	1 year
Hewlett Packard	N-Type Cable	-	1263	N/A	N/A
Solar Electronics	LISN	9252-50-R-24-N	511213	2014-07-14	1 year

Statement of Traceability: BACL Corp. attests that all calibrations have been performed per the A2LA requirements, traceable to the NIST.

6.7 Test Environmental Conditions

Temperature:	22-24° C
Relative Humidity:	40-41 %
ATM Pressure:	103.1-104.1 KPa

The testing was performed by Bo Li on 2015-03-27 in 5m chamber3.

6.8 Summary of Test Results

According to the recorded data in following table, the EUT complied with the FCC 15C standard's conducted emissions limits, with the margin reading of:

Connection: AC/DC adapter connected to 120 V/60 Hz, AC			
Margin (dB)	Frequency (MHz)	Conductor Mode (Line/Neutral)	Range (MHz)
-11.75	0.283829	Neutral	0.15-30

6.9 Conducted Emissions Test Plots and Data

120 V, 60 Hz – Line

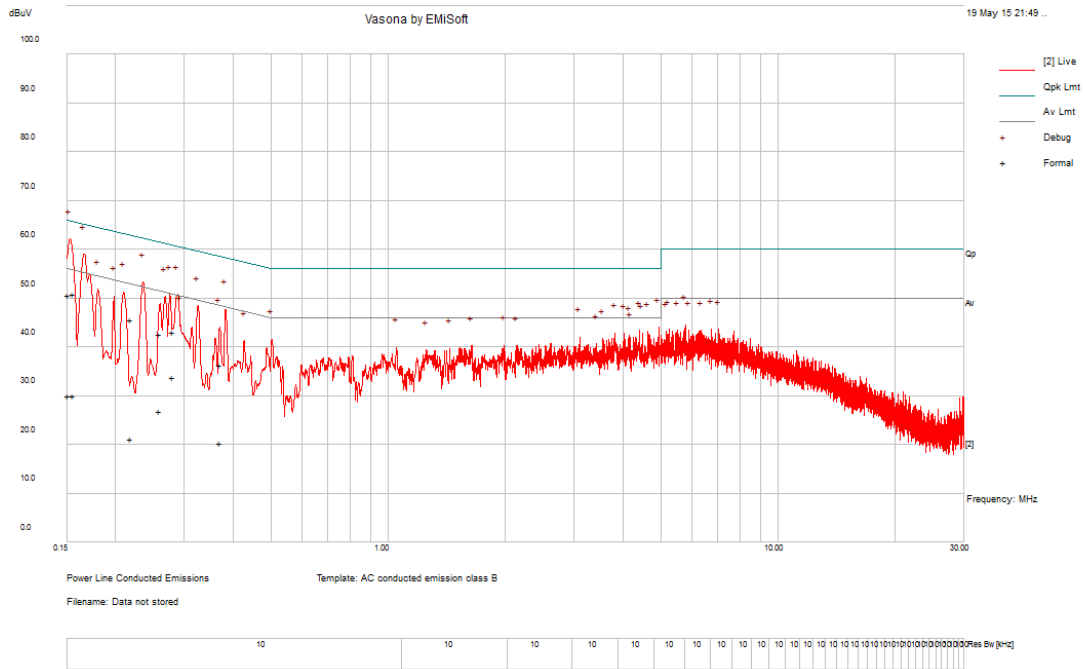

Frequency (MHz)	Corrected Amplitude (dBµV)	Conductor (Line/Neutral)	Limit (dBµV)	Margin (dB)	Detector (QP/Ave.)
0.151307	50.71	Line	65.93	-15.22	QP
0.156285	51.01	Line	65.66	-14.65	QP
0.218379	45.72	Line	62.88	-17.16	QP
0.280938	43.14	Line	60.79	-17.64	QP
0.259542	42.82	Line	61.45	-18.63	QP
0.370761	36.46	Line	58.48	-22.02	QP

Frequency (MHz)	Corrected Amplitude (dBµV)	Conductor (Line/Neutral)	Limit (dBµV)	Margin (dB)	Detector (QP/Ave.)
0.151307	30.13	Line	55.93	-25.8	Ave.
0.156285	30.08	Line	55.66	-25.58	Ave
0.218379	21.18	Line	52.88	-31.7	Ave
0.280938	33.95	Line	50.79	-16.84	Ave.
0.259542	27.05	Line	51.45	-24.39	Ave
0.370761	20.36	Line	48.48	-28.12	Ave

120 V, 60 Hz – Neutral

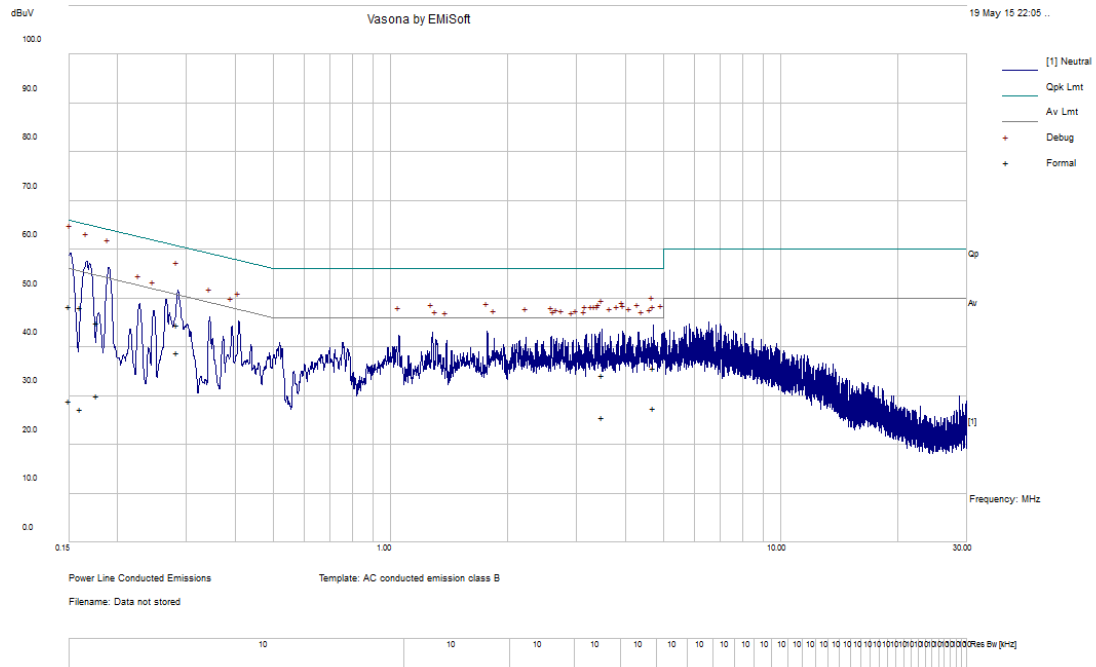

Frequency (MHz)	Corrected Amplitude (dBμV)	Conductor (Line/Neutral)	Limit (dBμV)	Margin (dB)	Detector (QP/Ave.)
0.160887	48.19	Neutral	65.42	-17.23	QP
0.150128	48.41	Neutral	65.99	-17.59	QP
0.177413	45.17	Neutral	64.61	-19.44	QP
0.283829	44.75	Neutral	60.7	-15.96	QP
4.725382	35.82	Neutral	56	-20.18	QP
3.4975	34.34	Neutral	56	-21.66	QP

Frequency (MHz)	Corrected Amplitude (dBμV)	Conductor (Line/Neutral)	Limit (dBμV)	Margin (dB)	Detector (QP/Ave.)
0.160887	27.32	Neutral	55.42	-28.1	Ave.
0.150128	29.06	Neutral	55.99	-26.93	Ave.
0.177413	30.03	Neutral	54.61	-24.58	Ave.
0.283829	38.95	Neutral	50.7	-11.75	Ave.
4.725382	27.49	Neutral	46	-18.51	Ave.
3.4975	25.72	Neutral	46	-20.28	Ave.

7 FCC §15.205 §15.209, §15.247(d)– Spurious Radiated Emissions

7.1 Applicable Standard

As per FCC §15.35(d): Unless otherwise specified, on any frequency or frequencies above 1000 MHz, the radiated emission limits are based on the use of measurement instrumentation employing an average detector function. Unless otherwise specified, measurements above 1000 MHz shall be performed using a minimum resolution bandwidth of 1 MHz.

As per FCC §15.209(a): Except as provided elsewhere in this Subpart, the emissions from an intentional radiator shall not exceed the field strength levels specified in the following table

Frequency (MHz)	Field Strength (micro volts/meter)	Measurement Distance (meters)
0.009 - 0.490	2400/F(kHz)	300
0.490 - 1.705	24000/F(kHz)	30
1.705 - 30.0	30	30
30 - 88	100**	3
88 - 216	150**	3
216 - 960	200**	3
Above 960	500	3

** Except as provided in paragraph (g), fundamental emissions from intentional radiators operating under this Section shall not be located in the frequency bands 54-72 MHz, 76-88 MHz, 174-216 MHz or 470-806 MHz. However, operation within these frequency bands is permitted under other sections of this Part, e.g., Sections 15.231 and 15.241.

As Per FCC §15.205(a) except as show in paragraph (d) of this section, only spurious emissions are permitted in any of the frequency bands listed below:

MHz	MHz	MHz	GHz
0.090 – 0.110	16.42 – 16.423	960 – 1240	4.5 – 5.15
0.495 – 0.505	16.69475 – 16.69525	1300 – 1427	5.35 – 5.46
2.1735 – 2.1905	25.5 – 25.67	1435 – 1626.5	7.25 – 7.75
4.125 – 4.128	37.5 – 38.25	1645.5 – 1646.5	8.025 – 8.5
4.17725 – 4.17775	73 – 74.6	1660 – 1710	9.0 – 9.2
4.20725 – 4.20775	74.8 – 75.2	1718.8 – 1722.2	9.3 – 9.5
6.215 – 6.218	108 – 121.94	2200 – 2300	10.6 – 12.7
6.26775 – 6.26825	123 – 138	2310 – 2390	13.25 – 13.4
6.31175 – 6.31225	149.9 – 150.05	2483.5 – 2500	14.47 – 14.5
8.291 – 8.294	156.52475 – 156.52525	2690 – 2900	15.35 – 16.2
8.362 – 8.366	156.7 – 156.9	3260 – 3267	17.7 – 21.4
8.37625 – 8.38675	162.0125 – 167.17	3.332 – 3.339	22.01 – 23.12
8.41425 – 8.41475	167.72 – 173.2	3.3458 – 3.358	23.6 – 24.0
12.29 – 12.293	240 – 285	3.600 – 4.400	31.2 – 31.8
12.51975 – 12.52025	322 – 335.4		36.43 – 36.5
12.57675 – 12.57725	399.9 – 410		Above 38.6
13.36 – 13.41	608 – 614		

As per FCC §15.247 (d) In any 100 kHz bandwidth outside the frequency band in which the spread spectrum or digitally modulated intentional radiator is operating, the radio frequency power that is produced by the intentional radiator shall be at least 20 dB below that in the 100 kHz bandwidth within the band that contains the highest level of the desired power, based on either an RF conducted or a radiated measurement, provided the transmitter demonstrates compliance with the peak conducted power limits. If the transmitter complies with the conducted power limits based on the use of RMS averaging over a time interval, as permitted under paragraph (b)(3) of this section, the attenuation required under this paragraph shall be 30 dB instead of 20 dB. Attenuation below the general limits specified in §15.209(a) is not required. In addition, radiated emissions which fall in the restricted bands, as defined in §15.205(a), must also comply with the radiated emission limits specified in §15.209(a) (see §15.205(c)).

7.2 Test Setup

The radiated emissions tests were performed in the 5-meter Chamber, using the setup in accordance with ANSI C63.10-2009. The specification used was the FCC 15 Subpart C limits.

The spacing between the peripherals was 10 centimeters.

External I/O cables were draped along the edge of the test table and bundle when necessary.

7.3 Test Procedure

The measurements are based on FCC KDB 558074 D01 DTS Meas Guidance v03r02: Guidance for Performing Compliance Measurements on Digital Transmission Systems (DTS) Operating Under §15.247 section 11: Emissions in non-restricted frequency bands and section 12: Emissions in restricted frequency bands. As well as ANSI C63.10: 2009 as described below:

For the radiated emissions test, the EUT host, and all support equipment power cords was connected to the AC floor outlet.

Maximizing procedure was performed on the highest emissions to ensure that the EUT complied with all installation combinations.

The EUT is set 3 meter away from the testing antenna, which is varied from 1-4 meter, and the EUT is placed on a turntable, which is 0.8 meter above ground plane, the table shall be rotated for 360 degrees to find out the highest emission. The receiving antenna should be changed the polarization both of horizontal and vertical.

The spectrum analyzer or receiver is set as:

Below 1000 MHz:

RBW = 100 kHz / VBW = 300 kHz / Sweep = Auto

Above 1000 MHz:

(1) Peak: RBW = 1MHz / VBW = 3MHz / Sweep = Auto

Average: RBW = 1MHz / VBW = 10Hz / Sweep = Auto

7.4 Corrected Amplitude & Margin Calculation

The Corrected Amplitude (CA) is calculated by adding the Antenna Factor (AF), the Cable Loss (CL), the Attenuator Factor (Atten) and subtracting the Amplifier Gain (Ga) to indicated Amplitude (Ai) reading. The basic equation is as follows:

$$CA = Ai + AF + CL + Atten - Ga$$

For example, a corrected amplitude of 40.3 dBuV/m = Indicated Reading (32.5 dBuV) + Antenna Factor (+23.5dB) + Cable Loss (3.7 dB) + Attenuator (10 dB) - Amplifier Gain (29.4 dB)

The “**Margin**” column of the following data tables indicates the degree of compliance within the applicable limit. For example, a margin of -7 dB means the emission is 7 dB below the maximum limit. The equation for margin calculation is as follows:

$$\text{Margin} = \text{Corrected Amplitude} - \text{Limit}$$

7.5 Test Equipment List and Details

Manufacturer	Description	Model No.	Serial No.	Calibration Date	Calibration Interval
Sunol Science Corp	System Controller	SC99V	122303-1	N/A	N/A
Sunol Sciences	Antenna, Biconi-Log	JB3	A020106-2	2014-09-17	1 year
Hewlett Packard	Pre-amplifier	8447D	2944A06639	2014-04-26	1 year
HP/ Agilent	Pre Amplifier	8449B OPT HO2	3008A0113	2015-03-12	1 year
E-meca	10d B Attenuator	18N-10-294	64671	N/A	N/A
Micro Tronics	Band Reject Filter	BRM50701	160	N/A	N/A
IW Microwave	SAM-Cable	SPS-2303-3840-SPS	DC1438	N/A	N/A
Hewlett Packard	N-Type Cable	-	692	N/A	N/A
Agilent	Analyzer, Spectrum	E4440A	MY44303352	2014-11-13	1 year
Eaton	Antenna, Horn	96001	2617	2014-11-18	1 year
Rohde & Schwarz	Receiver, EMI Test	ESCI 1166.5950K03	100044	2014-07-17	1 year

Statement of Traceability: BACL attests that all calibrations have been performed per the A2LA requirements, traceable to NIST.

7.6 Test Environmental Conditions

Temperature:	22° C
Relative Humidity:	52 %
ATM Pressure:	101.9 kPa

The testing was performed by Bo Li on 2015-03-31 in 5 m chamber 3.

7.7 Summary of Test Results

According to the data hereinafter, the EUT complied with the FCC Title 47, Part 15C standard’s radiated emissions limits, and had the worst margin of:

30-1000 MHz:

Mode: Transmitting			
Margin (dB)	Frequency (MHz)	Polarization (Horizontal/Vertical)	Channel
-7.65	199.99425	Horizontal	30-1000

1–25 GHz:

Mode: Transmitting			
Margin (dB)	Frequency (MHz)	Polarization (Horizontal/Vertical)	Channel
-0.725	2483.5	Horizontal	High

Please refer to the following table and plots for specific test result details

7.8 Radiated Emissions Test Results

1) 30 MHz – 1 GHz, Measured at 3 meters

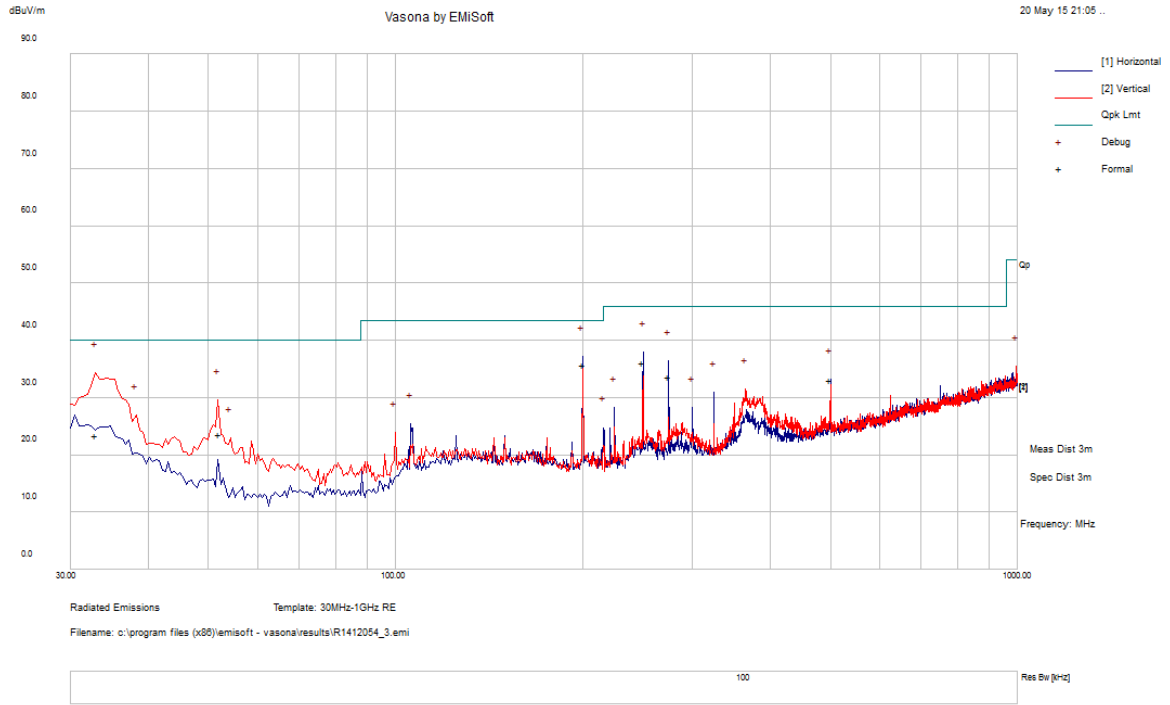

Frequency (MHz)	Corrected Amplitude (dBµV/m)	Antenna Height (cm)	Antenna Polarity (H/V)	Turntable Azimuth (degrees)	Limit (dBµV/m)	Margin (dB)	Detector (PK/QP/Ave)
32.88075	23.43	V	208	221	40	-16.57	QP
199.99425	35.85	H	168	228	43.5	-7.65	QP
250.00225	36.16	H	170	57	46	-9.84	QP
275.01475	33.69	H	101	18	46	-12.31	QP
52.0215	23.73	V	107	84	40	-16.27	QP
500.02225	33.11	H	190	257	46	-12.89	QP

Note: The worst case result for simultaneous transmission of BLE, ZigBee and Z-wave was reported.

2) 1-25 GHz, Measured at 3 meters

Frequency (MHz)	S.A. Reading (dBµV)	Turntable Azimuth (degrees)	Test Antenna			Cable Loss (dB)	Pre-Amp. (dB)	Cord. Reading (dBµV/m)	FCC		Comments
			Height (cm)	Polarity (H/V)	Factor (dB/m)				Limit (dBµV/m)	Margin (dB)	
Low Channel 2405 MHz, measured at 3 meters											
2405	65.83	324	219	V	28.383	2.865	0	97.078	-	-	Peak
2405	70.78	163	150	H	28.417	2.865	0	102.062	-	-	Peak
2405	63.35	324	219	V	28.383	2.865	0	94.598	-	-	Ave
2405	68.45	163	150	H	28.417	2.865	0	99.732	-	-	Ave
2390	27.01	324	219	V	28.383	2.865	0	58.258	74	-15.742	Peak
2390	27.4	163	150	H	28.417	2.865	0	58.682	74	-15.318	Peak
2390	12.82	324	219	V	28.383	2.865	0	44.068	54	-9.932	Ave
2390	13.39	163	150	H	28.417	2.865	0	44.672	54	-9.328	Ave
4810	49.12	64	150	V	32.897	4.297	35.663	50.651	74	-23.349	Peak
4810	51.63	157	165	H	32.897	4.297	35.663	53.161	74	-20.839	Peak
4810	36.93	64	150	V	32.897	4.297	35.663	38.461	54	-15.539	Ave
4810	40.32	157	165	H	32.897	4.297	35.663	41.851	54	-12.149	Ave
7215	47.6	293	150	V	37.444	5.675	36.064	54.655	77.078	-22.423	Peak
7215	45.49	145	150	H	37.442	5.675	36.064	52.543	82.062	-29.519	Peak
7215	35.73	293	150	V	37.444	5.675	36.064	42.785	74.598	-31.813	Ave
7215	32.46	145	150	H	37.442	5.675	36.064	39.513	79.732	-40.219	Ave
9620	44.84	0	150	V	38.830	8.704	35.900	56.474	77.078	-20.604	Peak
9620	44.2	0	150	H	38.834	8.704	35.900	55.838	82.062	-26.224	Peak
9620	29.58	0	150	V	38.830	8.704	35.900	41.214	74.598	-33.384	Ave
9620	29.64	0	150	H	38.834	8.704	35.900	41.278	79.732	-38.454	Ave
Middle Channel 2440 MHz, measured at 3 meters											
2440	63.66	286	150	V	28.383	2.865	0	94.908	-	-	Peak
2440	71.56	5	155	H	28.417	2.865	0	102.842	-	-	Peak
2440	61.17	286	150	V	28.383	2.865	0	92.418	-	-	Ave
2440	69.18	5	155	H	28.417	2.865	0	100.462	-	-	Ave
4880	50.47	41	170	V	33.119	4.404	35.896	52.097	74	-21.903	Peak
4880	50.66	161	152	H	33.354	4.404	35.896	52.522	74	-21.478	Peak
4880	39.33	41	170	V	33.119	4.404	35.896	40.957	54	-13.043	Ave
4880	39.4	161	152	H	33.354	4.404	35.896	41.262	54	-12.738	Ave
7320	44.05	0	150	V	37.242	5.788	35.958	51.122	74	-22.878	Peak
7320	43.44	0	150	H	37.356	5.788	35.958	50.626	74	-23.374	Peak
7320	28.58	0	150	V	37.242	5.788	35.958	35.652	54	-18.348	Ave
7320	28.28	0	150	H	37.356	5.788	35.958	35.466	54	-18.534	Ave
9760	42.93	0	150	V	38.908	8.157	36.032	53.964	74.908	-20.944	Peak
9760	42.85	0	150	H	38.913	8.157	36.032	53.889	82.842	-28.953	Peak
9760	27.89	0	150	V	38.908	8.157	36.032	38.924	72.418	-33.494	Ave
9760	27.91	0	150	H	38.913	8.157	36.032	38.949	80.462	-41.513	Ave

Frequency (MHz)	S.A. Reading (dBµV)	Turntable Azimuth (degrees)	Test Antenna			Cable Loss (dB)	Pre-Amp. (dB)	Cord. Reading (dBµV/m)	FCC		Comments
			Height (cm)	Polarity (H/V)	Factor (dB/m)				Limit (dBµV/m)	Margin (dB)	
High Channel 2480 MHz, measured at 3 meters											
2480	52.03	140	150	V	29.764	2.950	0	84.744	-	-	Peak
2480	62.84	171	155	H	28.785	2.950	0	94.575	-	-	Peak
2480	49.37	140	150	V	28.764	2.950	0	81.084	-	-	Ave
2480	60.46	171	155	H	28.785	2.950	0	92.195	-	-	Ave
2483.5	28.67	140	150	V	29.764	2.950	0	61.384	74	-12.616	Peak
2483.5	33.45	171	155	H	28.785	2.950	0	65.185	74	-8.815	Peak
2483.5	15.04	140	150	V	28.764	2.950	0	46.754	54	-7.246	Ave
2483.5	21.54	171	155	H	28.785	2.950	0	53.275	54	-0.725	Ave
4960	46.02	215	150	V	33.531	4.404	35.909	48.046	74	-25.954	Peak
4960	45.49	142	150	H	33.556	4.404	35.909	47.541	74	-26.459	Peak
4960	31.53	215	150	V	33.531	4.404	35.909	33.556	54	-20.444	Ave
4960	31.42	142	150	H	33.556	4.404	35.909	33.471	54	-20.529	Ave
7440	44.78	0	150	V	37.242	5.869	35.963	51.928	74	-22.072	Peak
7440	44.68	0	150	H	37.238	5.869	35.963	51.824	74	-22.176	Peak
7440	29.95	0	150	V	37.242	5.869	35.963	37.098	54	-16.902	Ave
7440	30.38	0	150	H	37.238	5.869	35.963	37.524	54	-16.476	Ave
9920	43.35	0	150	V	39.036	7.657	35.976	54.067	64.744	-10.677	Peak
9920	42.14	0	150	H	39.052	7.657	35.976	52.873	74.575	-21.702	Peak
9920	27.5	0	150	V	39.036	7.657	35.976	38.217	61.084	-22.867	Ave
9920	27.54	0	150	H	39.052	7.657	35.976	38.273	72.195	-33.922	Ave

Co-location:

Frequency (MHz)	S.A. Reading (dBµV)	Turntable Azimuth (degrees)	Test Antenna			Cable Loss (dB)	Pre-Amp. (dB)	Cord. Reading (dBµV/m)	FCC		Comments
			Height (cm)	Polarity (H/V)	Factor (dB/m)				Limit (dBµV/m)	Margin (dB)	
Simultaneous Transmission, measured at 3 meters											
4804	48.22	116	150	V	33.119	4.404	35.896	49.847	74	-24.153	Peak
4804.4	50.42	315	150	H	33.354	4.404	35.896	52.282	74	-21.718	Peak
4804	37.07	116	150	V	33.119	4.404	35.896	38.697	54	-15.303	Ave
4804.4	43.28	315	150	H	33.354	4.404	35.896	45.142	54	-8.858	Ave

Note: Co-location stands for the simultaneous transmission mode for BLE, ZigBee and Z-wave worst case.

8 FCC§15.247(a)(2)– 6 dB & 99% Emission Bandwidth

8.1 Applicable Standard

According to FCC §15.247(a)(2), systems using digital modulation techniques may operate in the 902~928 MHz, 2400~2483.5 MHz, and 5725~5850 MHz bands. The minimum 6 dB bandwidth shall be at least 500 kHz

8.2 Measurement Procedure

The measurements are base on FCC KDB 558074 D01 DTS Meas Guidance v03r02: Guidance for Performing Compliance Measurements on Digital Transmission Systems (DTS) Operating Under §15.247 section 8: DTS bandwidth

8.3 Test Equipment List and Details

Manufacturer	Description	Model No.	Serial No.	Calibration Date	Calibration Interval
Sunol Science Corp	System Controller	SC99V	122303-1	N/R	N/R
Agilent	Analyzer, Spectrum	E4440A	US 422221851	2014-04-09	1 year
IW Microwave	SMA-Cable	SPS-2303-3840-SPS	DC1438	N/A	N/A
Eaton	Antenna, Horn	96001	2617	2014-11-18	1 year

Statement of Traceability: BACL attests that all calibrations have been performed per the A2LA requirements, traceable to NIST.

8.4 Test Environmental Conditions

Temperature:	22° C
Relative Humidity:	52 %
ATM Pressure:	101.9 kPa

The testing was performed by Bo Li on 2015-03-31 in 5 m chamber 3.

8.5 Test Results and Plots

Channel	Frequency (MHz)	6 dB Emission Bandwidth (MHz)	99% Emission Bandwidth (MHz)	Limit (MHz)	Results
Low	2405	1.597	2.3934	> 0.5	Compliant
Middle	2440	1.587	2.3730	> 0.5	Compliant
High	2480	1.593	2.4125	> 0.5	Compliant

Please refer to the following plots for detailed test results

Low channel: 2405 MHz

Middle channel: 2440 MHz

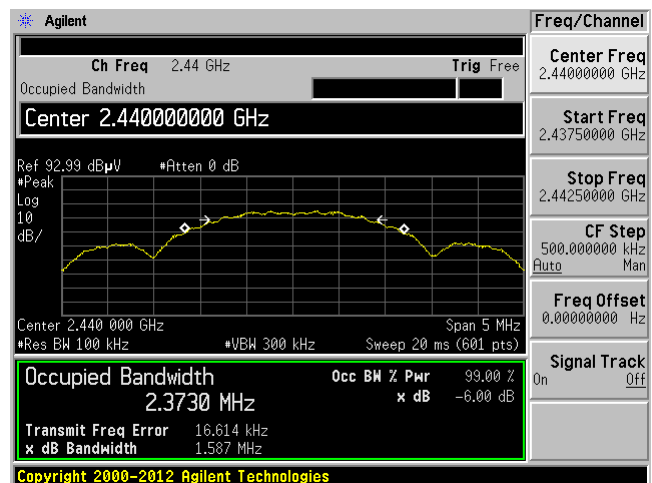
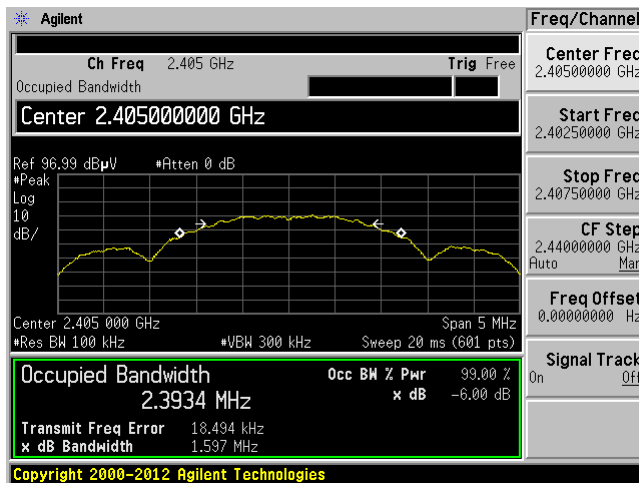

High Channel 2480 MHz

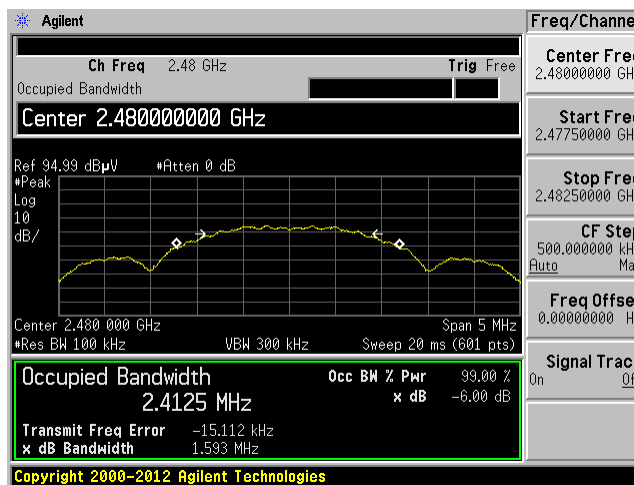

Note: These measurements were taken at the worst case, with the measuring antenna polarized horizontally.

9 FCC §15.247(b) – Peak Output Power Measurement

9.1 Applicable Standard

According to FCC §15.247(b), for systems using digital modulation in the 902~928 MHz, 2400~2483.5 MHz, and 5725~5850 MHz bands: 1 Watt.

9.2 Measurement Procedure

The measurements are based on FCC KDB 558074 D01 DTS Meas Guidance v03r02: Guidance for Performing Compliance Measurements on Digital Transmission Systems (DTS) Operating Under §15.247 section 9: Fundamental emission output power

9.3 Test Equipment List and Details

Manufacturer	Description	Model No.	Serial No.	Calibration Date	Calibration Interval
Sunol Science Corp	System Controller	SC99V	122303-1	N/R	N/R
IW Microwave	SMA-Cable	SPS-2303-3840-SPS	DC1438	N/A	N/A
Agilent	Analyzer, Spectrum	E4440A	US 422221851	2014-04-09	1 year
Eaton	Antenna, Horn	96001	2617	2014-11-18	1 year

Statement of Traceability: BACL attests that all calibrations have been performed per the A2LA requirements, traceable to NIST.

9.4 Test Environmental Conditions

Temperature:	22° C
Relative Humidity:	52 %
ATM Pressure:	101.9 kPa

The testing was performed by Bo Li on 2015-03-31 in 5 m chamber 3.

9.5 Test Results

Frequency (MHz)	S.A. Reading (dBµV)	Test Antenna Factor (dB/m)	Cable Loss (dB)	Cord. Reading (dBµV/m)	EIRP (dBm)	Antenna Gain (dBi)	Output Power (dBm)	Limit (dBm)	Power Setting
2405	70.77	28.417	-2.865	102.052	6.852	4.000	2.852	30	3 0
2440	71.28	28.417	-2.865	102.562	7.362	4.000	3.362	30	3 0
2480	62.99	28.785	-2.950	94.725	-0.475	4.000	-4.475	30	-5 0

The field strength converts to conducted power should be as following:

$E \text{ (dB}\mu\text{V/m)} = \text{EIRP [dBm]} + 95.2$ for the distance at 3 meters.

Please refer to the following plots:

Low channel: 2405 MHz

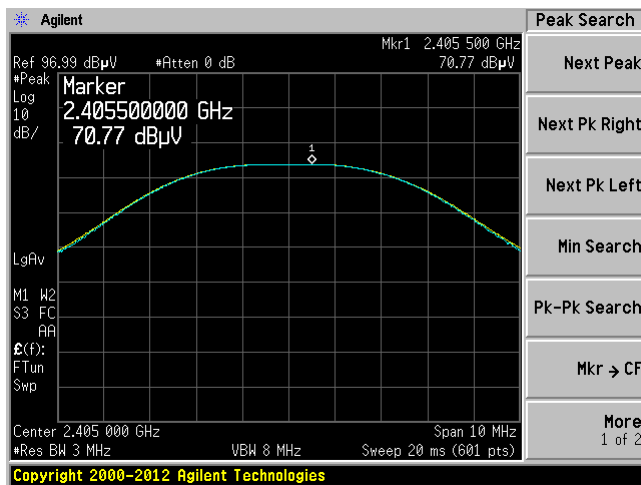

Middle channel: 2440 MHz

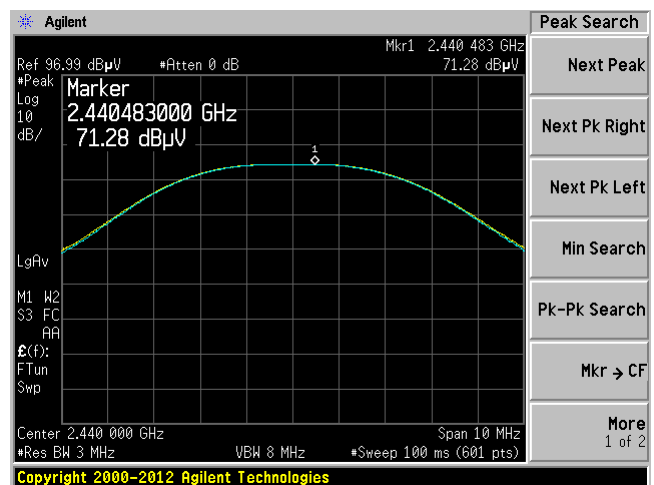

High Channel 2480 MHz

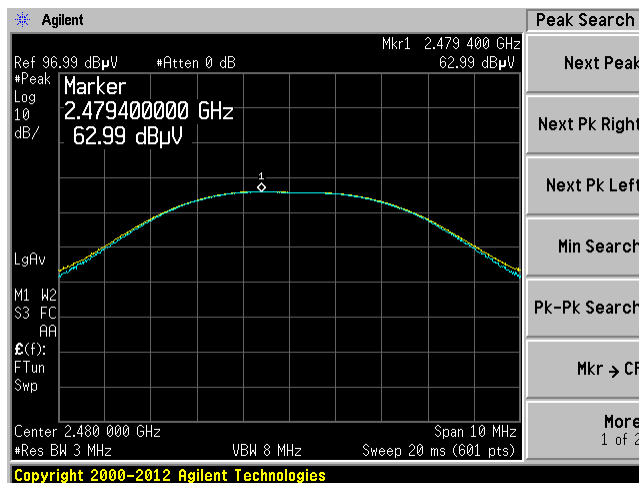

Note: These measurements were taken at the worst case, with the measuring antenna polarized horizontally.

10 FCC §15.247(d)– 100 kHz Bandwidth of Band Edges

10.1 Applicable Standard

According to FCC §15.247(d), in any 100 kHz bandwidth outside the frequency bands in which the spread spectrum intentional radiator is operating, the radio frequency power that is produced by the intentional radiator shall be at least 20 dB below that in the 100 kHz bandwidth within the band that contains the highest level of the desired power, based on either an RF conducted or a radiated measurement. In addition, radiated emissions which fall in the restricted bands, as defined in §15.205(a), must also comply with the radiated emissions limits specified in §15.209(a) see §15.205(c).

10.2 Measurement Procedure

The measurements are based on FCC KDB 558074 D01 DTS Meas Guidance v03r01: Guidance for Performing Compliance Measurements on Digital Transmission Systems (DTS) Operating Under §15.247 section 13: Band-edge measurements

10.3 Test Equipment List and Details

Manufacturer	Description	Model No.	Serial No.	Calibration Date	Calibration Interval
Sunol Science Corp	System Controller	SC99V	122303-1	N/R	N/R
IW Microwave	SMA-Cable	SPS-2303-3840-SPS	DC1438	N/A	N/A
Agilent	Analyzer, Spectrum	E4440A	US 422221851	2014-04-09	1 year
Eaton	Antenna, Horn	96001	2617	2014-11-18	1 year

Statement of Traceability: BACL attests that all calibrations have been performed per the A2LA requirements, traceable to NIST.

10.4 Test Environmental Conditions

Temperature:	22° C
Relative Humidity:	52 %
ATM Pressure:	101.9 kPa

The testing was performed by Bo Li on 2015-03-31 in 5 m chamber 3.

10.5 Test Results

Please refer to following pages for plots of band edge.

Low Channel 2405 MHz

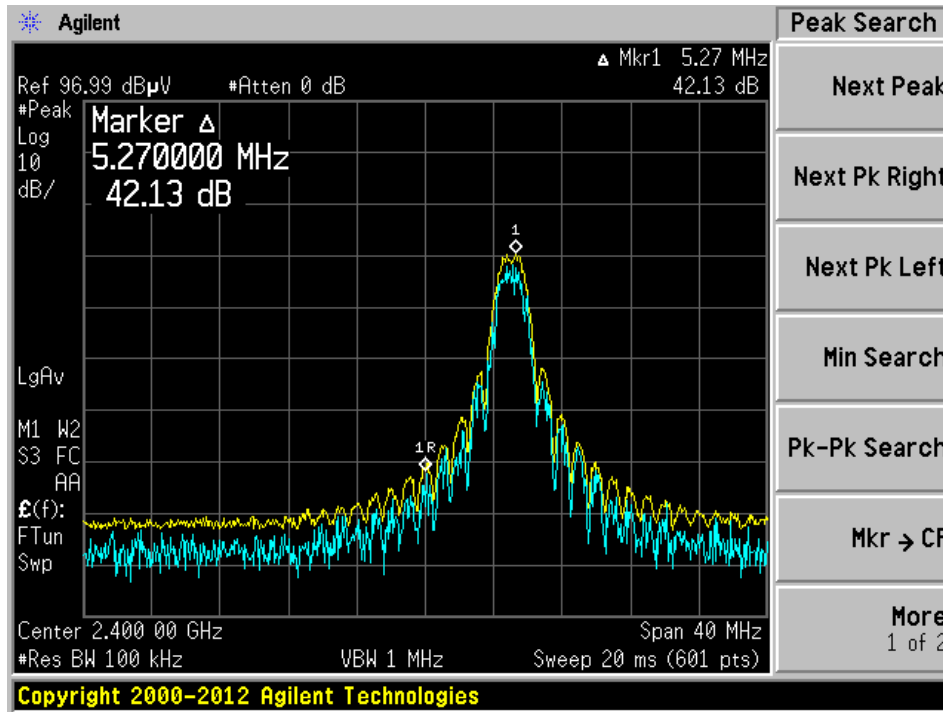

High Channel 2480 MHz

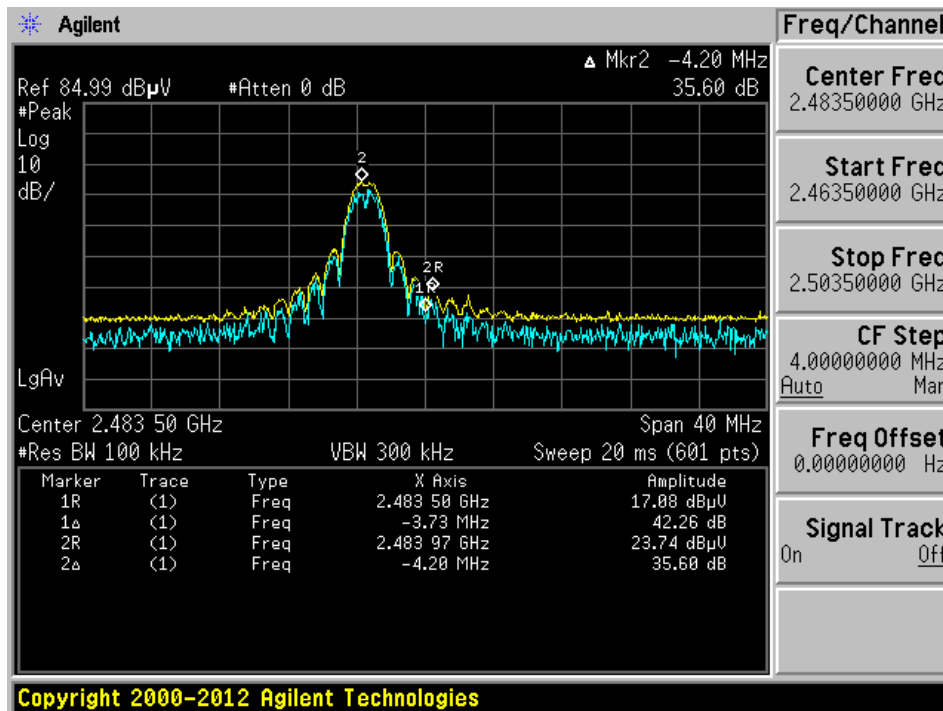

Note: These measurements were taken at the worst case, with the measuring antenna polarized horizontally.

11 FCC §15.247(e) – Power Spectral Density

11.1 Applicable Standard

According to FCC §15.247(e), for digitally modulated systems, the power spectral density conducted from the intentional radiator to the antenna shall not be greater than 8 dBm in any 3 kHz band during any time interval of continuous transmission.

11.2 Measurement Procedure

The measurements are based on FCC KDB 558074 D01 DTS Meas Guidance v03r01: Guidance for Performing Compliance Measurements on Digital Transmission Systems (DTS) Operating Under §15.247 section 10: Maximum power spectral density level in the fundamental emission

11.3 Test Equipment List and Details

Manufacturer	Description	Model No.	Serial No.	Calibration Date	Calibration Interval
Sunol Science Corp	System Controller	SC99V	122303-1	N/R	N/R
IW Microwave	SMA-Cable	SPS-2303-3840-SPS	DC1438	N/A	N/A
Agilent	Analyzer, Spectrum	E4440A	US 422221851	2014-04-09	1 year
Eaton	Antenna, Horn	96001	2617	2014-11-18	1 year

Statement of Traceability: *BACL attests that all calibrations have been performed per the A2LA requirements, traceable to NIST.*

11.4 Test Environmental Conditions

Temperature:	22° C
Relative Humidity:	52 %
ATM Pressure:	101.9 kPa

The testing was performed by Bo Li on 2015-03-31 in 5 m chamber 3.

11.5 Test Results

Frequency (MHz)	S.A. Reading (dBμV)	Test Antenna Factor (dB/m)	Cable Loss (dB)	Cord. Reading (dBμV/m)	EIRP (dBm/3kHz)	Antenna Gain (dBi)	Power Density (dBm/3kHz)	Limit
2405	54.10	28.417	-2.865	85.382	-9.818	4.000	-13.818	8
2440	55.60	28.417	-2.865	86.882	-8.318	4.000	-12.318	8
2480	47.21	28.785	-2.950	78.945	-16.255	4.000	-20.255	8

The field strength converts to conducted power should be as following:

$$E \text{ (dB}\mu\text{V/m)} = \text{EIRP [dBm]} + 95.2 \text{ for the distance at 3 meters.}$$

Please refer to the following plots for detailed test results:

Low channel: 2405 MHz

Middle channel: 2440 MHz

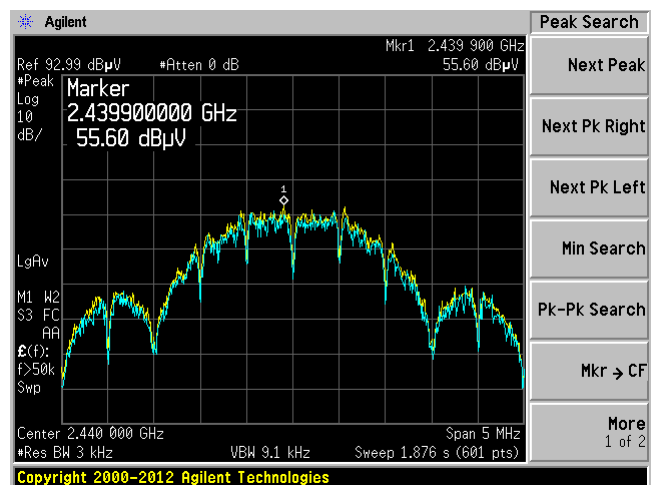
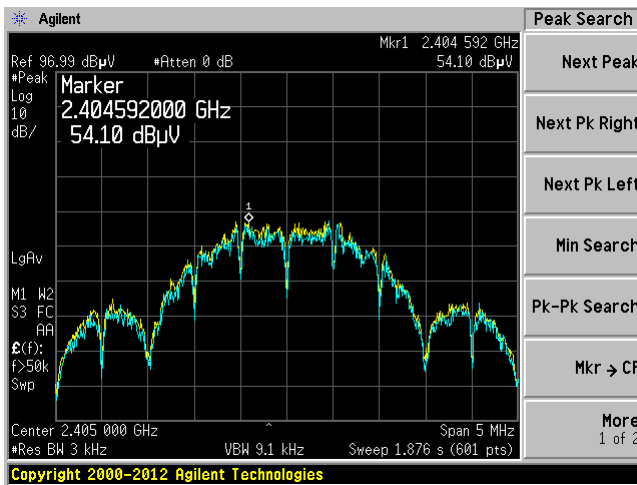

High Channel 2480 MHz

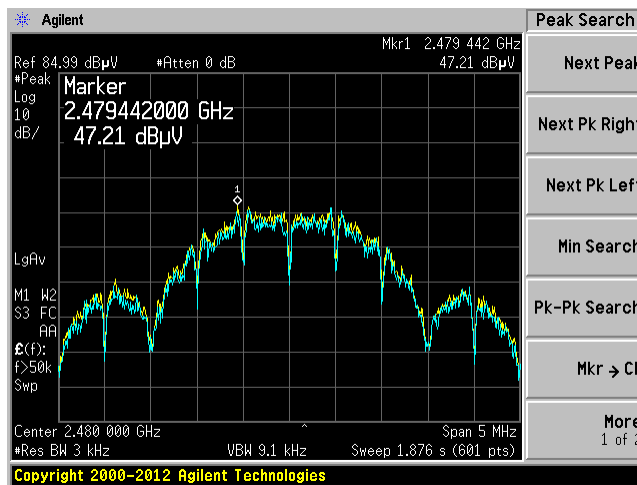

Note: These measurements were taken at the worst case, with the measuring antenna polarized horizontally.