



FCC PART 15 SUBPART B TEST REPORT

FCC PART 15B

FCC ID: **T37PL9667-ETH**

Report Reference No......: **WE09110003**

Compiled by

(position+printed name+signature)...: File administrators Cary Li

Cary Li

Supervised by

(position+printed name+signature)...: Test Engineer Wenliang Li

Wenliang Li

Approved by

(position+printed name+signature)...: Manager Jimmy Li

Jimmy Li

Date of issue.....: Nov 16, 2009

Testing Laboratory Name: **Shenzhen Huatongwei International Inspection Co., Ltd**

Address.....: Keji Nan No.12 Road, Hi-tech Park, Shenzhen, China

Applicant's name.....: **ASOKA USA CORPORATION**

Address.....: 2344-A Walsh Avenue, Santa Clara City, CA 95051

Test specification:

Standard: **FCC Part 15B- Unintentional Radiators**

TRF Originator.....: Shenzhen Huatongwei International Inspection CO., Ltd

Master TRF.....: Dated 2006-06

Shenzhen Huatongwei International Inspection Co., Ltd. All rights reserved.

This publication may be reproduced in whole or in part for non-commercial purposes as long as the Shenzhen Huatongwei International Inspection Co., Ltd is acknowledged as copyright owner and source of the material. Shenzhen Huatongwei International Inspection Co., Ltd takes no responsibility for and will not assume liability for damages resulting from the reader's interpretation of the reproduced material due to its placement and context.

Test item description : PlugLink AV 9667

Trade Mark: /

Model/Type reference.....: PL9667-ETH-B2

Listed Models: /

Result.....: **Positive**

TEST REPORT

Test Report No. :	WE09110003	Nov 16, 2009
		Date of issue

Equipment under Test : PlugLink AV 9667

Model /Type : PL9667-ETH-B2

Listed Models : /

Applicant : ASOKA USA CORPORATION

Address : 2344-A Walsh Avenue, Santa Clara City, CA 95051

Test Result according to the standards on page 4:	Positive
--	-----------------

The test report merely corresponds to the test sample.

It is not permitted to copy extracts of these test result without the written permission of the test laboratory.

Contents

- 1. TEST STANDARDS 4**

- 2. SUMMARY 5**
 - 2.1. General Remarks 5
 - 2.2. Equipment Under Test 5
 - 2.3. Short description of the Equipment under Test (EUT) 5
 - 2.4. EUT operation mode 5
 - 2.5. EUT configuration 5
 - 2.6. Related Submittal(s) / Grant (s) 6
 - 2.7. Modifications 6

- 3. TEST ENVIRONMENT 7**
 - 3.1. Address of the test laboratory 7
 - 3.2. Test Facility 7
 - 3.3. Environmental conditions 8
 - 3.4. Configuration of Tested System 8
 - 3.5. Statement of the measurement uncertainty 9
 - 3.6. Equipments Used during the Test 9

- 4. TEST CONDITIONS AND RESULTS 10**
 - 4.1. Conducted Emissions Test 10
 - 4.2. Radiated Emission Test 13

- 5. TEST SETUP PHOTOS OF THE EUT 17**

- 6. EXTERNAL AND INTERNAL PHOTOS OF THE EUT 18**

1. TEST STANDARDS

The tests were performed according to following standards:

[FCC Rules Part 15 Subpart B - Unintentional Radiators](#)

2.6. Related Submittal(s) / Grant (s)

This submittal(s) (test report) is intended for FCC ID: **T37PL9667-ETH** filing to comply with the FCC Part 15, Subpart B Rules.

2.7. Modifications

No modifications were implemented to meet testing criteria.

3. TEST ENVIRONMENT

3.1. Address of the test laboratory

Shenzhen Huatongwei International Inspection Co., Ltd
Keji Nan No.12 Road, Hi-tech Park, Shenzhen, China
Phone: 86-755-26715686 Fax: 86-755-26748089

The sites are constructed in conformance with the requirements of ANSI C63.7, ANSI C63.4 (2003) and CISPR Publication 22.

3.2. Test Facility

The test facility is recognized, certified, or accredited by the following organizations:

CNAS-Lab Code: L1225

Shenzhen Huatongwei International Inspection Co., Ltd has been assessed and proved to be in compliance with CNAS-CL01 Accreditation Criteria for Testing and Calibration Laboratories (identical to ISO/IEC 17025: 2005 General Requirements) for the Competence of Testing and Calibration Laboratories, Date of Registration: August 02, 2007. Valid time is until March 29, 2012.

A2LA-Lab Cert. No. 2243.01

Shenzhen Huatongwei International Inspection Co., Ltd, EMC Laboratory has been accredited by A2LA for technical competence in the field of electrical testing, and proved to be in compliance with ISO/IEC 17025: 2005 General Requirements for the Competence of Testing and Calibration Laboratories and any additional program requirements in the identified field of testing. Valid time is from Aug 24, 2005 to Dec 31, 2009.

FCC-Registration No.: 662850

Shenzhen Huatongwei International Inspection Co., Ltd, EMC Laboratory has been registered and fully described in a report filed with the FCC (Federal Communications Commission). The acceptance letter from the FCC is maintained in our files. Registration 662850, Renewal date July 01, 2009.

IC-Registration No.: 5377

The 3m Alternate Test Site of Shenzhen Huatongwei International Inspection Co., Ltd has been registered by Certification and Engineering Bureau of Industry Canada for the performance of radiated measurements with Registration No. 5377 on February 13th, 2009.

ACA

Shenzhen Huatongwei International Inspection Co., Ltd, EMC Laboratory can also perform testing for the Australian C-Tick mark as a result of our A2LA accreditation.

NEMKO-Aut. No.: ELA125

Shenzhen Huatongwei International Inspection Co., Ltd has been assessed the quality assurance system, the testing facilities, qualifications and testing practices of the relevant parts of the organization. The quality assurance system of the Laboratory has been validated against ISO/IEC 17025:2005 or equivalent. The laboratory also fulfils the conditions described in Nemko Document NLA-10, the Authorization is valid through Jul 07, 2011.

VCCI

The 3m Semi-anechoic chamber (12.2m×7.95m×6.7m) and Shielded Room (8m×4m×3m) of Shenzhen Huatongwei International Inspection Co., Ltd has been registered in accordance with the Regulations for Voluntary Control Measures with Registration No.: R-2484. Date of Registration: December 20, 2006. Valid time is until December 19, 2009.

Main Ports Conducted Interference Measurement of Shenzhen Huatongwei International Inspection Co., Ltd has been registered in accordance with the Regulations for Voluntary Control Measures with Registration No.: C-2726. Date of Registration: December 20, 2006. Valid time is until December 19, 2009.

DNV

Shenzhen Huatongwei International Inspection Co Ltd has been found to comply with the requirements of DNV towards subcontractor of EMC and safety testing services in conjunction with the EMC and Low voltage Directives and in the voluntary field. The acceptance is based on a formal quality Audit and follow-ups according to relevant parts of ISO/IEC Guide 17025(2005), in accordance with the requirements of the DNV Laboratory Quality Manual towards subcontractors. Valid time is until 09 July, 2010.

3.3. Environmental conditions

During the measurement the environmental conditions were within the listed ranges:

- Temperature: 15-35 ° C
- Humidity: 30-60 %
- Atmospheric pressure: 950-1050mbar

3.4. Configuration of Tested System

Fig. 2-1 Configuration of Tested System

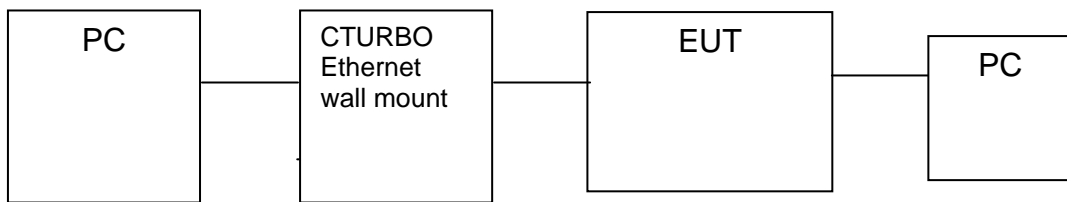

Table 2-1 Equipment Used in Tested System

No.	Product	Manufacturer	Model No.	Serial No.	
1	Notebook PC	ASUS	I9100L	59NP00972	
2	Notebook PC	IBM	1843-2XL	LV-BLH05 06/02	
3	CTURBO Ethernet wall mount	ASOKO	PL9650-ETH	/	

3.5. Statement of the measurement uncertainty

The data and results referenced in this document are true and accurate. The reader is cautioned that there may be errors within the calibration limits of the equipment and facilities. The measurement uncertainty was calculated for all measurements listed in this test report acc. to CISPR 16 - 4 „Specification for radio disturbance and immunity measuring apparatus and methods – Part 4: Uncertainty in EMC Measurements“ and is documented in the Shenzhen Huatongwei International Inspection Co., Ltd quality system acc. to DIN EN ISO/IEC 17025. Furthermore, component and process variability of devices similar to that tested may result in additional deviation. The manufacturer has the sole responsibility of continued compliance of the device.

Hereafter the best measurement capability for Shenzhen Huatongwei laboratory is reported:

Test	Range	Measurement Uncertainty	Notes
Radiated Emission	30~1000MHz	4.22dB	(1)
Radiated Emission	1~12.75GHz	4.35dB	(1)
Conducted Disturbance	0.15~30MHz	3.29dB	(1)

(1) This uncertainty represents an expanded uncertainty expressed at approximately the 95% confidence level using a coverage factor of k=2.

3.6. Equipments Used during the Test

AC Power Conducted Emission					
Item	Test Equipment	Manufacturer	Model No.	Serial No.	Last Cal.
1	EMI TEST RECEIVER	ROHDE & SCHWARZ	ESCI	100106	2009/11
2	ARTIFICIAL MAINS	ROHDE & SCHWARZ	ESH2-Z5	100028	2009/11
3	PULSE LIMITER	ROHDE & SCHWARZ	ESHSZ2	100044	2009/11
4	EMI TEST SOFTWARE	ROHDE & SCHWARZ	ES-K1 1.71	N/A	2009/11

Radiated Emissions					
Item	Test Equipment	Manufacturer	Model No.	Serial No.	Last Cal.
1	ULTRA-BROADBAND ANTENNA	ROHDE & SCHWARZ	HL562	100015	2009/11
2	EMI TEST RECEIVER	ROHDE & SCHWARZ	ESI 26	100009	2009/11
3	RF TEST PANEL	ROHDE & SCHWARZ	TS / RSP	335015/ 0017	2009/11
4	TURNTABLE	ETS	2088	2149	2009/11
5	ANTENNA MAST	ETS	2075	2346	2009/11
6	EMI TEST SOFTWARE	ROHDE & SCHWARZ	ESK1	N/A	2009/11

4. TEST CONDITIONS AND RESULTS

4.1. Conducted Emissions Test

TEST CONFIGURATION

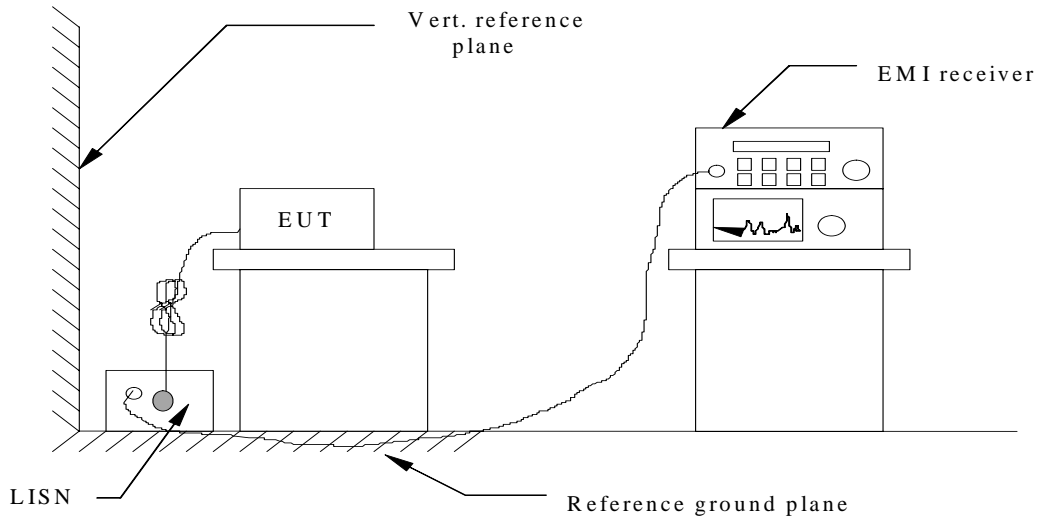

TEST PROCEDURE

- 1 The equipment was set up as per the test configuration to simulate typical actual usage per the user's manual. The EUT is a tabletop system, a wooden table with a height of 0.8 meters is used and is placed on the ground plane as per ANSI C63.4.
- 2 Support equipment, if needed, was placed as per ANSI C63.4.
- 3 All I/O cables were positioned to simulate typical actual usage as per ANSI C63.4.
- 4 The EUT received the AC120V/60Hz power through a Line Impedance Stabilization Network (LISN) which supplied power source and was grounded to the ground plane.
- 5 All support equipments received AC power from a second LISN, if any.
- 6 The EUT test program was started. Emissions were measured on each current carrying line of the EUT using a spectrum Analyzer / Receiver connected to the LISN powering the EUT. The LISN has two monitoring points: Line 1 (Hot Side) and Line 2 (Neutral Side). Two scans were taken: one with Line 1 connected to Analyzer / Receiver and Line 2 connected to a 50 ohm load; the second scan had Line 1 connected to a 50 ohm load and Line 2 connected to the Analyzer / Receiver.
- 7 Analyzer / Receiver scanned from 150 KHz to 30MHz for emissions in each of the test modes.
- 8 During the above scans, the emissions were maximized by cable manipulation.

Conducted Power Line Emission Limit

For unintentional device, according to § 15.107(a) Line Conducted Emission Limits is as following :

Frequency (MHz)	Maximum RF Line Voltage (dBµV)			
	CLASS A		CLASS B	
	Q.P.	Ave.	Q.P.	Ave.
0.15 - 0.50	79	66	66-56*	56-46*
0.50 - 5.00	73	60	56	46
5.00 - 30.0	73	60	60	50

* Decreasing linearly with the logarithm of the frequency

For intentional device, according to §15.207(a) Line Conducted Emission Limit is same as above table.

TEST RESULTS

SCAN TABLE: "Voltage (150K-30M) FIA"
 Short Description: 150K-30M Voltage

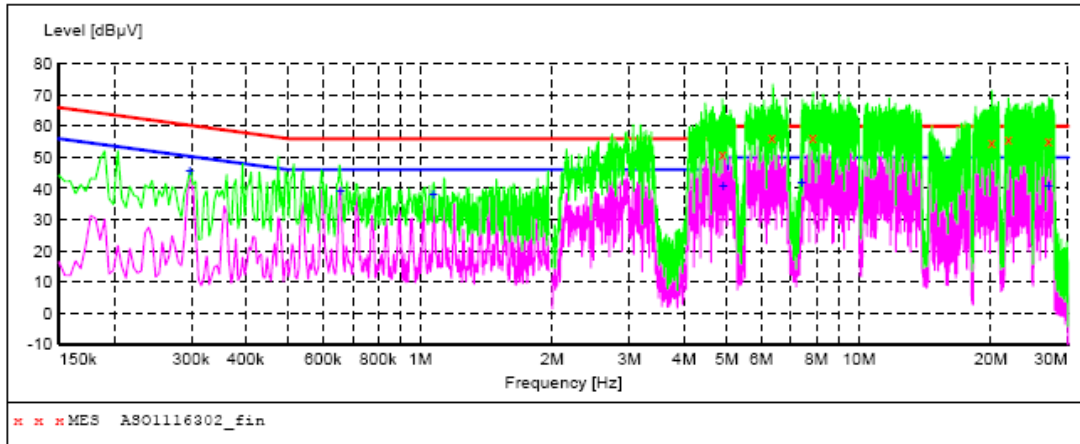

MEASUREMENT RESULT: "AS01116302_fin"

11/16/2009 9:24AM

Frequency MHz	Level dBµV	Transd dB	Limit dBµV	Margin dB	Detector	Line	PE
4.889000	51.20	10.4	56	4.8	QP	L1	GND
6.342500	56.30	10.4	60	3.7	QP	L1	GND
7.854500	56.70	10.5	60	3.3	QP	L1	GND
20.085500	54.90	11.0	60	5.1	QP	L1	GND
21.944000	55.80	11.0	60	4.2	QP	L1	GND
27.101000	55.10	11.2	60	4.9	QP	L1	GND

MEASUREMENT RESULT: "AS01116302_fin2"

11/16/2009 9:24AM

Frequency MHz	Level dBµV	Transd dB	Limit dBµV	Margin dB	Detector	Line	PE
0.298500	45.40	10.2	50	4.9	AV	L1	GND
0.658500	39.40	10.2	46	6.6	AV	L1	GND
1.072500	38.20	10.3	46	7.8	AV	L1	GND
4.911500	40.70	10.4	46	5.3	AV	L1	GND
7.404500	42.00	10.5	50	8.0	AV	L1	GND
27.119000	41.00	11.2	50	9.0	AV	L1	GND

Remark:

- (1) Measuring frequencies from 0.15 MHz to the 30 MHz.
- (2) Data of measurement within this frequency range shown "---" in the table above means the reading of emissions are attenuated more than 20dB below the permissible limits or the field strength is too small to be measured.
- (3) The IF bandwidth of EMI Test Receiver was 9KHz for measuring from 0.15 MHz to 30 MHz

SCAN TABLE: "Voltage (150K-30M) FIA"
 Short Description: 150K-30M Voltage

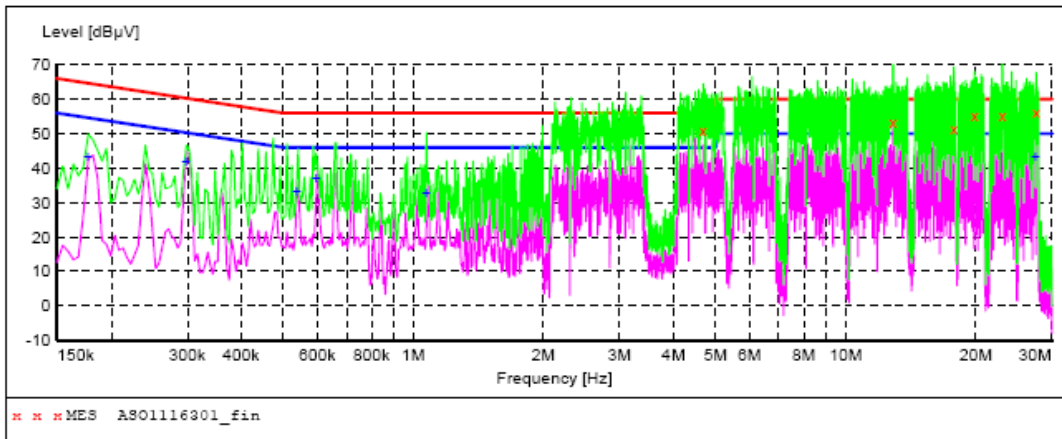

MEASUREMENT RESULT: "AS01116301_fin"

11/16/2009 8:57AM

Frequency MHz	Level dBµV	Transd dB	Limit dBµV	Margin dB	Detector	Line	PE
4.682000	51.00	10.4	56	5.0	QP	N	GND
12.872000	53.60	10.6	60	6.4	QP	N	GND
17.795000	51.30	10.8	60	8.7	QP	N	GND
19.869500	55.50	10.9	60	4.5	QP	N	GND
23.073500	55.40	11.1	60	4.6	QP	N	GND
27.587000	56.20	11.2	60	3.8	QP	N	GND

MEASUREMENT RESULT: "AS01116301_fin2"

11/16/2009 8:56AM

Frequency MHz	Level dBµV	Transd dB	Limit dBµV	Margin dB	Detector	Line	PE
0.177000	43.20	10.2	55	11.4	AV	N	GND
0.298500	41.90	10.2	50	8.4	AV	N	GND
0.537000	33.10	10.2	46	12.9	AV	N	GND
0.595500	37.00	10.2	46	9.0	AV	N	GND
1.072500	32.60	10.3	46	13.4	AV	N	GND
27.519500	43.40	11.2	50	6.6	AV	N	GND

Remark:

- (1) Measuring frequencies from 0.15 MHz to the 30 MHz.
- (2) Data of measurement within this frequency range shown "---" in the table above means the reading of emissions are attenuated more than 20dB below the permissible limits or the field strength is too small to be measured.
- (3) The IF bandwidth of EMI Test Receiver was 9KHz for measuring from 0.15 MHz to 30MHz

4.2. Radiated Emission Test

TEST CONFIGURATION

(A) Radiated Emission Test Set-Up, Frequency Below 30MHz

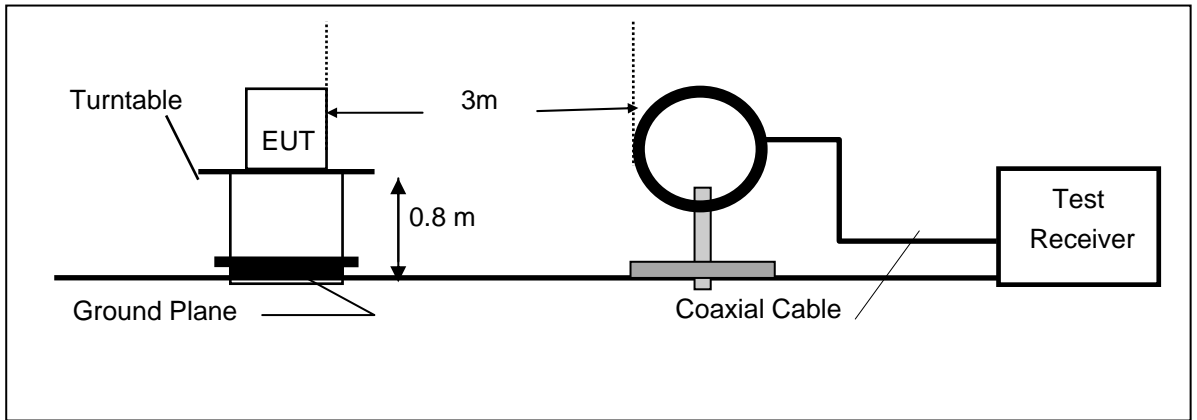

(B) Radiated Emission Test Set-Up, Frequency below 1000MHz

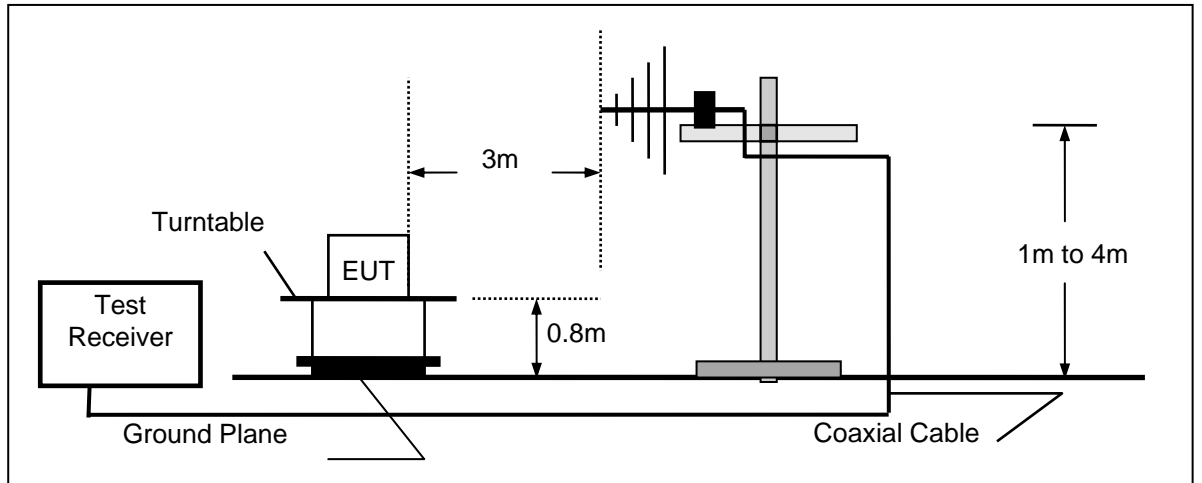

(C) Radiated Emission Test Set-Up, Frequency above 1000MHz

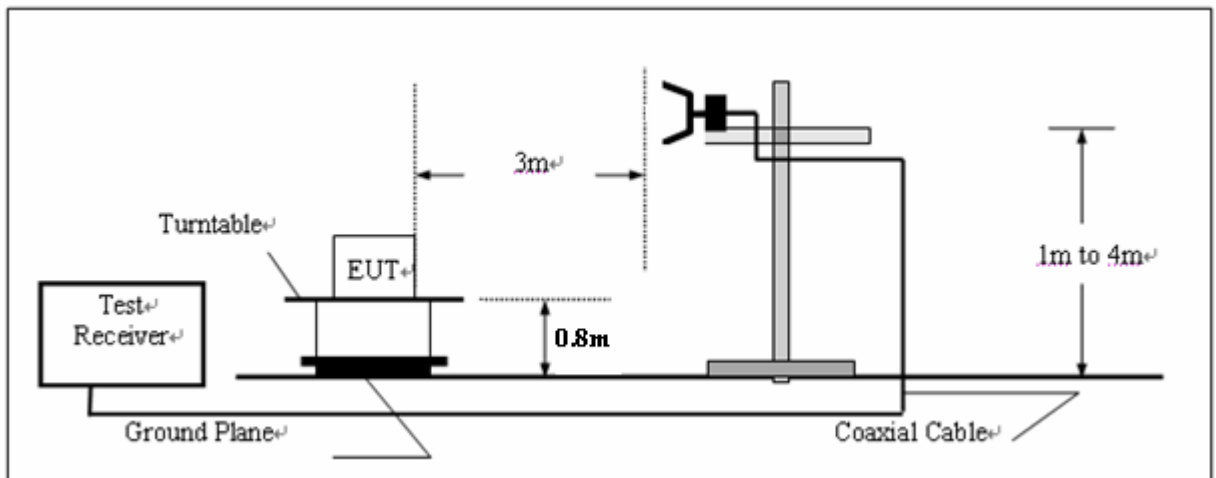

TEST PROCEDURE

- 1 The EUT was placed on a turn table which is 0.8m above ground plane.
- 2 Maximum procedure was performed by raising the receiving antenna from 1m to 4m and rotating the turn table from 0° to 360° to acquire the highest emissions from EUT
3. And also, each emission was to be maximized by changing the polarization of receiving antenna both horizontal and vertical.
4. Repeat above procedures until all frequency measurements have been completed.

Field Strength Calculation

The field strength is calculated by adding the Antenna Factor and Cable Factor and subtracting the Amplifier Gain and Duty Cycle Correction Factor (if any) from the measured reading. The basic equation with a sample calculation is as follows:

$$FS = RA + AF + CL - AG$$

Where FS = Field Strength	CL = Cable Attenuation Factor (Cable Loss)
RA = Reading Amplitude	AG = Amplifier Gain
AF = Antenna Factor	

RADIATION LIMIT

For unintentional device, according to § 15.109(a), except for Class A digital devices, the field strength of radiated emissions from unintentional radiators at a distance of 3 meters shall not exceed the following values:

Frequency (MHz)	Distance (Meters)	Radiated (dBµV/m)	Radiated (µV/m)
30-88	3	40.0	100
88-216	3	43.5	150
216-960	3	46.0	200
Above 960	3	54.0	500

For intentional device, according to § 15.209(a), the general requirement of field strength of radiated emissions from intentional radiators at a distance of 3 meters shall not exceed the above table.

Test Procedure

1. The EUT is placed on a turntable, which is 0.8m above ground plane.
2. The turntable shall be rotated for 360 degrees to determine the position of maximum emission level.
3. EUT is set 3m away from the receiving antenna, which is varied from 1m to 4m to find out the highest emissions.
4. Maximum procedure was performed on the six highest emissions to ensure EUT compliance.
5. And also, each emission was to be maximized by changing the polarization of receiving antenna both horizontal and vertical.
6. Repeat above procedures until the measurements for all frequencies are complete.

TEST RESULTS

Operation Mode: Normal Operation

Temperature: 20 C Humidity: 70 % RH

Polarity: Ver. / Hor.

SCAN TABLE: "test Field(30M-1G)OP"

Short Description:		Field Strength(30M-1G)				
Start	Stop	Step	Detector	Meas. Time	IF Bandw.	Transducer
Frequency	Frequency	Width				
30.0 MHz	1.0 GHz	60.0 kHz	QuasiPeak	1.0 s	120 kHz	HL562 09

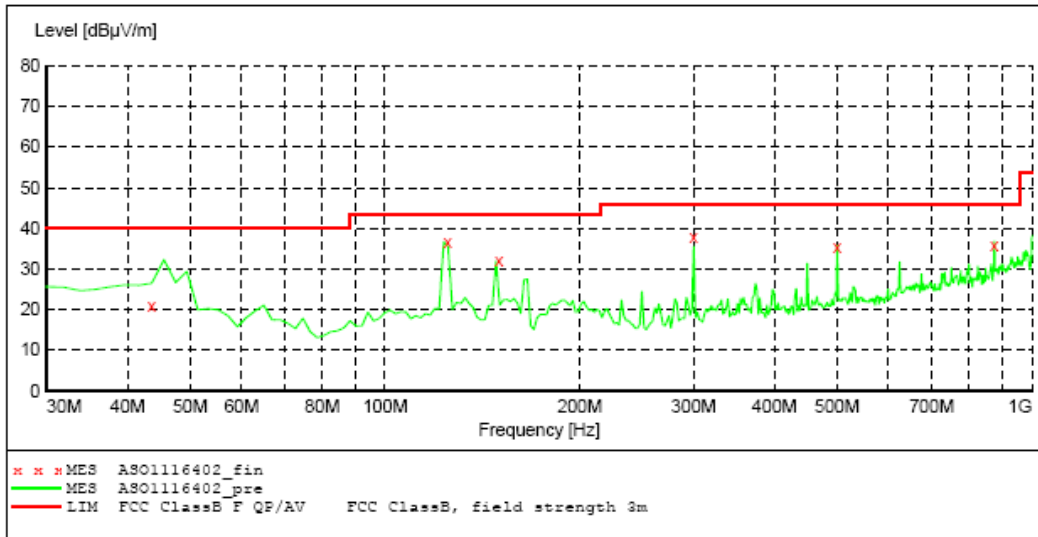

MEASUREMENT RESULT: "AS01116402_fin"

11/16/2009 12:58PM

Frequency MHz	Level dBµV/m	Transd dB	Limit dBµV/m	Margin dB	Det.	Height cm	Azimuth deg	Polarization
43.560000	20.80	-12.3	40.0	19.2	QP	100.0	96.00	VERTICAL
124.980000	36.50	-13.3	43.5	7.0	QP	100.0	38.00	VERTICAL
150.000000	32.00	-16.2	43.5	11.5	QP	100.0	288.00	VERTICAL
300.000000	38.00	-10.9	46.0	8.0	QP	126.0	205.00	VERTICAL
499.980000	35.30	-6.7	46.0	10.7	QP	100.0	196.00	VERTICAL
874.980000	35.90	0.6	46.0	10.1	QP	100.0	0.00	VERTICAL

Remark:

- (1) Measuring frequencies from 30 MHz to the 1 GHz.
- (2) * denotes emission frequency which appearing within the Restricted Bands specified in provision of 15.205, then the general radiated emission limits in 15.209 apply.
- (3) Data of measurement within this frequency range shown "---" in the table above means the reading of emissions are attenuated more than 20dB below the permissible limits or the field strength is too small to be measured.
- (4) The IF bandwidth of EMI Test Receiver was 120KHz for measuring from 30 MHz to 1 GHz and 1 MHz for measuring above 1 GHz

SCAN TABLE: "test Field(30M-1G) OP"

Short Description:		Field Strength(30M-1G)				
Start	Stop	Step	Detector	Meas. Time	IF Bandw.	Transducer
30.0 MHz	1.0 GHz	60.0 kHz	QuasiPeak	1.0 s	120 kHz	HL562 09

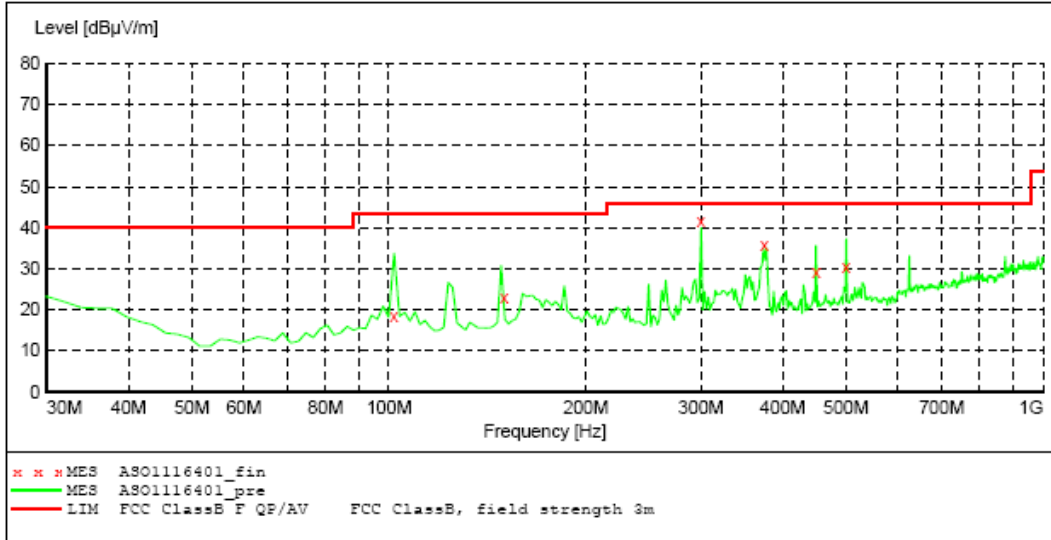

MEASUREMENT RESULT: "AS01116401_fin"

11/16/2009 12:49PM

Frequency MHz	Level dBuV/m	Transd dB	Limit dBuV/m	Margin dB	Det.	Height cm	Azimuth deg	Polarization
101.880000	18.30	-13.7	43.5	25.2	QP	350.0	124.00	HORIZONTAL
150.000000	22.90	-16.2	43.5	20.6	QP	337.0	43.00	HORIZONTAL
300.000000	41.50	-10.9	46.0	4.5	QP	100.0	203.00	HORIZONTAL
375.000000	35.60	-9.2	46.0	10.4	QP	100.0	110.00	HORIZONTAL
450.000000	29.20	-8.3	46.0	16.8	QP	150.0	127.00	HORIZONTAL
499.980000	30.30	-6.7	46.0	15.7	QP	100.0	261.00	HORIZONTAL

Remark:

- (1) Measuring frequencies from 30 MHz to the 1 GHz.
- (2) * denotes emission frequency which appearing within the Restricted Bands specified in provision of 15.205, then the general radiated emission limits in 15.209 apply.
- (3) Data of measurement within this frequency range shown "---" in the table above means the reading of emissions are attenuated more than 20dB below the permissible limits or the field strength is too small to be measured.
- (4) The IF bandwidth of EMI Test Receiver was 120KHz for measuring from 30 MHz to 1 GHz and 1 MHz for measuring above 1 GHz

5. Test Setup Photos of the EUT

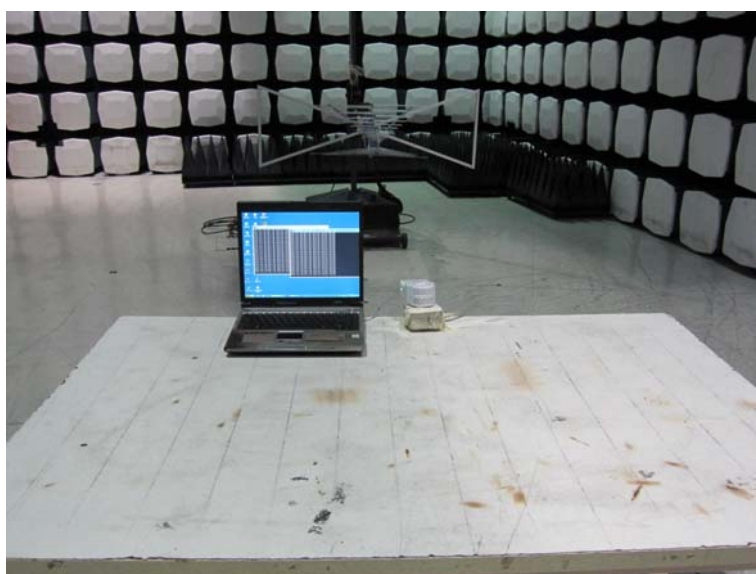
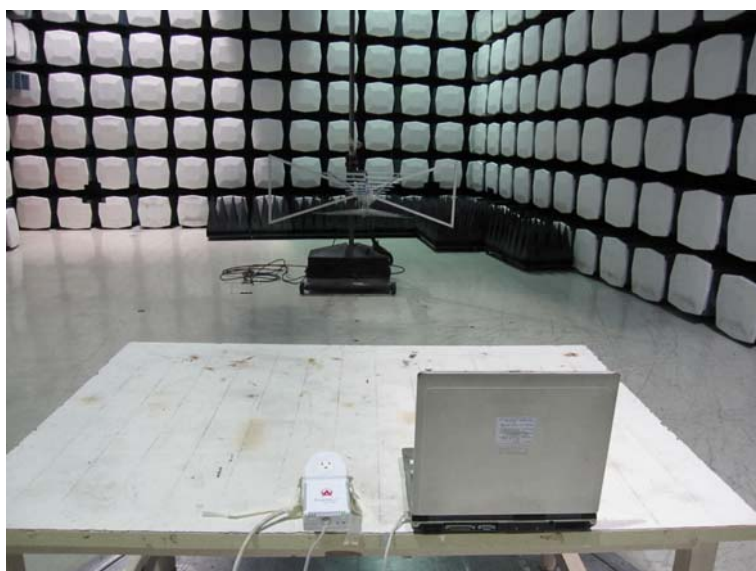

6. External and Internal Photos of the EUT

External Photos



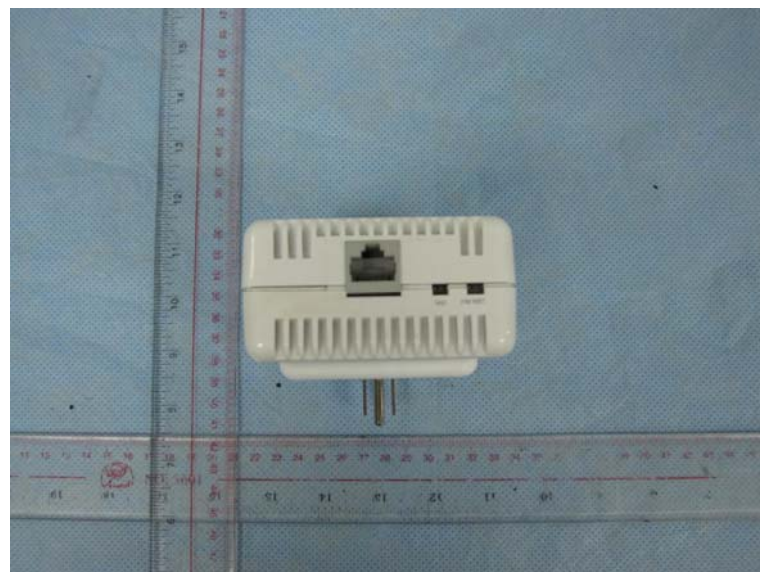

Internal Photos of the EUT

Internal Photos

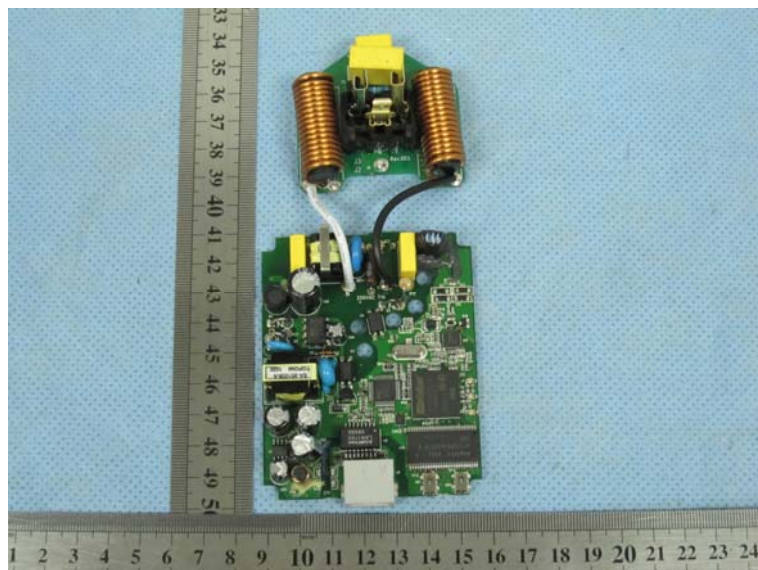
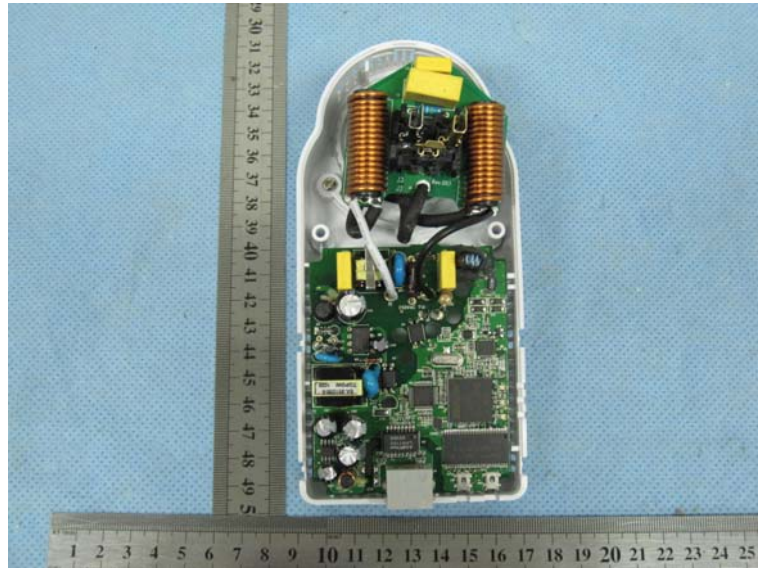
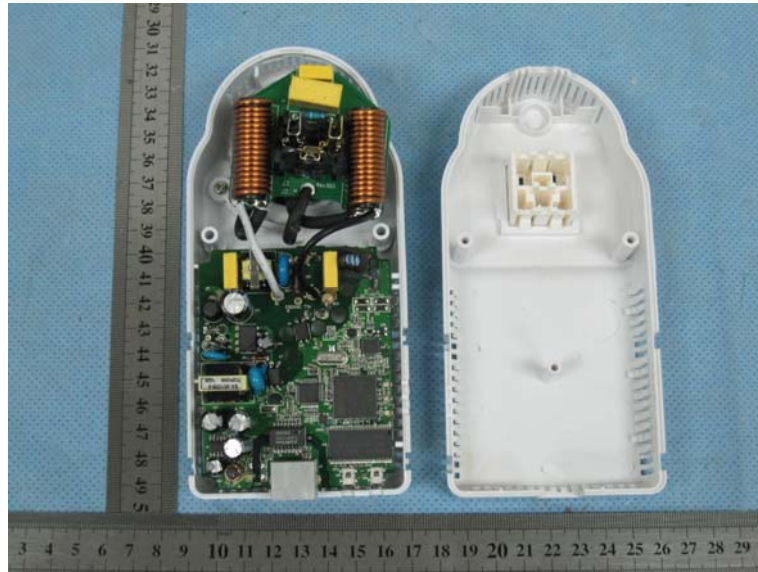

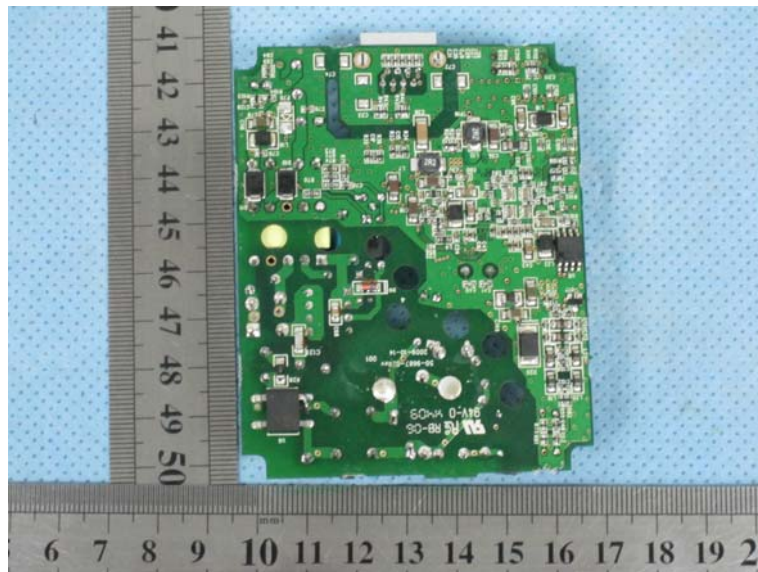
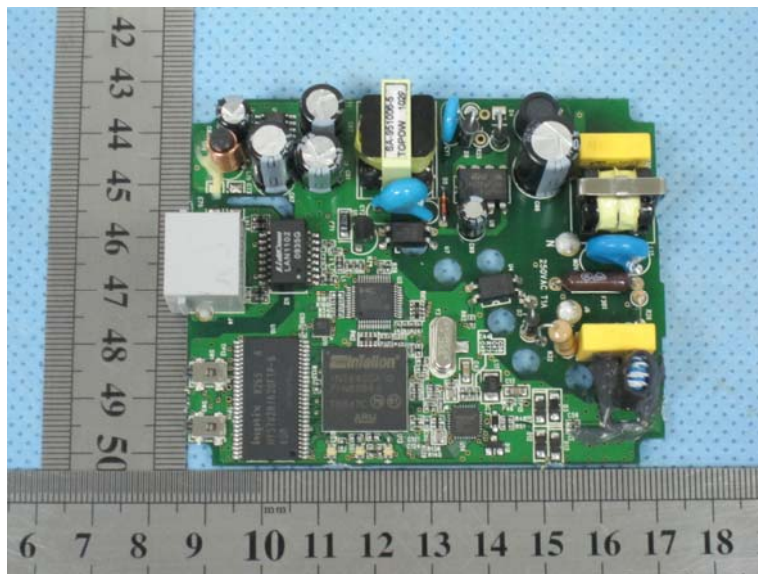

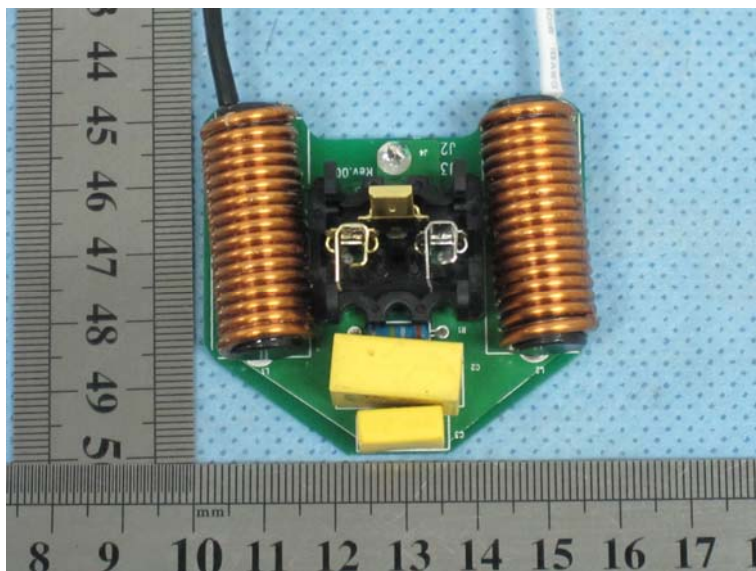

.....End of Report.....