



A S O K A®

PlugLink HD AV Eco Adapter User's Guide

PL9661-ETH

PlugLink[®] AV
by Asoka[®]

QUICKFIND LOCATOR

Contact

Information

Getting Help Table

of Contents

Installation

66-0360-00Rev.001

© 2009 Asoka USA Corporation

ALL RIGHTS RESERVED

Notice: No part of this publication may be reproduced or transmitted in any form or by any means, electronic or mechanical, including photocopying and recording, or stored in a database or retrieval system for any purpose without the express written permission of Asoka USA Corporation.

Asoka USA Corporation reserves the right to make changes to this user's guide at any time without notice and assumes no responsibility for its use. Asoka USA products and services can only be ordered under the terms and conditions of Asoka USA Corporation's applicable agreements. All of the features described in this user's guide may not be currently available. Refer to the most recent product announcement for information about feature and product availability.

This user's guide contains the most current information available at the time of publication. When new and/or revised information becomes available, this entire user's guide is updated and distributed to all registered users.

All company and product names mentioned herein are trademarks of their respective companies. Mention of third-party products is for informational purposes only and constitutes neither an endorsement nor a recommendation. Asoka USA Corporation assumes no responsibility with regard to the performance or use of these products.

Revision	Date	Description
66-0360-00Rev.001	May 2009	Preliminary Release

Changes in This Revision

- Not applicable (preliminary release)

Contact Information

For more information about the PlugLink HD AV Eco Adapter or any of Asoka's other leading-edge solutions, please contact us using any of the following methods:

- **Voice calls:** We welcome your calls Monday through Friday, from 9:00 am to 5:00 pm Pacific Time at (408) 550-8167. Voice mail is available during non-business hours.
- **Email:** If you prefer, you can send information requests to our e-mail address: sales@asokausa.com.
- **Fax calls:** You can also send your requests for information to our 24-hour fax number: (408) 884-2390.
- **Web site:** Our Web site contains valuable information about our products, solutions, and services. We encourage you to visit us at <http://www.asokausa.com>.

Getting Help

Asoka USA backs its products with unparalleled customer service and technical support for our valued customers.

Customer Service

Customer service, the customer-satisfaction arm of Asoka USA, is available Monday through Friday, from 9:00 am to 5:00 pm Pacific Time, by calling (408) 550-8173 or emailing custserv@asokausa.com.

Technical Support

Technical support is available Monday through Friday, from 6:00 am to 6:00 pm Pacific Time, by calling (408) 550-8173 or through email at support@asokausa.com.

Please provide the following information about the problem:

- Product name, model number, part number (if applicable) and serial number
- System configuration, including a description of the devices connected to your PlugLink HD AV Eco Adapter
 - The circumstances surrounding the error or failure
 - A detailed description of the problem and what has been done to try to solve it

Table of Contents

1	Simple Installation	1-1
	Package Contents	1-1
	Types of Connections.	1-1
	Simple Connection (Peer to Peer)	1-2
	Simple Broadband Connection.	1-2
	Other Connections.	1-3
	Finding a Suitable Location.	1-3
	Installing the Hardware	1-3
2	Advanced Configuration (Expert Users Only)	2-1
	Installing the Software.	2-1
3	Network Management	3-1
	Viewing Device Information	3-1
	Changing Names and Encryption Keys.	3-2
	Resetting and Upgrading the PlugLink AV	3-3
	Manually Resetting Firmware and NID.	3-4
	Prioritizing Network Traffic.	3-5
	Viewing Network Statistics	3-6
	Viewing Ethernet and HomePlug Connection	3-6
	Viewing Connection Speed	3-7
	Statistics Subscreen.	3-7
	Scanning Devices.	3-8
4	Troubleshooting.	4-1
A	Specifications	A-1
B	Components.	B-1
D	Warranty	D-1
E	FCC Notice	E-1



1

Simple Installation

Congratulations on your purchase of the PlugLink HD AV ECo Adapter!

This adapter allows you to network your home or office by plugging directly into an electrical outlet. With your PlugLink HD AV ECo Adapter, you can easily share your high-speed Internet, mp3s, video, and gaming throughout the home or office.

This manual describes how to connect your PlugLink HD AV ECo Adapter to a PC or cable/DSL router.

Package Contents

- PlugLink HD AV ECo Adapter (PL9661-ETH)
- 6-foot Ethernet cable
- Quick Installation Guide
- Installation Resource CD (for advanced users only)
- Warranty and Support Information Card



If any of the parts are incorrect, missing, or damaged, contact the retailer where you made your purchase. Keep the carton, including the original packing materials, in case you need to return the unit for repair.

Types of Connections

This section describes what you need to do to before installing the PlugLink HD AV ECo Adapter. You can set up a home or an office network or compliment your existing network by connecting to any device with a 10BaseT/100BaseT Ethernet-capable device.

Simple Connection (Peer to Peer)

To share a simple connection between computers, attach one PL9661-ETH device to each computer.

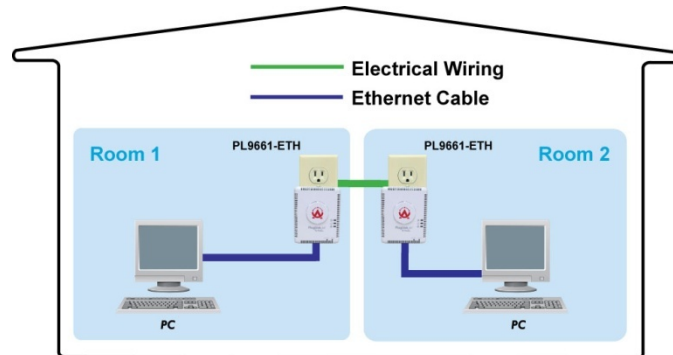

NOTE: Do not connect the PlugLink HD AV Eco Adapter into a power strip, extension cord, un-interruptible power supply (UPS), or surge protector. This may prevent the unit from working properly or degrade the network performance.

Simple Broadband Connection

The following items are needed to share a Broadband connection with computers:

- One (1) PL9661-ETH device attached to a standard cable, DSL, or wireless router
- One (1) PL9661-ETH device attached to each computer

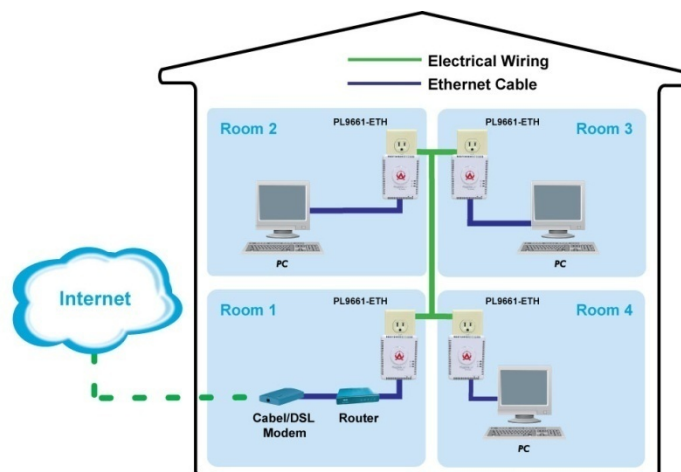

Other Connections

You can also use the PlugLink HD AV ECo Adapter with other Ethernet enabled devices, such as IP Cameras, IP set top box, game consoles, etc.

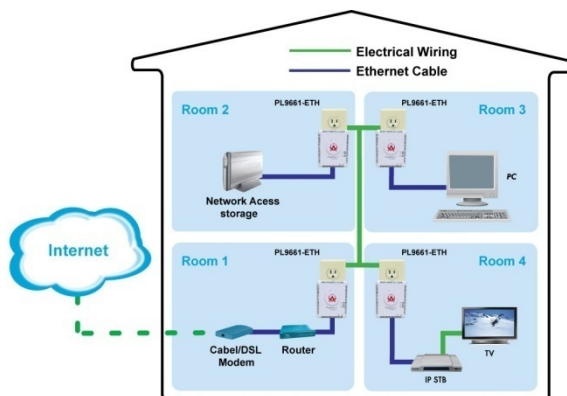

Finding a Suitable Location

Find a suitable location to install your PlugLink HD AV ECo Adapter. Where you install the units can affect their performance. Find a location that is:

- Acceptable temperature and humidity ranges.
- Free of strong electromagnetic field generators (such as motors), vibration, dust, and direct exposure to sunlight.
- An electrical outlet for your PlugLink HD AV ECo Adapter. Outlet must be within six feet (1.82 meters) of the device you are connecting to.

Installing the Hardware

Connect each of your PlugLink HD AV ECo Adapters.

1. Connect the unit into a nearby wall outlet (Do not plug the adapter into a power strip).
2. Connect the enclosed Ethernet cable to the Ethernet port of the unit.
3. Connect the other end of the cable to the Ethernet port of the PC or device.



Congratulations! You have completed the installation of the PlugLink HD AV ECo Adapter for normal use.

Advanced Configuration (Expert Users Only)

This chapter provides information on installing and setting up the PlugLink HD AV ECo Adapter.



NOTE: Do not connect the PlugLink HD AV ECo Adapter into a power strip, extension cord, un-interruptible power supply (UPS), or surge protector. This may prevent the unit from working properly or degrade the network performance.

Installing the Software

Following are software installation procedures for advanced users.



NOTE: Software installation is not required for normal use. The utility is used to change the security settings and view information about the network.

- 1 Insert the enclosed Installation Resource CD into your CD-ROM drive. If the PlugLink HD AV ECo Adapter Installation Utility does not appear within 30 seconds, select your CD-ROM drive and double-click the **Setup.exe** icon to start the Installation Utility.
- 2 Select the language preference, and click the **Run** button.

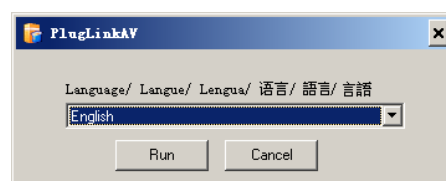

3. In the Start screen, click **Install Driver** to start the installation.

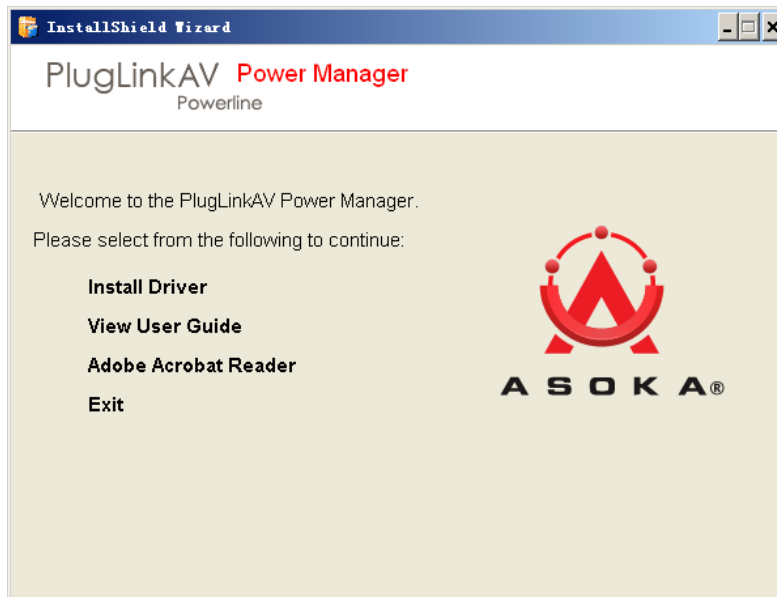

4. In the Welcome screen of the screen of the wizard, click **Next** to begin the installation.

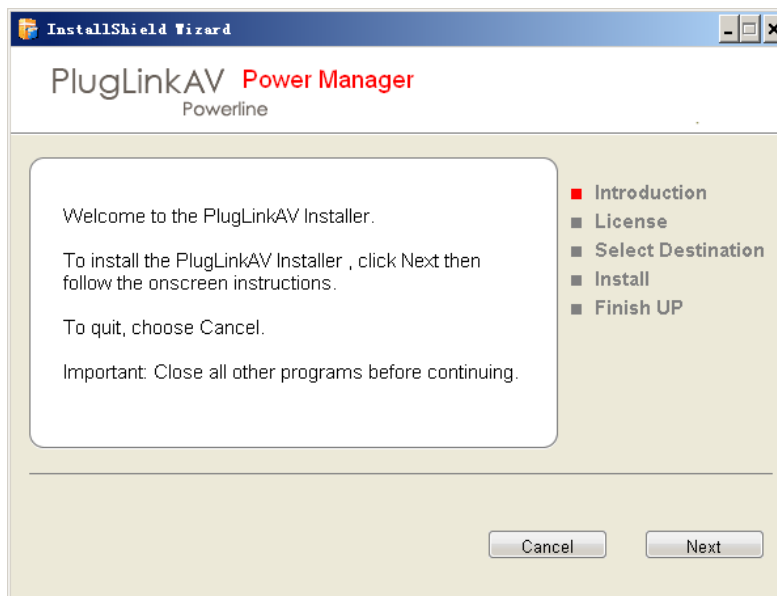

5. Read the End User Software License Agreement, and if you agree, click the Agree button to continue the installation.

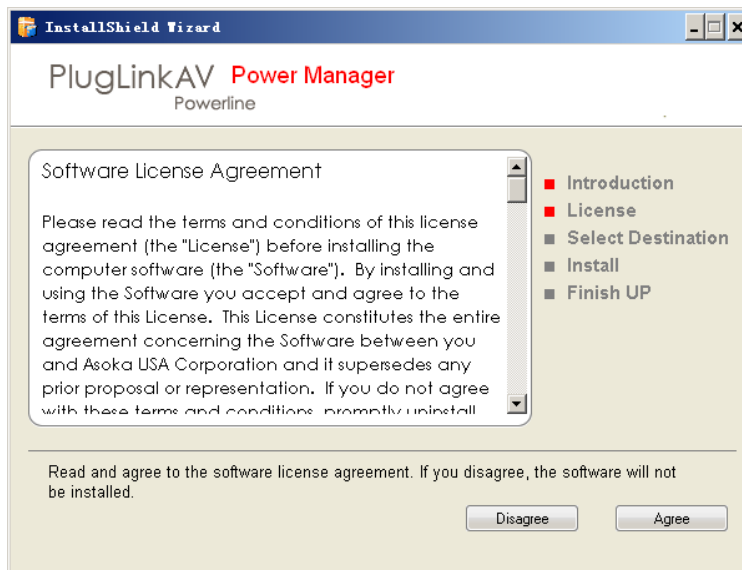

6. To change the name of the PlugLink AV unit, select Yes, and enter a name in the text field. Otherwise, select No. Click Next to advance to the next screen.

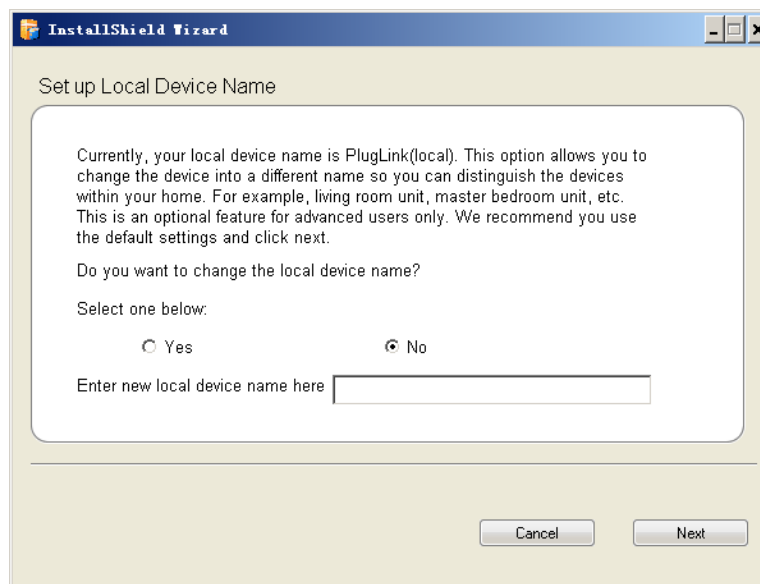

7. This following screen allows you to change the network password for your PlugLink HD AV ECo Adapter units. To change the network password, select **Yes** and then enter the new password in the text field. Or, select **No** and click the **Next** button to continue.

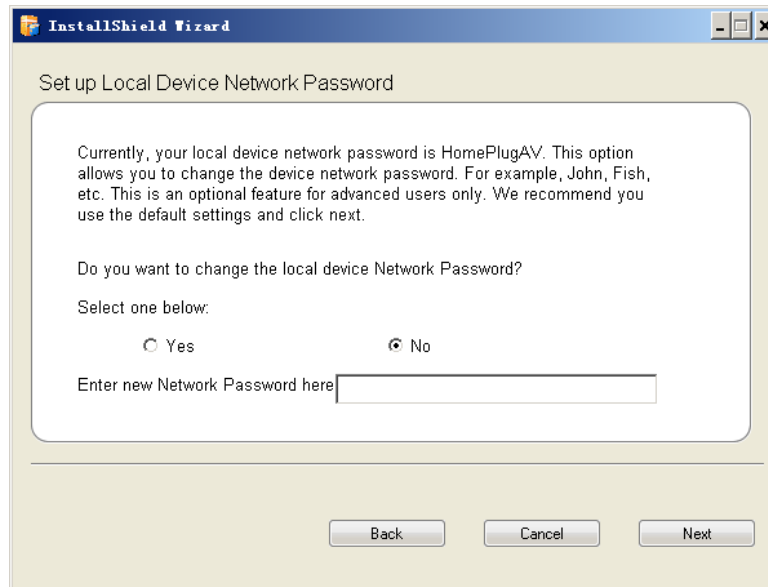

NOTE: All devices on your network must share the same password to communicate. Use care when changing the network password. The default password is HomePlugAV.

8. Select the location where you want to install the drivers and software and click the **Install** button.

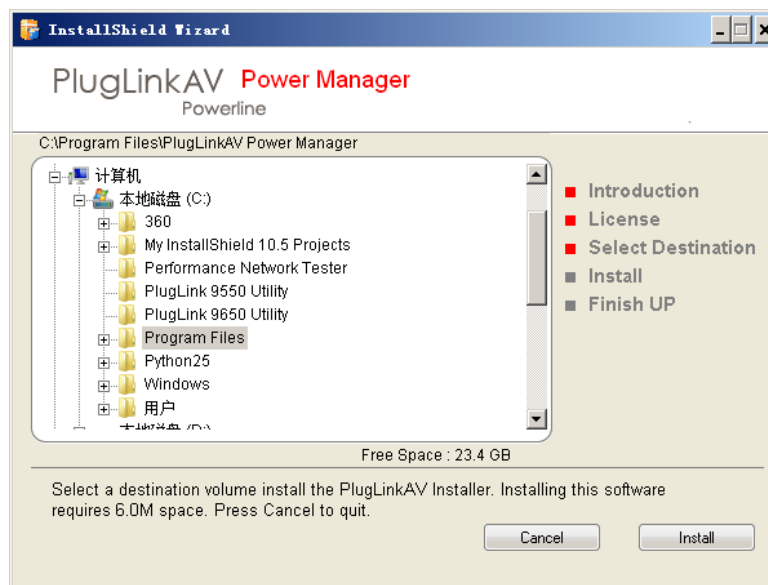

9. When the installation of the PlugLink AV drivers and software is complete, you can use Power Manager Utility for advanced configuration of your PlugLink AV 9661 unit. Click **Finish** to finish the installation wizard.

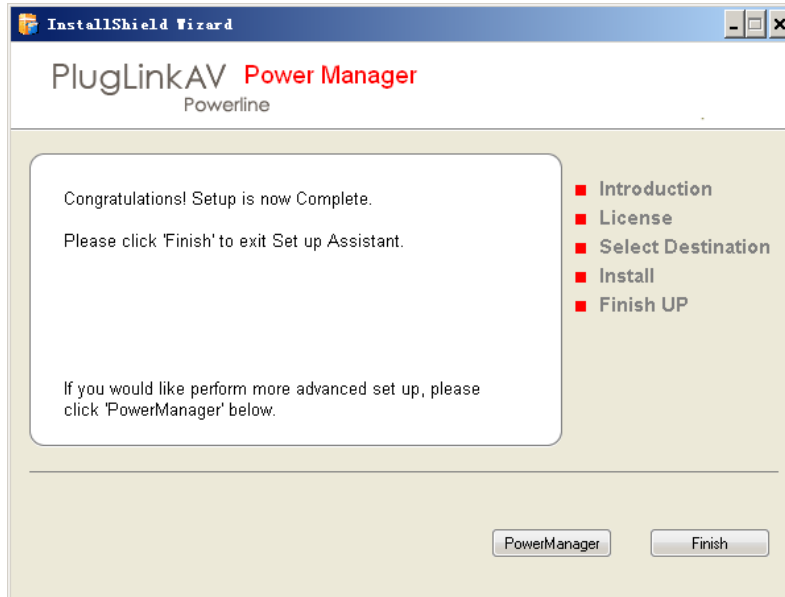

Network Management

The Power Manager Utility allows you to manually configure a PlugLink HD AV ECo Adapter that is directly connected to your Personal Computer or to any PlugLink HD AV ECo Adapters that are remotely residing on your PlugLink AV Mealybug network.



NOTE: The Power Manager Utility is for all Asoka PLC devices.

Viewing Device Information

Use the Profile screen to view information on all Mealybug devices attached directly to your PC and other Mealybug devices on your network.

The Profile screen displays the following information:

- Device Name
- MAC Address
- Firmware version of your devices
- Estimated device transmission rate

To refresh the list of Mealybug devices, Click the Rescan button.



NOTE: Devices set up with a different network password will NOT show up on this list.

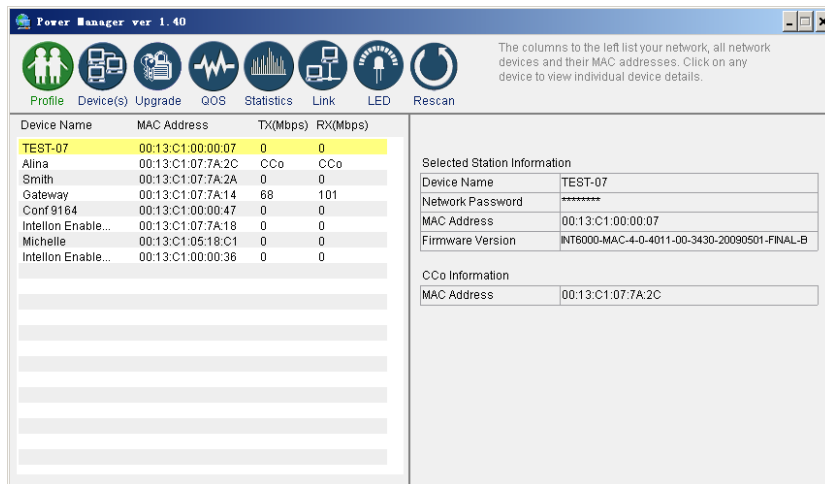

Changing Names and Encryption Keys

Use the Device Screen to change your local and remote device names and change local and remote device Network Encryption Keys (NEK). Always change the remote devices before changing the one you are connected to.

To change a remote device's NEK:

- 1 Check the box next to the device that you want to change the NEK.
- 2 Enter the password of the remote device. The password is printed on the device label. The default password is "HomePlugAV."
- 3 Enter a new password.
- 4 Click the **Update** button



NOTE: The device will not appear again until the device you are connected to is changed to the same password. All devices must have the same password.

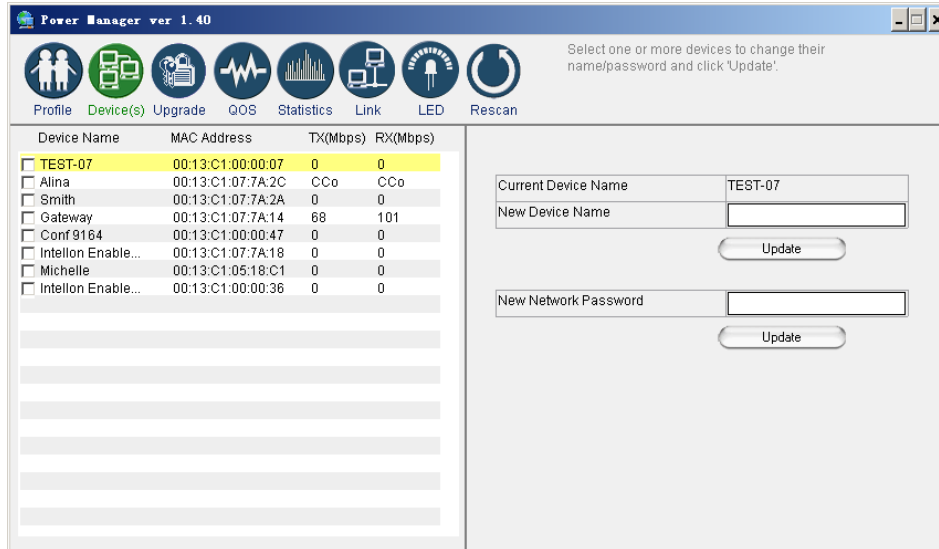

Resetting and Upgrading the PlugLink AV

Use the Upgrade Screen to perform the following functions:

- Reset the PlugLink HD AV ECo Adapter to factory default settings.
- Reboot the PlugLink HD AV ECo Adapter device. You can also reboot the device by unplugging and replugging the unit into the electrical outlet.
- Upgrade the firmware for the PlugLink HD AV ECo Adapter device. Visit www.asokausa.com to upgrade the firmware.

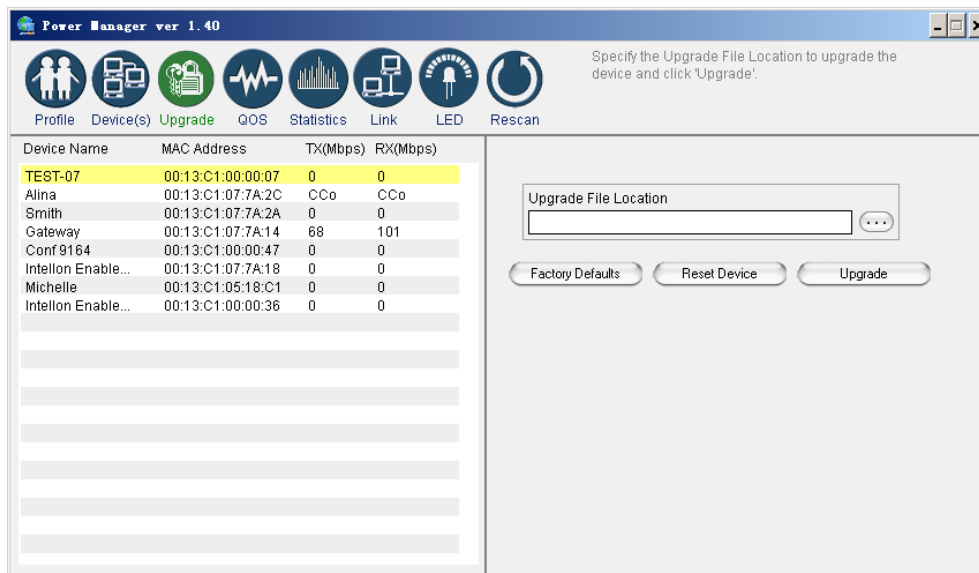

Manually Resetting Firmware and NID

You can use the buttons on the PlugLink device to reset the firmware to its default, or NID to associate a network.

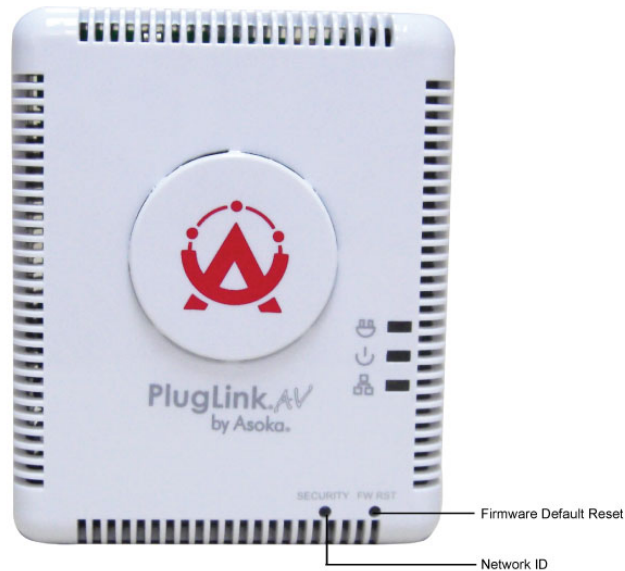

NOTE: The PlugLink device must be plugged into an electrical outlet when using these buttons. If you have questions, please contact Asoka USA Technical Support at (408) 550-8173

Prioritizing Network Traffic

Use the QoS screen to prioritize your traffic through the device.

- IGMP - (default CAP 3) - sets the channel access priority for IGMP group management frames
- Unicast - (default CAP 1) - sets the default channel access priority for Unicast frames not matching any other classification or mapping.
- IGMP managed Multicast Stream (It is better set it fixed to CAP 2) -sets the default channel access priority for stream data belonging to a snooped IGMP multicast group.
- Multicast/Broadcast - sets the default CAP for multicast frames not in a snooped group and for broadcast frames.

Power Manager ver 1.40

Profile Device(s) Upgrade QoS Statistics Link LED Rescan

QoS requirements are different for various data types such as streaming video or music, voice and raw data. To provide higher QoS for streaming data, priority levels can be set using tags at the beginning of data frames.

Device Name	MAC Address	TX(Mbps)	RX(Mbps)
TEST-07	00:13:C1:00:00:07	0	0
Alina	00:13:C1:07:7A:2C	CCo	CCo
Smith	00:13:C1:07:7A:2A	0	0
Gateway	00:13:C1:07:7A:14	68	101
Conf 9164	00:13:C1:00:00:47	0	0
Intellon Enable...	00:13:C1:07:7A:18	0	0
Michelle	00:13:C1:05:18:C1	0	0
Intellon Enable...	00:13:C1:00:00:36	0	0

Local device QoS setting. CAP3:Highest CAP2:Medium CAP1:Lowest

IGMP management packets: CAP3

Unicast packets: CAP2

IGMP managed multicast steam: CAP1

Other multicast or Broadcast packets: CAP3

Update

Viewing Network Statistics

The Statistics screen shows information on HomePlug packets that are transmitted and received by the devices in your network. To enable this function, click **Enable Statistics**.

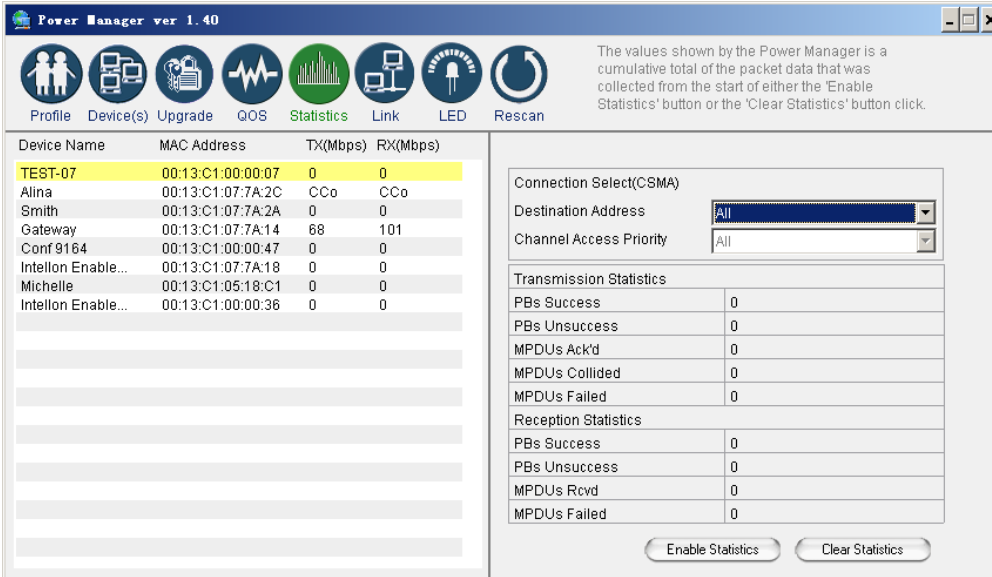

The screenshot shows the 'Power Manager ver 1.40' application window. The interface includes a navigation bar with icons for Profile, Device(s), Upgrade, QoS, Statistics (highlighted), Link, LED, and Rescan. A table displays network statistics for various devices, with 'TEST-07' selected. To the right, there are controls for 'Connection Select(CSMA)', 'Destination Address', and 'Channel Access Priority', along with 'Transmission Statistics' and 'Reception Statistics' sections. At the bottom right, there are 'Enable Statistics' and 'Clear Statistics' buttons.

Device Name	MAC Address	Tx(Mbps)	RX(Mbps)
TEST-07	00:13:C1:00:00:07	0	0
Alina	00:13:C1:07:7A:2C	Cc0	Cc0
Smith	00:13:C1:07:7A:2A	0	0
Gateway	00:13:C1:07:7A:14	68	101
Conf 9164	00:13:C1:00:00:47	0	0
Intellon Enable...	00:13:C1:07:7A:18	0	0
Michelle	00:13:C1:05:18:C1	0	0
Intellon Enable...	00:13:C1:00:00:36	0	0

Transmission Statistics

PBs Success	0
PBs Unsuccess	0
MPDUs Ack'd	0
MPDUs Collided	0
MPDUs Failed	0

Reception Statistics

PBs Success	0
PBs Unsuccess	0
MPDUs Rcvd	0
MPDUs Failed	0

Viewing Ethernet and HomePlug Connection

The Link screen has two sub-screens that provide information about your Ethernet and HomePlug connection.

Viewing Connection Speed

The Ethernet subscreen shows the Ethernet connection speed of the local and destination devices in your network. You can select the destination device in the Destination Address drop down menu. Click the Retrieve button to get the information.

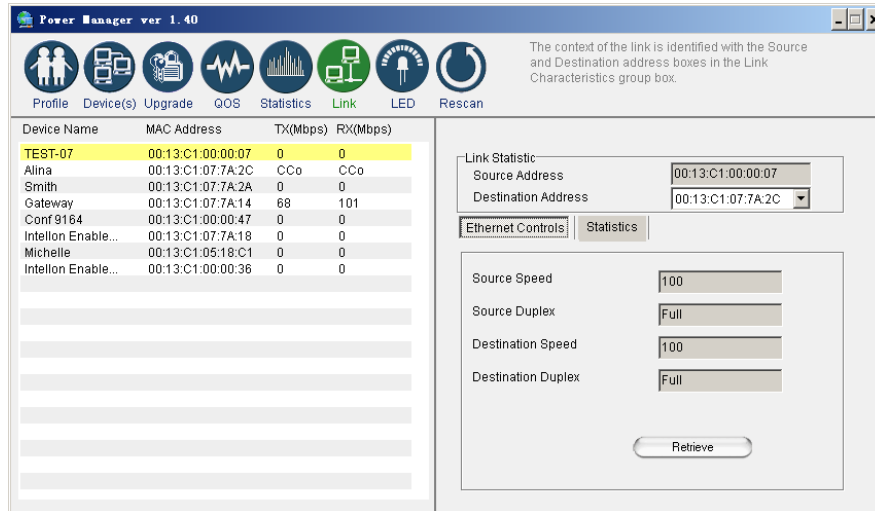

Statistics Subscreen

Use the Statistics subscreen to view statistical information about your connection between a source device and a specific destination device in your network. Click the Retrieve button to start accumulating the statistical information.

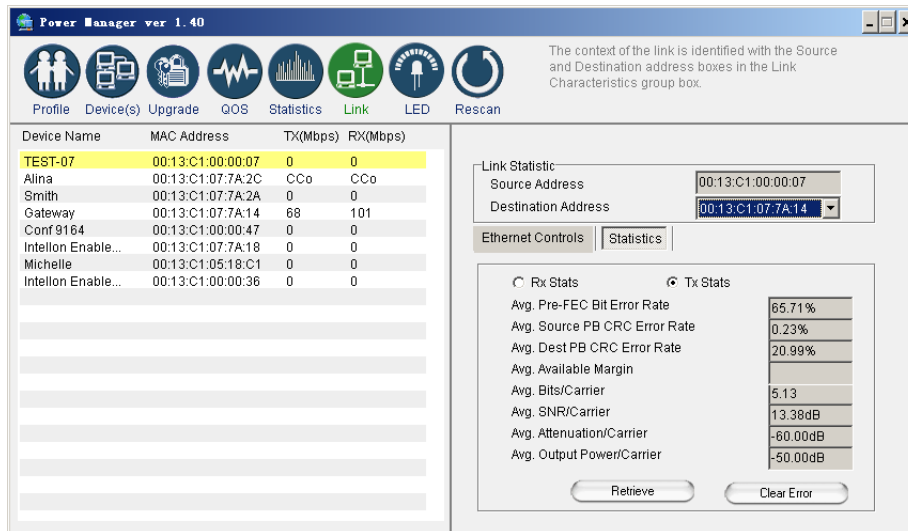

Scanning Devices



Use the Rescan button to rescan the devices on the HomePlug network. This refreshes the information on all devices using the same password.

4

Troubleshooting

Following are solutions to a few situations you might encounter. If you do not find a solution in this chapter, contact Asoka USA Technical Support by phone at (408) 550-8173 or through email at support@asokausa.com.

Symptom: I can't connect to anything and there are no lights activated on my PL9661-ETH.

Solution:

- 1 Unplug the device from the electrical outlet in question.
- 2 Locate another available outlet in your home.
- 3 Test the outlet by plugging in another electrical device such as a lamp or radio.
- 4 Plug the PL9661-ETH into the working electrical outlet.
- 5 Check to see if the lights work
- 6 If the above does not work, the device might be defective.
- 7 Please contact Technical Support for instructions on returning the device for repair or replacement.

Symptom: Some of my devices cannot connect to the Internet or other computers in my network. The lights seem to be functionally normally.

Solution #1:

- 1 Re-Initialize the PL9661-ETH device.
- 2 Unplug the PL9661-ETH from the electrical outlet.
- 3 Disconnect the Ethernet cable from the device
- 4 Plug the PL9661-ETH back into the electrical outlet.
- 5 Reconnect the Ethernet cable.

Solution #2:

The Network Encryption Key (NEK) may not be correct on your devices.

- 1 Reset the Network Encryption Key using the Factory Reset button located on the bottom of your PL9661 AV device. This will reset the NEK back to the default of HomePlug.
- 2 Test your connection again. If this still does not work, perform the factory reset on all of your other PL9661 AV devices in your network.

Solution #3:

It is possible some outlets in your home are not connected together.

- 1 Unplug the PL9661 AV from the current electrical outlet.
- 2 Locate another outlet in the home.
- 3 Plug the PL9661 AV into that outlet.
- 4 Attach a computer to the PL9661 AV.
- 5 Open the Power Manager Utility (located on the enclosed CD).
- 6 Under the Profile button, check if your PL9661 AV is displayed (it will be the first) and see if your other PL9661 AV devices can be seen. If you can see other devices under the Profile screen, your PL9661 AV device is functioning properly.

Solution #4:

Your broadband connection may have stopped working.

- 1 Power down your broadband router and/or DSL/cable modem (if applicable) for about 30 seconds and then power them back on.
- 2 If this step fails, please contact your ISP for assistance.



Specifications

This appendix lists the specifications for your PlugLink HD AV ECo Adapter.

Standards Compliance:	•HomePlug® AV • IEEE 802.3, IEEE 802.3x, IEEE 802.3u
Software Utility System Requirements:	Microsoft Windows® 98 SE, 2000, ME, XP, and Vista operating systems
Network Protocol:	TCP/IP, CSMA/CA, TDMA (supported in the future)
Network Interface:	One-port 10/100 Ethernet (RJ-45) switch
Bandwidth:	Up to 200 Mbps
Distance:	Up to 656 feet (200 meters)
Operating Frequency:	2 to 30MHz
Modulation Schemes:	• Orthogonal Frequency Division Multiplexing (OFDM) • QAM 1024/256/64/16 • QPSK • BPSK
EMI and Safety:	• FCC Part 15 Class B • UL (US and Canada) • CE
Additional Protocols:	• Forward Error Correction (FEC) • Automatic Channel Adaptation
Power Supply:	• US Version: 100-120VAC • UK/EU Version: 220-240VAC
Surge Energy Rating:	4KV
Power Rating:	• US Version: 100-120VAC 0.1A max, 60Hz • UK/EU Version: 220-240VAC 0.08A max, 50Hz
Security:	128-bit AES

Environmental Specifications:	<ul style="list-style-type: none"> • Operating temperature: 32°F to 131°F (0°C to 55°C) • Operating humidity: 10% to 85% Non-condensing • Storage temperature: -4°F to 158°F (-20°C to 70°C) • Storage humidity: 5% to 90% Non-condensing
Quality of Service:	<ul style="list-style-type: none"> •ToS • 802.1q • TDMA (supported in the future)
Warranty:	1-year limited



Components

Front Panel

Use the status lights on the front panel to verify connections.

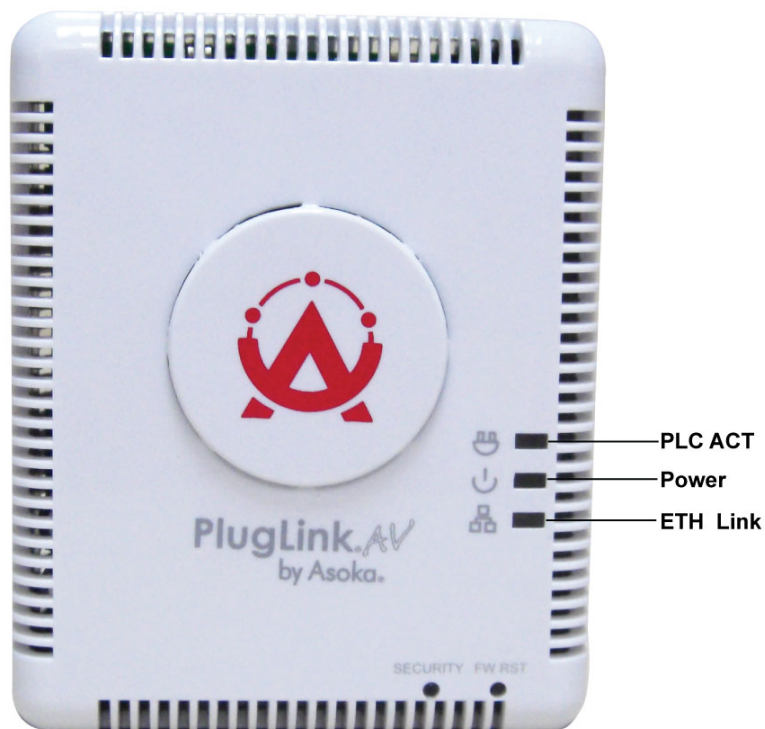

The following table describes the status light functions in the front panel:

Status Light	State	Indication
Power	Illuminated Off	Device is powered on Devices has no power
PLC Activity	Blinking Red Blinking Yellow Blinking Green Off	Traffic is running at < 7 Mbps Traffic is running at > 7 Mbps and < 40 Mbps Traffic is running at > 40 Mbps No activity on powerline (should blink intermittently)
Eth Link	Illuminated Blinking Off	Ethernet connectivity Ethernet traffic No ethernet connectivity

Bottom Panel

The bottom panel of the PL9661-ETH contains the following components:

- RJ-45 Ethernet port

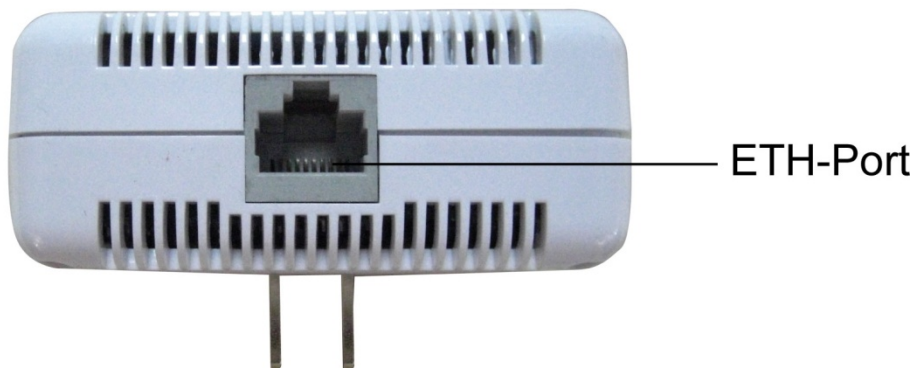

The label on the rear panel of the PlugLink HD AV Eco Adapter contains the information listed below.

- MAC address
- Model number
- Part number
- Serial number
- Unique device password

Note: Write this information down in your Warranty Support Information card for future reference.



Asoka USA Corporation
PlugLink HD AV Eco Adapter
MODEL:PL9661-ETH
FCC ID:T37PL9661ETH
Password:XXXX-XXXX-XXXX-XXXX
Mac Address:XXXXXXXXXXXX
S/N : XXXXXXXXXXXXX



Input :100-240VAC 0.1A 50/60Hz

This device complies with part 15 of the FCC Rules.Operation is subject to the following two conditions:
(1)This device may not cause harmful interference,and(2) this device must accept any interference received,including interference that may cause undesired operation.

MADE IN CHINA

C LISTED
E237853
35PX
I.T.E.

XX-XXX-XXX

Buttons

The Pluglink AV 9661 device has two hardware push buttons:

- **FW RST button** - Resets the PlugLinkHD AV ECo Adapter back to factory default settings. Press and hold the button with a pin or other sharp object for about 2 seconds until you see the lights on the device flash briefly.
- **NID button** - Allows you to set a randomized Network Encryption Key (NEK) by pressing on it. You can then have additional units use the same randomized NEK by using their respective NID buttons.

- 1 Select a PlugLink AV 9661 (#1) device in your network. Press and hold the **NID** button for 4 seconds. After about 4 seconds, the lights on your device will blink off briefly and come back on immediately. This will change the existing Network Encryption Key (NEK) to a randomized NEK.
- 2 On the PlugLinkAV 9661 (#1) device from Step #1, press and hold the **NID** button for about 1 seconds. The power light on the device will begin flashing. This unit has now been set to allow other units to join the network and be assigned the same password. This unit will remain in “adder” mode for about 2 minutes.
- 3 Before the three minutes have elapsed from Step #2, select another PlugLink AV 9661 (#2) device from your network. Press and hold the **NID** button for about 1 seconds. The power light on the device will blink as well. The #1 and #2 devices will communicating and the #2 device will have it's NEK set to the NEK of the #1 device. This should happen in about 15 to 20 seconds. Once the process has been completed, you can then test if the two devices are communicating.
- 4 If you add units at a later time, you only need to perform Step #2 (using any device in the network) and Step #3 (any new devices). Step #1 is not necessary unless you wish to change your NEK.



The use of the NID button is optional. You may also use the application software described in the manual to set NEK's as well.



Warranty

Asoka warrants that (a) the hardware components of the product will be free from defects in materials and workmanship under normal use for one (1) year from the date of purchase when used within the limits set forth in the Specifications section of the User Guide, and (b) the software components will perform substantially in accordance with Asoka's published specifications for ninety (90) days from the date of purchase, but does not warrant that the software will be error-free or free of all defects.

Should a product fail to perform as described in the User Guide within the warranted period, it will be repaired or replaced with the same or functionally equivalent product by Asoka, at its discretion, free of charge provided that you: (a) return the failed product to an Asoka designated repair facility with shipping charge prepaid, and (b) provide Asoka with proof of the original date of purchase. Repaired or replacement products will be returned to you with shipping charges prepaid. Asoka warrants any replaced or repaired product or component for the remainder of the initial warranty period whichever is longer. Replacement products may be refurbished or contain refurbished materials or components. If Asoka, by its sole determination, is unable to restore the product to proper operating condition, it will refund the depreciated purchase price of the product.

This warranty extends only to you, the original purchaser and is not transferable to any subsequent purchasers.

This warranty does not apply if, in the judgment of Asoka, the product fails due to damage from shipment, handling, storage, accident, abuse, misapplication or misuse, or if it has been used or maintained in a manner not conforming to product manual instructions, has been modified in any way, or has had any serial number removed or defaced. Repair by anyone other than Asoka or an approved agent will void this warranty. The maximum liability of Asoka under this warranty is limited to the purchase price of the

product covered by the warranty. Prior to returning any defective product, the purchaser or the authorized merchant from whom the purchaser originally bought the product must obtain a Return Material Authorization (RMA) number from Asoka. All defective products should be returned to Asoka with shipping charges prepaid. Asoka will not accept collect shipments.

WHILE ASOKA HAS MADE EVERY EFFORT TO PROVIDE CLEAR AND ACCURATE TECHNICAL INFORMATION ABOUT ITS PRODUCTS, ASOKA ASSUMES NO LIABILITY FOR ANY EVENTS ARISING OUT OF THE USE OF THE TECHNICAL INFORMATION OR THE PRODUCT, EXCEPT AS SPECIFICALLY PROVIDED IN THIS AGREEMENT OR AS REQUIRED BY LAW. THE WARRANTIES AND REMEDIES STATED ABOVE ARE EXCLUSIVE AND IN LIEU OF ALL OTHERS, ORAL OR WRITTEN, EXPRESS OR IMPLIED. ANY AND ALL OTHER WARRANTIES, INCLUDING IMPLIED WARRANTIES OF MERCHANTABILITY, FITNESS FOR A PARTICULAR PURPOSE AND NON-INFRINGEMENT OF THIRD PARTY RIGHTS ARE EXPRESSLY EXCLUDED. ASOKA SHALL NOT BE LIABLE, UNDER ANY CIRCUMSTANCES, TO ANY PERSON OR ENTITY FOR ANY SPECIAL, INCIDENTAL, INDIRECT OR CONSEQUENTIAL DAMAGES, INCLUDING WITHOUT LIMITATION, DAMAGES RESULTING FROM THE USE OR MALFUNCTION OF THE PRODUCTS, LOSS OF PROFITS OR REVENUES, BUSINESS INTERRUPTION, OR COSTS OF REPLACEMENT GOODS, EVEN IF ASOKA IS INFORMED IN ADVANCE OF THE POSSIBILITY OF SUCH DAMAGES.



FCC Notice

FCC Statement

This equipment has been tested and found to comply with the limits for a Class B digital device, pursuant to part 15 of FCC Rules. These limits are designed to provide reasonable protection against harmful interference in a residential installation. This equipment generates and can radiate radio frequency energy and, if not installed and used in accordance with the instructions, may cause harmful interference to radio communications. However, there is no guarantee that interference will not occur in a particular installation. If this equipment does cause harmful interference to radio or television reception, which can be determined by turning the equipment off and on, the user is encouraged to try to correct the interference by one or more of the following measures:

- Reorient or relocate the receiving antenna.
- Increase the separation between the equipment and receiver.
- Connect the equipment into an outlet on a circuit different from that to which the receiver is connected.
- Consult the dealer or an experienced radio/TV technician for help

This device complies with Part 15 of FCC Rules.

Operation is subject to the following two conditions:

- 1 This device may not cause harmful interference, and
- 2 This device must accept any interference received, including interference that may cause undesired operation.

Note: The manufacturer is not responsible for any radio or TV interference caused by unauthorized modifications to this equipment. Such modifications could void the user's authority to operate the equipment.

FCC RF Radiation Exposure Statement

This equipment complies with FCC RF radiation exposure limits set forth for an uncontrolled environment. This equipment should be installed and operated with a minimum distance of 20 centimeters between the radiator and your body.

Note: The manufacturer is not responsible for any radio or TV interference caused by unauthorized modifications to this equipment. Such modifications could void the user's authority to operate the equipment.

Asoka USA Corporation

2344 Walsh Avenue Suite A
Santa Clara, California 95051
USA Phone: (408) 550-8167
Fax: (408) 884-2390
www.asokausa.com

66-0360-00Rev.001