



松 明
CNASL1225

partner

FCC PART 15 SUBPART C TEST REPORT

FCC PART 15.247

Report Reference No.....: WE08040003

Compiled by

(position+printed name+signature)...: File administrators Tracy Qi

Supervised by

(position+printed name+signature)...: Test Engineer Tracy Qi

Approved by

(position+printed name+signature)...: Manager Jimmy Li

Date of issue.....: May 26, 2008

Testing Laboratory Name: Shenzhen Huatongwei International Inspection Co., Ltd

Address.....: Keji Nan No.12 Road, Hi-tech Park, Shenzhen, China

Applicant's name: ASOKA USA Corporation

Address.....: 558 Pilgrim Drive, Unit H Foster City, CA 94404

Test specification:

Standard: **FCC Part 15.247: Operation within the bands 920-928 MHz, 2400-2483.5 MHz and 5725-5850 MHz Direct Sequence System**

TRF Originator.....: Shenzhen Huatongwei International Inspection CO., Ltd

Master TRF.....: Dated 2006-06

Shenzhen Huatongwei International Inspection Co., Ltd. All rights reserved.

This publication may be reproduced in whole or in part for non-commercial purposes as long as the Shenzhen Huatongwei International Inspection Co., Ltd is acknowledged as copyright owner and source of the material. Shenzhen Huatongwei International Inspection Co., Ltd takes no responsibility for and will not assume liability for damages resulting from the reader's interpretation of the reproduced material due to its placement and context.

Test item description : PlugLink AV 9560 Wireless Adapter

Trade Mark: /

Model/Type reference.....: PL9560-WAP

Listed Models: /

Result.....: **Positive**

T E S T R E P O R T

Test Report No. :	WE08040003	May 26, 2008
		Date of issue

Equipment under Test : PlugLink AV 9560 Wireless Adapter

Model /Type : PL9560-WAP

Listed Models : /

Applicant : ASOKA USA Corporation

Address : 558 Pilgrim Drive, Unit H Foster City, CA 94404

Test Result according to the standards on page 4:	Positive
--	-----------------

The test report merely corresponds to the test sample.
It is not permitted to copy extracts of these test result without the written permission of the test laboratory.

Contents

<u>1.</u>	<u>TEST STANDARDS</u>	<u>4</u>
<u>2.</u>	<u>SUMMARY</u>	<u>5</u>
2.1.	General Remarks	5
2.2.	Equipment Under Test	5
2.3.	Short description of the Equipment under Test (EUT)	5
2.4.	EUT operation mode	5
2.5.	EUT configuration	5
2.6.	Related Submittal(s) / Grant (s)	6
2.7.	Modifications	6
<u>3.</u>	<u>TEST ENVIRONMENT</u>	<u>7</u>
3.1.	Address of the test laboratory	7
3.2.	Test Facility	7
3.3.	Environmental conditions	8
3.4.	Configuration of Tested System	8
3.5.	Test Description	9
3.6.	Statement of the measurement uncertainty	10
3.7.	Equipments Used during the Test	10
<u>4.</u>	<u>TEST CONDITIONS AND RESULTS</u>	<u>11</u>
4.1.	Conducted Emissions Test	11
4.2.	Radiated Emission Test	13
4.3.	Maximum Peak Output Power	22
4.4.	Power Spectral Density Measurement	24
4.5.	Band Edge Measurement	28
4.6.	6dB Bandwidth Measurement	31
4.7.	Antenna Requirement	35
	APPENDIX 1--PHOTOGRAPHS OF SET UP	36
	APPENDIX 2--PHOTOGRAPHS OF EUT	37

1. TEST STANDARDS

The tests were performed according to following standards:

[FCC Rules Part 15.247](#): Frequency Hopping, Direct Spread Spectrum and Hybrid Systems that are in operation within the bands of 902-928 MHz, 2400-2483.5 MHz, and 5725-5850 MHz.

2.6. Related Submittal(s) / Grant (s)

This submittal(s) (test report) is intended for FCC ID: T37PL9560-WAP filing to comply with Section 15.247 of the FCC Part 15, Subpart C Rules.

2.7. Modifications

No modifications were implemented to meet testing criteria.

3. TEST ENVIRONMENT

3.1. Address of the test laboratory

Shenzhen Huatongwei International Inspection Co., Ltd
Keji Nan No.12 Road, Hi-tech Park, Shenzhen, China
Phone: 86-755-26715686 Fax: 86-755-26748089

The sites are constructed in conformance with the requirements of ANSI C63.7, ANSI C63.4 (2003) and CISPR Publication 22.

3.2. Test Facility

The test facility is recognized, certified, or accredited by the following organizations:

CNAS-Lab Code: L1225

Shenzhen Huatongwei International Inspection Co., Ltd has been assessed and proved to be in compliance with CNAS-CL01 Accreditation Criteria for Testing and Calibration Laboratories (identical to ISO/IEC 17025: 2005 General Requirements) for the Competence of Testing and Calibration Laboratories, Date of Registration: August 02, 2007. Valid time is until March 04, 2009.

A2LA-Lab Cert. No. 2243.01

Shenzhen Huatongwei International Inspection Co., Ltd, EMC Laboratory has been accredited by A2LA for technical competence in the field of electrical testing, and proved to be in compliance with ISO/IEC 17025: 2005 General Requirements for the Competence of Testing and Calibration Laboratories and any additional program requirements in the identified field of testing. Valid time is from Aug 24, 2005 to Sept 30, 2009.

FCC-Registration No.: 662850

Shenzhen Huatongwei International Inspection Co., Ltd, EMC Laboratory has been registered and fully described in a report filed with the FCC (Federal Communications Commission). The acceptance letter from the FCC is maintained in our files. Registration 662850, Renewal date September 12, 2006.

IC-Registration No.: 5377

The 3m Alternate Test Site of Shenzhen Huatongwei International Inspection Co., Ltd has been registered by Certification and Engineering Bureau of Industry Canada for the performance of radiated measurements with Registration No. 5377 on November 28th, 2005.

ACA

Shenzhen Huatongwei International Inspection Co., Ltd, EMC Laboratory can also perform testing for the Australian C-Tick mark as a result of our A2LA accreditation.

NEMKO-Aut. No.: ELA125

Shenzhen Huatongwei International Inspection Co., Ltd has been assessed the quality assurance system, the testing facilities, qualifications and testing practices of the relevant parts of the organization. The quality assurance system of the Laboratory has been validated against ISO/IEC 17025:2005 or equivalent. The laboratory also fulfils the conditions described in Nemko Document NLA-10, the Authorization is valid through April 25, 2009.

VCCI

The 3m Semi-anechoic chamber (12.2m×7.95m×6.7m) and Shielded Room (8m×4m×3m) of Shenzhen Huatongwei International Inspection Co., Ltd has been registered in accordance with the Regulations for Voluntary Control Measures with Registration No.: R-2484. Date of Registration: December 20, 2006. Valid time is until December 19, 2009.

Main Ports Conducted Interference Measurement of Shenzhen Huatongwei International Inspection Co., Ltd has been registered in accordance with the Regulations for Voluntary Control Measures with Registration No.: C-2726. Date of Registration: December 20, 2006. Valid time is until December 19, 2009.

IECEE CB

Shenzhen Huatongwei International Inspection Co Ltd has been assessed and determined to fully comply with the requirements of ISO/IEC 17025: 2005-05, The Basic Rules, IECEE 01: 2006-10 and Rules of Procedure IECEE 02: 2006-10, and the relevant IECEE CB-Scheme Operational Documents. It is therefore entitled to operate as a CB Testing Laboratory under the responsibility of Nemko A/S. This certificate remains valid until May 25th 2009 at which time it will be reissued by the IECEE Executive Secretary upon successful completion of the normally scheduled 3-year Reassessment Program administered by the IECEE CB Scheme.

DNV

Shenzhen Huatongwei International Inspection Co Ltd has been found to comply with the requirements of DNV towards subcontractor of EMC and safety testing services in conjunction with the EMC and Low voltage Directives and in the voluntary field. The acceptance is based on a formal quality Audit and follow-ups according to relevant parts of ISO/IEC Guide 17025(2005), in accordance with the requirements of the DNV Laboratory Quality Manual towards subcontractors. Valid time is until 09 July, 2010.

3.3. Environmental conditions

During the measurement the environmental conditions were within the listed ranges:

Temperature:	<u>15-35 ° C</u>
Humidity:	<u>30-60 %</u>
Atmospheric pressure:	<u>950-1050mbar</u>

3.4. Configuration of Tested System

Fig. 2-1 Configuration of Tested System

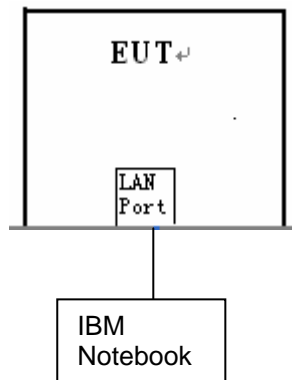

Table 2-1 Equipment Used in Tested System

No.	Product	Manufacturer	Model No.	Serial No.	FCC ID
1	Notebook PC	IBM	X32	L3-MF472	DoC

3.5. Test Description

FCC PART 15		
FCC Part 15.207	AC Power Conducted Emission	PASS
FCC Part 15.247(a)(2)	Spectrum Bandwidth of a Orthogonal Frequency Division Multiplex System	PASS
FCC Part 15.247(b)	Maximum Peak Output Power	PASS
FCC Part 15.247(e)	Power Spectral Density	PASS
FCC Part 15.109/ 15.205/ 15.209	Radiated Emissions	PASS
FCC Part 15.247(d)	Out of Band Emission and Restricted Band Radiation	PASS

Remark: The measurement uncertainty is not included in the test result.

Preliminary tests were performed in different data rate to find the worst radiated emission. The data rate shown in the table below is the worst-case rate with respect to the specific test item. Investigation has been done on all the possible configurations for searching the worst cases. The following table is a list of the test modes shown in this test report.

Test Items	Mode	Data Rate	Channel
AC Power Line Conducted Emissions	Normal Link	11 Mbps	6
Maximum Peak Conducted Output Power Power Spectral Density 6dB Spectrum Bandwidth	11b/BPSK	1 Mbps	1/6/11
	11g/BPSK	6 Mbps	1/6/11
Radiated Emissions 9kHz~1GHz	11g/BPSK	6 Mbps	6
Radiated Emissions 1GHz~10th Harmonic	11b/BPSK	1 Mbps	1/6/11
	11g/BPSK	6 Mbps	1/6/11
Band Edge Emissions	11b/BPSK	1 Mbps	1/11
	11g/BPSK	6 Mbps	1/11

3.6. Statement of the measurement uncertainty

The data and results referenced in this document are true and accurate. The reader is cautioned that there may be errors within the calibration limits of the equipment and facilities. The measurement uncertainty was calculated for all measurements listed in this test report acc. to CISPR 16 - 4 „Specification for radio disturbance and immunity measuring apparatus and methods – Part 4: Uncertainty in EMC Measurements“ and is documented in the Shenzhen Huatongwei International Inspection Co., Ltd quality system acc. to DIN EN ISO/IEC 17025. Furthermore, component and process variability of devices similar to that tested may result in additional deviation. The manufacturer has the sole responsibility of continued compliance of the device.

Hereafter the best measurement capability for Shenzhen Huatongwei laboratory is reported:

Test	Range	Measurement Uncertainty	Notes
Radiated Emission	30~1000MHz	4.22dB	(1)
Radiated Emission	1~12.75GHz	4.35dB	(1)
Conducted Disturbance	0.15~30MHz	3.29dB	(1)

(1) This uncertainty represents an expanded uncertainty expressed at approximately the 95% confidence level using a coverage factor of k=2.

3.7. Equipments Used during the Test

AC Power Conducted Emission					
Item	Test Equipment	Manufacturer	Model No.	Serial No.	Last Cal.
1	EMI TEST RECEIVER	ROHDE & SCHWARZ	ESCS30	100038	2007/10
2	ARTIFICIAL MAINS	ROHDE & SCHWARZ	ESH2-Z5	100028	2007/10
3	PULSE LIMITER	ROHDE & SCHWARZ	ESHSZ2	100044	2007/10
4	EMI TEST SOFTWARE	ROHDE & SCHWARZ	ES-K1 1.71	N/A	2007/10

Radiated Emissions					
Item	Test Equipment	Manufacturer	Model No.	Serial No.	Last Cal.
1	ULTRA-BROADBAND ANTENNA	ROHDE & SCHWARZ	HL562	100015	2007/06
2	EMI TEST RECEIVER	ROHDE & SCHWARZ	ESI 26	100009	2007/10
3	RF TEST PANEL	ROHDE & SCHWARZ	TS / RSP	335015/ 0017	2007/10
4	TURNTABLE	ETS	2088	2149	2007/10
5	ANTENNA MAST	ETS	2075	2346	2007/10
6	EMI TEST SOFTWARE	ROHDE & SCHWARZ	ESK1	N/A	2007/10

Maximum Peak Output Power / Power Spectral Density / 6dB Bandwidth / Band Edge Measurement					
Item	Test Equipment	Manufacturer	Model No.	Serial No.	Last Cal.
1	EMI TEST RECEIVER	ROHDE & SCHWARZ	ESI 26	100009	2007/10

4. TEST CONDITIONS AND RESULTS

4.1. Conducted Emissions Test

TEST CONFIGURATION

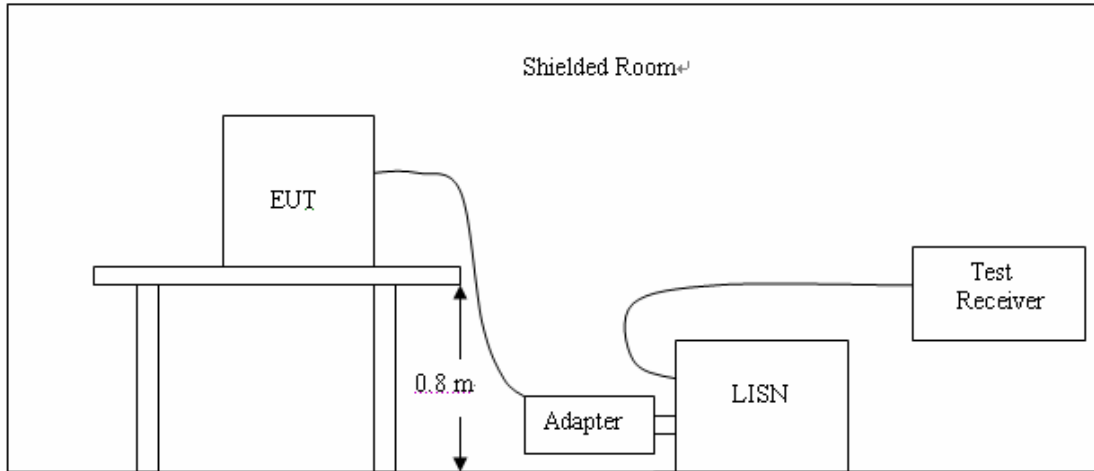

TEST PROCEDURE

- 1 The equipment was set up as per the test configuration to simulate typical actual usage per the user's manual. The EUT is a tabletop system, a wooden table with a height of 0.8 meters is used and is placed on the ground plane as per ANSI C63.4.
- 2 Support equipment, if needed, was placed as per ANSI C63.4.
- 3 All I/O cables were positioned to simulate typical actual usage as per ANSI C63.4.
- 4 The EUT received DC8V power from the adapter, the adapter received AC120V/60Hz power through a Line Impedance Stabilization Network (LISN) which supplied power source and was grounded to the ground plane.
- 5 All support equipments received AC power from a second LISN, if any.
- 6 The EUT test program was started. Emissions were measured on each current carrying line of the EUT using a spectrum Analyzer / Receiver connected to the LISN powering the EUT. The LISN has two monitoring points: Line 1 (Hot Side) and Line 2 (Neutral Side). Two scans were taken: one with Line 1 connected to Analyzer / Receiver and Line 2 connected to a 50 ohm load; the second scan had Line 1 connected to a 50 ohm load and Line 2 connected to the Analyzer / Receiver.
- 7 Analyzer / Receiver scanned from 150 KHz to 30MHz for emissions in each of the test modes.
- 8 During the above scans, the emissions were maximized by cable manipulation.

Conducted Power Line Emission Limit

For unintentional device, according to § 15.107(a) Line Conducted Emission Limits is as following :

Frequency (MHz)	Maximum RF Line Voltage (dBµV)			
	CLASS A		CLASS B	
	Q.P.	Ave.	Q.P.	Ave.
0.15 - 0.50	79	66	66-56*	56-46*
0.50 - 5.00	73	60	56	46
5.00 - 30.0	73	60	60	50

* Decreasing linearly with the logarithm of the frequency

For intentional device, according to §15.207(a) Line Conducted Emission Limit is same as above table.

TEST RESULTS

FREQ MHz	PEAK RAW dBuV	Q.P. RAW dBuV	AVG RAW dBuV	Q.P. Limit dBuV	AVG Limit dBuV	Q.P. Margin dB	AVG Margin dB	NOTE
0.174	44.90	---	---	65.00	55.00	---	-10.10	L1
0.202	44.40	---	---	64.00	54.00	---	-9.60	L1
0.230	41.30	---	---	62.00	52.00	---	-10.70	L1
0.258	40.10	---	---	62.00	52.00	---	-11.90	L1
0.490	38.40	---	---	56.00	46.00	---	-7.60	L1
0.170	44.60	---	---	65.00	55.00	---	-10.40	N
0.174	45.10	---	---	65.00	55.00	---	-9.90	N
0.202	43.10	---	---	64.00	54.00	---	-10.90	N
0.230	40.80	---	---	62.00	52.00	---	-11.20	N
0.258	40.10	---	---	62.00	52.00	---	-11.90	N

REMARKS :

1. Margin value = Emission level – Limit value
2. The EUT was set to be normal operation condition. Each Ethernet port was connected and data pay lead was transmitted at highest data rate. The RF chip can be operated in 802.11g and 802.11b mode. The rf chip will detect the environment and select the proper mode automatically. The WLAN function was set to normal operation condition.

4.2. Radiated Emission Test

TEST CONFIGURATION

(A) Radiated Emission Test Set-Up, Frequency Below 30MHz

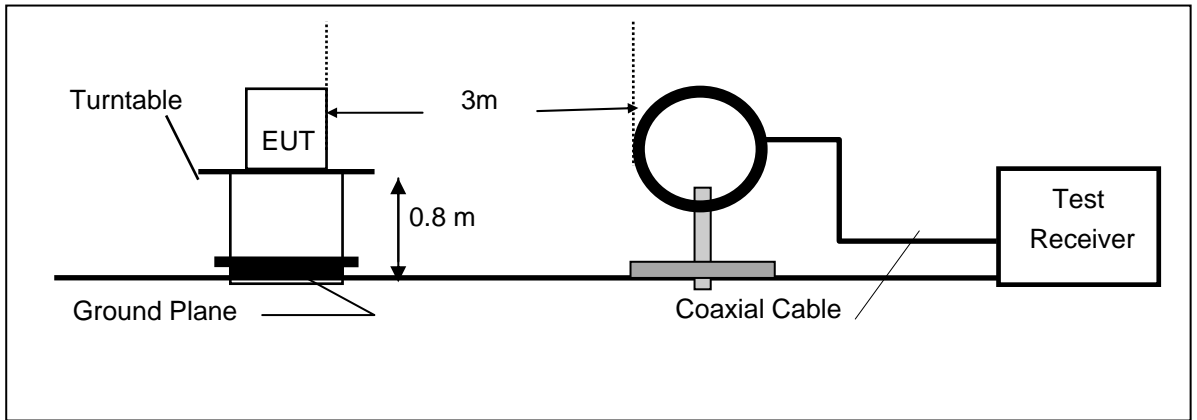

(B) Radiated Emission Test Set-Up, Frequency below 1000MHz

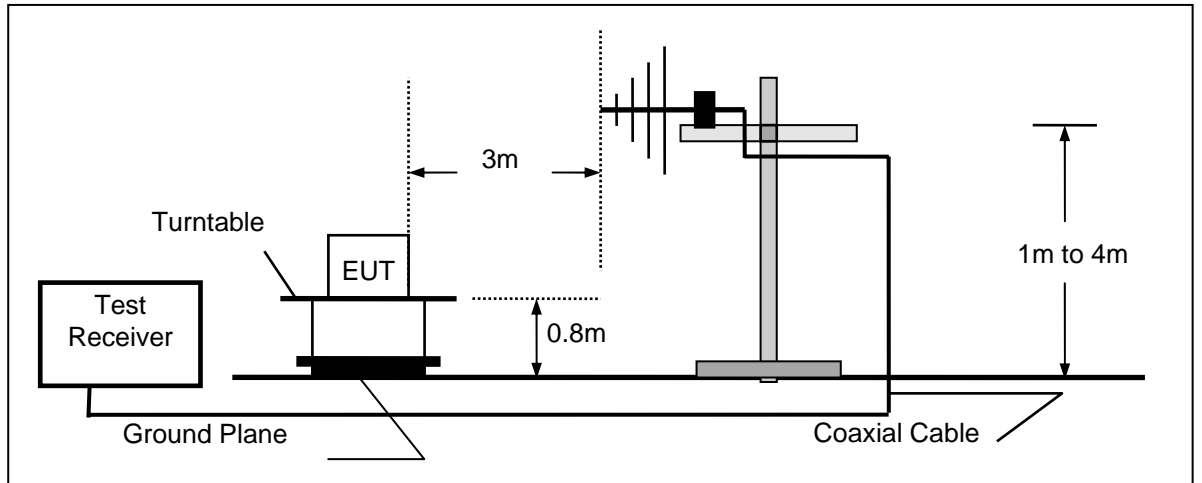

(C) Radiated Emission Test Set-Up, Frequency above 1000MHz

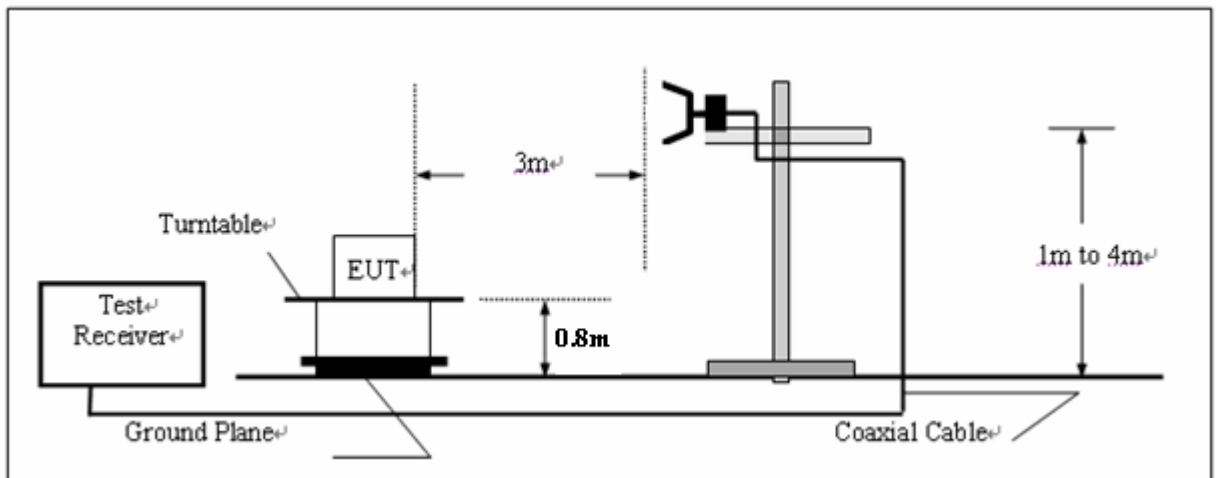

TEST PROCEDURE

- 1 The EUT was placed on a turn table which is 0.8m above ground plane.
- 2 Maximum procedure was performed by raising the receiving antenna from 1m to 4m and rotating the turn table from 0° to 360° to acquire the highest emissions from EUT
3. And also, each emission was to be maximized by changing the polarization of receiving antenna both horizontal and vertical.
4. Repeat above procedures until all frequency measurements have been completed.

Field Strength Calculation

The field strength is calculated by adding the Antenna Factor and Cable Factor and subtracting the Amplifier Gain and Duty Cycle Correction Factor(if any) from the measured reading. The basic equation with a sample calculation is as follows:

$$FS = RA + AF + CL - AG$$

Where FS = Field Strength	CL = Cable Attenuation Factor (Cable Loss)
RA = Reading Amplitude	AG = Amplifier Gain
AF = Antenna Factor	

RADIATION LIMIT

For unintentional device, according to § 15.109(a), except for Class A digital devices, the field strength of radiated emissions from unintentional radiators at a distance of 3 meters shall not exceed the following values:

Frequency (MHz)	Distance (Meters)	Radiated (dBµV/m)	Radiated (µV/m)
30-88	3	40.0	100
88-216	3	43.5	150
216-960	3	46.0	200
Above 960	3	54.0	500

For intentional device, according to § 15.209(a), the general requirement of field strength of radiated emissions from intentional radiators at a distance of 3 meters shall not exceed the above table. According to § 15.247(d), in any 100kHz bandwidth outside the frequency band in which the EUT is operating, the radio frequency power that is produced by the intentional radiator shall be at least 20dB below that in the 100kHz bandwidth within the band that contains the highest level of desired power.

TEST RESULTS

Frequency (MHz)	Ant/CL/ Amp.CF (dB)	Meter Reading at 3m(dB μ V)		Limits (dB μ V/m)	Emission Level at 3m(dB μ V/m)	
		Horizontal	Vertical		Horizontal	Vertical
30.00	20.70	*	*	40.00	*	*
191.30	11.00	26.10	26.20	46.00	37.10	37.20
224.40	11.40	25.40	20.90	46.00	36.80	32.30
376.00	18.80	18.20	11.90	46.00	37.00	30.70
449.90	20.10	18.40	15.20	46.00	38.50	35.30
825.10	24.10	12.20	10.30	46.00	36.30	34.40
900.90	25.40	13.10	13.00	46.00	38.50	38.40
1000.00	24.30	*	*	54.00	*	*

REMARKS :

1. *Undetectable

2. The IF bandwidth of EMI Test Receiver was 120KHz for measuring from 30 MHz to 1 GHz and 1 MHz for measuring above 1 GHz

The frequency spectrum above 1 GHz for Transmitter was investigated. All emissions not reported are much lower than the prescribed limits. Readings are both peak and average values.

Company	ASOKA USA Corporation	Test Date	05/20/2008
Test Mode	Channel 1	Detector Function	Peak(PK)/Average(AV)
Product Name	PlugLink AV 9560 Wireless Adapter	Test By	Tracy Qi
Model Name	PL9560-WAP	TEMP&Humidity	25 °C, 53%

ANTENNA POLARITY & TEST DISTANCE: HORIZONTAL AT 3 M								
No.	Freq. (MHz)	Emission Level (dBuV/m)	Limit (dBuV/m)	Margin (dB)	Antenna Height (m)	Table Angle (Degree)	Raw Value (dBuV)	Correction Factor (dB/m)
1	2386.60	47.30 PK	74.00	-26.70	1.87 H	124	14.50	32.80
1	2386.60	40.50 AV	54.00	-13.50	1.87 H	124	7.70	32.80
2	2390.00	42.70 PK	74.00	-31.30	1.87 H	124	8.90	33.80
2	2390.00	36.10 AV	54.00	-17.90	1.87 H	124	2.30	33.80
3	*2412.00	104.10 PK			1.87 H	124	74.20	29.90
3	*2412.00	100.00 AV			1.87 H	124	70.10	29.90
4	4824.00	45.50 PK	74.00	-28.50	1.49 H	331	9.30	36.20
4	4824.00	39.90 AV	54.00	-14.10	1.49 H	331	3.70	36.20
5	7236.00	49.70 PK	74.00	-24.30	1.03 H	146	8.00	41.70
5	7236.00	38.50 AV	54.00	-15.50	1.03 H	146	-3.20	41.70
6	9648.00	55.20 PK	74.00	-18.80	1.53 H	307	10.30	44.90
6	9648.00	49.20 AV	54.00	-4.80	1.53 H	307	4.30	44.90

ANTENNA POLARITY & TEST DISTANCE: VERTICAL AT 3 M								
No.	Freq. (MHz)	Emission Level (dBuV/m)	Limit (dBuV/m)	Margin (dB)	Antenna Height (m)	Table Angle (Degree)	Raw Value (dBuV)	Correction Factor (dB/m)
1	2386.60	55.60 PK	74.00	-18.40	1.19 V	90	22.80	32.80
1	2386.60	49.50 AV	54.00	-4.50	1.19 V	90	16.70	32.80
2	2390.00	53.20 PK	74.00	-20.80	1.19 V	90	19.40	33.80
2	2390.00	47.10 AV	54.00	-6.90	1.19 V	90	13.30	33.80
3	*2412.00	114.40 PK			1.19 V	90	84.50	29.90
3	*2412.00	107.00 AV			1.19 V	90	77.10	29.90
4	4824.00	47.00 PK	74.00	-27.00	1.10 V	224	10.80	36.20
4	4824.00	40.30 AV	54.00	-13.70	1.10 V	224	4.10	36.20
5	7236.00	50.20 PK	74.00	-23.80	1.65 V	124	8.50	41.70
5	7236.00	38.90 AV	54.00	-15.10	1.65 V	124	-2.80	41.70
6	9648.00	58.00 PK	92.40	-34.40	1.87 V	308	13.10	44.90
6	9648.00	54.70 AV	87.00	-32.30	1.87 V	308	9.80	44.90

- REMARKS:**
1. Emission level (dBuV/m) = Raw Value (dBuV) + Correction Factor (dB/m)
 2. Correction Factor (dB/m) = Antenna Factor (dB/m) + Cable Factor (dB)
 3. The other emission levels were very low against the limit.
 4. Margin value = Emission level – Limit value.
 5. The limit value is defined as per 15.247
 6. “* “: Fundamental frequency
 7. For Wireless 802.11b mode at 1Mbps.

Company	ASOKA USA Corporation	Test Date	05/20/2008
Test Mode	Channel 6	Detector Function	Peak(PK)/Average(AV)
Product Name	PlugLink AV 9560 Wireless Adapter	Test By	Tracy Qi
Model Name	PL9560-WAP	TEMP&Humidity	25 ° C, 53%

ANTENNA POLARITY & TEST DISTANCE: HORIZONTAL AT 3 M								
No.	Freq. (MHz)	Emission Level (dBuV/m)	Limit (dBuV/m)	Margin (dB)	Antenna Height (m)	Table Angle (Degree)	Raw Value (dBuV)	Correction Factor (dB/m)
1	*2437.00	104.00 PK			1.90 H	249	74.00	30.00
1	*2437.00	99.00 AV			1.90 H	249	69.00	30.00
2	4874.00	49.50 PK	74.00	-24.50	1.58 H	317	13.00	36.50
2	4874.00	42.40 AV	54.00	-11.60	1.58 H	317	5.90	36.50
3	7311.00	49.50 PK	74.00	-24.50	1.36 H	26	7.70	41.80
3	7311.00	38.70 AV	54.00	-15.30	1.36 H	26	-3.10	41.80
4	9748.00	54.40 PK	74.00	-19.60	1.66 H	308	9.80	44.60
4	9748.00	47.70 AV	54.00	-6.30	1.66 H	308	3.10	44.60

ANTENNA POLARITY & TEST DISTANCE: VERTICAL AT 3 M								
No.	Freq. (MHz)	Emission Level (dBuV/m)	Limit (dBuV/m)	Margin (dB)	Antenna Height (m)	Table Angle (Degree)	Raw Value (dBuV)	Correction Factor (dB/m)
1	*2437.00	113.70 PK			1.32 V	121	83.70	30.00
1	*2437.00	107.60 AV			1.32 V	121	77.60	30.00
2	4874.00	56.40 PK	74.00	-17.60	1.33 V	307	19.90	36.50
2	4874.00	48.10 AV	54.00	-5.90	1.33 V	307	11.60	36.50
3	7311.00	50.30 PK	74.00	-23.70	1.33 V	178	8.50	41.80
3	7311.00	39.70 AV	54.00	-14.30	1.33 V	178	-2.10	41.80
4	9748.00	55.20 PK	74.00	-18.80	1.18 V	301	10.60	44.60
4	9748.00	49.80 AV	54.00	-4.20	1.18 V	301	5.20	44.60

- REMARKS:**
1. Emission level (dBuV/m)=Raw Value(dBuV) + Correction Factor(dB/m)
 2. Correction Factor (dB/m) = Antenna Factor (dB/m) + Cable Factor (dB)
 3. The other emission levels were very low against the limit.
 4. Margin value = Emission level – Limit value.
 5. The limit value is defined as per 15.247
 6. “* “: Fundamental frequency
 7. For Wireless 802.11b mode at 1Mbps.

Company	ASOKA USA Corporation	Test Date	05/20/2008
Test Mode	Channel 11	Detector Function	Peak(PK)/Average(AV)
Product Name	PlugLink AV 9560 Wireless Adapter	Test By	Tracy Qi
Model Name	PL9560-WAP	TEMP&Humidity	25 ° C, 53%

ANTENNA POLARITY & TEST DISTANCE: HORIZONTAL AT 3 M

No.	Freq. (MHz)	Emission Level (dBuV/m)	Limit (dBuV/m)	Margin (dB)	Antenna Height (m)	Table Angle (Degree)	Raw Value (dBuV)	Correction Factor (dB/m)
1	*2462.00	103.90 PK			1.79 H	249	73.80	30.10
1	*2462.00	97.60 AV			1.79 H	249	67.50	30.10
2	2483.50	47.80 PK	74.00	-26.20	1.79 H	249	17.70	30.10
2	2483.50	41.60 AV	54.00	-12.40	1.79 H	249	11.50	30.10
3	2487.60	49.70 PK	74.00	-24.30	1.79 H	249	19.60	30.10
3	2487.60	43.30 AV	54.00	-10.70	1.79 H	249	13.20	30.10
4	4924.00	50.20 PK	74.00	-23.80	1.46 H	334	13.50	36.70
4	4924.00	41.90 AV	54.00	-12.10	1.46 H	334	5.20	36.70
5	7386.00	49.10 PK	74.00	-24.90	1.22 H	182	7.30	41.80
5	7386.00	38.50 AV	54.00	-15.50	1.22 H	182	-3.30	41.80
6	9848.00	55.50 PK	74.00	-18.50	1.47 H	343	11.10	44.40
6	9848.00	47.50 AV	54.00	-6.50	1.47 H	343	3.10	44.40

ANTENNA POLARITY & TEST DISTANCE: VERTICAL AT 3 M

No.	Freq. (MHz)	Emission Level (dBuV/m)	Limit (dBuV/m)	Margin (dB)	Antenna Height (m)	Table Angle (Degree)	Raw Value (dBuV)	Correction Factor (dB/m)
1	*2462.00	111.90 PK			1.28 V	247	81.80	30.10
1	*2462.00	106.80 AV			1.28 V	247	76.70	30.10
2	2483.50	55.80 PK	74.00	-18.20	1.28 V	247	25.70	30.10
2	2483.50	50.80 AV	54.00	-3.20	1.28 V	247	20.70	30.10
3	2487.60	57.60 PK	74.00	-16.40	1.28 V	247	27.50	30.10
3	2487.60	52.50 AV	54.00	-1.50	1.28 V	247	22.40	30.10
4	4924.00	55.70 PK	74.00	-18.30	1.07 V	223	19.00	36.70
4	4924.00	48.10 AV	54.00	-5.90	1.07 V	223	11.40	36.70
5	7386.00	49.80 PK	74.00	-24.20	1.31 V	176	8.00	41.80
5	7386.00	39.40 AV	54.00	-14.60	1.31 V	176	-2.40	41.80
6	9848.00	56.60 PK	74.00	-17.40	1.68 V	337	12.20	44.40
6	9848.00	50.30 AV	54.00	-3.70	1.68 V	337	5.90	44.40

- REMARKS:**
1. Emission level (dBuV/m)=Raw Value(dBuV) + Correction Factor(dB/m)
 2. Correction Factor (dB/m) = Antenna Factor (dB/m) + Cable Factor (dB)
 3. The other emission levels were very low against the limit.
 4. Margin value = Emission level – Limit value.
 5. The limit value is defined as per 15.247
 6. "*" ": Fundamental frequency
 7. For Wireless 802.11b mode at 1Mbps.

The frequency spectrum above 1 GHz for Transmitter was investigated. All emissions not reported are much lower than the prescribed limits. Readings are both peak and average values.

Company	ASOKA USA Corporation	Test Date	05/20/2008
Test Mode	Channel 1	Detector Function	Peak(PK)/Average(AV)
Product Name	PlugLink AV 9560 Wireless Adapter	Test By	Tracy Qi
Model Name	PL9560-WAP	TEMP&Humidity	25 °C, 53%

ANTENNA POLARITY & TEST DISTANCE: HORIZONTAL AT 3 M

No.	Freq. (MHz)	Emission Level (dBuV/m)	Limit (dBuV/m)	Margin (dB)	Antenna Height (m)	Table Angle (Degree)	Raw Value (dBuV)	Correction Factor (dB/m)
1	2390.00	49.70 PK	74.00	-24.30	1.87 H	123	15.90	33.80
1	2390.00	40.60 AV	54.00	-13.40	1.87 H	123	6.80	33.80
2	*2412.00	107.70 PK			1.87 H	123	77.80	29.90
2	*2412.00	100.50 AV			1.87 H	123	70.60	29.90
3	4824.00	50.20 PK	74.00	-23.80	1.32 H	10	14.00	36.20
3	4824.00	40.10 AV	54.00	-13.90	1.32 H	10	3.90	36.20
4	7236.00	50.30 PK	74.00	-23.70	1.43 H	27	8.60	41.70
4	7236.00	39.40 AV	54.00	-14.60	1.43 H	27	-2.30	41.70
5	9648.00	57.40 PK	74.00	-16.60	1.03 H	55	12.50	44.90
5	9648.00	47.40 AV	54.00	-6.60	1.03 H	55	2.50	44.90

ANTENNA POLARITY & TEST DISTANCE: VERTICAL AT 3 M

No.	Freq. (MHz)	Emission Level (dBuV/m)	Limit (dBuV/m)	Margin (dB)	Antenna Height (m)	Table Angle (Degree)	Raw Value (dBuV)	Correction Factor (dB/m)
1	2390.00	58.80 PK	74.00	-15.20	1.61 V	127	25.00	33.80
1	2390.00	50.70 AV	54.00	-3.30	1.61 V	127	16.90	33.80
2	*2412.00	117.70 PK			1.61 V	127	87.80	29.90
2	*2412.00	106.60 AV			1.61 V	127	76.70	29.90
3	4824.00	52.90 PK	74.00	-21.10	1.38 V	59	16.60	36.20
3	4824.00	42.00 AV	54.00	-12.00	1.38 V	59	5.70	36.20
4	7236.00	53.10 PK	74.00	-20.90	1.37 V	27	11.50	41.70
4	7236.00	40.30 AV	54.00	-13.70	1.37 V	27	-1.40	41.70
5	9648.00	56.80 PK	74.00	-17.20	1.38 V	8	11.90	44.90
5	9648.00	47.60 AV	54.00	-6.40	1.38 V	8	2.70	44.90

- REMARKS:**
1. Emission level (dBuV/m)=Raw Value(dBuV) + Correction Factor(dB/m)
 2. Correction Factor (dB/m) = Antenna Factor (dB/m) + Cable Factor (dB)
 3. The other emission levels were very low against the limit.
 4. Margin value = Emission level – Limit value.
 5. The limit value is defined as per 15.247
 6. "*" : Fundamental frequency
 7. For Wireless 802.11g mode at 6Mbps.

Company	ASOKA USA Corporation	Test Date	05/20/2008
Test Mode	Channel 6	Detector Function	Peak(PK)/Average(AV)
Product Name	PlugLink AV 9560 Wireless Adapter	Test By	Tracy Qi
Model Name	PL9560-WAP	TEMP&Humidity	25 ° C, 53%

ANTENNA POLARITY & TEST DISTANCE: HORIZONTAL AT 3 M								
No.	Freq. (MHz)	Emission Level (dBuV/m)	Limit (dBuV/m)	Margin (dB)	Antenna Height (m)	Table Angle (Degree)	Raw Value (dBuV)	Correction Factor (dB/m)
1	*2437.00	107.60 PK			1.47 H	122	77.60	30.00
1	*2437.00	100.60 AV			1.47 H	122	70.60	30.00
2	4874.00	49.90 PK	74.00	-24.10	1.39 H	21	13.40	36.50
2	4874.00	39.80 AV	54.00	-14.20	1.39 H	21	3.30	36.50
3	7311.00	50.80 PK	74.00	-23.20	1.47 H	53	9.10	41.80
3	7311.00	39.70 AV	54.00	-14.30	1.47 H	53	-2.00	41.80
4	9748.00	56.50 PK	74.00	-17.50	1.17 H	64	11.80	44.60
4	9748.00	46.80 AV	54.00	-7.20	1.17 H	64	2.10	44.60

ANTENNA POLARITY & TEST DISTANCE: VERTICAL AT 3 M								
No.	Freq. (MHz)	Emission Level (dBuV/m)	Limit (dBuV/m)	Margin (dB)	Antenna Height (m)	Table Angle (Degree)	Raw Value (dBuV)	Correction Factor (dB/m)
1	*2437.00	117.50 PK			1.31 V	122	87.50	30.00
1	*2437.00	107.80 AV			1.31 V	122	77.80	30.00
2	4874.00	52.70 PK	74.00	-21.30	1.34 V	47	16.20	36.50
2	4874.00	41.80 AV	54.00	-12.20	1.34 V	47	5.30	36.50
3	7311.00	53.20 PK	74.00	-20.80	1.29 V	41	11.40	41.80
3	7311.00	40.20 AV	54.00	-13.80	1.29 V	41	-1.60	41.80
4	9748.00	56.40 PK	74.00	-17.60	1.27 V	26	11.80	44.60
4	9748.00	47.90 AV	54.00	-6.10	1.27 V	26	3.30	44.60

- REMARKS:**
1. Emission level (dBuV/m) = Raw Value (dBuV) + Correction Factor (dB/m)
 2. Correction Factor (dB/m) = Antenna Factor (dB/m) + Cable Factor (dB)
 3. The other emission levels were very low against the limit.
 4. Margin value = Emission level – Limit value.
 5. The limit value is defined as per 15.247
 6. “* “: Fundamental frequency
 7. For Wireless 802.11g mode at 6Mbps.

Company	ASOKA USA Corporation	Test Date	05/20/2008
Test Mode	Channel 11	Detector Function	Peak(PK)/Average(AV)
Product Name	PlugLink AV 9560 Wireless Adapter	Test By	Tracy Qi
Model Name	PL9560-WAP	TEMP&Humidity	25 ° C, 53%

ANTENNA POLARITY & TEST DISTANCE: HORIZONTAL AT 3 M								
No.	Freq. (MHz)	Emission Level (dBuV/m)	Limit (dBuV/m)	Margin (dB)	Antenna Height (m)	Table Angle (Degree)	Raw Value (dBuV)	Correction Factor (dB/m)
1	*2462.00	107.40 PK			1.89 H	122	77.30	30.10
1	*2462.00	100.90 AV			1.89 H	122	70.80	30.10
2	2483.50	51.70 PK	74.00	-22.30	1.89 H	122	21.60	30.10
2	2483.50	41.60 AV	54.00	-12.40	1.89 H	122	11.50	30.10
3	4924.00	48.90 PK	74.00	-25.10	1.29 H	9	12.20	36.70
3	4924.00	38.80 AV	54.00	-15.20	1.29 H	9	2.20	36.70
4	7386.00	50.80 PK	74.00	-23.20	1.45 H	21	9.00	41.80
4	7386.00	39.80 AV	54.00	-14.20	1.45 H	21	-2.00	41.80
5	9848.00	55.80 PK	74.00	-18.20	1.41 H	118	11.50	44.40
5	9848.00	46.10 AV	54.00	-7.90	1.41 H	118	1.80	44.40

ANTENNA POLARITY & TEST DISTANCE: VERTICAL AT 3 M								
No.	Freq. (MHz)	Emission Level (dBuV/m)	Limit (dBuV/m)	Margin (dB)	Antenna Height (m)	Table Angle (Degree)	Raw Value (dBuV)	Correction Factor (dB/m)
1	*2462.00	118.00 PK			1.30 V	125	87.90	30.10
1	*2462.00	108.30 AV			1.30 V	125	78.20	30.10
2	2483.50	63.10 PK	74.00	-10.90	1.30 V	125	33.00	30.10
2	2483.50	53.00 AV	54.00	-1.00	1.30 V	125	22.90	30.10
3	4924.00	52.70 PK	74.00	-21.30	1.27 V	38	16.10	36.70
3	4924.00	41.10 AV	54.00	-12.90	1.27 V	38	4.40	36.70
4	7386.00	53.20 PK	74.00	-20.80	1.28 V	35	11.30	41.80
4	7386.00	40.10 AV	54.00	-13.90	1.28 V	35	-1.80	41.80
5	9848.00	56.30 PK	74.00	-17.70	1.00 V	37	11.90	44.40
5	9848.00	48.70 AV	54.00	-5.30	1.00 V	37	4.40	44.40

- REMARKS:**
1. Emission level (dBuV/m) = Raw Value (dBuV) + Correction Factor (dB/m)
 2. Correction Factor (dB/m) = Antenna Factor (dB/m) + Cable Factor (dB)
 3. The other emission levels were very low against the limit.
 4. Margin value = Emission level – Limit value.
 5. The limit value is defined as per 15.247
 6. “ * “ : Fundamental frequency
 7. For Wireless 802.11g mode at 6Mbps.

4.3. Maximum Peak Output Power

TEST CONFIGURATION

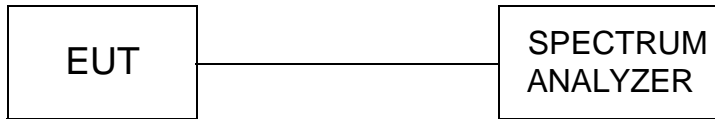

TEST PROCEDURE

- The spectrum shall be set as follows :
 - Span : 1.5 times channel integration bandwidth.
 - RBW : 1MHz
 - VBW : 3MHz
 - Detector : Peak
 - Sweep : Single trace
- Compute the combined power of all signal responses contained in the trace by covering all the data points.
- For 99% occupied BW, place the markers at the frequency at which 0.5% of the power lies to the right of the right marker and 0.5% of the power lies to the left of the left marker.
- The peak output power is the channel power integrated over 99% bandwidth.

LIMIT

The Maximum Peak Output Power Measurement is 30dBm.

TEST RESULTS

Company	ASOKA USA Corporation	Test Date	05/20/2008
Product Name	PlugLink AV 9560 Wireless Adapter	Test By	Tracy Qi
Model Name	PL9560-WAP	TEMP&Humidity	25 °C, 53%

Data Rate (Mbps)	Channel Frequency (MHz)	Peak Power Output (dBm)	Peak Power Limit (dBm)	Pass / Fail
1	2437	16.88	30	PASS
2	2437	16.80	30	PASS
5.5	2437	16.75	30	PASS
11	2437	16.67	30	PASS

Channel	Channel Frequency (MHz)	Peak Power Output (dBm)	Peak Power Limit (dBm)	Pass / Fail
1	2412	16.79	30	PASS
6	2437	16.88	30	PASS
11	2462	16.71	30	PASS

Note: 1. For 802.11b Mode at 1M bps

Data Rate (Mbps)	Channel Frequency (MHz)	Peak Power Output (dBm)	Peak Power Limit (dBm)	Pass / Fail
6	2462	19.77	30	PASS
9	2462	19.74	30	PASS
12	2462	19.70	30	PASS
18	2462	19.68	30	PASS
24	2462	19.65	30	PASS
36	2462	19.64	30	PASS
48	2462	19.62	30	PASS
54	2462	19.60	30	PASS

Channel	Channel Frequency (MHz)	Peak Power Output (dBm)	Peak Power Limit (dBm)	Pass / Fail
1	2412	19.63	30	PASS
6	2437	19.72	30	PASS
11	2462	19.77	30	PASS

Note: 1. For 802.11g Mode at 6M bps

4.4. Power Spectral Density Measurement

TEST CONFIGURATION

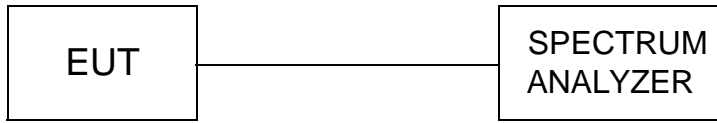

TEST PROCEDURE

1. The transmitter output (antenna port) was connected to the spectrum analyzer.
2. Set RBW of spectrum analyzer to 3kHz and VBW to 30kHz. Set Detector to Peak, Trace to Max Hold.
3. Mark the frequency with maximum peak power as the center of the display of the spectrum.
4. Set the span to 1.5MHz and the sweep time to 500s and record the maximum peak value.

LIMIT

For digitally modulated systems, the power spectral density conducted from the intentional radiator to the antenna shall not be greater than 8 dBm in any 3 kHz band during any time interval of continuous transmission.

TEST RESULTS

Company	ASOKA USA Corporation	Test Date	05/20/2008
Product Name	PlugLink AV 9560 Wireless Adapter	Test By	Tracy Qi
Model Name	PL9560-WAP	TEMP&Humidity	25 °C, 53%

CHANNEL NUMBER	CHANNEL FREQUENCY (MHz)	RF POWER LEVEL IN 3 KHz BW (dBm)	MAXIMUM LIMIT (dBm)	PASS/FAIL
1	2412	-6.06	8	PASS
6	2437	-6.43	8	PASS
11	2462	-6.50	8	PASS

Note: 1. For 802.11b mode at final test to get the worst-case emission at 1Mbps.

CHANNEL NUMBER	CHANNEL FREQUENCY (MHz)	RF POWER LEVEL IN 3 KHz BW (dBm)	MAXIMUM LIMIT (dBm)	PASS/FAIL
1	2412	-11.01	8	PASS
6	2437	-11.39	8	PASS
11	2462	-11.57	8	PASS

Note: 1. For 802.11g mode at final test to get the worst-case emission at 6Mbps

Photo of Power Spectral Density Measurement

Note: For 802.11b Mode

Channel 1

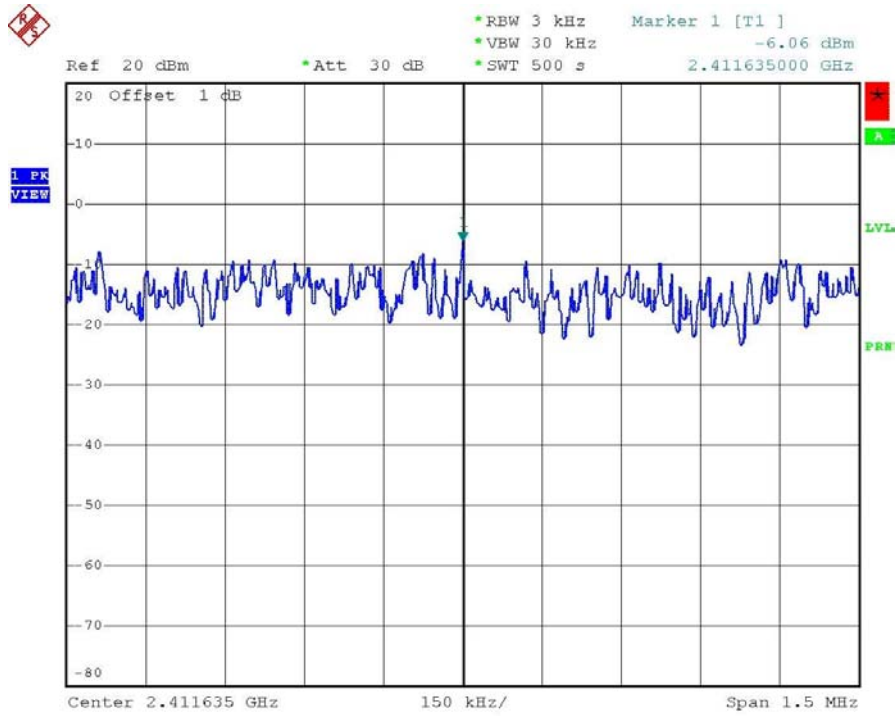

Channel 6

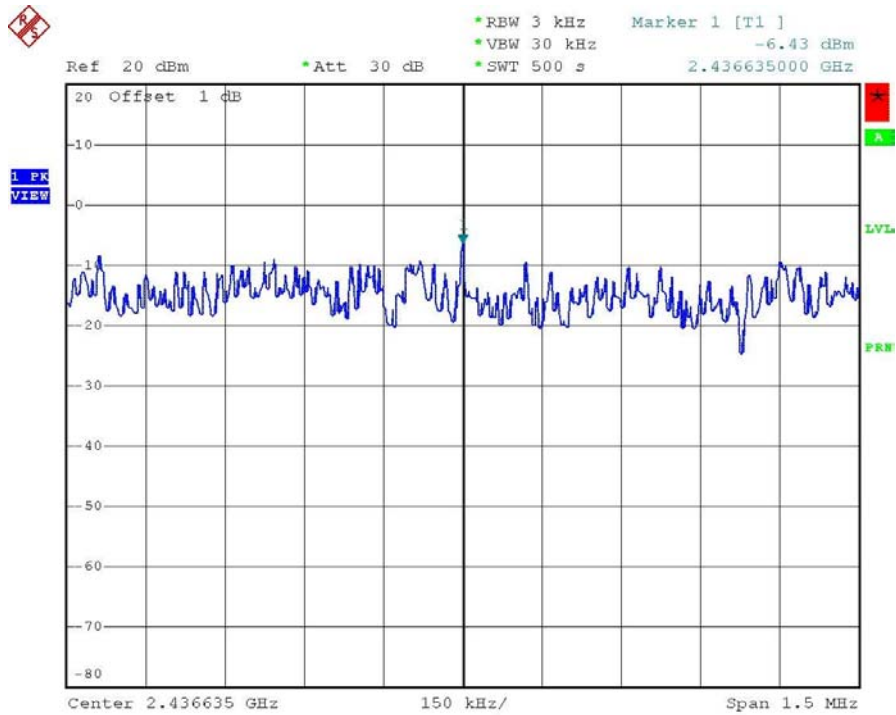

Channel 11

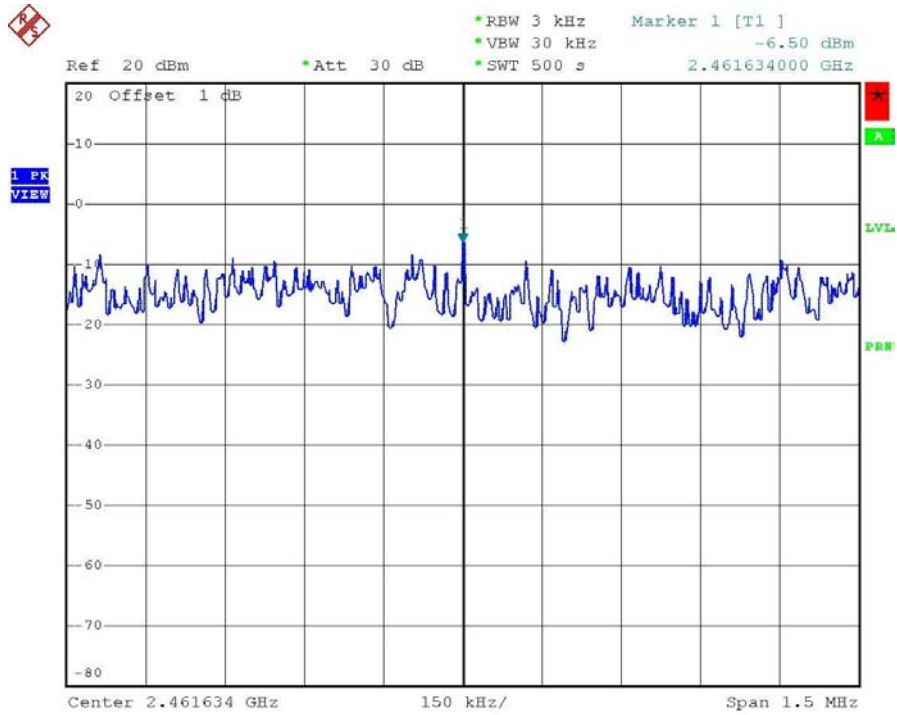

Note: For 802.11g Mode

Channel 1

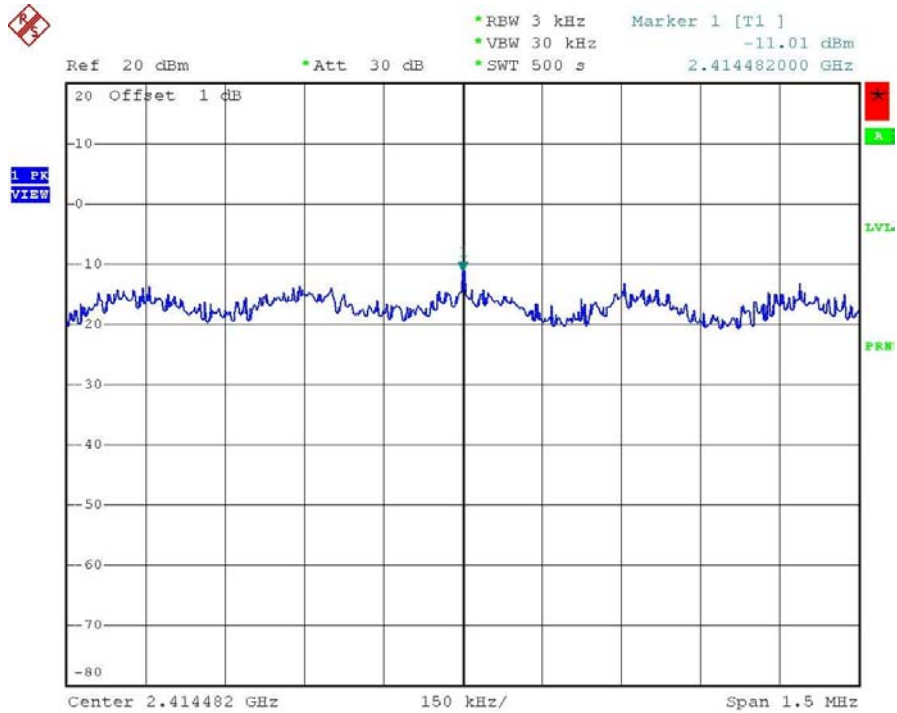

Channel 6

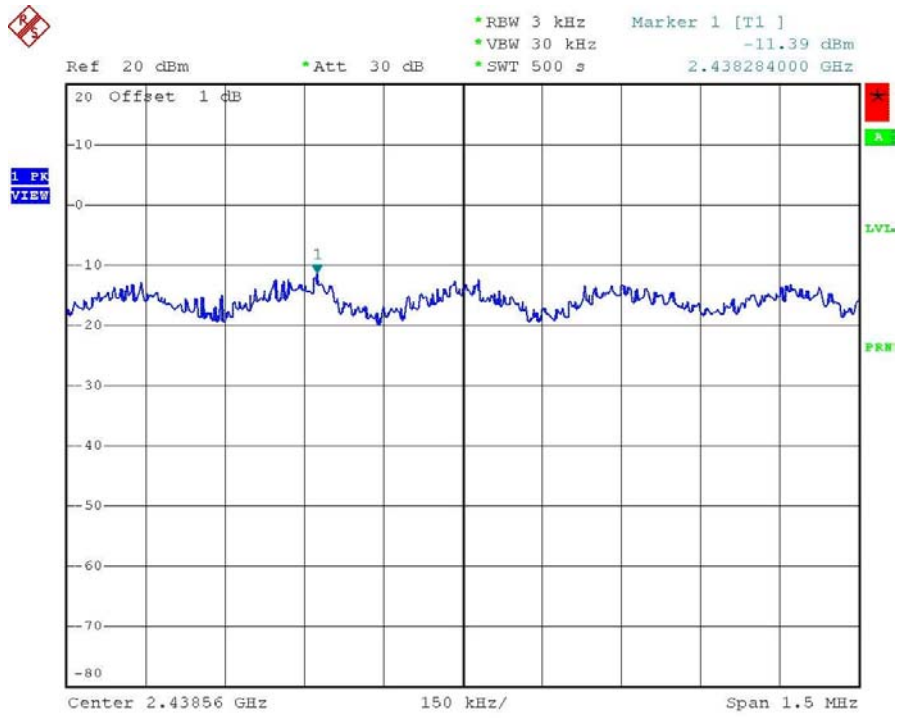

Channel 11

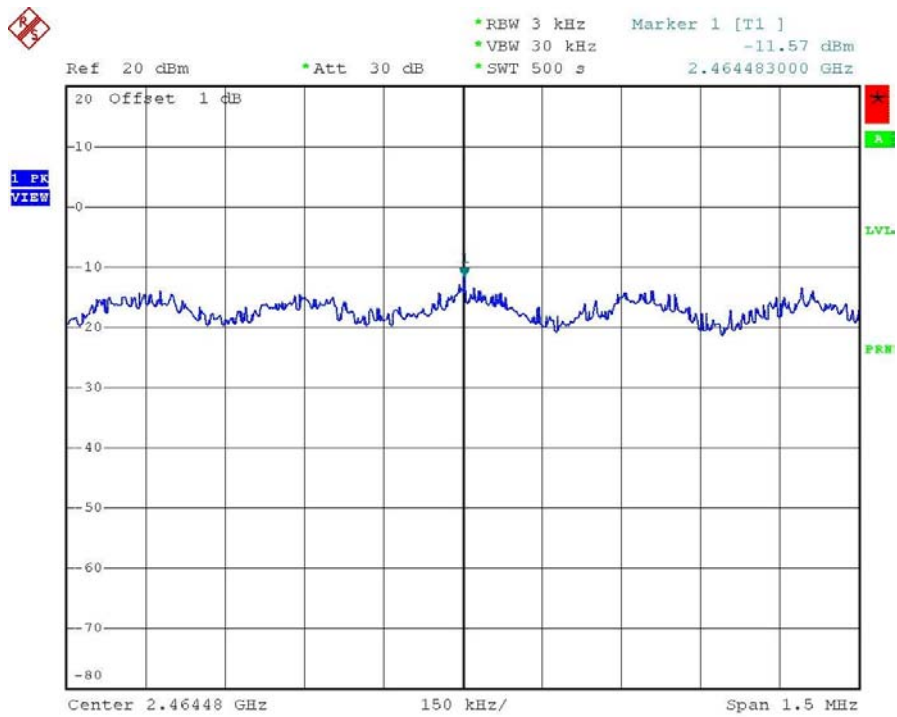

4.5. Band Edge Measurement

TEST CONFIGURATION

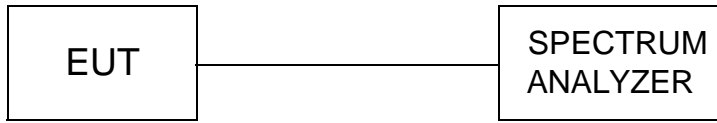

TEST PROCEDURE

The band edge compliance of RF radiated emission should be measured by following the guidance in ANSI C63.4 with respect to maximizing the emission by rotating the EUT, measuring the emission while the EUT is situated in three orthogonal planes (if appropriate), adjusting the measurement antenna height and polarization etc. Set RBW and VBM to 1MHz to measure the peak field strength and set RBW to 1MHz and VBW to 10Hz to measure the average radiated field strength.

The conducted RF band edge was measured by using a spectrum analyzer. Set span wide enough to capture the highest in-band emission and the emission at the band edge. Set RBW and VBW to 100 kHz, to measure the conducted peak band edge.

LIMIT

1. Below -20dB of the highest emission level in operating band.
2. Fall in the restricted bands listed in section 15.205. The maximum permitted average field strength is listed in section 15.209.

TEST RESULTS

Photo of Band Edge Measurement

Note: For 802.11b Mode

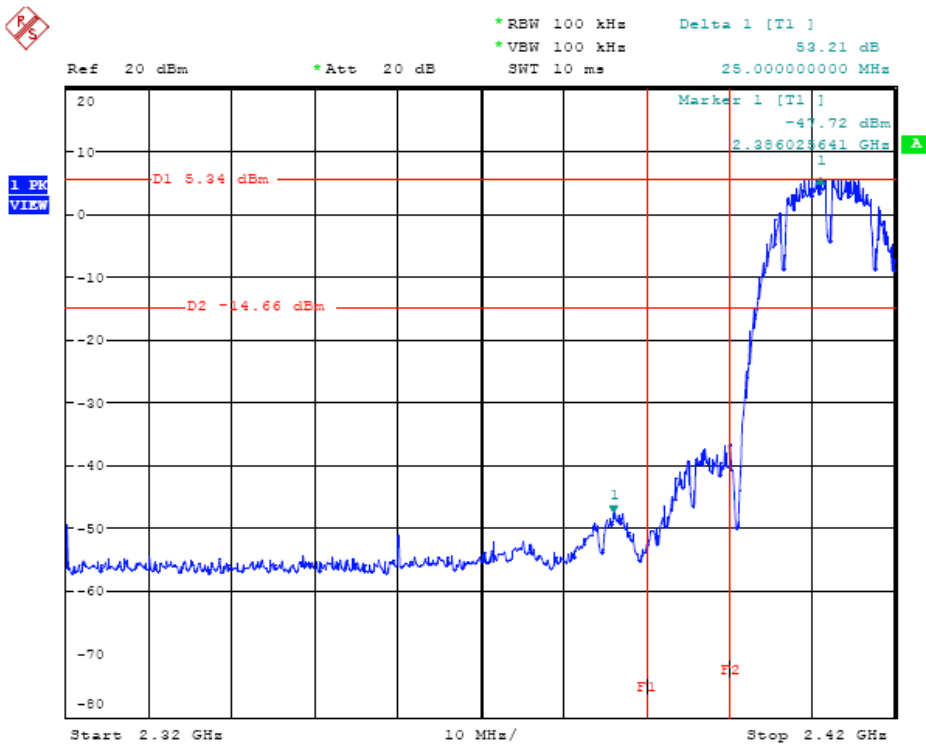

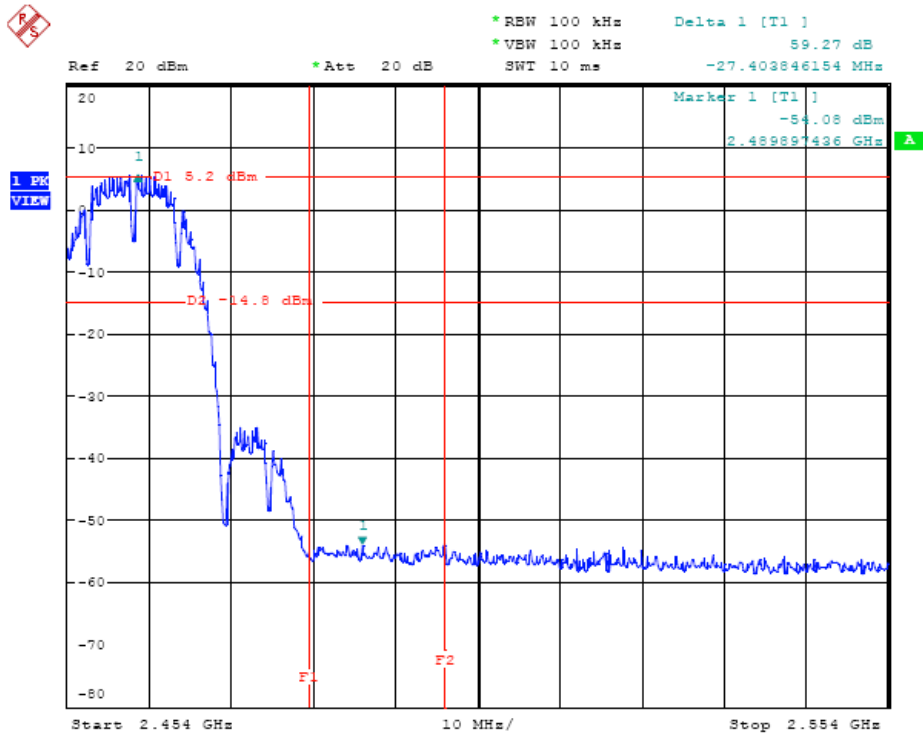

Note : For 802.11g Mode

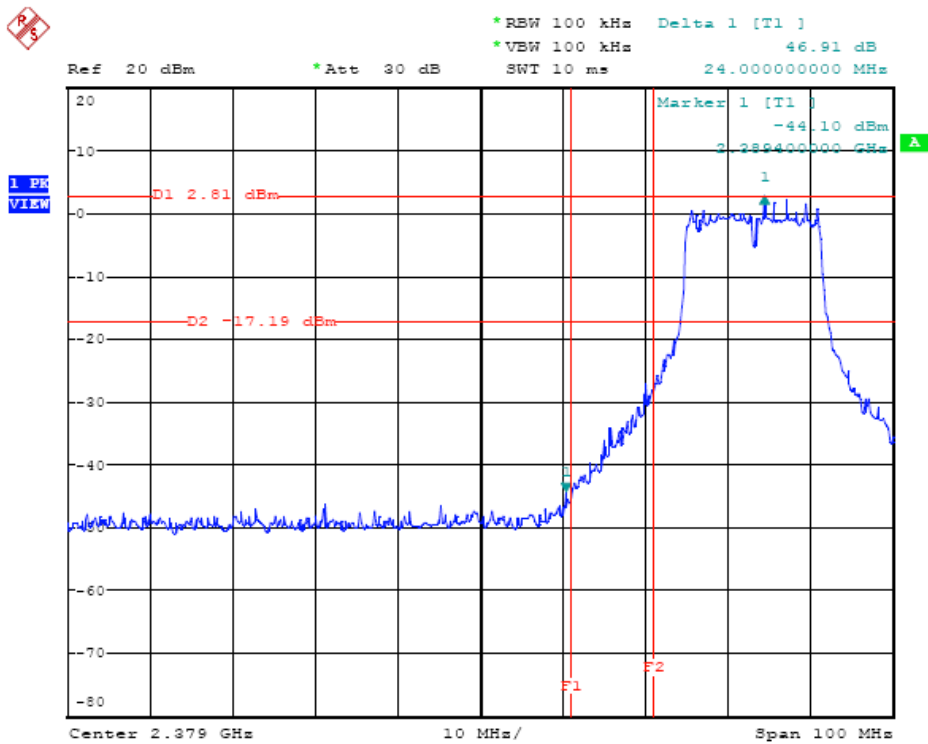



*RBW 100 kHz Delta 1 [T1]
*VBW 100 kHz 43.94 dB
Ref 20 dBm *Att 30 dB SWI 10 ms -29.17200000 MHz

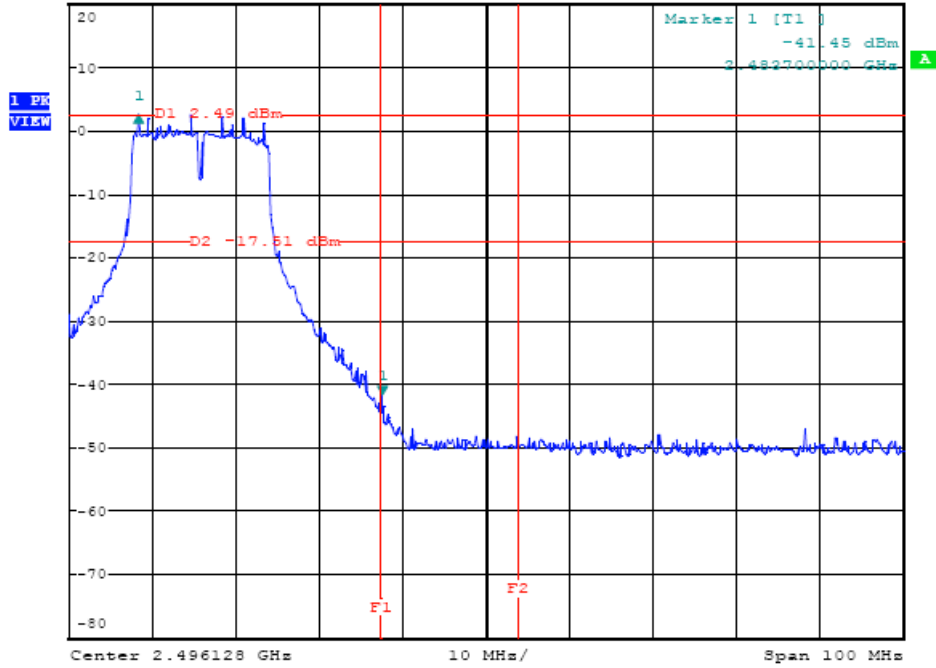

4.6. 6dB Bandwidth Measurement

TEST CONFIGURATION

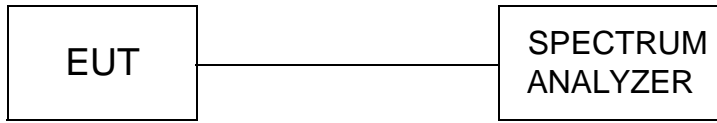

TEST PROCEDURE

The transmitter output was connected to the spectrum analyzer through an attenuator. The bandwidth of the fundamental frequency was measured by spectrum analyzer with 300 KHz RBW and 1MHz VBW. The 6dB bandwidth is defined as the total spectrum the power of which is higher than peak power minus 6dB.

LIMIT

For digital modulation systems, the minimum 6 dB bandwidth shall be at least 500 kHz.

TEST RESULTS

Company	ASOKA USA Corporation	Test Date	05/20/2008
Product Name	PlugLink AV 9560 Wireless Adapter	Test By	Tracy Qi
Model Name	PL9560-WAP	TEMP&Humidity	25 °C, 53%

CHANNEL	CHANNEL FREQUENCY (MHz)	6 dB BANDWIDTH (MHz)	MINIMUM LIMIT (MHz)	PASS/FAIL
1	2412	10.40	0.5	PASS
6	2437	10.05	0.5	PASS
11	2462	10.90	0.5	PASS

Note: 1. For 802.11b Mode

CHANNEL	CHANNEL FREQUENCY (MHz)	6 dB BANDWIDTH (MHz)	MINIMUM LIMIT (MHz)	PASS/FAIL
1	2412	16.40	0.5	PASS
6	2437	16.40	0.5	PASS
11	2462	16.40	0.5	PASS

Note: 1. For 802.11g Mode

6 dB Bandwidth Test Plots:

Note: For 802.11b Mode

Channel 1

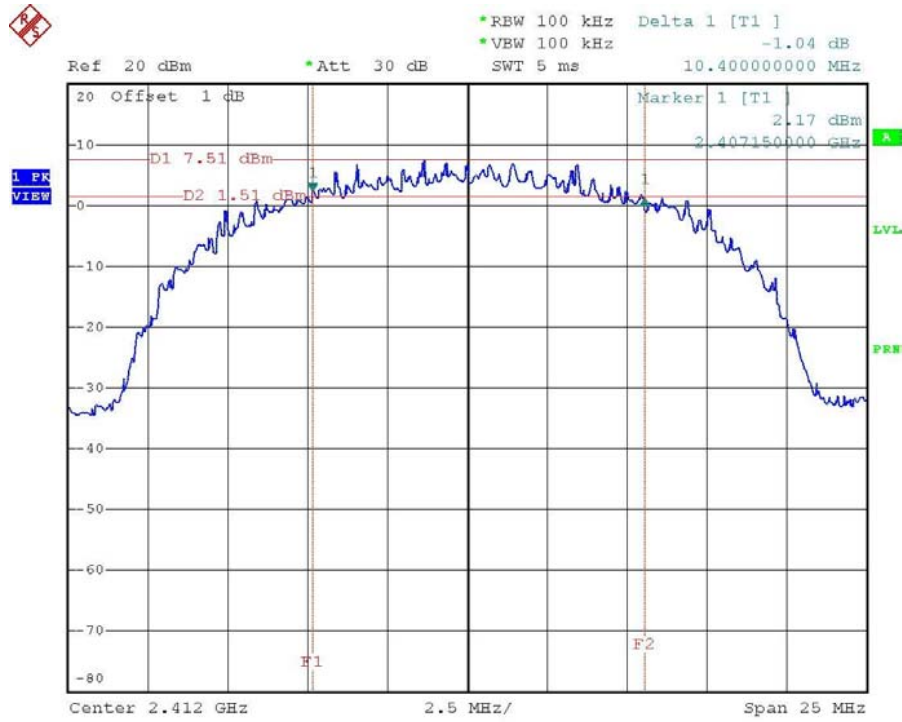

Channel 6

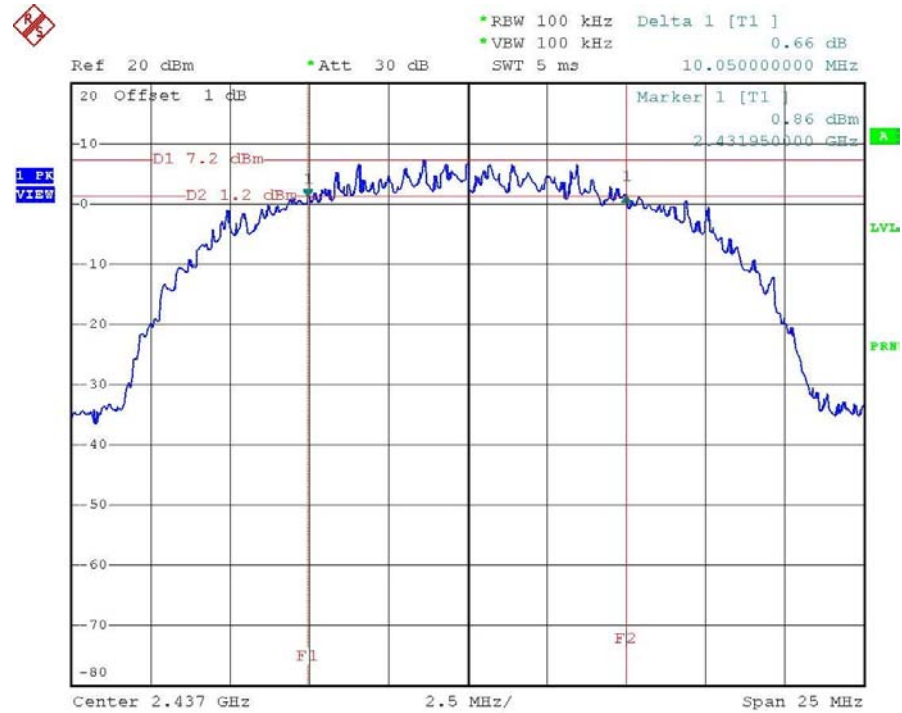

Channel 11

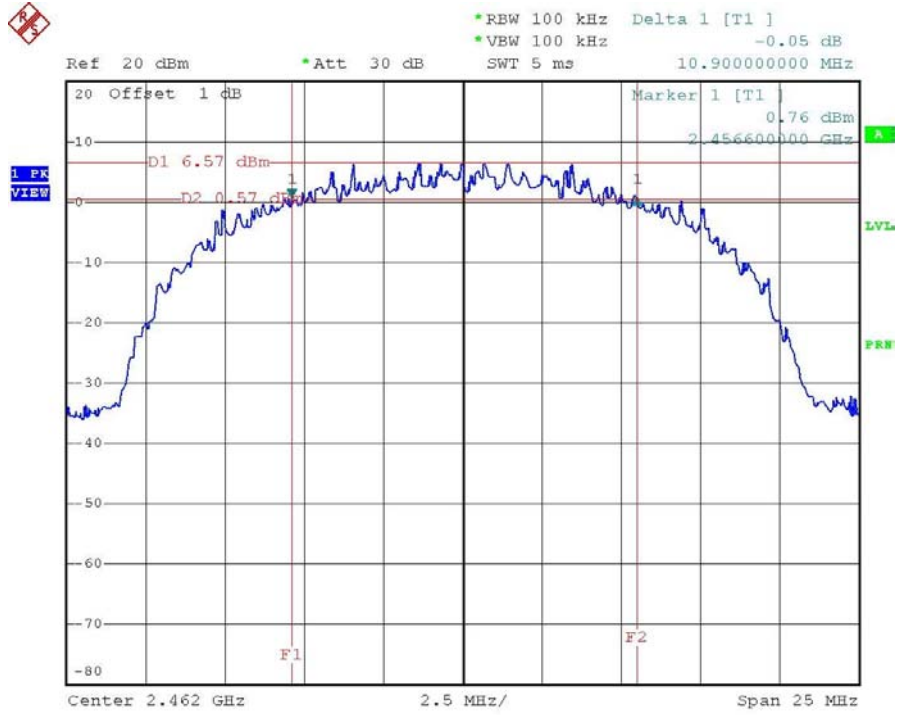

Note : For 802.11g Mode

Channel 1

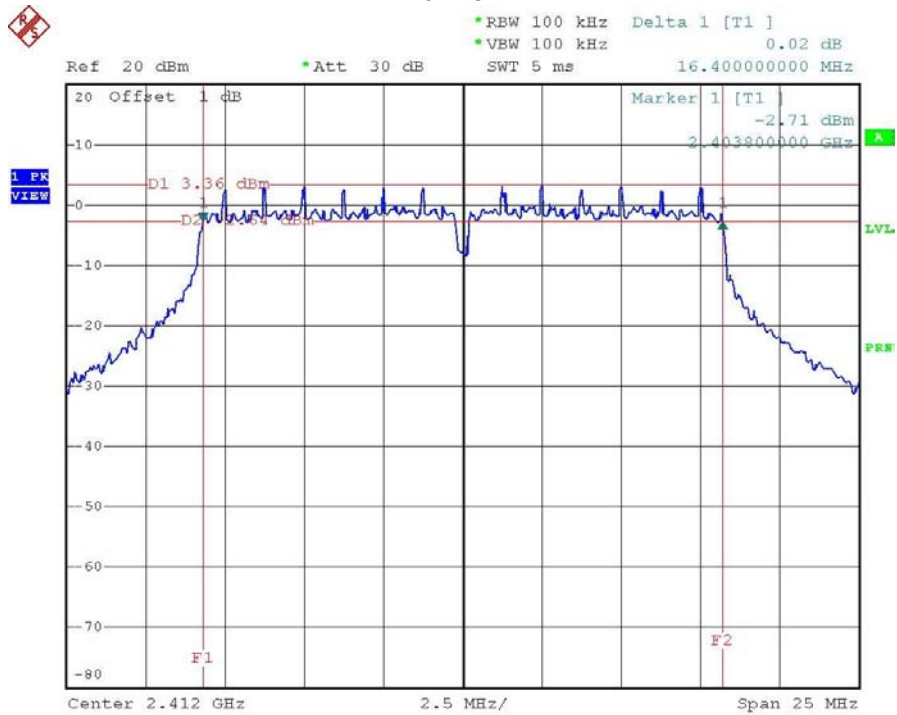

Channel 6

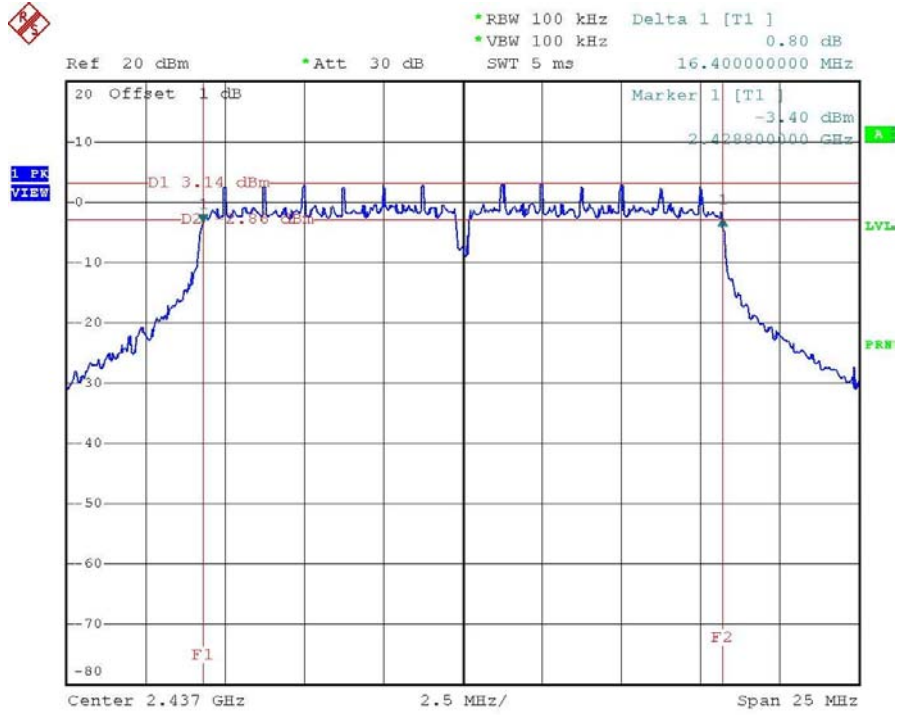

Channel 11

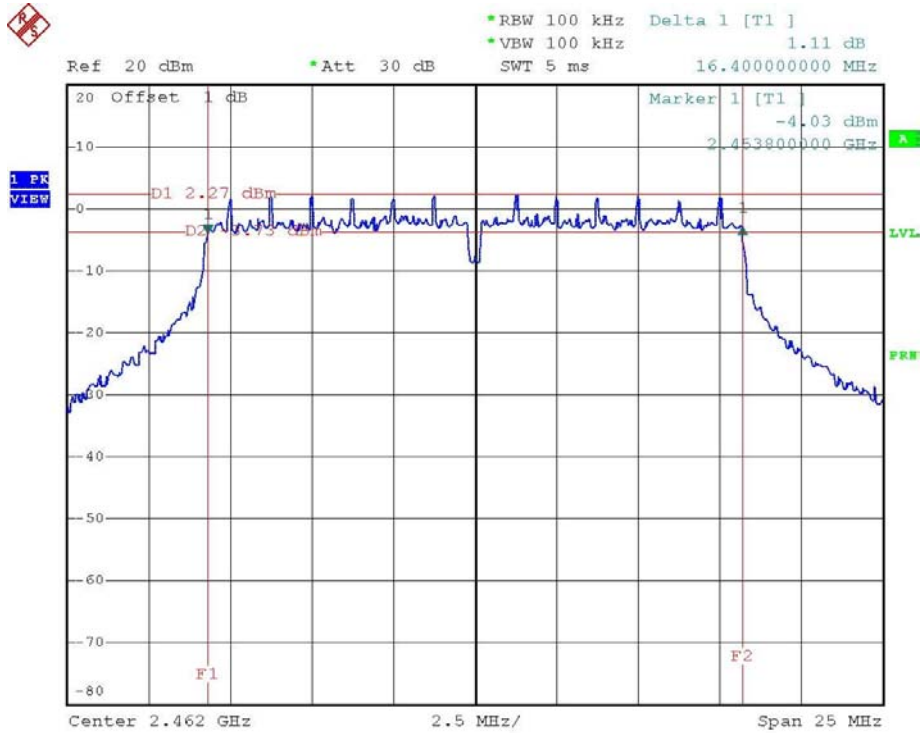

4.7. Antenna Requirement

Standard Applicable

For intentional device, according to FCC 47 CFR Section 15.203, an intentional radiator shall be designed to ensure that no antenna other than that furnished by the responsible party shall be used with the device.

And according to FCC 47 CFR Section 15.247 (c), if transmitting antennas of directional gain greater than 6dBi are used, the power shall be reduced by the amount in dB that the directional gain of the antenna exceeds 6dBi.

Refer to statement below for compliance.

The manufacturer may design the unit so that the user can replace a broken antenna, but the use of a standard antenna jack or electrical connector is prohibited. Further, this requirement does not apply to intentional radiators that must be professionally installed.

Antenna Connected Construction

The antenna used in this product is Dipole antenna. The maximum Gain of the antenna only 2dBi.

APPENDIX 1--PHOTOGRAPHS OF SET UP

Radiated Emission

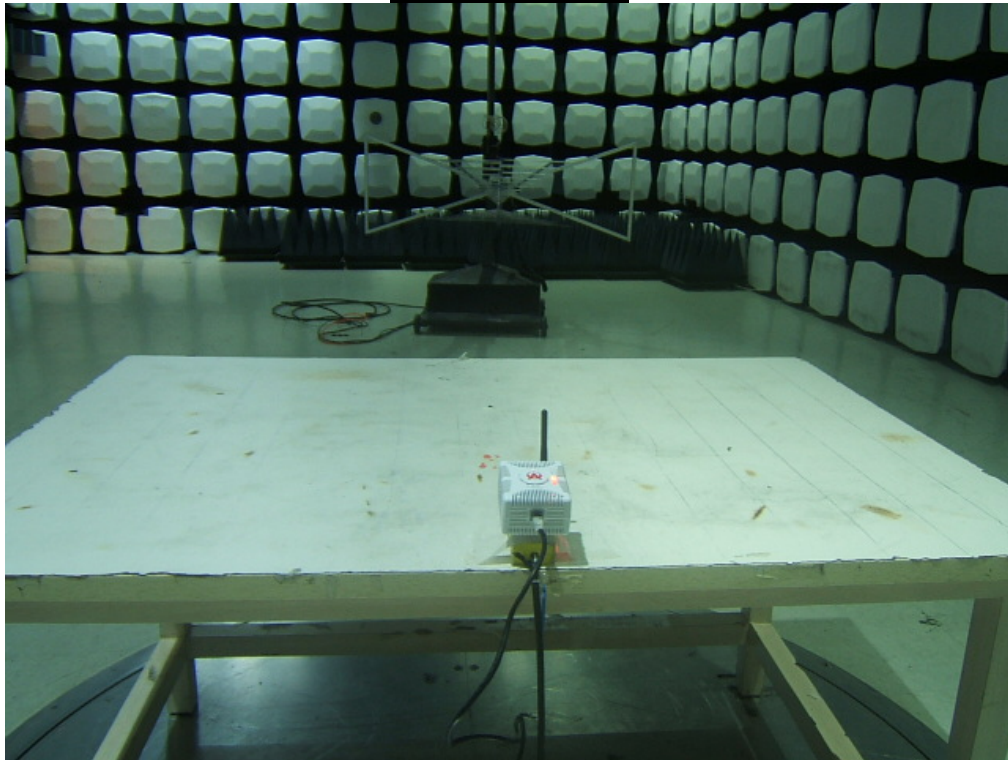

Conducted Emission



APPENDIX 2--PHOTOGRAPHS OF EUT

External Photos

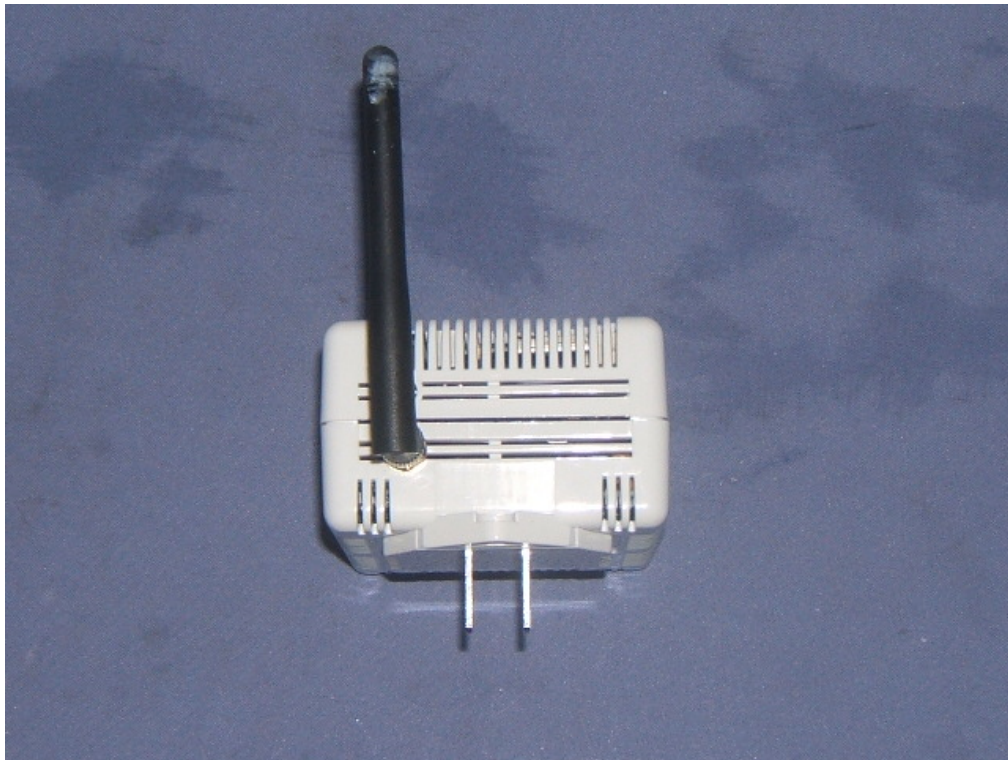

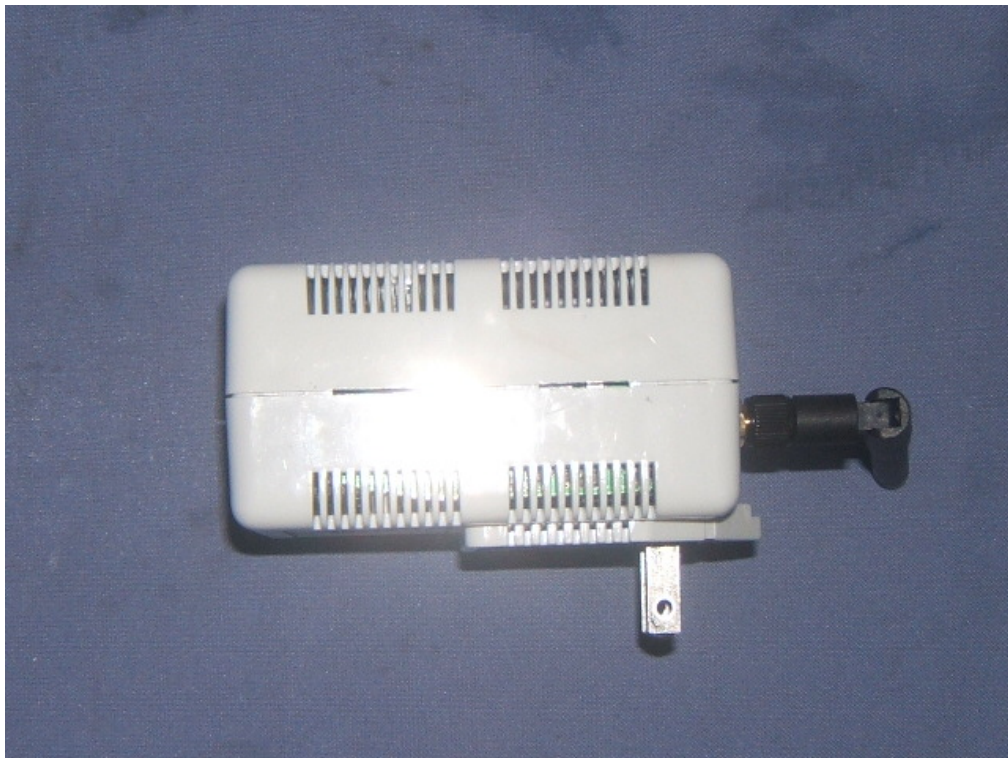
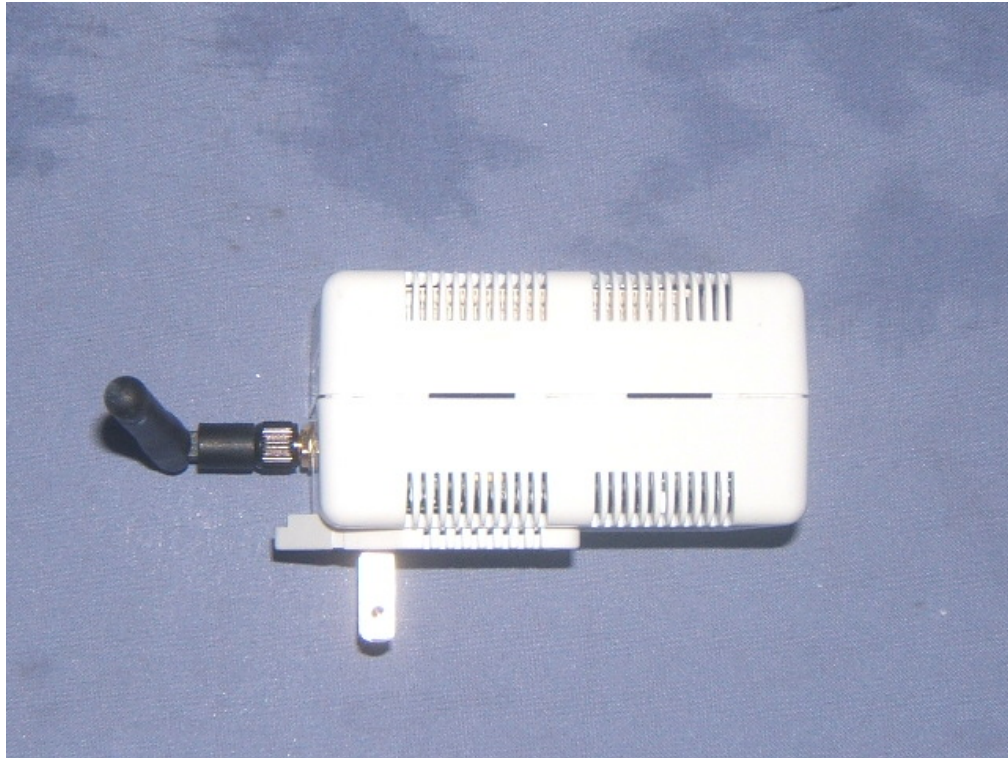

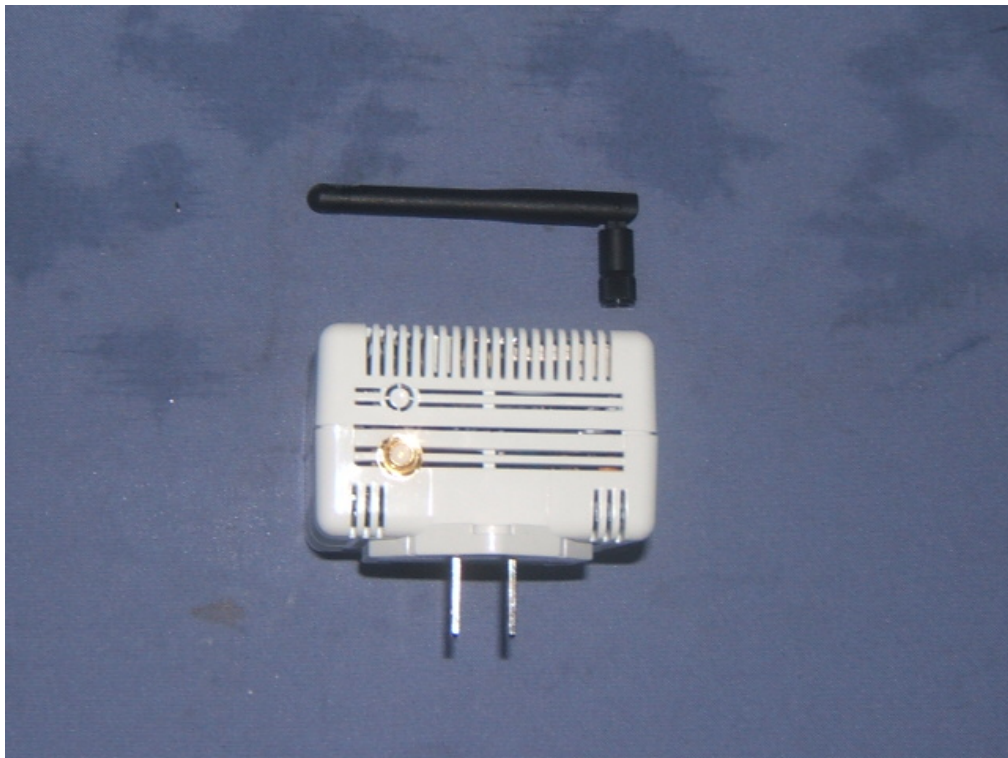



Internal Photos



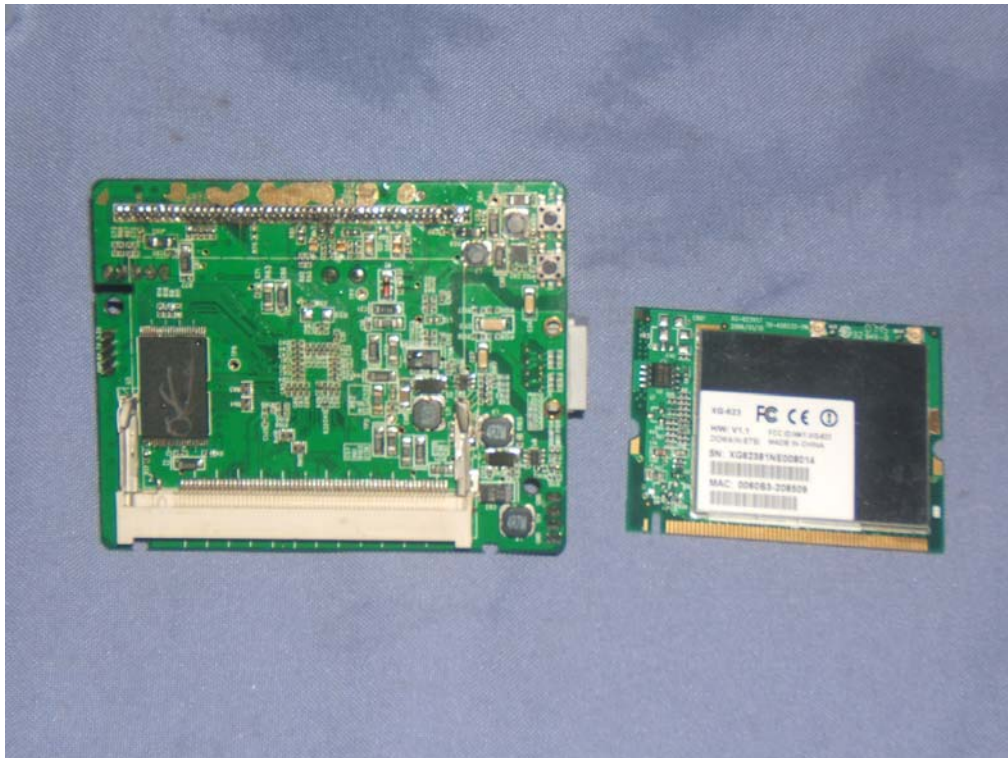



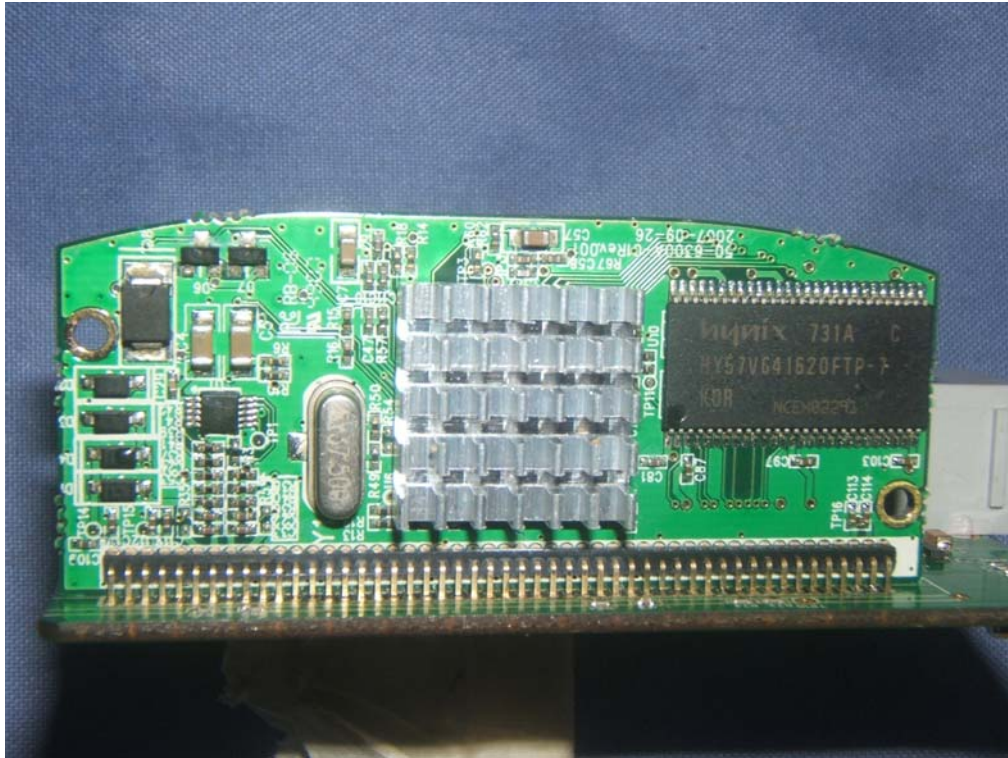



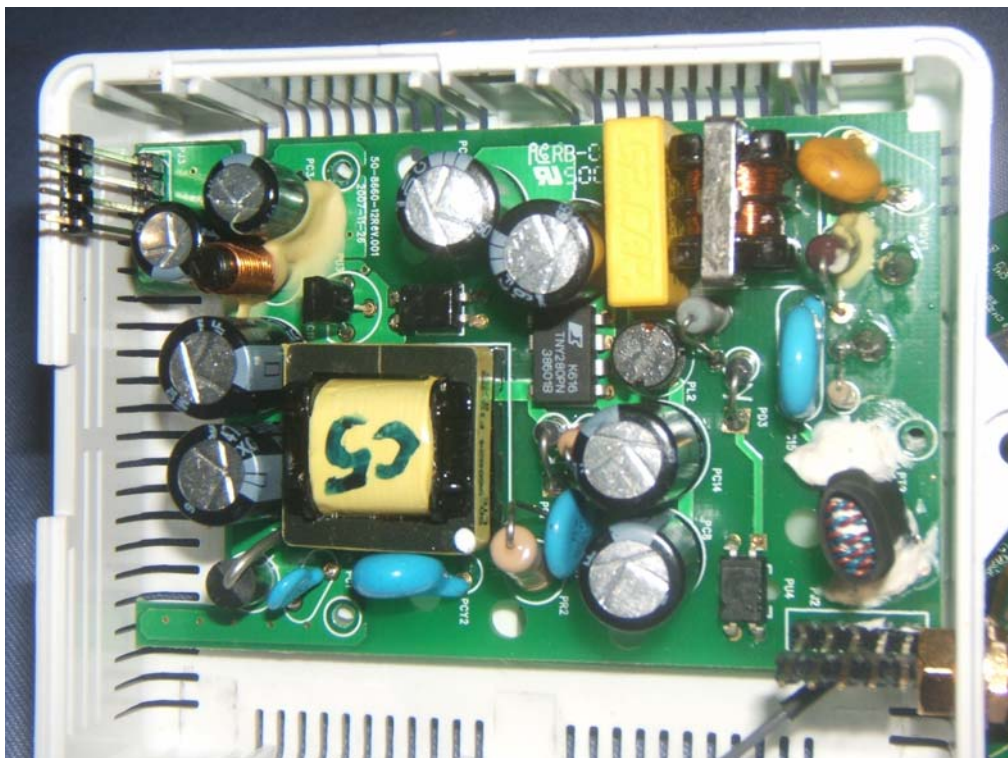

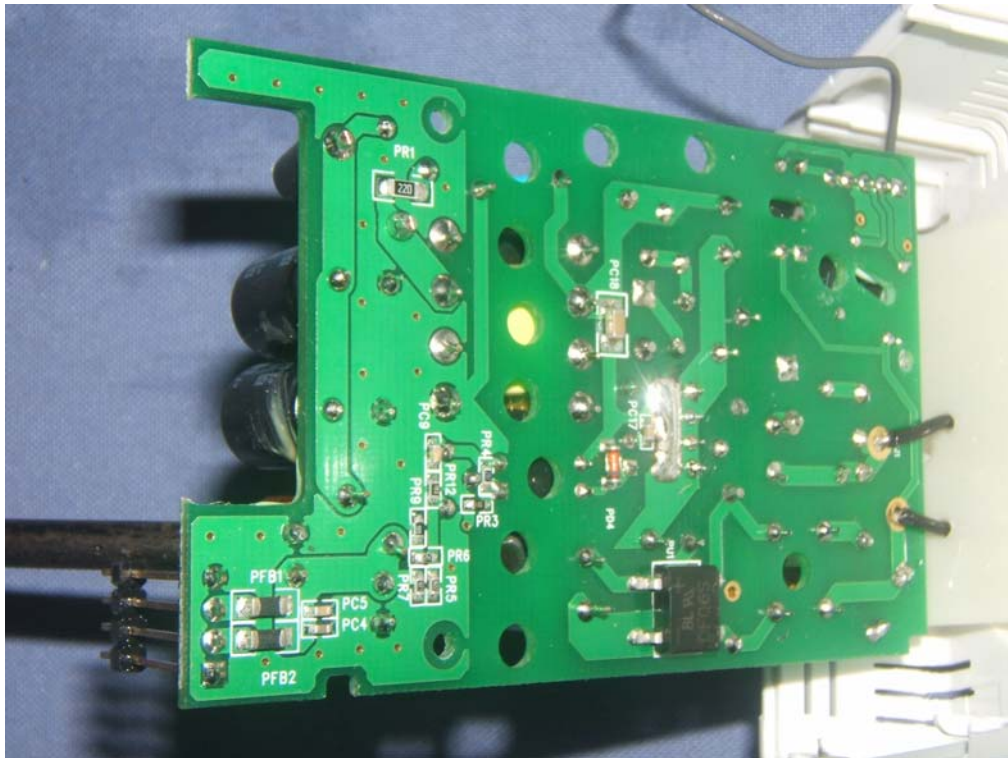

.....End of Report.....