

Product Name: Wi-Fi&Bluetooth Module	Report No: FCC022022-06244RF2
Product Model: YL43456	Security Classification: Open
Version: V1.0	Total Page: 322

TIRT Testing Report



Prepared By:	Checked By:	Approved By:	
Stone Tang	Randy Lv	Daniel Chen	
<i>Stone Tang</i>	<i>Randy Lv</i>	<i>Daniel Chen</i>	

FCC Radio Test Report

FCC ID: T2C-YL43456

This report concerns: Original Grant

Equipment : Wi-Fi&Bluetooth Module
Brand Name : Yealink
Test Model : YL43456
Series Model : N/A
Applicant : YEALINK(XIAMEN) NETWORK TECHNOLOGY CO., LTD.
Address : No. 666 Hu'an Rd, Huli District Xiamen City, Fujian, P.R. China
Manufacturer : YEALINK(XIAMEN) NETWORK TECHNOLOGY CO., LTD.
Address : No. 666 Hu'an Rd, Huli District Xiamen City, Fujian, P.R. China
Date of Receipt : Dec. 06, 2022
Date of Test : Dec. 06, 2022~ Jan. 25, 2023
Issued Date : Jan. 28, 2023
Report Version : V1.0
Test Sample : Engineering Sample No.: 20221206021239
Standard(s) : FCC CFR Title 47, Part 15, Subpart E
FCC KDB 789033 D02 General UNII Test Procedures New Rules v02r01
FCC KDB 662911 D01 Multiple Transmitter Output v02r01
ANSI C63.10-2013

- The test result referred exclusively to the presented test model /sample.
- Without written approval of TIRT Inc. the test report shall not reproduced except in full.

Lab: Beijing TIRT Technology Service Co.,Ltd Shenzhen

Add: 101, 3 # Factory Building, Gongjin Electronics Shatin Community, Kengzi Street, Pingshan

District, Shenzhen, China

TEL: +86-0755-27087573

Table of Contents	Page
REPORT ISSUED HISTORY	5
1 . SUMMARY OF TEST RESULTS	6
1.1 TEST FACILITY	7
1.2 MEASUREMENT UNCERTAINTY	7
1.3 TEST ENVIRONMENT CONDITIONS	7
2 . GENERAL INFORMATION	8
2.1 GENERAL DESCRIPTION OF EUT	8
2.2 TEST MODES	10
2.3 PARAMETERS OF TEST SOFTWARE	13
2.4 DUTY CYCLE	15
2.5 BLOCK DIAGRAM SHOWING THE CONFIGURATION OF SYSTEM TESTED	19
2.6 SUPPORT UNITS	19
3 . AC POWER LINE CONDUCTED EMISSIONS	20
3.1 LIMIT	20
3.2 TEST PROCEDURE	20
3.3 DEVIATION FROM TEST STANDARD	20
3.4 TEST SETUP	21
3.5 EUT OPERATION CONDITIONS	21
3.6 TEST RESULTS	21
4 . RADIATED EMISSIONS	22
4.1 LIMIT	22
4.2 TEST PROCEDURE	22
4.3 DEVIATION FROM TEST STANDARD	24
4.4 TEST SETUP	24
4.5 EUT OPERATION CONDITIONS	25
4.6 TEST RESULTS - 9 KHZ TO 30 MHZ	25
4.7 TEST RESULTS - 30 MHZ TO 1000 MHZ	25
4.8 TEST RESULTS - ABOVE 1000 MHZ	25
5 . BANDWIDTH	26
5.1 LIMIT	26
5.2 TEST PROCEDURE	26
5.3 DEVIATION FROM STANDARD	26
5.4 TEST SETUP	27
5.5 EUT OPERATION CONDITIONS	27

Table of Contents	Page
5.6 TEST RESULTS	27
6 . MAXIMUM OUTPUT POWER	28
6.1 LIMIT	28
6.2 TEST PROCEDURE	28
6.3 DEVIATION FROM STANDARD	28
6.4 TEST SETUP	28
6.5 EUT OPERATION CONDITIONS	28
6.6 TEST RESULTS	28
7 . POWER SPECTRAL DENSITY	29
7.1 LIMIT	29
7.2 TEST PROCEDURE	29
7.3 DEVIATION FROM STANDARD	29
7.4 TEST SETUP	30
7.5 EUT OPERATION CONDITIONS	30
7.6 TEST RESULTS	30
8 . FREQUENCY STABILITY	31
8.1 LIMIT	31
8.2 TEST PROCEDURE	31
8.3 DEVIATION FROM STANDARD	31
8.4 TEST SETUP	31
8.5 EUT OPERATION CONDITIONS	31
8.6 TEST RESULTS	31
9 . MEASUREMENT INSTRUMENTS LIST	32
10 . EUT TEST PHOTOS	33
APPENDIX A - AC POWER LINE CONDUCTED EMISSIONS	36
APPENDIX B - RADIATED EMISSION - 9 KHZ TO 30 MHZ	39
APPENDIX C - RADIATED EMISSION - 30 MHZ TO 1000 MHZ	40
APPENDIX D - RADIATED EMISSION - ABOVE 1000 MHZ	43
APPENDIX E - BANDWIDTH	218
APPENDIX F - MAXIMUM OUTPUT POWER	289
APPENDIX G - POWER SPECTRAL DENSITY	291

REPORT ISSUED HISTORY

Report No.	Version	Description	Issued Date	Note
FCC022022-06244RF2	V1.0	Original Report.	2023.01.28	Valid

1. SUMMARY OF TEST RESULTS

Test procedures according to the technical standard(s):

FCC CFR Title 47, Part 15, Subpart E				
Standard(s) Section	Test Item	Test Result	Judgment	Remark
15.207 15.407(b)	AC Power Line Conducted Emissions	APPENDIX A	PASS	-----
15.407(b) 15.205(a) 15.209(a)	Radiated Emissions	APPENDIX B APPENDIX C APPENDIX D	PASS	-----
15.407(a) 15.407(e)	Bandwidth	APPENDIX E	PASS	-----
15.407(a)	Maximum Output Power	APPENDIX F	PASS	-----
15.407(a)	Power Spectral Density	APPENDIX G	PASS	-----
15.407(g)	Frequency Stability	APPENDIX H	PASS	NOTE (5)
15.203	Antenna Requirements	-----	PASS	NOTE (2)
15.407(c)	Automatically Discontinue Transmission	-----	PASS	NOTE (3)

Note:

- (1) "N/A" denotes test is not applicable in this test report.
- (2) The device what use a permanently attached antenna were considered sufficient to comply with the provisions of 15.203.
- (3) During no any information transmission, the EUT can automatically discontinue transmission and become standby mode for power saving. the EUT can detect the controlling signal of ACK message transmitting from remote device and verify whether it shall resend or discontinue transmission.
- (4) For UNII-1 this device was functioned as a
 - Outdoor access point device
 - Indoor access point device
 - Fixed point-to-point access points device
 - Client device
- (5) The manufacturer states that the frequency sability is in compliance with 15.407(g).

1.1 TEST FACILITY

Company:	Beijing TIRT Technology Service Co.,Ltd Shenzhen
Address:	101, 3 # Factory Building, Gongjin Electronics Shatin Community, Kengzi Street, Pingshan District, Shenzhen, China
CNAS Registration Number:	CNAS L14158
A2LA Registration Number:	6049.01
FCC Accredited Lab. Designation Number:	CN1309
FCC Test Firm Registration Number:	825524
Telephone:	+86-0755-27087573

1.2 MEASUREMENT UNCERTAINTY

ISO/IEC 17025 requires that an estimate of the measurement uncertainties associated with the emissions test results be included in the report. The measurement uncertainties given below are based on a 95% confidence level (based on a coverage factor (k=2))

The TIRT measurement uncertainty as below table:

Uncertainty	
Parameter	Uncertainty
Occupied Channel Bandwidth	±142.12 KHz
RF power conducted	±0.74 dB
RF power radiated	±3.25dB
Spurious emissions, conducted	±1.78dB
Spurious emissions, radiated (30MHz~1GHz)	±4.6dB
Spurious emissions, radiated (1GHz ~ 18GHz)	±4.9dB
Conduction Emissions(150kHz~30MHz)	±3.1 dB
Humidity	±4.6%
Temperature	±0.7°C
Time	±1.25%

Note: Unless specifically mentioned, the uncertainty of measurement has not been taken into account to declare the compliance or non-compliance to the specification.

1.3 TEST ENVIRONMENT CONDITIONS

Test Item	Temperature	Humidity	Test Voltage	Tested By
AC Power Line Conducted Emissions	25°C	53%	AC 120V/60Hz	Stone Tang
Radiated Emissions-9kHz to 30MHz	24°C	51%	AC 120V/60Hz	Stone Tang
Radiated Emissions-30MHz to 1000MHz	24°C	51%	AC 120V/60Hz	Stone Tang
Radiated Emissions-Above 1000 MHz	24°C	51%	AC 120V/60Hz	Stone Tang
Bandwidth	24.5°C	52%	AC 120V/60Hz	Stone Tang
Maximum Output Power	24.5°C	52%	AC 120V/60Hz	Stone Tang
Power Spectral Density	24.5°C	52%	AC 120V/60Hz	Stone Tang

2. GENERAL INFORMATION

2.1 GENERAL DESCRIPTION OF EUT

Equipment	Wi-Fi&Bluetooth Module
Brand Name	Yealink
Test Model	YL43456
Series Model	N/A
Model Difference(s)	N/A
Software Version	N/A
Hardware Version	N/A
Power Source	DC voltage supplied from host system.
Power Rating	DC 3.6V
Operation Frequency Band(s)	UNII-1: 5150 MHz ~ 5250 MHz UNII-2A: 5250 MHz ~ 5350 MHz UNII-2C: 5470 MHz ~ 5725 MHz UNII-3: 5725 MHz ~ 5850 MHz
Modulation Type	IEEE 802.11a/n/ac: OFDM
Bit Rate of Transmitter	IEEE 802.11a: 54/48/36/24/18/12/9/6 Mbps IEEE 802.11n: up to 300 Mbps IEEE 802.11ac: up to 866.7 Mbps
Maximum Output Power _UNII-1	IEEE 802.11a: 15.76 dBm (0.0377 W)
Maximum Output Power _UNII-2A	IEEE 802.11a: 16.12 dBm (0.0409 W)
Maximum Output Power _UNII-2C	IEEE 802.11a: 16.28 dBm (0.0425 W)
Maximum Output Power _UNII-3	IEEE 802.11a: 15.93 dBm (0.0392 W)

Note:

1. For a more detailed features description, please refer to the manufacturer's specifications or the user's manual.

2. Channel List:

IEEE 802.11a IEEE 802.11n(HT20) IEEE 802.11ac(VHT20)		IEEE 802.11n(HT40) IEEE 802.11ac(VHT40)		IEEE 802.11ac(VHT80)	
UNII-1		UNII-1		UNII-1	
Channel	Frequency (MHz)	Channel	Frequency (MHz)	Channel	Frequency (MHz)
36	5180	38	5190	42	5210
40	5200	46	5230		
44	5220				
48	5240				

IEEE 802.11a IEEE 802.11n(HT20) IEEE 802.11ac(VHT20)		IEEE 802.11n(HT40) IEEE 802.11ac(VHT40)		IEEE 802.11ac(VHT80)	
UNII-2A		UNII-2A		UNII-2A	
Channel	Frequency (MHz)	Channel	Frequency (MHz)	Channel	Frequency (MHz)
52	5260	54	5270	58	5290
56	5280	62	5310		
60	5300				
64	5320				

IEEE 802.11a IEEE 802.11n(HT20) IEEE 802.11ac(VHT20)		IEEE 802.11n(HT40) IEEE 802.11ac(VHT40)		IEEE 802.11ac(VHT80)	
UNII-2C		UNII-2C		UNII-2C	
Channel	Frequency (MHz)	Channel	Frequency (MHz)	Channel	Frequency (MHz)
100	5500	102	5510	106	5530
104	5520	110	5550	122	5610
108	5540	118	5590		
112	5560	126	5630		
116	5580	134	5670		
120	5600				
124	5620				
128	5640				
132	5660				
136	5680				
140	5700				

IEEE 802.11a IEEE 802.11n(HT20) IEEE 802.11ac(VHT20)		IEEE 802.11n(HT40) IEEE 802.11ac(VHT40)		IEEE 802.11ac(VHT80)	
UNII-3		UNII-3		UNII-3	
Channel	Frequency (MHz)	Channel	Frequency (MHz)	Channel	Frequency (MHz)
149	5745	151	5755	155	5775
153	5765	159	5795		
157	5785				
161	5805				
165	5825				

3. Antenna Specification:

Ant.	Brand	Model Name	Antenna Type	Connector	Gain (dBi)
1	N/A	N/A	FPC	N/A	3.0

Note:

- 1) The antenna gain is provided by the manufacturer.
- 2) The antenna is for testing purposes only.

2.2 TEST MODES

The test system was pre-tested based on the consideration of all possible combinations of EUT operation mode.

Pretest Mode	Description
Mode 1	TX A Mode Channel 36/40/48 (UNII-1)
Mode 2	TX N(HT20) Mode Channel 36/40/48 (UNII-1)
Mode 3	TX N(HT40) Mode Channel 38/46 (UNII-1)
Mode 4	TX AC(VHT20) Mode Channel 36/40/48 (UNII-1)
Mode 5	TX AC(VHT40) Mode Channel 38/46 (UNII-1)
Mode 6	TX AC(VHT80) Mode Channel 42 (UNII-1)
Mode 7	TX A Mode Channel 52/60/64 (UNII-2A)
Mode 8	TX N(HT20) Mode Channel 52/60/64 (UNII-2A)
Mode 9	TX N(HT40) Mode Channel 54/62 (UNII-2A)
Mode 10	TX AC(VHT20) Mode Channel 52/60/64 (UNII-2A)
Mode 11	TX AC(VHT40) Mode Channel 54/62 (UNII-2A)
Mode 12	TX AC(VHT80) Mode Channel 58 (UNII-2A)
Mode 13	TX A Mode Channel 100/116/140 (UNII-2C)
Mode 14	TX N(HT20) Mode Channel 100/116/140 (UNII-2C)
Mode 15	TX N(HT40) Mode Channel 102/110/134 (UNII-2C)
Mode 16	TX AC(VHT20) Mode Channel 100/116/140 (UNII-2C)
Mode 17	TX AC(VHT40) Mode Channel 102/110/134 (UNII-2C)
Mode 18	TX AC(VHT80) Mode Channel 106/122 (UNII-2C)
Mode 19	TX A Mode Channel 149/157/165 (UNII-3)
Mode 20	TX N(HT20) Mode Channel 149/157/165 (UNII-3)
Mode 21	TX N(HT40) Mode Channel 151/159 (UNII-3)
Mode 22	TX AC(VHT20) Mode Channel 149/157/165 (UNII-3)
Mode 23	TX AC(VHT40) Mode Channel 151/159 (UNII-3)
Mode 24	TX AC(VHT80) Mode Channel 155 (UNII-3)
Mode 25	TX A Mode Channel 100 (UNII-1)

Following mode(s) was (were) found to be the worst case(s) and selected for the final test.

AC power line conducted emissions test	
Final Test Mode	Description
Mode 25	TX A Mode Channel 100 (UNII-1)

Radiated Emissions Test - Below 1GHz	
Final Test Mode	Description
Mode 25	TX A Mode Channel 100 (UNII-1)

Radiated Emissions Test - Above 1GHz	
Final Test Mode	Description
Mode 1	TX A Mode Channel 36/40/48 (UNII-1)
Mode 2	TX N(HT20) Mode Channel 36/40/48 (UNII-1)
Mode 3	TX N(HT40) Mode Channel 38/46 (UNII-1)
Mode 4	TX AC(VHT20) Mode Channel 36/40/48 (UNII-1)
Mode 5	TX AC(VHT40) Mode Channel 38/46 (UNII-1)
Mode 6	TX AC(VHT80) Mode Channel 42 (UNII-1)
Mode 7	TX A Mode Channel 52/56/64 (UNII-2A)
Mode 8	TX N(HT20) Mode Channel 52/56/64 (UNII-2A)
Mode 9	TX N(HT40) Mode Channel 54/62 (UNII-2A)
Mode 10	TX AC(VHT20) Mode Channel 52/56/64 (UNII-2A)
Mode 11	TX AC(VHT40) Mode Channel 54/62 (UNII-2A)
Mode 12	TX AC(VHT80) Mode Channel 58 (UNII-2A)
Mode 13	TX A Mode Channel 100/116/140 (UNII-2C)
Mode 14	TX N(HT20) Mode Channel 100/116/140 (UNII-2C)
Mode 15	TX N(HT40) Mode Channel 102/110/134 (UNII-2C)
Mode 16	TX AC(VHT20) Mode Channel 100/116/140 (UNII-2C)
Mode 17	TX AC(VHT40) Mode Channel 102/110/134 (UNII-2C)
Mode 18	TX AC(VHT80) Mode Channel 106/122 (UNII-2C)
Mode 19	TX A Mode Channel 149/157/165 (UNII-3)
Mode 20	TX N(HT20) Mode Channel 149/157/165 (UNII-3)
Mode 21	TX N(HT40) Mode Channel 151/159 (UNII-3)
Mode 22	TX AC(VHT20) Mode Channel 149/157/165 (UNII-3)
Mode 23	TX AC(VHT40) Mode Channel 151/159 (UNII-3)
Mode 24	TX AC(VHT80) Mode Channel 155 (UNII-3)

Conducted Test	
Final Test Mode	Description
Mode 1	TX A Mode Channel 36/40/48 (UNII-1)
Mode 2	TX N(HT20) Mode Channel 36/40/48 (UNII-1)
Mode 3	TX N(HT40) Mode Channel 38/46 (UNII-1)
Mode 4	TX AC(VHT20) Mode Channel 36/40/48 (UNII-1)
Mode 5	TX AC(VHT40) Mode Channel 38/46 (UNII-1)
Mode 6	TX AC(VHT80) Mode Channel 42 (UNII-1)
Mode 7	TX A Mode Channel 52/60/64 (UNII-2A)
Mode 8	TX N(HT20) Mode Channel 52/60/64 (UNII-2A)
Mode 9	TX N(HT40) Mode Channel 54/62 (UNII-2A)
Mode 10	TX AC(VHT20) Mode Channel 52/60/64 (UNII-2A)
Mode 11	TX AC(VHT40) Mode Channel 54/62 (UNII-2A)
Mode 12	TX AC(VHT80) Mode Channel 58 (UNII-2A)
Mode 13	TX A Mode Channel 100/116/140 (UNII-2C)
Mode 14	TX N(HT20) Mode Channel 100/116/140 (UNII-2C)
Mode 15	TX N(HT40) Mode Channel 102/110/134 (UNII-2C)
Mode 16	TX AC(VHT20) Mode Channel 100/116/140 (UNII-2C)
Mode 17	TX AC(VHT40) Mode Channel 102/110/134 (UNII-2C)
Mode 18	TX AC(VHT80) Mode Channel 106/122 (UNII-2C)
Mode 19	TX A Mode Channel 149/157/165 (UNII-3)
Mode 20	TX N(HT20) Mode Channel 149/157/165 (UNII-3)
Mode 21	TX N(HT40) Mode Channel 151/159 (UNII-3)
Mode 22	TX AC(VHT20) Mode Channel 149/157/165 (UNII-3)
Mode 23	TX AC(VHT40) Mode Channel 151/159 (UNII-3)
Mode 24	TX AC(VHT80) Mode Channel 155 (UNII-3)

Note:

- (1) For AC power line conducted emissions and radiated emission below 1 GHz test, the TX A Mode Channel 100 (UNII-1) is found to be the worst case and recorded.
- (2) For radiated emission above 1 GHz test, the spurious points of 1GHz~18GHz and 18GHz~40GHz have been pre-tested and in this report only recorded the worst case. The remaining spurious points are all below the limit value of 20dB.
- (3) All the bit rate of transmitter have been tested and found the lowest rate is found to be the worst case and recorded.

2.3 PARAMETERS OF TEST SOFTWARE

UNII-1			
Test Software Version	AuthenticTool_1.2.14.0		
Frequency (MHz)	5180	5200	5240
IEEE 802.11a	16	16	16
IEEE 802.11n(HT20)	16	16	16
IEEE 802.11ac(VHT20)	16	16	16
Frequency (MHz)	5190	5230	
IEEE 802.11n(HT40)	16	16	
IEEE 802.11ac(VHT40)	16	16	
Frequency (MHz)	5210		
IEEE 802.11ac(VHT80)	16		

UNII-2A			
Test Software Version	AuthenticTool_1.2.14.0		
Frequency (MHz)	5260	5300	5320
IEEE 802.11a	16	16	16
IEEE 802.11n(HT20)	16	16	16
IEEE 802.11ac(VHT20)	16	16	16
Frequency (MHz)	5270	5310	
IEEE 802.11n(HT40)	16	16	
IEEE 802.11ac(VHT40)	16	16	
Frequency (MHz)	5290		
IEEE 802.11ac(VHT80)	16		

UNII-2C			
Test Software Version	AuthenticTool_1.2.14.0		
Frequency (MHz)	5500	5580	5700
IEEE 802.11a	16	16	16
IEEE 802.11n(HT20)	16	16	16
IEEE 802.11ac(VHT20)	16	16	16
Frequency (MHz)	5510	5550	5670
IEEE 802.11n(HT40)	16	16	16
IEEE 802.11ac(VHT40)	16	16	16
Frequency (MHz)	5530	5610	
IEEE 802.11ac(VHT80)	16	16	

UNII-3			
Test Software Version	AuthenticTool_1.2.14.0		
Frequency (MHz)	5745	5785	5825
IEEE 802.11a	16	16	16
IEEE 802.11n(HT20)	16	16	16
IEEE 802.11ac(VHT20)	16	16	16
Frequency (MHz)	5755	5795	
IEEE 802.11n(HT40)	16	16	
IEEE 802.11ac(VHT40)	16	16	
Frequency (MHz)	5775		
IEEE 802.11ac(VHT80)	16		

2.4 DUTY CYCLE

If duty cycle is $\geq 98\%$, duty factor is not required.

If duty cycle is $< 98\%$, duty factor shall be considered.

The output power = measured power + duty factor.

The power spectral density = measured power spectral density + duty factor.

TestMode	Antenna	Frequency[MHz]	Transmission Duration [ms]	Transmission Period [ms]	Duty Cycle [%]
11A	Ant1	5180	1.40	1.50	93.33
11N20SISO	Ant1	5180	1.34	1.44	93.06
11N40SISO	Ant1	5190	0.65	0.75	86.67
11AC20SISO	Ant1	5180	1.32	1.42	92.96
11AC40SISO	Ant1	5190	0.65	0.75	86.67
11AC80SISO	Ant1	5210	0.32	0.43	60.38

Test Graphs

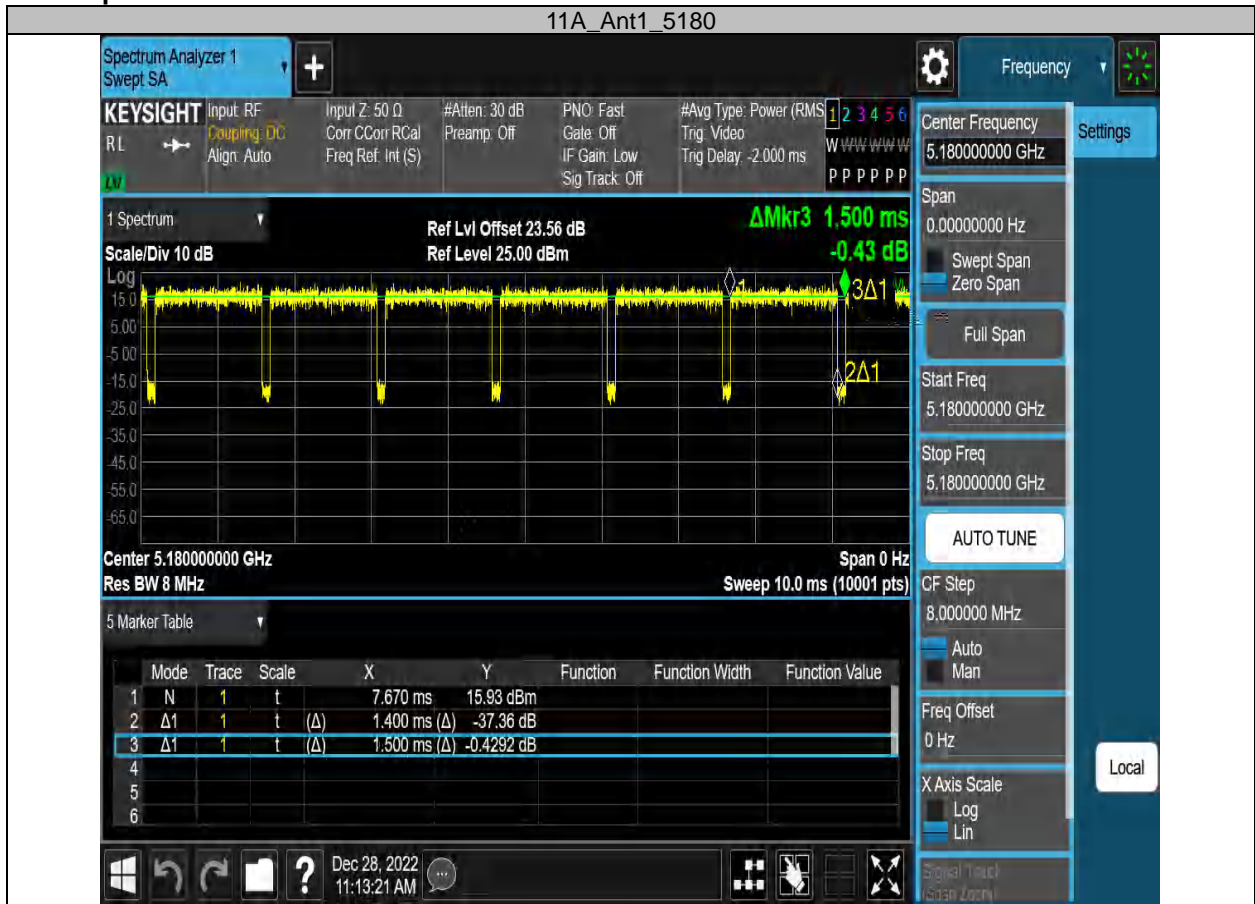

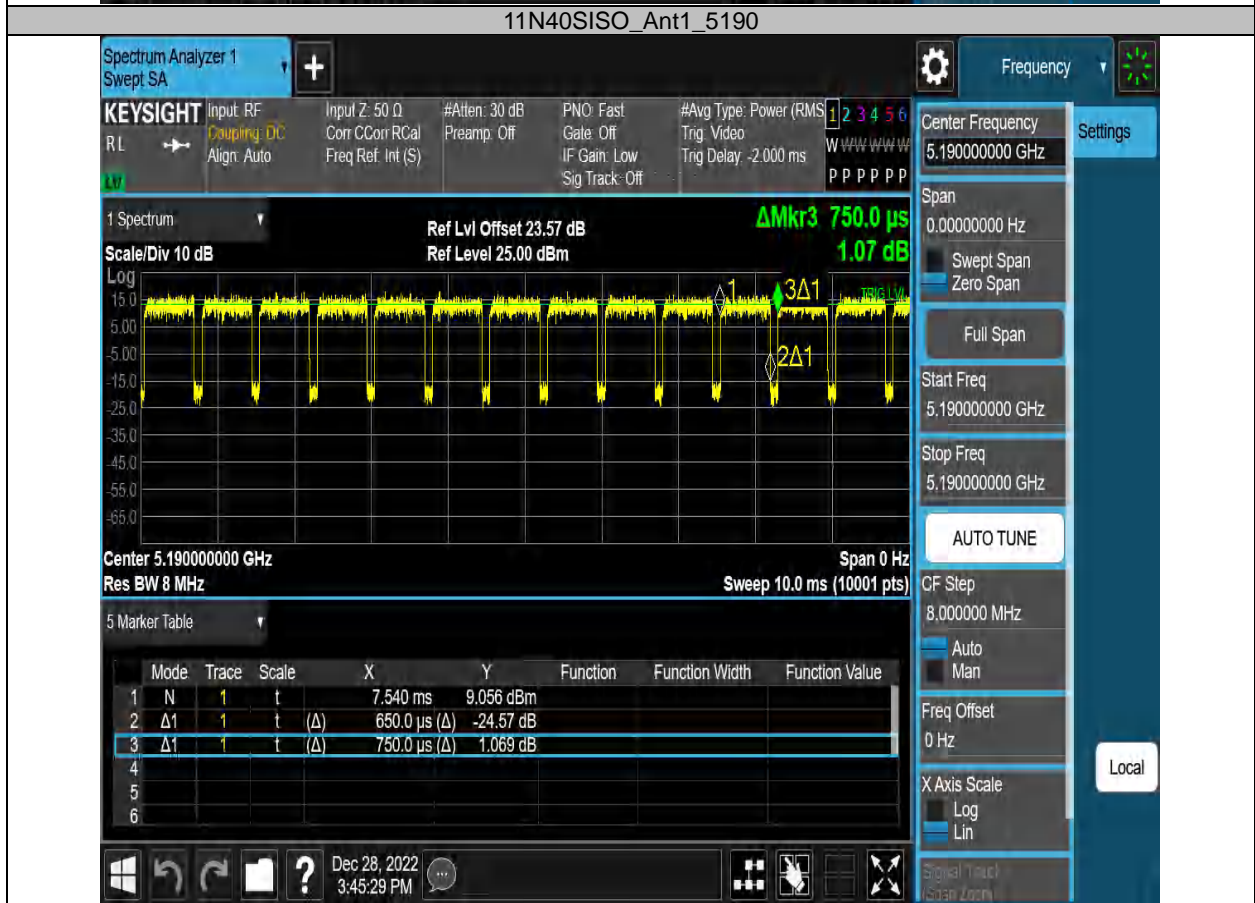

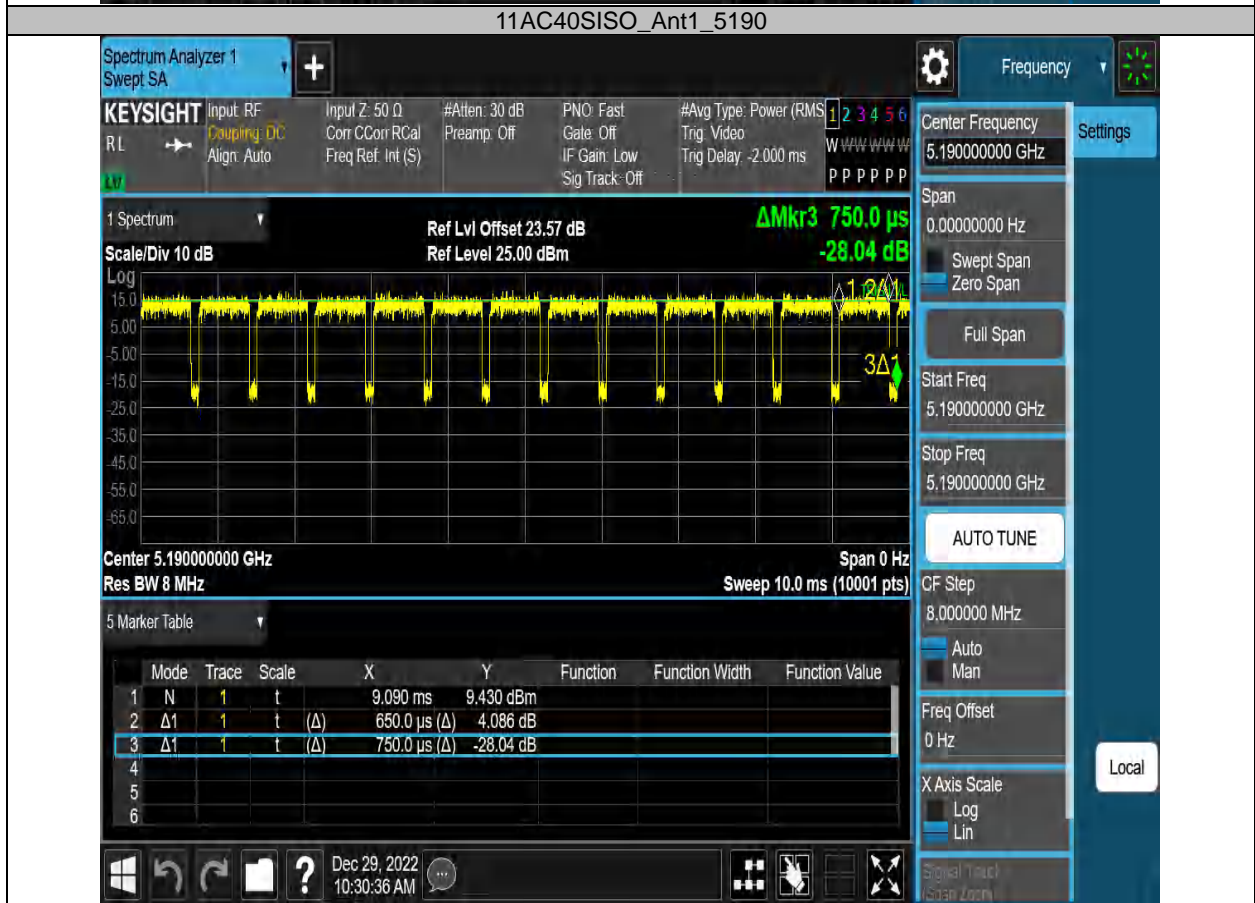
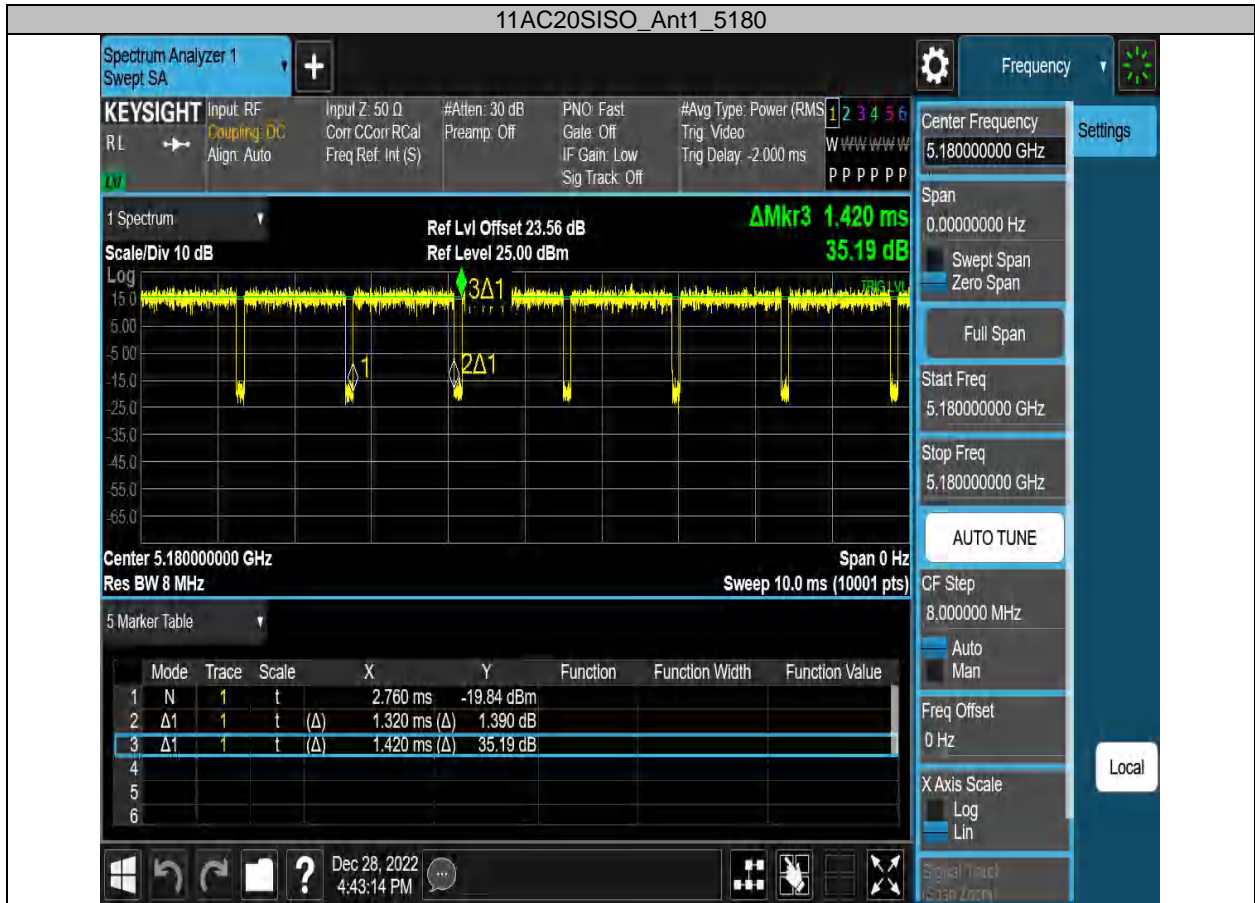

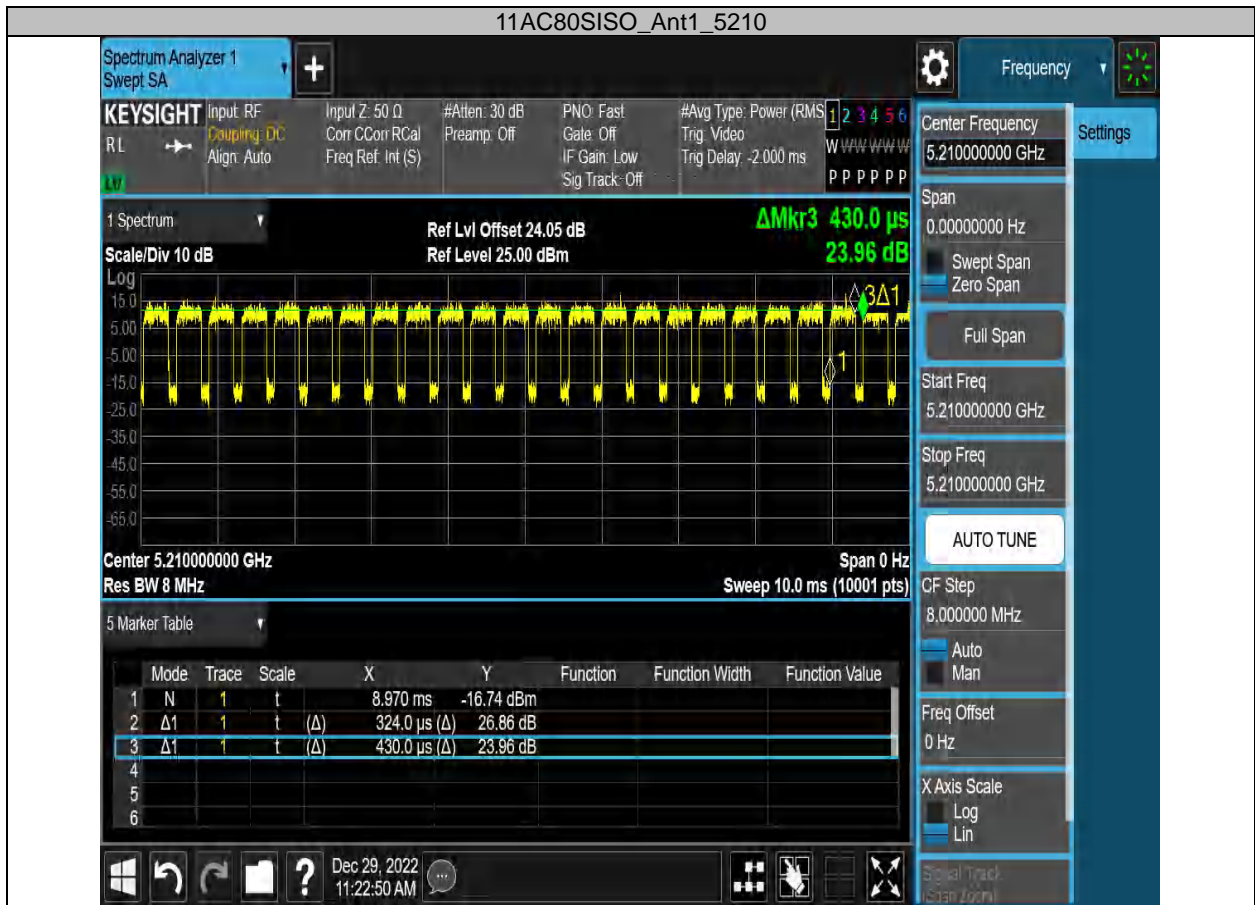

NOTE:

For IEEE 802.11a:

For radiated emissions frequency above 1 GHz, the resolution bandwidth of test receiver/spectrum analyzer is 1 MHz and the video bandwidth is 714Hz.

For IEEE 802.11n(HT20):

For radiated emissions frequency above 1 GHz, the resolution bandwidth of test receiver/spectrum analyzer is 1 MHz and the video bandwidth is 746Hz.

For IEEE 802.11n(HT40):

For radiated emissions frequency above 1 GHz, the resolution bandwidth of test receiver/spectrum analyzer is 1 MHz and the video bandwidth is 1538Hz

For IEEE 802.11ac(VHT20):

For radiated emissions frequency above 1 GHz, the resolution bandwidth of test receiver/spectrum analyzer is 1 MHz and the video bandwidth is 758Hz.

For IEEE 802.11ac(VHT40):

For radiated emissions frequency above 1 GHz, the resolution bandwidth of test receiver/spectrum analyzer is 1 MHz and the video bandwidth is 1538Hz.

For IEEE 802.11ac(VHT80):

For radiated emissions frequency above 1 GHz, the resolution bandwidth of test receiver/spectrum analyzer is 1 MHz and the video bandwidth is 3125Hz.

2.5 BLOCK DIAGRAM SHOWING THE CONFIGURATION OF SYSTEM TESTED

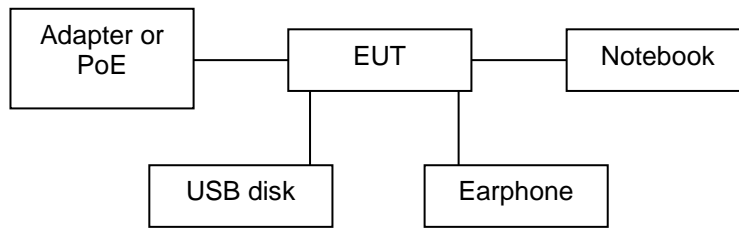

2.6 SUPPORT UNITS

Support Equipment				
No.	Equipment	Brand Name	Model Name	Remarks
1	Notebook	L450	Think	/
2	Earphone	/	/	/
3	USB disk	Kingston	/	/
4	Lan Cable	/	/	10m,Unshielding

3. AC POWER LINE CONDUCTED EMISSIONS

3.1 LIMIT

Frequency (MHz)	Limit (dB μ V)	
	Quasi-peak	Average
0.15 - 0.5	66 to 56*	56 to 46*
0.5 - 5.0	56	46
5.0 - 30.0	60	50

NOTE:

- (1) The tighter limit applies at the band edges.
- (2) The limit of " * " marked band means the limitation decreases linearly with the logarithm of the frequency in the range.

3.2 TEST PROCEDURE

- a. The EUT was placed 0.8 meters from the horizontal ground plane with EUT being connected to the power mains through a line impedance stabilization network (LISN). All other support equipment powered from additional LISN(s). The LISN provide 50 Ohm/ 50uH of coupling impedance for the measuring instrument.
- b. Interconnecting cables that hang closer than 40 cm to the ground plane shall be folded back and forth in the center forming a bundle 30 to 40 cm long.
- c. I/O cables that are not connected to a peripheral shall be bundled in the center. The end of the cable may be terminated, if required, using the correct terminating impedance. The overall length shall not exceed 1 m.
- d. LISN at least 80 cm from nearest part of EUT chassis.
- e. For the actual test configuration, please refer to the related Item -EUT Test Photos.

The following table is the setting of the receiver:

Receiver Parameter	Setting
Start Frequency	0.15 MHz
Stop Frequency	30 MHz
IF Bandwidth	9 kHz

3.3 DEVIATION FROM TEST STANDARD

No deviation

3.4 TEST SETUP

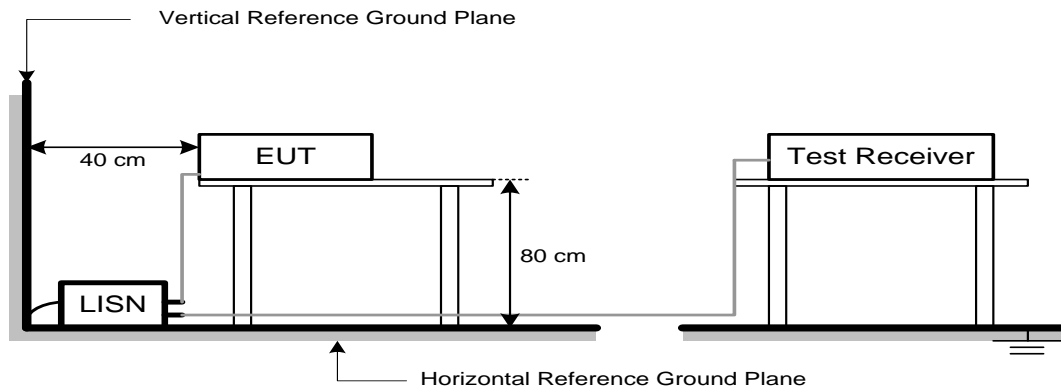

3.5 EUT OPERATION CONDITIONS

The EUT was configured for testing in a typical fashion (as a customer would normally use it). The EUT has been programmed to continuously transmit during test. This operating condition was tested and used to collect the included data.

The EUT was programmed to be in continuously transmitting/TX mode.

3.6 TEST RESULTS

Please refer to the APPENDIX A.

4. RADIATED EMISSIONS

4.1 LIMIT

In case the emission fall within the restricted band specified on 15.205(a), then the 15.209(a) limit in the table below has to be followed.

LIMITS OF RADIATED EMISSIONS MEASUREMENT (9 kHz to 1000 MHz)

Frequency (MHz)	Field Strength (microvolts/meter)	Measurement Distance (meters)
0.009-0.490	2400/F(kHz)	300
0.490-1.705	24000/F(kHz)	30
1.705-30.0	30	30
30-88	100	3
88-216	150	3
216-960	200	3
Above 960	500	3

LIMITS OF UNWANTED EMISSION OUT OF THE RESTRICTED BANDS (Above 1000 MHz)

Frequency (MHz)	EIRP Limit (dBm/MHz)	Equivalent Field Strength at 3m (dBμV/m)
5150-5250	-27	68.2
5250-5350	-27	68.2
5470-5725	-27	68.2
5725-5850 NOTE (2)	-27	68.2
	10	105.2
	15.6	110.8
	27	122.2

NOTE:

(1) The following formula is used to convert the equipment isotropic radiated power (eirp) to field strength:

$$E = \frac{1000000\sqrt{30P}}{3} \mu\text{V/m, where P is the eirp (Watts)}$$

(2) According to 15.407(b)(4)(i), all emissions shall be limited to a level of -27 dBm/MHz at 75 MHz or more above or below the band edge increasing linearly to 10 dBm/MHz at 25 MHz above or below the band edge, and from 25 MHz above or below the band edge increasing linearly to a level of 15.6 dBm/MHz at 5 MHz above or below the band edge, and from 5 MHz above or below the band edge increasing linearly to a level of 27 dBm/MHz at the band edge.

4.2 TEST PROCEDURE

- The measuring distance of 3 m shall be used for measurements. The EUT was placed on the top of a rotating table 0.8 meter above the ground at a 3 meter semi-anechoic chamber. The table was rotated 360 degrees to determine the position of the highest radiation.(below 1GHz)
- The measuring distance of 3 m shall be used for measurements. The EUT was placed on the top of a rotating table 1.5 meter above the ground at a 3 meter semi-anechoic chamber. The table was rotated 360 degrees to determine the position of the highest radiation.(above 1GHz)
- The height of the equipment or of the substitution antenna shall be 0.8m or 1.5m; the height of the test antenna shall vary between 1 m to 4 m. Both horizontal and vertical polarizations of the antenna are set to make the measurement.
- For each suspected emission, the EUT was arranged to its worst case and then the antenna was tuned to heights find the maximum reading (used Bore sight function).
- The receiver system was set to peak and average detect function and specified bandwidth with maximum hold mode when the test frequency is above 1 GHz.

- f. The initial step in collecting radiated emission data is a receiver peak detector mode pre-scanning the measurement frequency range. Significant peaks are then marked and then Quasi Peak detector mode re-measured.
- g. All readings are Peak unless otherwise stated QP in column of Note. Peak denotes that the Peak reading compliance with the QP Limits and then QP Mode measurement didn't perform. (below 1 GHz)
- h. All readings are Peak Mode value unless otherwise stated AVG in column of Note. If the Peak Mode Measured value compliance with the Peak Limits and lower than AVG Limits, the EUT shall be deemed to meet both Peak & AVG Limits and then only Peak Mode was measured, but AVG Mode didn't perform. (above 1 GHz)
- i. For the actual test configuration, please refer to the related Item –EUT Test Photos.

The following table is the setting of the receiver:

Spectrum Parameters	Setting
Start ~ Stop Frequency	9 kHz~150 kHz for RBW 200 Hz
Start ~ Stop Frequency	0.15 MHz~30 MHz for RBW 9 kHz
Start ~ Stop Frequency	30 MHz~1000 MHz for RBW 100 kHz

Spectrum Parameters	Setting
Start Frequency	1000 MHz
Stop Frequency	10th carrier harmonic or 40 GHz, whichever is lower
RBW / VBW (Emission in restricted band)	1 MHz / 3 MHz for PK value 1 MHz / 1/T Hz for AVG value

Receiver Parameters	Setting
Start ~ Stop Frequency	9 kHz~90 kHz for PK/AVG detector
Start ~ Stop Frequency	90 kHz~110 kHz for QP detector
Start ~ Stop Frequency	110 kHz~490 kHz for PK/AVG detector
Start ~ Stop Frequency	490 kHz~30 MHz for QP detector
Start ~ Stop Frequency	30 MHz~1000 MHz for QP detector
Start ~ Stop Frequency	1 GHz~40 GHz for PK/AVG detector

4.3 DEVIATION FROM TEST STANDARD

No deviation.

4.4 TEST SETUP

9 kHz to 30 MHz

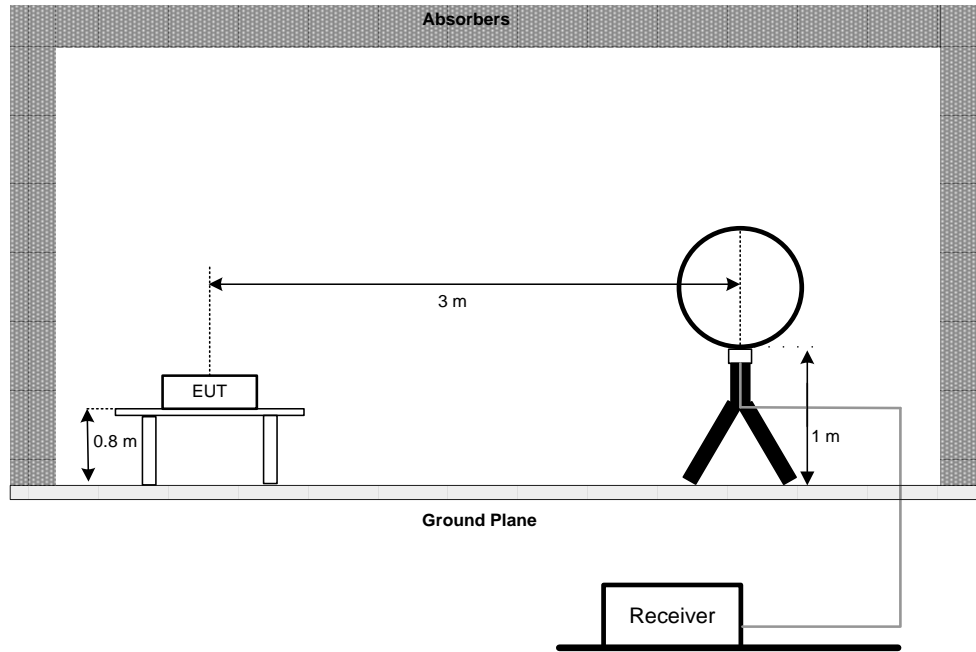

30 MHz to 1 GHz

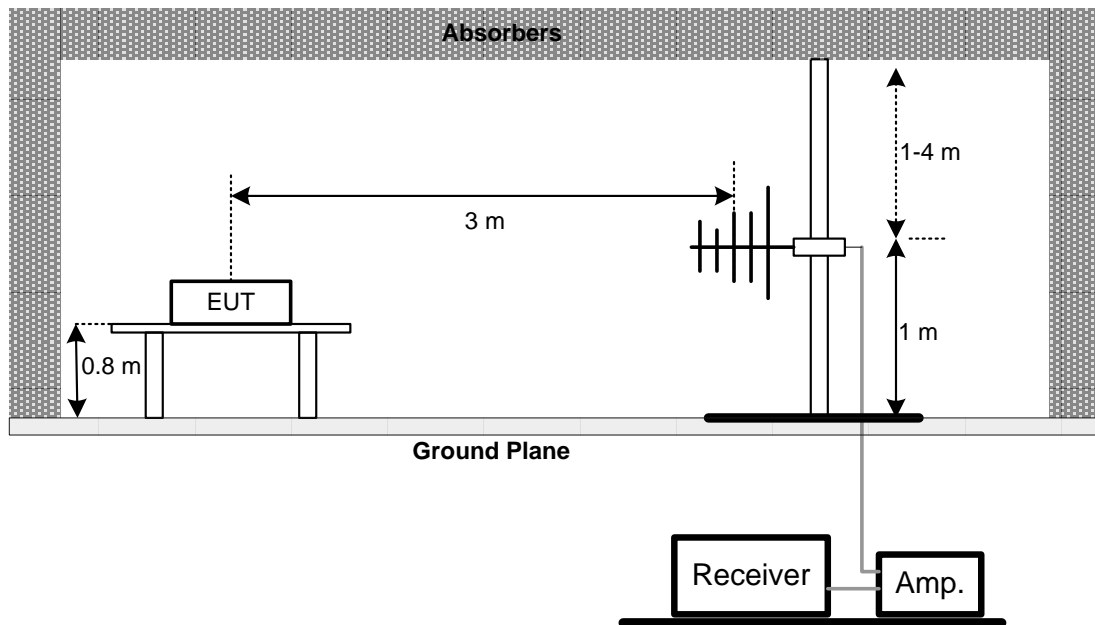

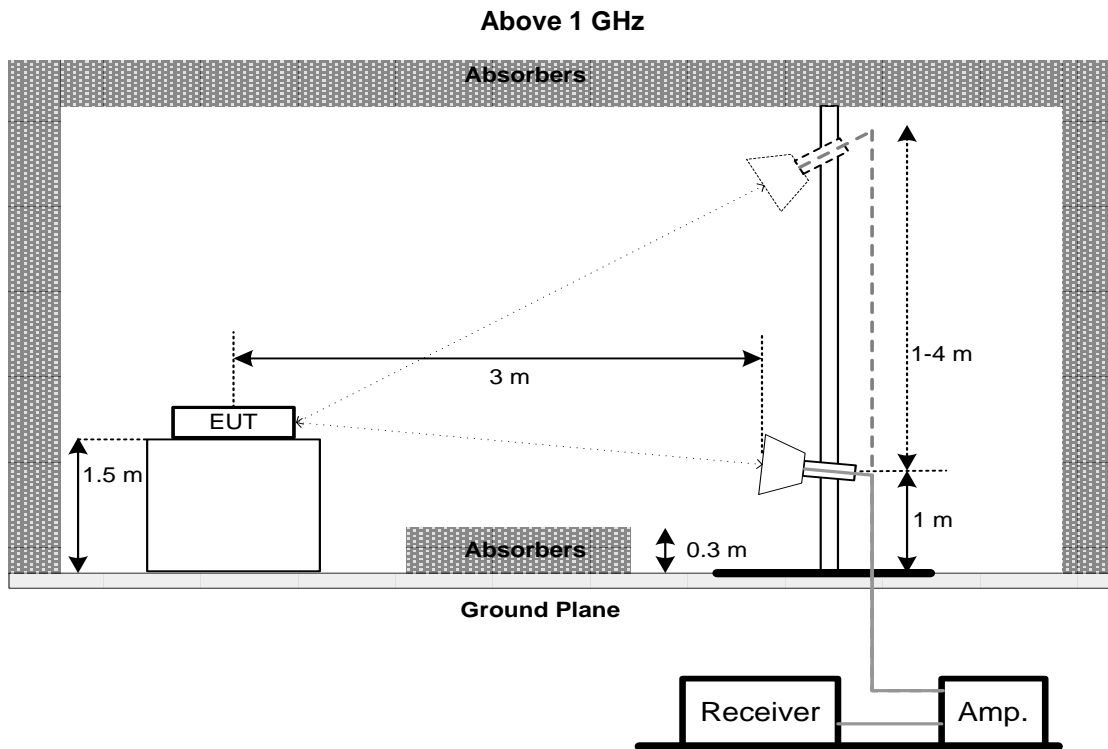

4.5 EUT OPERATION CONDITIONS

The EUT tested system was configured as the statements of 3.5 unless otherwise a special operating condition is specified in the follows during the testing.

4.6 TEST RESULTS - 9 KHZ TO 30 MHZ

Please refer to the APPENDIX B.

Remark:

- (1) Distance extrapolation factor = $40 \log (\text{specific distance} / \text{test distance})$ (dB).
- (2) Limit line = specific limits (dBuV) + distance extrapolation factor.

4.7 TEST RESULTS - 30 MHZ TO 1000 MHZ

Please refer to the APPENDIX C.

4.8 TEST RESULTS - ABOVE 1000 MHZ

Please refer to the APPENDIX D.

Remark:

- (1) No limit: This is fundamental signal, the judgment is not applicable.
For fundamental signal judgment was referred to Peak output test.

5. BANDWIDTH

5.1 LIMIT

Section	Test Item	Limit	Frequency Range (MHz)
FCC 15.407(a) FCC 15.407(e)	26 dB Bandwidth	-	5150-5250
	26 dB Bandwidth	-	5250-5350
	26 dB Bandwidth	-	5470-5725
	6 dB Bandwidth	Minimum 500 kHz	5725-5850

5.2 TEST PROCEDURE

a. The EUT was directly connected to the tonscend test system and antenna output port as show in the block diagram below.

b. Spectrum Setting:

For UNII-1, UNII-2A, UNII-2C:

Spectrum Parameter	Setting
Span Frequency	> 26 dB Bandwidth
RBW	Appromiximately 1% of the emission bandwidth
VBW	> RBW
Detector	Peak
Trace	Max Hold
Sweep Time	Auto

For UNII-3:

Spectrum Parameter	Setting
Span Frequency	> 6 dB Bandwidth
RBW	100 kHz
VBW	300 kHz
Detector	Peak
Trace	Max Hold
Sweep Time	Auto

For 99% Occupied Bandwidth:

Spectrum Parameter	Setting
Span Frequency	1.5 times to 5 times the OBW
RBW	1% to 5% of the OBW
VBW	$\geq 3 \cdot \text{RBW}$
Detector	Peak
Trace	Max Hold
Sweep Time	Auto

c. Measured the spectrum width with power higher than 26 dB / 6 dB below carrier.

5.3 DEVIATION FROM STANDARD

No deviation.

5.4 TEST SETUP

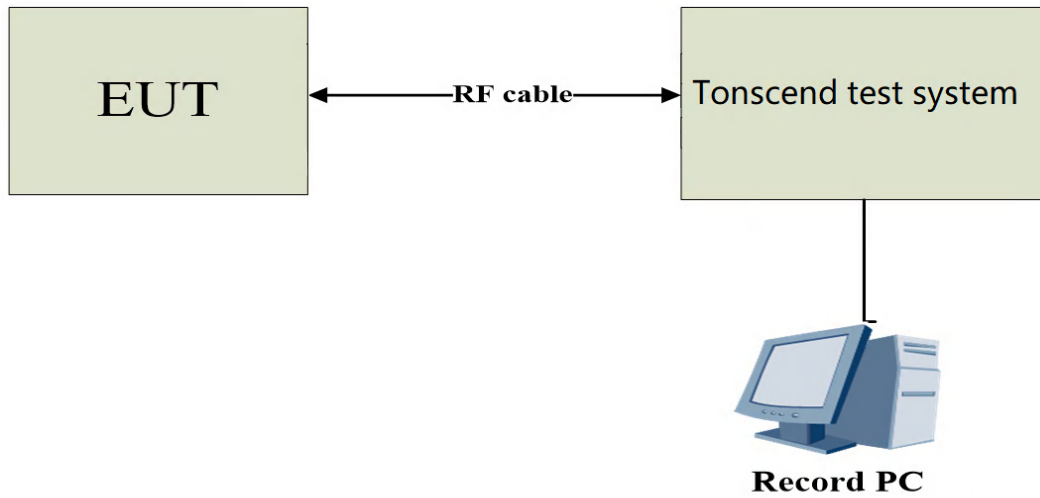

5.5 EUT OPERATION CONDITIONS

The EUT was programmed to be in continuously transmitting mode.

5.6 TEST RESULTS

Please refer to the APPENDIX E.

6. MAXIMUM OUTPUT POWER

6.1 LIMIT

Section	Test Item	Limit	Frequency Range (MHz)
FCC 15.407(a)	Maximum Output Power	AP device: 1 Watt (30 dBm)	5150-5250
		Client device: 250 mW (23.98 dBm)	
		250 mW (23.98 dBm)	5250-5350
		250 mW (23.98 dBm)	5470-5725
		1 Watt (30dBm)	5725-5850

Note:

- a. For client devices in the 5.15-5.25 GHz band, the maximum conducted output power over the frequency band of operation shall not exceed 250 mW provided the maximum antenna gain does not exceed 6 dBi. In addition, the maximum power spectral density shall not exceed 11 dBm in any 1 megahertz band. If transmitting antennas of directional gain greater than 6 dBi are used, both the maximum conducted output power and the maximum power spectral density shall be reduced by the amount in dB that the directional gain of the antenna exceeds 6 dBi.
- b. For the 5.25-5.35 GHz and 5.47-5.725 GHz bands, the maximum conducted output power over the frequency bands of operation shall not exceed the lesser of 250 mW or 11 dBm + 10log B, where B is the 26dB Bandwidth in megahertz.

6.2 TEST PROCEDURE

- a. The EUT was directly connected to the tonscend test system and antenna output port as show in the block diagram below.
- b. The test was performed in accordance with method of FCC KDB 789033 D02 General UNII Test Procedures New Rules v02r01.

6.3 DEVIATION FROM STANDARD

No deviation.

6.4 TEST SETUP

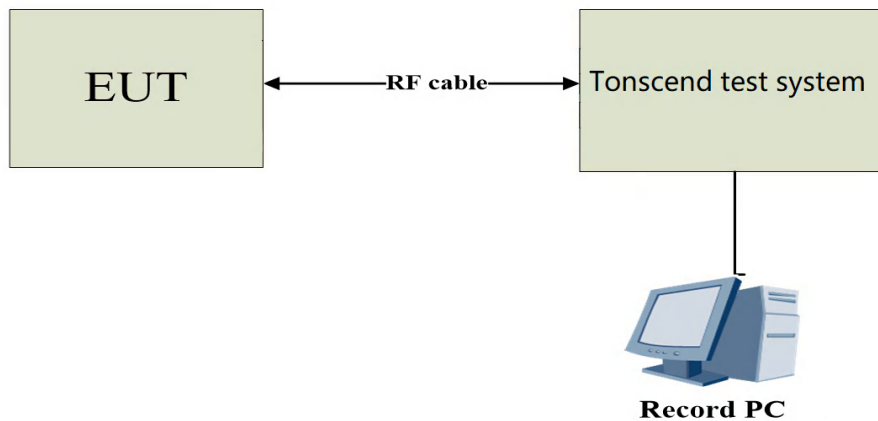

6.5 EUT OPERATION CONDITIONS

The EUT was programmed to be in continuously transmitting mode.

6.6 TEST RESULTS

Please refer to the APPENDIX F.

7. POWER SPECTRAL DENSITY

7.1 LIMIT

Section	Test Item	Limit	Frequency Range (MHz)
FCC 15.407(a)	Power Spectral Density	AP device: 17 dBm/MHz Client device: 11 dBm/MHz	5150-5250
		11 dBm/MHz	5250-5350
		11 dBm/MHz	5470-5725
		30 dBm/500 kHz	5725-5850

7.2 TEST PROCEDURE

- a. The EUT was directly connected to the tonscond test system and antenna output port as show in the block diagram below.
- b. Spectrum Setting:

For UNII-1, UNII-2A, UNII-2C:

Spectrum Parameter	Setting
Span Frequency	Encompass the entire emissions bandwidth (EBW) of the signal
RBW	1 MHz.
VBW	3 MHz.
Detector	RMS
Trace average	100 trace
Sweep Time	Auto

For UNII-3:

Spectrum Parameter	Setting
Span Frequency	Encompass the entire emissions bandwidth (EBW) of the signal
RBW	100 kHz.
VBW	300 kHz.
Detector	RMS
Trace average	100 trace
Sweep Time	Auto

Note:

- For UNII-3, according to KDB publication 789033 D02 General UNII Test Procedures New Rules v02r01, section II.F.5., it is acceptable to set RBW at 300kHz and VBW at 1MHz if the spectrum analyzer does not have 500 kHz RBW. Then, add $10 \log(500 \text{ kHz}/300 \text{ kHz})$ to the measured result, i.e. 2.22 dB.
- During the test of U-NII 3 PSD, the measurement result with RBW=300kHz has been added 2.22 dB by compensating offset.

7.3 DEVIATION FROM STANDARD

No deviation.

7.4 TEST SETUP

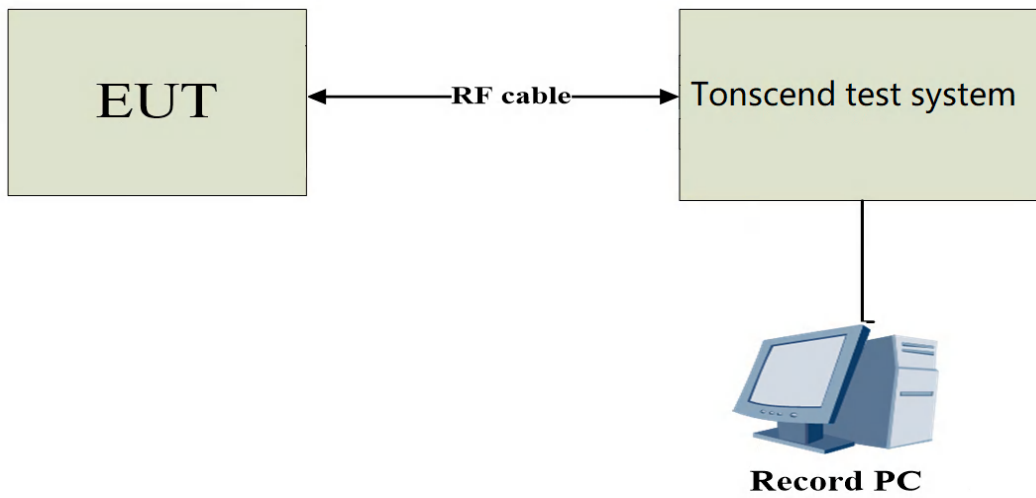

7.5 EUT OPERATION CONDITIONS

The EUT was programmed to be in continuously transmitting mode.

7.6 TEST RESULTS

Please refer to the APPENDIX G.

8. FREQUENCY STABILITY

8.1 LIMIT

Section	Test Item	Limit	Frequency Range (MHz)
FCC 15.407(g)	Frequency Stability	An emission is maintained within the band of operation under all conditions of normal operation as specified in the users manual.	5150-5250
			5250-5350
			5470-5725
			5725-5850

8.2 TEST PROCEDURE

- a. The EUT was directly connected to the tonscond test system and antenna output port as show in the block diagram below.
- b. Spectrum Setting:

Spectrum Parameter	Setting
Span Frequency	Entire absence of modulation emissions bandwidth
RBW	10 kHz
VBW	10 kHz
Detector	Peak
Trace	Max Hold
Sweep Time	Auto

- c. The test extreme voltage is to change the primary supply voltage from 85 to 115 percent of the nominal value.
- d. User manual temperature is -30°C~75°C.

8.3 DEVIATION FROM STANDARD

No deviation.

8.4 TEST SETUP

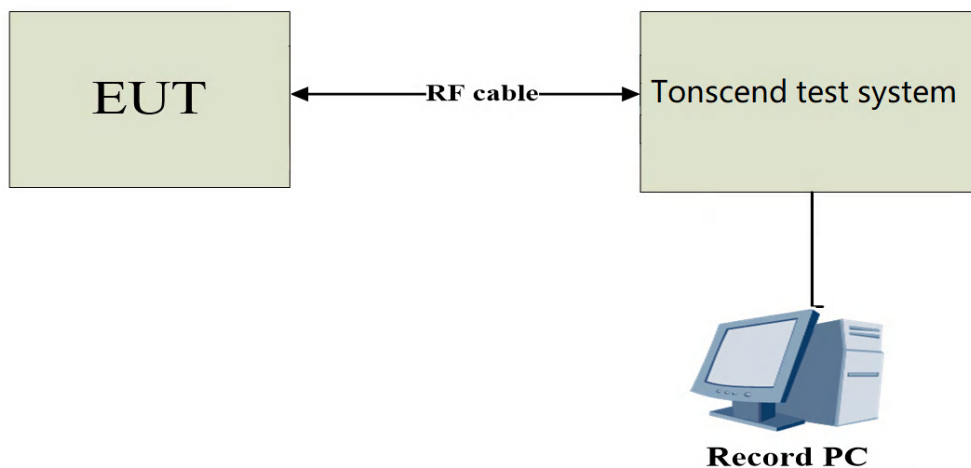

8.5 EUT OPERATION CONDITIONS

The EUT was programmed to be in continuously transmitting mode.

8.6 TEST RESULTS

N/A.

9. MEASUREMENT INSTRUMENTS LIST

No.	Equipment	Manufacturer	Type No.	Serial No.	Calibrated until
1	EMI Receiver	Rohde&Schwarz	ESCI	1166.5950.03	2023/10/14
2	AMN	Rohde&Schwarz	ENV216	3560.6550.05	2023/10/14
3	AMN	Schwarzbeck	NSLK8127	#829	2023/10/14
4	ECSI RF IN RF Cable	Rohde&Schwarz	RP-X1	\	2023/10/14
5	ECSI RF IN RF Cable	Rohde&Schwarz	Sapre sm	\	2023/10/14
6	EMI Receiver	Rohde&Schwarz	ESR7	102013	2023/10/14
7	Spectrum analyzer	Rohde&Schwarz	FSV30	103741	2023/10/17
8	EMI receiver	Rohde&Schwarz	ESU	100184	2023/07/20
9	Spectrum analyzer	KEYSIGHT	N9010A-44	MY51440158	2023/10/17
10	Loop Antenna*	Schwarzbeck	FMZB1519B	00029	2025/07/03
11	Integral Antenna	Schwarzbeck	VULB 9163	VULB 9163-361	2023/10/20
12	Integral Antenna	Schwarzbeck	BBHA 9120D	BBHA 9120D 1201	2023/10/15
13	Integral Antenna	Schwarzbeck	BBHA 9170	9170#685	2023/10/15
14	Preamplifier	CD Systems Inc	PAP-03036-30	85060000	2023/10/15
15	Preamplifier	Schwarzbeck	BBV9721	9721-019	2023/10/15
16	Preamplifier	emci	EMC012645 SE	980417	2023/10/16
17	ECSI RF IN RF Cable	Rohde&Schwarz	AP-X1	\	2023/10/16
18	Spectrum Analyzer	Agilent	N9010A	MY52221119	2023/10/17
19	Power Collection Unit	Tonscend	JS0806-2	188060134	2023/10/16
20	Tonscend Test System	Tonscend	2.6.77.0518	N/A	N/A
21	10dB Attenuator	Tonscend	10dB	N/A	N/A
22	Temp&Humidity Recorder	Anymetre	JR900	N/A	2023/10/16
23	Temp&Humidity Chamber	ETOMA	NTH1100-30 A	16080628	2023/10/16
24	Filter	STI	STI15-9845	N/A	N/A
25	Filter	STI	5.1G	N/A	N/A
26	Filter	STI	STI15-9845	N/A	N/A
27	Testing Software	EZ-EMC	TW-03A2	N/A	N/A

Remark: "N/A" denotes no model name, serial no. or calibration specified.
 "**" calibration period of equipment list is three year.
 Except * item, all calibration period of equipment list is one year.

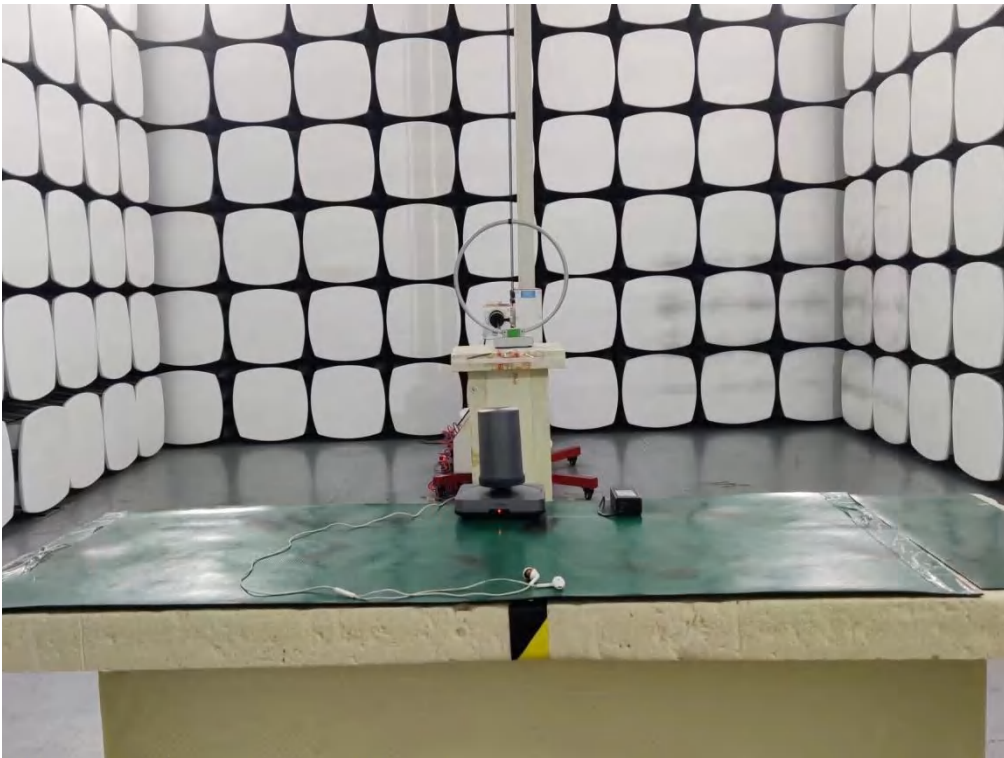
10. EUT TEST PHOTOS**AC Power Line Conducted Emissions Test Photos****Radiated Emissions Test Photos****9 kHz to 30 MHz**

Radiated Emissions Test Photos

30 MHz to 1 GHz

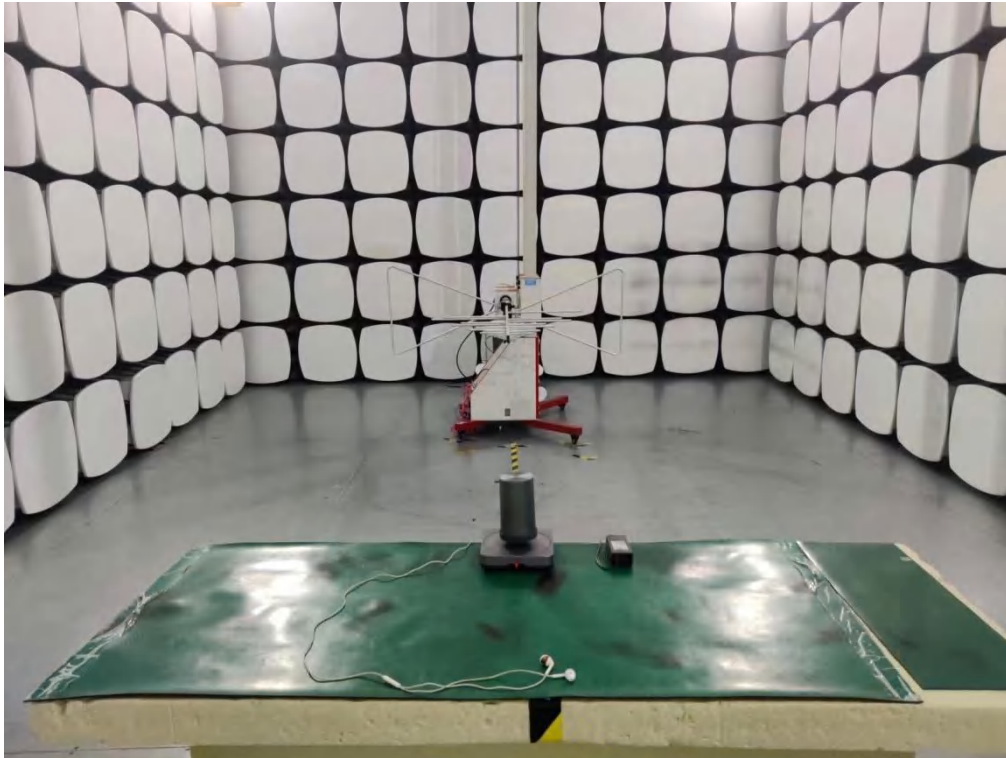

Radiated Emissions Test Photos

Above 1 GHz

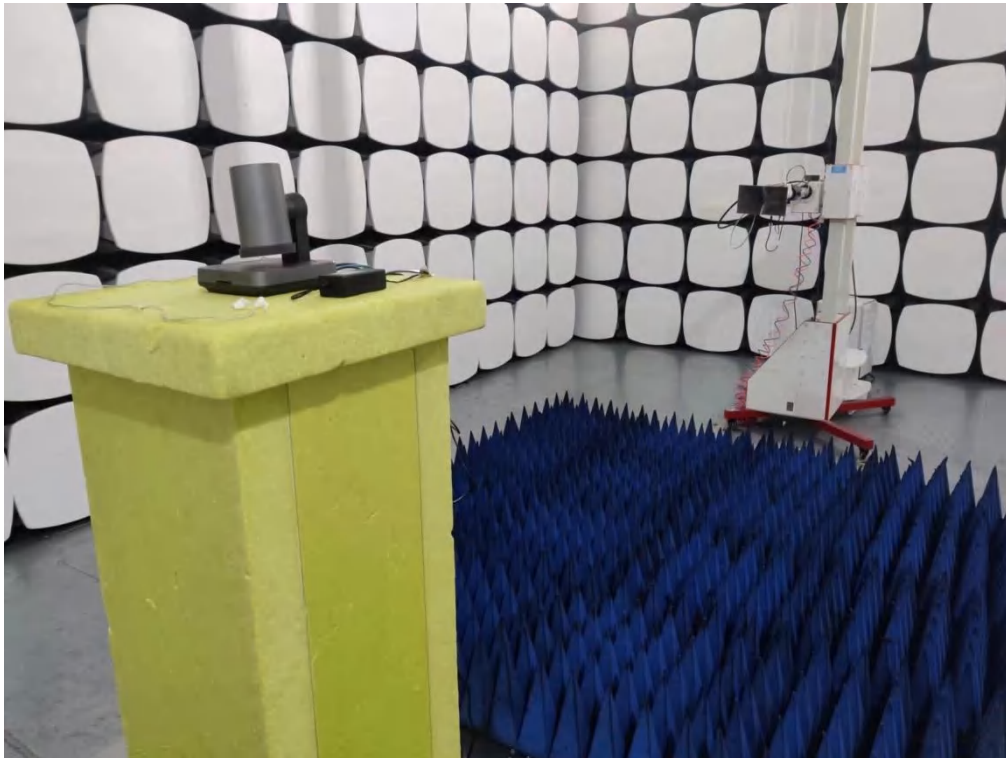

Conducted Test Photos



APPENDIX A - AC POWER LINE CONDUCTED EMISSIONS

Test Mode	TX A Mode Channel 100 (UNII-1)	Phase	Line
-----------	--------------------------------	-------	------

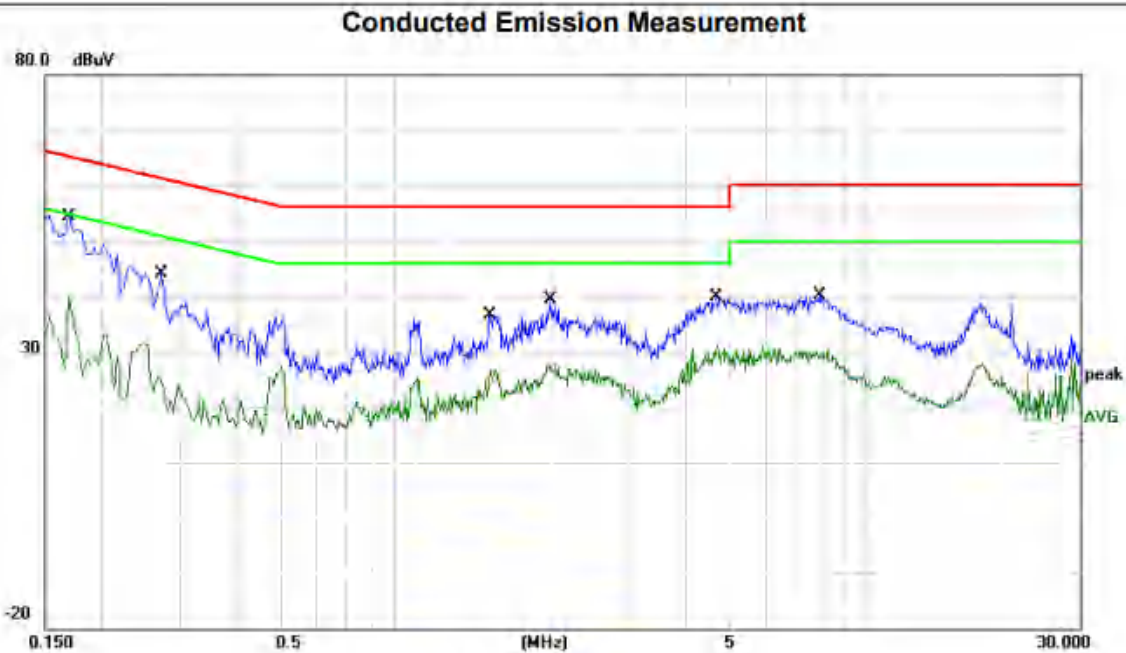

No.	Mk.	Freq.	Reading Level	Correct Factor	Measurement	Limit	Over	Detector	Comment
		MHz	dBuV	dB	dBuV	dBuV	dB		
1	*	0.1700	32.44	19.88	52.32	64.96	-12.64	QP	
2		0.1700	15.69	19.88	35.57	54.96	-19.39	AVG	
3		0.2740	17.71	19.88	37.59	61.00	-23.41	QP	
4		0.2740	3.51	19.88	23.39	51.00	-27.61	AVG	
5		1.4660	11.78	19.90	31.68	56.00	-24.32	QP	
6		1.4660	5.63	19.90	25.53	46.00	-20.47	AVG	
7		2.0060	13.19	19.91	33.10	56.00	-22.90	QP	
8		2.0060	6.99	19.91	26.90	46.00	-19.10	AVG	
9		4.6860	15.82	19.92	35.74	56.00	-20.26	QP	
10		4.6860	8.13	19.92	28.05	46.00	-17.95	AVG	
11		7.8940	15.49	19.94	35.43	60.00	-24.57	QP	
12		7.8940	7.96	19.94	27.90	50.00	-22.10	AVG	

REMARKS:

- (1) Measurement Value = Reading Level + Correct Factor.
- (2) Margin Level = Measurement Value - Limit Value.
- (3) The test result has included the cable loss.

Test Mode	TX A Mode Channel 100 (UNII-1)	Phase	Neutral
-----------	--------------------------------	-------	---------

Conducted Emission Measurement

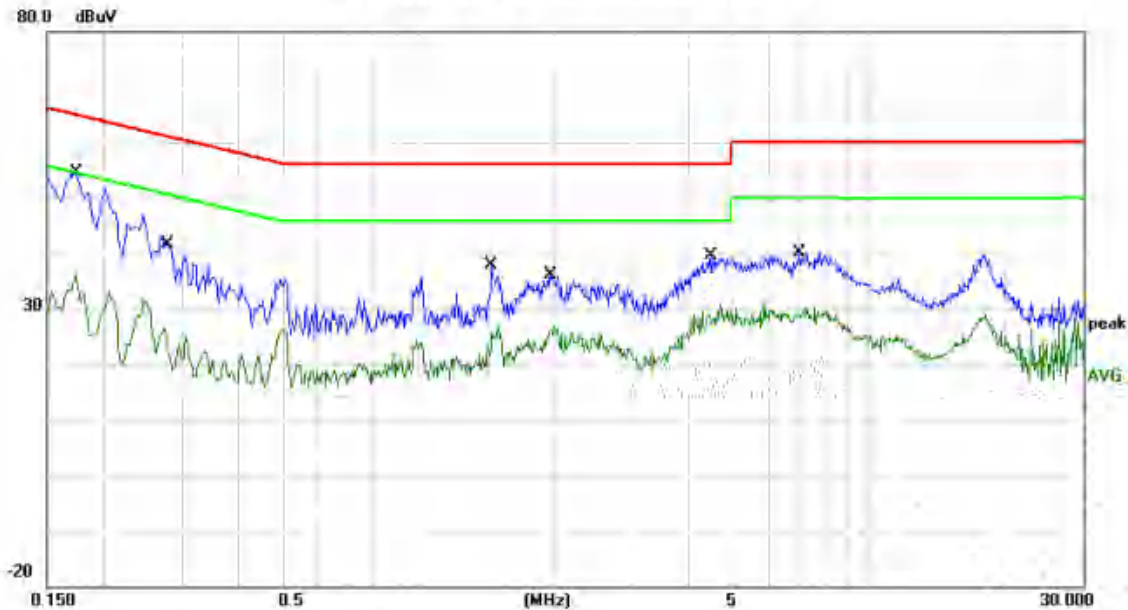

No.	Mk.	Freq.	Reading Level	Correct Factor	Measurement	Limit	Over	Detector	Comment
		MHz	dBuV	dB	dBuV	dBuV	dB		
1	*	0.1740	30.96	19.88	50.84	64.77	-13.93	QP	
2		0.1740	15.63	19.88	35.51	54.77	-19.26	AVG	
3		0.2780	14.88	19.88	34.76	60.88	-26.12	QP	
4		0.2780	0.66	19.88	20.54	50.88	-30.34	AVG	
5		1.4620	12.10	19.90	32.00	56.00	-24.00	QP	
6		1.4620	5.24	19.90	25.14	46.00	-20.86	AVG	
7		1.9700	10.99	19.91	30.90	56.00	-25.10	QP	
8		1.9700	5.42	19.91	25.33	46.00	-20.67	AVG	
9		4.4860	14.67	19.91	34.58	56.00	-21.42	QP	
10		4.4860	6.98	19.91	26.89	46.00	-19.11	AVG	
11		7.0420	14.73	19.93	34.66	60.00	-25.34	QP	
12		7.0420	7.99	19.93	27.92	50.00	-22.08	AVG	

REMARKS:

- (1) Measurement Value = Reading Level + Correct Factor.
- (2) Margin Level = Measurement Value - Limit Value.
- (3) The test result has included the cable loss.

APPENDIX B - RADIATED EMISSION - 9 KHZ TO 30 MHZ

The low frequency, which started from 9 kHz to 30MHz, was pre-scanned and the result which was 20dB lower than the limit line was not reported.

There is a comparison data of both open-field test site and semi-Anechoic chamber, and the result came out very similar.

APPENDIX C - RADIATED EMISSION - 30 MHZ TO 1000 MHZ

Test Mode	TX A Mode Channel 100 (UNII-1)	Polarization	Vertical
-----------	--------------------------------	--------------	----------

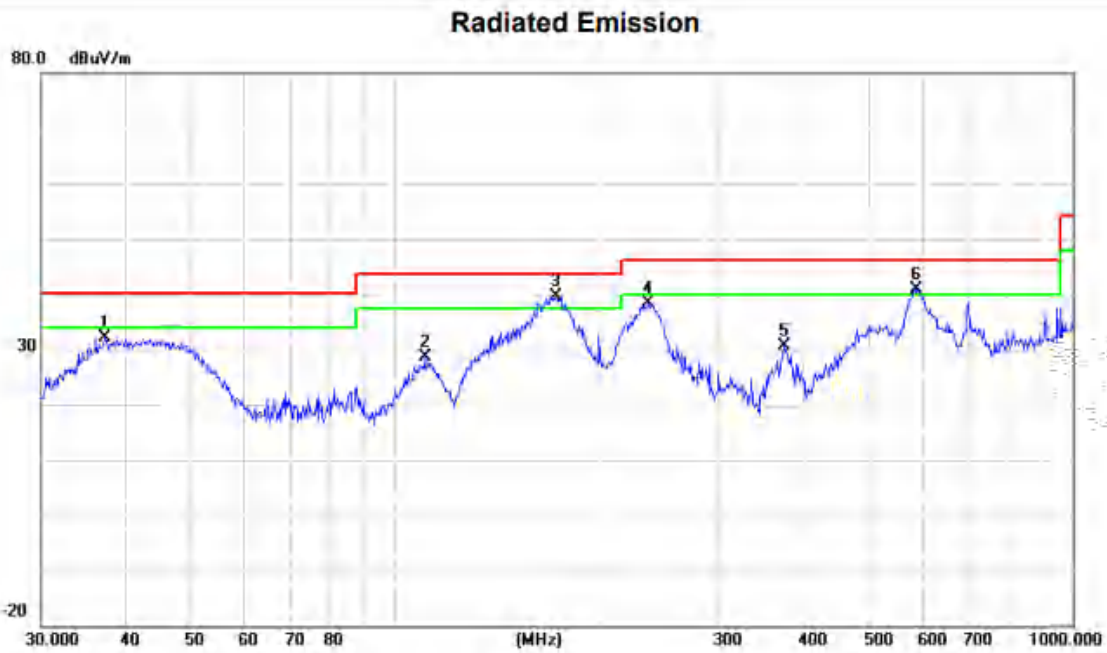

No.	Mk.	Freq.	Reading Level	Correct Factor	Measurement	Limit	Over	Antenna Height	Table Degree	
		MHz	dBuV	dB/m	dBuV/m	dBuV/m	dB	cm	degree	Comment
1		37.2854	42.37	-10.33	32.04	40.00	-7.96			peak
2		110.5686	41.23	-12.65	28.58	43.50	-14.92			peak
3	*	172.5987	50.38	-10.83	39.55	43.50	-3.95			peak
4		236.6447	49.12	-10.85	38.27	46.00	-7.73			peak
5		375.9385	37.47	-6.78	30.69	46.00	-15.31			peak
6	!	588.9050	42.57	-1.57	41.00	46.00	-5.00			peak

REMARKS:

- (1) Measurement Value = Reading Level + Correct Factor.
- (2) Margin Level = Measurement Value - Limit Value.

Test Mode	TX A Mode Channel 100 (UNII-1)	Polarization	Horizontal
-----------	--------------------------------	--------------	------------

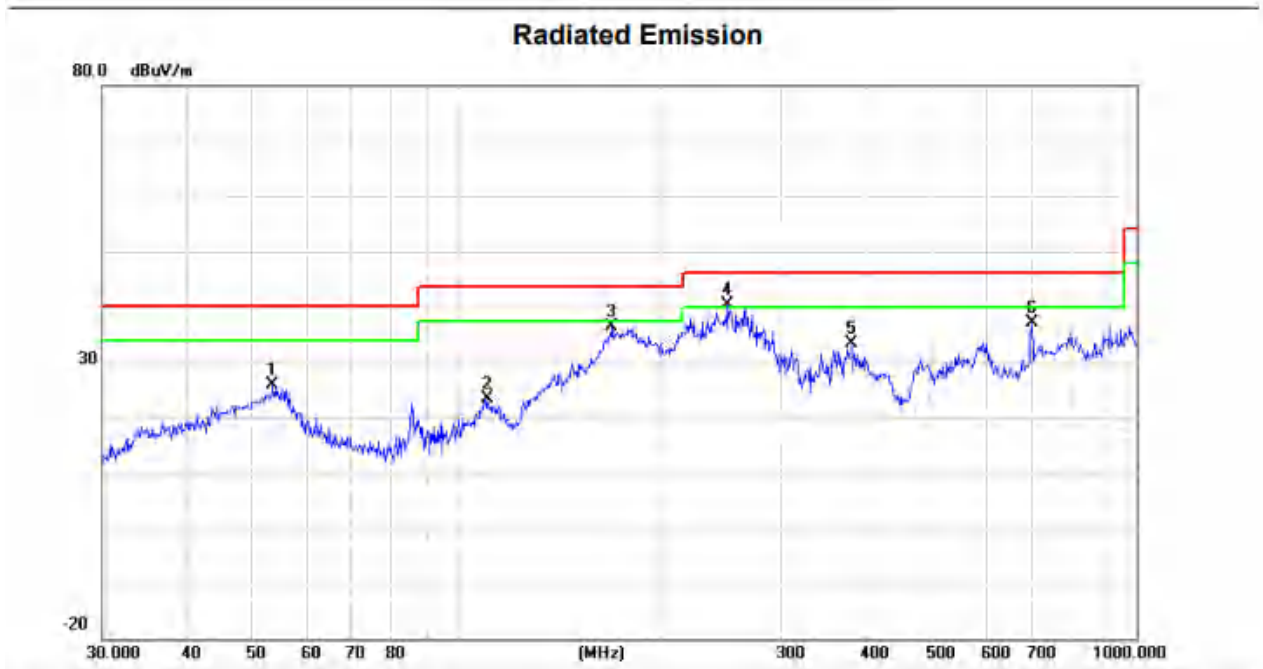

No.	Mk.	Freq.	Reading Level	Correct Factor	Measurement	Limit	Over	Antenna Height	Table Degree	
		MHz	dBuV	dB/m	dBuV/m	dBuV/m	dB	cm	degree	Comment
1		53.5052	36.30	-10.54	25.76	40.00	-14.24			peak
2		110.5686	36.05	-12.65	23.40	43.50	-20.10			peak
3		169.0053	46.86	-10.51	36.35	43.50	-7.15			peak
4	*	250.3011	50.75	-10.40	40.35	46.00	-5.65			peak
5		381.2485	40.00	-6.64	33.36	46.00	-12.64			peak
6		701.7610	36.90	0.34	37.24	46.00	-8.76			peak

REMARKS:

- (1) Measurement Value = Reading Level + Correct Factor.
- (2) Margin Level = Measurement Value - Limit Value.

APPENDIX D - RADIATED EMISSION - ABOVE 1000 MHZ

Test Mode	UNII-1_TX A Mode 5180 MHz	Polarization	Vertical
-----------	---------------------------	--------------	----------

Radiated Emission

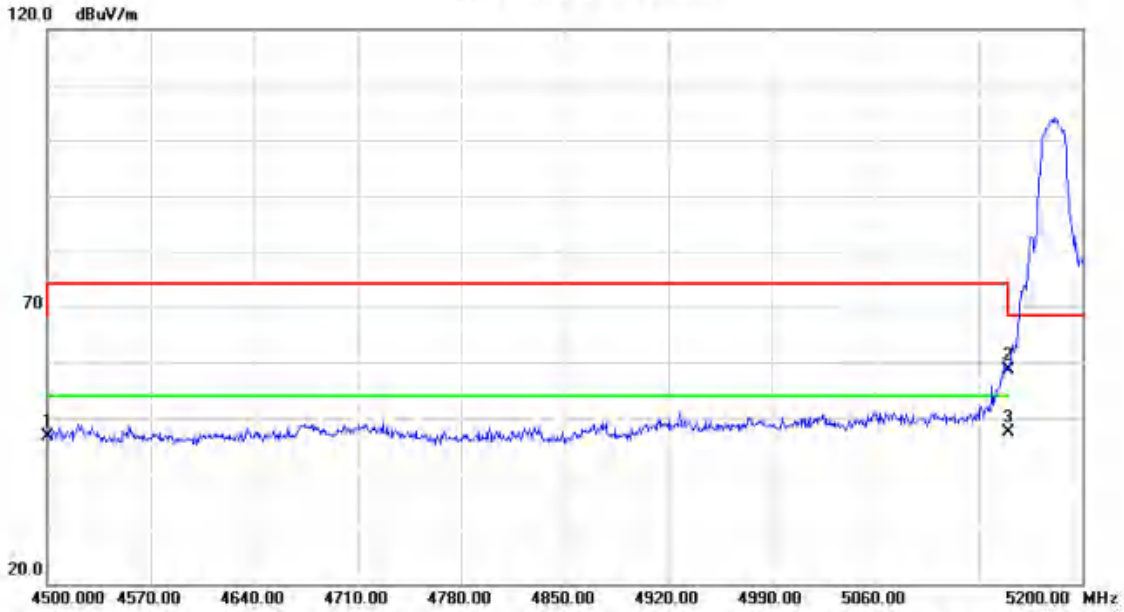

No.	Mk.	Freq.	Reading Level	Correct Factor	Measurement	Limit	Over	Antenna Height	Table Degree	
		MHz	dBuV	dB/m	dBuV/m	dBuV/m	dB	cm	degree	Comment
1		4500.000	50.11	-3.51	46.60	68.20	-21.60			peak
2		5150.000	60.44	-1.88	58.56	68.20	-9.64			peak
3	*	5150.000	49.19	-1.88	47.31	54.00	-6.69			AVG

REMARKS:

- (1) Measurement Value = Reading Level + Correct Factor.
- (2) Margin Level = Measurement Value - Limit Value.

Test Mode	UNII-1_TX A Mode 5180 MHz	Polarization	Vertical
-----------	---------------------------	--------------	----------

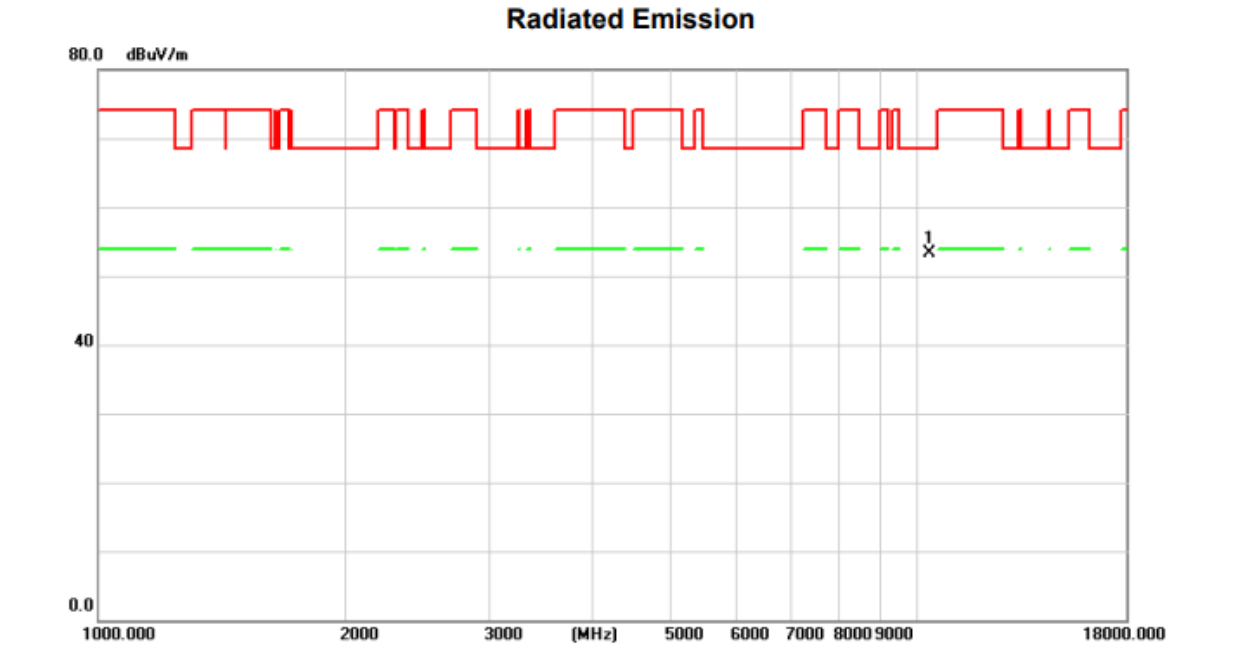

No.	Mk.	Freq.	Reading Level	Correct Factor	Measurement	Limit	Over	Antenna Height	Table Degree	
		MHz	dBuV	dB/m	dBuV/m	dBuV/m	dB	cm	degree	Comment
1	*	10360.000	44.18	9.03	53.21	68.20	-14.99			peak

REMARKS:

- (1) Measurement Value = Reading Level + Correct Factor.
- (2) Margin Level = Measurement Value - Limit Value.

Test Mode	UNII-1_TX A Mode 5180 MHz	Polarization	Horizontal
-----------	---------------------------	--------------	------------

Radiated Emission

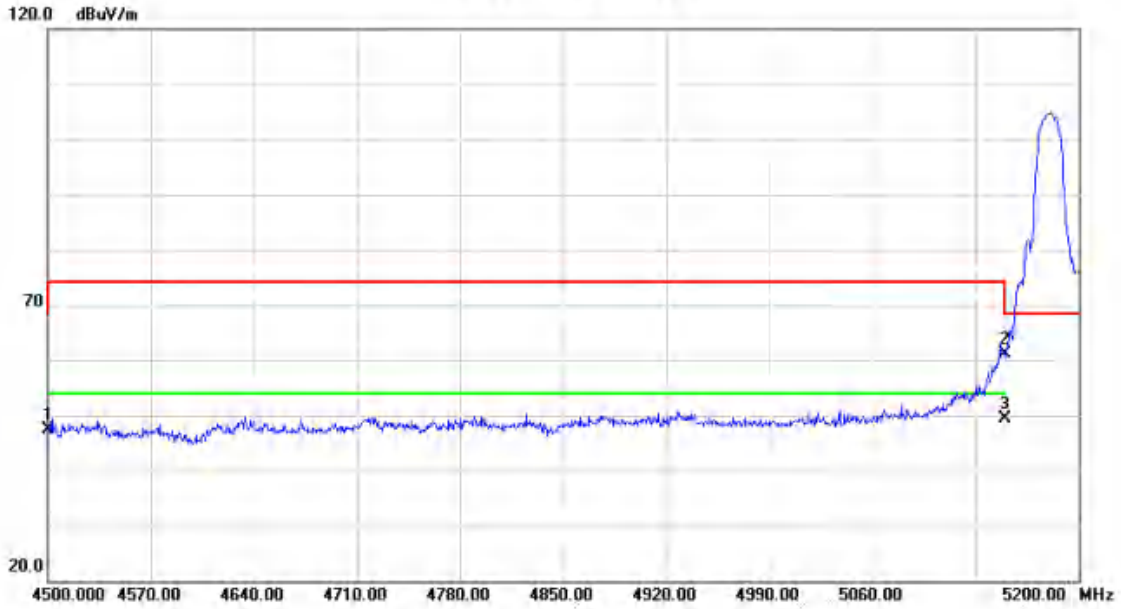

No.	Mk.	Freq.	Reading Level	Correct Factor	Measurement	Limit	Over	Antenna Height	Table Degree	
		MHz	dBuV	dB/m	dBuV/m	dBuV/m	dB	cm	degree	Comment
1		4500.000	50.93	-3.51	47.42	68.20	-20.78			peak
2		5150.000	62.96	-1.88	61.08	68.20	-7.12			peak
3	*	5150.000	51.24	-1.88	49.36	54.00	-4.64			AVG

REMARKS:

- (1) Measurement Value = Reading Level + Correct Factor.
- (2) Margin Level = Measurement Value - Limit Value.

Test Mode	UNII-1_TX A Mode 5180 MHz	Polarization	Horizontal
-----------	---------------------------	--------------	------------

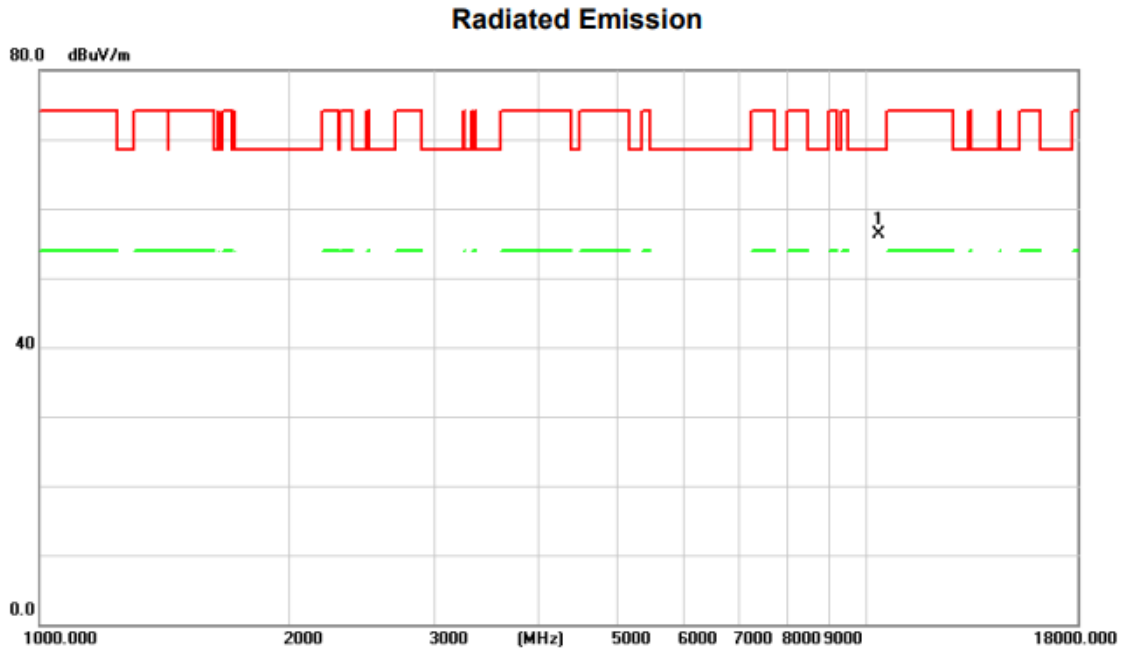

No.	Mk.	Freq.	Reading Level	Correct Factor	Measurement	Limit	Over	Antenna Height	Table Degree
		MHz	dBuV	dB/m	dBuV/m	dBuV/m	dB	cm	degree
1	*	10360.000	47.31	9.03	56.34	68.20	-11.86	peak	

REMARKS:

- (1) Measurement Value = Reading Level + Correct Factor.
- (2) Margin Level = Measurement Value - Limit Value.

Test Mode	UNII-1_TX A Mode 5200 MHz	Polarization	Vertical
-----------	---------------------------	--------------	----------

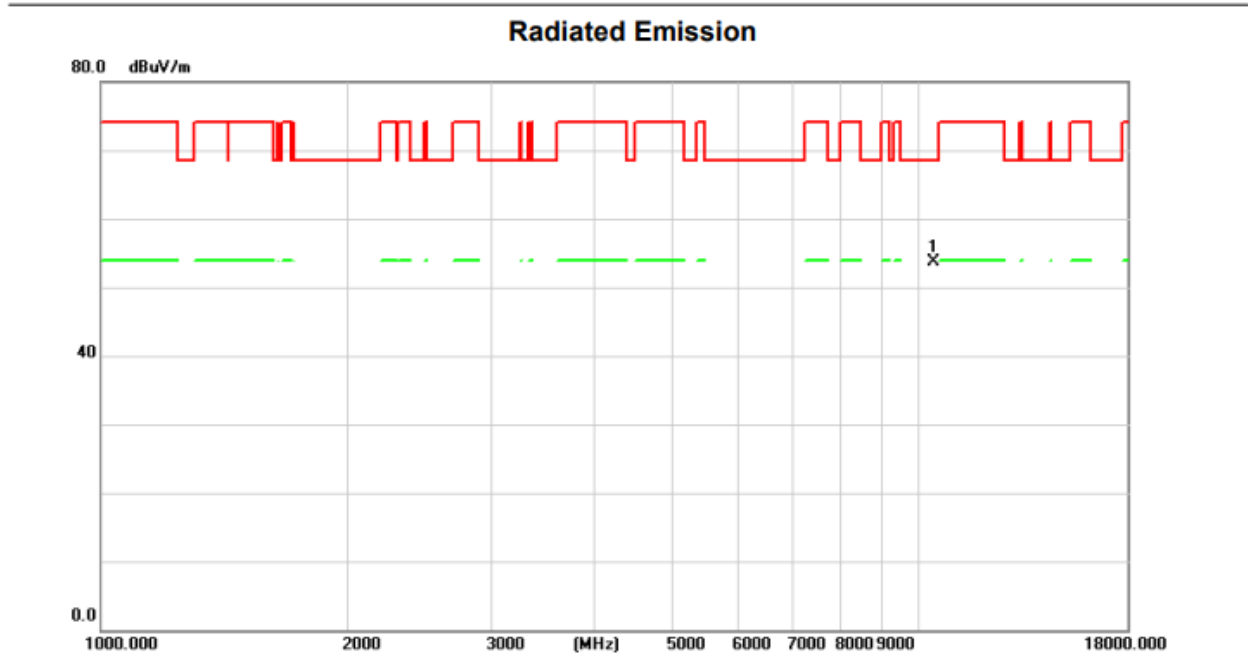

No.	Mk.	Freq.	Reading Level	Correct Factor	Measurement	Limit	Over	Antenna Height	Table Degree
		MHz	dBuV	dB/m	dBuV/m	dBuV/m	dB	Detector	cm
1	*	10400.000	44.58	9.09	53.67	68.20	-14.53	peak	

REMARKS:

- (1) Measurement Value = Reading Level + Correct Factor.
- (2) Margin Level = Measurement Value - Limit Value.

Test Mode	UNII-1_TX A Mode 5200 MHz	Polarization	Horizontal
-----------	---------------------------	--------------	------------

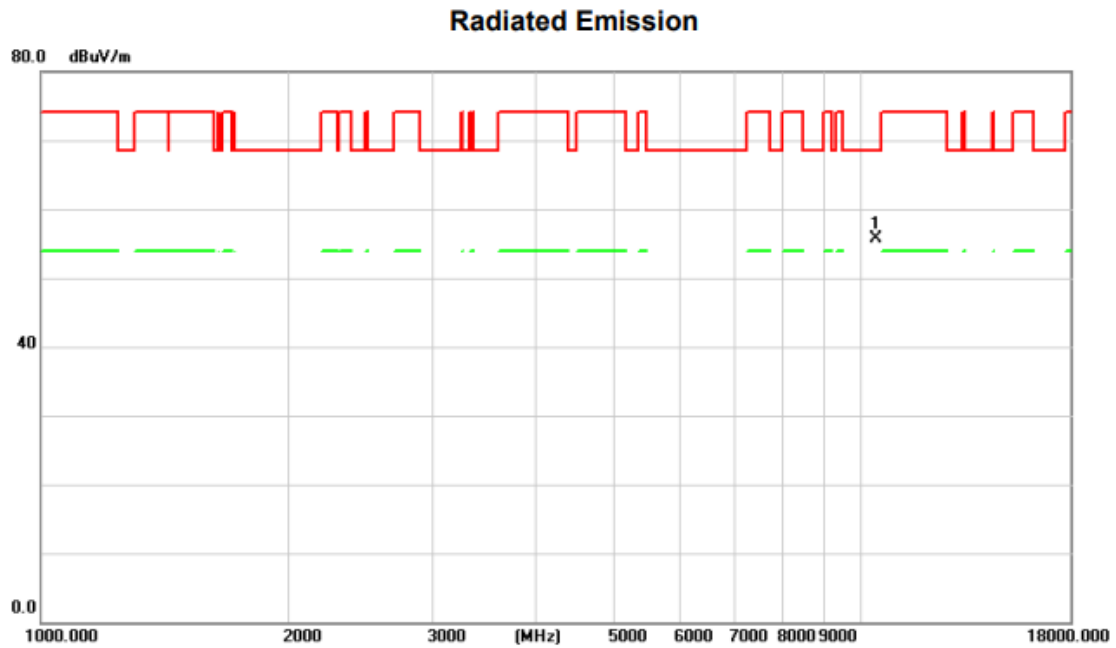

No.	Mk.	Freq.	Reading Level	Correct Factor	Measurement	Limit	Over	Antenna Height	Table Degree	
		MHz	dBuV	dB/m	dBuV/m	dBuV/m	dB	cm	degree	Comment
1	*	10400.000	46.69	9.09	55.78	68.20	-12.42			peak

REMARKS:

- (1) Measurement Value = Reading Level + Correct Factor.
- (2) Margin Level = Measurement Value - Limit Value.

Test Mode	UNII-1_TX A Mode 5240 MHz	Polarization	Vertical
-----------	---------------------------	--------------	----------

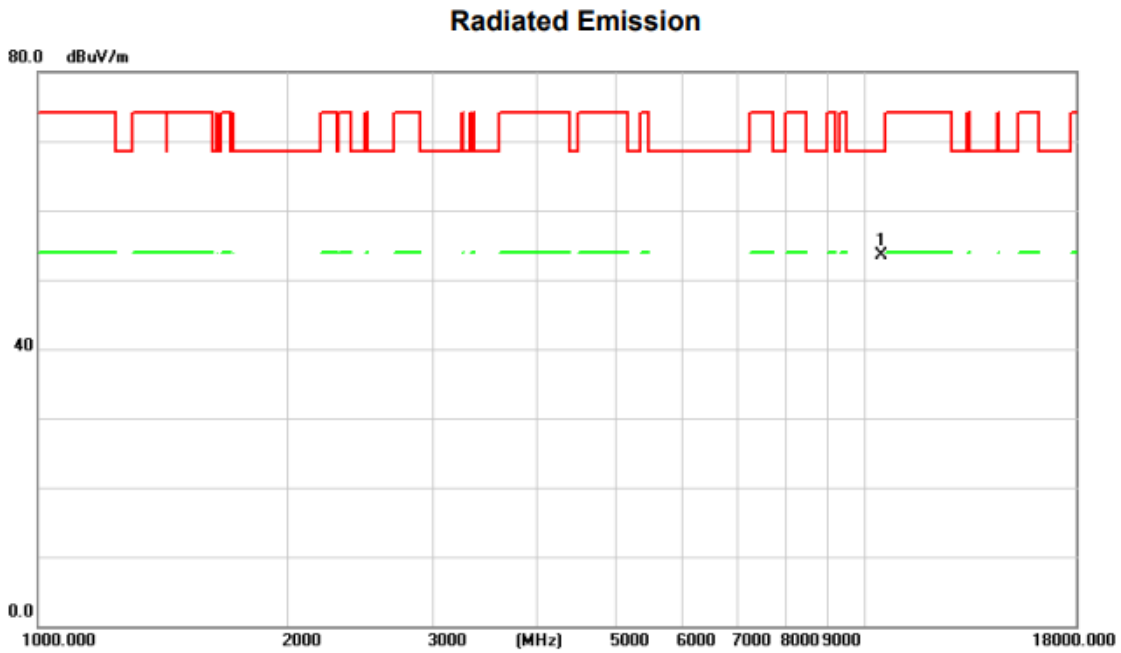

No.	Mk.	Freq.	Reading Level	Correct Factor	Measurement	Limit	Over	Antenna Height	Table Degree	Comment
		MHz	dBuV	dB/m	dBuV/m	dBuV/m	dB	cm	degree	
1	*	10480.000	44.27	9.24	53.51	68.20	-14.69	peak		

REMARKS:

- (1) Measurement Value = Reading Level + Correct Factor.
- (2) Margin Level = Measurement Value - Limit Value.

Test Mode	UNII-1_TX A Mode 5240 MHz	Polarization	Horizontal
-----------	---------------------------	--------------	------------

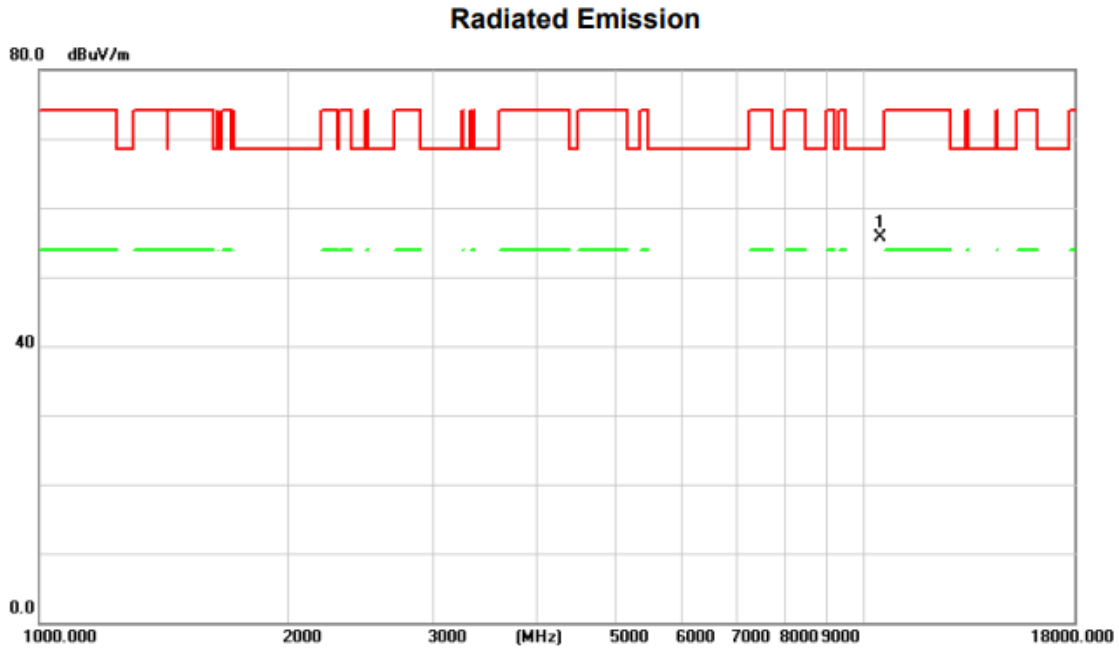

No.	Mk.	Freq.	Reading Level	Correct Factor	Measurement	Limit	Over	Antenna Height	Table Degree	
		MHz	dBuV	dB/m	dBuV/m	dBuV/m	dB	cm	degree	Comment
1	*	10480.000	46.40	9.24	55.64	68.20	-12.56	peak		

REMARKS:

- (1) Measurement Value = Reading Level + Correct Factor.
- (2) Margin Level = Measurement Value - Limit Value.

Test Mode	UNII-1_TX N(HT20) Mode 5180 MHz	Polarization	Vertical
-----------	---------------------------------	--------------	----------

Radiated Emission

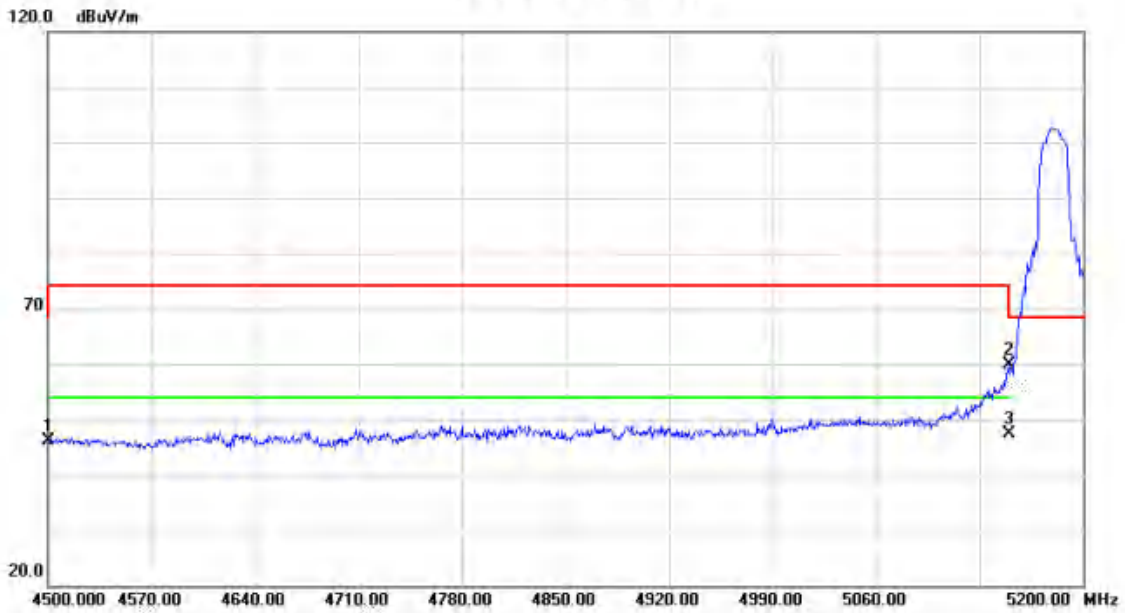

No.	Mk.	Freq.	Reading Level	Correct Factor	Measurement	Limit	Over	Antenna Height	Table Degree	
		MHz	dBuV	dB/m	dBuV/m	dBuV/m	dB	cm	degree	Comment
1		4500.000	49.75	-3.51	46.24	68.20	-21.96			peak
2		5150.000	61.69	-1.88	59.81	68.20	-8.39			peak
3	*	5150.000	49.23	-1.88	47.35	54.00	-6.65			AVG

REMARKS:

- (1) Measurement Value = Reading Level + Correct Factor.
- (2) Margin Level = Measurement Value - Limit Value.

Test Mode	UNII-1_TX N(HT20) Mode 5180 MHz	Polarization	Vertical
-----------	---------------------------------	--------------	----------

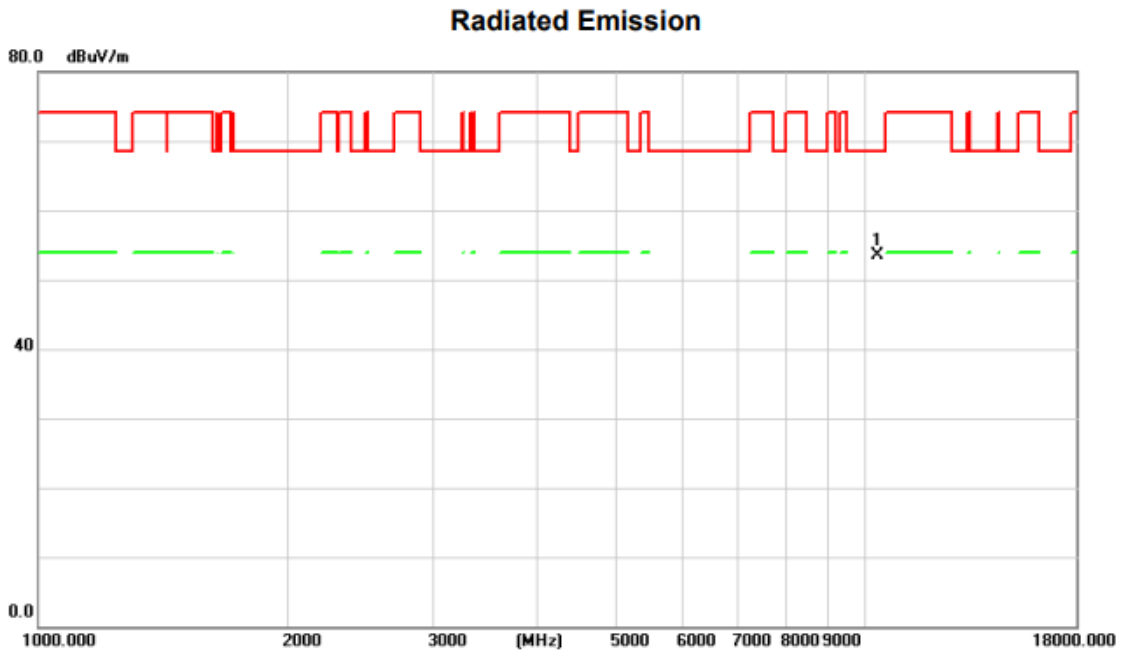

No.	Mk.	Freq.	Reading Level	Correct Factor	Measurement	Limit	Over	Antenna Height	Table Degree	
		MHz	dBuV	dB/m	dBuV/m	dBuV/m	dB	cm	degree	Comment
1	*	10360.000	44.39	9.03	53.42	68.20	-14.78	peak		

REMARKS:

- (1) Measurement Value = Reading Level + Correct Factor.
- (2) Margin Level = Measurement Value - Limit Value.

Test Mode	UNII-1_TX N(HT20) Mode 5180 MHz	Polarization	Horizontal
-----------	---------------------------------	--------------	------------

Radiated Emission

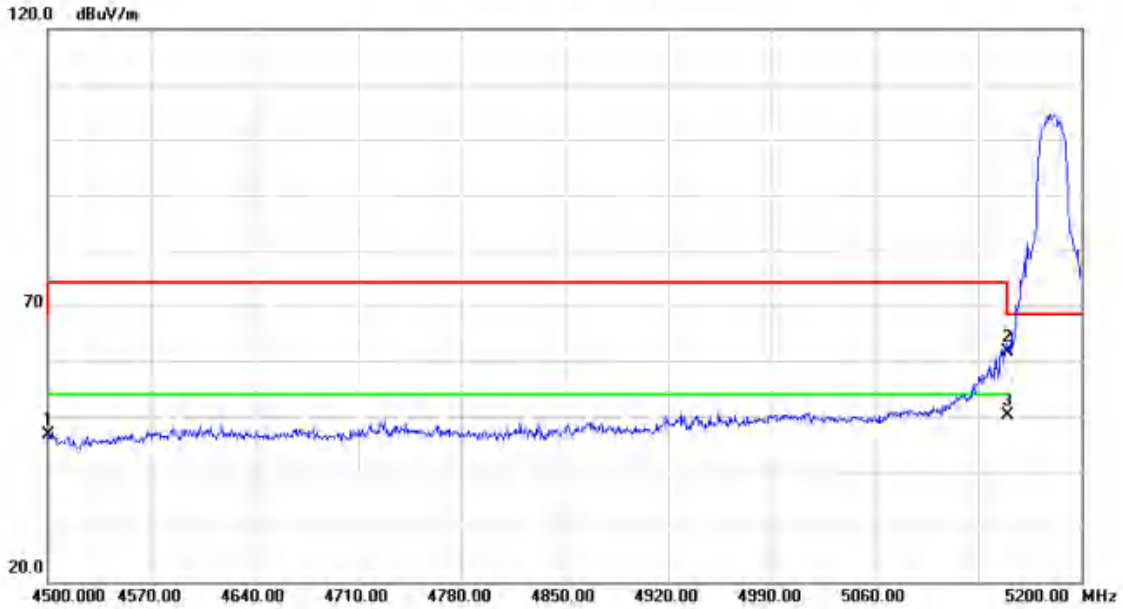

No.	Mk.	Freq.	Reading Level	Correct Factor	Measurement	Limit	Over	Antenna Height	Table Degree	
		MHz	dBuV	dB/m	dBuV/m	dBuV/m	dB	cm	degree	Comment
1		4500.000	50.07	-3.51	46.56	68.20	-21.64			peak
2		5150.000	63.47	-1.88	61.59	68.20	-6.61			peak
3	*	5150.000	52.01	-1.88	50.13	54.00	-3.87			AVG

REMARKS:

- (1) Measurement Value = Reading Level + Correct Factor.
- (2) Margin Level = Measurement Value - Limit Value.

Test Mode	UNII-1_TX N(HT20) Mode 5180 MHz	Polarization	Horizontal
-----------	---------------------------------	--------------	------------

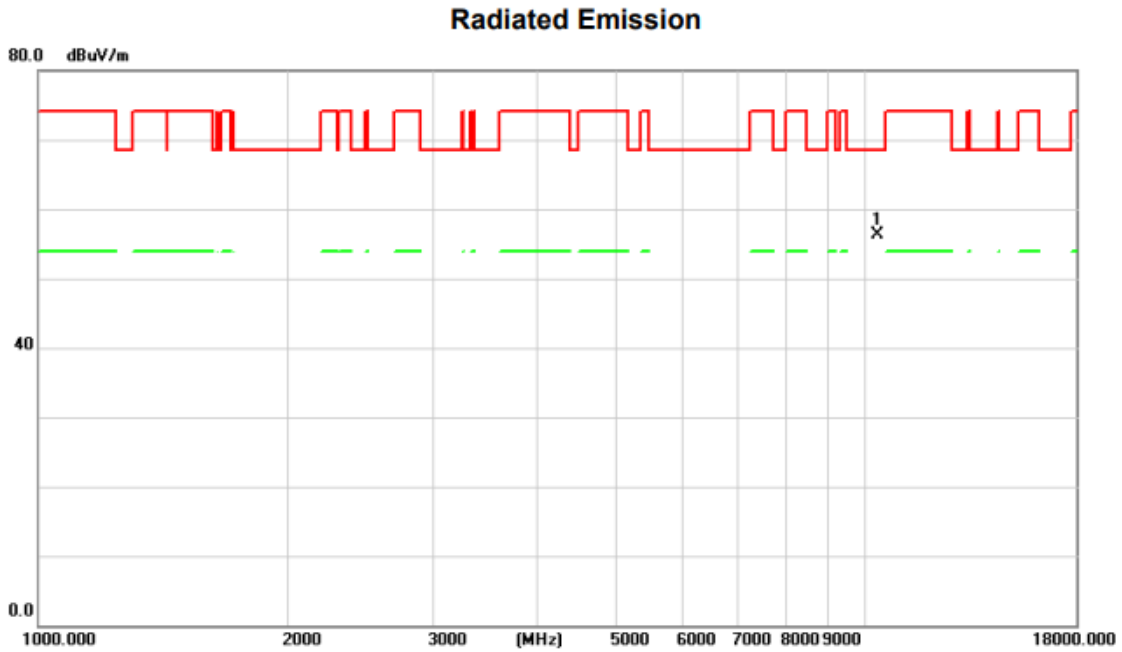

No.	Mk.	Freq.	Reading Level	Correct Factor	Measurement	Limit	Over	Antenna Height	Table Degree	
		MHz	dBuV	dB/m	dBuV/m	dBuV/m	dB	cm	degree	Comment
1	*	10360.000	47.37	9.03	56.40	68.20	-11.80	peak		

REMARKS:

- (1) Measurement Value = Reading Level + Correct Factor.
- (2) Margin Level = Measurement Value - Limit Value.

Test Mode	UNII-1_TX N(HT20) Mode 5200 MHz	Polarization	Vertical
-----------	---------------------------------	--------------	----------

Radiated Emission

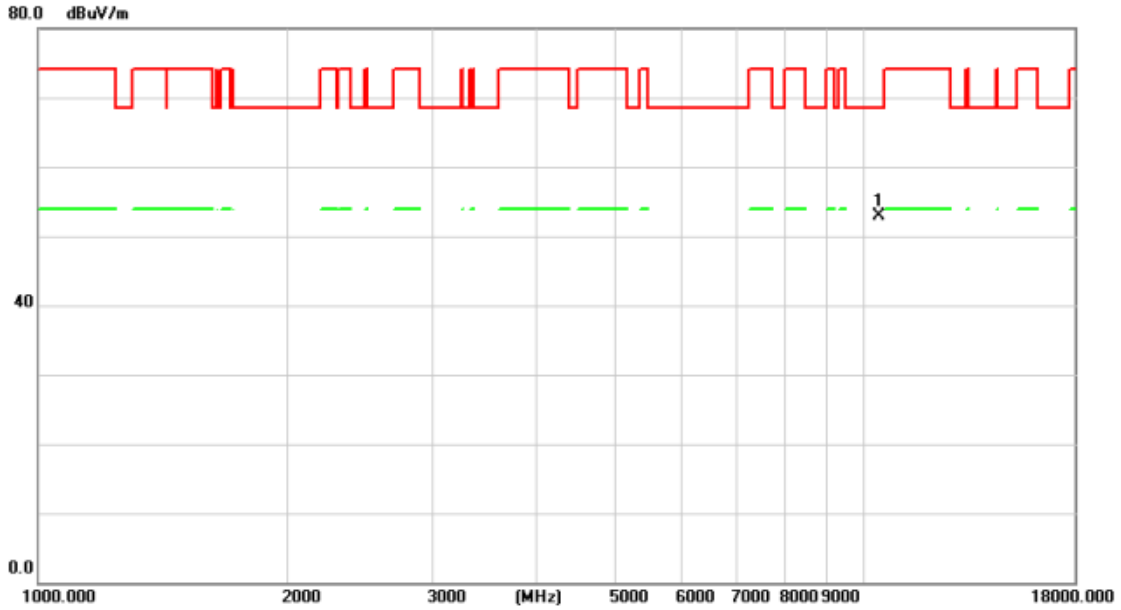

No.	Mk.	Freq.	Reading Level	Correct Factor	Measurement	Limit	Over	Antenna Height	Table Degree
		MHz	dBuV	dB/m	dBuV/m	dBuV/m	dB	cm	degree
1	*	10400.000	43.78	9.09	52.87	68.20	-15.33	peak	

REMARKS:

- (1) Measurement Value = Reading Level + Correct Factor.
- (2) Margin Level = Measurement Value - Limit Value.

Test Mode	UNII-1_TX N(HT20) Mode 5200 MHz	Polarization	Horizontal
-----------	---------------------------------	--------------	------------

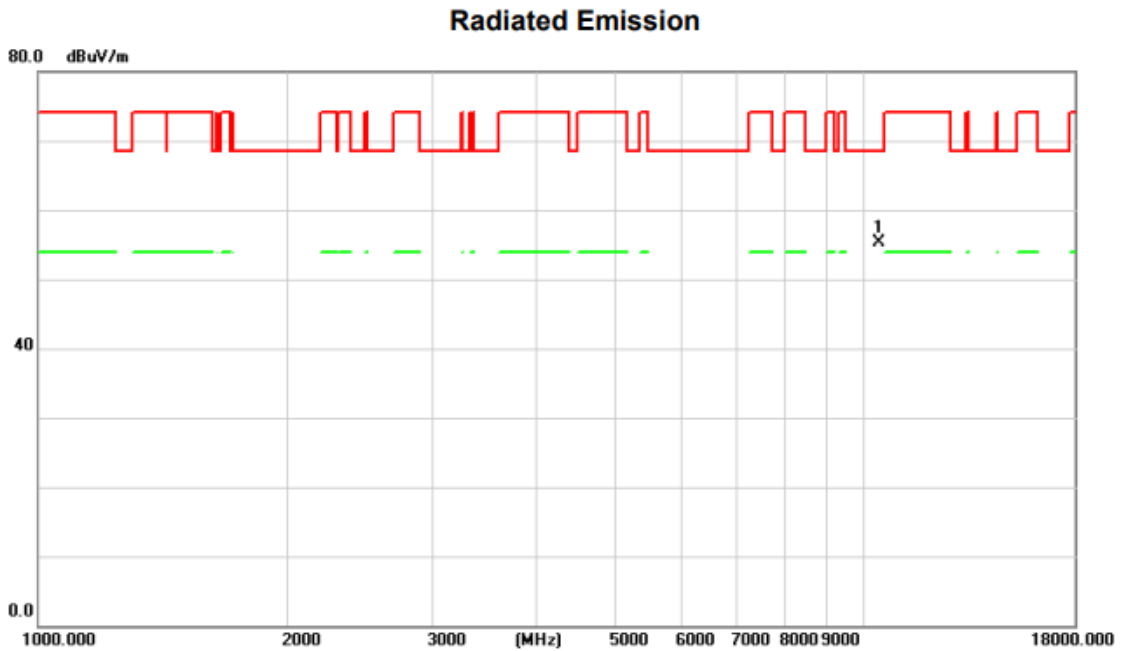

No.	Mk.	Freq.	Reading Level	Correct Factor	Measurement	Limit	Over	Antenna Height	Table Degree
		MHz	dBuV	dB/m	dBuV/m	dBuV/m	dB	cm	degree
1	*	10400.000	46.29	9.09	55.38	68.20	-12.82	peak	

REMARKS:

- (1) Measurement Value = Reading Level + Correct Factor.
- (2) Margin Level = Measurement Value - Limit Value.

Test Mode	UNII-1_TX N(HT20) Mode 5240 MHz	Polarization	Vertical
-----------	---------------------------------	--------------	----------

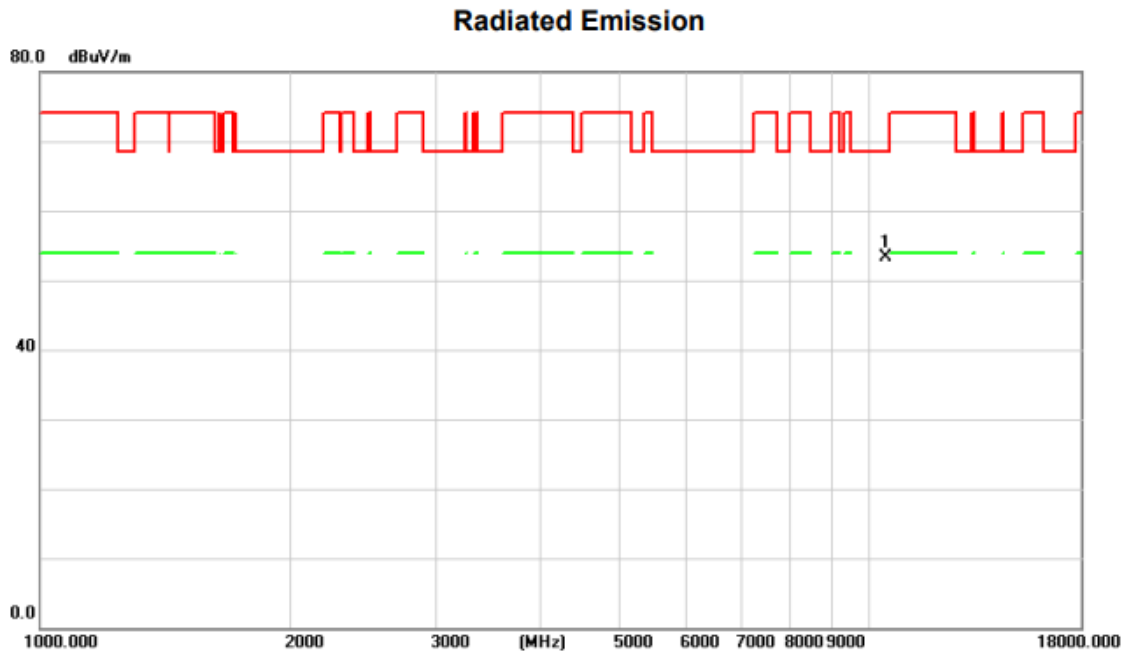

No.	Mk.	Freq.	Reading Level	Correct Factor	Measurement	Limit	Over	Antenna Height	Table Degree	
		MHz	dBuV	dB/m	dBuV/m	dBuV/m	dB	cm	degree	Comment
1	*	10480.000	44.12	9.24	53.36	68.20	-14.84	peak		

REMARKS:

- (1) Measurement Value = Reading Level + Correct Factor.
- (2) Margin Level = Measurement Value - Limit Value.

Test Mode	UNII-1_TX N(HT20) Mode 5240 MHz	Polarization	Horizontal
-----------	---------------------------------	--------------	------------

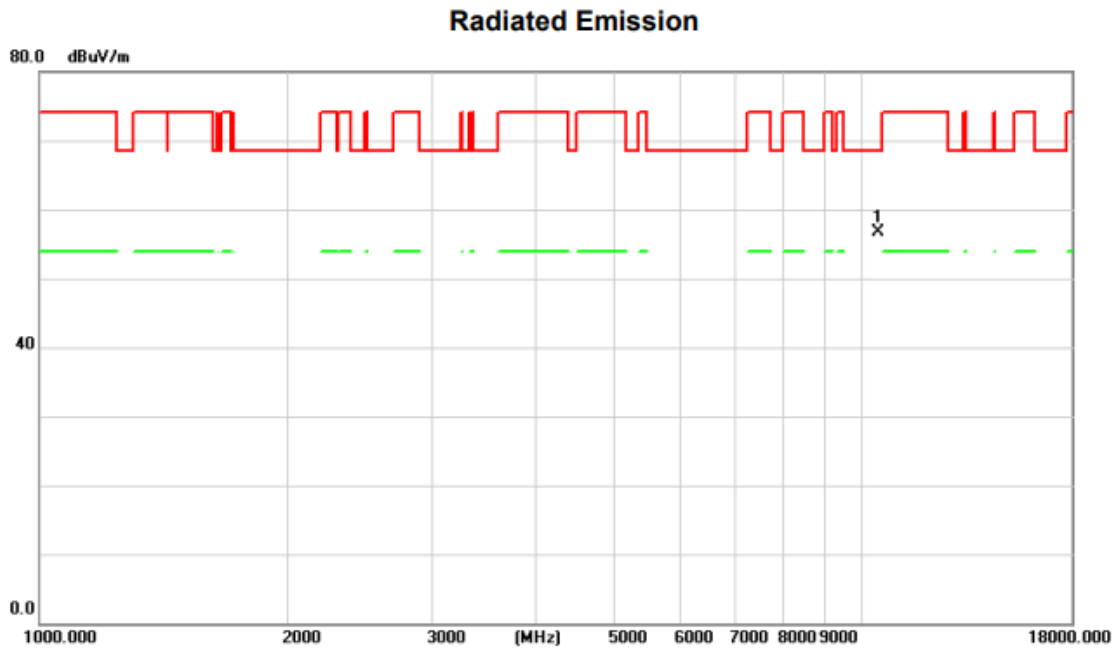

No.	Mk.	Freq.	Reading Level	Correct Factor	Measurement	Limit	Over	Antenna Height	Table Degree	
		MHz	dBuV	dB/m	dBuV/m	dBuV/m	dB	cm	degree	Comment
1	*	10480.000	47.47	9.24	56.71	68.20	-11.49	peak		

REMARKS:

- (1) Measurement Value = Reading Level + Correct Factor.
- (2) Margin Level = Measurement Value - Limit Value.

Test Mode	UNII-1_TX N(HT40) Mode 5190 MHz	Polarization	Vertical
-----------	---------------------------------	--------------	----------

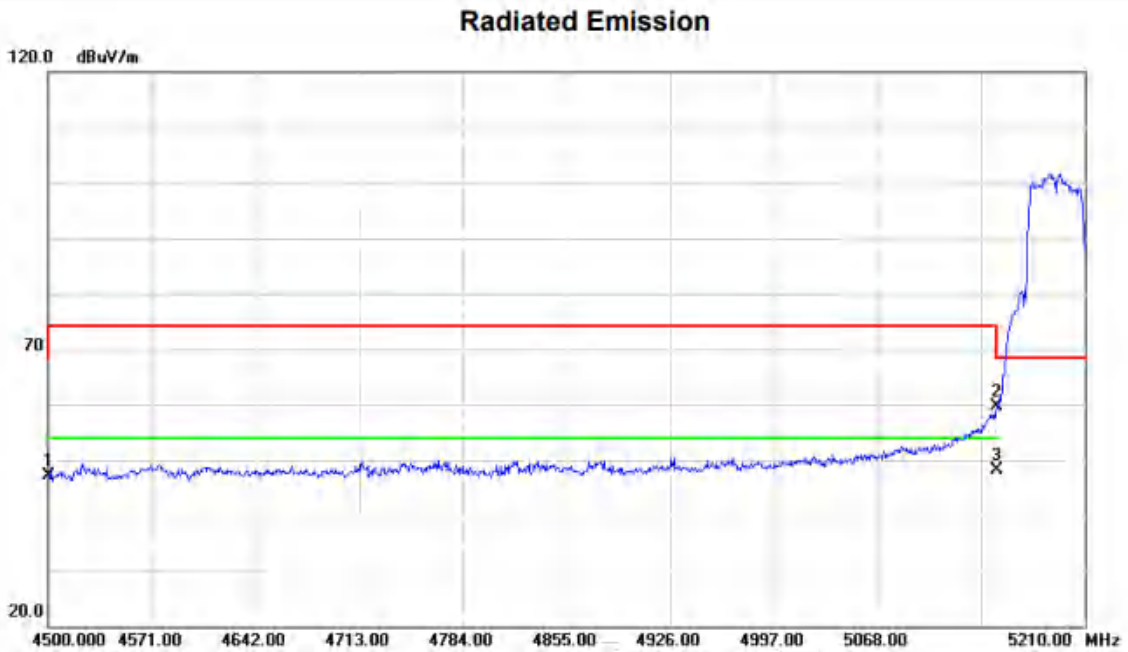

No.	Mk.	Freq.	Reading Level	Correct Factor	Measurement	Limit	Over	Antenna Height	Table Degree	
		MHz	dBuV	dB/m	dBuV/m	dBuV/m	dB	cm	degree	Comment
1		4500.000	50.76	-3.51	47.25	68.20	-20.95			peak
2		5150.000	61.56	-1.88	59.68	68.20	-8.52			peak
3	*	5150.000	49.93	-1.88	48.05	54.00	-5.95			AVG

REMARKS:

- (1) Measurement Value = Reading Level + Correct Factor.
- (2) Margin Level = Measurement Value - Limit Value.

Test Mode	UNII-1_TX N(HT40) Mode 5190 MHz	Polarization	Vertical
-----------	---------------------------------	--------------	----------

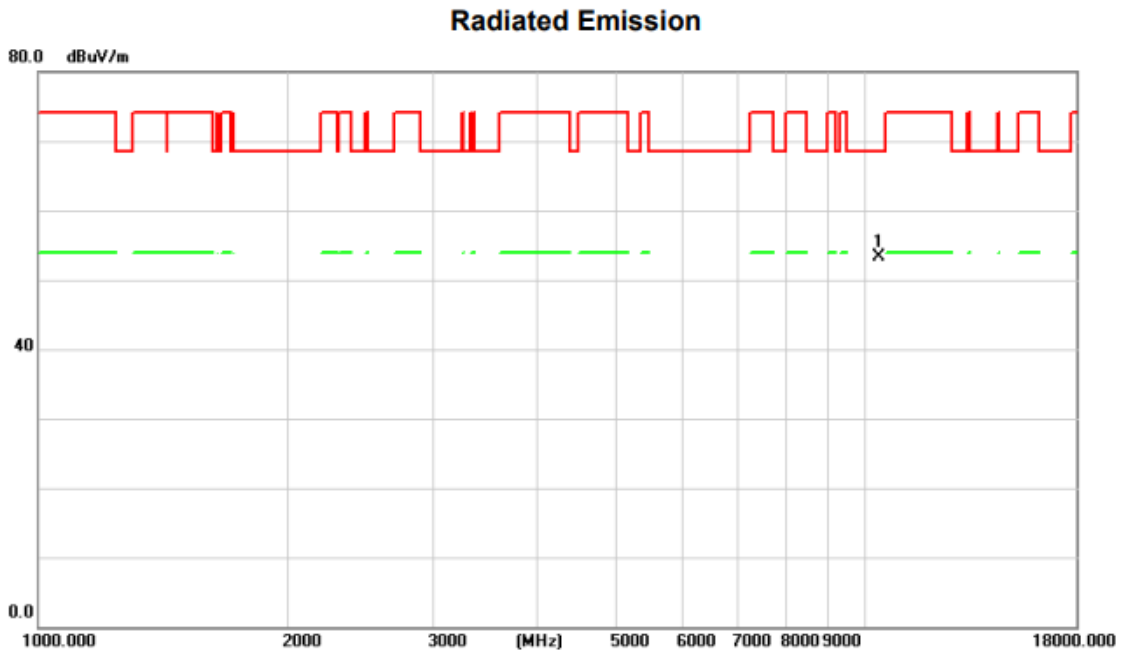

No.	Mk.	Freq.	Reading Level	Correct Factor	Measurement	Limit	Over	Antenna Height	Table Degree	
		MHz	dBuV	dB/m	dBuV/m	dBuV/m	dB	cm	degree	Comment
1	*	10380.000	44.20	9.06	53.26	68.20	-14.94	peak		

REMARKS:

- (1) Measurement Value = Reading Level + Correct Factor.
- (2) Margin Level = Measurement Value - Limit Value.

Test Mode	UNII-1_TX N(HT40) Mode 5190 MHz	Polarization	Horizontal
-----------	---------------------------------	--------------	------------

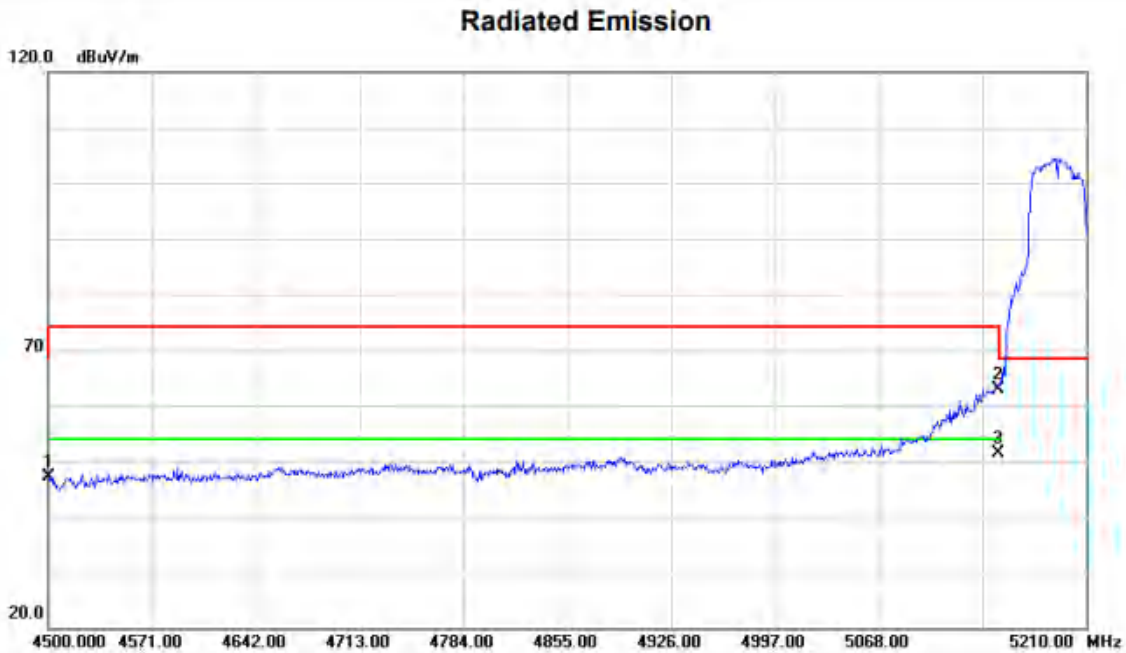

No.	Mk.	Freq.	Reading Level	Correct Factor	Measurement	Limit	Over	Antenna Height	Table Degree	
		MHz	dBuV	dB/m	dBuV/m	dBuV/m	dB	cm	degree	Comment
1		4500.000	50.69	-3.51	47.18	68.20	-21.02			peak
2		5150.000	64.67	-1.88	62.79	68.20	-5.41			peak
3	*	5150.000	53.17	-1.88	51.29	54.00	-2.71			AVG

REMARKS:

- (1) Measurement Value = Reading Level + Correct Factor.
- (2) Margin Level = Measurement Value - Limit Value.

Test Mode	UNII-1_TX N(HT40) Mode 5190 MHz	Polarization	Horizontal
-----------	---------------------------------	--------------	------------

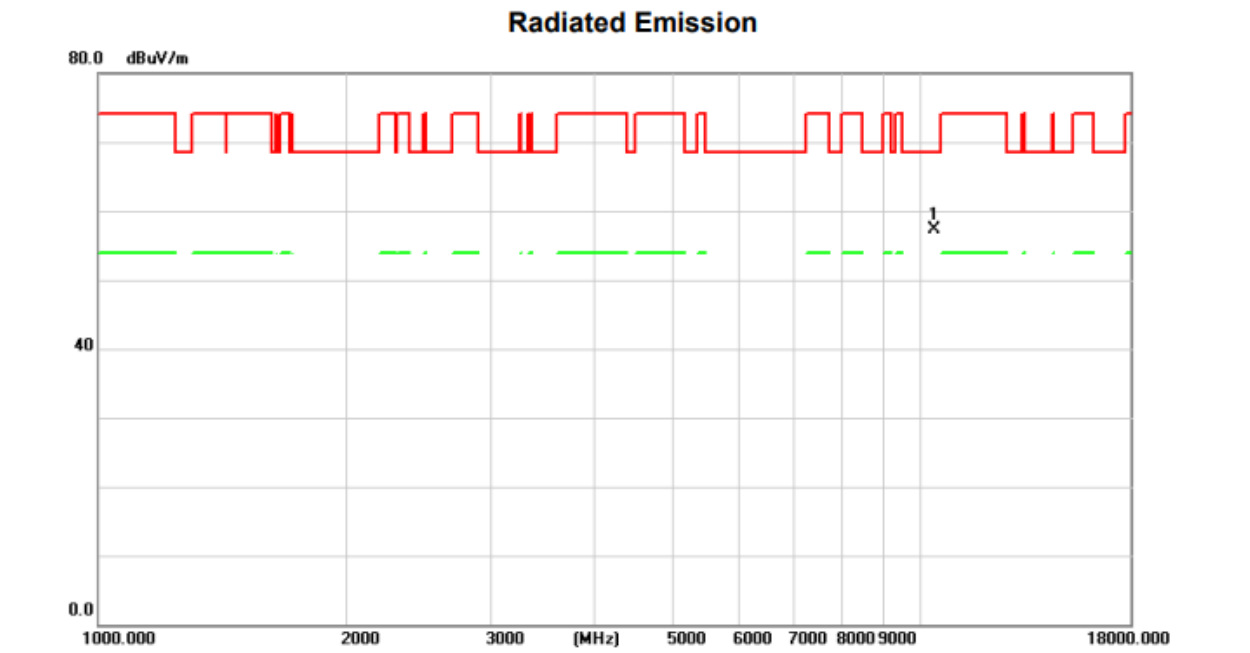

No.	Mk.	Freq.	Reading Level	Correct Factor	Measurement	Limit	Over	Antenna Height	Table Degree
		MHz	dBuV	dB/m	dBuV/m	dBuV/m	dB	cm	degree
1	*	10380.000	48.21	9.06	57.27	68.20	-10.93	peak	

REMARKS:

- (1) Measurement Value = Reading Level + Correct Factor.
- (2) Margin Level = Measurement Value - Limit Value.

Test Mode	UNII-1_TX N(HT40) Mode 5230 MHz	Polarization	Vertical
-----------	---------------------------------	--------------	----------

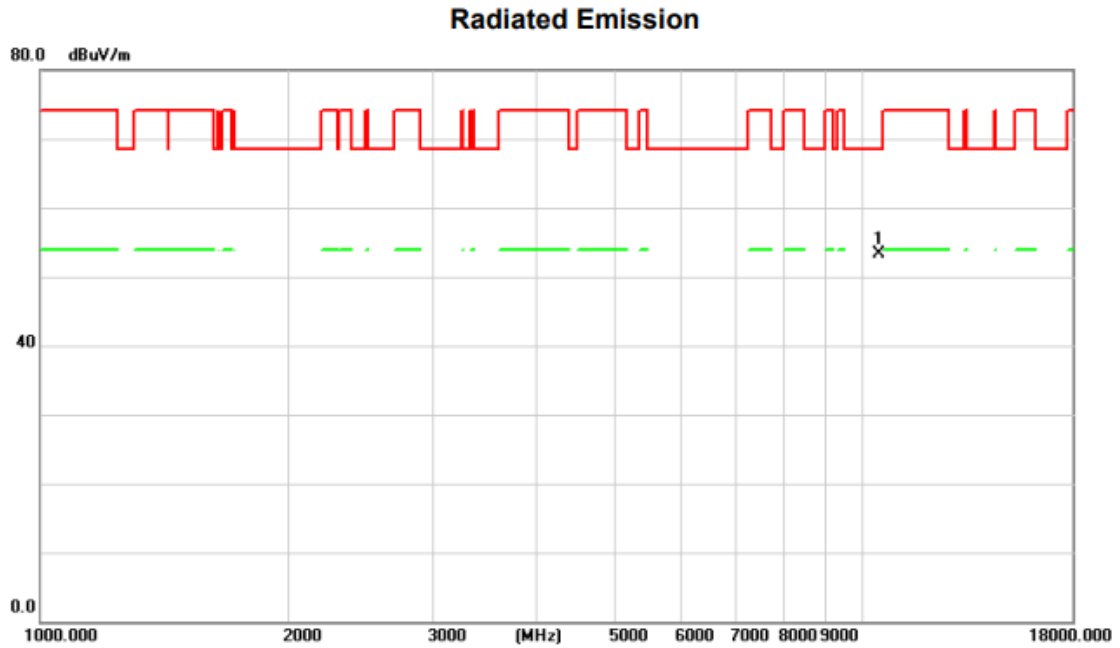

No.	Mk.	Freq.	Reading Level	Correct Factor	Measurement	Limit	Over	Antenna Height	Table Degree
		MHz	dBuV	dB/m	dBuV/m	dBuV/m	dB	cm	degree
1	*	10460.000	44.07	9.20	53.27	68.20	-14.93	peak	

REMARKS:

- (1) Measurement Value = Reading Level + Correct Factor.
- (2) Margin Level = Measurement Value - Limit Value.

Test Mode	UNII-1_TX N(HT40) Mode 5230 MHz	Polarization	Horizontal
-----------	---------------------------------	--------------	------------

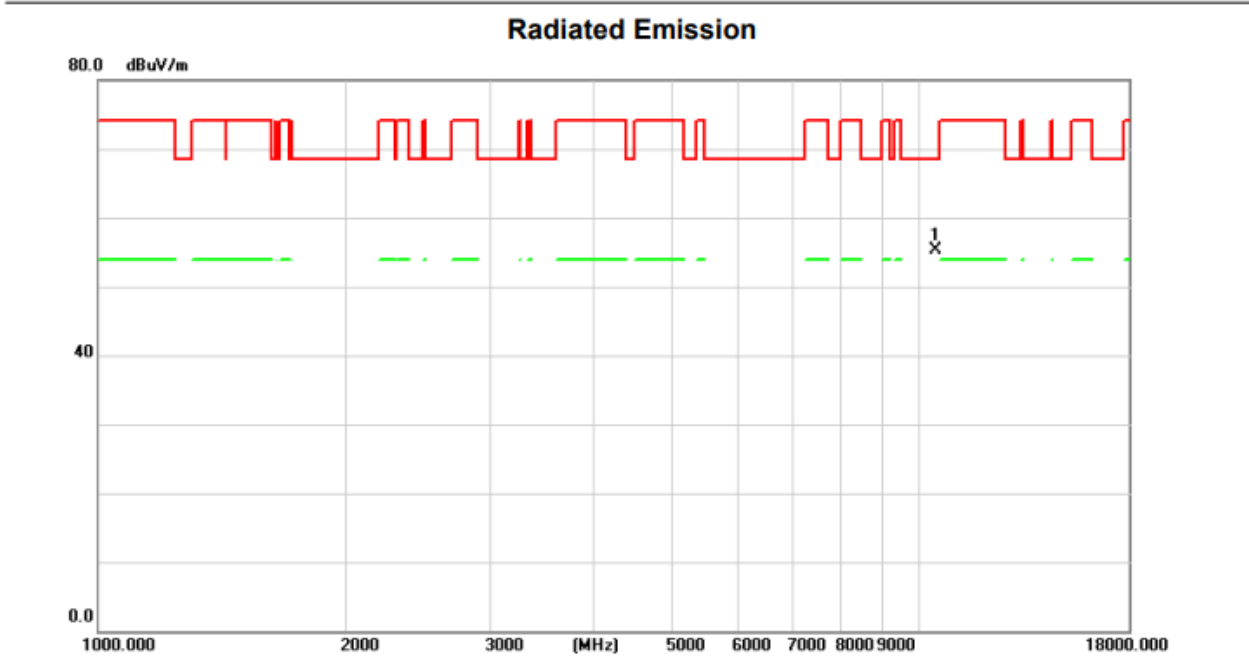

No.	Mk.	Freq.	Reading Level	Correct Factor	Measurement	Limit	Over	Antenna Height	Table Degree
		MHz	dBuV	dB/m	dBuV/m	dBuV/m	dB	cm	degree
1	*	10460.000	46.06	9.20	55.26	68.20	-12.94	peak	

REMARKS:

- (1) Measurement Value = Reading Level + Correct Factor.
- (2) Margin Level = Measurement Value - Limit Value.

Test Mode	UNII-1_TX AC(HT20) Mode 5180 MHz	Polarization	Vertical
-----------	----------------------------------	--------------	----------

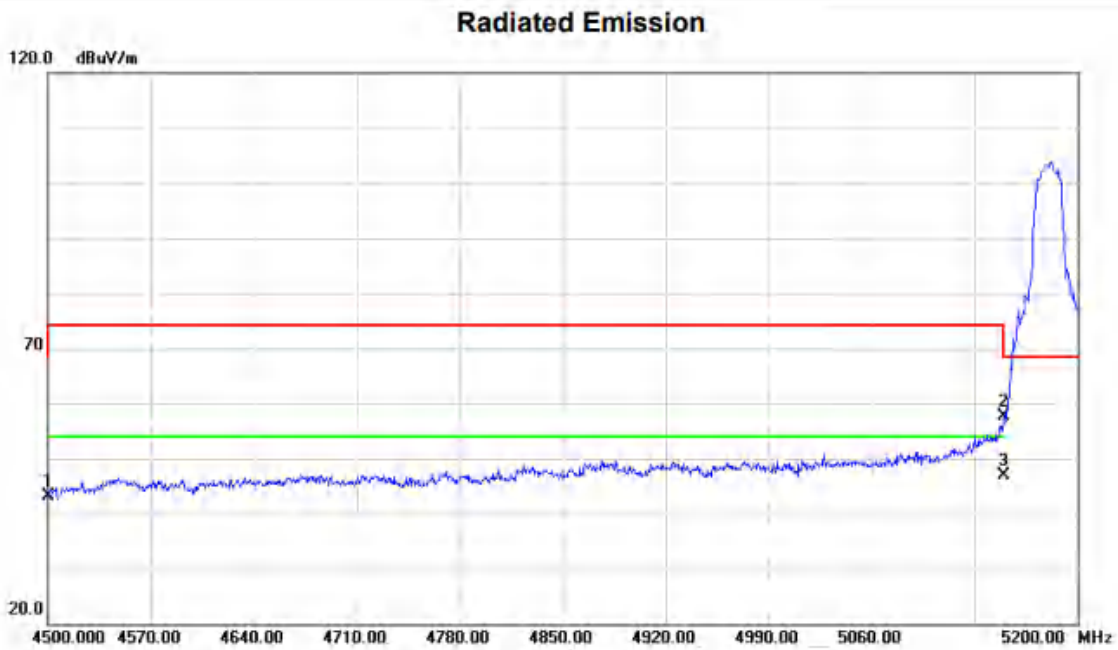

No.	Mk.	Freq.	Reading Level	Correct Factor	Measurement	Limit	Over	Antenna Height	Table Degree	Comment
		MHz	dBuV	dB/m	dBuV/m	dBuV/m	dB	cm	degree	
1		4500.000	46.70	-3.51	43.19	68.20	-25.01			peak
2		5150.000	59.50	-1.88	57.62	68.20	-10.58			peak
3	*	5150.000	48.69	-1.88	46.81	54.00	-7.19			AVG

REMARKS:

- (1) Measurement Value = Reading Level + Correct Factor.
- (2) Margin Level = Measurement Value - Limit Value.

Test Mode	UNII-1_TX AC(HT20) Mode 5180 MHz	Polarization	Vertical
-----------	----------------------------------	--------------	----------

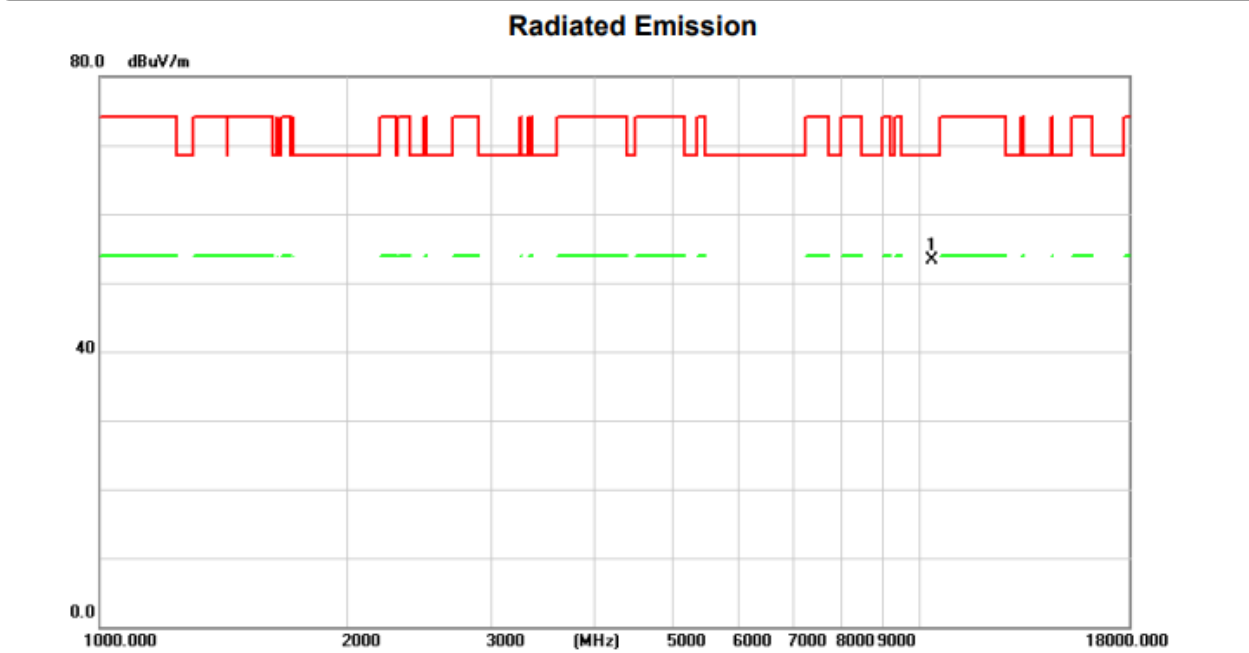

No.	Mk.	Freq.	Reading Level	Correct Factor	Measurement	Limit	Over	Antenna Height	Table Degree
		MHz	dBuV	dB/m	dBuV/m	dBuV/m	dB	cm	degree
1	*	10360.000	44.34	9.03	53.37	68.20	-14.83	peak	

REMARKS:

- (1) Measurement Value = Reading Level + Correct Factor.
- (2) Margin Level = Measurement Value - Limit Value.

Test Mode	UNII-1_TX AC(HT20) Mode 5180 MHz	Polarization	Horizontal
-----------	----------------------------------	--------------	------------

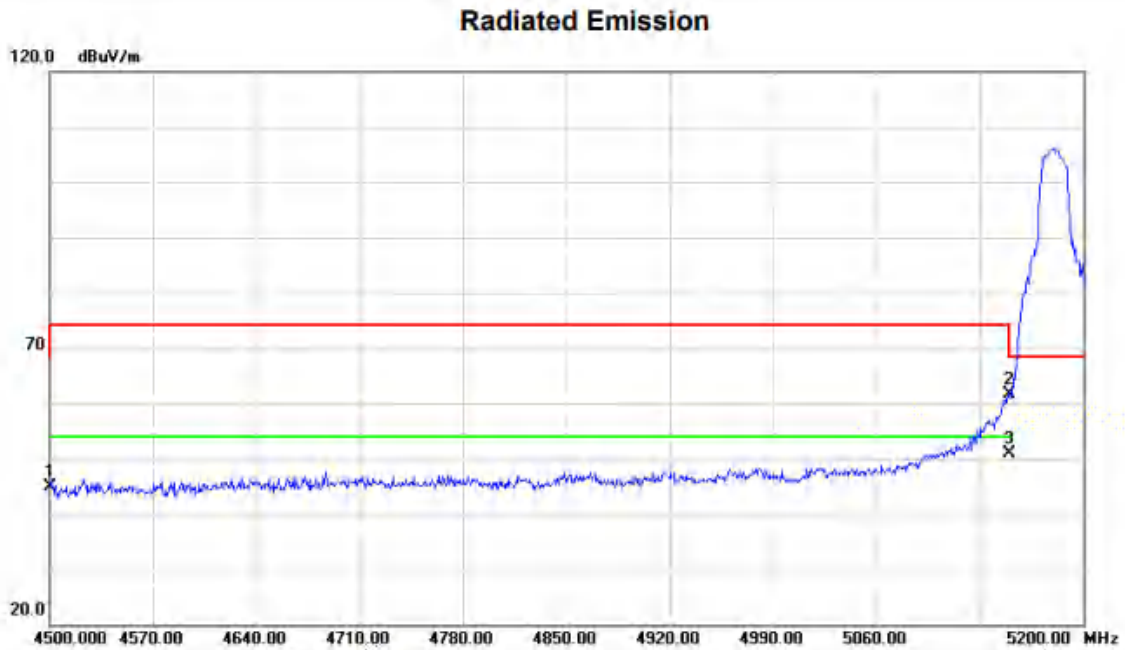

No.	Mk.	Freq.	Reading Level	Correct Factor	Measurement	Limit	Over	Antenna Height	Table Degree	
		MHz	dBuV	dB/m	dBuV/m	dBuV/m	dB	cm	degree	Comment
1		4500.000	48.51	-3.51	45.00	68.20	-23.20			peak
2		5150.000	63.40	-1.88	61.52	68.20	-6.68			peak
3	*	5150.000	52.64	-1.88	50.76	54.00	-3.24			AVG

REMARKS:

- (1) Measurement Value = Reading Level + Correct Factor.
- (2) Margin Level = Measurement Value - Limit Value.

Test Mode	UNII-1_TX AC(HT20) Mode 5180 MHz	Polarization	Horizontal
-----------	----------------------------------	--------------	------------

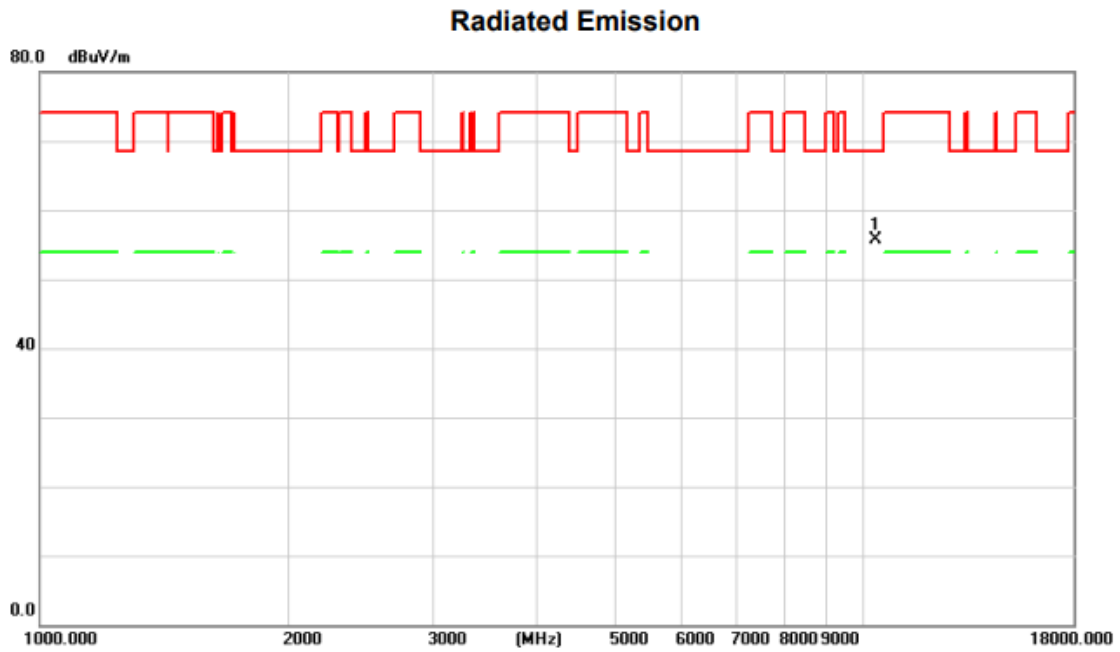

No.	Mk.	Freq.	Reading Level	Correct Factor	Measurement	Limit	Over	Antenna Height	Table Degree	
		MHz	dBuV	dB/m	dBuV/m	dBuV/m	dB	cm	degree	Comment
1	*	10360.000	46.62	9.03	55.65	68.20	-12.55	peak		

REMARKS:

- (1) Measurement Value = Reading Level + Correct Factor.
- (2) Margin Level = Measurement Value - Limit Value.

Test Mode	UNII-1_TX AC(HT20) Mode 5200 MHz	Polarization	Vertical
-----------	----------------------------------	--------------	----------

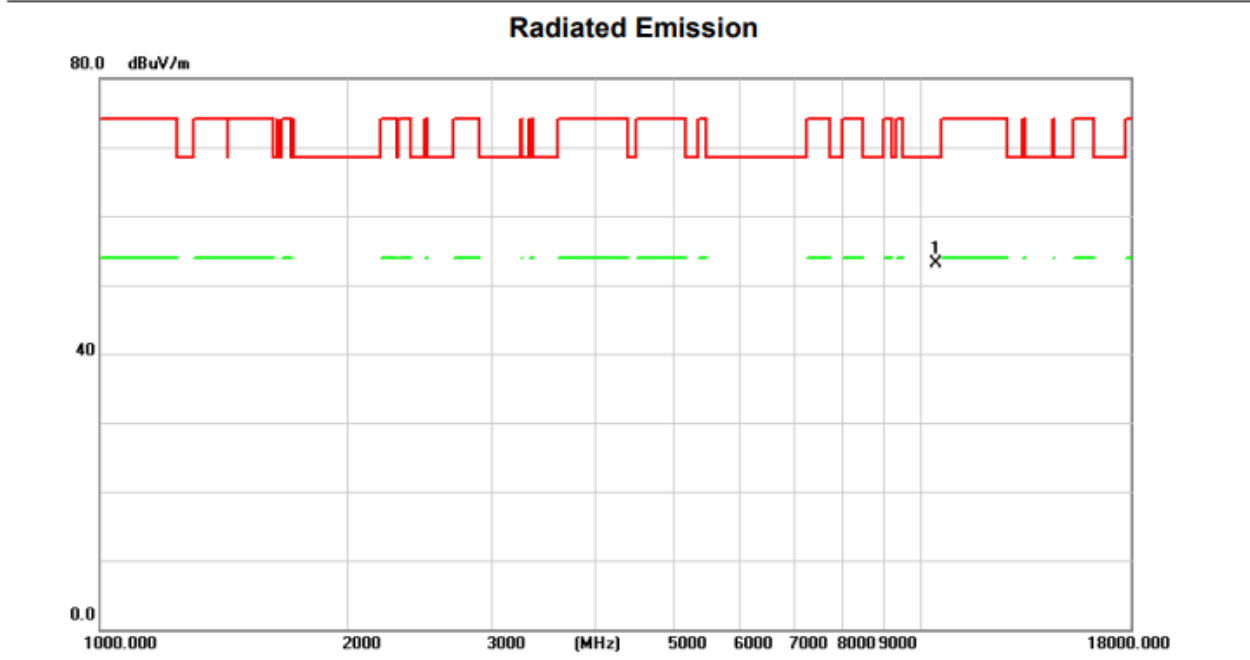

No.	Mk.	Freq.	Reading Level	Correct Factor	Measurement	Limit	Over	Antenna Height	Table Degree
		MHz	dBuV	dB/m	dBuV/m	dBuV/m	dB	cm	degree
1	*	10400.000	43.95	9.09	53.04	68.20	-15.16	peak	

REMARKS:

- (1) Measurement Value = Reading Level + Correct Factor.
- (2) Margin Level = Measurement Value - Limit Value.

Test Mode	UNII-1_TX AC(HT20) Mode 5200 MHz	Polarization	Horizontal
-----------	----------------------------------	--------------	------------

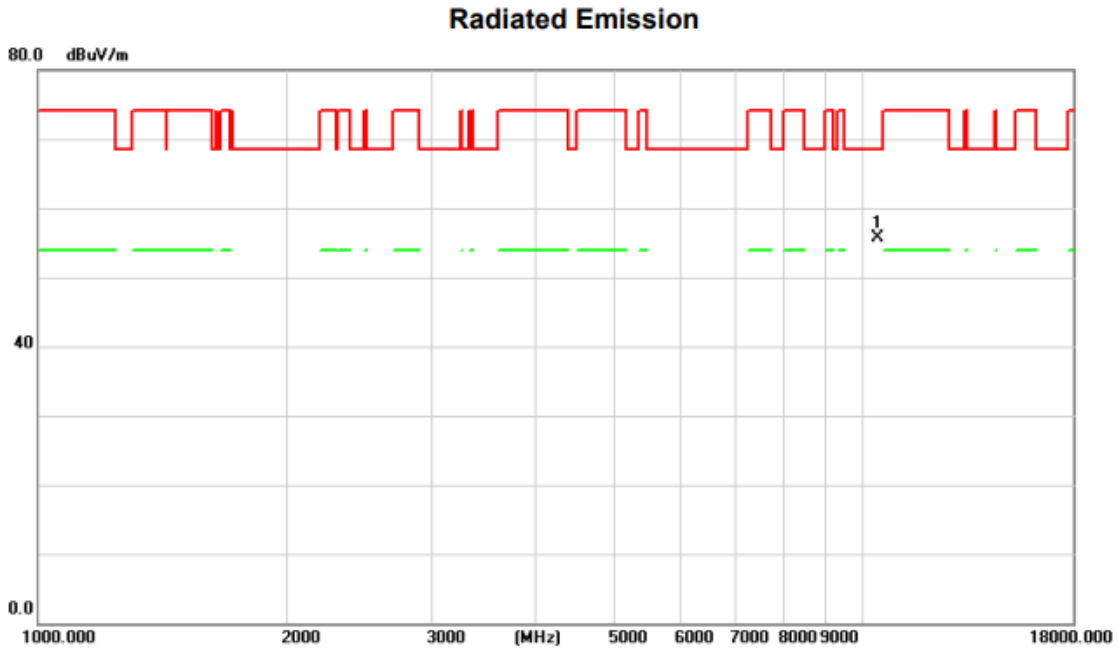

No.	Mk.	Freq.	Reading Level	Correct Factor	Measurement	Limit	Over	Antenna Height	Table Degree
		MHz	dBuV	dB/m	dBuV/m	dBuV/m	dB	cm	degree
1	*	10400.000	46.57	9.09	55.66	68.20	-12.54	peak	

REMARKS:
 (1) Measurement Value = Reading Level + Correct Factor.
 (2) Margin Level = Measurement Value - Limit Value.

Test Mode	UNII-1_TX AC(HT20) Mode 5240 MHz	Polarization	Vertical
-----------	----------------------------------	--------------	----------

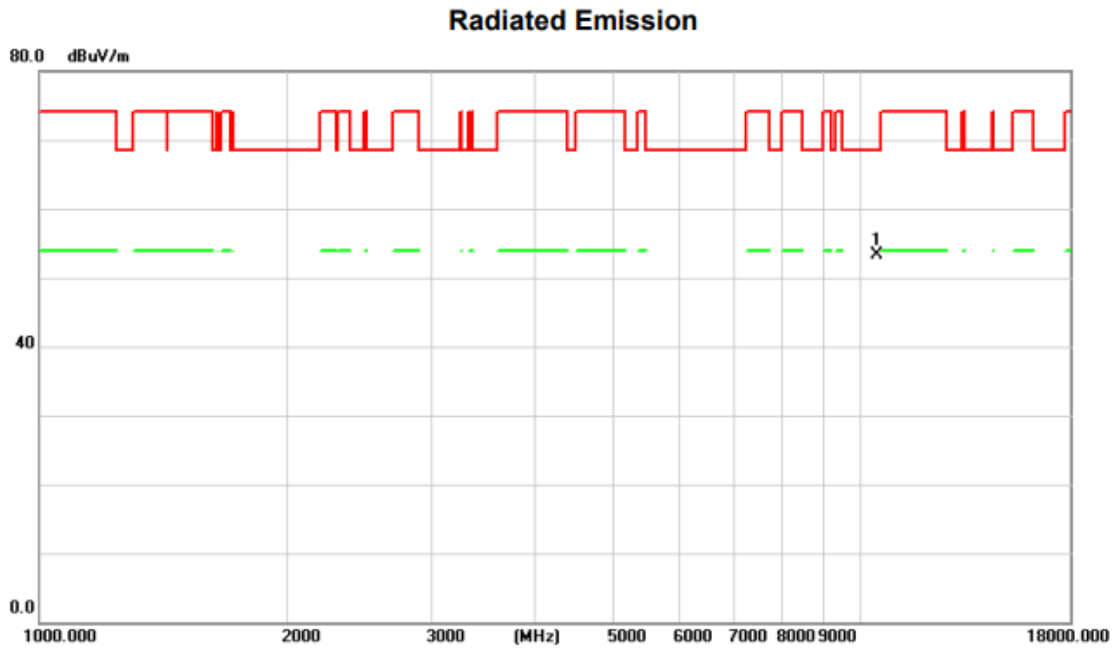

No.	Mk.	Freq.	Reading Level	Correct Factor	Measurement	Limit	Over	Antenna Height	Table Degree	Comment
		MHz	dBuV	dB/m	dBuV/m	dBuV/m	dB	cm	degree	
1	*	10480.000	44.07	9.24	53.31	68.20	-14.89	peak		

REMARKS:

- (1) Measurement Value = Reading Level + Correct Factor.
- (2) Margin Level = Measurement Value - Limit Value.

Test Mode	UNII-1_TX N(HT20) Mode 5240 MHz	Polarization	Horizontal
-----------	---------------------------------	--------------	------------

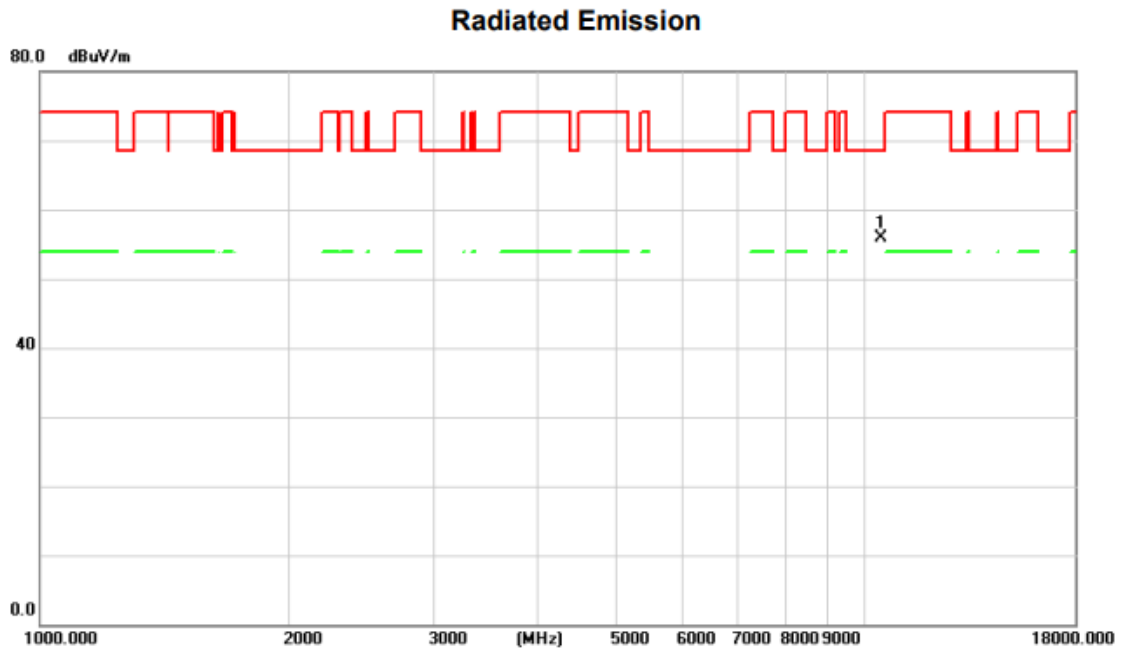

No.	Mk.	Freq.	Reading Level	Correct Factor	Measurement	Limit	Over	Antenna Height	Table Degree
		MHz	dBuV	dB/m	dBuV/m	dBuV/m	dB	cm	degree
1	*	10480.000	46.64	9.24	55.88	68.20	-12.32	peak	

REMARKS:

- (1) Measurement Value = Reading Level + Correct Factor.
- (2) Margin Level = Measurement Value - Limit Value.

Test Mode	UNII-1_TX AC(HT40) Mode 5190 MHz	Polarization	Vertical
-----------	----------------------------------	--------------	----------

Radiated Emission

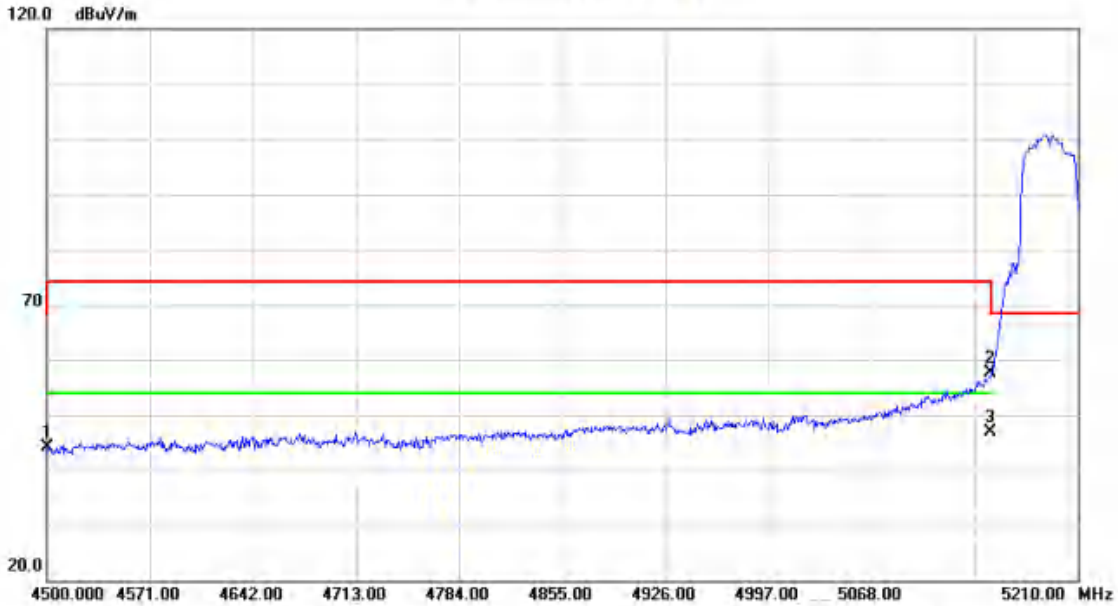

No.	Mk.	Freq.	Reading Level	Correct Factor	Measurement	Limit	Over	Antenna Height	Table Degree	Comment
		MHz	dBuV	dB/m	dBuV/m	dBuV/m	dB	cm	degree	
1		4500.000	47.75	-3.51	44.24	68.20	-23.96			peak
2		5150.000	59.59	-1.88	57.71	68.20	-10.49			peak
3	*	5150.000	48.80	-1.88	46.92	54.00	-7.08			AVG

REMARKS:

- (1) Measurement Value = Reading Level + Correct Factor.
- (2) Margin Level = Measurement Value - Limit Value.

Test Mode	UNII-1_TX AC(HT40) Mode 5190 MHz	Polarization	Vertical
-----------	----------------------------------	--------------	----------

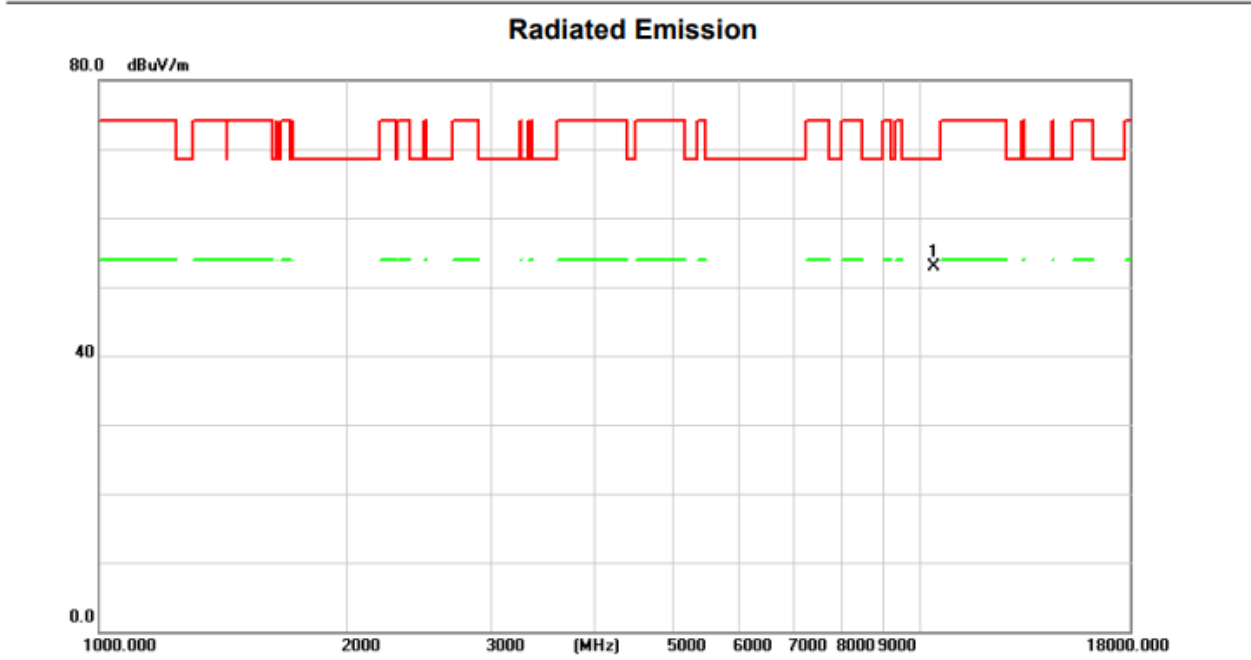

No.	Mk.	Freq.	Reading Level	Correct Factor	Measurement	Limit	Over	Antenna Height	Table Degree
		MHz	dBuV	dB/m	dBuV/m	dBuV/m	dB	cm	degree
1	*	10380.000	43.80	9.06	52.86	68.20	-15.34	peak	

REMARKS:

- (1) Measurement Value = Reading Level + Correct Factor.
- (2) Margin Level = Measurement Value - Limit Value.

Test Mode	UNII-1_TX AC(HT40) Mode 5190 MHz	Polarization	Horizontal
-----------	----------------------------------	--------------	------------

Radiated Emission

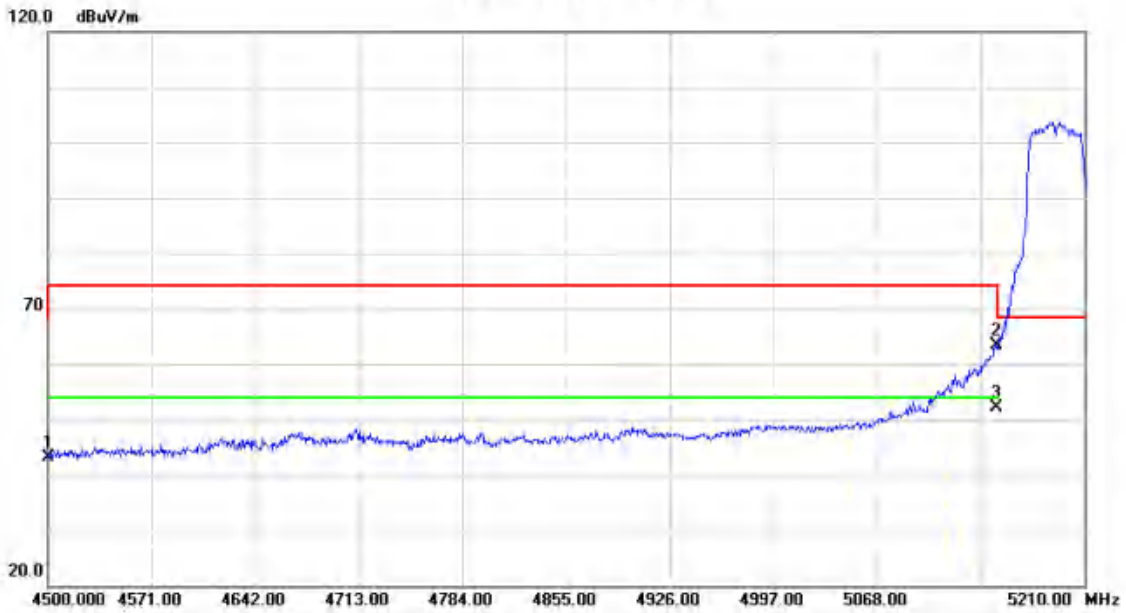

No.	Mk.	Freq.	Reading Level	Correct Factor	Measurement	Limit	Over	Antenna Height	Table Degree	
		MHz	dBuV	dB/m	dBuV/m	dBuV/m	dB	cm	degree	Comment
1		4500.000	46.76	-3.51	43.25	68.20	-24.95			peak
2		5150.000	65.35	-1.88	63.47	68.20	-4.73			peak
3	*	5150.000	53.98	-1.88	52.10	54.00	-1.90			AVG

REMARKS:

- (1) Measurement Value = Reading Level + Correct Factor.
- (2) Margin Level = Measurement Value - Limit Value.

Test Mode	UNII-1_TX N(HT40) Mode 5190 MHz	Polarization	Horizontal
-----------	---------------------------------	--------------	------------

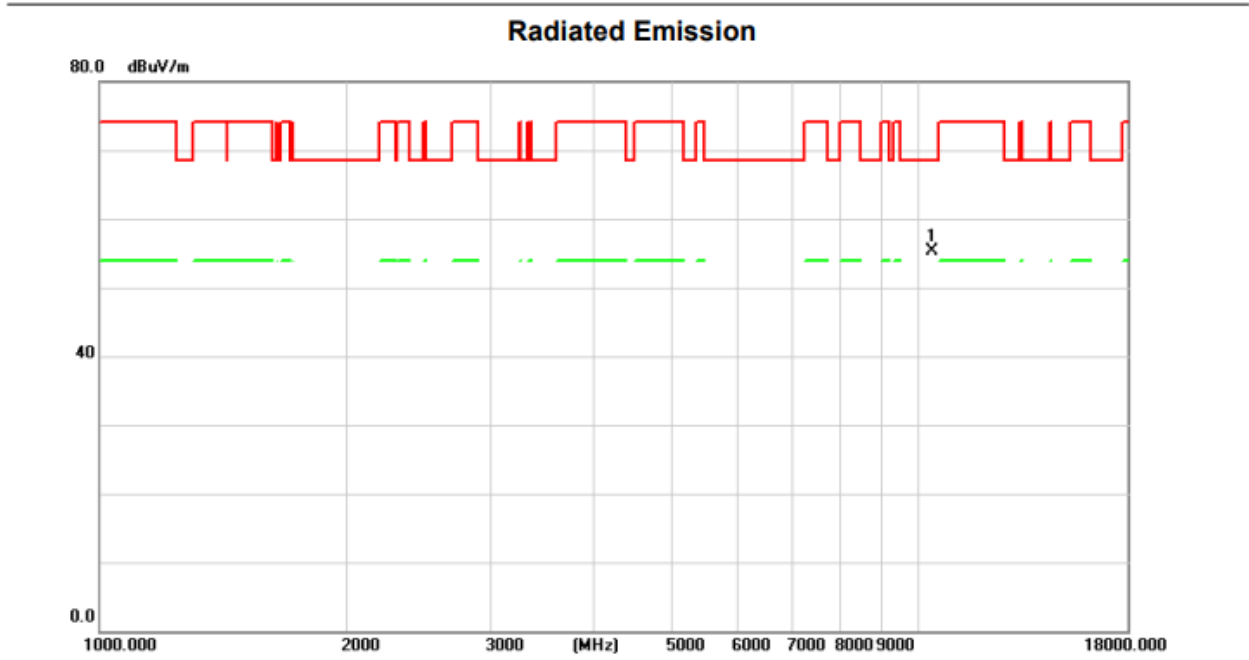

No.	Mk.	Freq.	Reading Level	Correct Factor	Measurement	Limit	Over	Antenna Height	Table Degree	
		MHz	dBuV	dB/m	dBuV/m	dBuV/m	dB	cm	degree	Comment
1	*	10380.000	46.22	9.06	55.28	68.20	-12.92			peak

REMARKS:

- (1) Measurement Value = Reading Level + Correct Factor.
- (2) Margin Level = Measurement Value - Limit Value.

Test Mode	UNII-1_TX AC(HT40) Mode 5230 MHz	Polarization	Vertical
-----------	----------------------------------	--------------	----------

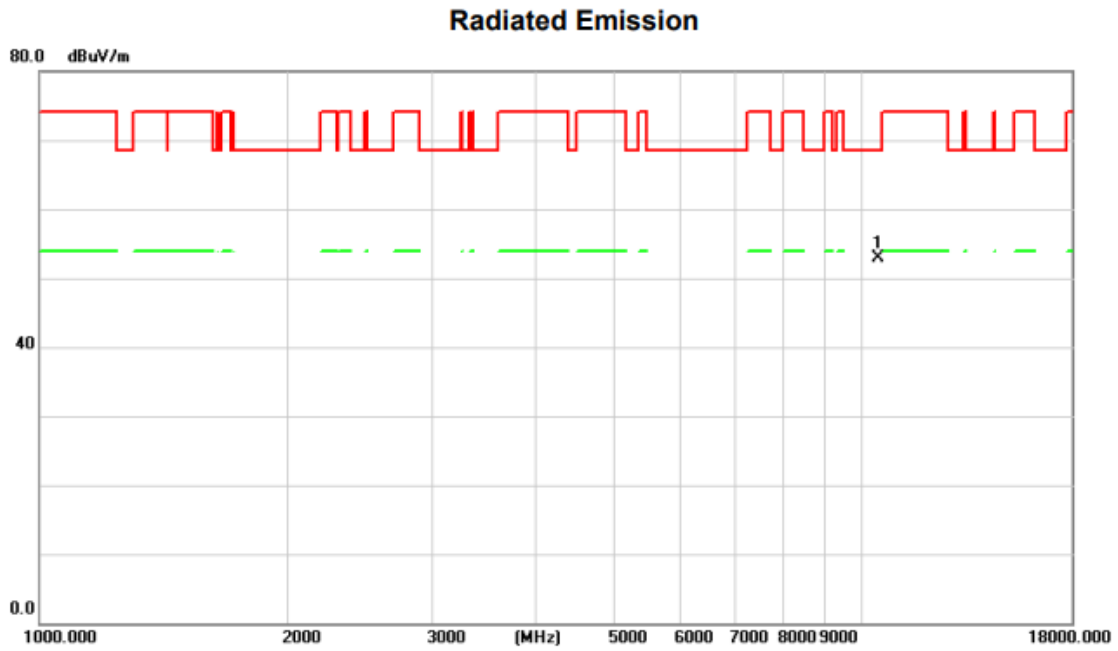

No.	Mk.	Freq.	Reading Level	Correct Factor	Measurement	Limit	Over	Antenna Height	Table Degree	
		MHz	dBuV	dB/m	dBuV/m	dBuV/m	dB	cm	degree	Comment
1	*	10460.000	43.76	9.20	52.96	68.20	-15.24	peak		

REMARKS:

- (1) Measurement Value = Reading Level + Correct Factor.
- (2) Margin Level = Measurement Value - Limit Value.

Test Mode	UNII-1_TX N(HT40) Mode 5230 MHz	Polarization	Horizontal
-----------	---------------------------------	--------------	------------

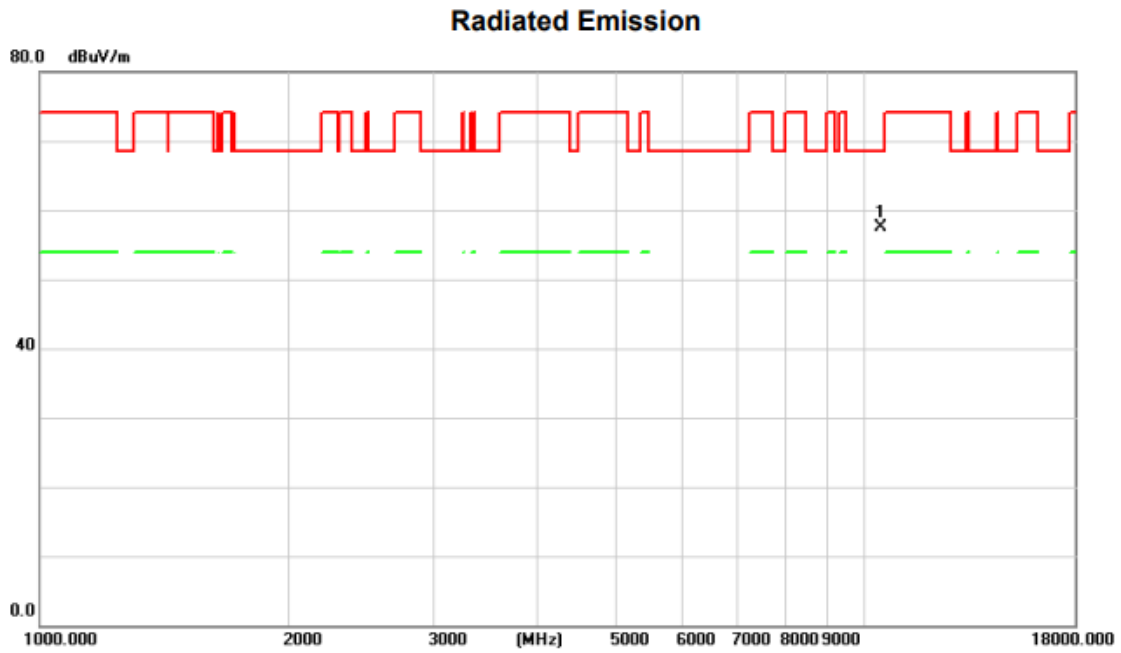

No.	Mk.	Freq.	Reading Level	Correct Factor	Measurement	Limit	Over	Antenna Height	Table Degree
		MHz	dBuV	dB/m	dBuV/m	dBuV/m	dB	cm	degree
1	*	10460.000	48.34	9.20	57.54	68.20	-10.66	peak	

REMARKS:

- (1) Measurement Value = Reading Level + Correct Factor.
- (2) Margin Level = Measurement Value - Limit Value.

Test Mode	UNII-1_TX AC(VHT80) Mode 5210 MHz	Polarization	Vertical
-----------	-----------------------------------	--------------	----------

Radiated Emission

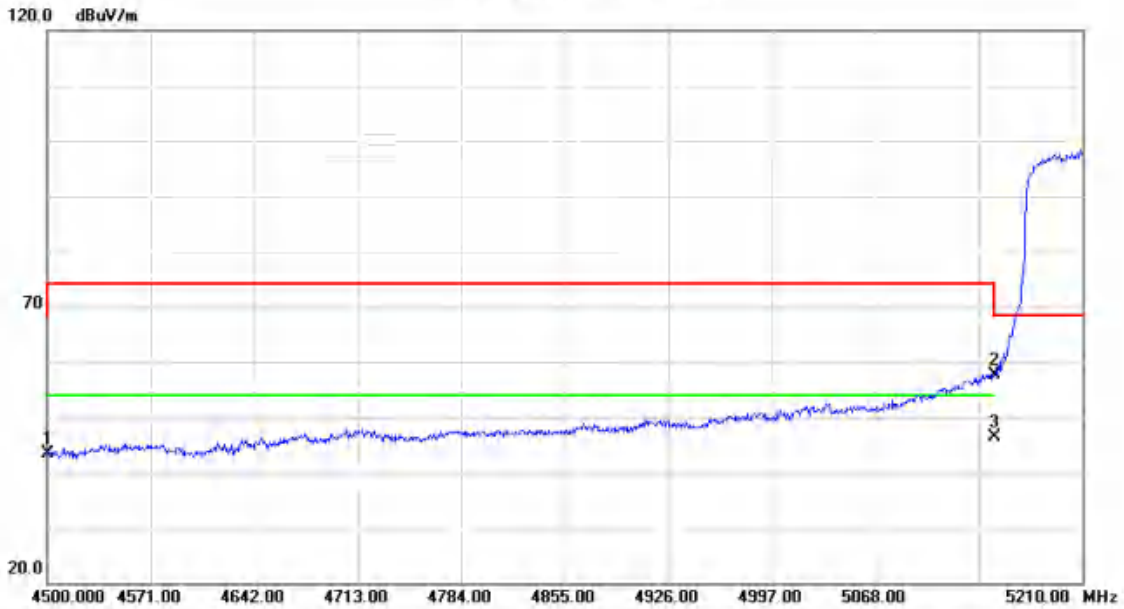

No.	Mk.	Freq.	Reading Level	Correct Factor	Measurement	Limit	Over	Antenna Height	Table Degree	
		MHz	dBuV	dB/m	dBuV/m	dBuV/m	dB	cm	degree	Comment
1		4500.000	46.98	-3.51	43.47	68.20	-24.73			peak
2		5150.000	59.40	-1.88	57.52	68.20	-10.68			peak
3	*	5150.000	48.25	-1.88	46.37	54.00	-7.63			AVG

REMARKS:

- (1) Measurement Value = Reading Level + Correct Factor.
- (2) Margin Level = Measurement Value - Limit Value.

Test Mode	UNII-1_TX AC(VHT80) Mode 5210 MHz	Polarization	Vertical
-----------	-----------------------------------	--------------	----------

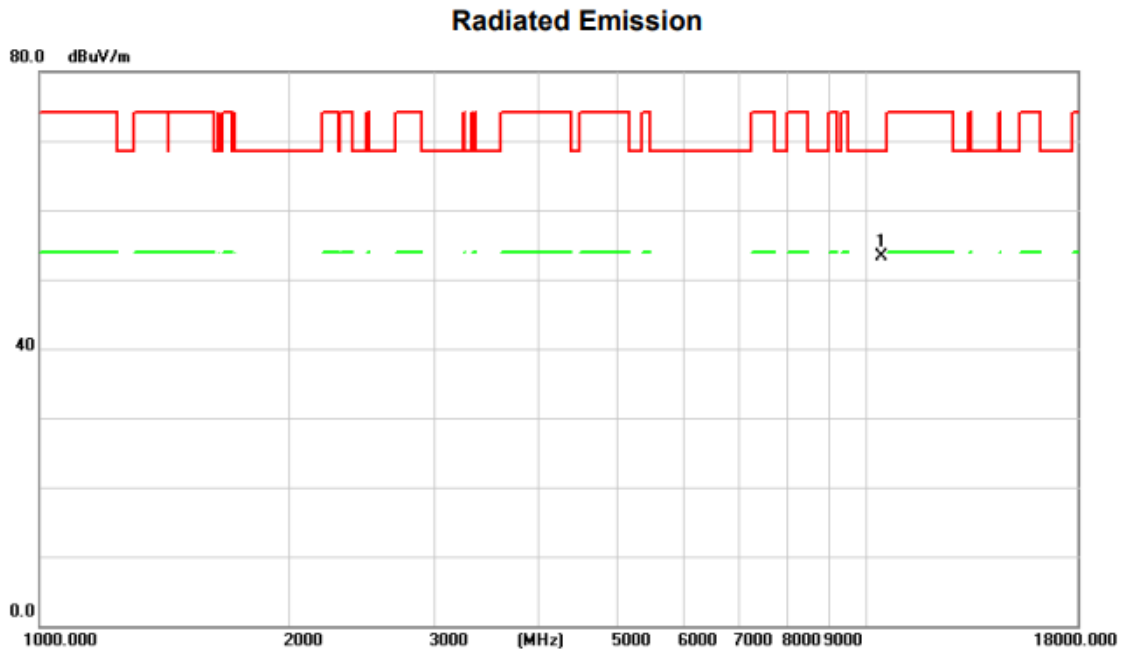

No.	Mk.	Freq.	Reading Level	Correct Factor	Measurement	Limit	Over	Antenna Height	Table Degree	
		MHz	dBuV	dB/m	dBuV/m	dBuV/m	dB	cm	degree	Comment
1	*	10420.000	44.27	9.12	53.39	68.20	-14.81	peak		

REMARKS:

- (1) Measurement Value = Reading Level + Correct Factor.
- (2) Margin Level = Measurement Value - Limit Value.

Test Mode	UNII-1_TX AC(VHT80) Mode 5210 MHz	Polarization	Horizontal
-----------	-----------------------------------	--------------	------------

Radiated Emission

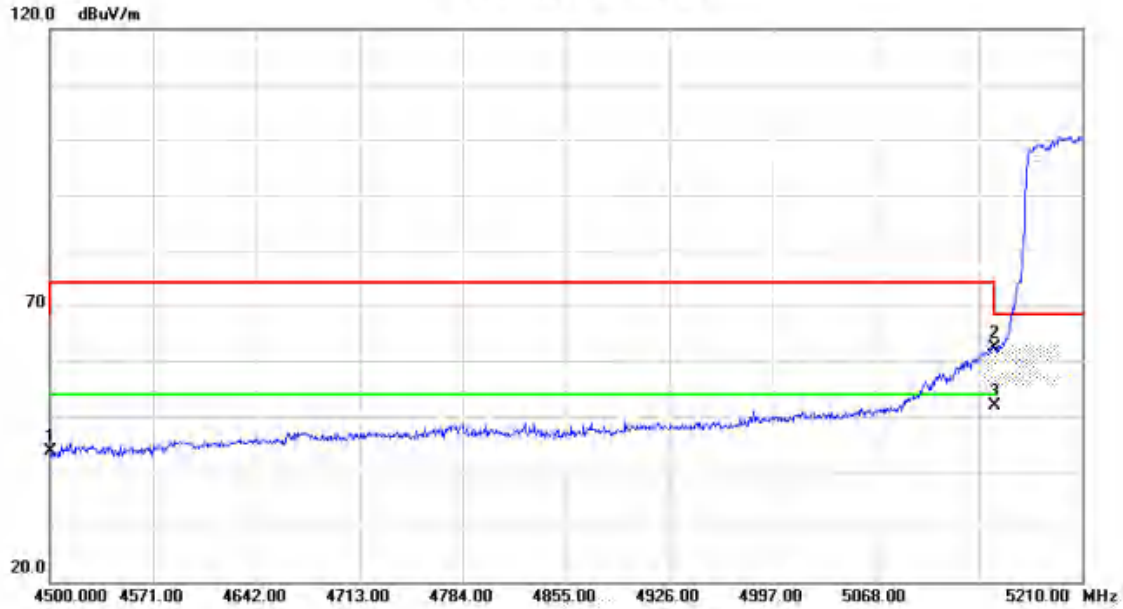

No.	Mk.	Freq.	Reading Level	Correct Factor	Measurement	Limit	Over	Antenna Height	Table Degree	
		MHz	dBuV	dB/m	dBuV/m	dBuV/m	dB	cm	degree	Comment
1		4500.000	47.13	-3.51	43.62	68.20	-24.58			peak
2		5150.000	64.25	-1.88	62.37	68.20	-5.83			peak
3	*	5150.000	53.67	-1.88	51.79	54.00	-2.21			AVG

REMARKS:

- (1) Measurement Value = Reading Level + Correct Factor.
- (2) Margin Level = Measurement Value - Limit Value.

Test Mode	UNII-1_TX AC(VHT80) Mode 5210 MHz	Polarization	Horizontal
-----------	-----------------------------------	--------------	------------

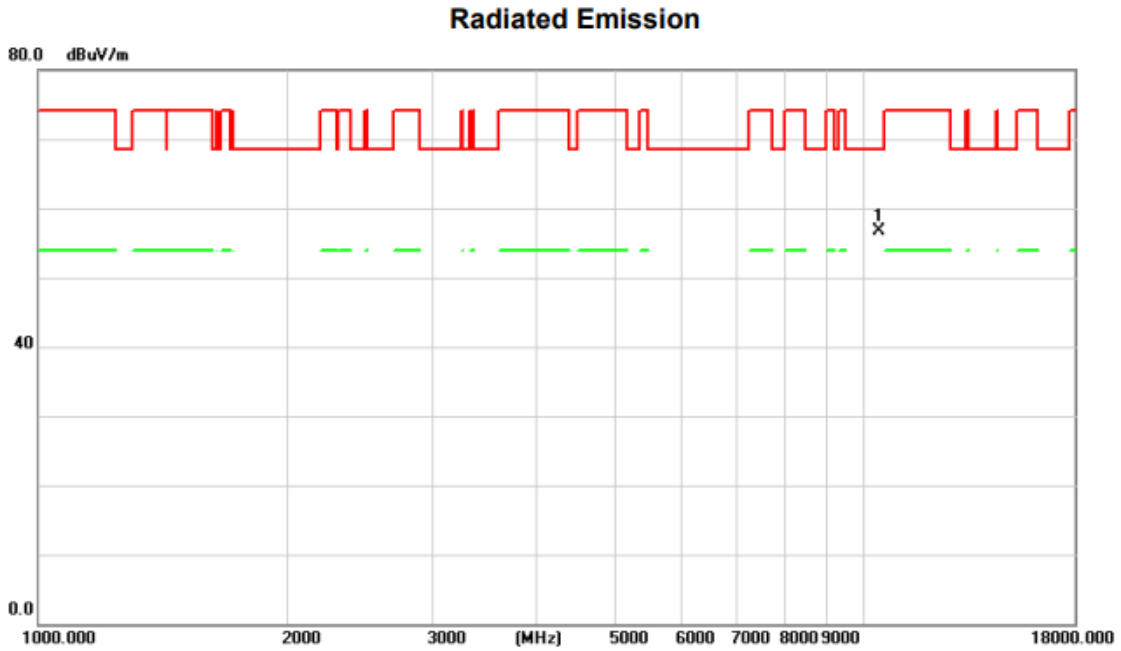

No.	Mk.	Freq.	Reading Level	Correct Factor	Measurement	Limit	Over	Antenna Height	Table Degree
		MHz	dBuV	dB/m	dBuV/m	dBuV/m	dB	cm	degree
1	*	10420.000	47.62	9.12	56.74	68.20	-11.46	peak	

REMARKS:

- (1) Measurement Value = Reading Level + Correct Factor.
- (2) Margin Level = Measurement Value - Limit Value.

Test Mode	UNII-2A_TX A Mode 5260 MHz	Polarization	Vertical
-----------	----------------------------	--------------	----------

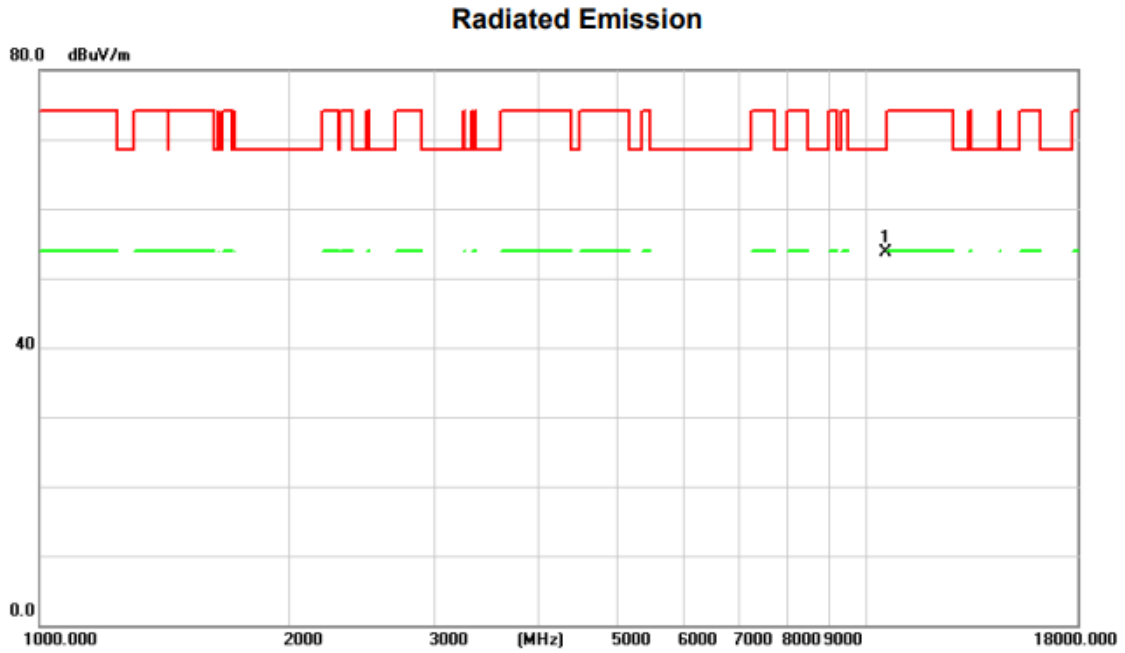

No.	Mk.	Freq.	Reading Level	Correct Factor	Measurement	Limit	Over	Antenna Height	Table Degree
		MHz	dBuV	dB/m	dBuV/m	dBuV/m	dB	cm	degree
1	*	10520.000	44.47	9.30	53.77	68.20	-14.43	peak	

REMARKS:

- (1) Measurement Value = Reading Level + Correct Factor.
- (2) Margin Level = Measurement Value - Limit Value.

Test Mode	UNII-2A_TX A Mode 5260 MHz	Polarization	Horizontal
-----------	----------------------------	--------------	------------

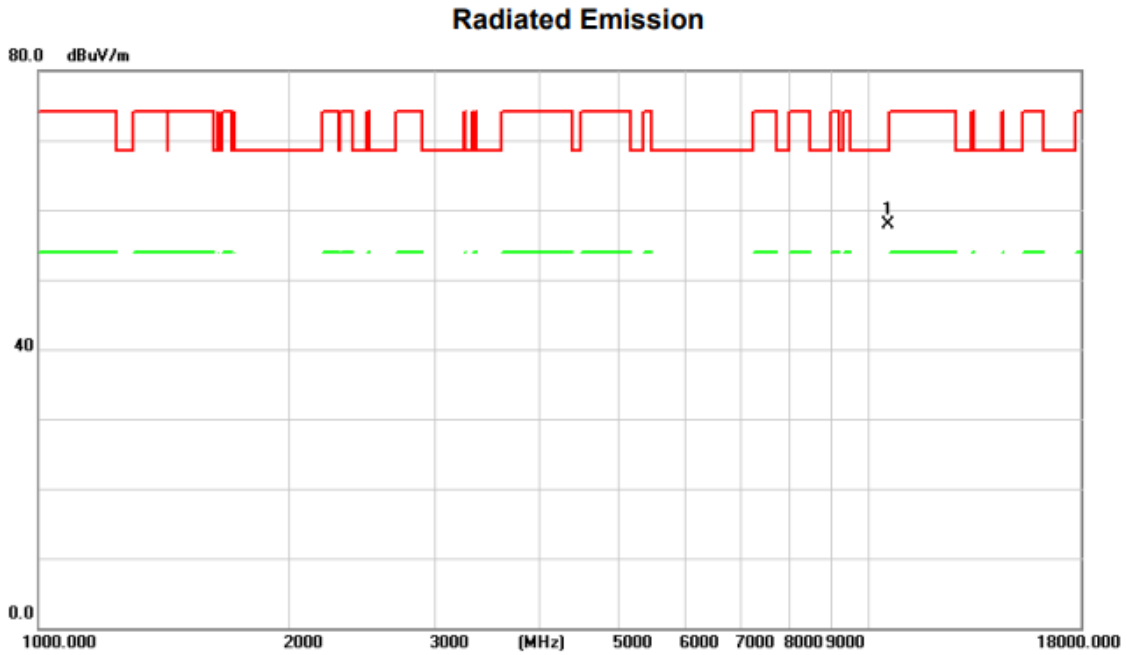

No.	Mk.	Freq.	Reading Level	Correct Factor	Measurement	Limit	Over	Antenna Height	Table Degree	
		MHz	dBuV	dB/m	dBuV/m	dBuV/m	dB	cm	degree	Comment
1	*	10520.000	48.64	9.30	57.94	68.20	-10.26	peak		

REMARKS:

- (1) Measurement Value = Reading Level + Correct Factor.
- (2) Margin Level = Measurement Value - Limit Value.

Test Mode	UNII-2A_TX A Mode 5280 MHz	Polarization	Vertical
-----------	----------------------------	--------------	----------

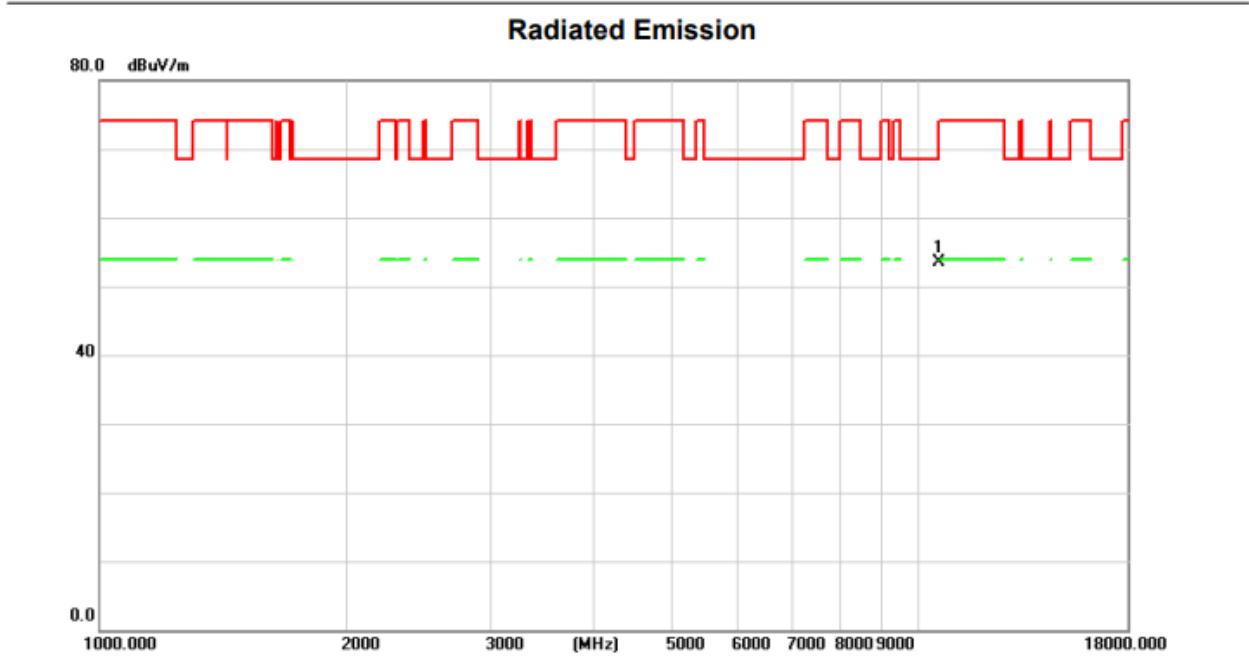

No.	Mk.	Freq.	Reading Level	Correct Factor	Measurement	Limit	Over	Antenna Height	Table Degree	
		MHz	dBuV	dB/m	dBuV/m	dBuV/m	dB	cm	degree	Comment
1	*	10560.000	44.05	9.37	53.42	68.20	-14.78	peak		

REMARKS:

- (1) Measurement Value = Reading Level + Correct Factor.
- (2) Margin Level = Measurement Value - Limit Value.

Test Mode	UNII-2A_TX A Mode 5280 MHz	Polarization	Horizontal
-----------	----------------------------	--------------	------------

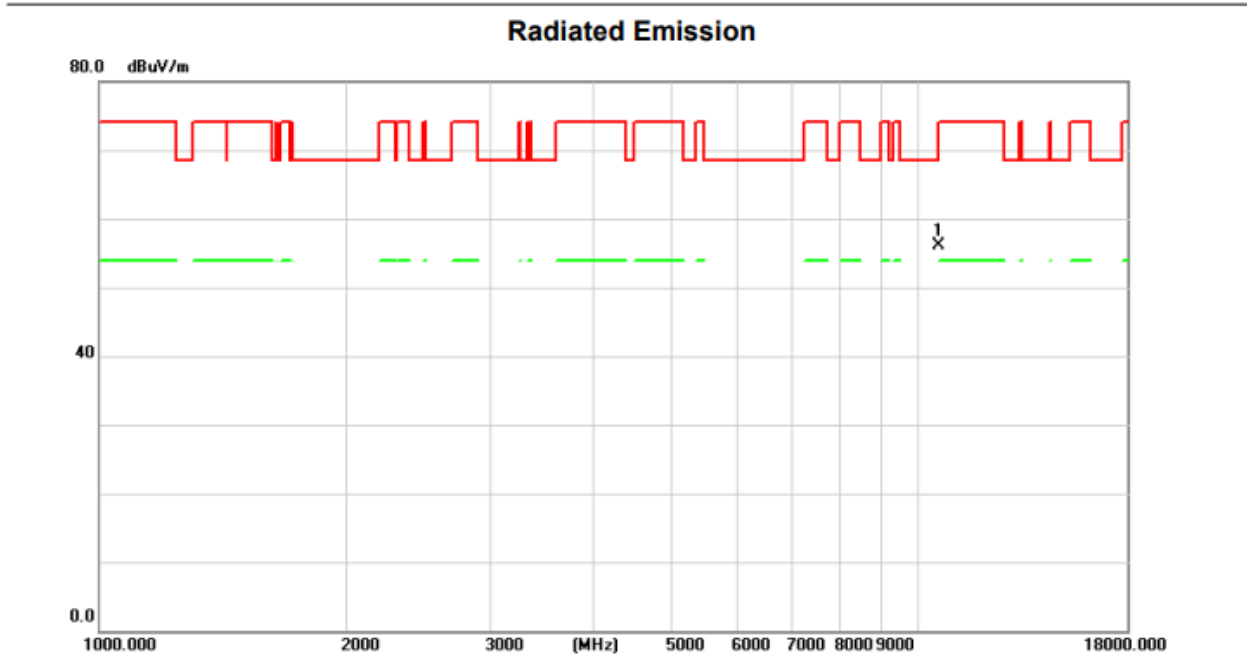

No.	Mk.	Freq.	Reading Level	Correct Factor	Measurement	Limit	Over	Antenna Height	Table Degree
		MHz	dBuV	dB/m	dBuV/m	dBuV/m	dB	cm	degree
1	*	10560.000	46.65	9.37	56.02	68.20	-12.18	peak	

REMARKS:

- (1) Measurement Value = Reading Level + Correct Factor.
- (2) Margin Level = Measurement Value - Limit Value.

Test Mode	UNII-2A_TX A Mode 5320 MHz	Polarization	Vertical
-----------	----------------------------	--------------	----------

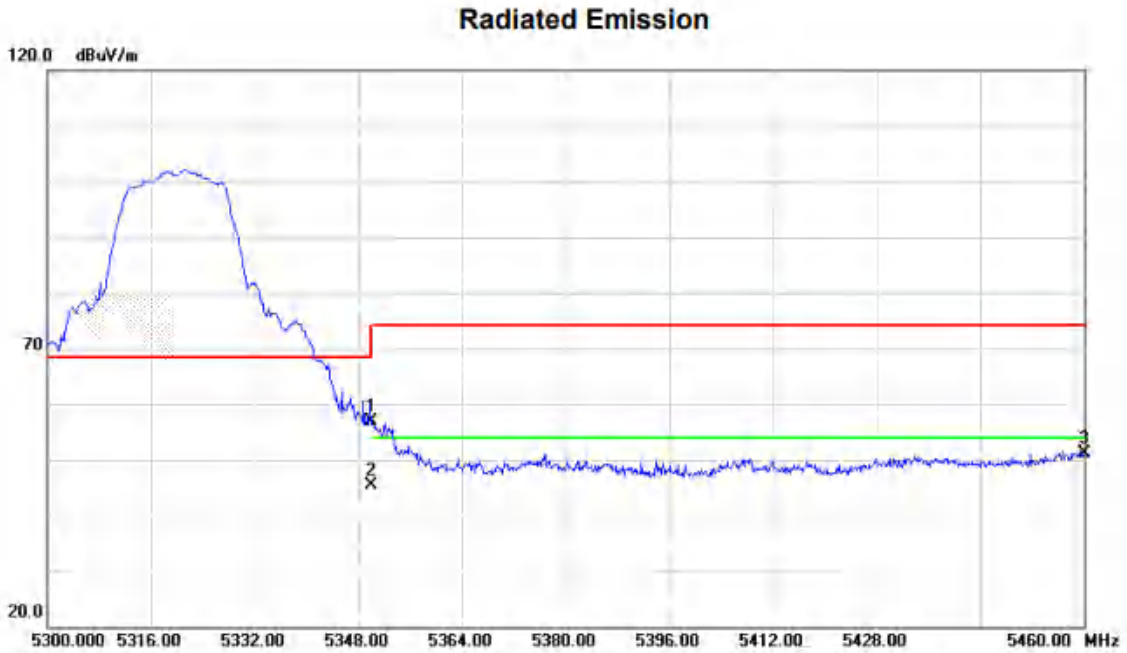

No.	Mk.	Freq.	Reading Level	Correct Factor	Measurement	Limit	Over	Antenna Height	Table Degree	
		MHz	dBuV	dB/m	dBuV/m	dBuV/m	dB	cm	degree	Comment
1		5350.000	59.55	-2.78	56.77	68.20	-11.43			peak
2	*	5350.000	48.16	-2.78	45.38	54.00	-8.62			AVG
3		5460.000	53.83	-2.67	51.16	68.20	-17.04			peak

REMARKS:

- (1) Measurement Value = Reading Level + Correct Factor.
- (2) Margin Level = Measurement Value - Limit Value.

Test Mode	UNII-2A_TX A Mode 5320 MHz	Polarization	Vertical
-----------	----------------------------	--------------	----------

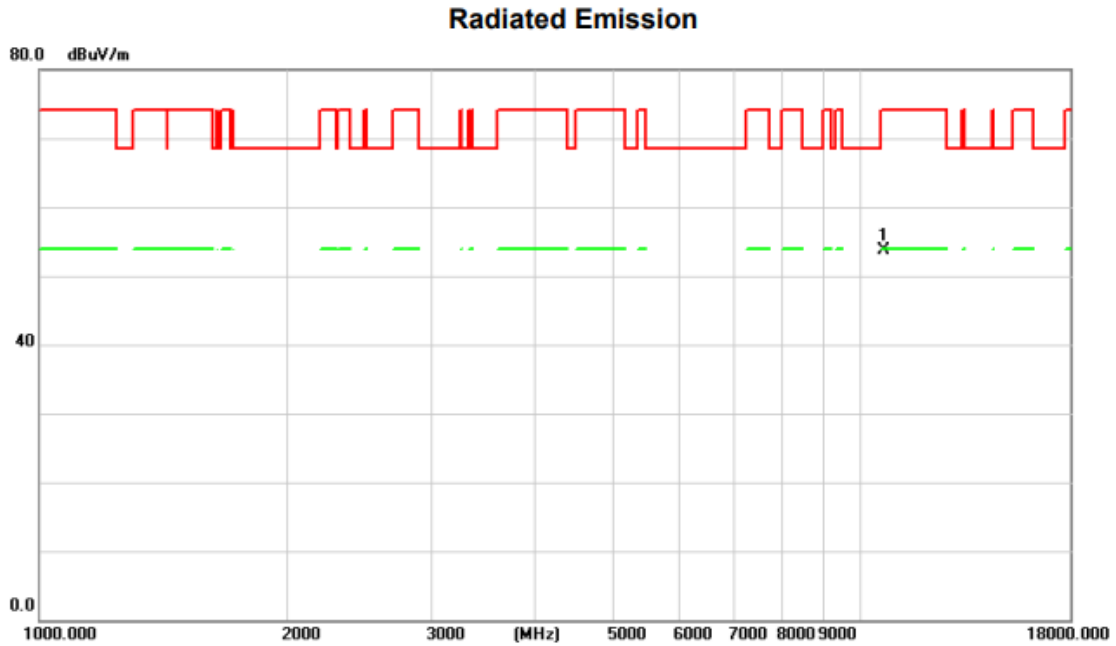

No.	Mk.	Freq.	Reading Level	Correct Factor	Measurement	Limit	Over	Antenna Height	Table Degree	Comment
		MHz	dBuV	dB/m	dBuV/m	dBuV/m	dB	cm	degree	
1	*	10640.000	44.09	9.52	53.61	74.00	-20.39	peak		

REMARKS:

- (1) Measurement Value = Reading Level + Correct Factor.
- (2) Margin Level = Measurement Value - Limit Value.

Test Mode	UNII-2A_TX A Mode 5320 MHz	Polarization	Horizontal
-----------	----------------------------	--------------	------------

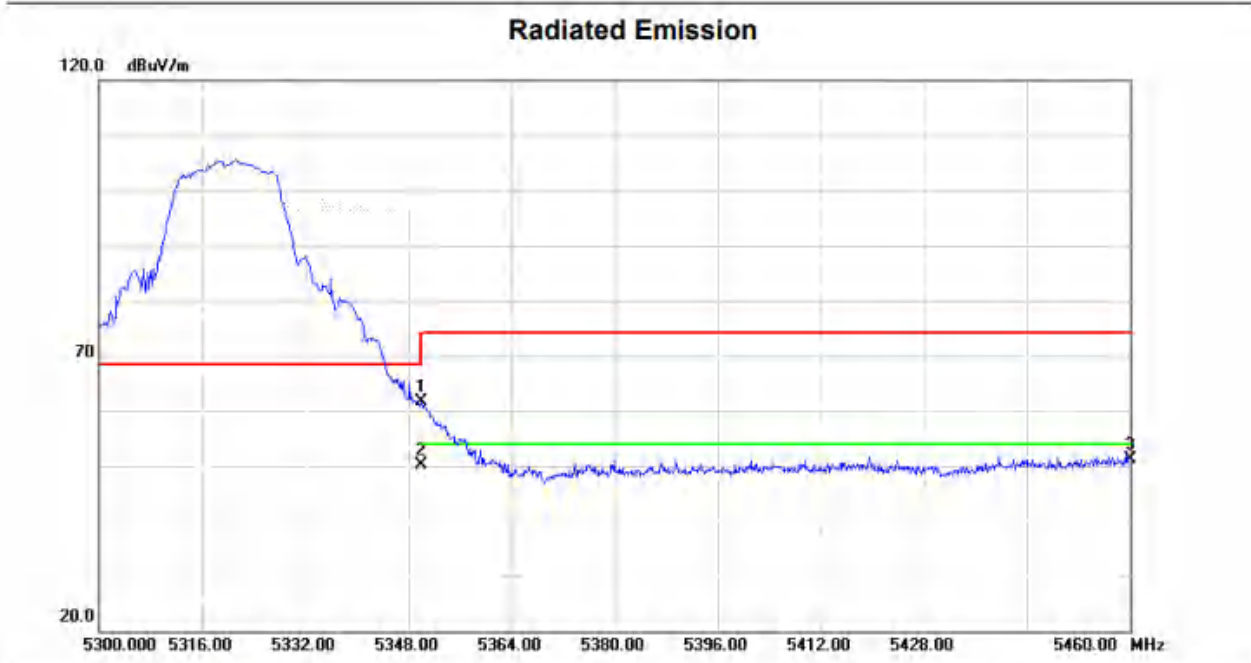

No.	Mk.	Freq.	Reading Level	Correct Factor	Measurement	Limit	Over	Antenna Height	Table Degree	
		MHz	dBuV	dB/m	dBuV/m	dBuV/m	dB	cm	degree	Comment
1		5350.000	64.43	-2.78	61.65	68.20	-6.55			peak
2	*	5350.000	52.91	-2.78	50.13	54.00	-3.87			AVG
3		5460.000	53.87	-2.67	51.20	68.20	-17.00			peak

REMARKS:

- (1) Measurement Value = Reading Level + Correct Factor.
- (2) Margin Level = Measurement Value - Limit Value.

Test Mode	UNII-2A_TX A Mode 5320 MHz	Polarization	Horizontal
-----------	----------------------------	--------------	------------

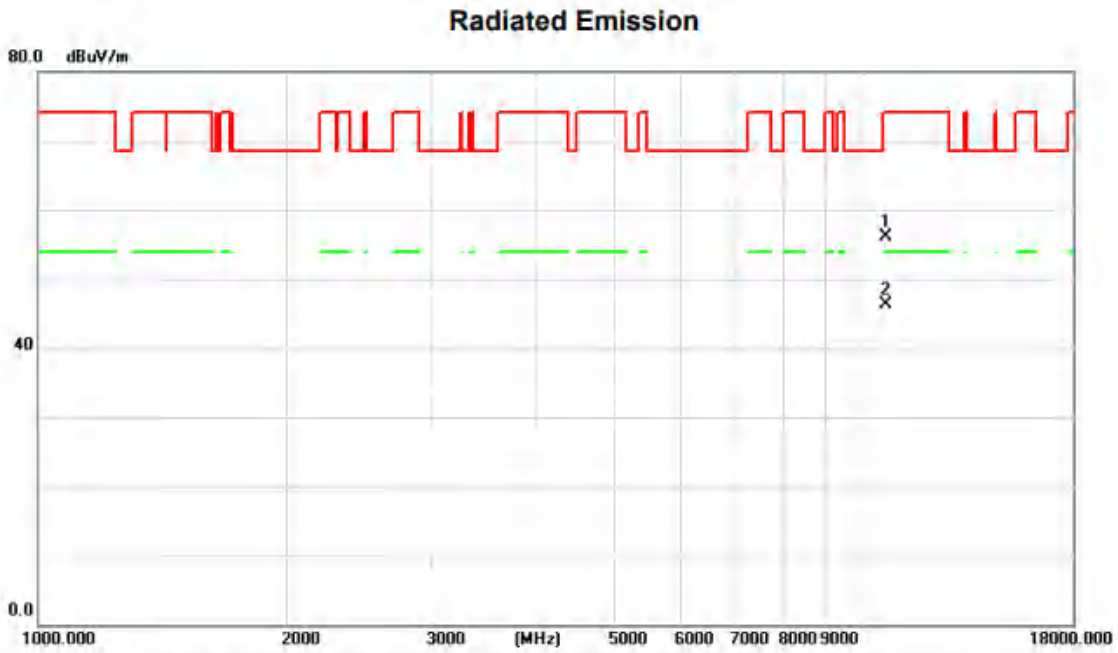

No.	Mk.	Freq.	Reading Level	Correct Factor	Measurement	Limit	Over	Antenna Height	Table Degree
		MHz	dBuV	dB/m	dBuV/m	dBuV/m	dB	cm	degree
1		10640.000	46.59	9.52	56.11	74.00	-17.89	peak	
2	*	10640.000	36.80	9.52	46.32	54.00	-7.68	AVG	

REMARKS:

(1) Measurement Value = Reading Level + Correct Factor.

(2) Margin Level = Measurement Value - Limit Value.

Test Mode	UNII-2A_TX N(HT20) Mode 5260 MHz	Polarization	Vertical
-----------	----------------------------------	--------------	----------

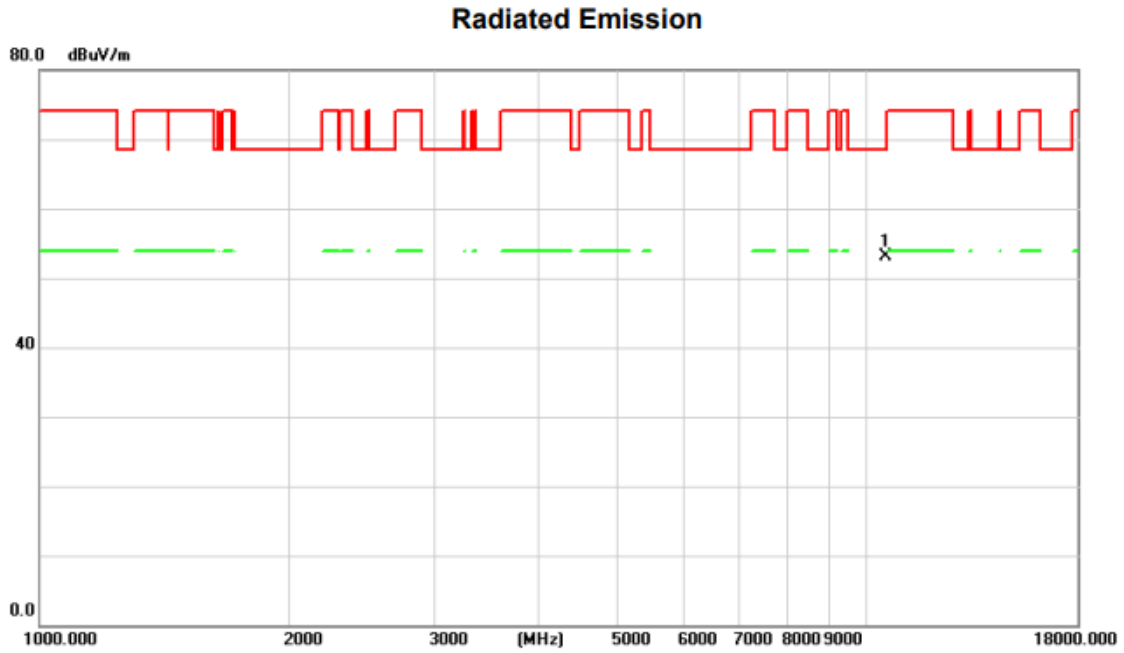

No.	Mk.	Freq.	Reading Level	Correct Factor	Measurement	Limit	Over	Antenna Height	Table Degree	
		MHz	dBuV	dB/m	dBuV/m	dBuV/m	dB	cm	degree	Comment
1	*	10520.000	43.83	9.30	53.13	68.20	-15.07	peak		

REMARKS:

- (1) Measurement Value = Reading Level + Correct Factor.
- (2) Margin Level = Measurement Value - Limit Value.

Test Mode	UNII-2A_TX N(HT20) Mode 5260 MHz	Polarization	Horizontal
-----------	----------------------------------	--------------	------------

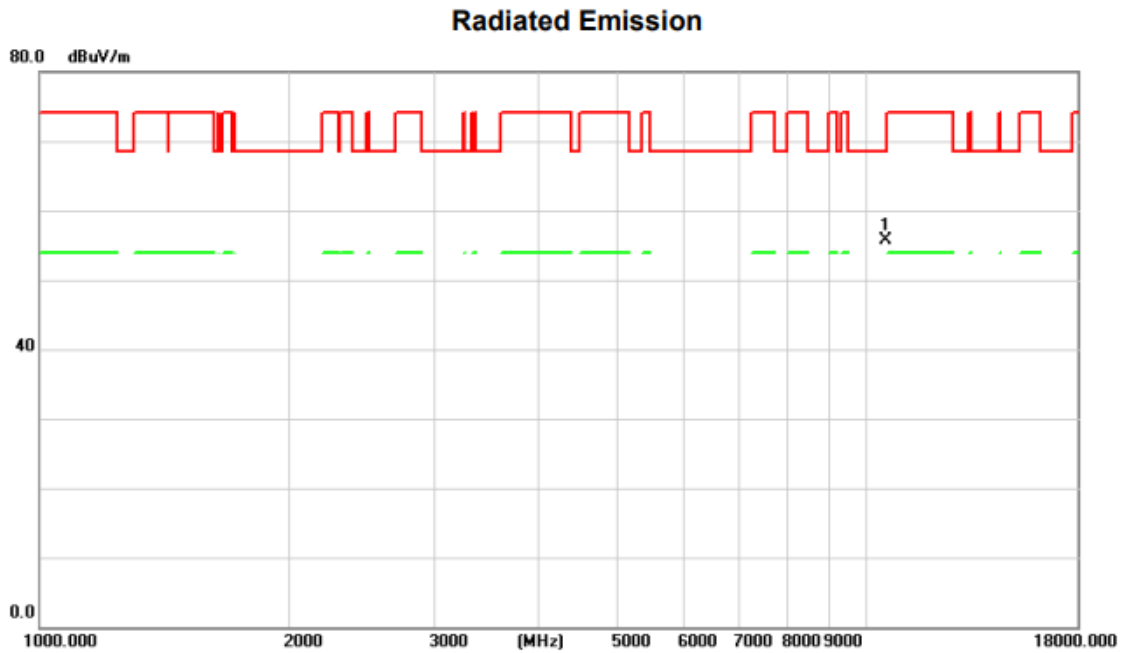

No.	Mk.	Freq.	Reading Level	Correct Factor	Measurement	Limit	Over	Antenna Height	Table Degree	
		MHz	dBuV	dB/m	dBuV/m	dBuV/m	dB	cm	degree	Comment
1	*	10520.000	46.36	9.30	55.66	68.20	-12.54	peak		

REMARKS:

- (1) Measurement Value = Reading Level + Correct Factor.
- (2) Margin Level = Measurement Value - Limit Value.

Test Mode	UNII-2A_TX N(HT20) Mode 5280 MHz	Polarization	Vertical
-----------	----------------------------------	--------------	----------

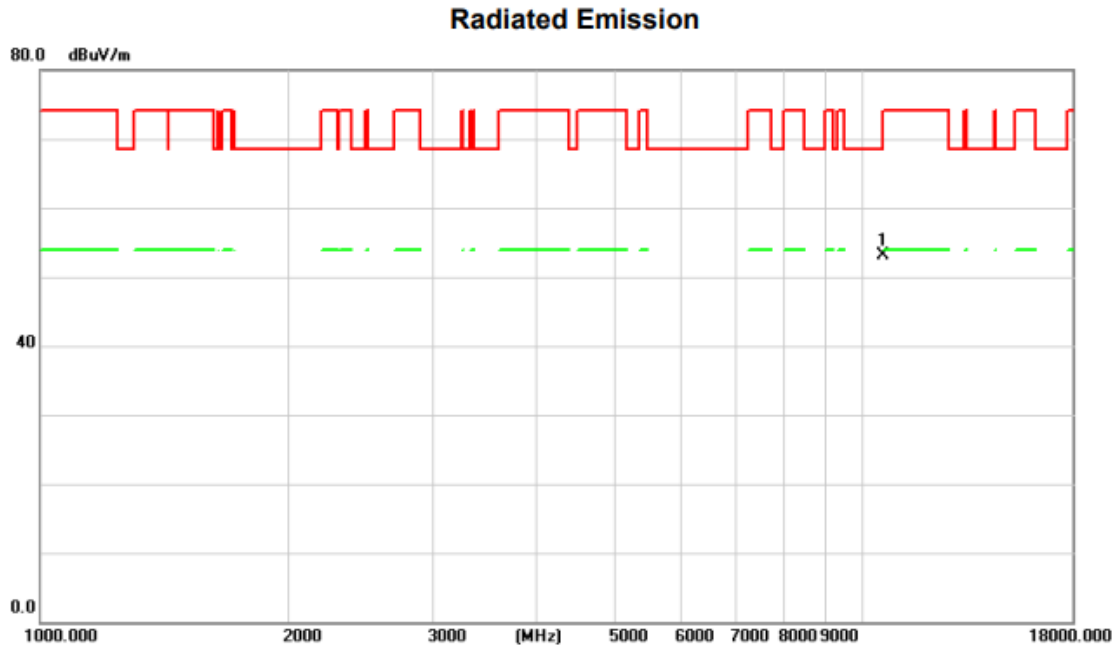

No.	Mk.	Freq.	Reading Level	Correct Factor	Measurement	Limit	Over	Antenna Height	Table Degree
		MHz	dBuV	dB/m	dBuV/m	dBuV/m	dB	cm	degree
1	*	10560.000	43.71	9.37	53.08	68.20	-15.12	peak	

REMARKS:

- (1) Measurement Value = Reading Level + Correct Factor.
- (2) Margin Level = Measurement Value - Limit Value.

Test Mode	UNII-2A_TX N(HT20) Mode 5280 MHz	Polarization	Horizontal
-----------	----------------------------------	--------------	------------

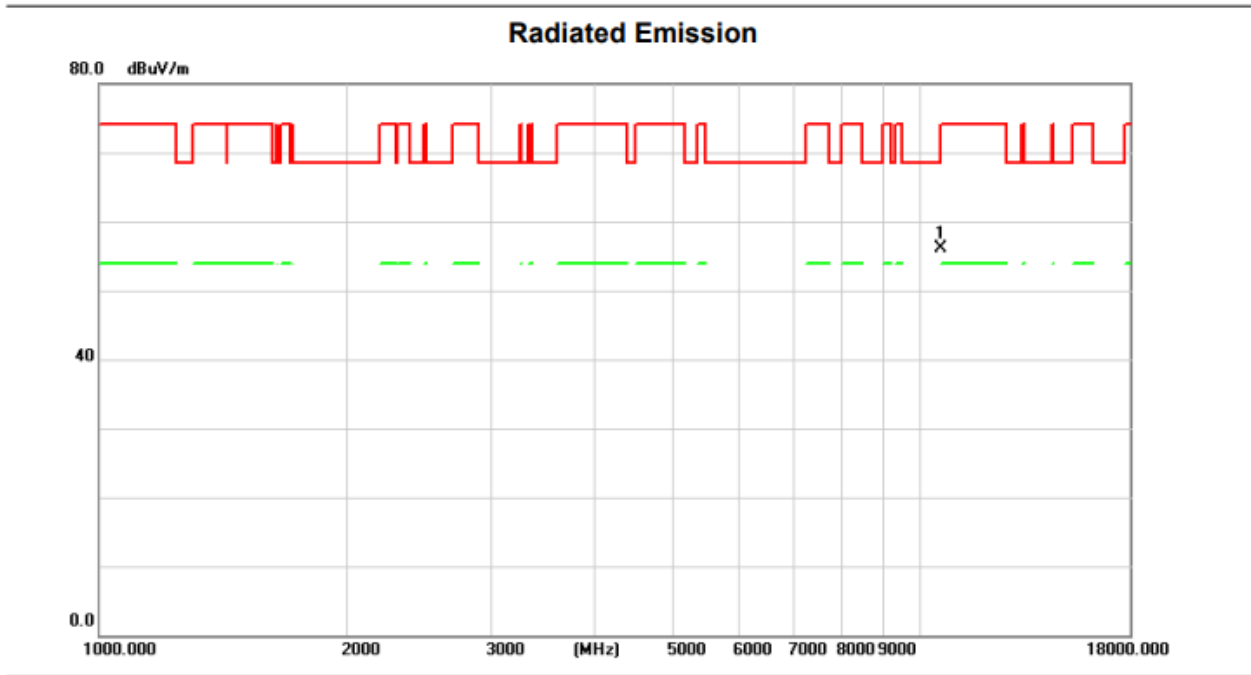

No.	Mk.	Freq.	Reading Level	Correct Factor	Measurement	Limit	Over	Antenna Height	Table Degree
		MHz	dBuV	dB/m	dBuV/m	dBuV/m	dB	cm	degree
1	*	10560.000	46.66	9.37	56.03	68.20	-12.17	peak	

REMARKS:

- (1) Measurement Value = Reading Level + Correct Factor.
- (2) Margin Level = Measurement Value - Limit Value.

Test Mode	UNII-2A_TX N(HT20) Mode 5320 MHz	Polarization	Vertical
-----------	----------------------------------	--------------	----------

Radiated Emission

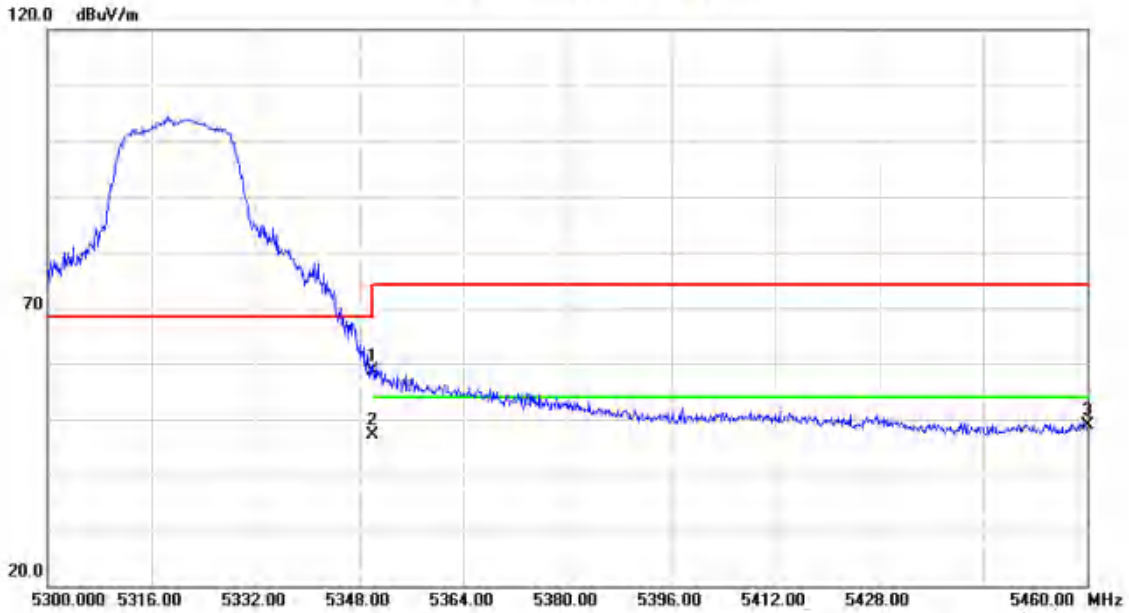

No.	Mk.	Freq.	Reading Level	Correct Factor	Measurement	Limit	Over	Antenna Height	Table Degree	
		MHz	dBuV	dB/m	dBuV/m	dBuV/m	dB	cm	degree	Comment
1		5350.000	61.41	-2.78	58.63	68.20	-9.57			peak
2	*	5350.000	49.99	-2.78	47.21	54.00	-6.79			AVG
3		5460.000	51.55	-2.67	48.88	68.20	-19.32			peak

REMARKS:

- (1) Measurement Value = Reading Level + Correct Factor.
- (2) Margin Level = Measurement Value - Limit Value.

Test Mode	UNII-2A_TX N(HT20) Mode 5320 MHz	Polarization	Vertical
-----------	----------------------------------	--------------	----------

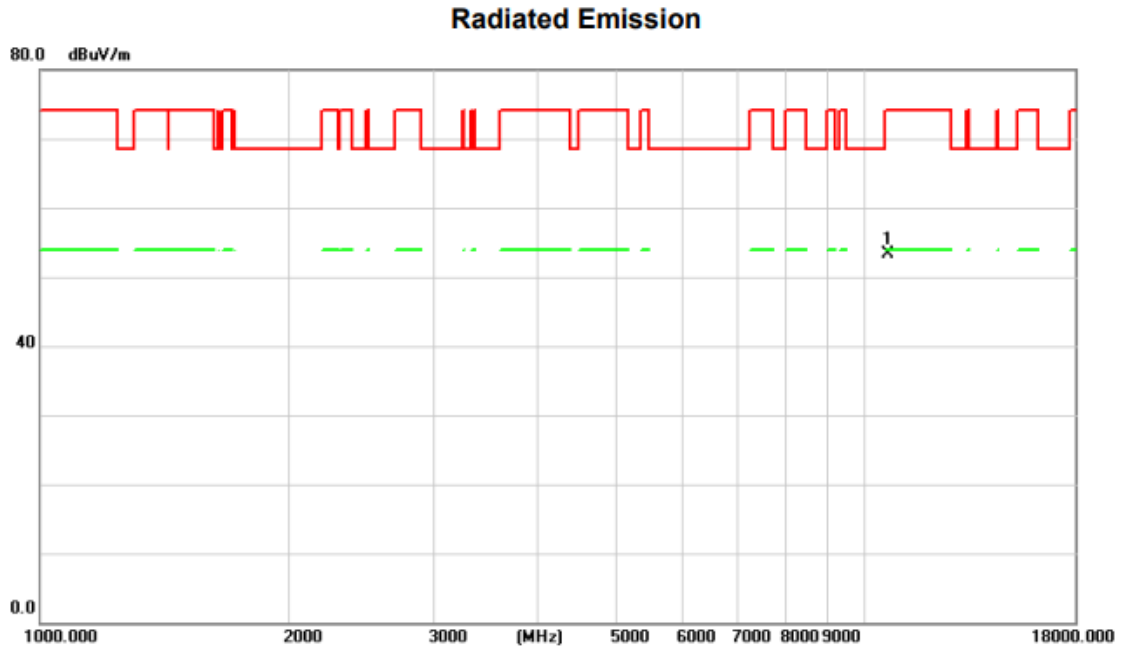

No.	Mk.	Freq.	Reading Level	Correct Factor	Measurement	Limit	Over	Antenna Height	Table Degree	
		MHz	dBuV	dB/m	dBuV/m	dBuV/m	dB	cm	degree	Comment
1	*	10640.000	43.77	9.52	53.29	74.00	-20.71			peak

REMARKS:

- (1) Measurement Value = Reading Level + Correct Factor.
- (2) Margin Level = Measurement Value - Limit Value.

Test Mode	UNII-2A_TX N(HT20) Mode 5320 MHz	Polarization	Horizontal
-----------	----------------------------------	--------------	------------

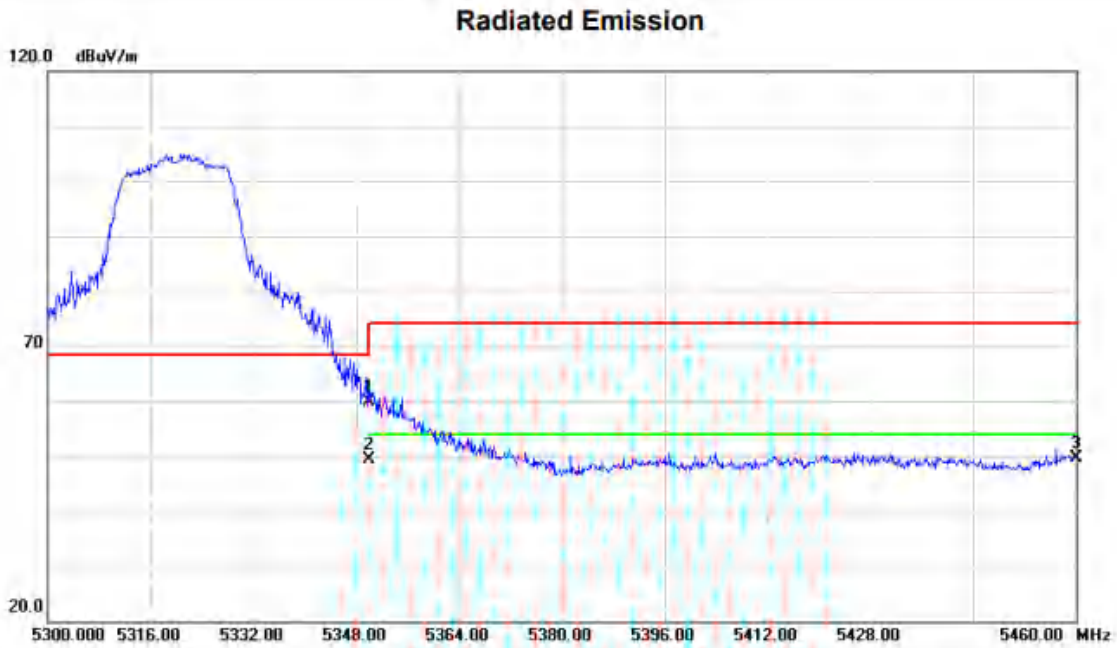

No.	Mk.	Freq. MHz	Reading Level dBuV	Correct Factor dB/m	Measure- ment dBuV/m	Limit dBuV/m	Over dB	Antenna Height cm	Table Degree degree	Comment
1		5350.000	62.74	-2.78	59.96	68.20	-8.24			peak
2	*	5350.000	52.15	-2.78	49.37	54.00	-4.63			AVG
3		5460.000	52.40	-2.67	49.73	68.20	-18.47			peak

REMARKS:

- (1) Measurement Value = Reading Level + Correct Factor.
- (2) Margin Level = Measurement Value - Limit Value.

Test Mode	UNII-2A_TX N(HT20) Mode 5320 MHz	Polarization	Horizontal
-----------	----------------------------------	--------------	------------

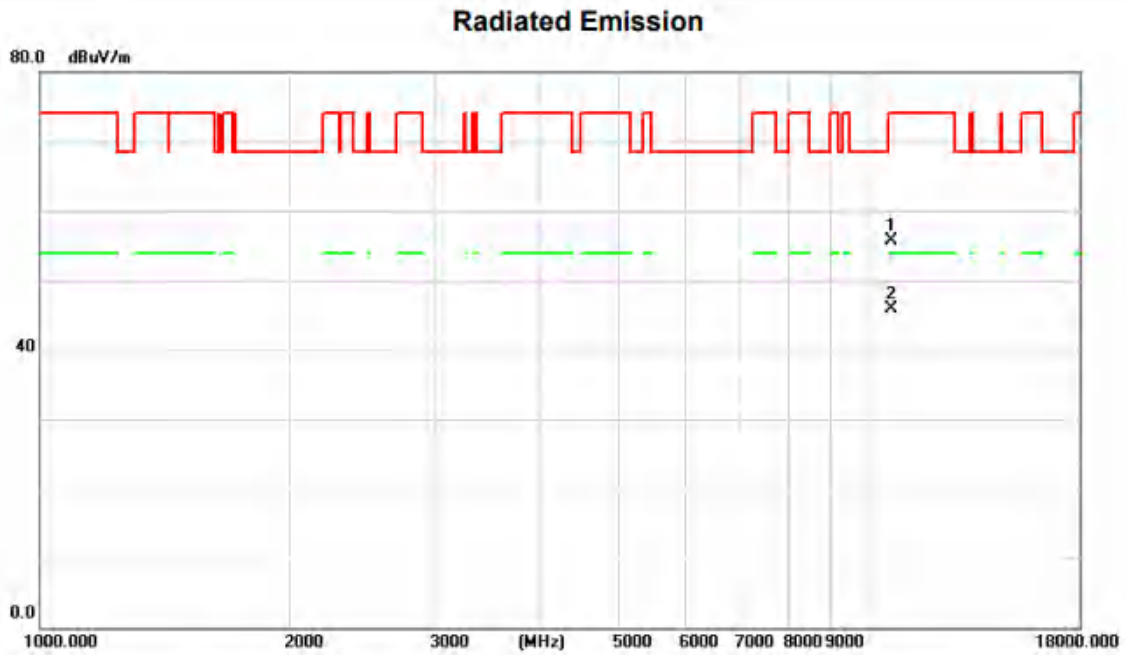

No.	Mk.	Freq.	Reading Level	Correct Factor	Measurement	Limit	Over	Antenna Height	Table Degree	
		MHz	dBuV	dB/m	dBuV/m	dBuV/m	dB	cm	degree	Comment
1		10640.000	46.21	9.52	55.73	74.00	-18.27	peak		
2	*	10640.000	36.43	9.52	45.95	54.00	-8.05	AVG		

REMARKS:

(1) Measurement Value = Reading Level + Correct Factor.

(2) Margin Level = Measurement Value - Limit Value.

Test Mode	UNII-2A_TX N(HT40) Mode 5270 MHz	Polarization	Vertical
-----------	----------------------------------	--------------	----------

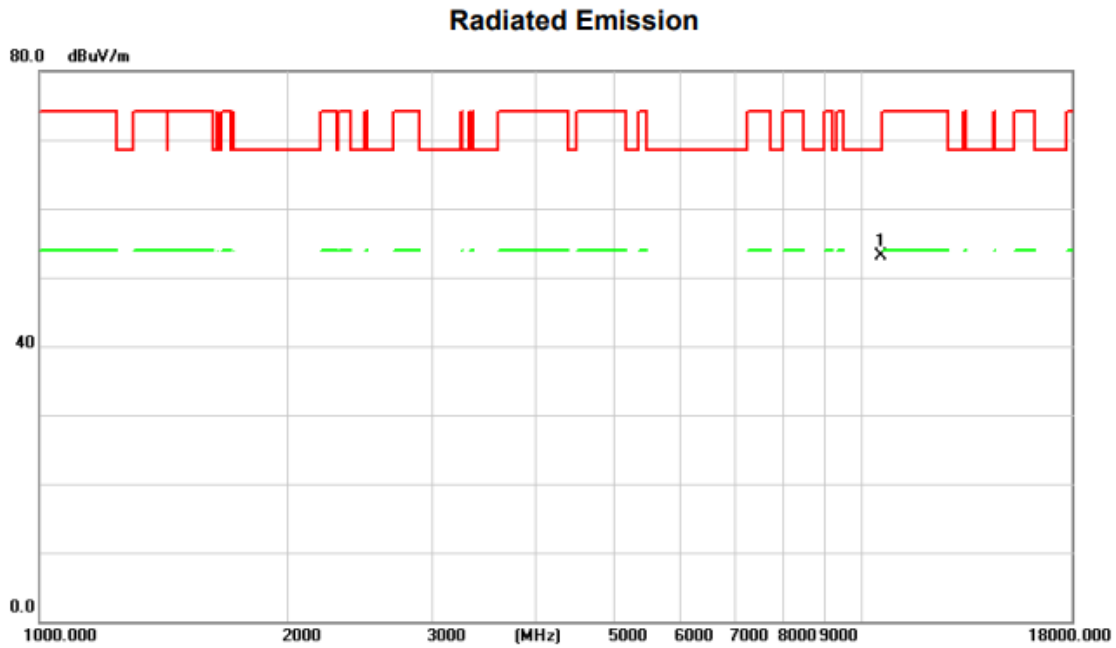

No.	Mk.	Freq.	Reading Level	Correct Factor	Measurement	Limit	Over	Antenna Height	Table Degree	
		MHz	dBuV	dB/m	dBuV/m	dBuV/m	dB	cm	degree	Comment
1	*	10540.000	43.76	9.34	53.10	68.20	-15.10	peak		

REMARKS:

- (1) Measurement Value = Reading Level + Correct Factor.
- (2) Margin Level = Measurement Value - Limit Value.

Test Mode	UNII-2A_TX N(HT40) Mode 5270 MHz	Polarization	Horizontal
-----------	----------------------------------	--------------	------------

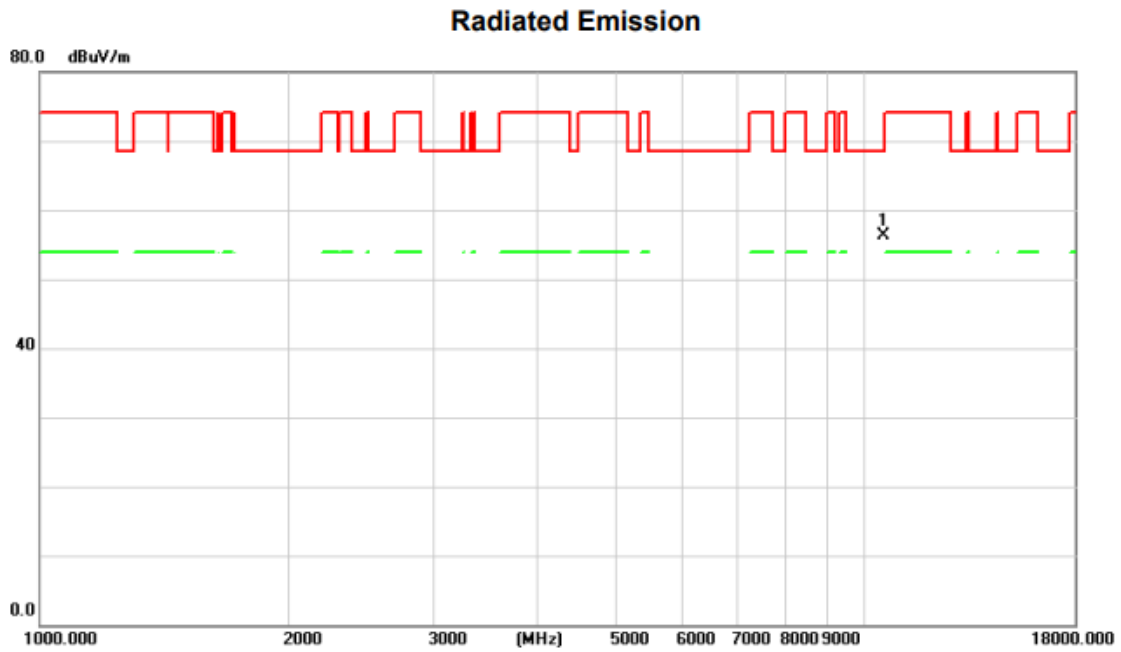

No.	Mk.	Freq.	Reading Level	Correct Factor	Measurement	Limit	Over	Antenna Height	Table Degree	
		MHz	dBuV	dB/m	dBuV/m	dBuV/m	dB	cm	degree	Comment
1	*	10540.000	46.87	9.34	56.21	68.20	-11.99	peak		

REMARKS:

- (1) Measurement Value = Reading Level + Correct Factor.
- (2) Margin Level = Measurement Value - Limit Value.

Test Mode	UNII-2A_TX N(HT40) Mode 5310 MHz	Polarization	Vertical
-----------	----------------------------------	--------------	----------

Radiated Emission

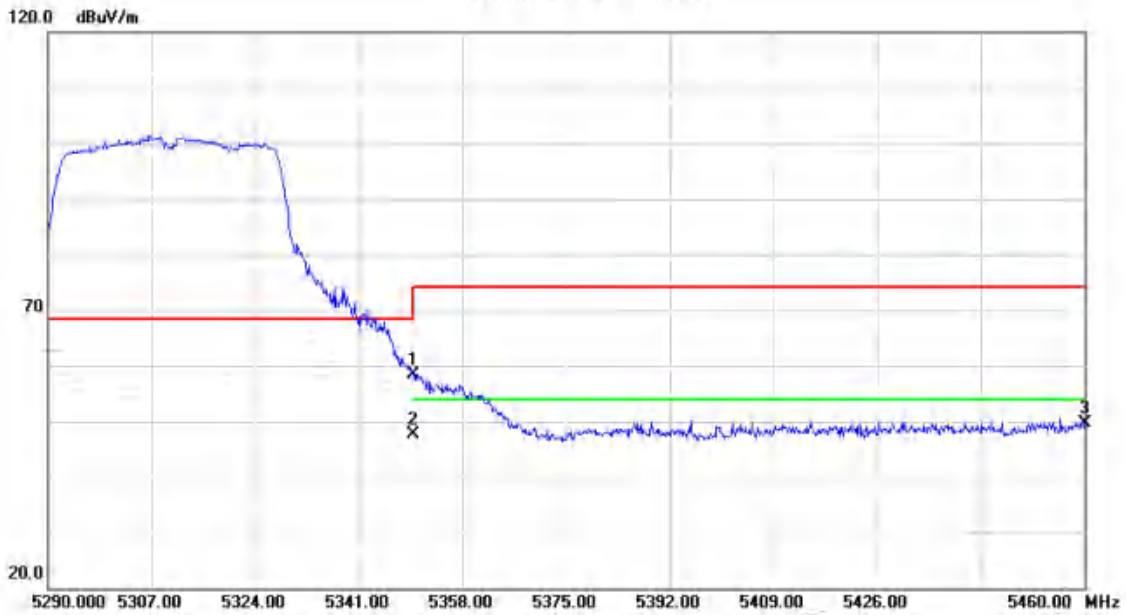

No.	Mk.	Freq.	Reading Level	Correct Factor	Measurement	Limit	Over	Antenna Height	Table Degree	
		MHz	dBuV	dB/m	dBuV/m	dBuV/m	dB	cm	degree	Comment
1		5350.000	61.15	-2.78	58.37	68.20	-9.83			peak
2	*	5350.000	50.46	-2.78	47.68	54.00	-6.32			AVG
3		5460.000	52.25	-2.67	49.58	68.20	-18.62			peak

REMARKS:

- (1) Measurement Value = Reading Level + Correct Factor.
- (2) Margin Level = Measurement Value - Limit Value.

Test Mode	UNII-2A_TX N(HT40) Mode 5310 MHz	Polarization	Vertical
-----------	----------------------------------	--------------	----------

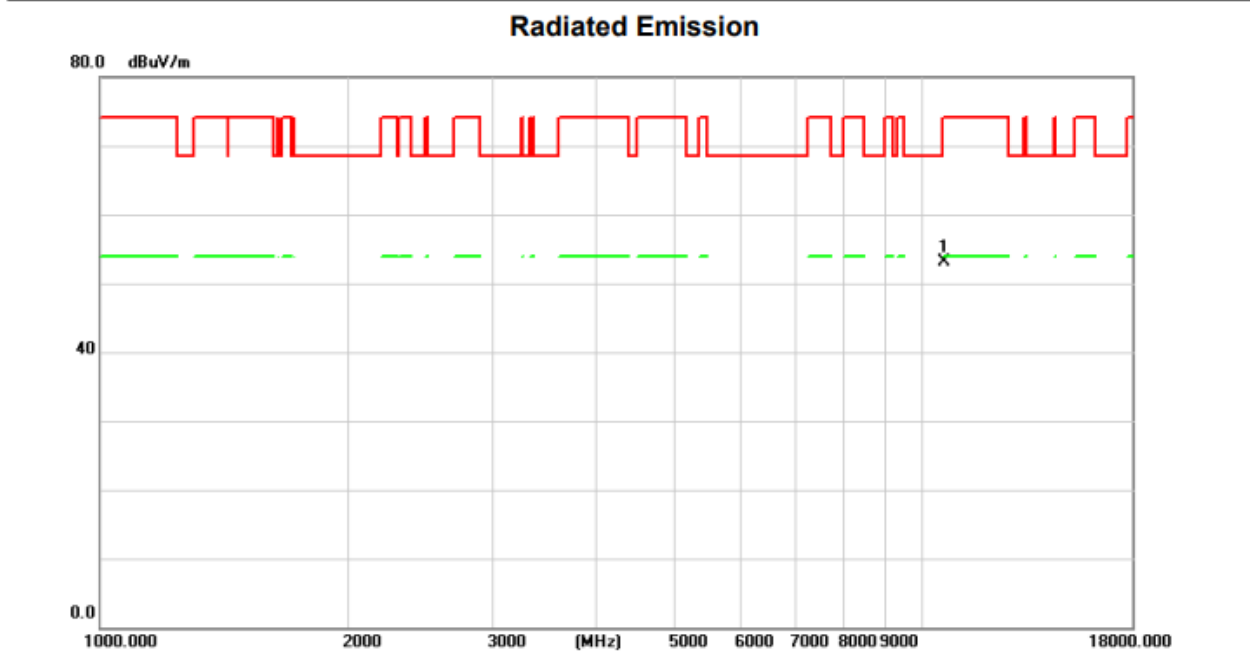

No.	Mk.	Freq.	Reading Level	Correct Factor	Measurement	Limit	Over	Antenna Height	Table Degree
		MHz	dBuV	dB/m	dBuV/m	dBuV/m	dB	cm	degree
1	*	10620.000	43.70	9.48	53.18	74.00	-20.82	peak	

REMARKS:

- (1) Measurement Value = Reading Level + Correct Factor.
- (2) Margin Level = Measurement Value - Limit Value.

Test Mode	UNII-2A_TX N(HT40) Mode 5310 MHz	Polarization	Horizontal
-----------	----------------------------------	--------------	------------

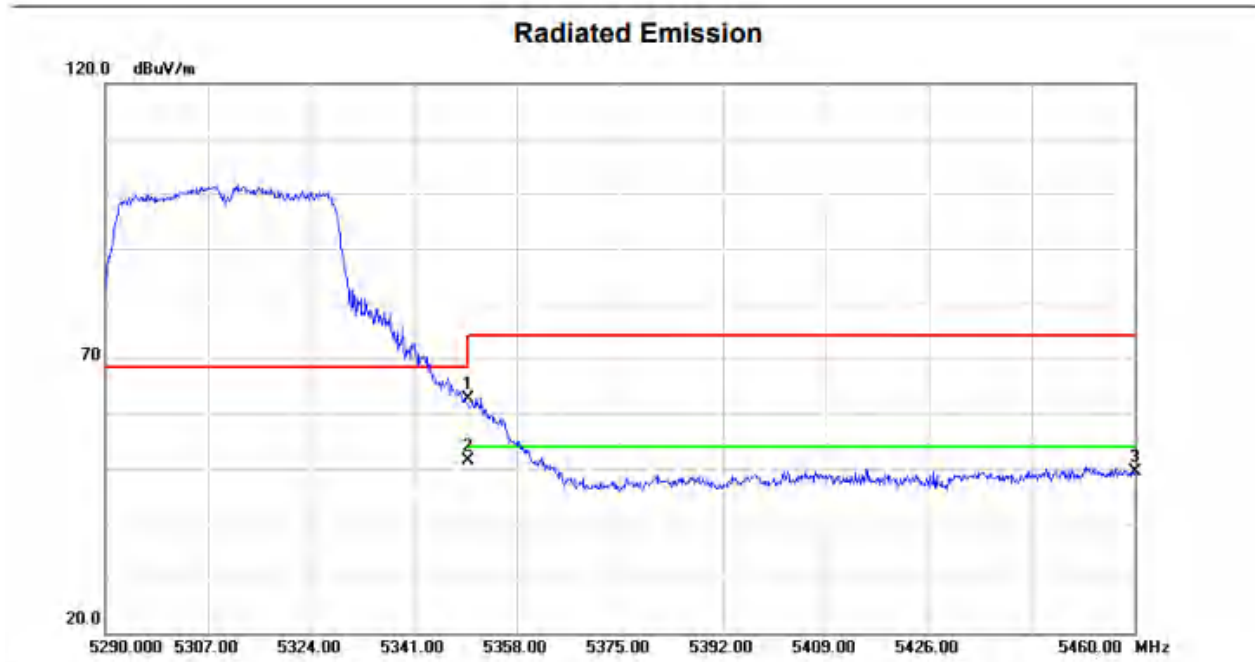

No.	Mk.	Freq.	Reading Level	Correct Factor	Measurement	Limit	Over	Antenna Height	Table Degree	Comment
		MHz	dBuV	dB/m	dBuV/m	dBuV/m	dB	cm	degree	
1		5350.000	65.32	-2.78	62.54	68.20	-5.66			peak
2	*	5350.000	54.21	-2.78	51.43	54.00	-2.57			AVG
3		5460.000	52.08	-2.67	49.41	68.20	-18.79			peak

REMARKS:

- (1) Measurement Value = Reading Level + Correct Factor.
- (2) Margin Level = Measurement Value - Limit Value.

Test Mode	UNII-2A_TX N(HT40) Mode 5310 MHz	Polarization	Horizontal
-----------	----------------------------------	--------------	------------

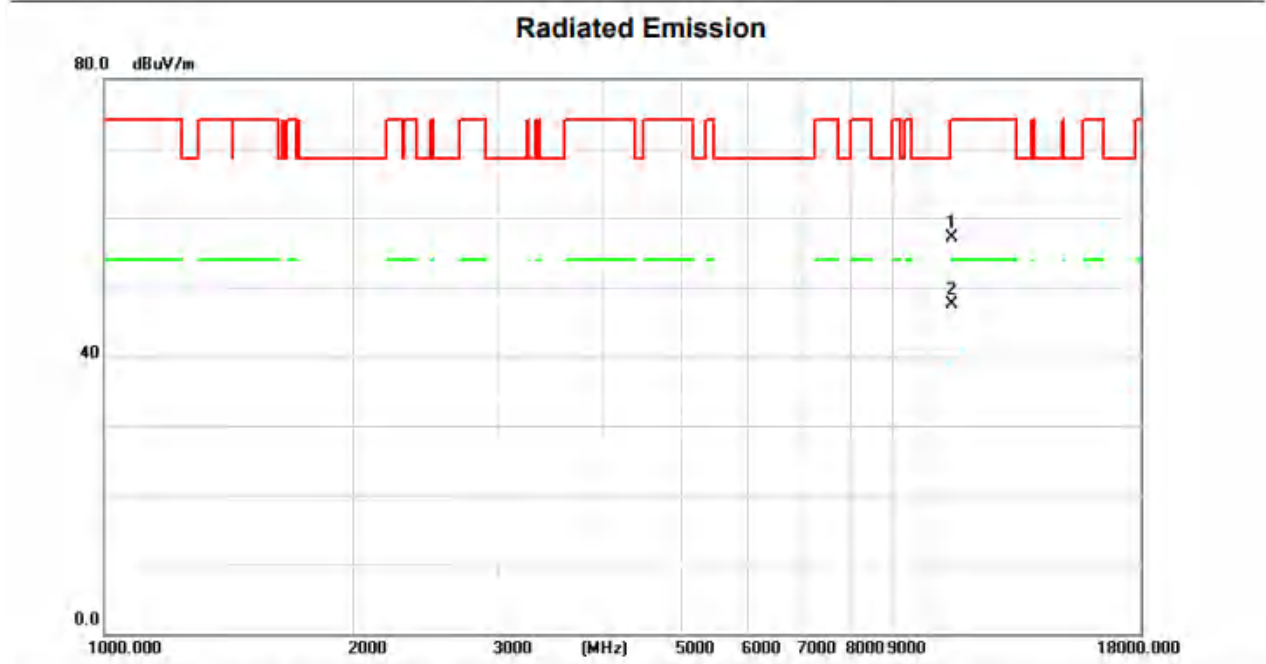

No.	Mk.	Freq.	Reading Level	Correct Factor	Measurement	Limit	Over	Antenna Height	Table Degree	
		MHz	dBuV	dB/m	dBuV/m	dBuV/m	dB	cm	degree	Comment
1		10620.000	47.66	9.48	57.14	74.00	-16.86	peak		
2	*	10620.000	38.11	9.48	47.59	54.00	-6.41	AVG		

REMARKS:

- (1) Measurement Value = Reading Level + Correct Factor.
- (2) Margin Level = Measurement Value - Limit Value.

Test Mode	UNII-2A_TX AC(VHT20) Mode 5260 MHz	Polarization	Vertical
-----------	------------------------------------	--------------	----------

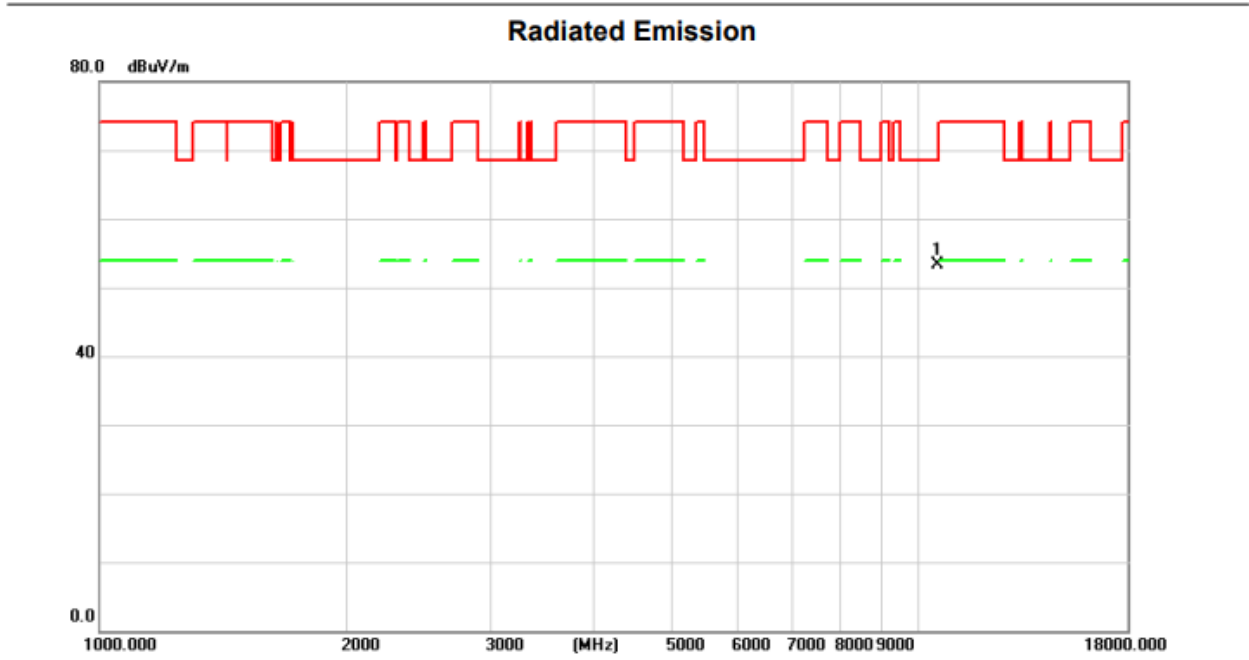

No.	Mk.	Freq.	Reading Level	Correct Factor	Measurement	Limit	Over	Antenna Height	Table Degree
		MHz	dBuV	dB/m	dBuV/m	dBuV/m	dB	cm	degree
1	*	10520.000	43.93	9.30	53.23	68.20	-14.97	peak	

REMARKS:

- (1) Measurement Value = Reading Level + Correct Factor.
- (2) Margin Level = Measurement Value - Limit Value.

Test Mode	UNII-2A_TX AC(VHT20) Mode 5260 MHz	Polarization	Horizontal
-----------	------------------------------------	--------------	------------

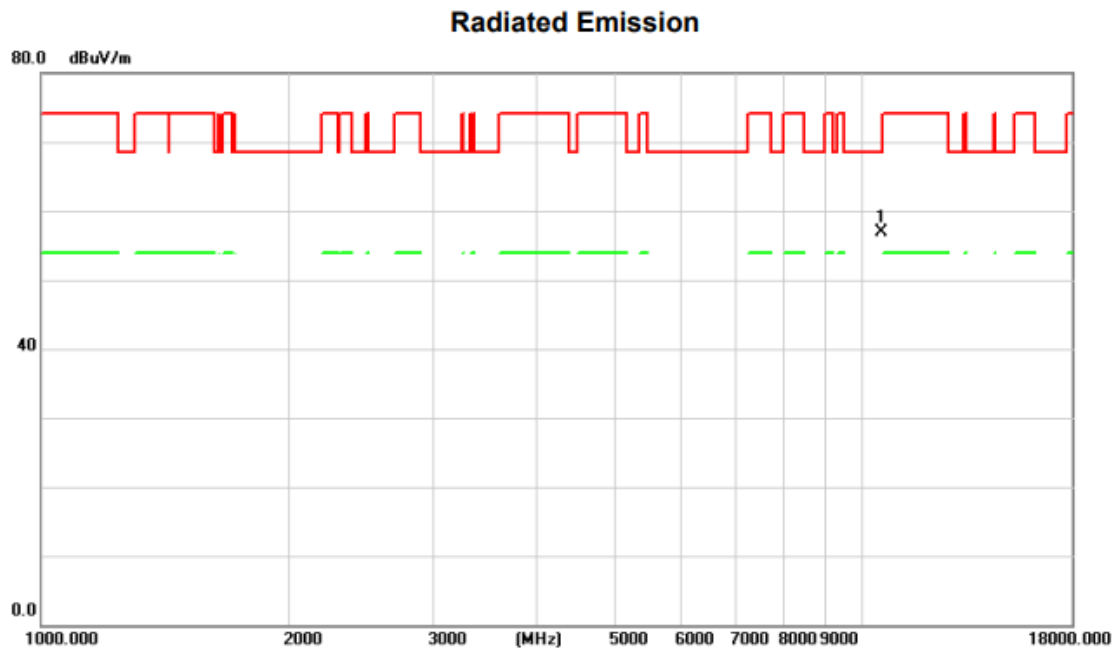

No.	Mk.	Freq.	Reading Level	Correct Factor	Measurement	Limit	Over	Antenna Height	Table Degree
		MHz	dBuV	dB/m	dBuV/m	dBuV/m	dB	cm	degree
1	*	10520.000	47.69	9.30	56.99	68.20	-11.21	peak	

REMARKS:

- (1) Measurement Value = Reading Level + Correct Factor.
- (2) Margin Level = Measurement Value - Limit Value.

Test Mode	UNII-2A_TX AC(VHT20) Mode 5280 MHz	Polarization	Vertical
-----------	------------------------------------	--------------	----------

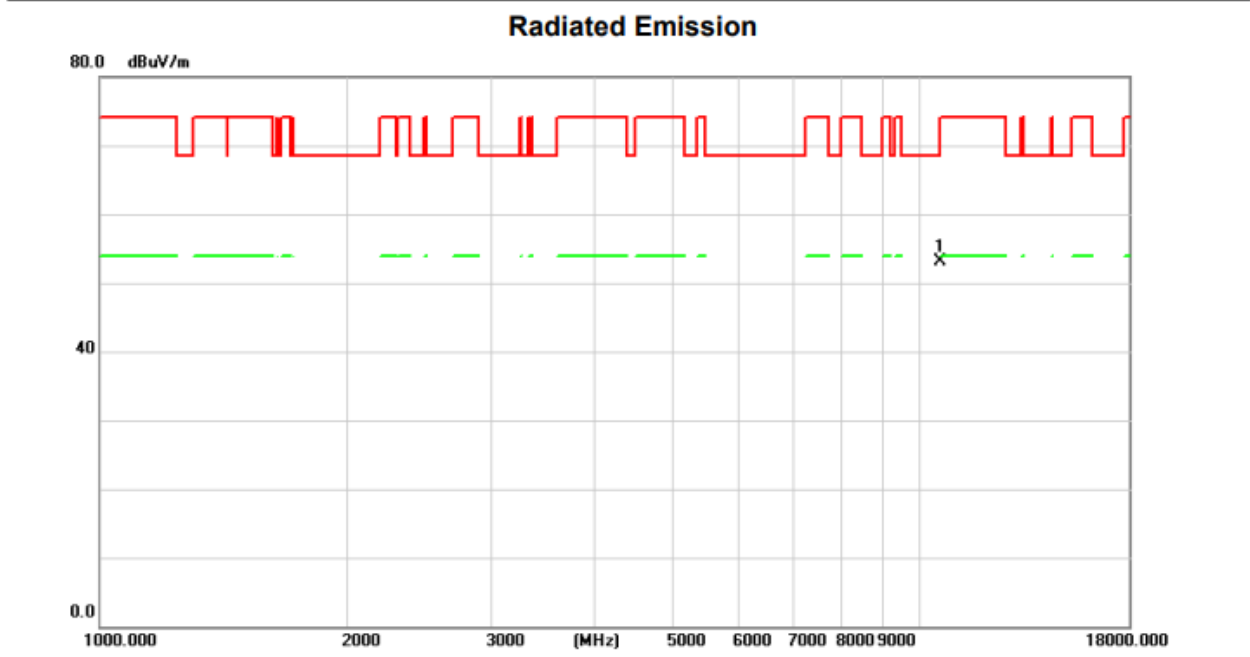

No.	Mk.	Freq.	Reading Level	Correct Factor	Measurement	Limit	Over	Antenna Height	Table Degree
		MHz	dBuV	dB/m	dBuV/m	dBuV/m	dB	cm	degree
1	*	10560.000	43.65	9.37	53.02	68.20	-15.18	peak	

REMARKS:

- (1) Measurement Value = Reading Level + Correct Factor.
- (2) Margin Level = Measurement Value - Limit Value.

Test Mode	UNII-2A_TX AC(VHT20) Mode 5280 MHz	Polarization	Horizontal
-----------	------------------------------------	--------------	------------

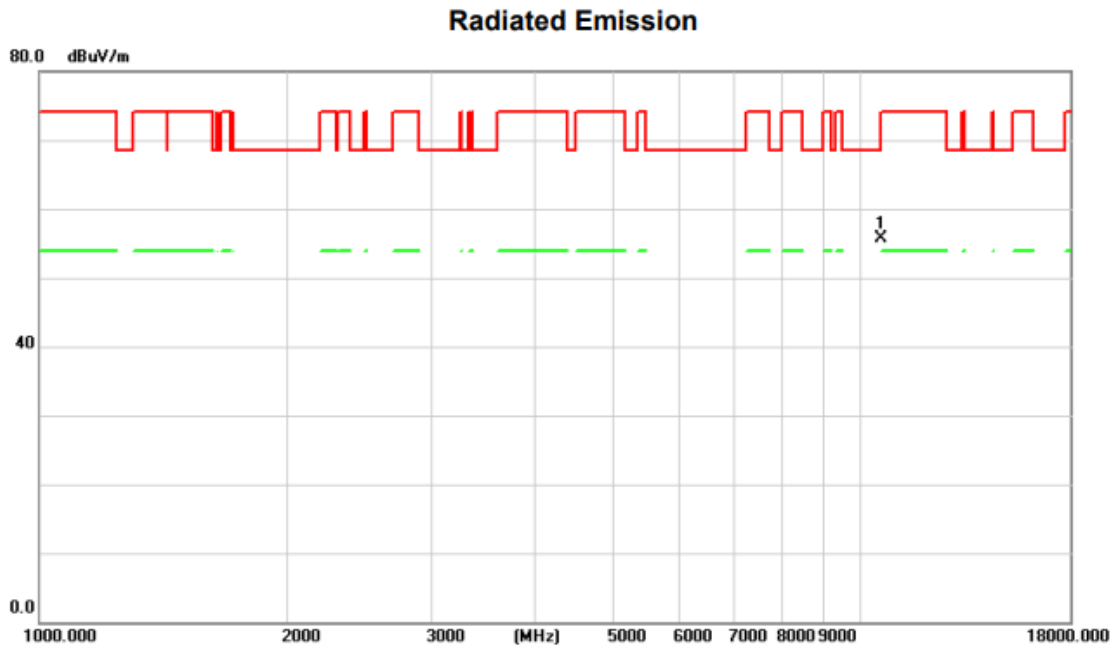

No.	Mk.	Freq.	Reading Level	Correct Factor	Measurement	Limit	Over	Antenna Height	Table Degree	
		MHz	dBuV	dB/m	dBuV/m	dBuV/m	dB	cm	degree	Comment
1	*	10560.000	46.29	9.37	55.66	68.20	-12.54			peak

REMARKS:

- (1) Measurement Value = Reading Level + Correct Factor.
- (2) Margin Level = Measurement Value - Limit Value.

Test Mode	UNII-2A_TX AC(VHT20) Mode 5320 MHz	Polarization	Vertical
-----------	------------------------------------	--------------	----------

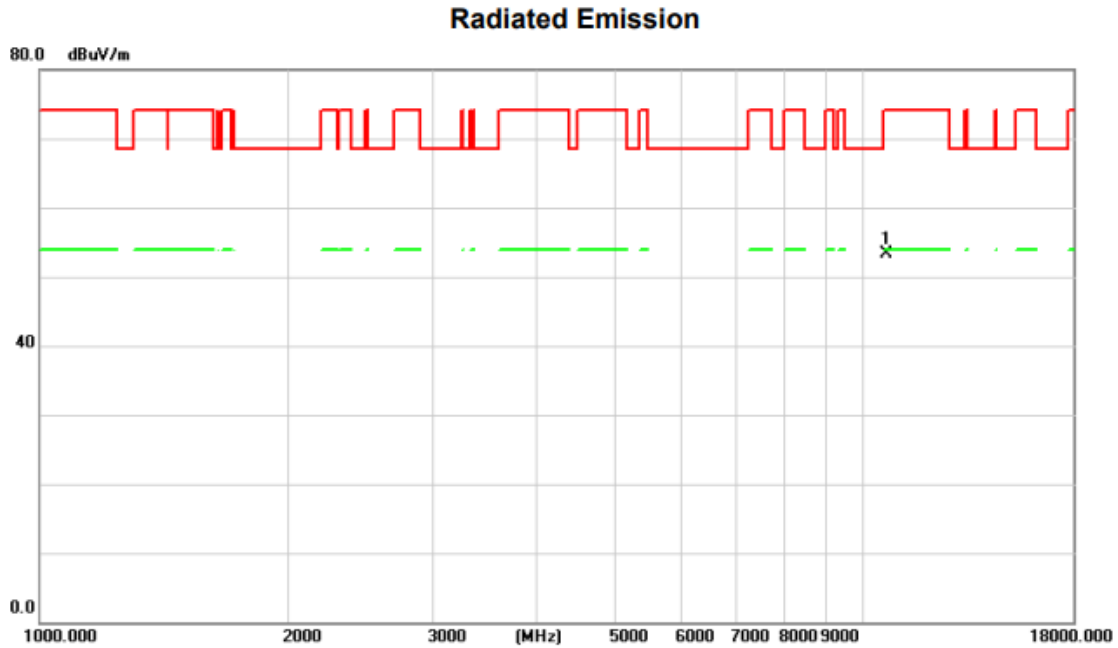

No.	Mk.	Freq.	Reading Level	Correct Factor	Measurement	Limit	Over	Antenna Height	Table Degree
		MHz	dBuV	dB/m	dBuV/m	dBuV/m	dB	cm	degree
1	*	10640.000	43.76	9.52	53.28	74.00	-20.72	peak	

REMARKS:

- (1) Measurement Value = Reading Level + Correct Factor.
- (2) Margin Level = Measurement Value - Limit Value.

Test Mode	UNII-2A_TX AC(VHT20) Mode 5320 MHz	Polarization	Horizontal
-----------	------------------------------------	--------------	------------

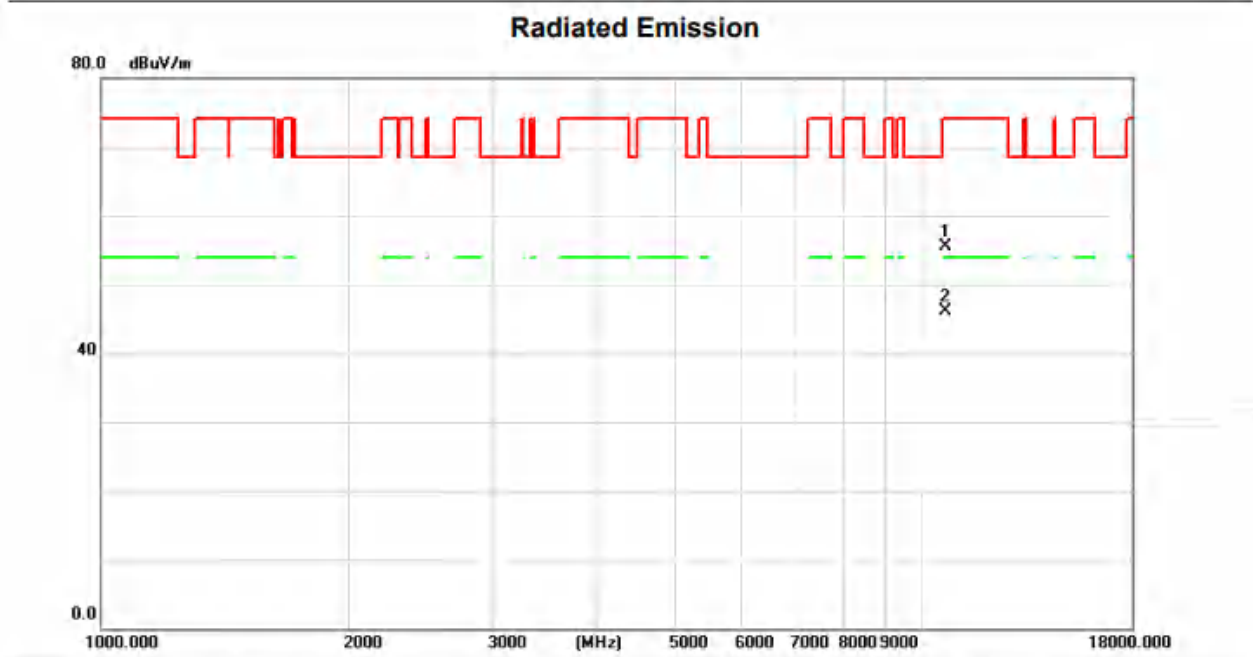

No.	Mk.	Freq.	Reading Level	Correct Factor	Measurement	Limit	Over	Antenna Height	Table Degree	Comment
		MHz	dBuV	dB/m	dBuV/m	dBuV/m	dB	cm	degree	
1		10640.000	46.06	9.52	55.58	74.00	-18.42	peak		
2	*	10640.000	36.55	9.52	46.07	54.00	-7.93	AVG		

REMARKS:

- (1) Measurement Value = Reading Level + Correct Factor.
- (2) Margin Level = Measurement Value - Limit Value.

Test Mode	UNII-2A_TX AC(VHT40) Mode 5270 MHz	Polarization	Vertical
-----------	------------------------------------	--------------	----------

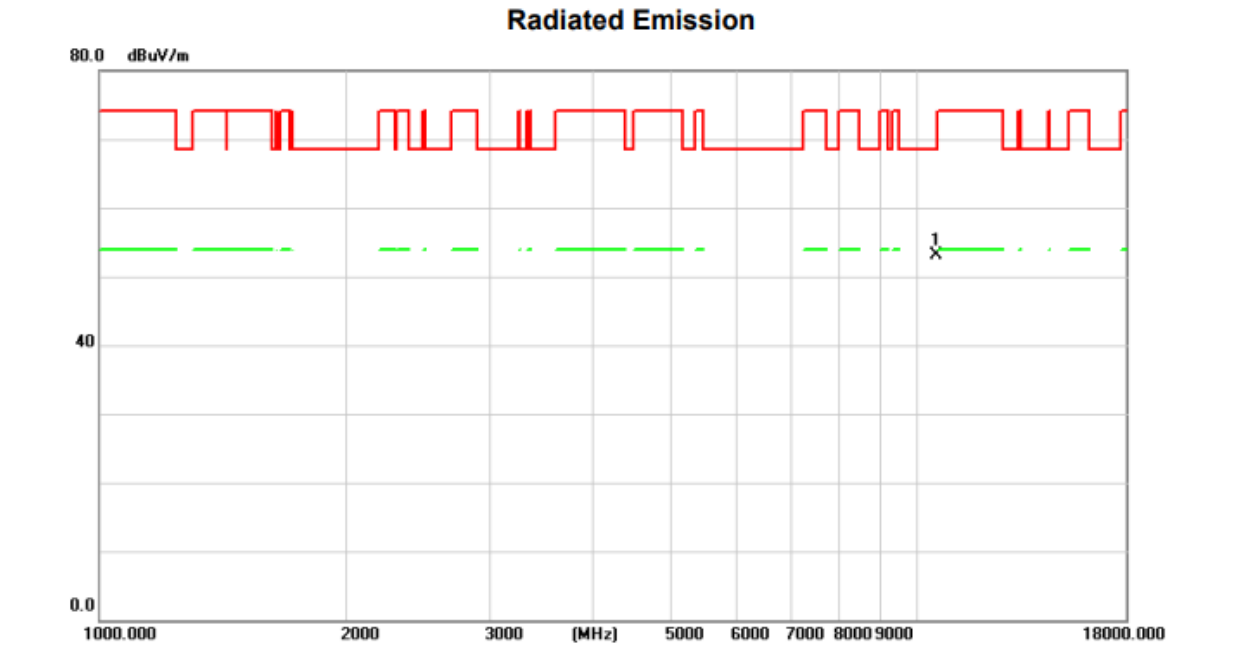

No.	Mk.	Freq.	Reading Level	Correct Factor	Measurement	Limit	Over	Antenna Height	Table Degree	
		MHz	dBuV	dB/m	dBuV/m	dBuV/m	dB	cm	degree	Comment
1	*	10540.000	43.82	9.34	53.16	68.20	-15.04	peak		

REMARKS:

- (1) Measurement Value = Reading Level + Correct Factor.
- (2) Margin Level = Measurement Value - Limit Value.

Test Mode	UNII-2A_TX AC(VHT40) Mode 5270 MHz	Polarization	Horizontal
-----------	------------------------------------	--------------	------------

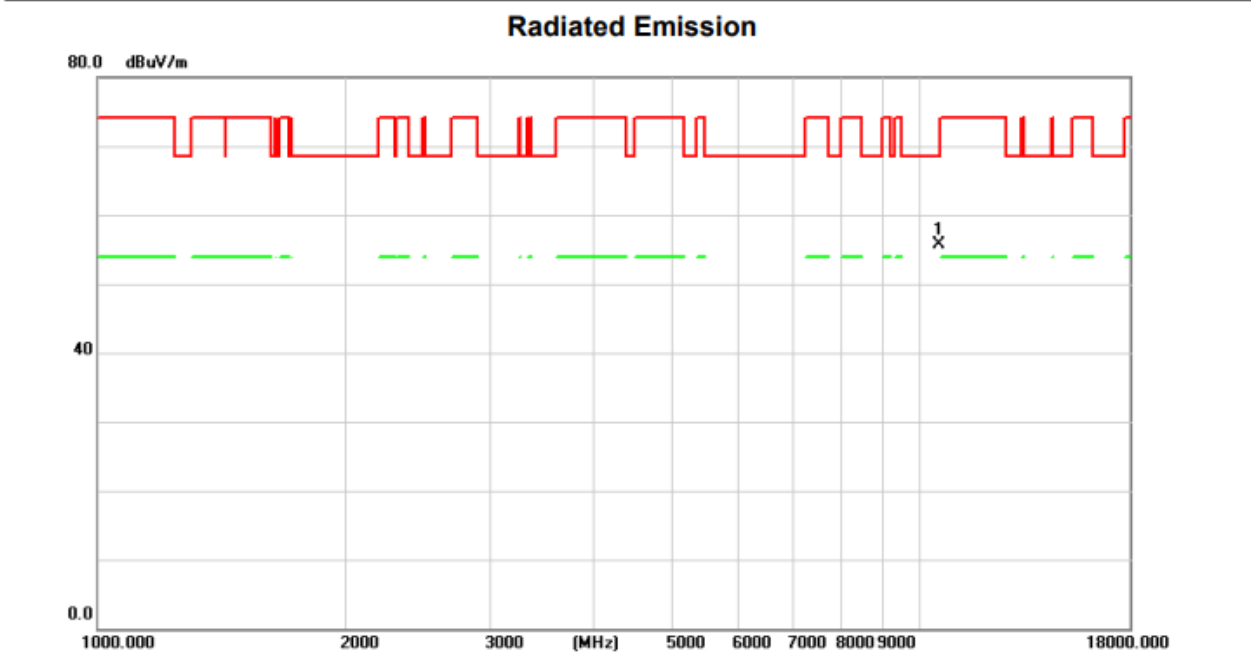

No.	Mk.	Freq.	Reading Level	Correct Factor	Measurement	Limit	Over	Antenna Height	Table Degree	
		MHz	dBuV	dB/m	dBuV/m	dBuV/m	dB	cm	degree	Comment
1	*	10540.000	46.43	9.34	55.77	68.20	-12.43	peak		

REMARKS:

- (1) Measurement Value = Reading Level + Correct Factor.
- (2) Margin Level = Measurement Value - Limit Value.

Test Mode	UNII-2A_TX AC(VHT40) Mode 5310 MHz	Polarization	Vertical
-----------	------------------------------------	--------------	----------

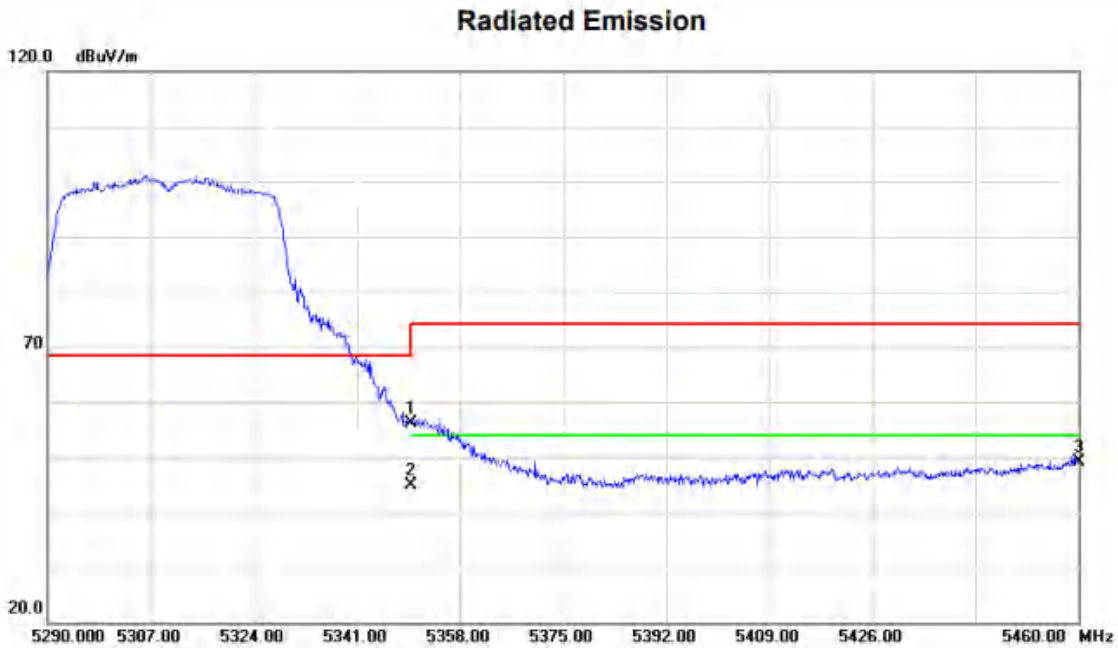

No.	Mk.	Freq.	Reading Level	Correct Factor	Measurement	Limit	Over	Antenna Height	Table Degree	
		MHz	dBuV	dB/m	dBuV/m	dBuV/m	dB	cm	degree	Comment
1		5350.000	58.85	-2.78	56.07	68.20	-12.13			peak
2	*	5350.000	47.70	-2.78	44.92	54.00	-9.08			AVG
3		5460.000	51.86	-2.67	49.19	68.20	-19.01			peak

REMARKS:

- (1) Measurement Value = Reading Level + Correct Factor.
- (2) Margin Level = Measurement Value - Limit Value.

Test Mode	UNII-2A_TX AC(VHT40) Mode 5310 MHz	Polarization	Vertical
-----------	------------------------------------	--------------	----------

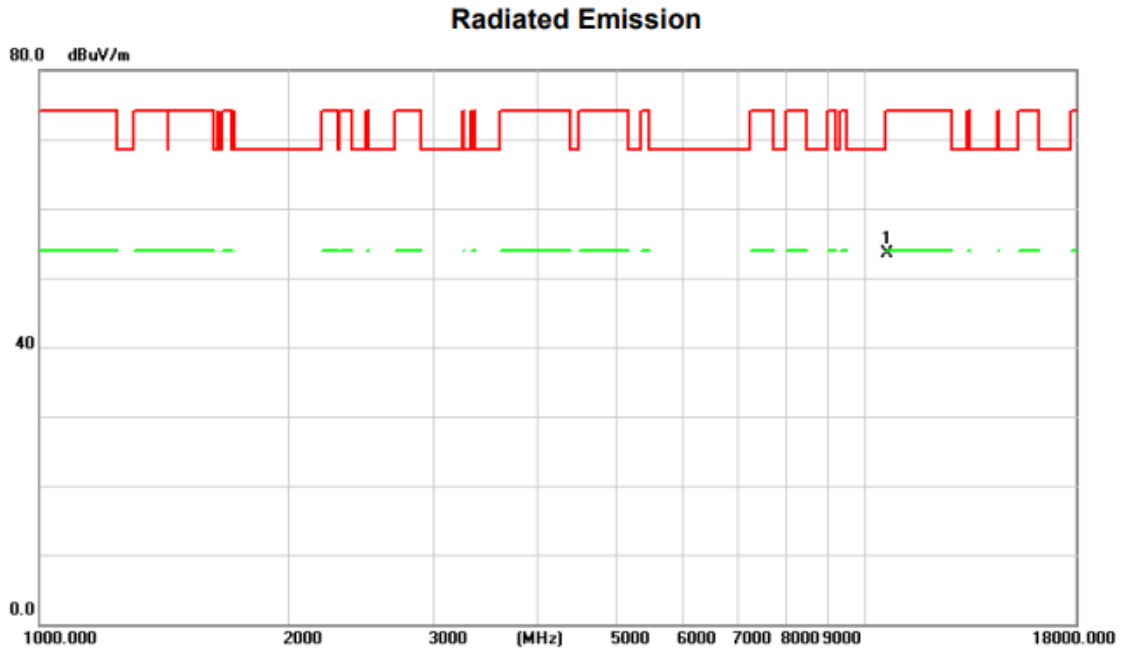

No.	Mk.	Freq.	Reading Level	Correct Factor	Measurement	Limit	Over	Antenna Height	Table Degree	
		MHz	dBuV	dB/m	dBuV/m	dBuV/m	dB	cm	degree	Comment
1	*	10620.000	44.01	9.48	53.49	74.00	-20.51	peak		

REMARKS:

- (1) Measurement Value = Reading Level + Correct Factor.
- (2) Margin Level = Measurement Value - Limit Value.

Test Mode	UNII-2A_TX AC(VHT40) Mode 5310 MHz	Polarization	Horizontal
-----------	------------------------------------	--------------	------------

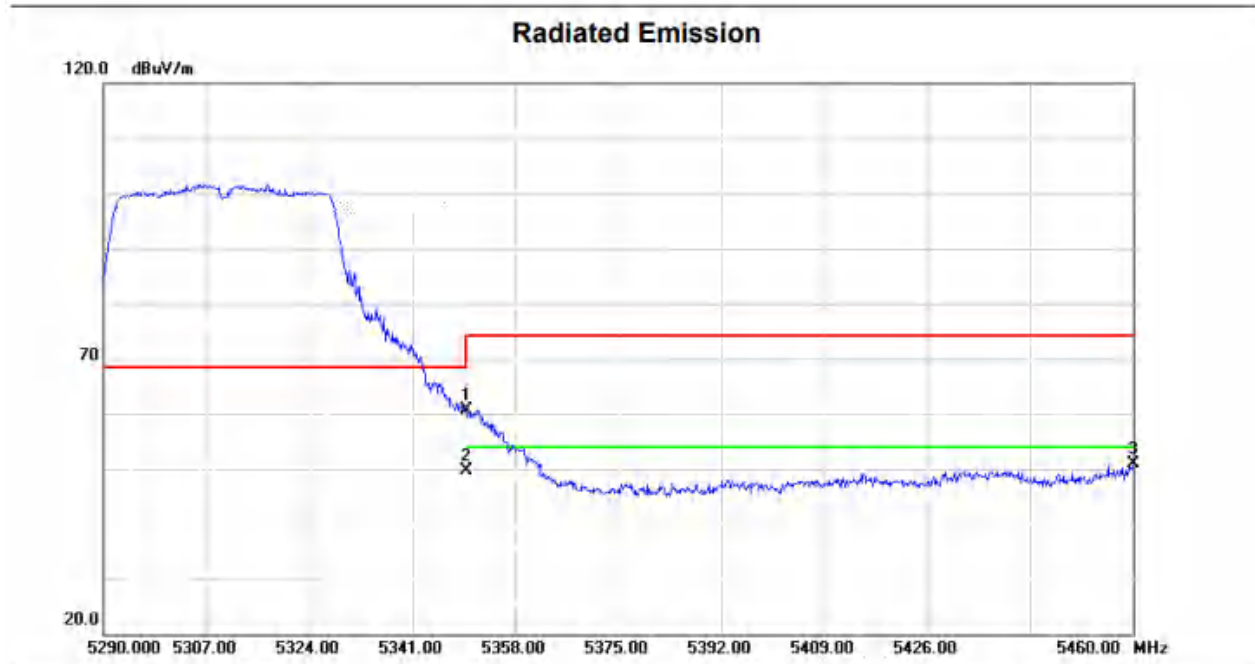

No.	Mk.	Freq.	Reading Level	Correct Factor	Measurement	Limit	Over	Antenna Height	Table Degree	Comment
		MHz	dBuV	dB/m	dBuV/m	dBuV/m	dB	cm	degree	
1		5350.000	63.53	-2.78	60.75	68.20	-7.45			peak
2	*	5350.000	52.50	-2.78	49.72	54.00	-4.28			AVG
3		5460.000	53.53	-2.67	50.86	68.20	-17.34			peak

REMARKS:

- (1) Measurement Value = Reading Level + Correct Factor.
- (2) Margin Level = Measurement Value - Limit Value.

Test Mode	UNII-2A_TX AC(VHT40) Mode 5310 MHz	Polarization	Horizontal
-----------	------------------------------------	--------------	------------

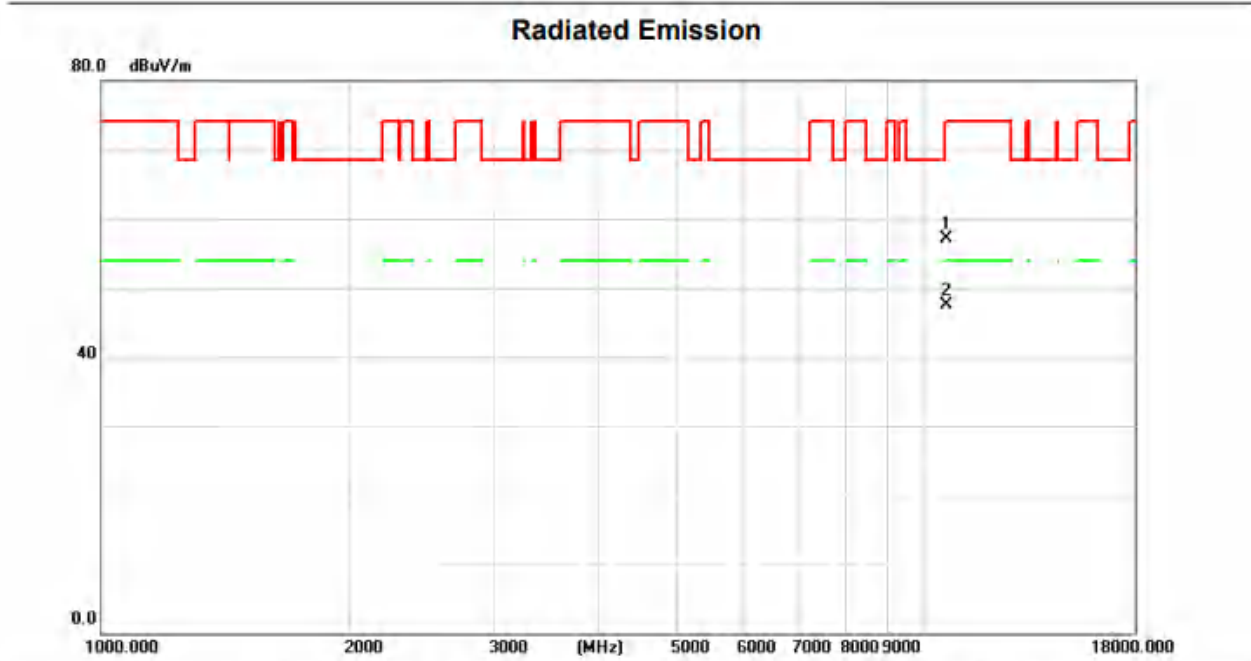

No.	Mk.	Freq.	Reading Level	Correct Factor	Measurement	Limit	Over	Antenna Height	Table Degree	
		MHz	dBuV	dB/m	dBuV/m	dBuV/m	dB	cm	degree	Comment
1		10620.000	47.57	9.48	57.05	74.00	-16.95	peak		
2	*	10620.000	38.09	9.48	47.57	54.00	-6.43	AVG		

REMARKS:

- (1) Measurement Value = Reading Level + Correct Factor.
- (2) Margin Level = Measurement Value - Limit Value.

Test Mode	UNII-2A_TX AC(VHT80) Mode 5290 MHz	Polarization	Vertical
-----------	------------------------------------	--------------	----------

Radiated Emission

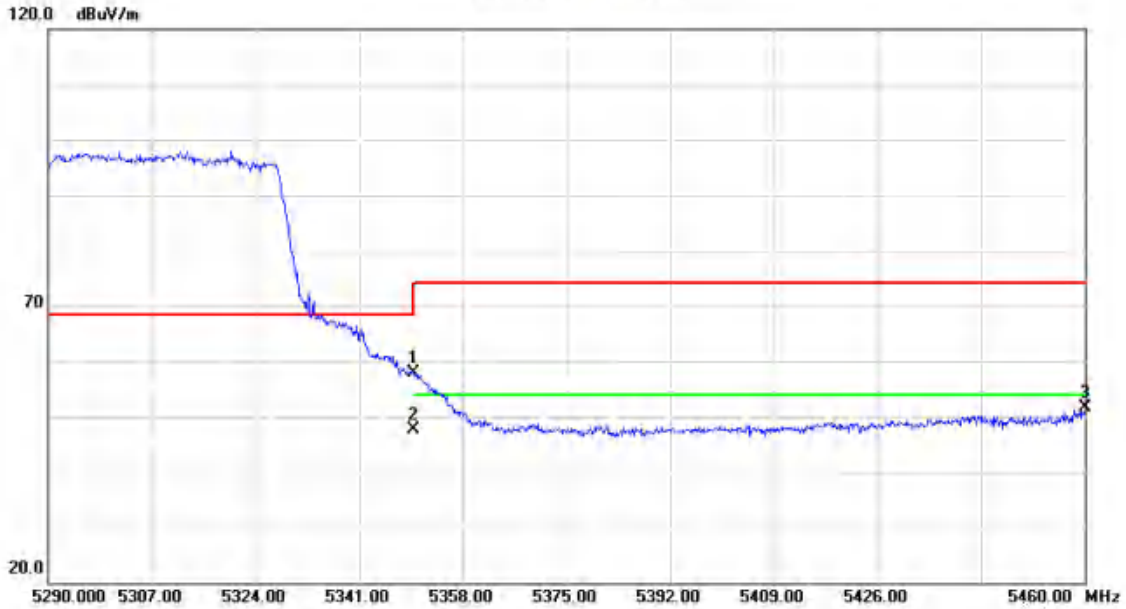

No.	Mk.	Freq.	Reading Level	Correct Factor	Measurement	Limit	Over	Antenna Height	Table Degree	
		MHz	dBuV	dB/m	dBuV/m	dBuV/m	dB	cm	degree	Comment
1		5350.000	60.67	-2.78	57.89	68.20	-10.31			peak
2	*	5350.000	50.40	-2.78	47.62	54.00	-6.38			AVG
3		5460.000	54.32	-2.67	51.65	68.20	-16.55			peak

REMARKS:

- (1) Measurement Value = Reading Level + Correct Factor.
- (2) Margin Level = Measurement Value - Limit Value.

Test Mode	UNII-2A_TX AC(VHT80) Mode 5290 MHz	Polarization	Vertical
-----------	------------------------------------	--------------	----------

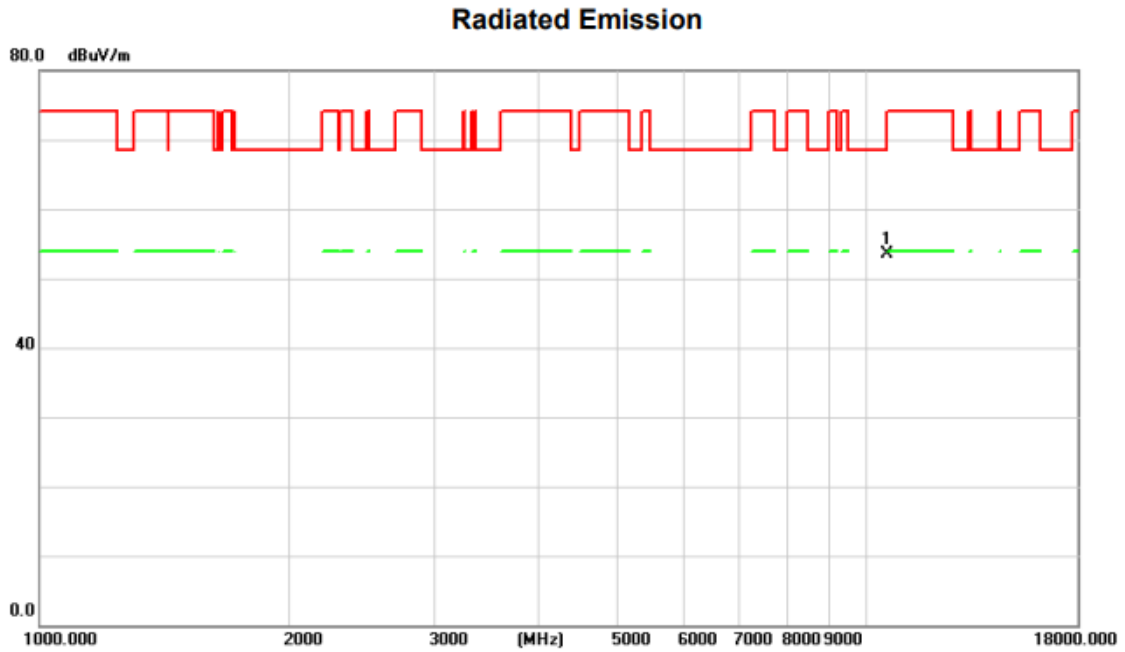

No.	Mk.	Freq.	Reading Level	Correct Factor	Measurement	Limit	Over	Antenna Height	Table Degree	
		MHz	dBuV	dB/m	dBuV/m	dBuV/m	dB	cm	degree	Comment
1	*	10580.000	44.17	9.41	53.58	68.20	-14.62	peak		

REMARKS:

- (1) Measurement Value = Reading Level + Correct Factor.
- (2) Margin Level = Measurement Value - Limit Value.

Test Mode	UNII-2A_TX AC(VHT80) Mode 5290 MHz	Polarization	Horizontal
-----------	------------------------------------	--------------	------------

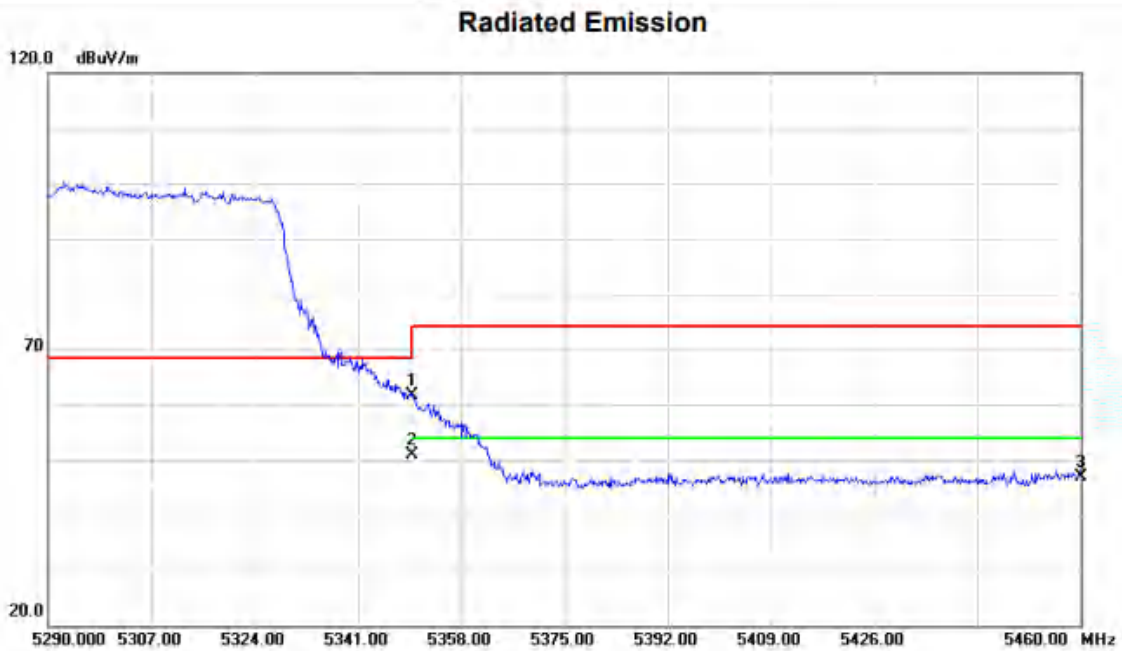

No.	Mk.	Freq.	Reading Level	Correct Factor	Measurement	Limit	Over	Antenna Height	Table Degree	
		MHz	dBuV	dB/m	dBuV/m	dBuV/m	dB	cm	degree	Comment
1		5350.000	64.46	-2.78	61.68	68.20	-6.52			peak
2	*	5350.000	53.60	-2.78	50.82	54.00	-3.18			AVG
3		5460.000	49.51	-2.67	46.84	68.20	-21.36			peak

REMARKS:

- (1) Measurement Value = Reading Level + Correct Factor.
- (2) Margin Level = Measurement Value - Limit Value.

Test Mode	UNII-2A_TX AC(VHT80) Mode 5290 MHz	Polarization	Horizontal
-----------	------------------------------------	--------------	------------

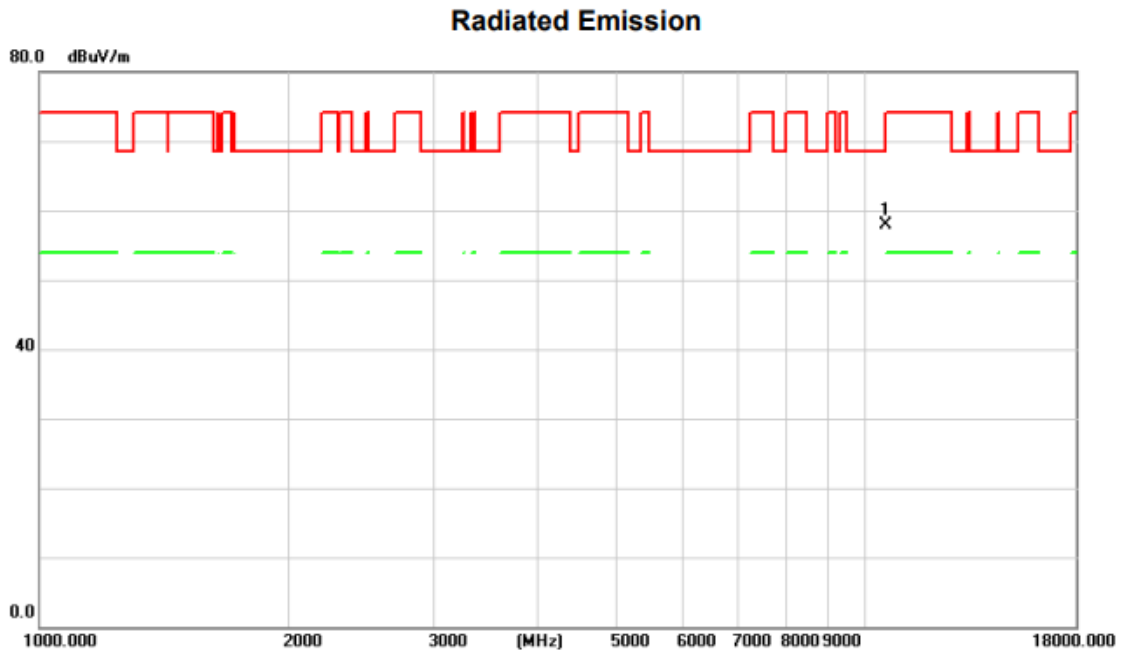

No.	Mk.	Freq.	Reading Level	Correct Factor	Measurement	Limit	Over	Antenna Height	Table Degree	
		MHz	dBuV	dB/m	dBuV/m	dBuV/m	dB	cm	degree	Comment
1	*	10580.000	48.41	9.41	57.82	68.20	-10.38	peak		

REMARKS:

- (1) Measurement Value = Reading Level + Correct Factor.
- (2) Margin Level = Measurement Value - Limit Value.

Test Mode	UNII-2C_TX A Mode 5500 MHz	Polarization	Vertical
-----------	----------------------------	--------------	----------

Radiated Emission

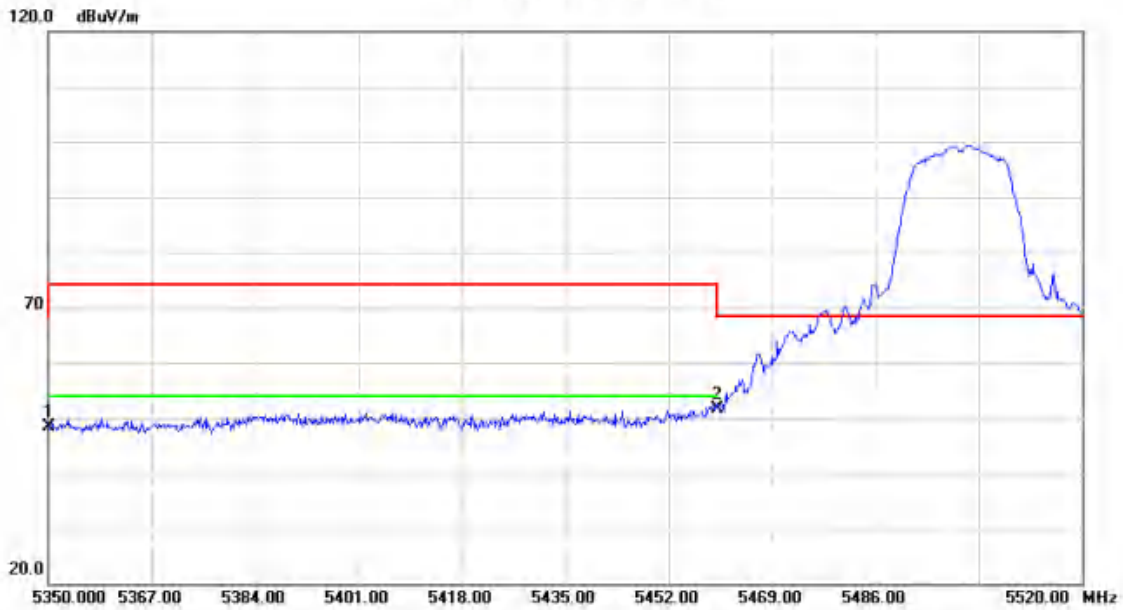

No.	Mk.	Freq.	Reading Level	Correct Factor	Measurement	Limit	Over	Antenna Height	Table Degree	
		MHz	dBuV	dB/m	dBuV/m	dBuV/m	dB	cm	degree	Comment
1		5350.000	51.22	-2.78	48.44	68.20	-19.76			peak
2	*	5460.000	54.40	-2.67	51.73	68.20	-16.47			peak

REMARKS:

- (1) Measurement Value = Reading Level + Correct Factor.
- (2) Margin Level = Measurement Value - Limit Value.

Test Mode	UNII-2C_TX A Mode 5500 MHz	Polarization	Vertical
-----------	----------------------------	--------------	----------

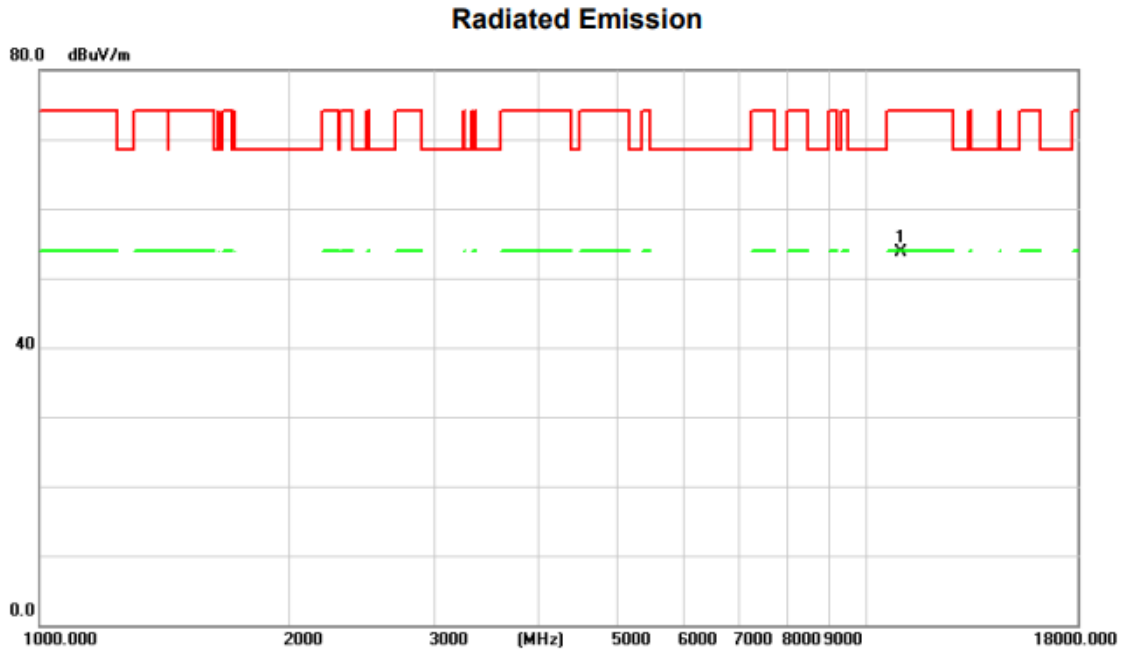

No.	Mk.	Freq.	Reading Level	Correct Factor	Measurement	Limit	Over	Antenna Height	Table Degree
		MHz	dBuV	dB/m	dBuV/m	dBuV/m	dB	cm	degree
1	*	11000.000	43.42	10.29	53.71	74.00	-20.29	peak	

REMARKS:

- (1) Measurement Value = Reading Level + Correct Factor.
- (2) Margin Level = Measurement Value - Limit Value.

Test Mode	UNII-2C_TX A Mode 5500 MHz	Polarization	Horizontal
-----------	----------------------------	--------------	------------

Radiated Emission

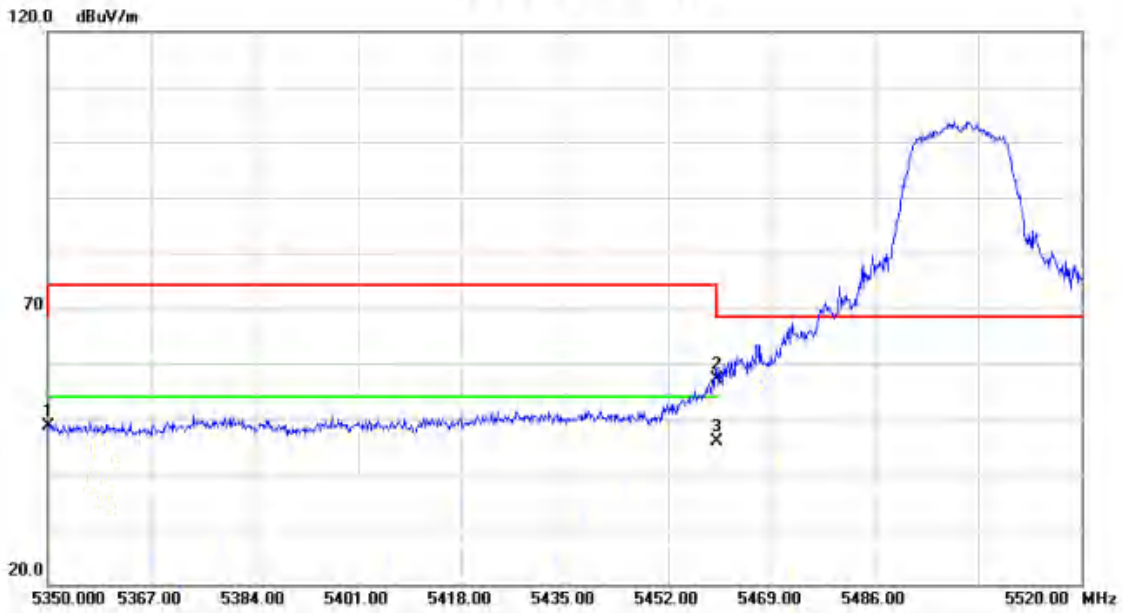

No.	Mk.	Freq.	Reading Level	Correct Factor	Measurement	Limit	Over	Antenna Height	Table Degree	
		MHz	dBuV	dB/m	dBuV/m	dBuV/m	dB	cm	degree	Comment
1		5350.000	51.38	-2.78	48.60	68.20	-19.60			peak
2		5460.000	59.72	-2.67	57.05	68.20	-11.15			peak
3	*	5460.000	48.56	-2.67	45.89	54.00	-8.11			AVG

REMARKS:

- (1) Measurement Value = Reading Level + Correct Factor.
- (2) Margin Level = Measurement Value - Limit Value.

Test Mode	UNII-2C_TX A Mode 5500 MHz	Polarization	Horizontal
-----------	----------------------------	--------------	------------

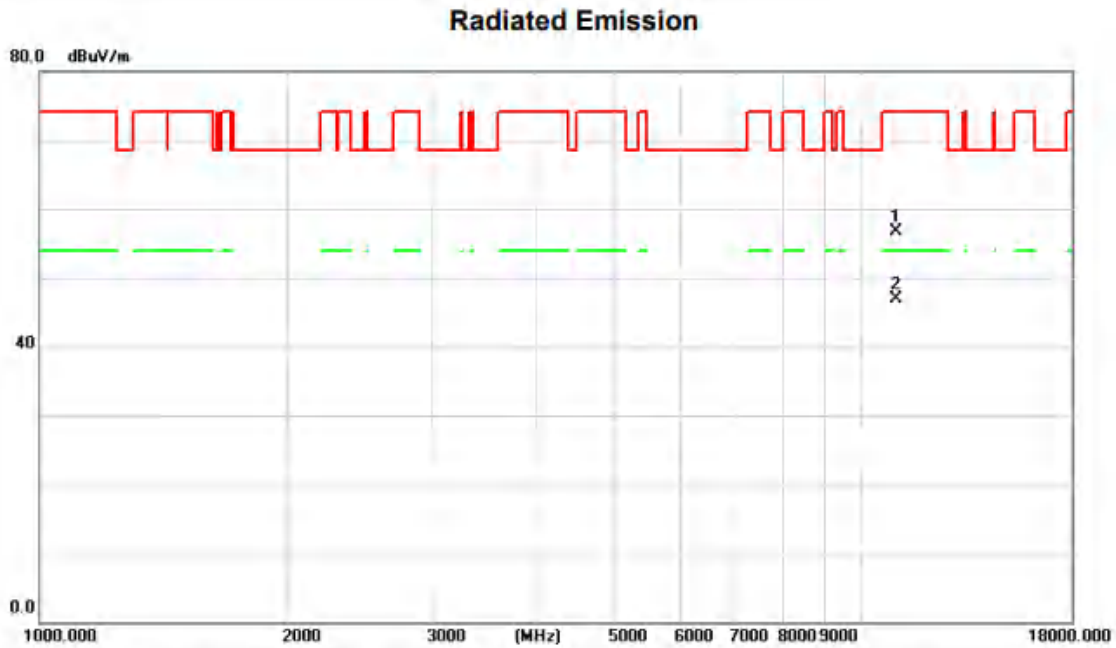

No.	Mk.	Freq.	Reading Level	Correct Factor	Measurement	Limit	Over	Antenna Height	Table Degree
		MHz	dBuV	dB/m	dBuV/m	dBuV/m	dB	cm	degree
1		11000.000	46.44	10.29	56.73	74.00	-17.27	peak	
2	*	11000.000	36.69	10.29	46.98	54.00	-7.02	AVG	

REMARKS:

- (1) Measurement Value = Reading Level + Correct Factor.
- (2) Margin Level = Measurement Value - Limit Value.

Test Mode	UNII-2C_TX A Mode 5580 MHz	Polarization	Vertical
-----------	----------------------------	--------------	----------

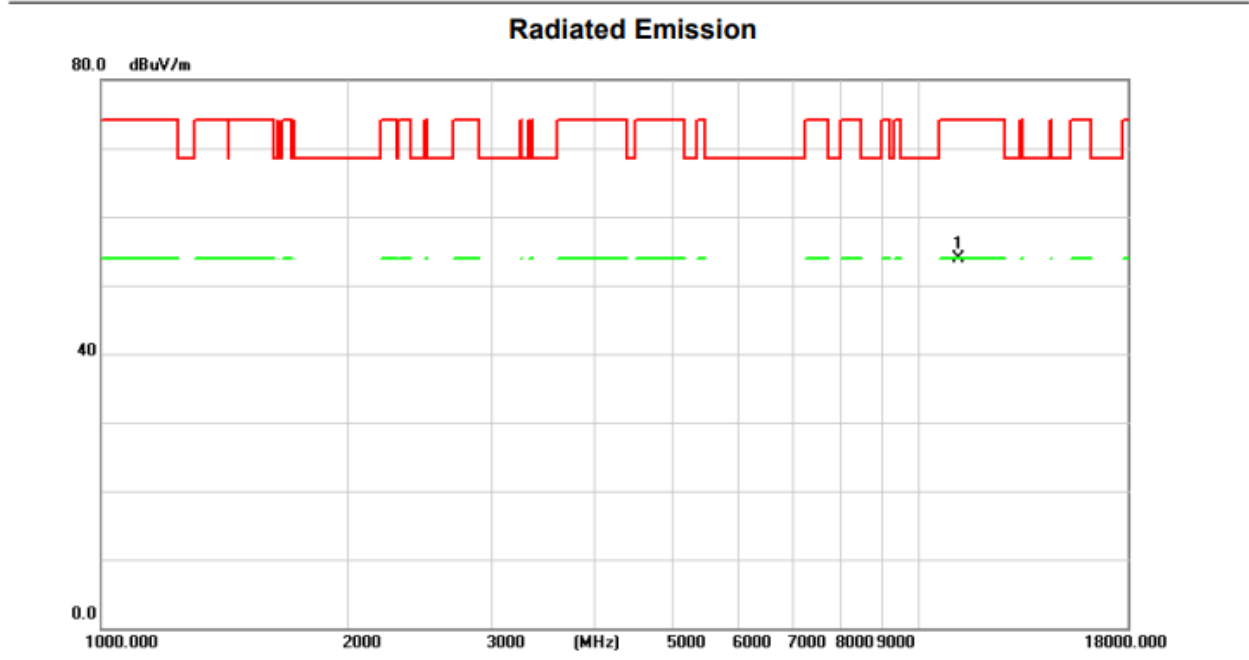

No.	Mk.	Freq.	Reading Level	Correct Factor	Measurement	Limit	Over	Antenna Height	Table Degree	
		MHz	dBuV	dB/m	dBuV/m	dBuV/m	dB	cm	degree	Comment
1	*	11160.000	43.83	9.98	53.81	74.00	-20.19			peak

REMARKS:

- (1) Measurement Value = Reading Level + Correct Factor.
- (2) Margin Level = Measurement Value - Limit Value.

Test Mode	UNII-2C_TX A Mode 5580 MHz	Polarization	Horizontal
-----------	----------------------------	--------------	------------

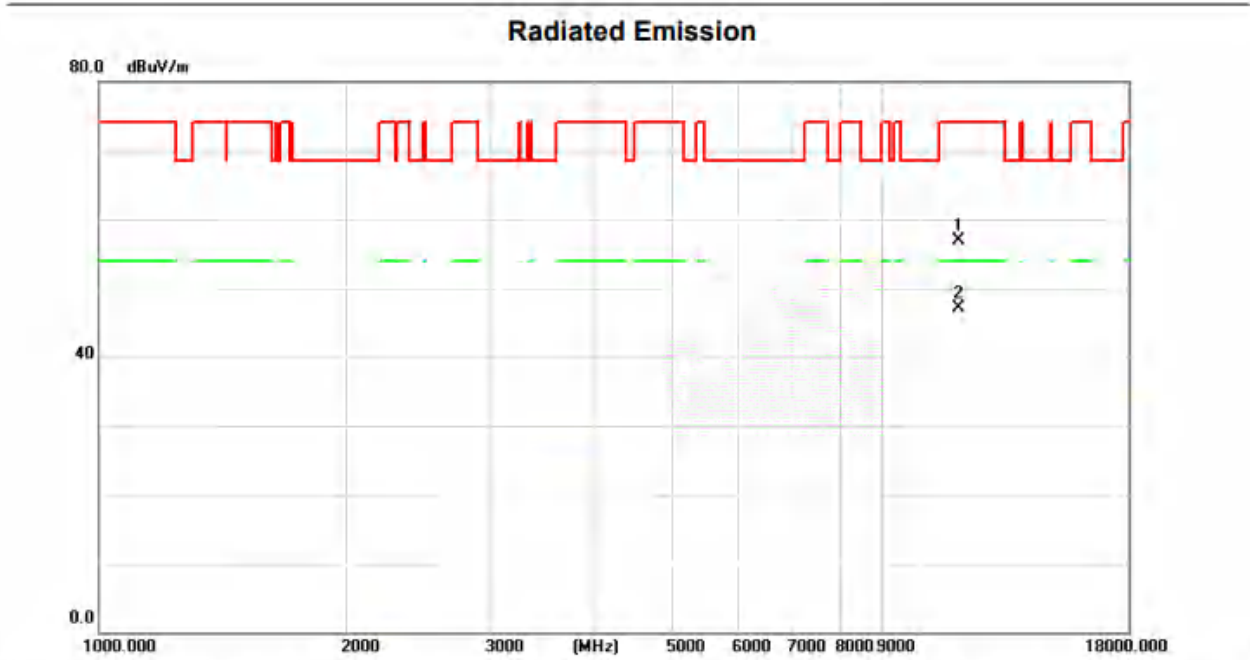

No.	Mk.	Freq.	Reading Level	Correct Factor	Measurement	Limit	Over	Antenna Height	Table Degree	Comment
		MHz	dBuV	dB/m	dBuV/m	dBuV/m	dB	cm	degree	
1		11160.000	46.84	9.98	56.82	74.00	-17.18	peak		
2	*	11160.000	37.08	9.98	47.06	54.00	-6.94	AVG		

REMARKS:

- (1) Measurement Value = Reading Level + Correct Factor.
- (2) Margin Level = Measurement Value - Limit Value.

Test Mode	UNII-2C_TX A Mode 5700 MHz	Polarization	Vertical
-----------	----------------------------	--------------	----------

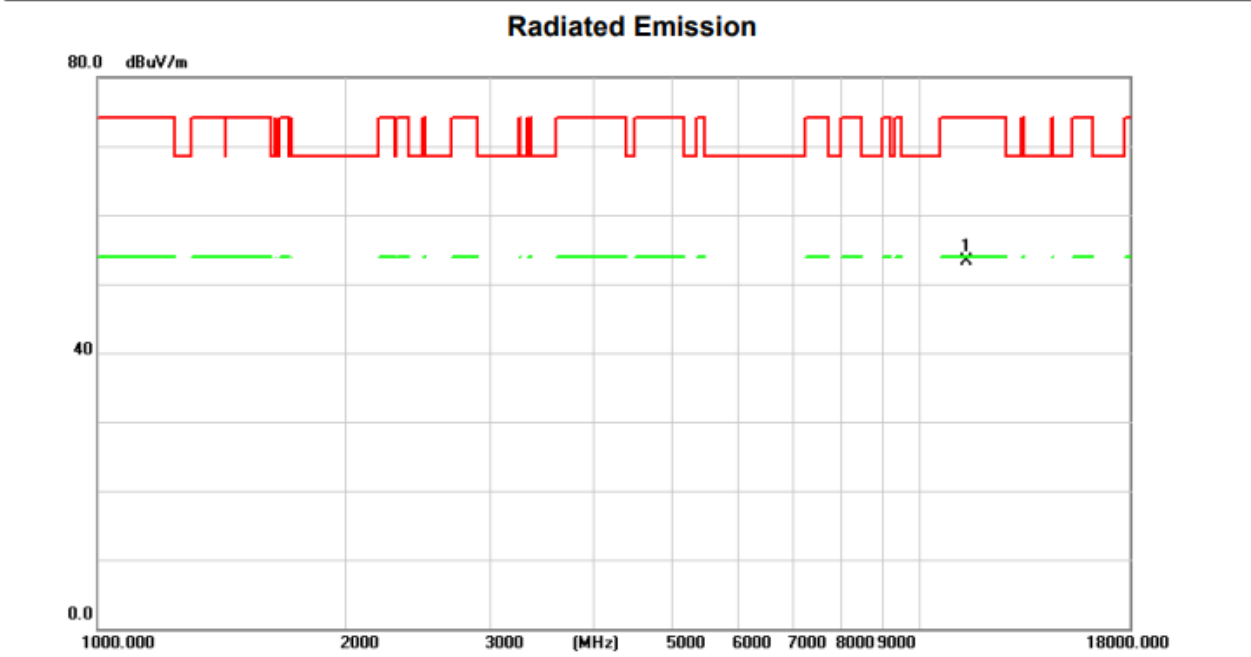

No.	Mk.	Freq.	Reading Level	Correct Factor	Measurement	Limit	Over	Antenna Height	Table Degree	
		MHz	dBuV	dB/m	dBuV/m	dBuV/m	dB	cm	degree	Comment
1	*	11400.000	43.86	9.51	53.37	74.00	-20.63	peak		

REMARKS:

- (1) Measurement Value = Reading Level + Correct Factor.
- (2) Margin Level = Measurement Value - Limit Value.

Test Mode	UNII-2C_TX A Mode 5700 MHz	Polarization	Horizontal
-----------	----------------------------	--------------	------------

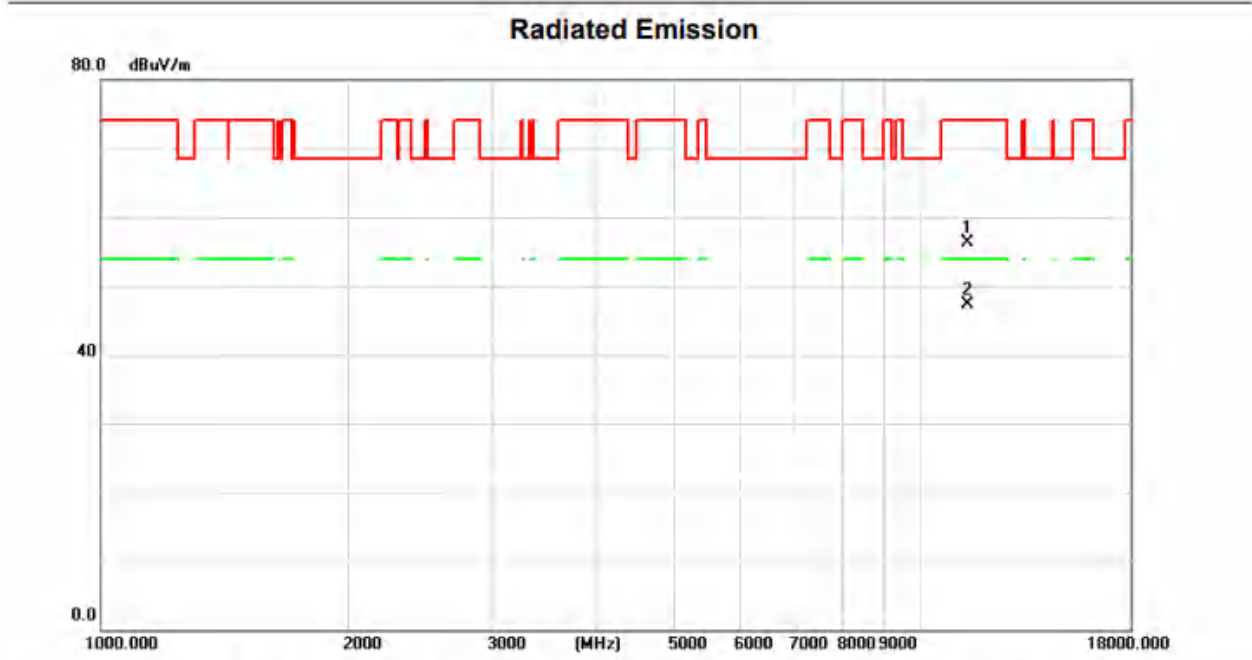

No.	Mk.	Freq.	Reading Level	Correct Factor	Measurement	Limit	Over	Antenna Height	Table Degree	
		MHz	dBuV	dB/m	dBuV/m	dBuV/m	dB	cm	degree	Comment
1		11400.000	46.86	9.51	56.37	74.00	-17.63			peak
2	*	11400.000	37.75	9.51	47.26	54.00	-6.74			AVG

REMARKS:

- (1) Measurement Value = Reading Level + Correct Factor.
- (2) Margin Level = Measurement Value - Limit Value.

Test Mode	UNII-2C_TX N(HT20) Mode 5500 MHz	Polarization	Vertical
-----------	----------------------------------	--------------	----------

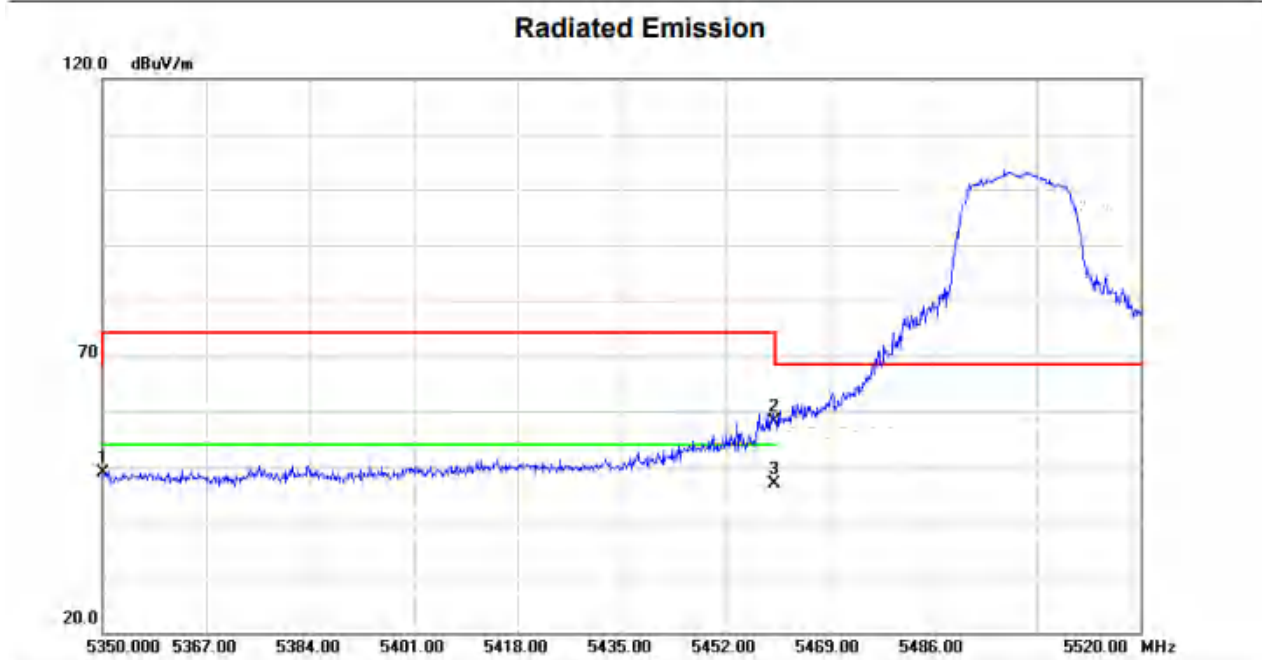

No.	Mk.	Freq.	Reading Level	Correct Factor	Measurement	Limit	Over	Antenna Height	Table Degree	
		MHz	dBuV	dB/m	dBuV/m	dBuV/m	dB	cm	degree	Comment
1		5350.000	51.54	-2.78	48.76	68.20	-19.44			peak
2		5460.000	60.84	-2.67	58.17	68.20	-10.03			peak
3	*	5460.000	49.54	-2.67	46.87	54.00	-7.13			AVG

REMARKS:

- (1) Measurement Value = Reading Level + Correct Factor.
- (2) Margin Level = Measurement Value - Limit Value.

Test Mode	UNII-2C_TX N(HT20) Mode 5500 MHz	Polarization	Vertical
-----------	----------------------------------	--------------	----------

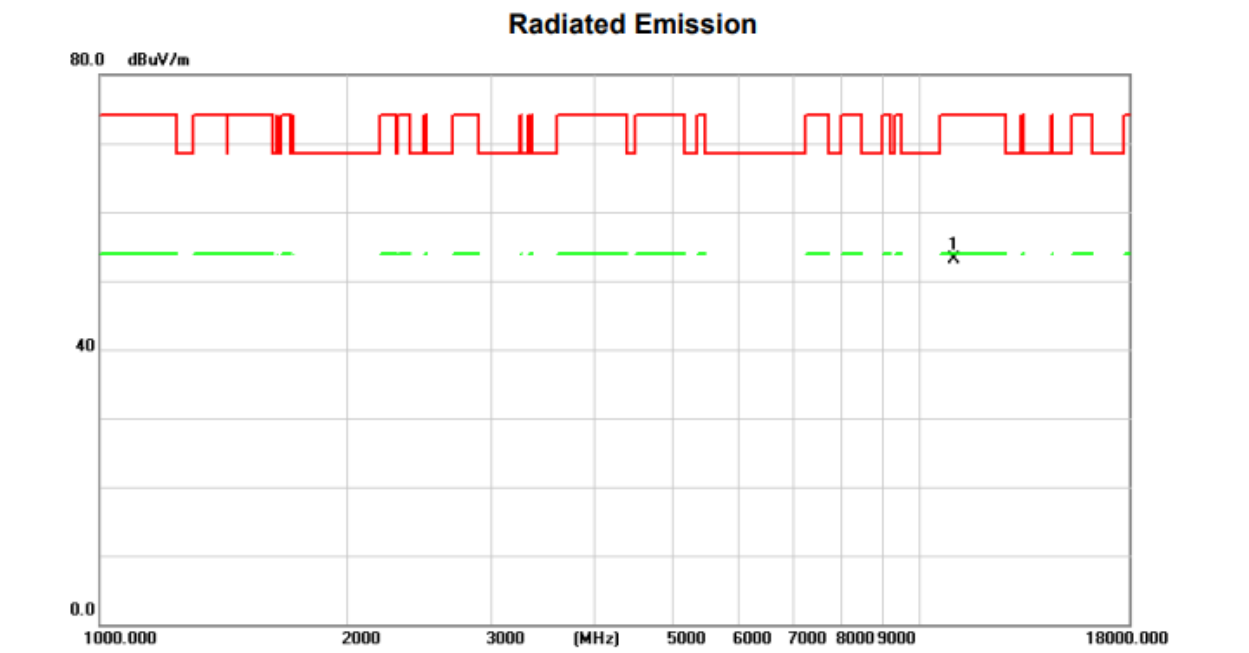

No.	Mk.	Freq.	Reading Level	Correct Factor	Measurement	Limit	Over	Antenna Height	Table Degree
		MHz	dBuV	dB/m	dBuV/m	dBuV/m	dB	cm	degree
1	*	11000.000	42.88	10.29	53.17	74.00	-20.83	peak	

REMARKS:

- (1) Measurement Value = Reading Level + Correct Factor.
- (2) Margin Level = Measurement Value - Limit Value.

Test Mode	UNII-2C_TX N(HT20) Mode 5500 MHz	Polarization	Horizontal
-----------	----------------------------------	--------------	------------

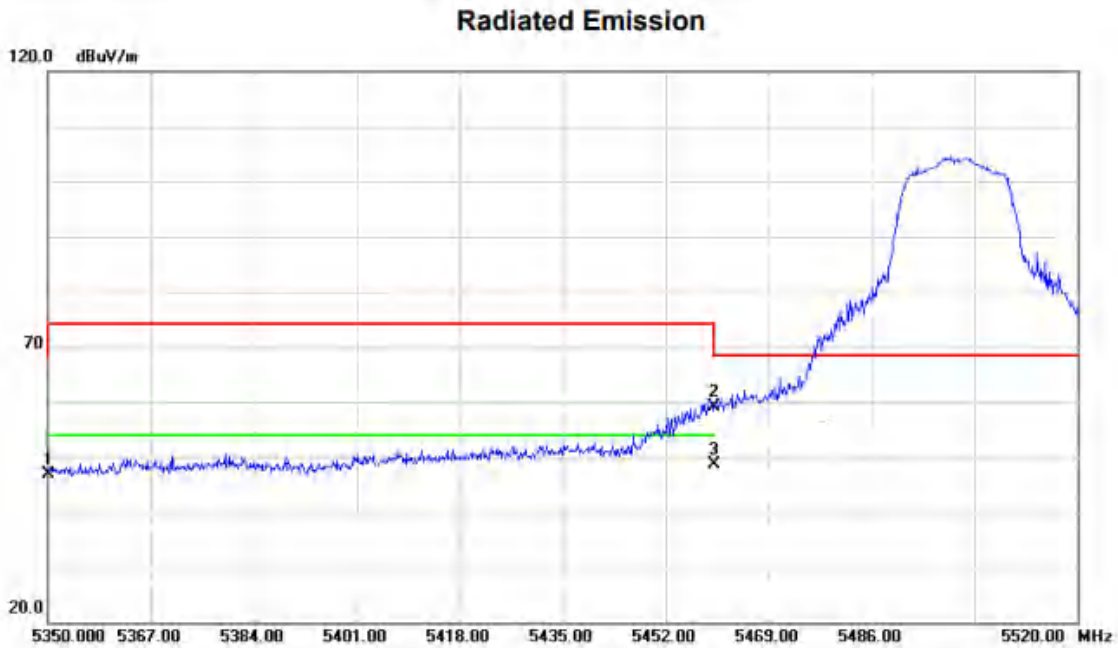

No.	Mk.	Freq.	Reading Level	Correct Factor	Measurement	Limit	Over	Antenna Height	Table Degree	
		MHz	dBuV	dB/m	dBuV/m	dBuV/m	dB	cm	degree	Comment
1		5350.000	49.57	-2.78	46.79	68.20	-21.41			peak
2		5460.000	61.85	-2.67	59.18	68.20	-9.02			peak
3	*	5460.000	51.26	-2.67	48.59	54.00	-5.41			AVG

REMARKS:

- (1) Measurement Value = Reading Level + Correct Factor.
- (2) Margin Level = Measurement Value - Limit Value.

Test Mode	UNII-2C_TX N(HT20) Mode 5500 MHz	Polarization	Horizontal
-----------	----------------------------------	--------------	------------

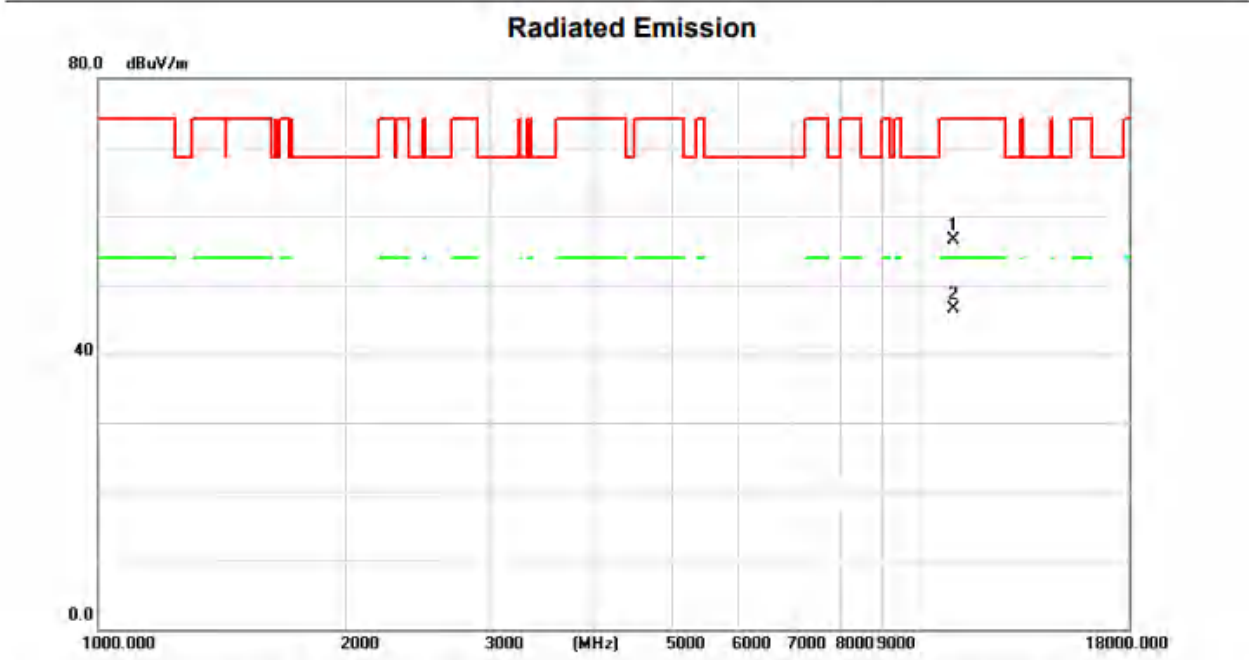

No.	Mk.	Freq.	Reading Level	Correct Factor	Measurement	Limit	Over	Antenna Height	Table Degree
		MHz	dBuV	dB/m	dBuV/m	dBuV/m	dB	cm	degree
1		11000.000	46.27	10.29	56.56	74.00	-17.44	peak	
2 *		11000.000	36.19	10.29	46.48	54.00	-7.52	AVG	

REMARKS:

- (1) Measurement Value = Reading Level + Correct Factor.
- (2) Margin Level = Measurement Value - Limit Value.

Test Mode	UNII-2C_TX N(HT20) Mode 5580 MHz	Polarization	Vertical
-----------	----------------------------------	--------------	----------

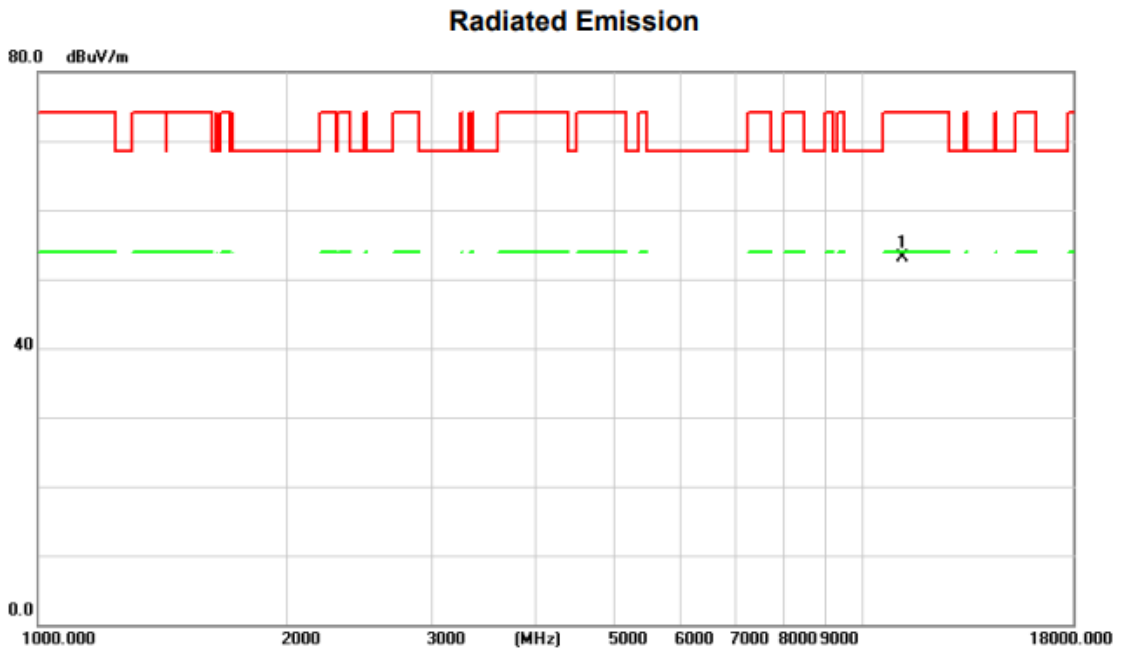

No.	Mk.	Freq.	Reading Level	Correct Factor	Measurement	Limit	Over	Antenna Height	Table Degree
		MHz	dBuV	dB/m	dBuV/m	dBuV/m	dB	Detector	cm
1	*	11160.000	43.04	9.98	53.02	74.00	-20.98	peak	

REMARKS:

- (1) Measurement Value = Reading Level + Correct Factor.
- (2) Margin Level = Measurement Value - Limit Value.

Test Mode	UNII-2C_TX N(HT20) Mode 5580 MHz	Polarization	Horizontal
-----------	----------------------------------	--------------	------------

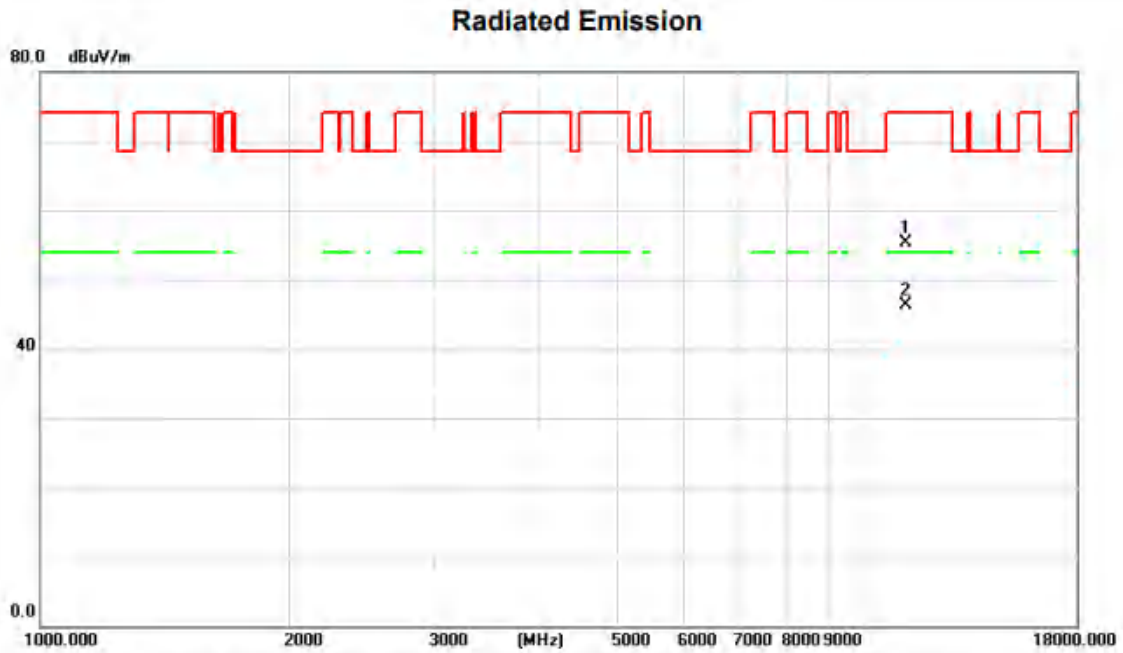

No.	Mk.	Freq.	Reading Level	Correct Factor	Measurement	Limit	Over	Antenna Height	Table Degree	
		MHz	dBuV	dB/m	dBuV/m	dBuV/m	dB	cm	degree	Comment
1		11160.000	45.25	9.98	55.23	74.00	-18.77	peak		
2	*	11160.000	36.38	9.98	46.36	54.00	-7.64	AVG		

REMARKS:

(1) Measurement Value = Reading Level + Correct Factor.

(2) Margin Level = Measurement Value - Limit Value.

Test Mode	UNII-2C_TX N(HT20) Mode 5700 MHz	Polarization	Vertical
-----------	----------------------------------	--------------	----------

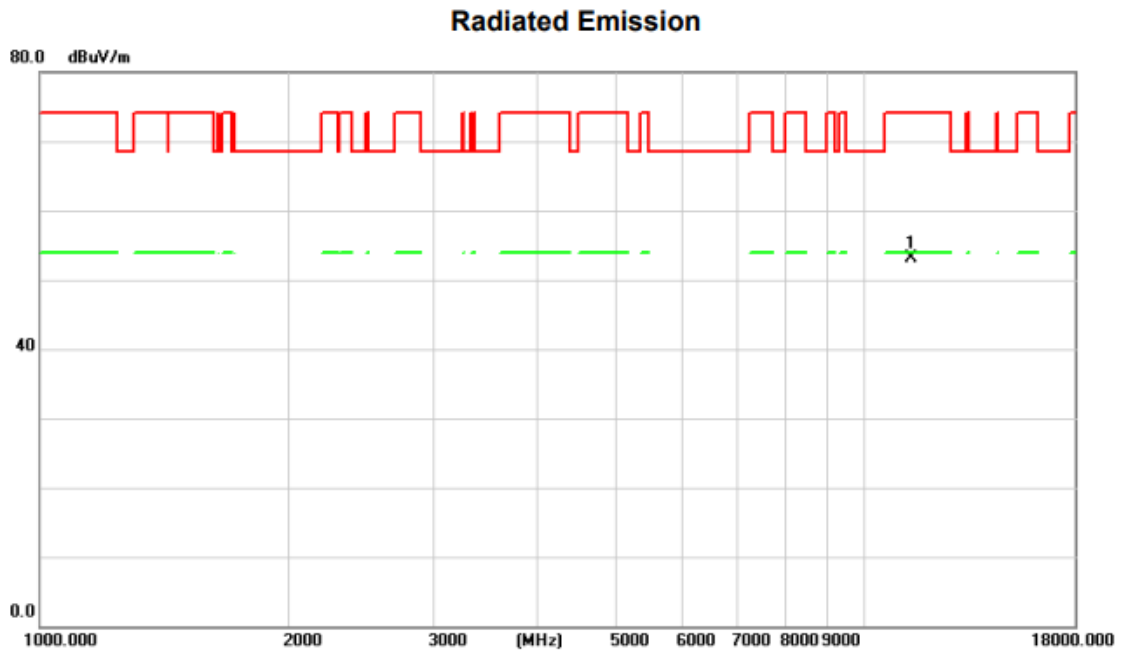

No.	Mk.	Freq.	Reading Level	Correct Factor	Measurement	Limit	Over	Antenna Height	Table Degree
		MHz	dBuV	dB/m	dBuV/m	dBuV/m	dB	cm	degree
1	*	11400.000	43.53	9.51	53.04	74.00	-20.96	peak	

REMARKS:

- (1) Measurement Value = Reading Level + Correct Factor.
- (2) Margin Level = Measurement Value - Limit Value.

Test Mode	UNII-2C_TX N(HT20) Mode 5700 MHz	Polarization	Horizontal
-----------	----------------------------------	--------------	------------

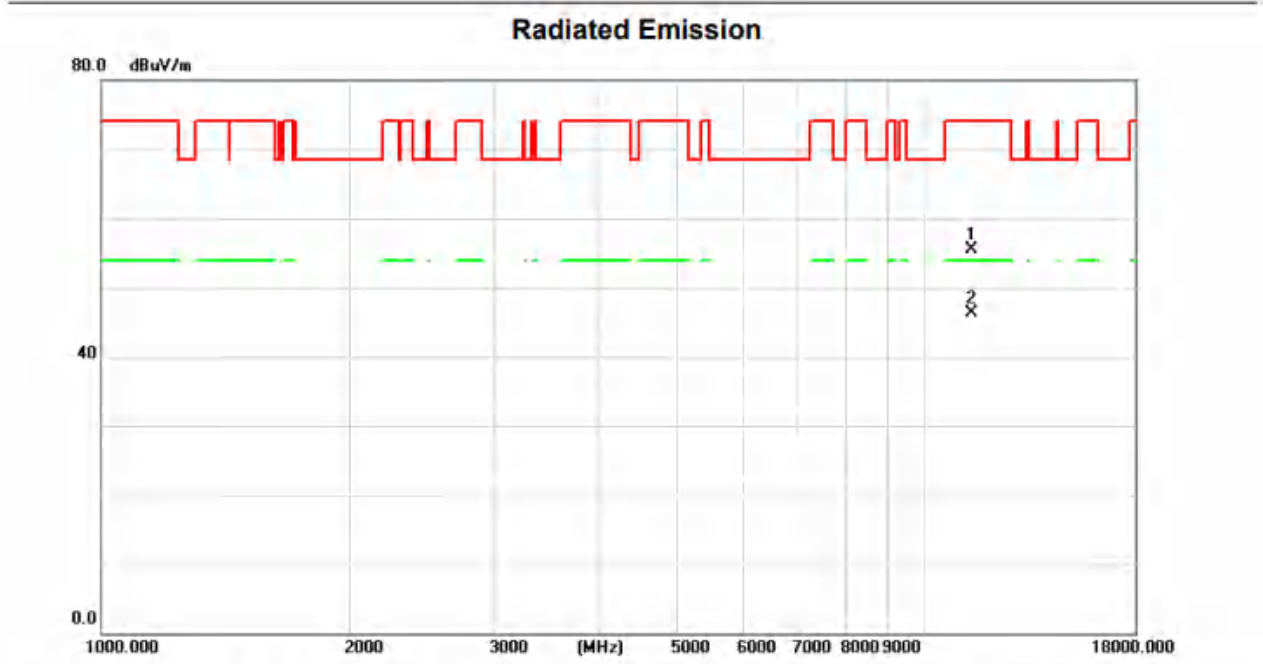

No.	Mk.	Freq.	Reading Level	Correct Factor	Measurement	Limit	Over	Antenna Height	Table Degree
		MHz	dBuV	dB/m	dBuV/m	dBuV/m	dB	cm	degree
1		11400.000	45.94	9.51	55.45	74.00	-18.55	peak	
2	*	11400.000	36.81	9.51	46.32	54.00	-7.68	AVG	

REMARKS:

- (1) Measurement Value = Reading Level + Correct Factor.
- (2) Margin Level = Measurement Value - Limit Value.

Test Mode	UNII-2C_TX N(HT40) Mode 5510 MHz	Polarization	Vertical
-----------	----------------------------------	--------------	----------

Radiated Emission

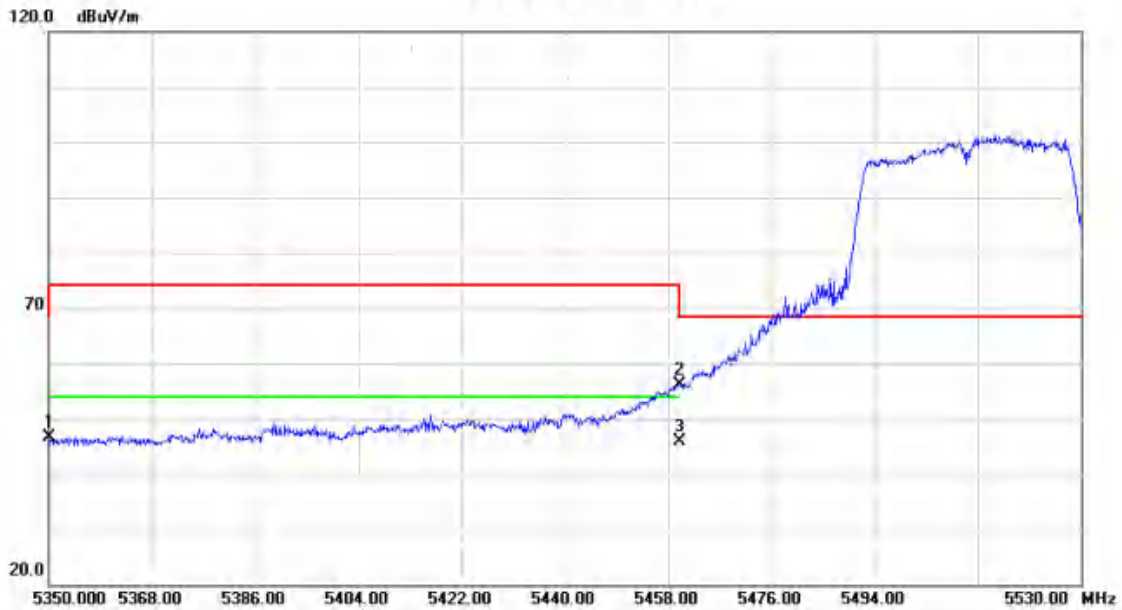

No.	Mk.	Freq.	Reading Level	Correct Factor	Measurement	Limit	Over	Antenna Height	Table Degree	
		MHz	dBuV	dB/m	dBuV/m	dBuV/m	dB	cm	degree	Comment
1		5350.000	49.30	-2.78	46.52	68.20	-21.68			peak
2		5460.000	58.81	-2.67	56.14	68.20	-12.06			peak
3	*	5460.000	48.44	-2.67	45.77	54.00	-8.23			AVG

REMARKS:

- (1) Measurement Value = Reading Level + Correct Factor.
- (2) Margin Level = Measurement Value - Limit Value.

Test Mode	UNII-2C_TX N(HT40) Mode 5510 MHz	Polarization	Vertical
-----------	----------------------------------	--------------	----------

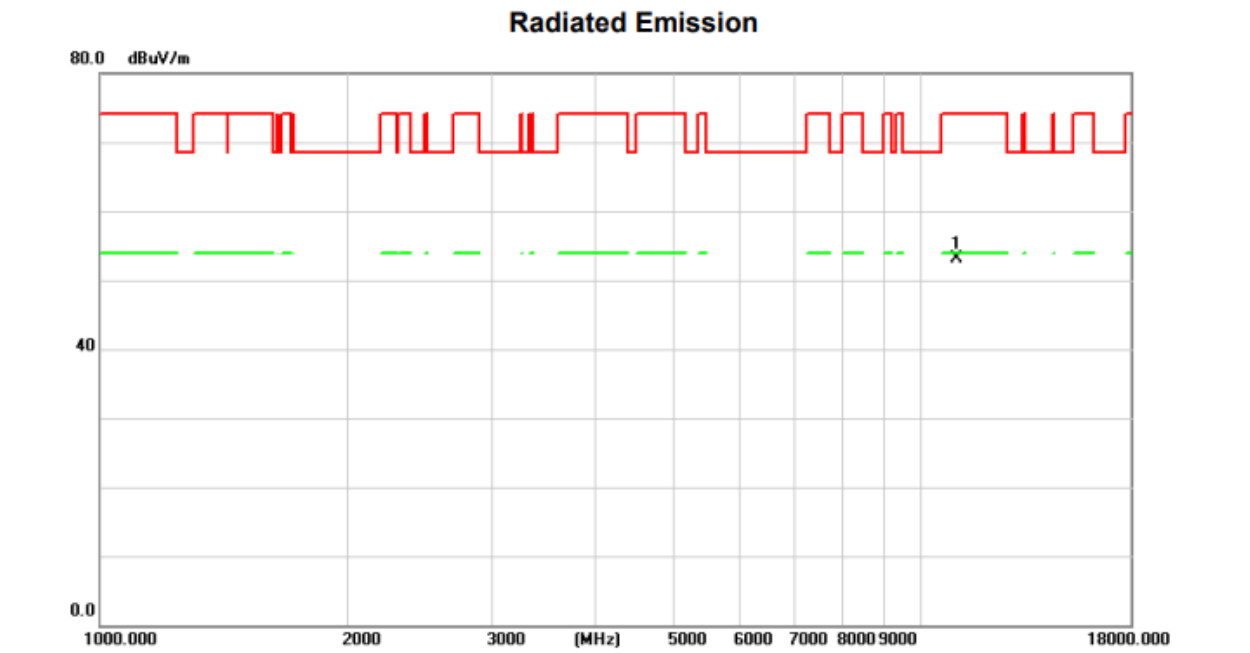

No.	Mk.	Freq.	Reading Level	Correct Factor	Measurement	Limit	Over	Antenna Height	Table Degree
		MHz	dBuV	dB/m	dBuV/m	dBuV/m	dB	cm	degree
1	*	11020.000	42.84	10.25	53.09	74.00	-20.91	peak	

REMARKS:

- (1) Measurement Value = Reading Level + Correct Factor.
- (2) Margin Level = Measurement Value - Limit Value.

Test Mode	UNII-2C_TX N(HT40) Mode 5510 MHz	Polarization	Horizontal
-----------	----------------------------------	--------------	------------

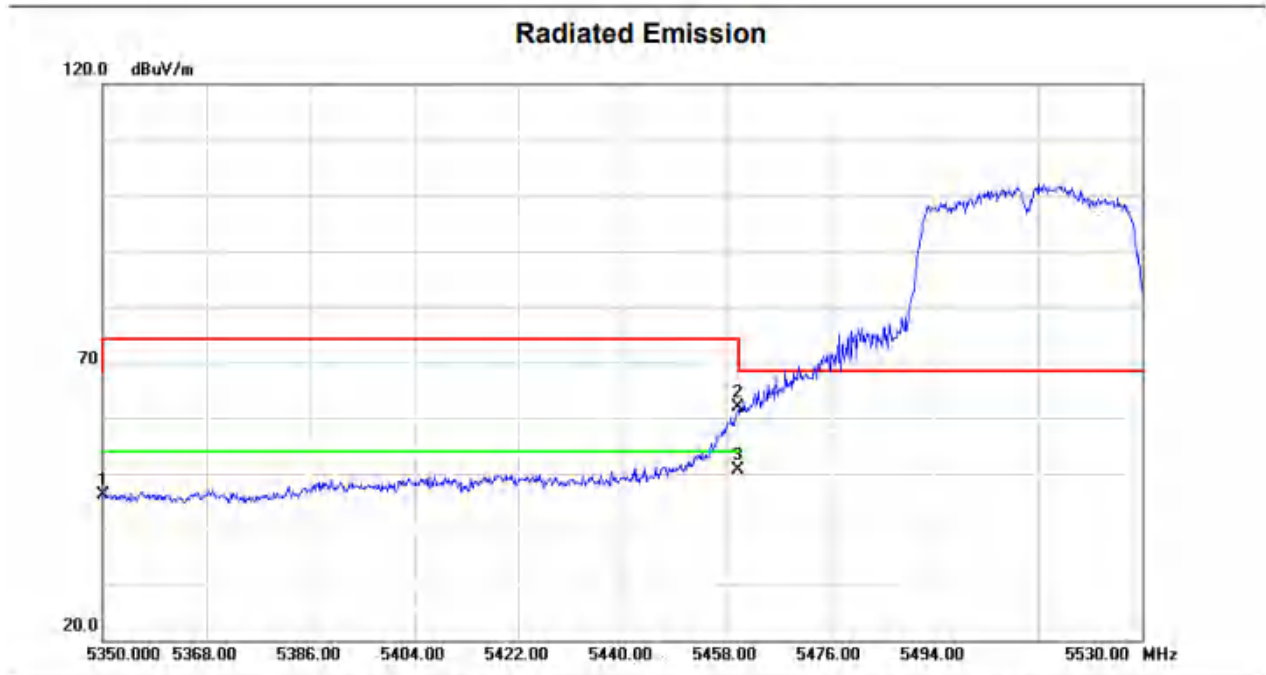

No.	Mk.	Freq.	Reading Level	Correct Factor	Measurement	Limit	Over	Antenna Height	Table Degree	
		MHz	dBuV	dB/m	dBuV/m	dBuV/m	dB	cm	degree	Comment
1		5350.000	48.83	-2.78	46.05	68.20	-22.15			peak
2		5460.000	64.63	-2.67	61.96	68.20	-6.24			peak
3	*	5460.000	53.32	-2.67	50.65	54.00	-3.35			AVG

REMARKS:

- (1) Measurement Value = Reading Level + Correct Factor.
- (2) Margin Level = Measurement Value - Limit Value.

Test Mode	UNII-2C_TX N(HT40) Mode 5510 MHz	Polarization	Horizontal
-----------	----------------------------------	--------------	------------

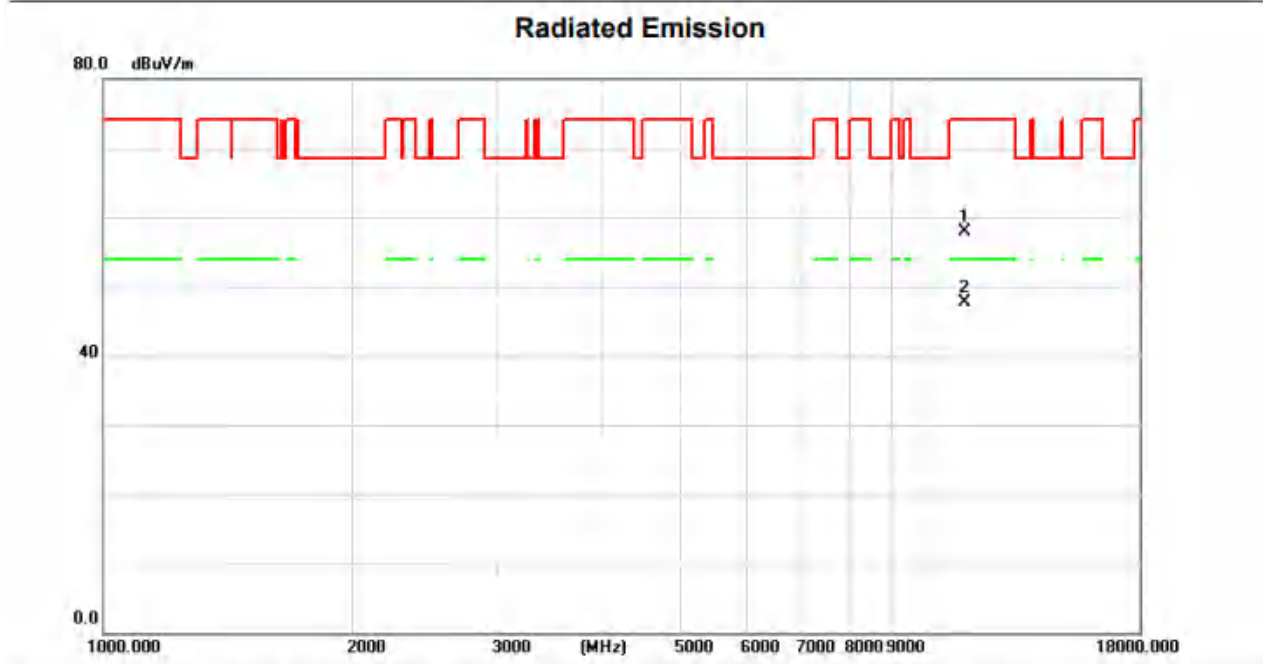

No.	Mk.	Freq.	Reading Level	Correct Factor	Measurement	Limit	Over	Antenna Height	Table Degree
		MHz	dBuV	dB/m	dBuV/m	dBuV/m	dB	cm	degree
1		11020.000	47.58	10.25	57.83	74.00	-16.17	peak	
2	*	11020.000	37.37	10.25	47.62	54.00	-6.38	AVG	

REMARKS:

- (1) Measurement Value = Reading Level + Correct Factor.
- (2) Margin Level = Measurement Value - Limit Value.

Test Mode	UNII-2C_TX N(HT40) Mode 5550 MHz	Polarization	Vertical
-----------	----------------------------------	--------------	----------

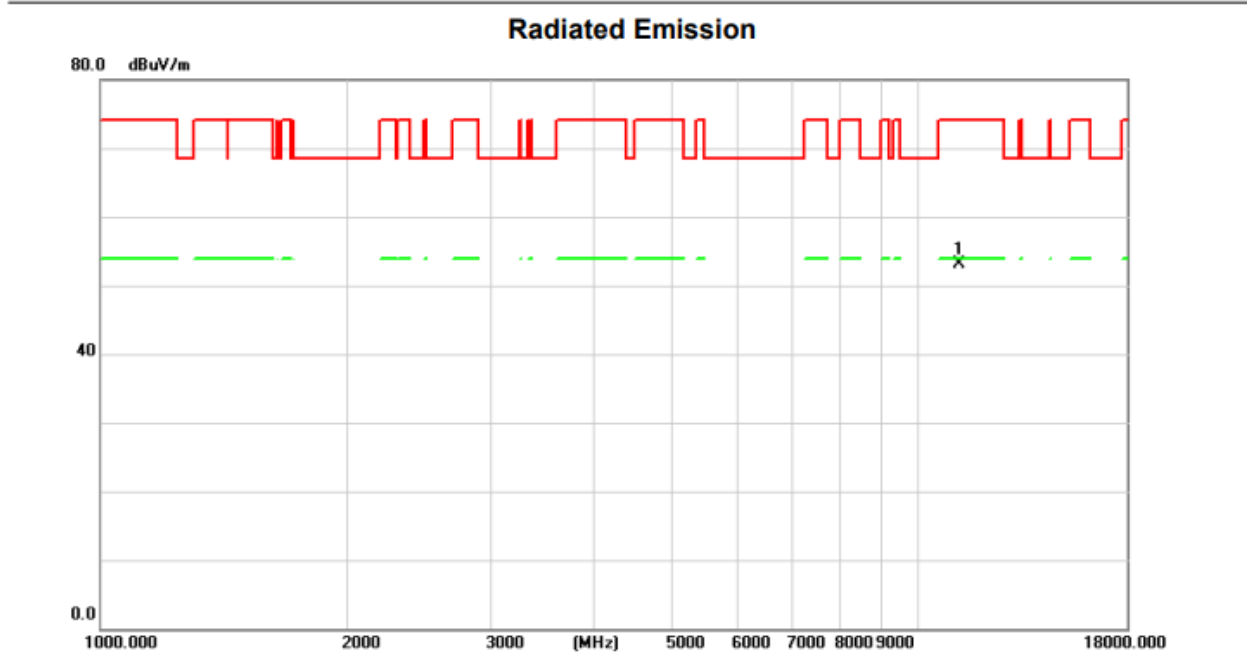

No.	Mk.	Freq.	Reading Level	Correct Factor	Measurement	Limit	Over	Antenna Height	Table Degree	
		MHz	dBuV	dB/m	dBuV/m	dBuV/m	dB	cm	degree	Comment
1	*	11100.000	43.09	9.94	53.03	74.00	-20.97	peak		

REMARKS:

- (1) Measurement Value = Reading Level + Correct Factor.
- (2) Margin Level = Measurement Value - Limit Value.

Test Mode	UNII-2C_TX N(HT40) Mode 5500 MHz	Polarization	Horizontal
-----------	----------------------------------	--------------	------------

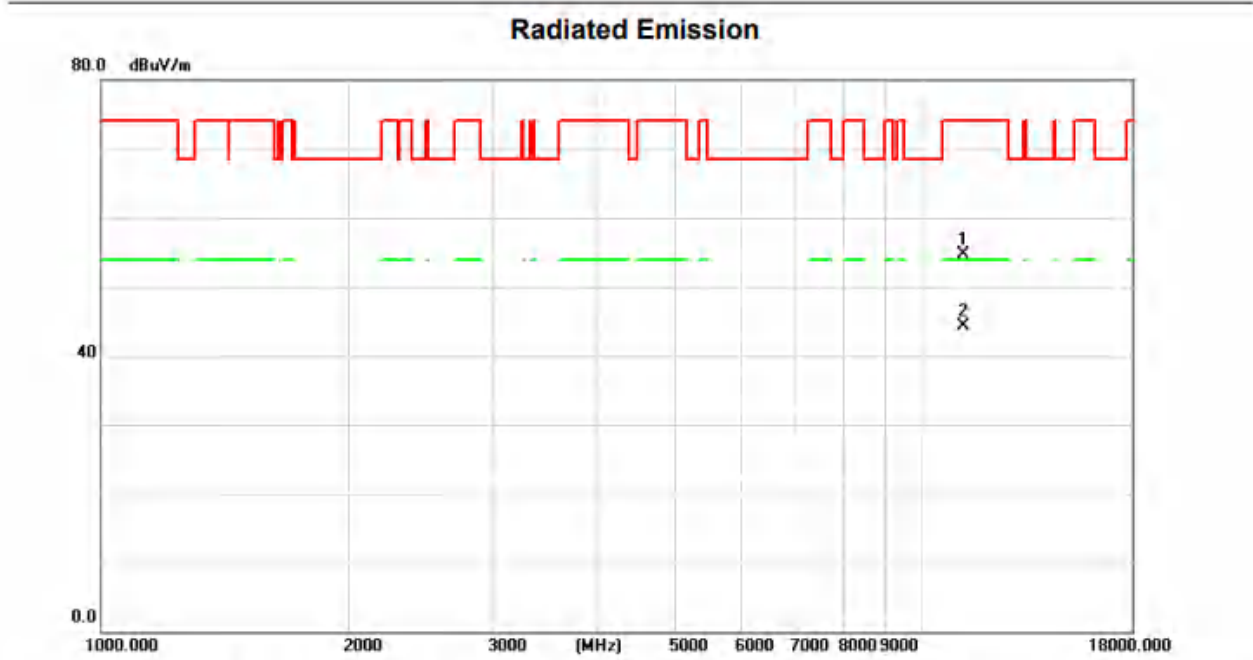

No.	Mk.	Freq.	Reading Level	Correct Factor	Measurement	Limit	Over	Antenna Height	Table Degree
		MHz	dBuV	dB/m	dBuV/m	dBuV/m	dB	cm	degree
1		11100.000	44.77	9.94	54.71	74.00	-19.29	peak	
2	*	11100.000	34.31	9.94	44.25	54.00	-9.75	AVG	

REMARKS:

(1) Measurement Value = Reading Level + Correct Factor.

(2) Margin Level = Measurement Value - Limit Value.

Test Mode	UNII-2C_TX N(HT40) Mode 5670 MHz	Polarization	Vertical
-----------	----------------------------------	--------------	----------

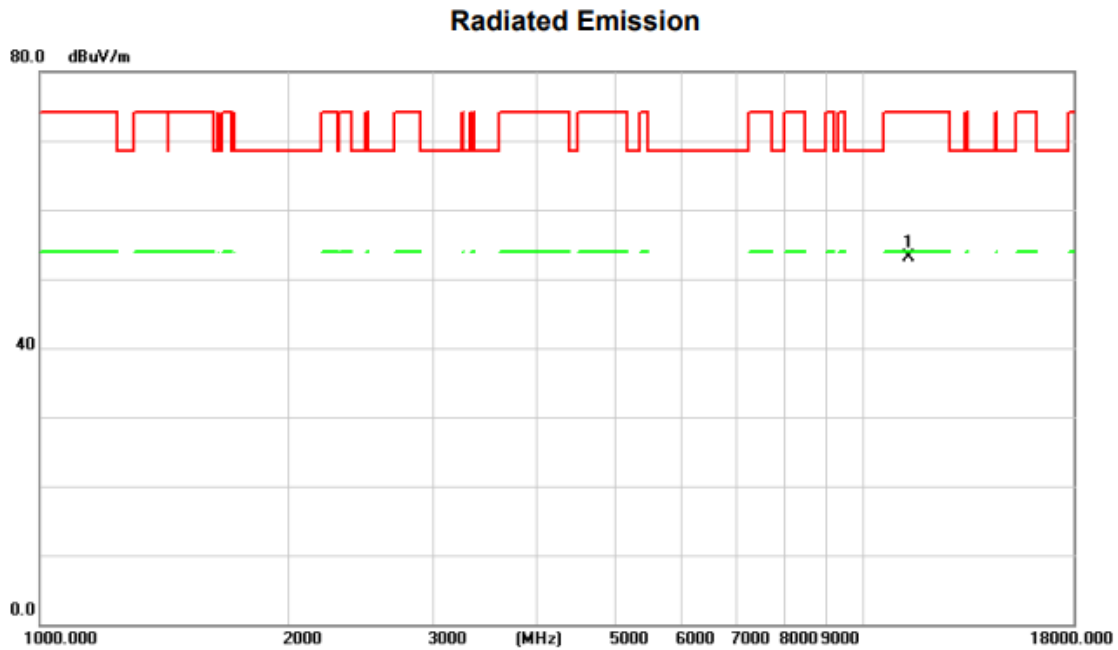

No.	Mk.	Freq.	Reading Level	Correct Factor	Measurement	Limit	Over	Antenna Height	Table Degree	
		MHz	dBuV	dB/m	dBuV/m	dBuV/m	dB	cm	degree	Comment
1	*	11340.000	43.54	9.63	53.17	74.00	-20.83	peak		

REMARKS:

- (1) Measurement Value = Reading Level + Correct Factor.
- (2) Margin Level = Measurement Value - Limit Value.

Test Mode	UNII-2C_TX N(HT40) Mode 5670 MHz	Polarization	Horizontal
-----------	----------------------------------	--------------	------------

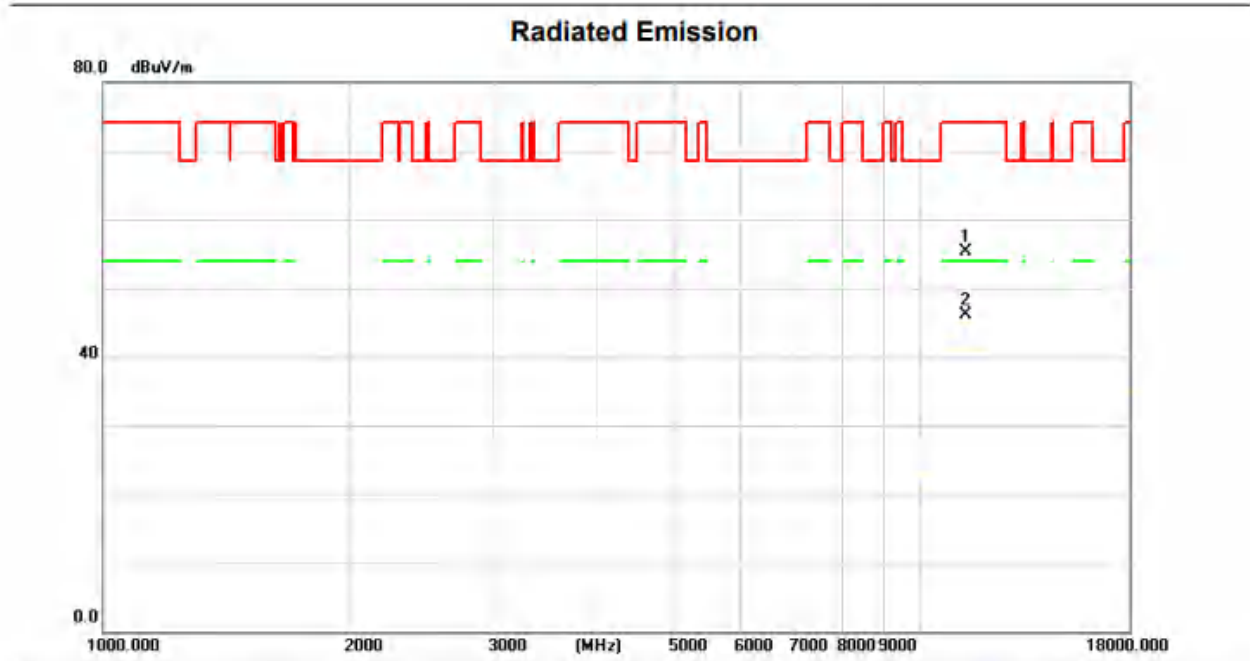

No.	Mk.	Freq.	Reading Level	Correct Factor	Measurement	Limit	Over	Antenna Height	Table Degree
		MHz	dBuV	dB/m	dBuV/m	dBuV/m	dB	cm	degree
1		11340.000	45.75	9.63	55.38	74.00	-18.62	peak	
2	*	11340.000	36.49	9.63	46.12	54.00	-7.88	AVG	

REMARKS:

- (1) Measurement Value = Reading Level + Correct Factor.
- (2) Margin Level = Measurement Value - Limit Value.

Test Mode	UNII-2C_TX AC(HT20) Mode 5500 MHz	Polarization	Vertical
-----------	-----------------------------------	--------------	----------

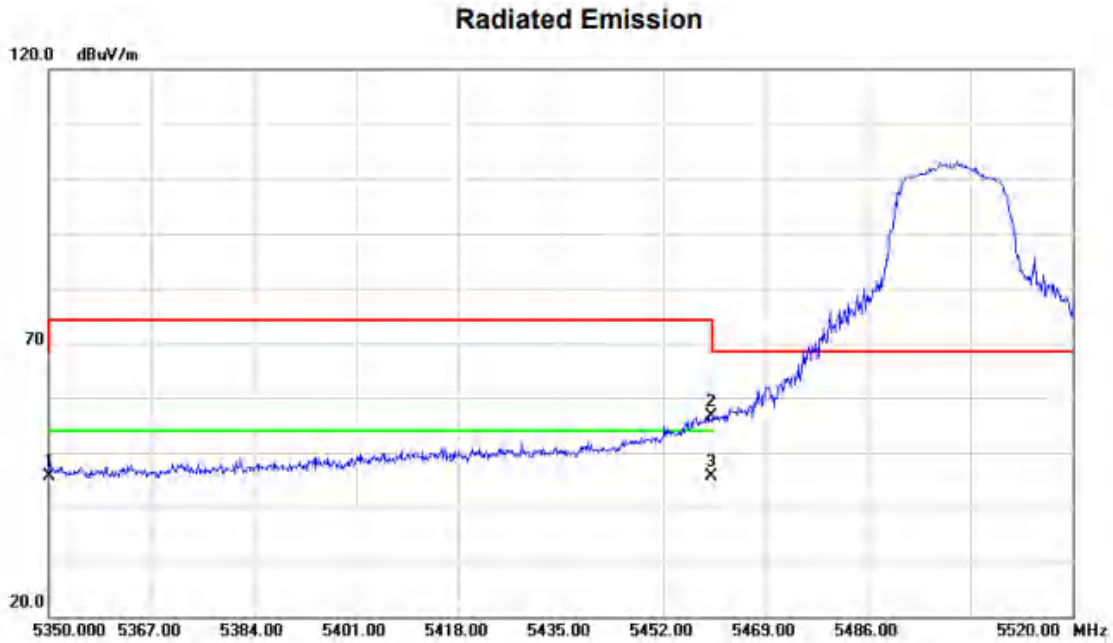

No.	Mk.	Freq.	Reading Level	Correct Factor	Measurement	Limit	Over	Antenna Height	Table Degree	
		MHz	dBuV	dB/m	dBuV/m	dBuV/m	dB	cm	degree	Comment
1		5350.000	48.50	-2.78	45.72	68.20	-22.48			peak
2		5460.000	59.32	-2.67	56.65	68.20	-11.55			peak
3	*	5460.000	48.29	-2.67	45.62	54.00	-8.38			AVG

REMARKS:

- (1) Measurement Value = Reading Level + Correct Factor.
- (2) Margin Level = Measurement Value - Limit Value.

Test Mode	UNII-2C_TX AC(HT20) Mode 5500 MHz	Polarization	Vertical
-----------	-----------------------------------	--------------	----------

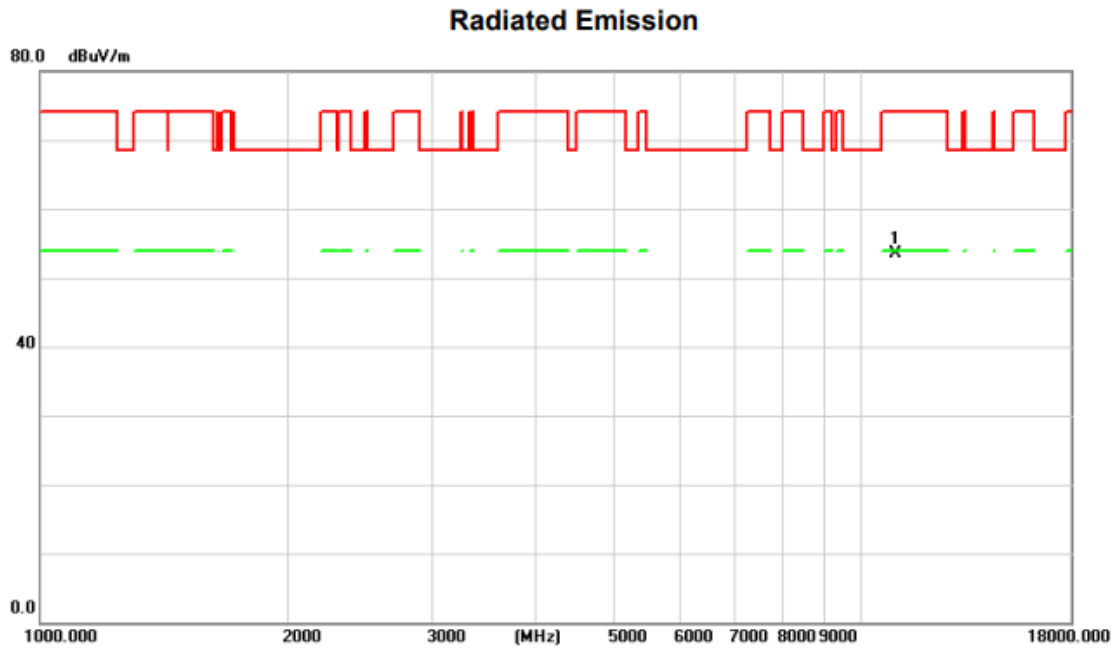

No.	Mk.	Freq.	Reading Level	Correct Factor	Measurement	Limit	Over	Antenna Height	Table Degree	
		MHz	dBuV	dB/m	dBuV/m	dBuV/m	dB	cm	degree	Comment
1	*	11000.000	43.13	10.29	53.42	74.00	-20.58	peak		

REMARKS:

- (1) Measurement Value = Reading Level + Correct Factor.
- (2) Margin Level = Measurement Value - Limit Value.

Test Mode	UNII-2C_TX AC(HT20) Mode 5500 MHz	Polarization	Horizontal
-----------	-----------------------------------	--------------	------------

Radiated Emission

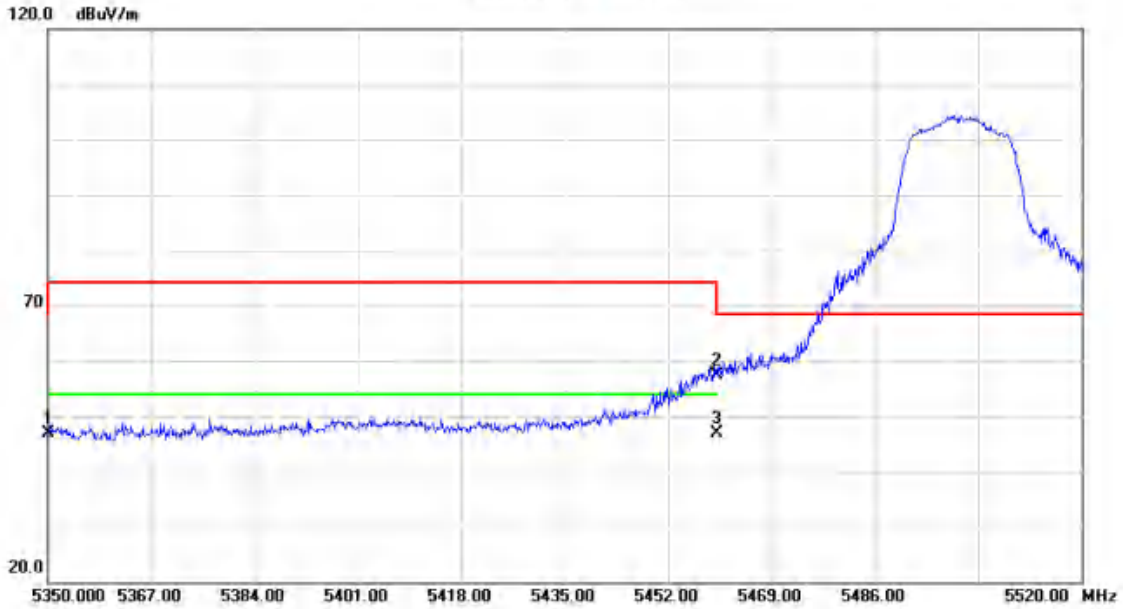

No.	Mk.	Freq.	Reading Level	Correct Factor	Measurement	Limit	Over	Antenna Height	Table Degree	
		MHz	dBuV	dB/m	dBuV/m	dBuV/m	dB	cm	degree	Comment
1		5350.000	49.77	-2.78	46.99	68.20	-21.21			peak
2		5460.000	60.15	-2.67	57.48	68.20	-10.72			peak
3	*	5460.000	49.56	-2.67	46.89	54.00	-7.11			AVG

REMARKS:

- (1) Measurement Value = Reading Level + Correct Factor.
- (2) Margin Level = Measurement Value - Limit Value.

Test Mode	UNII-2C_TX AC(HT20) Mode 5500 MHz	Polarization	Horizontal
-----------	-----------------------------------	--------------	------------

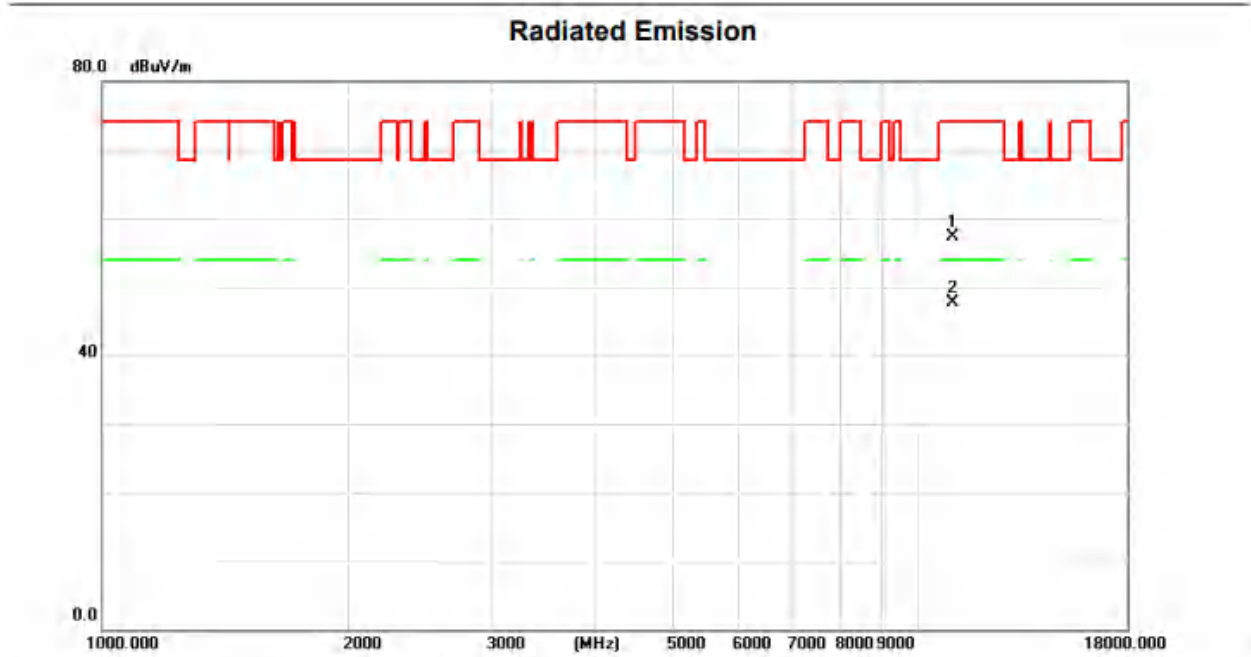

No.	Mk.	Freq.	Reading Level	Correct Factor	Measurement	Limit	Over	Antenna Height	Table Degree	
		MHz	dBuV	dB/m	dBuV/m	dBuV/m	dB	cm	degree	Comment
1		11000.000	46.97	10.29	57.26	74.00	-16.74	peak		
2	*	11000.000	37.39	10.29	47.68	54.00	-6.32	AVG		

REMARKS:

- (1) Measurement Value = Reading Level + Correct Factor.
- (2) Margin Level = Measurement Value - Limit Value.

Test Mode	UNII-2C_TX AC(HT20) Mode 5580 MHz	Polarization	Vertical
-----------	-----------------------------------	--------------	----------

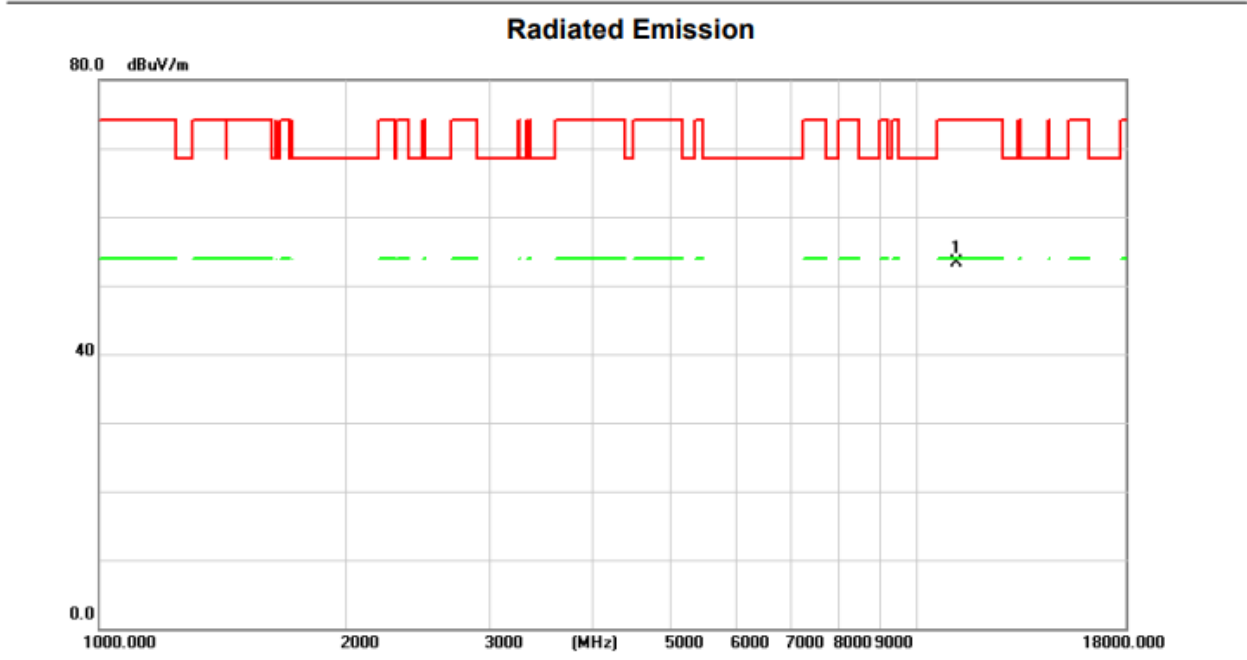

No.	Mk.	Freq.	Reading Level	Correct Factor	Measurement	Limit	Over	Antenna Height	Table Degree
		MHz	dBuV	dB/m	dBuV/m	dBuV/m	dB	cm	degree
1	*	11160.000	43.31	9.98	53.29	74.00	-20.71	peak	

REMARKS:

- (1) Measurement Value = Reading Level + Correct Factor.
- (2) Margin Level = Measurement Value - Limit Value.

Test Mode	UNII-2C_TX AC(HT20) Mode 5580 MHz	Polarization	Horizontal
-----------	-----------------------------------	--------------	------------

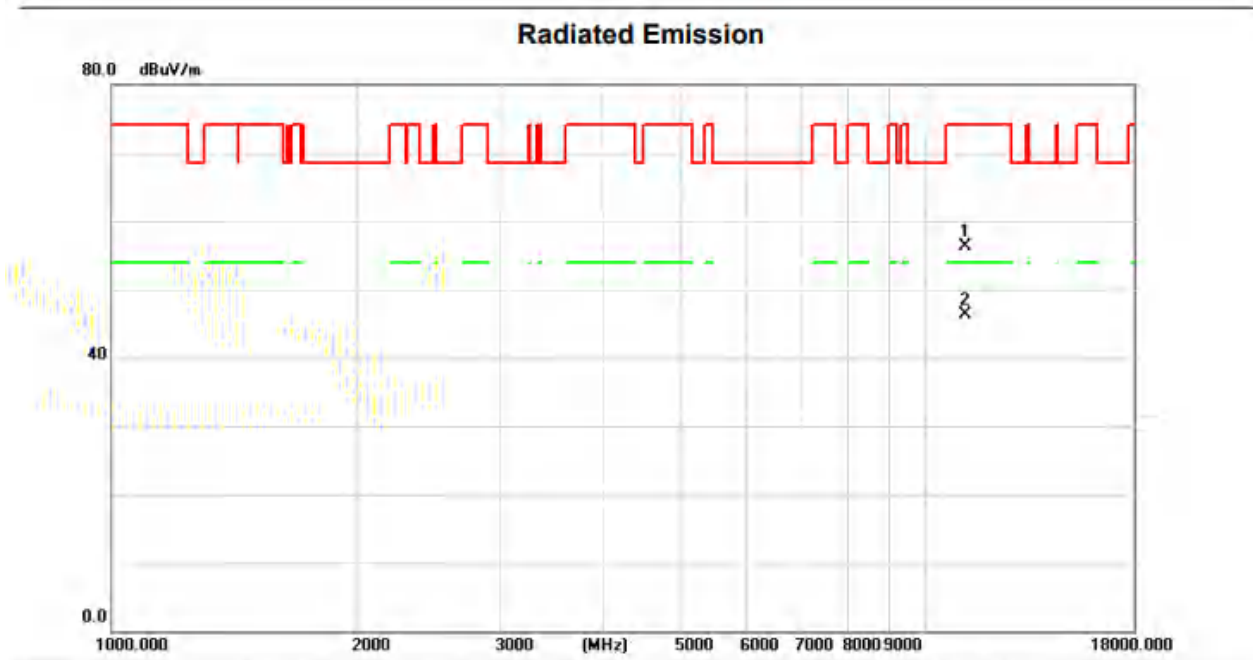

No.	Mk.	Freq.	Reading Level	Correct Factor	Measurement	Limit	Over	Antenna Height	Table Degree	
		MHz	dBuV	dB/m	dBuV/m	dBuV/m	dB	cm	degree	Comment
1		11160.000	46.27	9.98	56.25	74.00	-17.75			peak
2	*	11160.000	36.39	9.98	46.37	54.00	-7.63			AVG

REMARKS:

(1) Measurement Value = Reading Level + Correct Factor.

(2) Margin Level = Measurement Value - Limit Value.

Test Mode	UNII-2C_TX AC(HT20) Mode 5700 MHz	Polarization	Vertical
-----------	-----------------------------------	--------------	----------

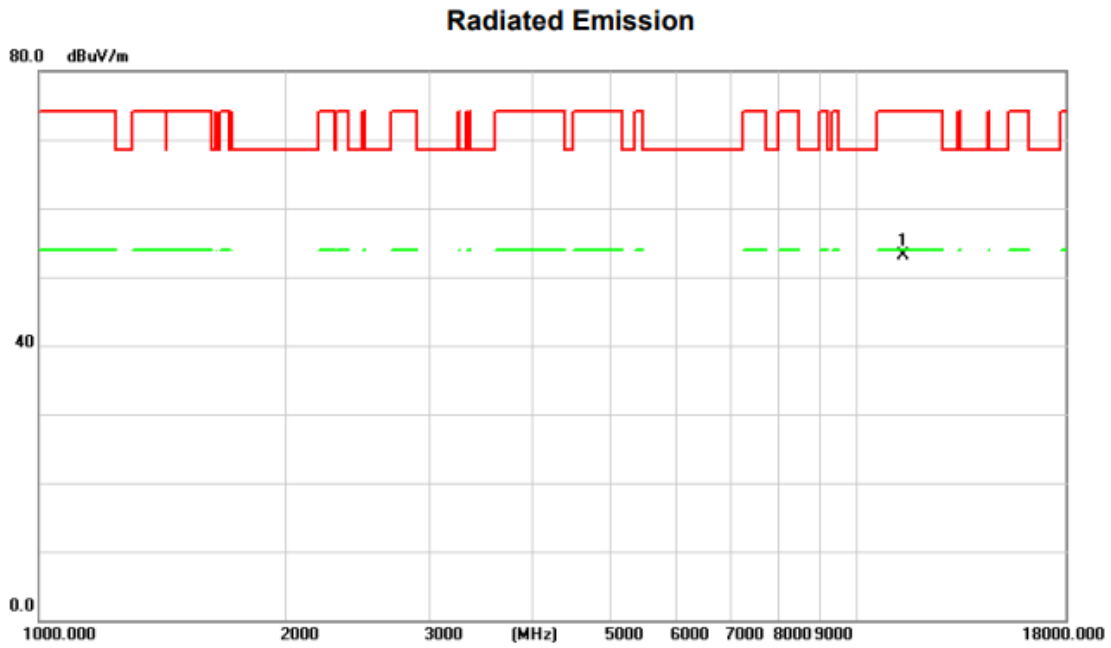

No.	Mk.	Freq.	Reading Level	Correct Factor	Measurement	Limit	Over	Antenna Height	Table Degree	Comment
		MHz	dBuV	dB/m	dBuV/m	dBuV/m	dB	cm	degree	
1	*	11400.000	43.64	9.51	53.15	74.00	-20.85	peak		

REMARKS:

- (1) Measurement Value = Reading Level + Correct Factor.
- (2) Margin Level = Measurement Value - Limit Value.

Test Mode	UNII-2C_TX AC(HT20) Mode 5700 MHz	Polarization	Horizontal
-----------	-----------------------------------	--------------	------------

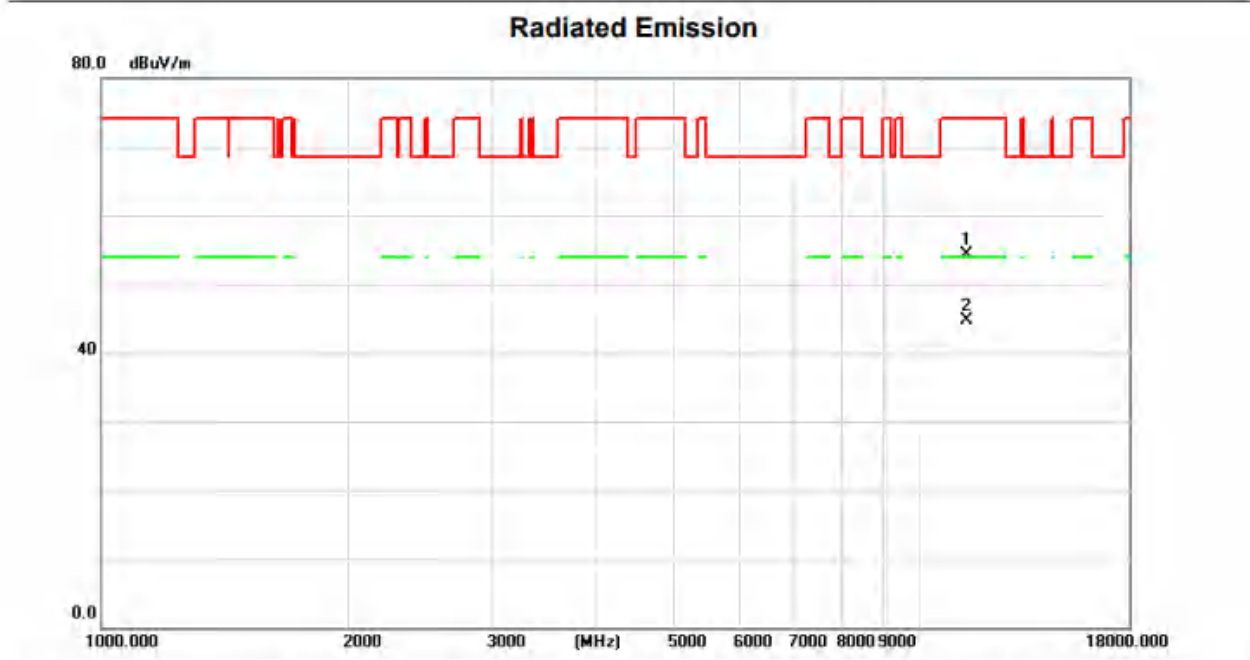

No.	Mk.	Freq.	Reading Level	Correct Factor	Measurement	Limit	Over	Antenna Height	Table Degree	
		MHz	dBuV	dB/m	dBuV/m	dBuV/m	dB	cm	degree	Comment
1		11400.000	44.71	9.51	54.22	74.00	-19.78			peak
2	*	11400.000	35.28	9.51	44.79	54.00	-9.21			AVG

REMARKS:

- (1) Measurement Value = Reading Level + Correct Factor.
- (2) Margin Level = Measurement Value - Limit Value.

Test Mode	UNII-2C_TX AC(HT40) Mode 5510 MHz	Polarization	Vertical
-----------	-----------------------------------	--------------	----------

Radiated Emission

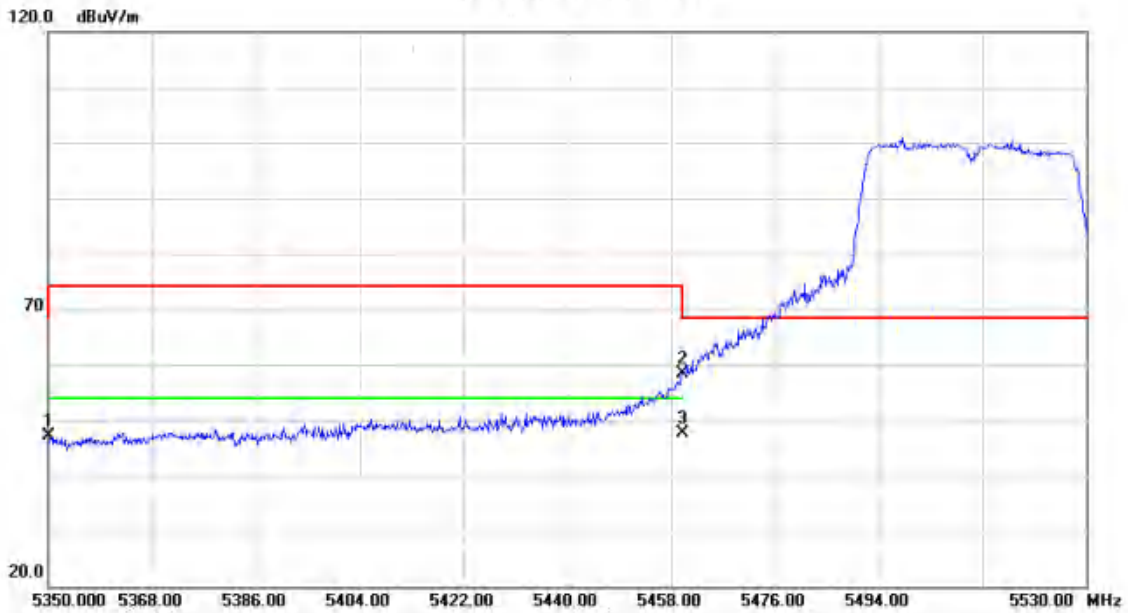

No.	Mk.	Freq.	Reading Level	Correct Factor	Measurement	Limit	Over	Antenna Height	Table Degree	
		MHz	dBuV	dB/m	dBuV/m	dBuV/m	dB	cm	degree	Comment
1		5350.000	49.88	-2.78	47.10	68.20	-21.10			peak
2		5460.000	60.94	-2.67	58.27	68.20	-9.93			peak
3	*	5460.000	50.36	-2.67	47.69	54.00	-6.31			AVG

REMARKS:

- (1) Measurement Value = Reading Level + Correct Factor.
- (2) Margin Level = Measurement Value - Limit Value.

Test Mode	UNII-2C_TX N(HT40) Mode 5510 MHz	Polarization	Vertical
-----------	----------------------------------	--------------	----------

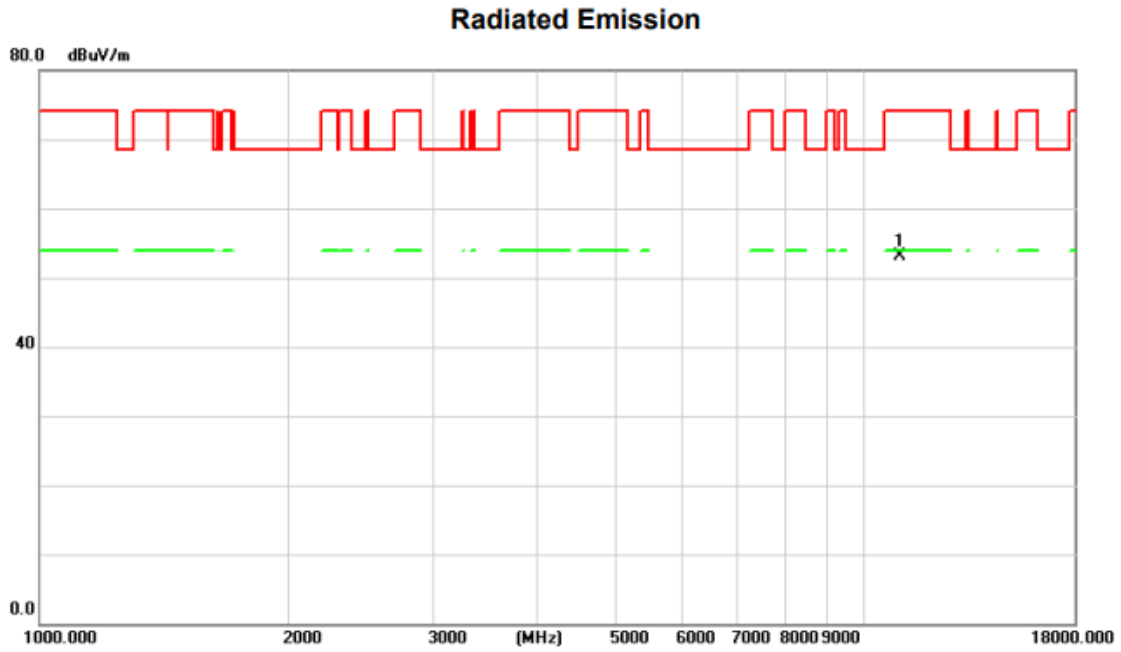

No.	Mk.	Freq.	Reading Level	Correct Factor	Measurement	Limit	Over	Antenna Height	Table Degree	
		MHz	dBuV	dB/m	dBuV/m	dBuV/m	dB	cm	degree	Comment
1	*	11020.000	42.92	10.25	53.17	74.00	-20.83			peak

REMARKS:

- (1) Measurement Value = Reading Level + Correct Factor.
- (2) Margin Level = Measurement Value - Limit Value.

Test Mode	UNII-2C_TX N(HT40) Mode 5510 MHz	Polarization	Horizontal
-----------	----------------------------------	--------------	------------

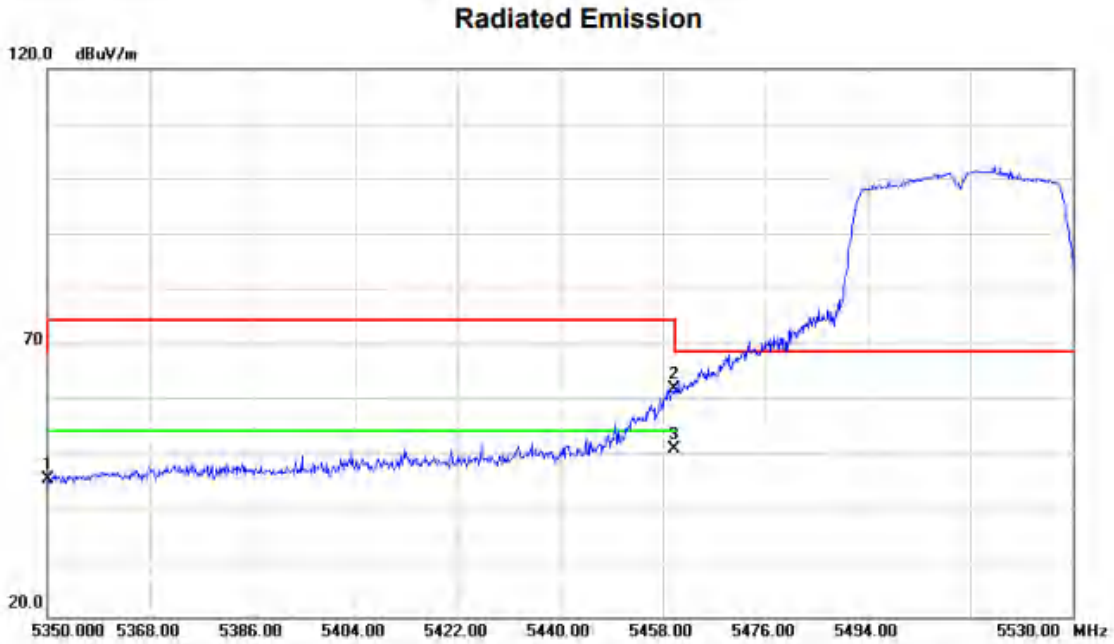

No.	Mk.	Freq.	Reading Level	Correct Factor	Measurement	Limit	Over	Antenna Height	Table Degree	Comment
		MHz	dBuV	dB/m	dBuV/m	dBuV/m	dB	cm	degree	
1		5350.000	47.94	-2.78	45.16	68.20	-23.04	peak		
2		5460.000	64.41	-2.67	61.74	68.20	-6.46	peak		
3	*	5460.000	53.25	-2.67	50.58	54.00	-3.42	AVG		

REMARKS:

- (1) Measurement Value = Reading Level + Correct Factor.
- (2) Margin Level = Measurement Value - Limit Value.

Test Mode	UNII-2C_TX AC(HT40) Mode 5510 MHz	Polarization	Horizontal
-----------	-----------------------------------	--------------	------------

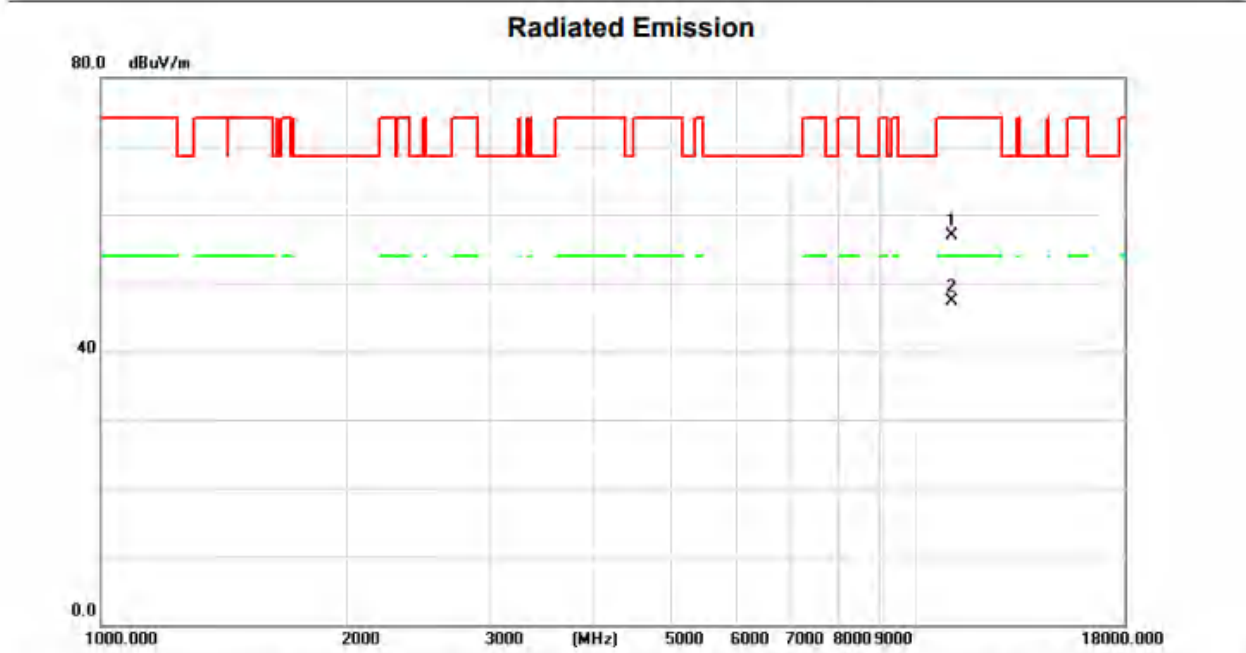

No.	Mk.	Freq.	Reading Level	Correct Factor	Measurement	Limit	Over	Antenna Height	Table Degree	
		MHz	dBuV	dB/m	dBuV/m	dBuV/m	dB	cm	degree	Comment
1		11020.000	46.66	10.25	56.91	74.00	-17.09			peak
2	*	11020.000	36.96	10.25	47.21	54.00	-6.79			AVG

REMARKS:

- (1) Measurement Value = Reading Level + Correct Factor.
- (2) Margin Level = Measurement Value - Limit Value.

Test Mode	UNII-2C_TX AC(HT40) Mode 5550 MHz	Polarization	Vertical
-----------	-----------------------------------	--------------	----------

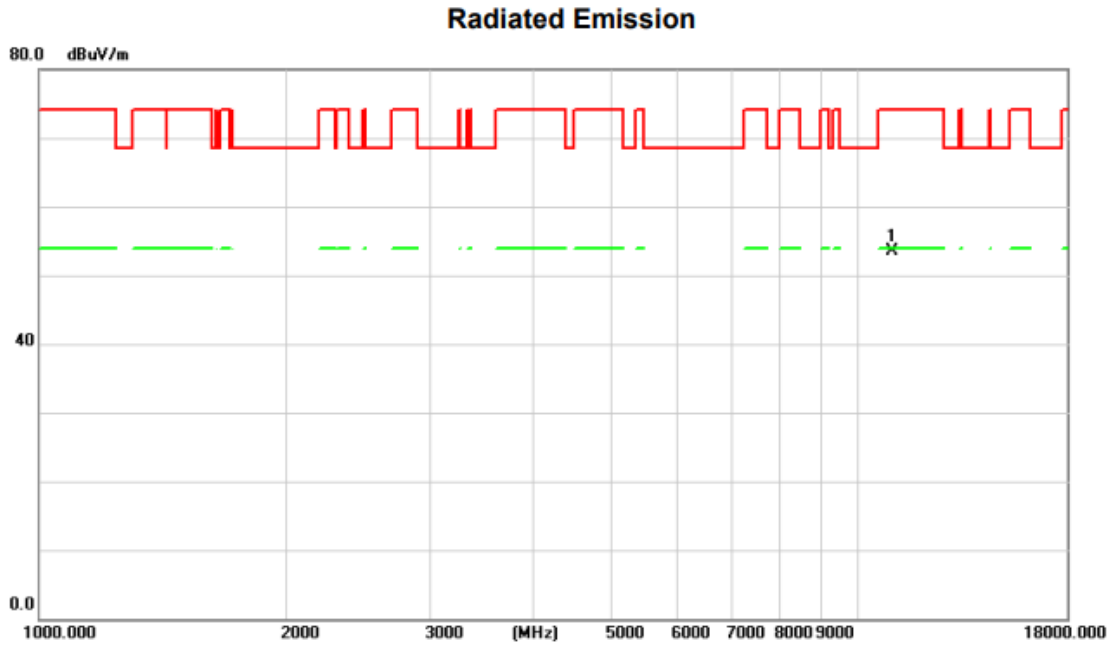

No.	Mk.	Freq.	Reading Level	Correct Factor	Measurement	Limit	Over	Antenna Height	Table Degree	Comment
		MHz	dBuV	dB/m	dBuV/m	dBuV/m	dB	cm	degree	
1	*	11100.000	43.13	10.29	53.42	74.00	-20.58	peak		

REMARKS:

- (1) Measurement Value = Reading Level + Correct Factor.
- (2) Margin Level = Measurement Value - Limit Value.

Test Mode	UNII-2C_TX AC(HT40) Mode 5550 MHz	Polarization	Horizontal
-----------	-----------------------------------	--------------	------------

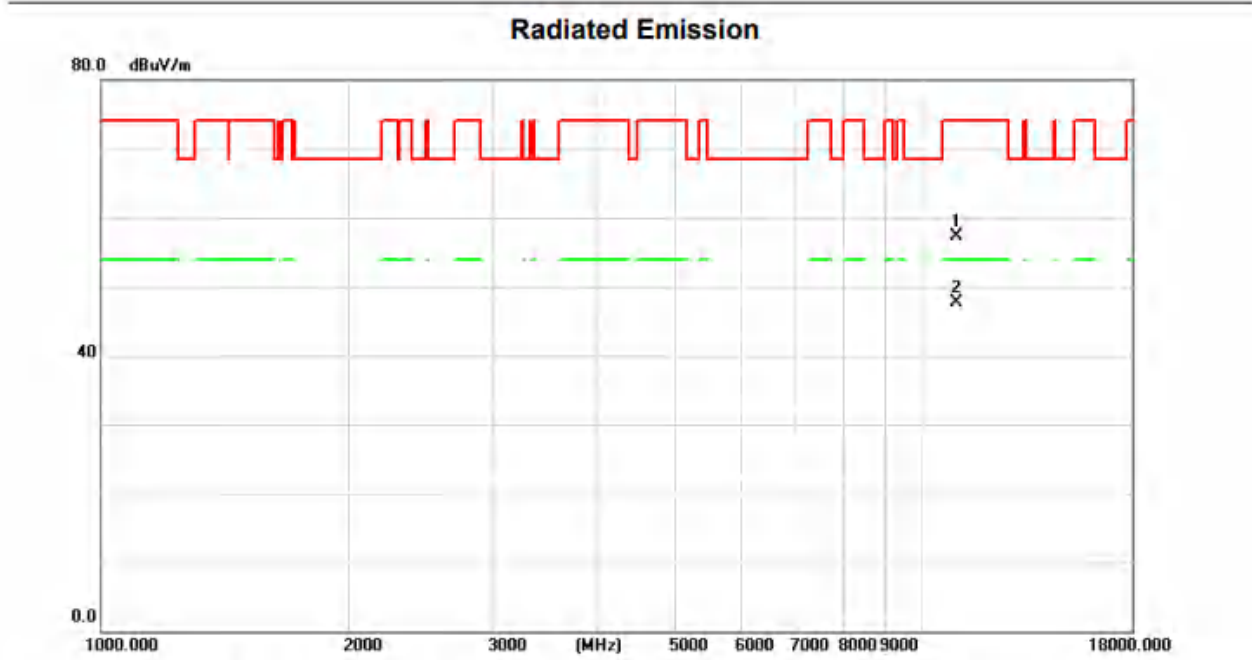

No.	Mk.	Freq.	Reading Level	Correct Factor	Measurement	Limit	Over	Antenna Height	Table Degree
		MHz	dBuV	dB/m	dBuV/m	dBuV/m	dB	cm	degree
1		11100.000	46.97	10.29	57.26	74.00	-16.74	peak	
2	*	11100.000	37.39	10.29	47.68	54.00	-6.32	AVG	

REMARKS:

- (1) Measurement Value = Reading Level + Correct Factor.
- (2) Margin Level = Measurement Value - Limit Value.

Test Mode	UNII-2C_TX AC(HT40) Mode 5670 MHz	Polarization	Vertical
-----------	-----------------------------------	--------------	----------

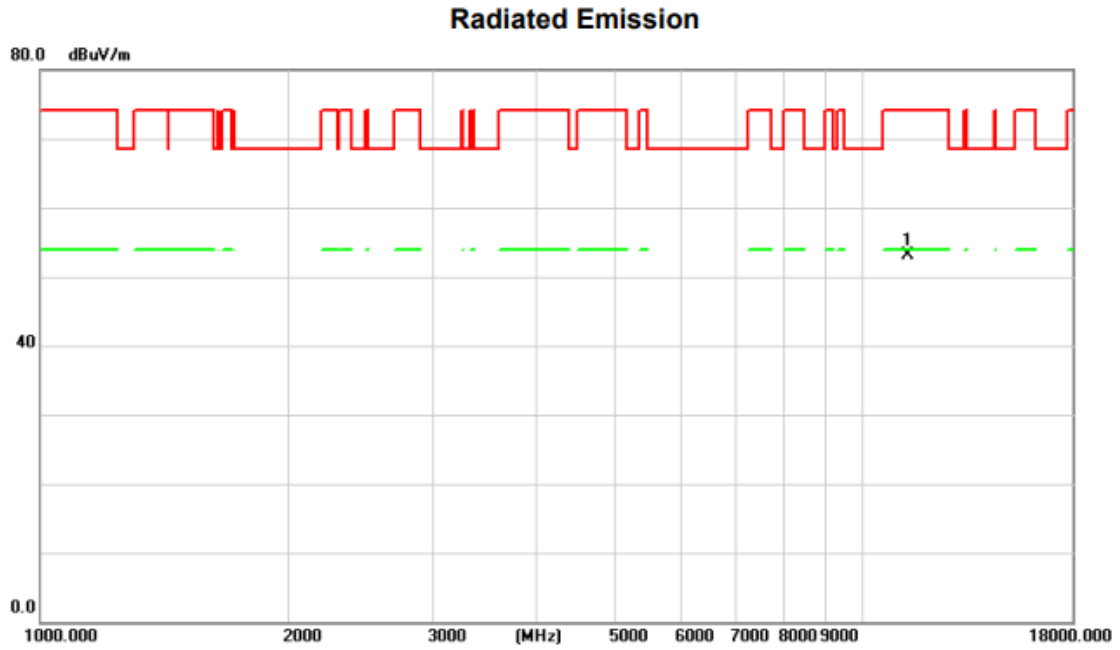

No.	Mk.	Freq.	Reading Level	Correct Factor	Measurement	Limit	Over	Antenna Height	Table Degree
		MHz	dBuV	dB/m	dBuV/m	dBuV/m	dB	Detector	cm
1	*	11340.000	43.43	9.63	53.06	74.00	-20.94	peak	

REMARKS:

- (1) Measurement Value = Reading Level + Correct Factor.
- (2) Margin Level = Measurement Value - Limit Value.

Test Mode	UNII-2C_TX AC(HT40) Mode 5670 MHz	Polarization	Horizontal
-----------	-----------------------------------	--------------	------------

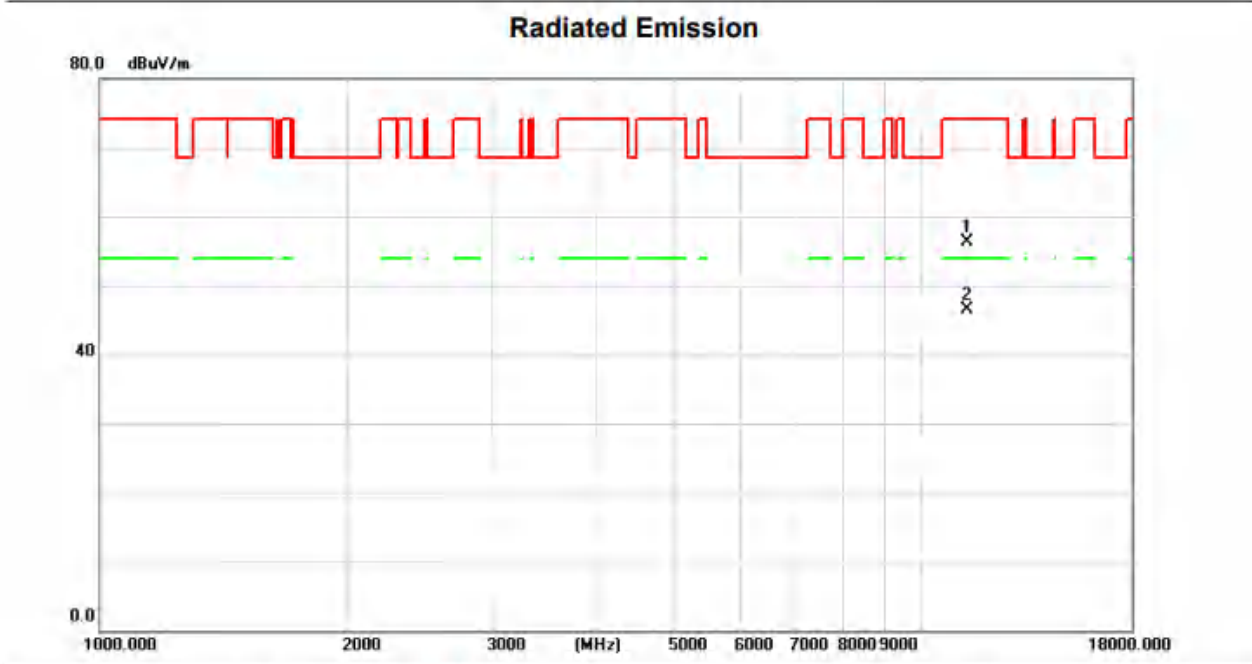

No.	Mk.	Freq.	Reading Level	Correct Factor	Measurement	Limit	Over	Antenna Height	Table Degree
		MHz	dBuV	dB/m	dBuV/m	dBuV/m	dB	cm	degree
1		11340.000	46.60	9.63	56.23	74.00	-17.77	peak	
2	*	11340.000	36.89	9.63	46.52	54.00	-7.48	AVG	

REMARKS:

- (1) Measurement Value = Reading Level + Correct Factor.
- (2) Margin Level = Measurement Value - Limit Value.

Test Mode	UNII-2C_TX AC(VHT80) Mode 5530 MHz	Polarization	Vertical
-----------	------------------------------------	--------------	----------

Radiated Emission

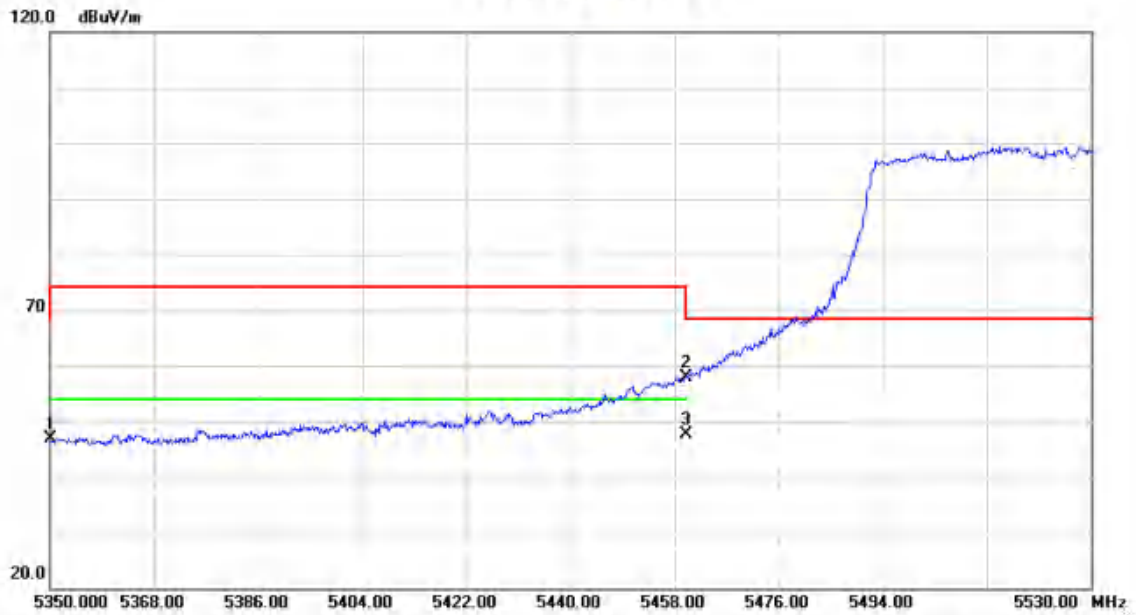

No.	Mk.	Freq.	Reading Level	Correct Factor	Measurement	Limit	Over	Antenna Height	Table Degree	
		MHz	dBuV	dB/m	dBuV/m	dBuV/m	dB	cm	degree	Comment
1		5350.000	49.68	-2.78	46.90	68.20	-21.30			peak
2		5460.000	60.60	-2.67	57.93	68.20	-10.27			peak
3	*	5460.000	50.19	-2.67	47.52	54.00	-6.48			AVG

REMARKS:

- (1) Measurement Value = Reading Level + Correct Factor.
- (2) Margin Level = Measurement Value - Limit Value.

Test Mode	UNII-2C_TX AC(VHT80) Mode 5530 MHz	Polarization	Vertical
-----------	------------------------------------	--------------	----------

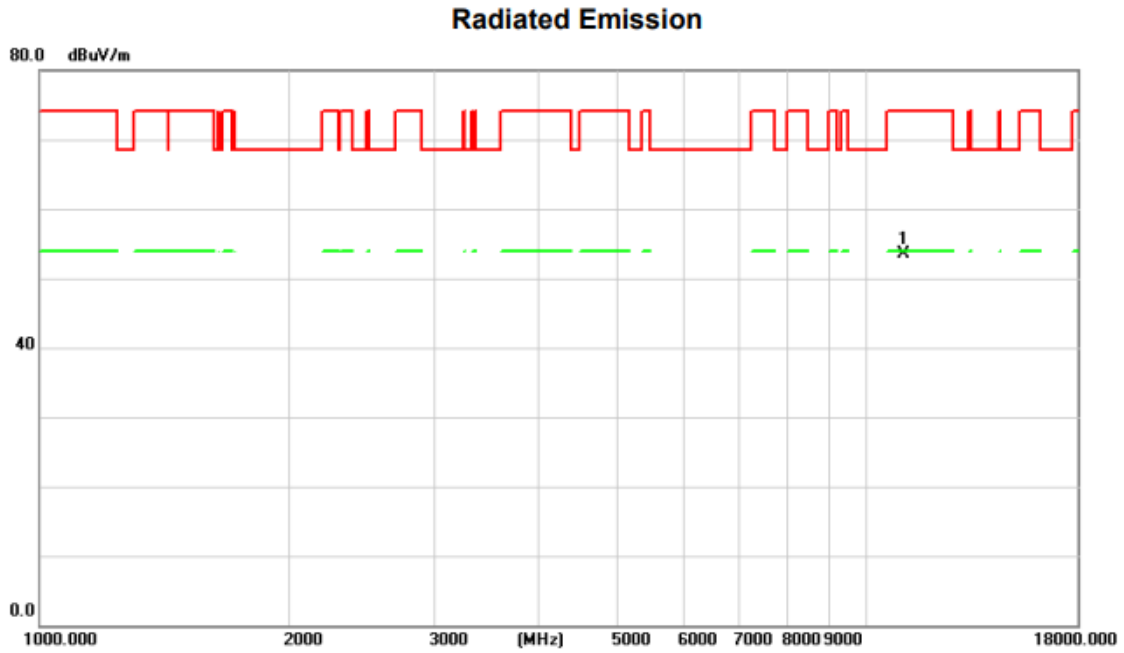

No.	Mk.	Freq.	Reading Level	Correct Factor	Measurement	Limit	Over	Antenna Height	Table Degree	
		MHz	dBuV	dB/m	dBuV/m	dBuV/m	dB	cm	degree	Comment
1	*	11060.000	43.28	10.17	53.45	74.00	-20.55	peak		

REMARKS:

- (1) Measurement Value = Reading Level + Correct Factor.
- (2) Margin Level = Measurement Value - Limit Value.

Test Mode	UNII-2C_TX AC(VHT80) Mode 5530 MHz	Polarization	Horizontal
-----------	------------------------------------	--------------	------------

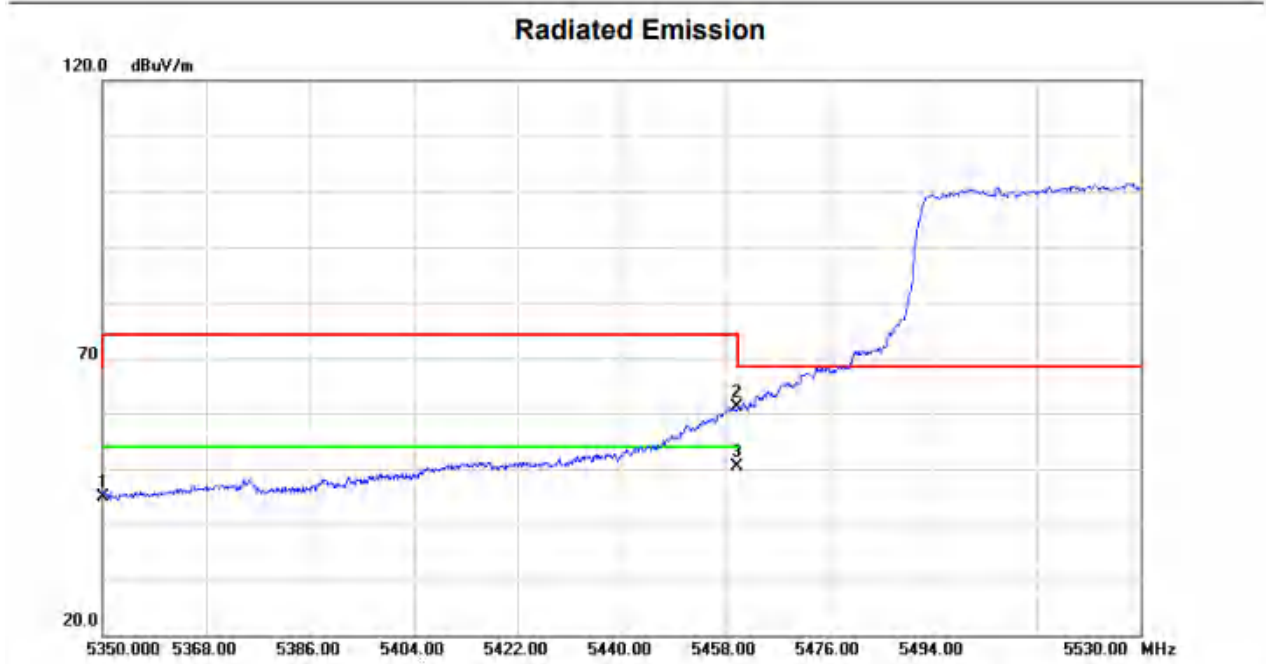

No.	Mk.	Freq.	Reading Level	Correct Factor	Measurement	Limit	Over	Antenna Height	Table Degree	
		MHz	dBuV	dB/m	dBuV/m	dBuV/m	dB	cm	degree	Comment
1		5350.000	47.54	-2.78	44.76	68.20	-23.44			peak
2		5460.000	63.71	-2.67	61.04	68.20	-7.16			peak
3	*	5460.000	52.93	-2.67	50.26	54.00	-3.74			AVG

REMARKS:

- (1) Measurement Value = Reading Level + Correct Factor.
- (2) Margin Level = Measurement Value - Limit Value.

Test Mode	UNII-2C_TX AC(VHT80) Mode 5530 MHz	Polarization	Horizontal
-----------	------------------------------------	--------------	------------

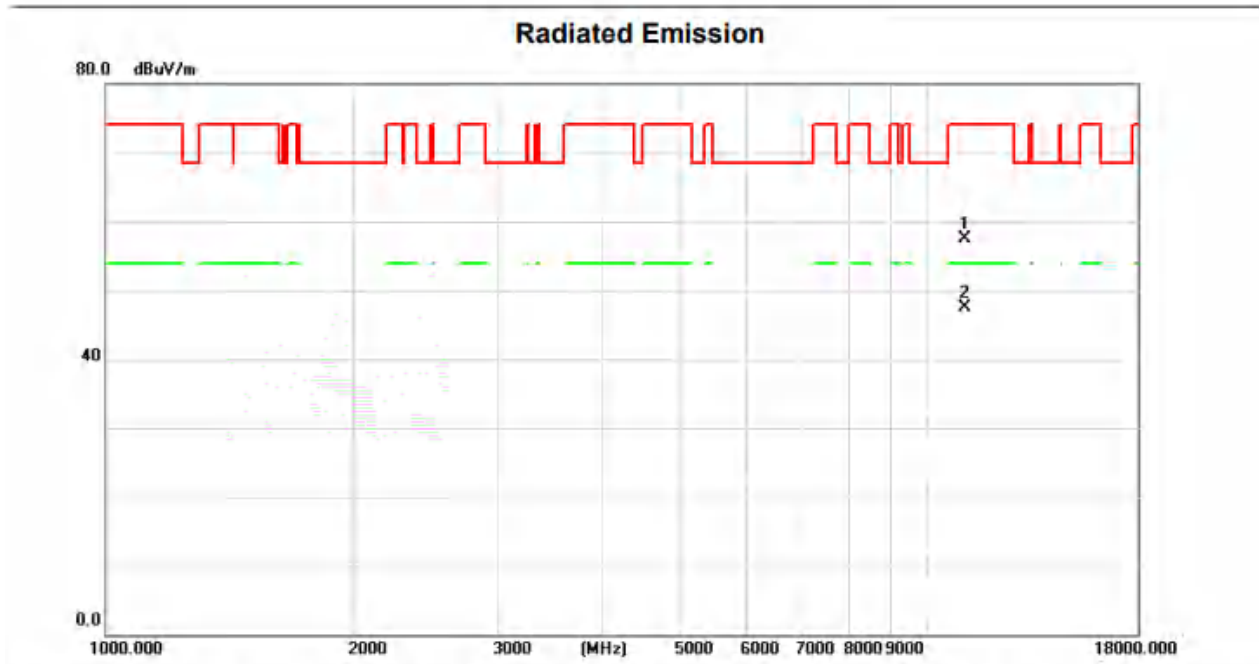

No.	Mk.	Freq.	Reading Level	Correct Factor	Measurement	Limit	Over	Antenna Height	Table Degree
		MHz	dBuV	dB/m	dBuV/m	dBuV/m	dB	cm	degree
1		11060.000	47.32	10.17	57.49	74.00	-16.51	peak	
2	*	11060.000	37.37	10.17	47.54	54.00	-6.46	AVG	

REMARKS:

- (1) Measurement Value = Reading Level + Correct Factor.
- (2) Margin Level = Measurement Value - Limit Value.

Test Mode	UNII-2C_TX AC(VHT80) Mode 5610 MHz	Polarization	Vertical
-----------	------------------------------------	--------------	----------

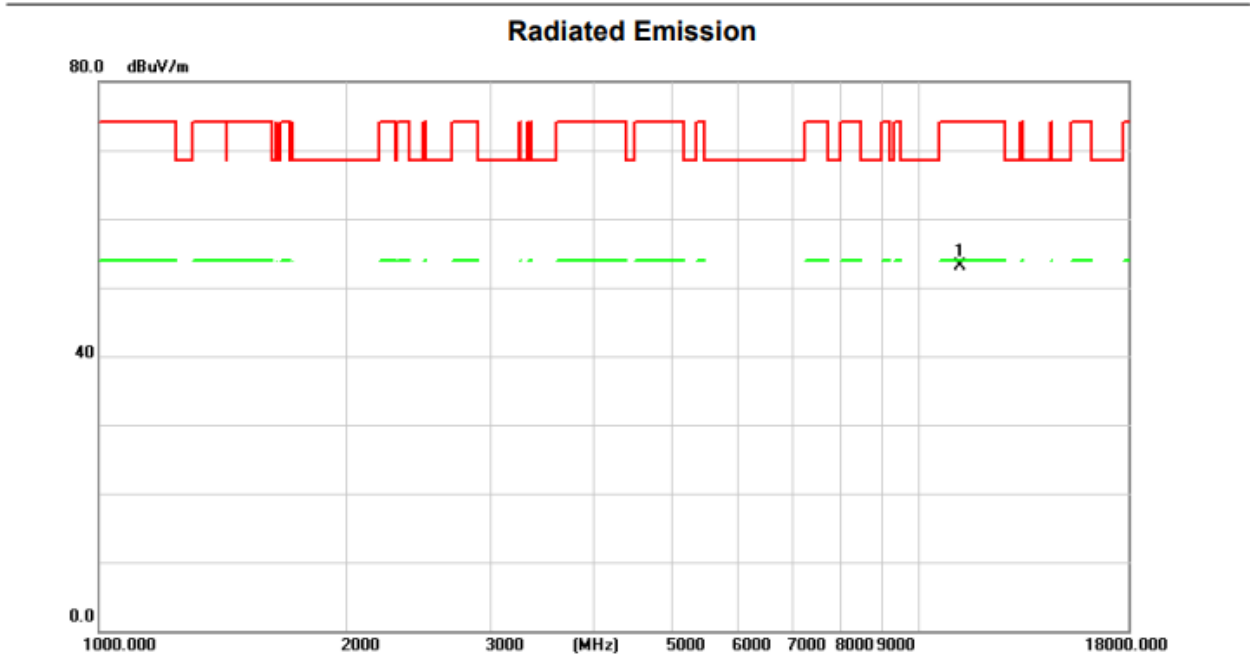

No.	Mk.	Freq.	Reading Level	Correct Factor	Measurement	Limit	Over	Antenna Height	Table Degree	
		MHz	dBuV	dB/m	dBuV/m	dBuV/m	dB	cm	degree	Comment
1	*	11220.000	43.26	9.86	53.12	74.00	-20.88	peak		

REMARKS:

- (1) Measurement Value = Reading Level + Correct Factor.
- (2) Margin Level = Measurement Value - Limit Value.

Test Mode	UNII-2C_TX AC(VHT80) Mode 5610 MHz	Polarization	Horizontal
-----------	------------------------------------	--------------	------------

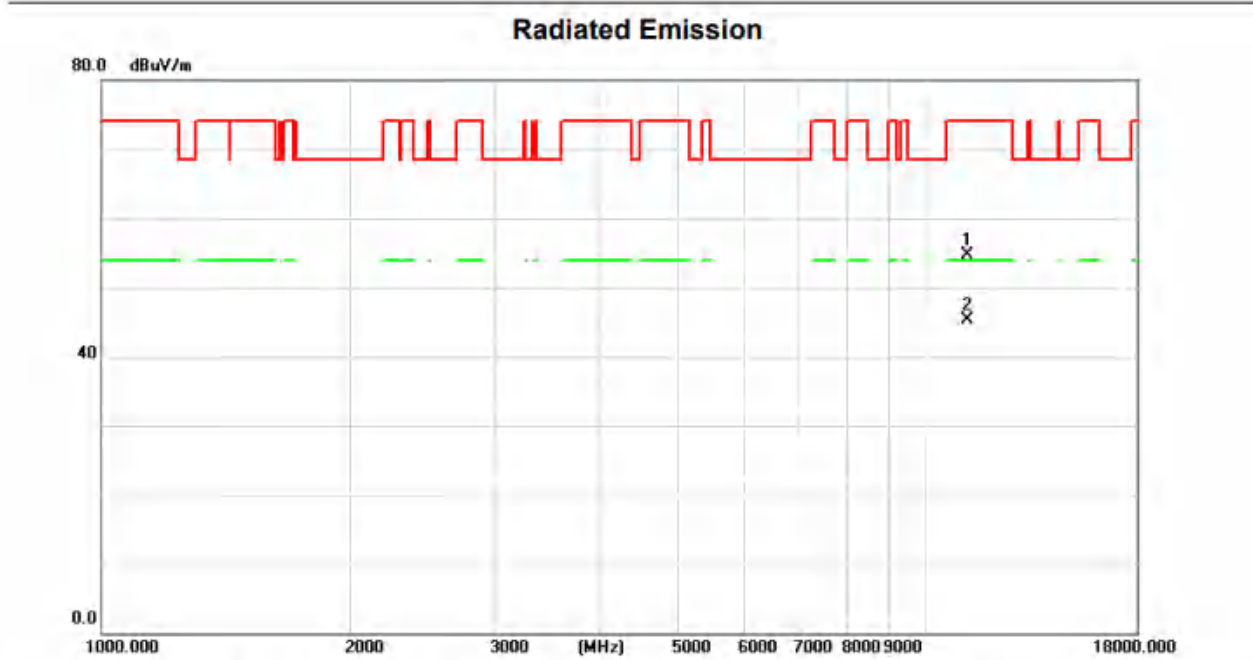

No.	Mk.	Freq.	Reading Level	Correct Factor	Measurement	Limit	Over	Antenna Height	Table Degree	
		MHz	dBuV	dB/m	dBuV/m	dBuV/m	dB	cm	degree	Comment
1		11220.000	44.93	9.86	54.79	74.00	-19.21			peak
2	*	11220.000	35.46	9.86	45.32	54.00	-8.68			AVG

REMARKS:

- (1) Measurement Value = Reading Level + Correct Factor.
- (2) Margin Level = Measurement Value - Limit Value.

Test Mode	UNII-3_TX A Mode 5745 MHz	Polarization	Vertical
-----------	---------------------------	--------------	----------

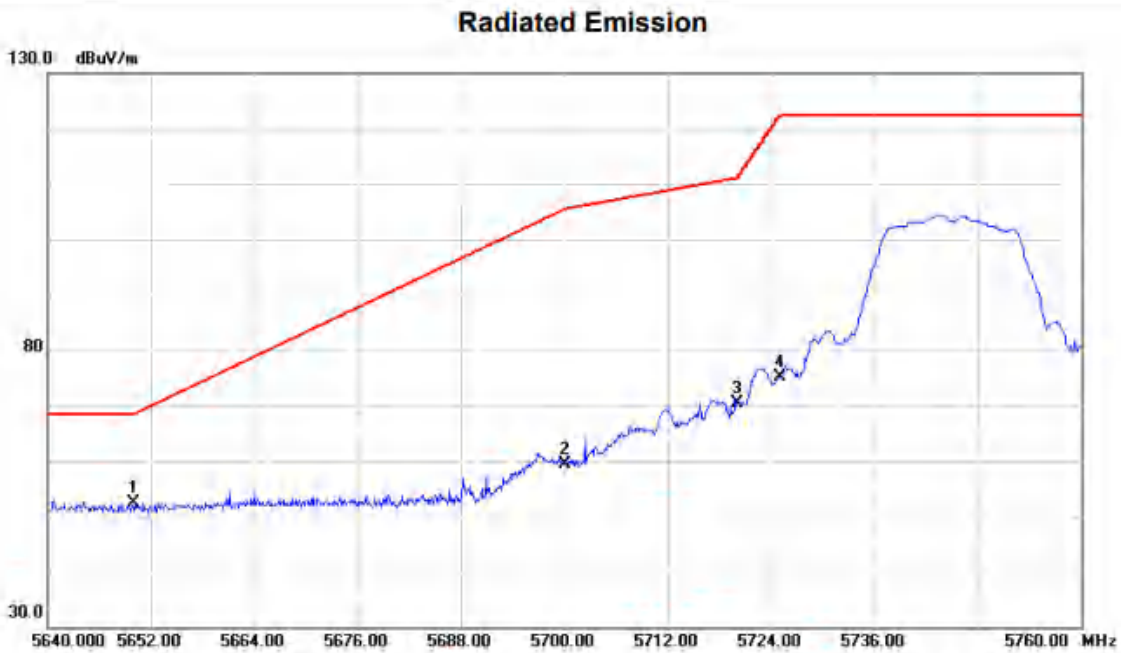

No.	Mk.	Freq. MHz	Reading Level dBuV	Correct Factor dB/m	Measure- ment dBuV/m	Limit dBuV/m	Over dB	Detector	Antenna Height cm	Table Degree degree	Comment
1	*	5650.000	54.48	-2.09	52.39	68.20	-15.81	peak			
2		5700.000	61.62	-2.19	59.43	105.20	-45.77	peak			
3		5720.000	72.71	-2.23	70.48	110.80	-40.32	peak			
4		5725.000	77.47	-2.24	75.23	122.20	-46.97	peak			

REMARKS:

- (1) Measurement Value = Reading Level + Correct Factor.
- (2) Margin Level = Measurement Value - Limit Value.

Test Mode	UNII-3_TX A Mode 5745 MHz	Polarization	Vertical
-----------	---------------------------	--------------	----------

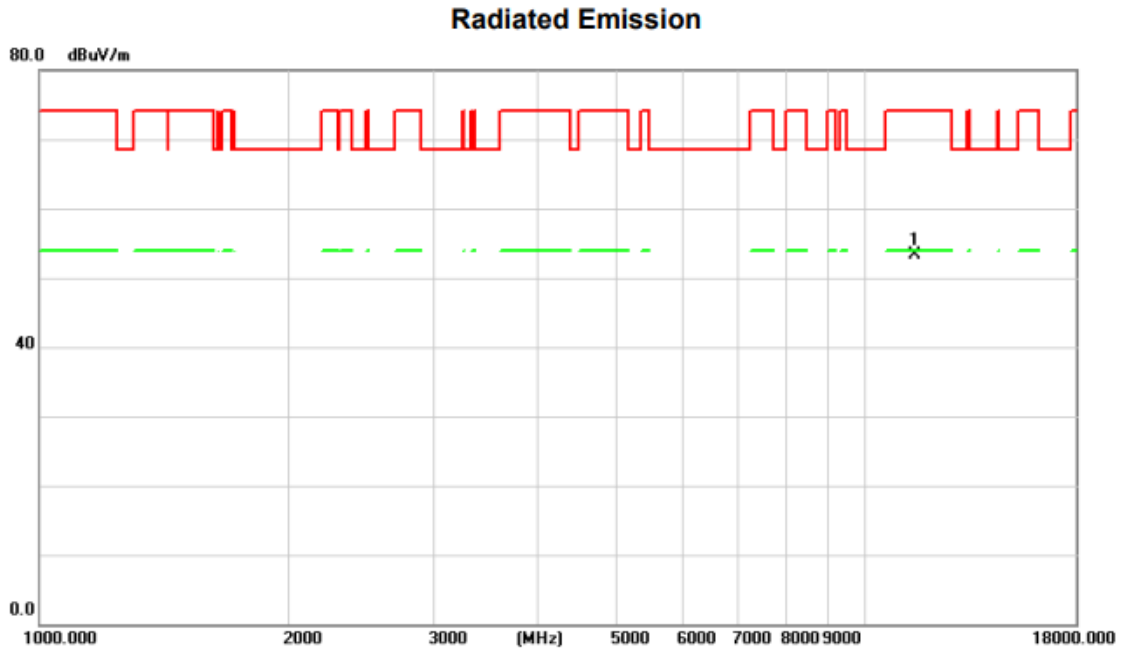

No.	Mk.	Freq.	Reading Level	Correct Factor	Measurement	Limit	Over	Antenna Height	Table Degree
		MHz	dBuV	dB/m	dBuV/m	dBuV/m	dB	cm	degree
1	*	11490.000	43.43	9.78	53.21	74.00	-20.79	peak	

REMARKS:

- (1) Measurement Value = Reading Level + Correct Factor.
- (2) Margin Level = Measurement Value - Limit Value.

Test Mode	UNII-3_TX A Mode 5745 MHz	Polarization	Horizontal
-----------	---------------------------	--------------	------------

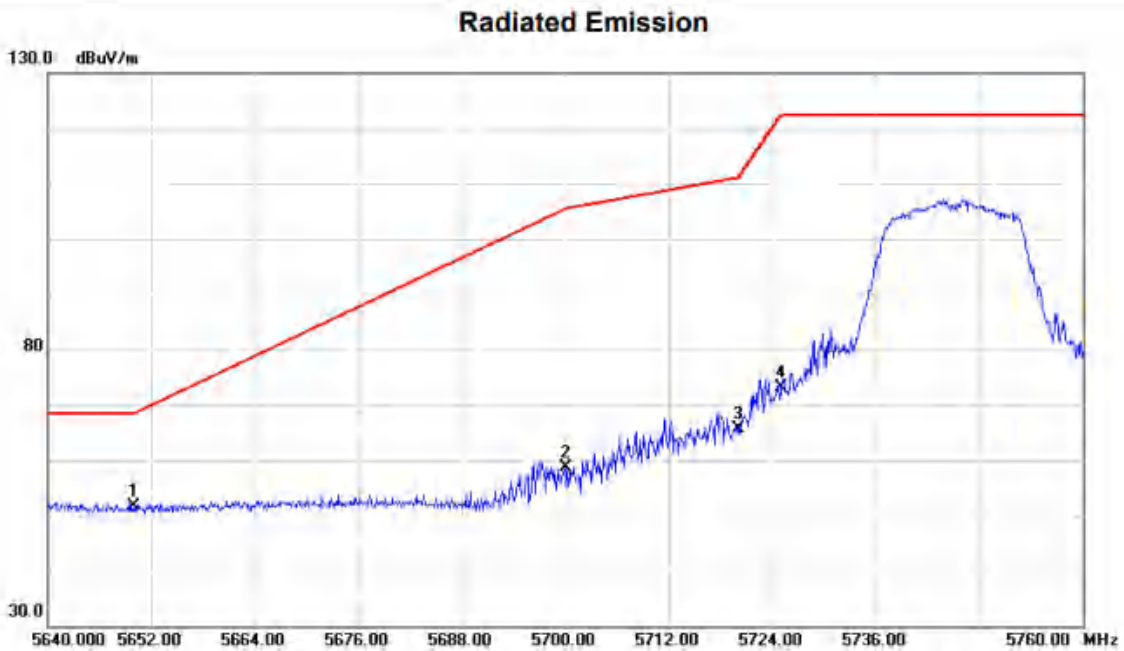

No.	Mk.	Freq. MHz	Reading Level dBuV	Correct Factor dB/m	Measure- ment dBuV/m	Limit dBuV/m	Over dB	Detector	Antenna Height cm	Table Degree degree	Comment
1	*	5650.000	53.64	-2.09	51.55	68.20	-16.65	peak			
2		5700.000	60.88	-2.19	58.69	105.20	-46.51	peak			
3		5720.000	67.80	-2.23	65.57	110.80	-45.23	peak			
4		5725.000	75.30	-2.24	73.06	122.20	-49.14	peak			

REMARKS:

- (1) Measurement Value = Reading Level + Correct Factor.
- (2) Margin Level = Measurement Value - Limit Value.

Test Mode	UNII-3_TX A Mode 5745 MHz	Polarization	Horizontal
-----------	---------------------------	--------------	------------

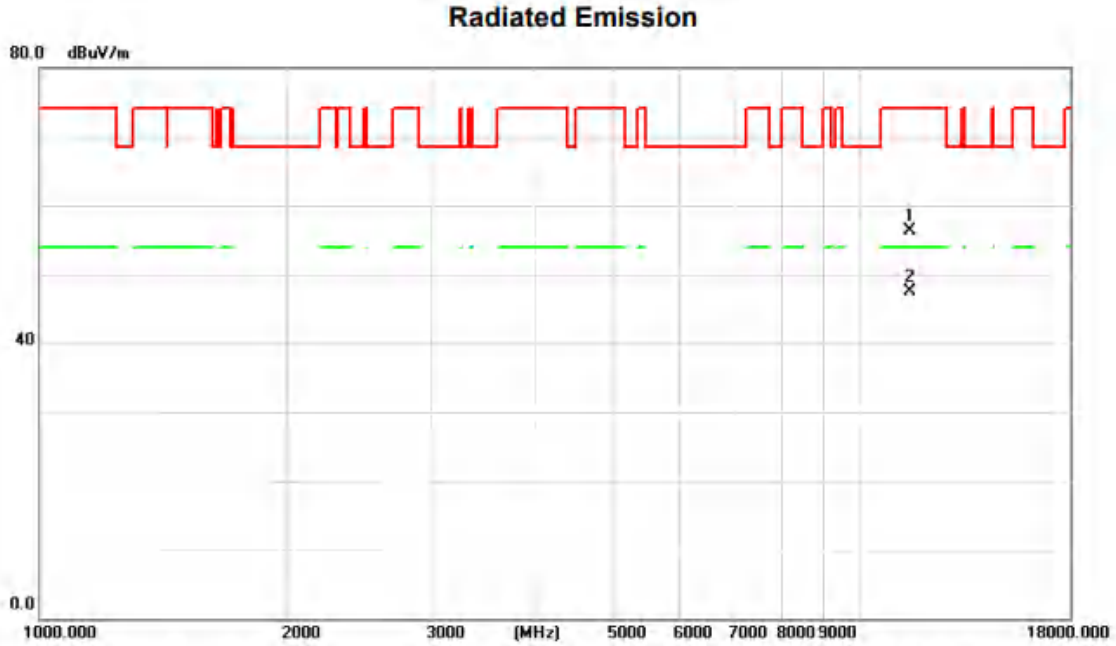

No.	Mk.	Freq.	Reading Level	Correct Factor	Measurement	Limit	Over	Antenna Height	Table Degree	
		MHz	dBuV	dB/m	dBuV/m	dBuV/m	dB	cm	degree	Comment
1		11490.000	46.54	9.78	56.32	74.00	-17.68			peak
2	*	11490.000	37.73	9.78	47.51	54.00	-6.49			AVG

REMARKS:

- (1) Measurement Value = Reading Level + Correct Factor.
- (2) Margin Level = Measurement Value - Limit Value.

Test Mode	UNII-3_TX A Mode 5785 MHz	Polarization	Vertical
-----------	---------------------------	--------------	----------

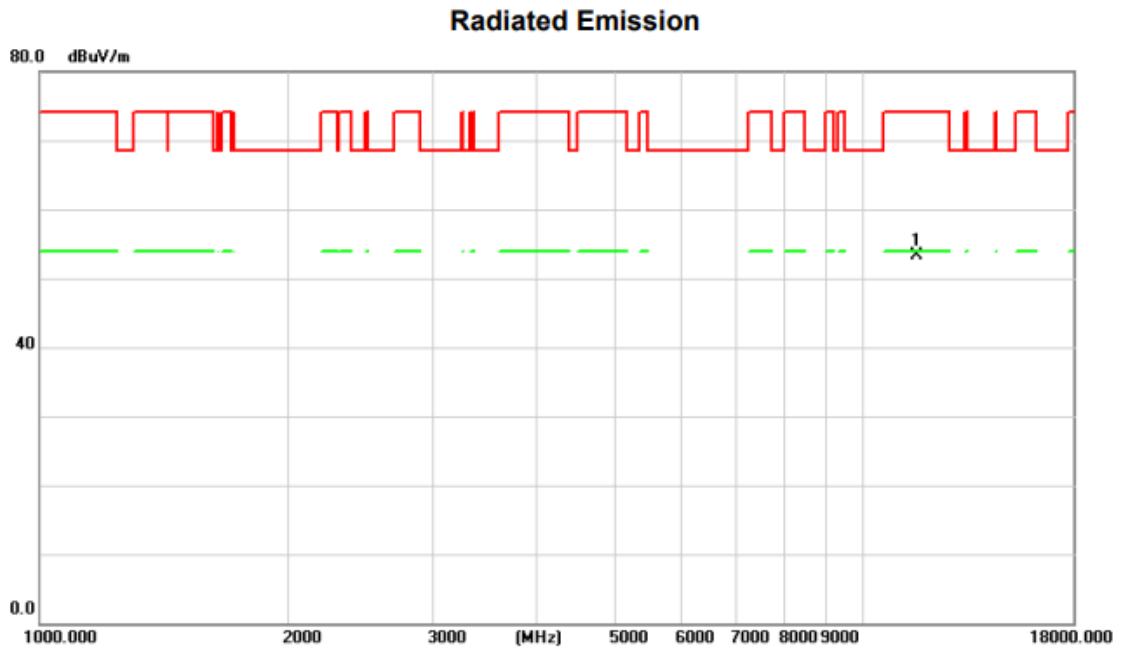

No.	Mk.	Freq.	Reading Level	Correct Factor	Measurement	Limit	Over	Antenna Height	Table Degree
		MHz	dBuV	dB/m	dBuV/m	dBuV/m	dB	cm	degree
1	*	11570.000	43.37	10.01	53.38	74.00	-20.62	peak	

REMARKS:

- (1) Measurement Value = Reading Level + Correct Factor.
- (2) Margin Level = Measurement Value - Limit Value.

Test Mode	UNII-3_TX A Mode 5785 MHz	Polarization	Horizontal
-----------	---------------------------	--------------	------------

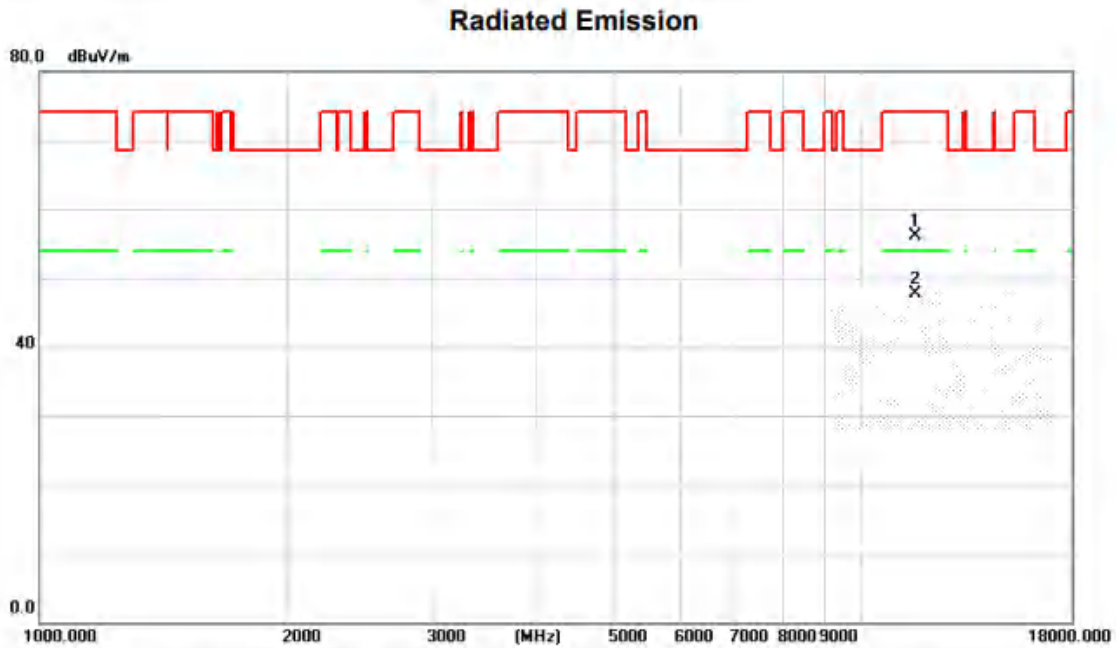

No.	Mk.	Freq.	Reading Level	Correct Factor	Measurement	Limit	Over	Antenna Height	Table Degree
		MHz	dBuV	dB/m	dBuV/m	dBuV/m	dB	cm	degree
1		11570.000	46.08	10.01	56.09	74.00	-17.91	peak	
2	*	11570.000	37.66	10.01	47.67	54.00	-6.33	AVG	

REMARKS:

- (1) Measurement Value = Reading Level + Correct Factor.
- (2) Margin Level = Measurement Value - Limit Value.

Test Mode	UNII-3_TX A Mode 5825 MHz	Polarization	Vertical
-----------	---------------------------	--------------	----------

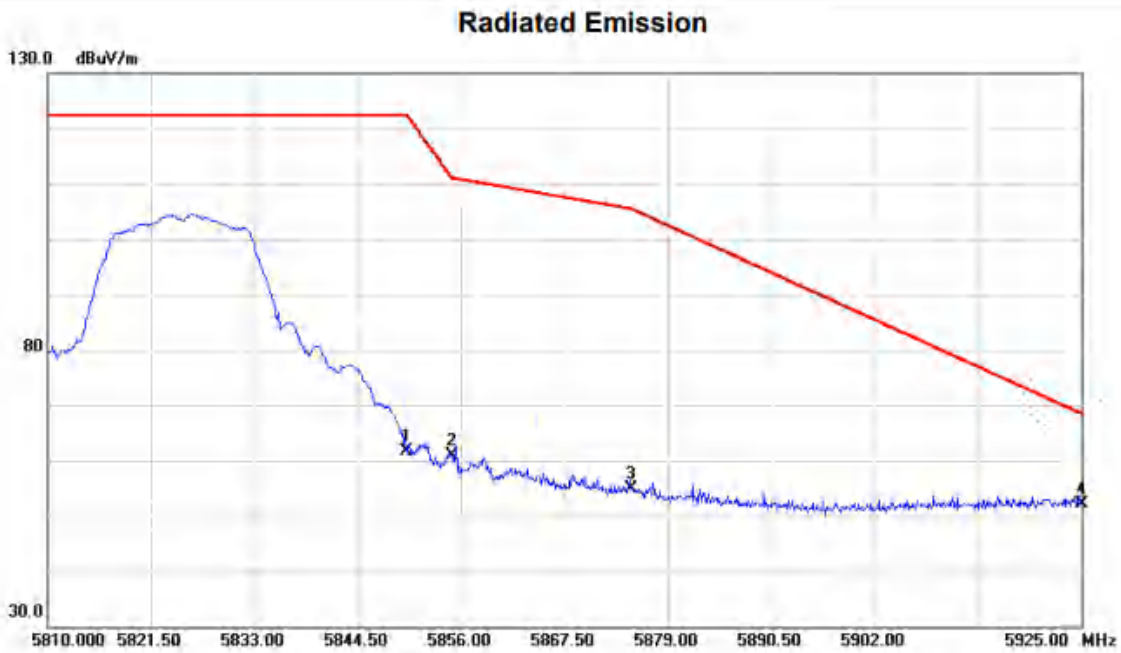

No.	Mk.	Freq.	Reading Level	Correct Factor	Measurement	Limit	Over	Antenna Height	Table Degree	
		MHz	dBuV	dB/m	dBuV/m	dBuV/m	dB	cm	degree	Comment
1		5850.000	63.73	-2.07	61.66	122.20	-60.54			peak
2		5855.000	62.84	-2.04	60.80	110.80	-50.00			peak
3		5875.000	56.76	-1.91	54.85	105.20	-50.35			peak
4	*	5925.000	53.64	-1.59	52.05	68.20	-16.15			peak

REMARKS:

- (1) Measurement Value = Reading Level + Correct Factor.
- (2) Margin Level = Measurement Value - Limit Value.

Test Mode	UNII-3_TX A Mode 5825 MHz	Polarization	Vertical
-----------	---------------------------	--------------	----------

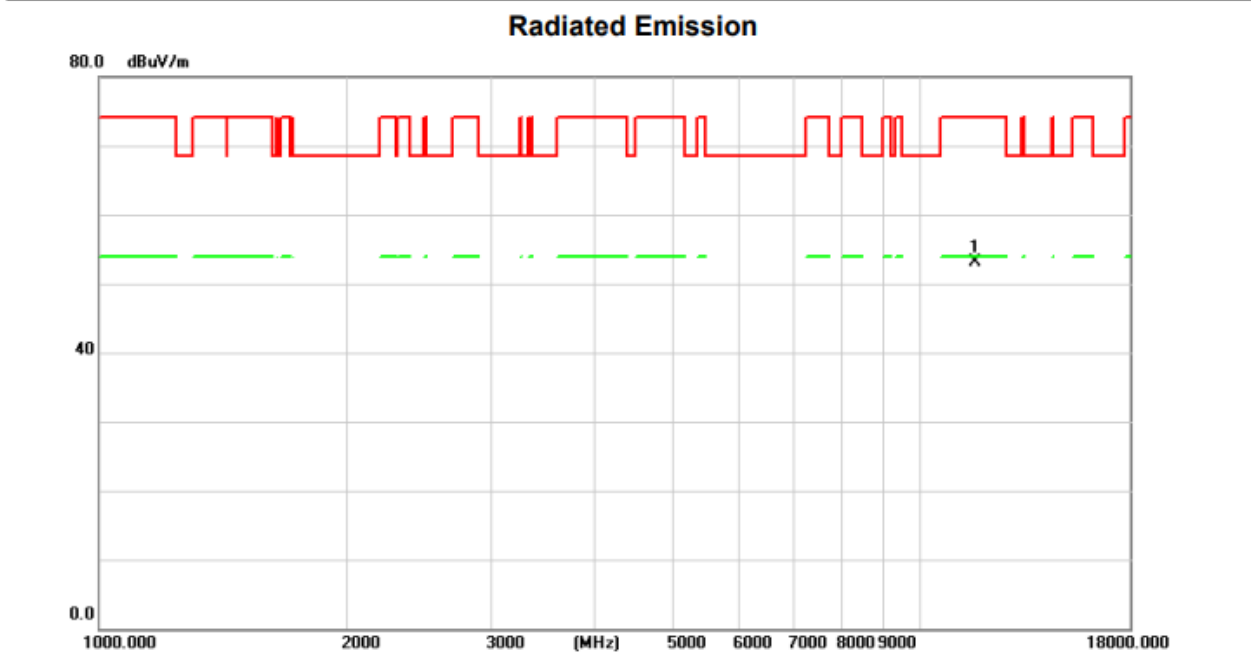

No.	Mk.	Freq.	Reading Level	Correct Factor	Measurement	Limit	Over	Antenna Height	Table Degree
		MHz	dBuV	dB/m	dBuV/m	dBuV/m	dB	cm	degree
1	*	11650.000	42.90	10.24	53.14	74.00	-20.86	peak	

REMARKS:

- (1) Measurement Value = Reading Level + Correct Factor.
- (2) Margin Level = Measurement Value - Limit Value.

Test Mode	UNII-3_TX A Mode 5825 MHz	Polarization	Horizontal
-----------	---------------------------	--------------	------------

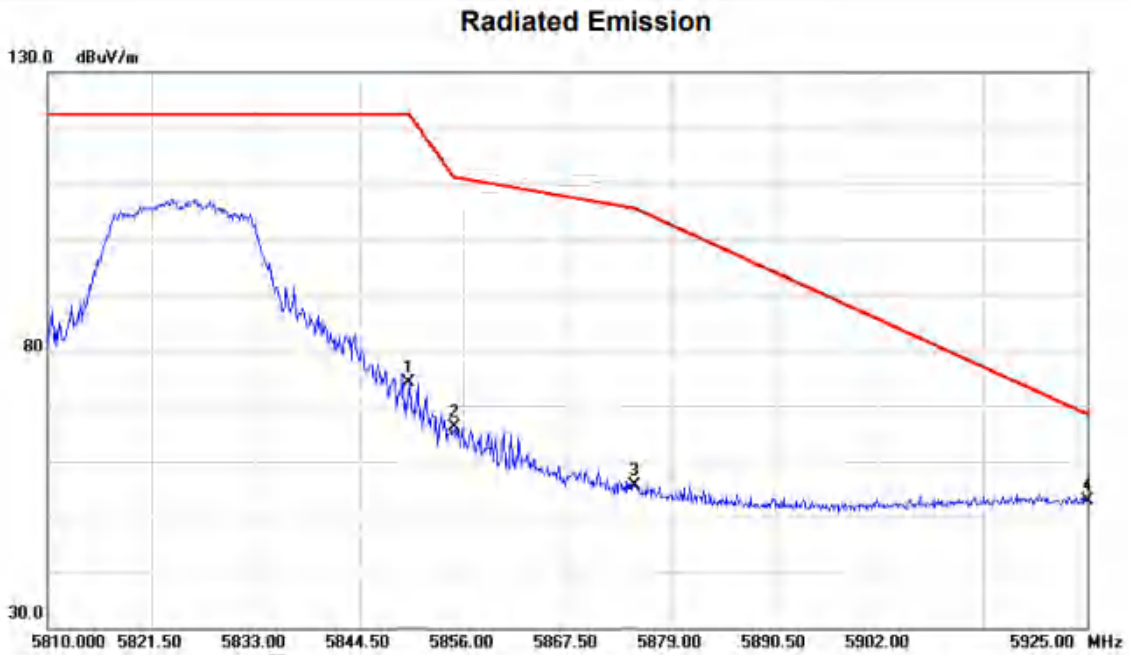

No.	Mk.	Freq.	Reading Level	Correct Factor	Measurement	Limit	Over	Antenna Height	Table Degree	
		MHz	dBuV	dB/m	dBuV/m	dBuV/m	dB	cm	degree	Comment
1		5850.000	76.15	-2.07	74.08	122.20	-48.12			peak
2		5855.000	68.26	-2.04	66.22	110.80	-44.58			peak
3		5875.000	57.42	-1.91	55.51	105.20	-49.69			peak
4	*	5925.000	54.43	-1.59	52.84	68.20	-15.36			peak

REMARKS:

- (1) Measurement Value = Reading Level + Correct Factor.
- (2) Margin Level = Measurement Value - Limit Value.

Test Mode	UNII-3_TX A Mode 5825 MHz	Polarization	Horizontal
-----------	---------------------------	--------------	------------

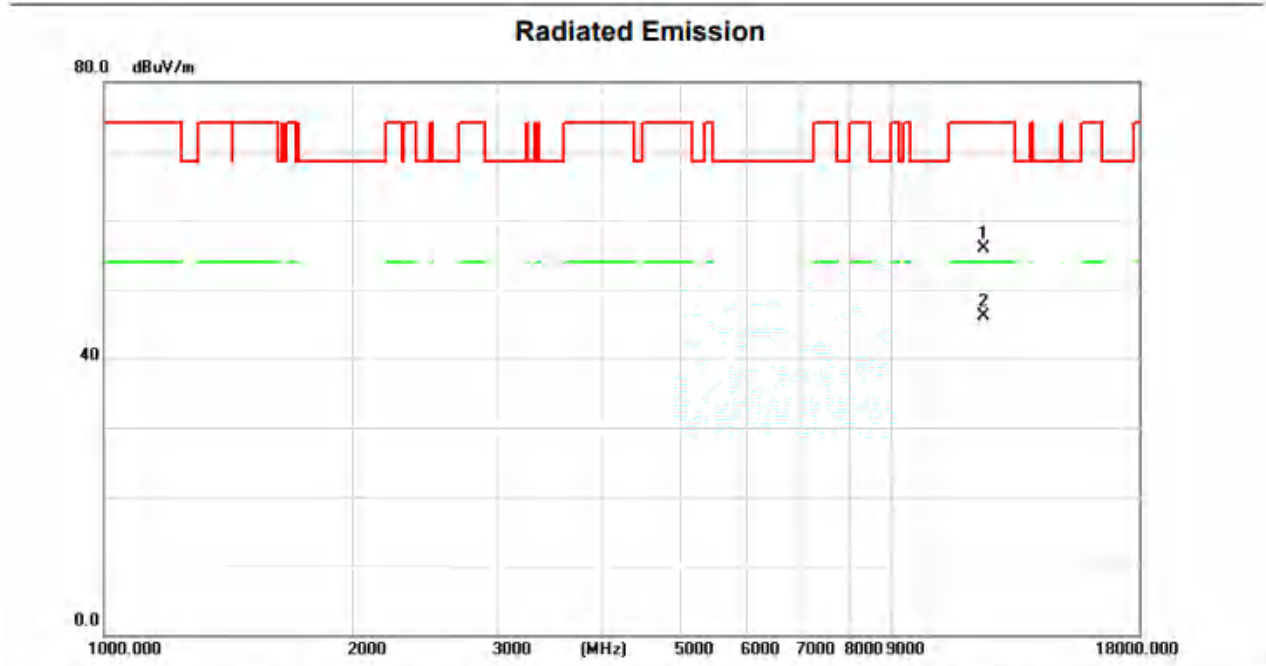

No.	Mk.	Freq.	Reading Level	Correct Factor	Measurement	Limit	Over	Antenna Height	Table Degree
		MHz	dBuV	dB/m	dBuV/m	dBuV/m	dB	cm	degree
1		11650.000	45.64	10.24	55.88	74.00	-18.12	peak	
2 *		11650.000	35.79	10.24	46.03	54.00	-7.97	AVG	

REMARKS:

- (1) Measurement Value = Reading Level + Correct Factor.
- (2) Margin Level = Measurement Value - Limit Value.

Test Mode	UNII-3_TX N(HT20) Mode 5745 MHz	Polarization	Vertical
-----------	---------------------------------	--------------	----------

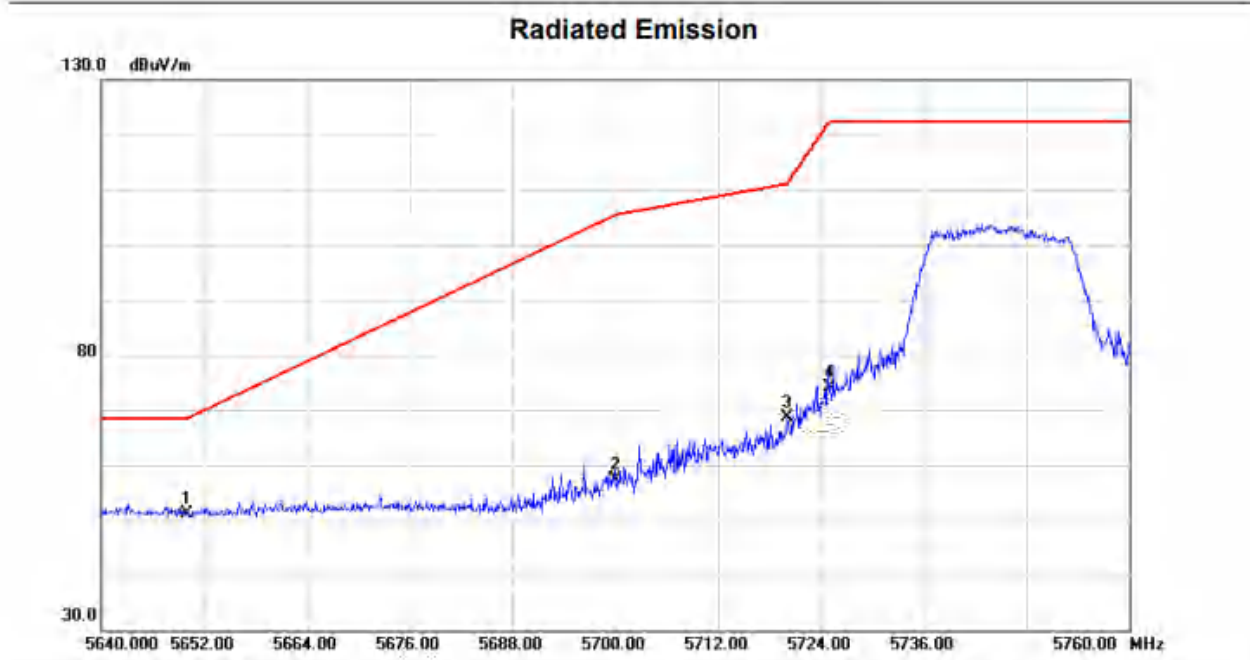

No.	Mk.	Freq.	Reading Level	Correct Factor	Measurement	Limit	Over	Antenna Height	Table Degree
		MHz	dBuV	dB/m	dBuV/m	dBuV/m	dB	cm	degree
1	*	5650.000	53.22	-2.09	51.13	68.20	-17.07	peak	
2		5700.000	59.50	-2.19	57.31	105.20	-47.89	peak	
3		5720.000	70.85	-2.23	68.62	110.80	-42.18	peak	
4		5725.000	76.37	-2.24	74.13	122.20	-48.07	peak	

REMARKS:

- (1) Measurement Value = Reading Level + Correct Factor.
- (2) Margin Level = Measurement Value - Limit Value.

Test Mode	UNII-3_TX N(HT20) Mode 5745 MHz	Polarization	Vertical
-----------	---------------------------------	--------------	----------

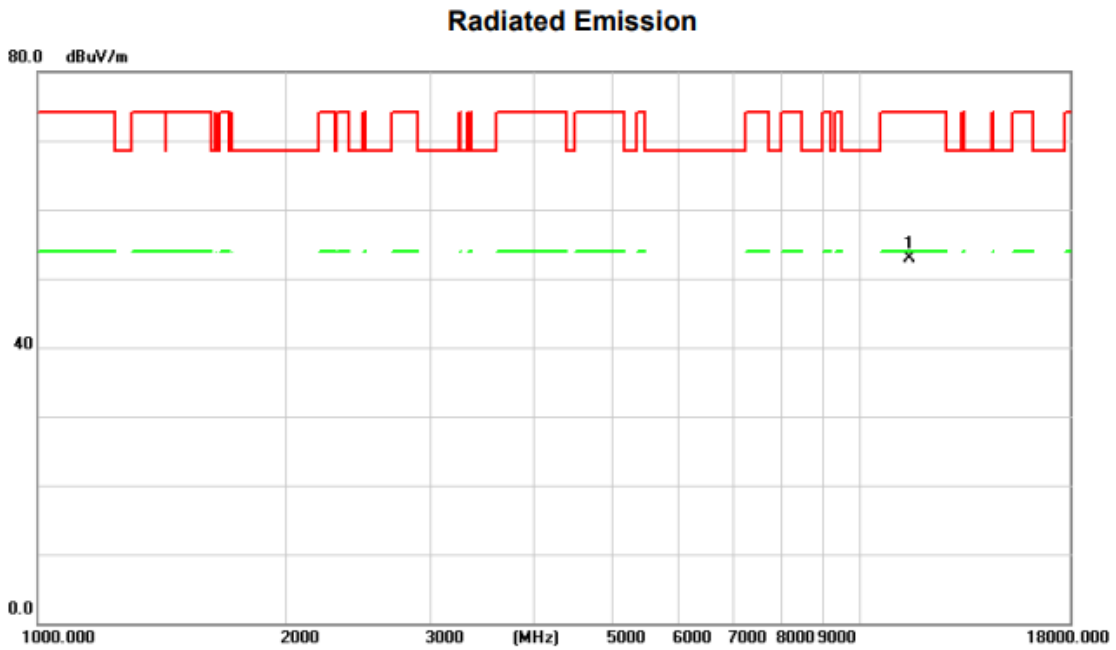

No.	Mk.	Freq.	Reading Level	Correct Factor	Measurement	Limit	Over	Antenna Height	Table Degree	
		MHz	dBuV	dB/m	dBuV/m	dBuV/m	dB	cm	degree	Comment
1	*	11490.000	43.20	9.78	52.98	74.00	-21.02	peak		

REMARKS:

- (1) Measurement Value = Reading Level + Correct Factor.
- (2) Margin Level = Measurement Value - Limit Value.

Test Mode	UNII-3_TX N(HT20) Mode 5745 MHz	Polarization	Horizontal
-----------	---------------------------------	--------------	------------

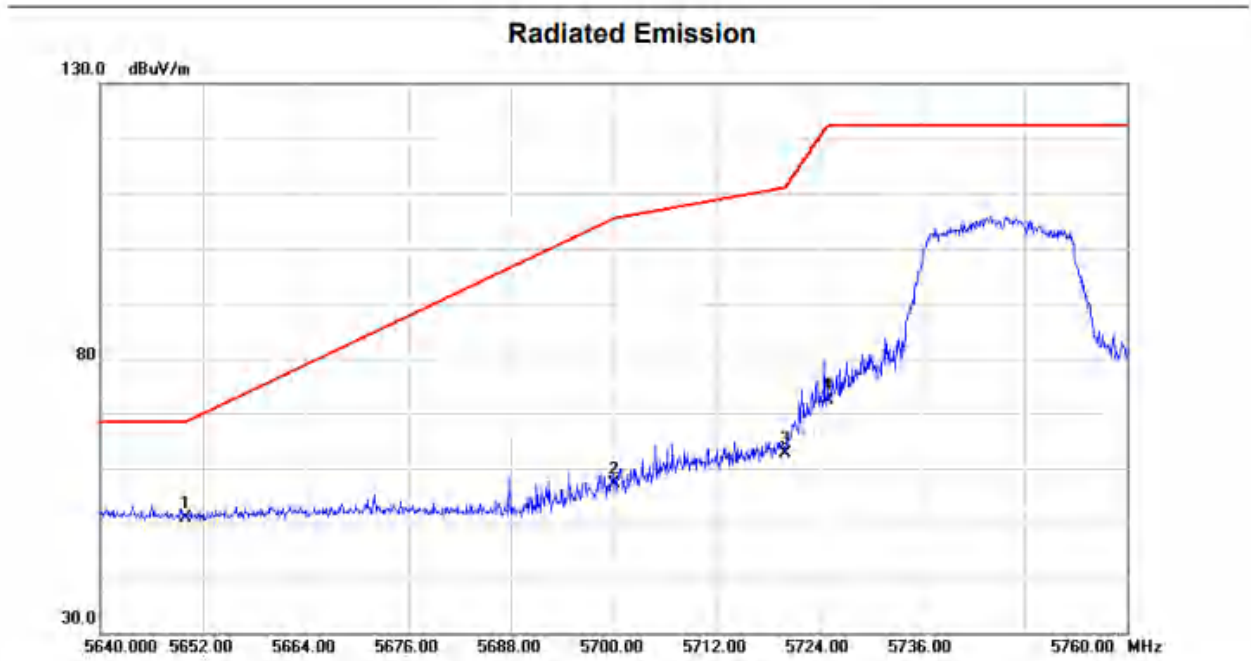

No.	Mk.	Freq.	Reading Level	Correct Factor	Measurement	Limit	Over	Antenna Height	Table Degree	
		MHz	dBuV	dB/m	dBuV/m	dBuV/m	dB	cm	degree	Comment
1	*	5650.000	53.06	-2.09	50.97	68.20	-17.23			peak
2		5700.000	59.21	-2.19	57.02	105.20	-48.18			peak
3		5720.000	64.93	-2.23	62.70	110.80	-48.10			peak
4		5725.000	74.60	-2.24	72.36	122.20	-49.84			peak

REMARKS:

- (1) Measurement Value = Reading Level + Correct Factor.
- (2) Margin Level = Measurement Value - Limit Value.