

<b>Product Name: Wi-Fi&amp;Bluetooth Module</b>	<b>Report No: FCC022022-06244RF5</b>
<b>Product Model: YL43456</b>	<b>Security Classification: Open</b>
<b>Version: V1.0</b>	<b>Total Page: 63</b>

# TIRT Testing Report



<b>Prepared By:</b>	<b>Checked By:</b>	<b>Approved By:</b>	A circular blue stamp with the text "TIRT Shenzhen" in the center and "Beijing TIRT Technology Service Co., Ltd" around the perimeter.
<b>Stone Tang</b>	<b>Randy Lv</b>	<b>Daniel Chen</b>	
<i>Stone Tang</i>	<i>Randy Lv</i>	<i>Daniel Chen</i>	

# FCC Radio Test Report

## FCC ID: T2C-YL43456

This report concerns: Original Grant

**Equipment** : Wi-Fi&Bluetooth Module  
**Brand Name** : Yealink  
**Test Model** : YL43456  
**Series Model** : N/A  
**Applicant** : YEALINK(XIAMEN) NETWORK TECHNOLOGY CO., LTD.  
**Address** : No. 666 Hu'an Rd, Huli District Xiamen City, Fujian, P.R. China  
**Manufacturer** : YEALINK(XIAMEN) NETWORK TECHNOLOGY CO., LTD.  
**Address** : No. 666 Hu'an Rd, Huli District Xiamen City, Fujian, P.R. China  
**Date of Receipt** : Dec. 06, 2022  
**Date of Test** : Dec. 06, 2022~ Jan. 03, 2023  
**Issued Date** : Jan. 28, 2023  
**Report Version** : V1.0  
**Test Sample** : Engineering Sample No.: 20221206021239  
**Standard(s)** : FCC CFR Title 47, Part 15, Subpart C  
FCC KDB 558074 D01 15.247 Meas Guidance v05r02  
ANSI C63.10-2013

- The test result referred exclusively to the presented test model /sample.
- Without written approval of TIRT Inc. the test report shall not reproduced except in full.

Lab: Beijing TIRT Technology Service Co.,Ltd Shenzhen

Add: 101, 3 # Factory Building, Gongjin Electronics Shatin Community, Kengzi Street, Pingshan

District, Shenzhen, China

TEL: +86-0755-27087573

<b>Table of Contents</b>	<b>Page</b>
<b>REPORT ISSUED HISTORY</b>	<b>6</b>
<b>1 . SUMMARY OF TEST RESULTS</b>	<b>7</b>
1.1 TEST FACILITY	8
1.2 MEASUREMENT UNCERTAINTY	8
1.3 TEST ENVIRONMENT CONDITIONS	9
<b>2 . GENERAL INFORMATION</b>	<b>10</b>
2.1 GENERAL DESCRIPTION OF EUT	10
2.2 DESCRIPTION OF TEST MODES	12
2.3 PARAMETERS OF TEST SOFTWARE	13
2.4 BLOCK DIAGRAM SHOWING THE CONFIGURATION OF SYSTEM TESTED	13
2.5 SUPPORT UNITS	13
<b>3 . AC POWER LINE CONDUCTED EMISSIONS</b>	<b>14</b>
3.1 LIMIT	14
3.2 TEST PROCEDURE	14
3.3 DEVIATION FROM TEST STANDARD	14
3.4 TEST SETUP	15
3.5 EUT OPERATING CONDITIONS	15
3.6 TEST RESULTS	15
<b>4 . RADIATED EMISSIONS</b>	<b>16</b>
4.1 LIMIT	16
4.2 TEST PROCEDURE	17
4.3 DEVIATION FROM TEST STANDARD	18
4.4 TEST SETUP	18
4.5 EUT OPERATING CONDITIONS	20
4.6 TEST RESULT - 9 KHZ TO 30 MHZ	20
4.7 TEST RESULT - 30 MHZ TO 1000 MHZ	20
4.8 TEST RESULT - ABOVE 1000 MHZ	20
<b>5 . BANDWIDTH</b>	<b>21</b>
5.1 LIMIT	21
5.2 TEST PROCEDURE	21
5.3 DEVIATION FROM STANDARD	21
5.4 TEST SETUP	21

<b>Table of Contents</b>	<b>Page</b>
5.5 EUT OPERATION CONDITIONS	21
5.6 TEST RESULTS	21
<b>6 . MAXIMUM OUTPUT POWER</b>	<b>22</b>
6.1 LIMIT	22
6.2 TEST PROCEDURE	22
6.3 DEVIATION FROM STANDARD	22
6.4 TEST SETUP	22
6.5 EUT OPERATION CONDITIONS	22
6.6 TEST RESULTS	22
<b>7 . CONDUCTED SPURIOUS EMISSION</b>	<b>23</b>
7.1 LIMIT	23
7.2 TEST PROCEDURE	23
7.3 DEVIATION FROM STANDARD	23
7.4 TEST SETUP	23
7.5 EUT OPERATION CONDITIONS	23
7.6 TEST RESULTS	23
<b>8 . POWER SPECTRAL DENSITY</b>	<b>24</b>
8.1 LIMIT	24
8.2 TEST PROCEDURE	24
8.3 DEVIATION FROM STANDARD	24
8.4 TEST SETUP	24
8.5 EUT OPERATION CONDITIONS	24
8.6 TEST RESULTS	24
<b>9 . MEASUREMENT INSTRUMENTS LIST</b>	<b>25</b>
<b>10 . EUT TEST PHOTO</b>	<b>26</b>
<b>APPENDIX A - AC POWER LINE CONDUCTED EMISSIONS</b>	<b>29</b>
<b>APPENDIX B - RADIATED EMISSION - 9 KHZ TO 30 MHZ</b>	<b>32</b>
<b>APPENDIX C - RADIATED EMISSION - 30 MHZ TO 1000 MHZ</b>	<b>33</b>
<b>APPENDIX D - RADIATED EMISSION - ABOVE 1000 MHZ</b>	<b>36</b>
<b>APPENDIX E - BANDWIDTH</b>	<b>47</b>
<b>APPENDIX F - MAXIMUM OUTPUT POWER</b>	<b>52</b>

**Table of Contents****Page****APPENDIX G - CONDUCTED SPURIOUS EMISSION****55****APPENDIX H - POWER SPECTRAL DENSITY****61**

**REPORT ISSUED HISTORY**

Report No.	Version	Description	Issued Date	Note
FCC022022-06244RF5	V1.0	Original Report.	2023.01.28	Valid

### 1. SUMMARY OF TEST RESULTS

Test procedures according to the technical standard(s):

FCC CFR Title 47, Part 15, Subpart C				
Standard(s) Section	Test Item	Test Result	Judgment	Remark
15.207	AC Power Line Conducted Emissions	APPENDIX A	PASS	-----
15.247(d) 15.205(a) 15.209(a)	Radiated Emissions	APPENDIX B APPENDIX C APPENDIX D	PASS	-----
15.247(a)(2)	Bandwidth	APPENDIX E	PASS	-----
15.247(b)(3)	Maximum Output Power	APPENDIX F	PASS	-----
15.247(d)	Conducted Spurious Emission	APPENDIX G	PASS	-----
15.247(e)	Power Spectral Density	APPENDIX H	PASS	-----
15.203	Antenna Requirement	-----	PASS	Note(2)

Note:

- (1) "N/A" denotes test is not applicable to this device.
- (2) The device what use a permanently attached antenna were considered sufficient to comply with the provisions of 15.203.

## 1.1 TEST FACILITY

Company:	Beijing TIRT Technology Service Co.,Ltd Shenzhen
Address:	101, 3 # Factory Building, Gongjin Electronics Shatin Community, Kengzi Street, Pingshan District, Shenzhen, China
CNAS Registration Number:	CNAS L14158
A2LA Registration Number:	6049.01
FCC Accredited Lab. Designation Number:	CN1309
FCC Test Firm Registration Number:	825524
Telephone:	+86-0755-27087573

## 1.2 MEASUREMENT UNCERTAINTY

ISO/IEC 17025 requires that an estimate of the measurement uncertainties associated with the emissions test results be included in the report. The measurement uncertainties given below are based on a 95% confidence level (based on a coverage factor (k=2))

The BTL measurement uncertainty as below table:

Parameter	Uncertainty
Occupied Channel Bandwidth	±142.12 KHz
RF power conducted	±0.74 dB
RF power radiated	±3.25dB
Spurious emissions, conducted	±1.78dB
Spurious emissions, radiated (30MHz~1GHz)	±4.6dB
Spurious emissions, radiated (1GHz ~ 18GHz)	±4.9dB
Conduction Emissions(150kHz~30MHz)	±3.1 dB
Humidity	±4.6%
Temperature	±0.7°C
Time	±1.25%

Note: Unless specifically mentioned, the uncertainty of measurement has not been taken into account to declare the compliance or non-compliance to the specification.



### 1.3 TEST ENVIRONMENT CONDITIONS

Test Item	Temperature	Humidity	Test Voltage	Tested By
AC Power Line Conducted Emissions	25°C	53%	AC 120V/60Hz	Stone Tang
Radiated Emissions-9 kHz to 30 MHz	24°C	51%	AC 120V/60Hz	Stone Tang
Radiated Emissions-30 MHz to 1000 MHz	24°C	51%	AC 120V/60Hz	Stone Tang
Radiated Emissions-Above 1000 MHz	24°C	51%	AC 120V/60Hz	Stone Tang
Bandwidth	24.5°C	52%	AC 120V/60Hz	Stone Tang
Maximum Output Power	24.5°C	52%	AC 120V/60Hz	Stone Tang
Conducted Spurious Emission	24.5°C	52%	AC 120V/60Hz	Stone Tang
Power Spectral Density	24.5°C	52%	AC 120V/60Hz	Stone Tang

## 2. GENERAL INFORMATION

### 2.1 GENERAL DESCRIPTION OF EUT

Equipment	Wi-Fi&Bluetooth Module
Brand Name	Yealink
Test Model	YL43456
Series Model	N/A
Model Difference(s)	N/A
Software Version	N/A
Hardware Version	N/A
Power Source	DC voltage supplied from host system.
Power Rating	DC 3.6V
Operation Frequency	2402 MHz ~ 2480 MHz
Modulation Type	GFSK
Bit Rate of Transmitter	1Mbps
Max. Output Power	1Mbps: 3.53 dBm (0.0023 W)

Note:

1. For a more detailed features description, please refer to the manufacturer's specifications or the user's manual.

2. Channel List:

Channel	Frequency (MHz)	Channel	Frequency (MHz)
00	2402	20	2442
01	2404	21	2444
02	2406	22	2446
03	2408	23	2448
04	2410	24	2450
05	2412	25	2452
06	2414	26	2454
07	2416	27	2456
08	2418	28	2458
09	2420	29	2460
10	2422	30	2462
11	2424	31	2464
12	2426	32	2466
13	2428	33	2468
14	2430	34	2470
15	2432	35	2472
16	2434	36	2474
17	2436	37	2476
18	2438	38	2478
19	2440	39	2480

3. Table for Filed Antenna:

Ant.	Brand	Model Name	Antenna Type	Connector	Gain (dBi)
1	N/A	N/A	FPC	N/A	3.0

Note:

1. The antenna gain is provided by the manufacturer.
2. The antenna is for testing purposes only.

## 2.2 DESCRIPTION OF TEST MODES

The test system was pre-tested based on the consideration of all possible combinations of EUT operation mode.

Pretest Mode	Description
Mode 1	TX Mode_1Mbps Channel 00/19/39
Mode 2	TX Mode_1Mbps Channel 00

Following mode(s) was (were) found to be the worst case(s) and selected for the final test.

<b>AC power line conducted emissions test</b>	
Final Test Mode	Description
Mode 2	TX Mode_1Mbps Channel 00

<b>Radiated emissions test - Below 1GHz</b>	
Final Test Mode	Description
Mode 2	TX Mode_1Mbps Channel 00

<b>Radiated emissions test - Above 1GHz</b>	
Final Test Mode	Description
Mode 1	TX Mode_1Mbps Channel 00/19/39

<b>Conducted test</b>	
Final Test Mode	Description
Mode 1	TX Mode_1Mbps Channel 00/19/39

Note:

- (1) For radiated emission above 1 GHz test, the spurious points of 1GHz~18GHz and 18GHz~26.5GHz have been pre-tested and in this report only recorded the worst case. The remaining spurious points are all below the limit value of 20dB.
- (2) For AC power line conducted emissions and radiated emissions below 1 GHz test, the 1Mbps Channel 00 is found to be the worst case and recorded.

### 2.3 PARAMETERS OF TEST SOFTWARE

During testing channel & power controlling software provided by the customer was used to control the operating channel as well as the output power level.

Test Software Version	AuthenticTool_1.2.14.0		
Frequency (MHz)	2402	2440	2480
1Mbps	default	default	default

### 2.4 BLOCK DIAGRAM SHOWING THE CONFIGURATION OF SYSTEM TESTED

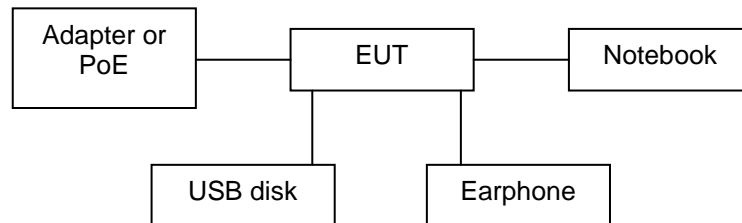

### 2.5 SUPPORT UNITS

Support Equipment				
No.	Equipment	Brand Name	Model Name	Remarks
1	Notebook	L450	Think	/
2	Earphone	/	/	/
3	USB disk	Kingston	/	/
4	Lan Cable	/	/	10m,Unshielding

### 3. AC POWER LINE CONDUCTED EMISSIONS

#### 3.1 LIMIT

Frequency of Emission (MHz)	Limit (dB $\mu$ V)	
	Quasi-peak	Average
0.15 - 0.5	66 to 56*	56 to 46*
0.5 - 5.0	56	□6
5.0 - 30.0	60	50

Note:

- (1) The tighter limit applies at the band edges.
- (2) The limit of " \* " marked band means the limitation decreases linearly with the logarithm of the frequency in the range.

#### 3.2 TEST PROCEDURE

- a. The EUT was placed 0.8 meters from the horizontal ground plane with EUT being connected to the power mains through a line impedance stabilization network (LISN). All other support equipment powered from additional LISN(s). The LISN provide 50 Ohm/ 50uH of coupling impedance for the measuring instrument.
- b. Interconnecting cables that hang closer than 40 cm to the ground plane shall be folded back and forth in the center forming a bundle 30 to 40 cm long.
- c. I/O cables that are not connected to a peripheral shall be bundled in the center. The end of the cable may be terminated, if required, using the correct terminating impedance. The overall length shall not exceed 1 m.
- d. LISN at least 80 cm from nearest part of EUT chassis.
- e. For the actual test configuration, please refer to the related Item –EUT Test Photos.

The following table is the setting of the receiver:

Receiver Parameters	Setting
Start Frequency	0.15 MHz
Stop Frequency	30 MHz
IF Bandwidth	9 kHz

#### 3.3 DEVIATION FROM TEST STANDARD

No deviation.

### 3.4 TEST SETUP

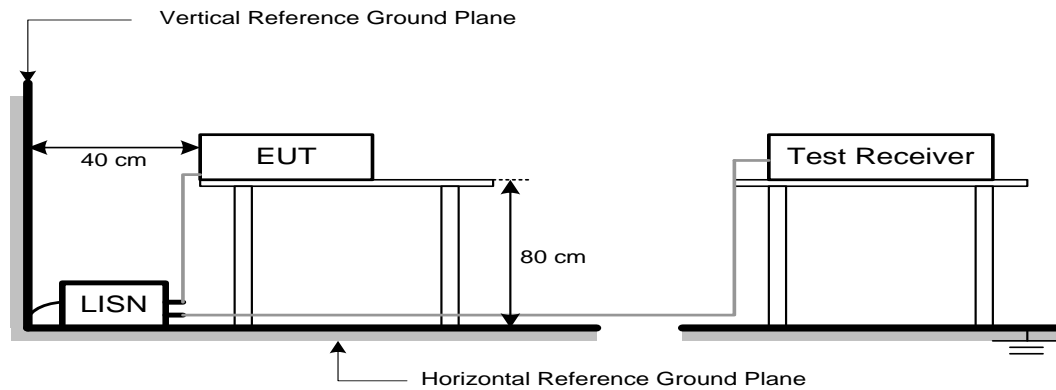

### 3.5 EUT OPERATING CONDITIONS

The EUT was configured for testing in a typical fashion (as a customer would normally use it). The EUT has been programmed to continuously transmit during test. This operating condition was tested and used to collect the included data.

### 3.6 TEST RESULTS

Please refer to the APPENDIX A.

Remark:

- (1) All readings are QP Mode value unless otherwise stated AVG in column of 『Note』 . If the QP Mode Measured value compliance with the QP Limits and lower than AVG Limits, the EUT shall be deemed to meet both QP & AVG Limits and then only QP Mode was measured, but AVG Mode didn't perform. In this case, a “ \* ” marked in AVG Mode column of Interference Voltage Measured.
- (2) Measuring frequency range from 150 kHz to 30 MHz.

## 4. RADIATED EMISSIONS

### 4.1 LIMIT

In case the emission fall within the restricted band specified on 15.205(a), then the 15.209(a) limit in the table below has to be followed.

#### LIMITS OF RADIATED EMISSION MEASUREMENT (9 kHz-1000 MHz)

Frequency (MHz)	Field Strength (microvolts/meter)	Measurement Distance (meters)
0.009-0.490	2400/F(kHz)	300
0.490-1.705	24000/F(kHz)	30
1.705-30.0	30	30
30-88	100	3
88-216	150	3
216-960	200	3
Above 960	500	3

#### LIMITS OF RADIATED EMISSION MEASUREMENT (Above 1000 MHz)

Frequency (MHz)	(dBuV/m at 3 m)	
	Peak	Average
Above 1000	74	54

**Note:**

- (1) The limit for radiated test was performed according to FCC CFR Title 47, Part 15, Subpart C.
- (2) The tighter limit applies at the band edges.
- (3) Emission level (dBuV/m)=20log Emission level (uV/m).



#### 4.2 TEST PROCEDURE

- a. The measuring distance of 3 m shall be used for measurements. The EUT was placed on the top of a rotating table 0.8 meter above the ground at a 3 meter semi-anechoic chamber. The table was rotated 360 degrees to determine the position of the highest radiation.(below 1 GHz)
- b. The measuring distance of 3 m shall be used for measurements. The EUT was placed on the top of a rotating table 1.5 meter above the ground at a 3 meter semi-anechoic chamber. The table was rotated 360 degrees to determine the position of the highest radiation.(above 1 GHz)
- c. The height of the equipment or of the substitution antenna shall be 0.8m or 1.5m; the height of the test antenna shall vary between 1 m to 4 m. Both horizontal and vertical polarizations of the antenna are set to make the measurement.
- d. For each suspected emission, the EUT was arranged to its worst case and then the antenna was tuned to heights find the maximum reading (used Bore sight function).
- e. The receiver system was set to peak and average detect function and specified bandwidth with maximum hold mode when the test frequency is above 1 GHz.
- f. The initial step in collecting radiated emission data is a receiver peak detector mode pre-scanning the measurement frequency range. Significant peaks are then marked and then Quasi Peak detector mode re-measured.
- g. All readings are Peak unless otherwise stated QP in column of Note. Peak denotes that the Peak reading compliance with the QP Limits and then QP Mode measurement didn't perform. (below 1 GHz)
- h. All readings are Peak Mode value unless otherwise stated AVG in column of Note. If the Peak Mode Measured value compliance with the Peak Limits and lower than AVG Limits, the EUT shall be deemed to meet both Peak & AVG Limits and then only Peak Mode was measured, but AVG Mode didn't perform. (above 1 GHz)
- i. For the actual test configuration, please refer to the related Item –EUT Test Photos.

The following table is the setting of the receiver:

Spectrum Parameters	Setting
Start ~ Stop Frequency	9 kHz~150 kHz for RBW 200 Hz
Start ~ Stop Frequency	0.15 MHz~30 MHz for RBW 9 kHz
Start ~ Stop Frequency	30 MHz~1000 MHz for RBW 100 kHz

Spectrum Parameters	Setting
Start Frequency	1000 MHz
Stop Frequency	10th carrier harmonic
RBW / VBW (Emission in restricted band)	1 MHz / 3 MHz for PK value 1 MHz / 1/T Hz for AVG value

Spectrum Parameters	Setting
Start ~ Stop Frequency	9 kHz~90 kHz for PK/AVG detector
Start ~ Stop Frequency	90 kHz~110 kHz for QP detector
Start ~ Stop Frequency	110 kHz~490 kHz for PK/AVG detector
Start ~ Stop Frequency	490 kHz~30 MHz for QP detector
Start ~ Stop Frequency	30 MHz~1000 MHz for QP detector
Start ~ Stop Frequency	1 GHz~26.5 GHz for PK/AVG detector

### 4.3 DEVIATION FROM TEST STANDARD

No deviation.

### 4.4 TEST SETUP

#### 9 kHz to 30 MHz

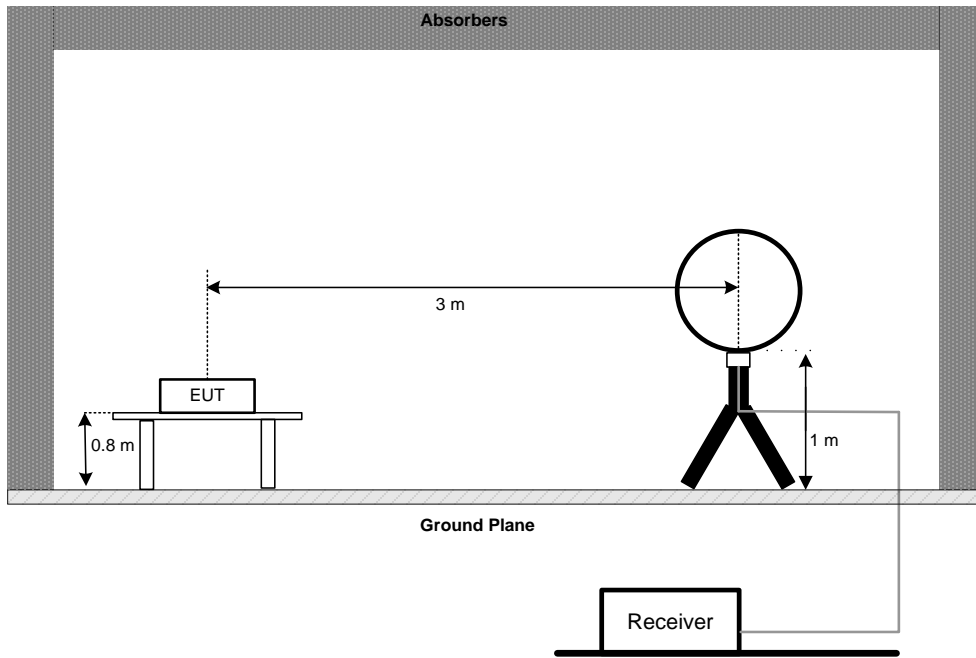

#### 30 MHz to 1 GHz

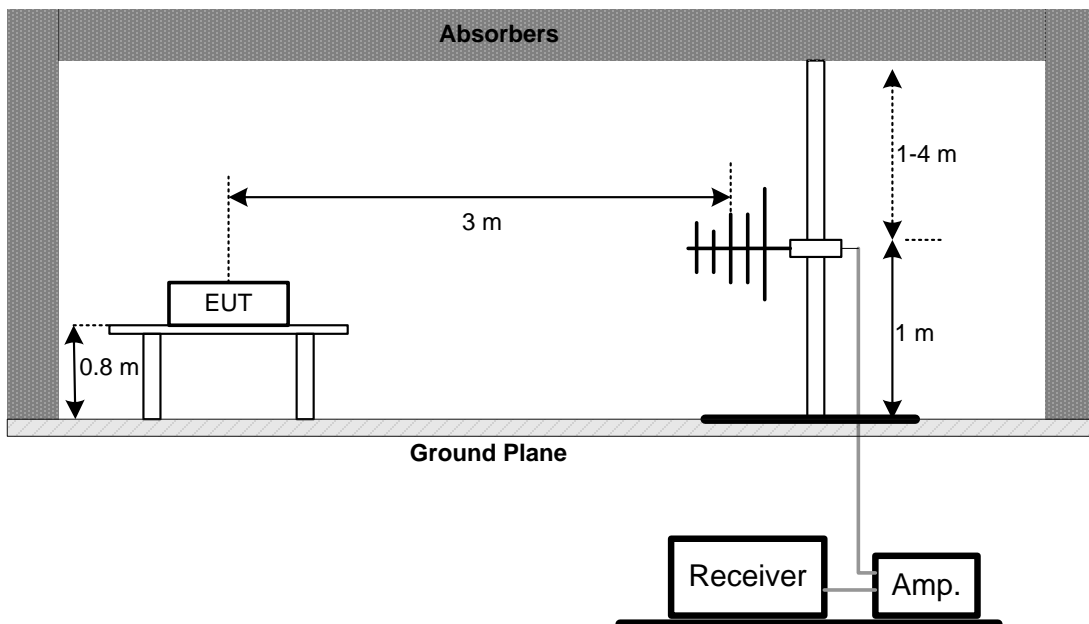

**Above 1 GHz**

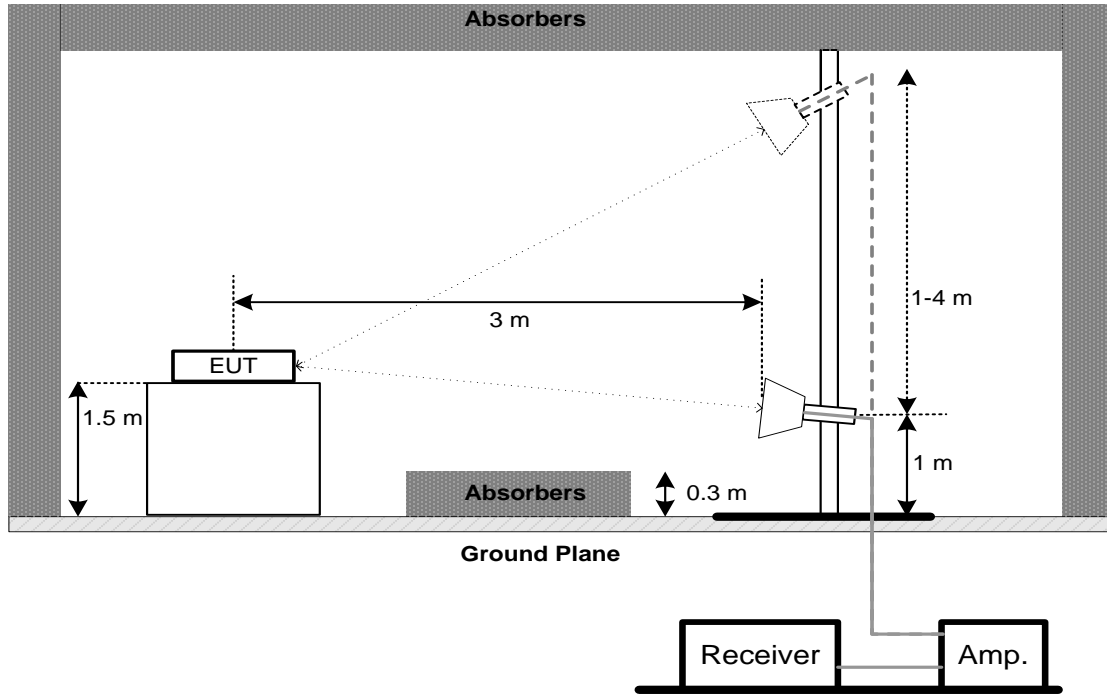

**4.5 EUT OPERATING CONDITIONS**

The EUT was programmed to be in continuously transmitting mode.

**4.6 TEST RESULT - 9 kHz TO 30 MHz**

Please refer to the APPENDIX B.

Remark:

- (1) Distance extrapolation factor =  $40 \log(\text{specific distance} / \text{test distance})$  (dB).
- (2) Limit line = specific limits (dBuV) + distance extrapolation factor.

**4.7 TEST RESULT - 30 MHz TO 1000 MHz**

Please refer to the APPENDIX C.

**4.8 TEST RESULT - ABOVE 1000 MHz**

Please refer to the APPENDIX D.

Remark:

- (1) No limit: This is fundamental signal, the judgment is not applicable.  
For fundamental signal judgment was referred to Peak output test.

## 5. BANDWIDTH

### 5.1 LIMIT

Section	Test Item	Limit
FCC 15.247(a)(2)	6 dB Bandwidth	$\geq 500$ kHz
	99% Emission Bandwidth	-

### 5.2 TEST PROCEDURE

- The EUT was directly connected to the tonscend test system and antenna output port as show in the block diagram below.
- The following table is the setting of the spectrum analyzer:

For 6 dB Bandwidth:

Spectrum Parameters	Setting
Span Frequency	> Measurement Bandwidth
RBW	100 kHz
VBW	300 kHz
Detector	Peak
Trace	Max Hold
Sweep Time	Auto

For 99% Emission Bandwidth:

Spectrum Parameters	Setting
Span Frequency	Between 1.5 times and 5.0 times the OBW
RBW	30 kHz
VBW	100 kHz
Detector	Peak
Trace	Max Hold
Sweep Time	Auto

### 5.3 DEVIATION FROM STANDARD

No deviation.

### 5.4 TEST SETUP

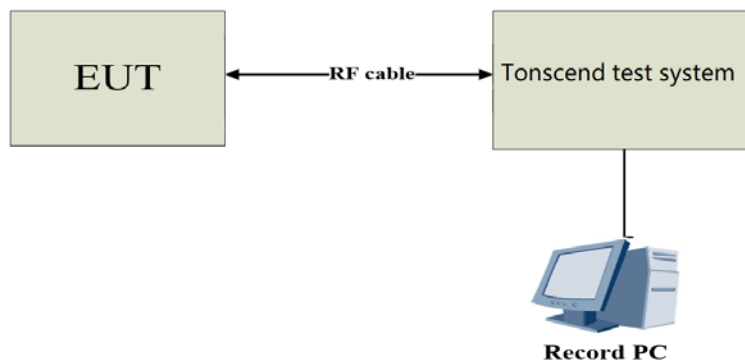

### 5.5 EUT OPERATION CONDITIONS

The EUT was programmed to be in continuously transmitting mode.

### 5.6 TEST RESULTS

Please refer to the APPENDIX E.

## 6. MAXIMUM OUTPUT POWER

### 6.1 LIMIT

Section	Test Item	Limit
FCC 15.247(b)(3)	Maximum Output Power	1.0000 watt or 30.00 dBm

### 6.2 TEST PROCEDURE

- The EUT was directly connected to the tonscend test system and antenna output port as show in the block diagram below.
- The following table is the setting of the spectrum analyzer:

Spectrum Parameters	Setting
Span Frequency	$\geq 3 \times \text{RBW}$
RBW	3 MHz
VBW	3 MHz
Detector	Peak
Trace	Max Hold
Sweep Time	Auto

### 6.3 DEVIATION FROM STANDARD

No deviation.

### 6.4 TEST SETUP

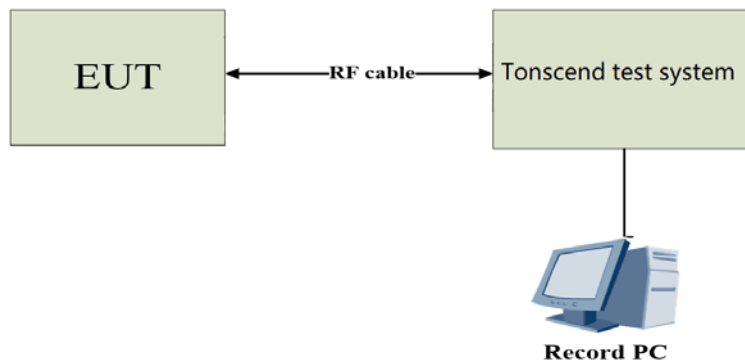

### 6.5 EUT OPERATION CONDITIONS

The EUT was programmed to be in continuously transmitting mode.

### 6.6 TEST RESULTS

Please refer to the APPENDIX F.

## 7. CONDUCTED SPURIOUS EMISSION

### 7.1 LIMIT

In any 100 kHz bandwidth outside the frequency band in which the spread spectrum or digitally modulated intentional radiator is operating, the radio frequency power that is produced by the intentional radiator shall be at least 20 dB below that in the 100 kHz bandwidth within the band that contains the highest level of the desired power, based on either an RF conducted or a radiated measurement, provided the transmitter demonstrates compliance with the peak Output Power limits. If the transmitter complies with the Output Power limits based on the use of RMS averaging over a time interval, as permitted under paragraph (b)(3) of this section, the attenuation required under this paragraph shall be 30 dB instead of 20 dB. Attenuation below the general limits specified in Section 15.209(a) is not required.

### 7.2 TEST PROCEDURE

- a. The EUT was directly connected to the tonscend test system and antenna output port as show in the block diagram below.
- b. The following table is the setting of the spectrum analyzer:

Spectrum Parameters	Setting
Start Frequency	30 MHz
Stop Frequency	26.5 GHz
RBW	100 kHz
VBW	300 kHz
Detector	Peak
Trace	Max Hold
Sweep Time	Auto

### 7.3 DEVIATION FROM STANDARD

No deviation.

### 7.4 TEST SETUP

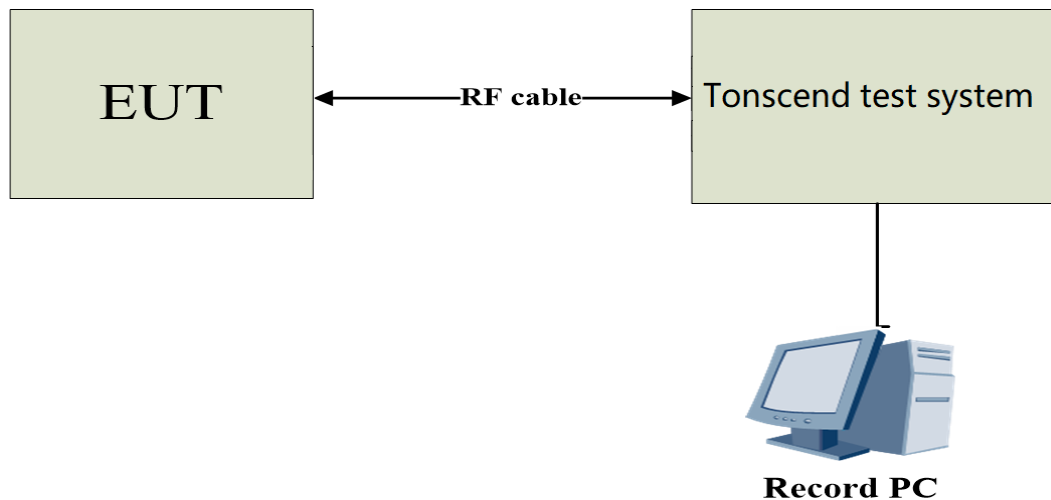

### 7.5 EUT OPERATION CONDITIONS

The EUT was programmed to be in continuously transmitting mode.

### 7.6 TEST RESULTS

Please refer to the APPENDIX G.

## 8. POWER SPECTRAL DENSITY

### 8.1 LIMIT

Section	Test Item	Limit
FCC 15.247(e)	Power Spectral Density	8 dBm (in any 3 kHz)

### 8.2 TEST PROCEDURE

- The EUT was directly connected to the tonscend test system and antenna output port as show in the block diagram below.
- The following table is the setting of the spectrum analyzer:

Spectrum Parameters	Setting
Span Frequency	2 MHz (1 Mbps) / 4 MHz (2 Mbps)
RBW	3 kHz
VBW	10 kHz
Detector	Peak
Trace	Max Hold
Sweep Time	Auto

### 8.3 DEVIATION FROM STANDARD

No deviation.

### 8.4 TEST SETUP

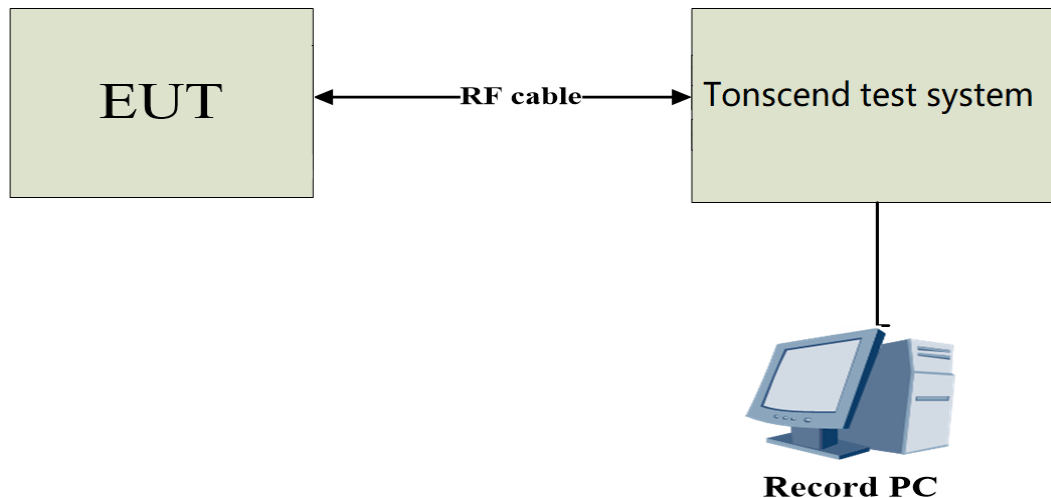

### 8.5 EUT OPERATION CONDITIONS

The EUT was programmed to be in continuously transmitting mode.

### 8.6 TEST RESULTS

Please refer to the APPENDIX H.



**9. MEASUREMENT INSTRUMENTS LIST**

No.	Equipment	Manufacturer	Type No.	Serial No.	Calibrated until
1	EMI Receiver	Rohde&Schwarz	ESCI	1166.5950.03	2023/10/14
2	AMN	Rohde&Schwarz	ENV216	3560.6550.05	2023/10/14
3	AMN	Schwarzbeck	NSLK8127	#829	2023/10/14
4	ECSI RF IN RF Cable	Rohde&Schwarz	RP-X1	\	2023/10/14
5	ECSI RF IN RF Cable	Rohde&Schwarz	Sapre sm	\	2023/10/14
6	EMI Receiver	Rohde&Schwarz	ESR7	102013	2023/10/14
7	Spectrum analyzer	Rohde&Schwarz	FSV30	103741	2023/10/17
8	EMI receiver	Rohde&Schwarz	ESU	100184	2023/07/20
9	Spectrum analyzer	KEYSIGHT	N9010A-44	MY51440158	2023/10/17
10	Loop Antenna*	Schwarzbeck	FMZB1519B	00029	2025/07/03
11	Integral Antenna	Schwarzbeck	VULB 9163	VULB 9163-361	2023/10/20
12	Integral Antenna	Schwarzbeck	BBHA 9120D	BBHA 9120D 1201	2023/10/15
13	Integral Antenna	Schwarzbeck	BBHA 9170	9170#685	2023/10/15
14	Preamplifier	CD Systems Inc	PAP-03036-30	85060000	2023/10/15
15	Preamplifier	Schwarzbeck	BBV9721	9721-019	2023/10/15
16	Preamplifier	emci	EMC012645 SE	980417	2023/10/16
17	ECSI RF IN RF Cable	Rohde&Schwarz	AP-X1	\	2023/10/16
18	Spectrum Analyzer	Agilent	N9010A	MY52221119	2023/10/17
19	Power Collection Unit	Tonscend	JS0806-2	188060134	2023/10/16
20	Tonscend Test System	Tonscend	2.6.77.0518	NA	NA
21	10dB Attenuator	Tonscend	10dB	NA	NA
22	Temp&Humidity Recorder	Anymetre	JR900	NA	2023/10/16
23	Temp&Humidity Chamber	ETOMA	NTH1100-30 A	16080628	2023/10/16
24	Filter	STI	STI15-9845	N/A	N/A
25	Filter	STI	5.1G	N/A	N/A
26	Filter	STI	STI15-9845	N/A	N/A
27	Testing Software	EZ-EMC	TW-03A2	N/A	N/A

Remark: "N/A" denotes no model name, serial no. or calibration specified.

"\*\*" calibration period of equipment list is three year.

Except \* item, all calibration period of equipment list is one year.

### 10. EUT TEST PHOTO

#### AC Power Line Conducted Emissions Test Photos



#### Radiated Emissions Test Photos

##### 9 kHz to 30 MHz

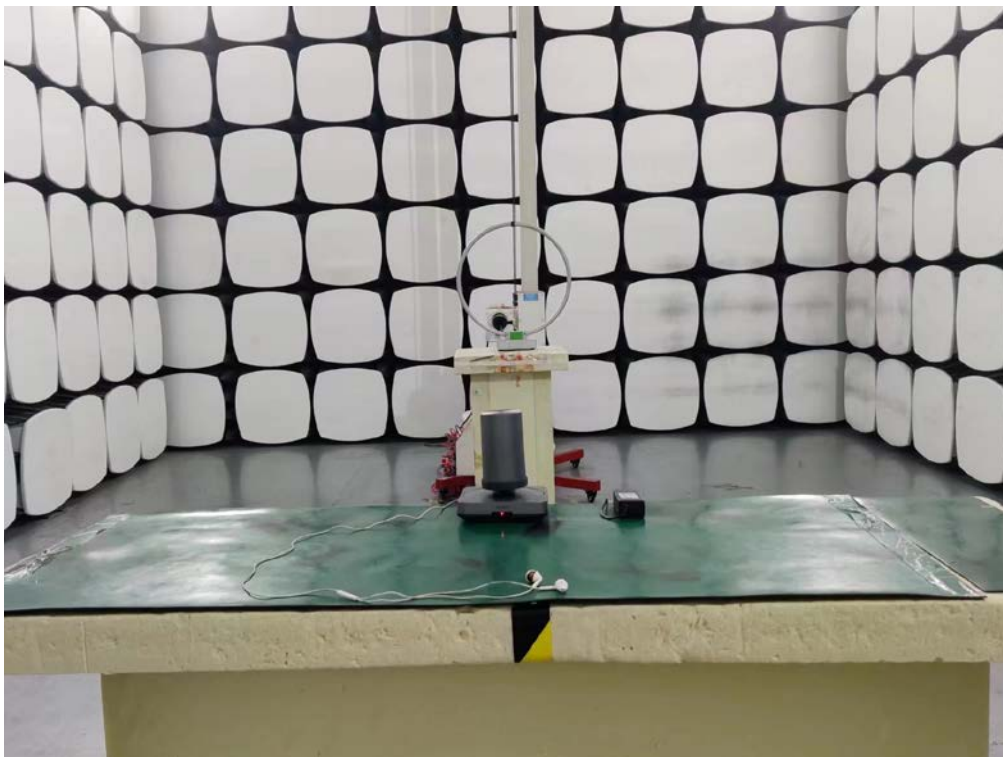

**Radiated Emissions Test Photos**

**30 MHz to 1000 MHz**

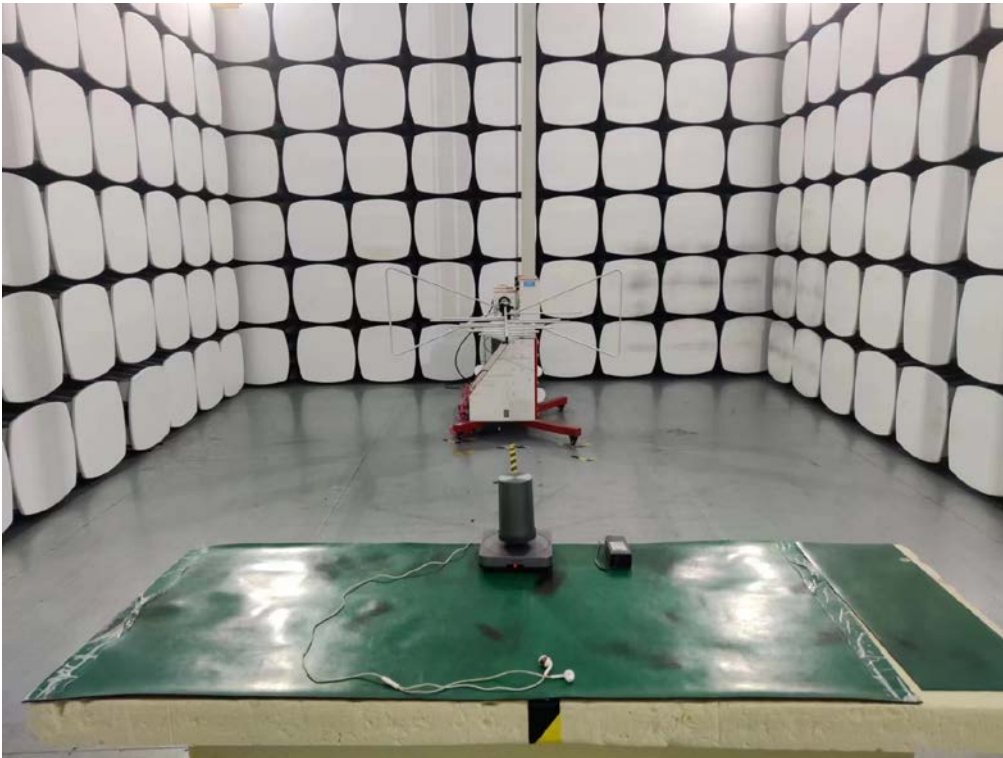

**Radiated Emissions Test Photos**

**Above 1 GHz**

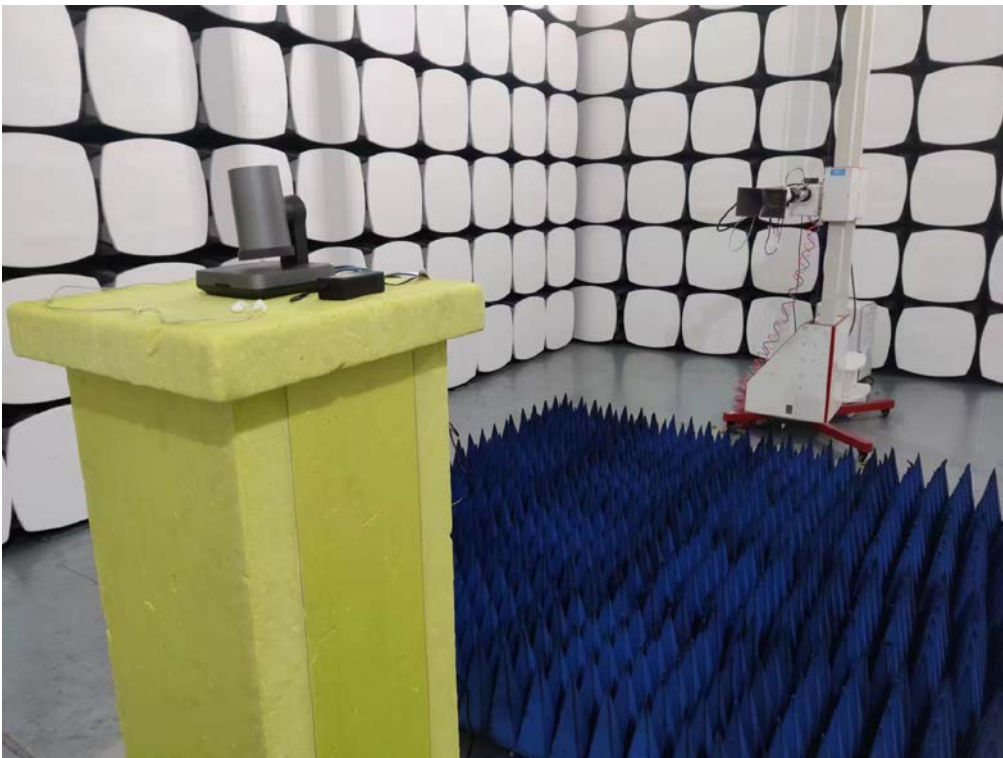

**Conducted Test Photos**

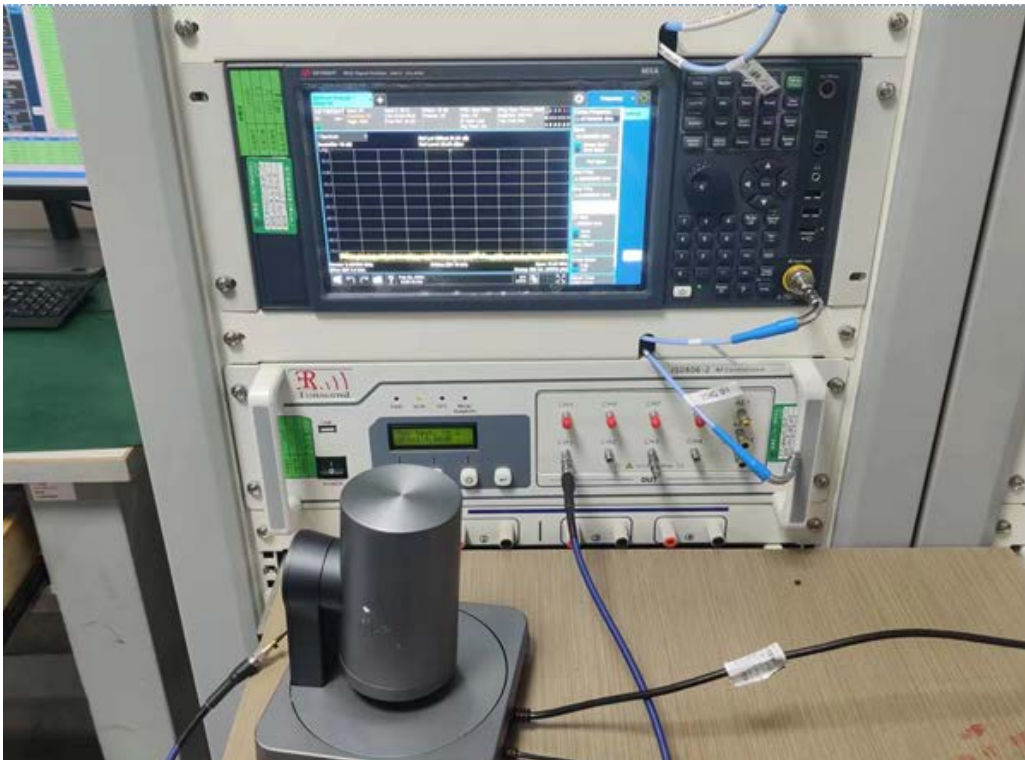

## **APPENDIX A - AC POWER LINE CONDUCTED EMISSIONS**

Test Mode	TX Mode_1Mbps Channel 00	Phase	Line
-----------	--------------------------	-------	------

### Conducted Emission Measurement

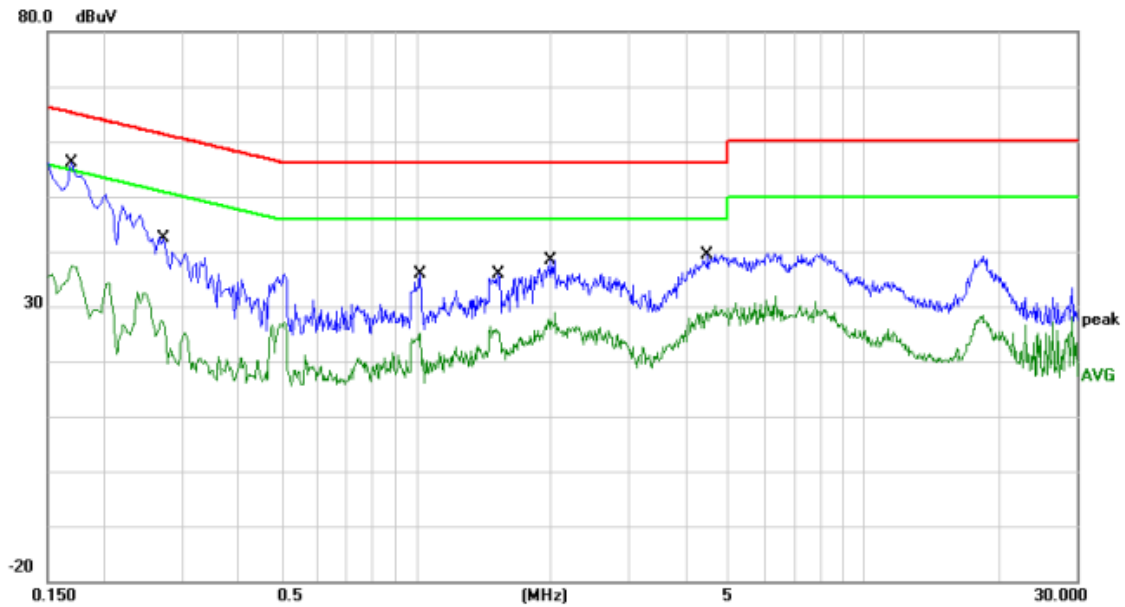

No.	Mk.	Freq.	Reading Level	Correct Factor	Measurement	Limit	Over	Detector	Comment
		MHz	dBuV	dB	dBuV	dBuV	dB		
1	*	0.1700	33.47	19.88	53.35	64.96	-11.61	QP	
2		0.1700	16.51	19.88	36.39	54.96	-18.57	AVG	
3		0.2740	18.39	19.88	38.27	61.00	-22.73	QP	
4		0.2740	3.85	19.88	23.73	51.00	-27.27	AVG	
5		1.0220	11.75	19.89	31.64	56.00	-24.36	QP	
6		1.0220	4.20	19.89	24.09	46.00	-21.91	AVG	
7		1.5340	12.89	19.90	32.79	56.00	-23.21	QP	
8		1.5340	5.77	19.90	25.67	46.00	-20.33	AVG	
9		2.0060	12.99	19.91	32.90	56.00	-23.10	QP	
10		2.0060	6.88	19.91	26.79	46.00	-19.21	AVG	
11		4.4860	14.71	19.91	34.62	56.00	-21.38	QP	
12		4.4860	6.90	19.91	26.81	46.00	-19.19	AVG	

**REMARKS:**

- (1) Measurement Value = Reading Level + Correct Factor.
- (2) Margin Level = Measurement Value - Limit Value.

Test Mode	TX Mode_1Mbps Channel 00	Phase	Neutral
-----------	--------------------------	-------	---------

### Conducted Emission Measurement

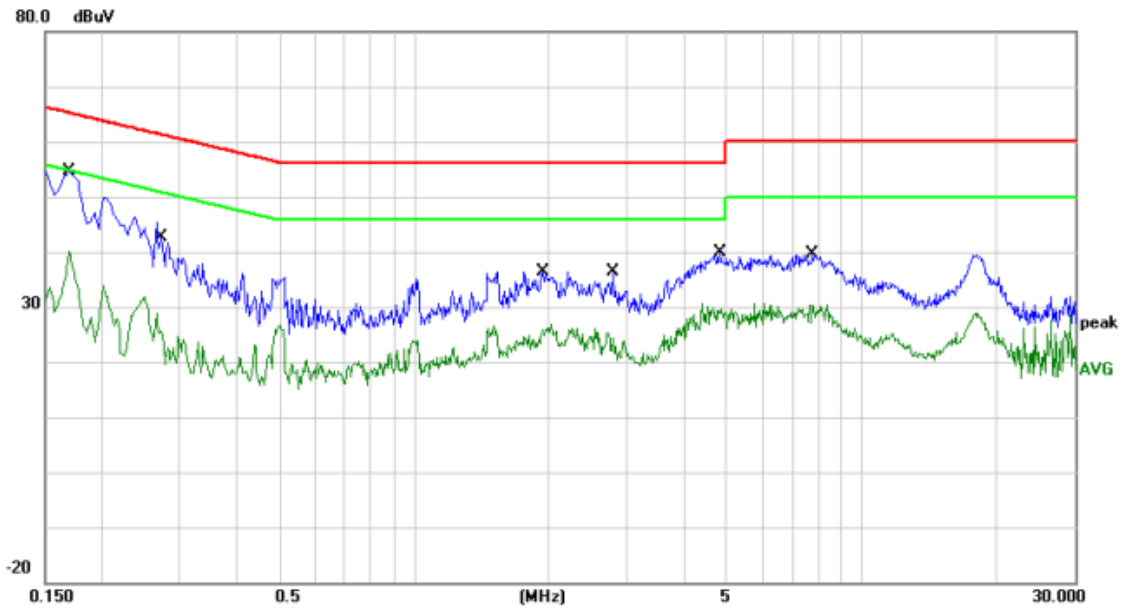

No.	Mk.	Freq.	Reading Level	Correct Factor	Measurement	Limit	Over	Detector	Comment
		MHz	dBuV	dB	dBuV	dBuV	dB		
1	*	0.1700	32.68	19.88	52.56	64.96	-12.40	QP	
2		0.1700	15.33	19.88	35.21	54.96	-19.75	AVG	
3		0.2740	18.49	19.88	38.37	61.00	-22.63	QP	
4		0.2740	4.01	19.88	23.89	51.00	-27.11	AVG	
5		1.9460	11.30	19.91	31.21	56.00	-24.79	QP	
6		1.9460	5.25	19.91	25.16	46.00	-20.84	AVG	
7		2.7940	8.84	19.91	28.75	56.00	-27.25	QP	
8		2.7940	2.03	19.91	21.94	46.00	-24.06	AVG	
9		4.8340	14.93	19.92	34.85	56.00	-21.15	QP	
10		4.8340	7.14	19.92	27.06	46.00	-18.94	AVG	
11		7.8060	14.93	19.94	34.87	60.00	-25.13	QP	
12		7.8060	7.75	19.94	27.69	50.00	-22.31	AVG	

**REMARKS:**

- (1) Measurement Value = Reading Level + Correct Factor.
- (2) Margin Level = Measurement Value - Limit Value.

## **APPENDIX B - RADIATED EMISSION - 9 KHZ TO 30 MHZ**

The low frequency, which started from 9 kHz to 30MHz, was pre-scanned and the result which was 20dB lower than the limit line was not reported.

There is a comparison data of both open-field test site and semi-Anechoic chamber, and the result came out very similar.



## **APPENDIX C - RADIATED EMISSION - 30 MHZ TO 1000 MHZ**

Test Mode	TX Mode_1Mbps Channel 00	Polarization	Vertical
-----------	--------------------------	--------------	----------

### Radiated Emission

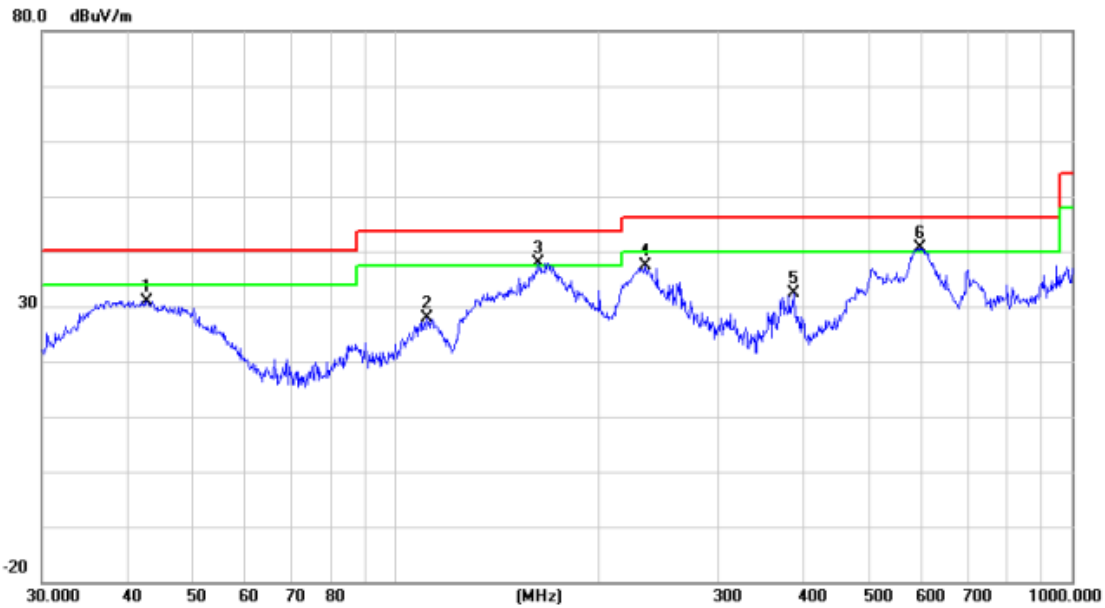

No.	Mk.	Freq.	Reading Level	Correct Factor	Measurement	Limit	Over	Antenna Height	Table Degree	
		MHz	dBuV	dB/m	dBuV/m	dBuV/m	dB	cm	degree	Comment
1		42.8997	40.98	-9.98	31.00	40.00	-9.00			peak
2		111.3468	40.54	-12.56	27.98	43.50	-15.52			peak
3	!	162.6105	47.88	-9.91	37.97	43.50	-5.53			peak
4		234.1683	48.32	-11.02	37.30	46.00	-8.70			peak
5		387.9920	38.95	-6.47	32.48	46.00	-13.52			peak
6	*	595.1327	41.95	-1.42	40.53	46.00	-5.47			peak

**REMARKS:**

- (1) Measurement Value = Reading Level + Correct Factor.
- (2) Margin Level = Measurement Value - Limit Value.

Test Mode	TX Mode_1Mbps Channel 00	Polarization	Horizontal
-----------	--------------------------	--------------	------------

### Radiated Emission

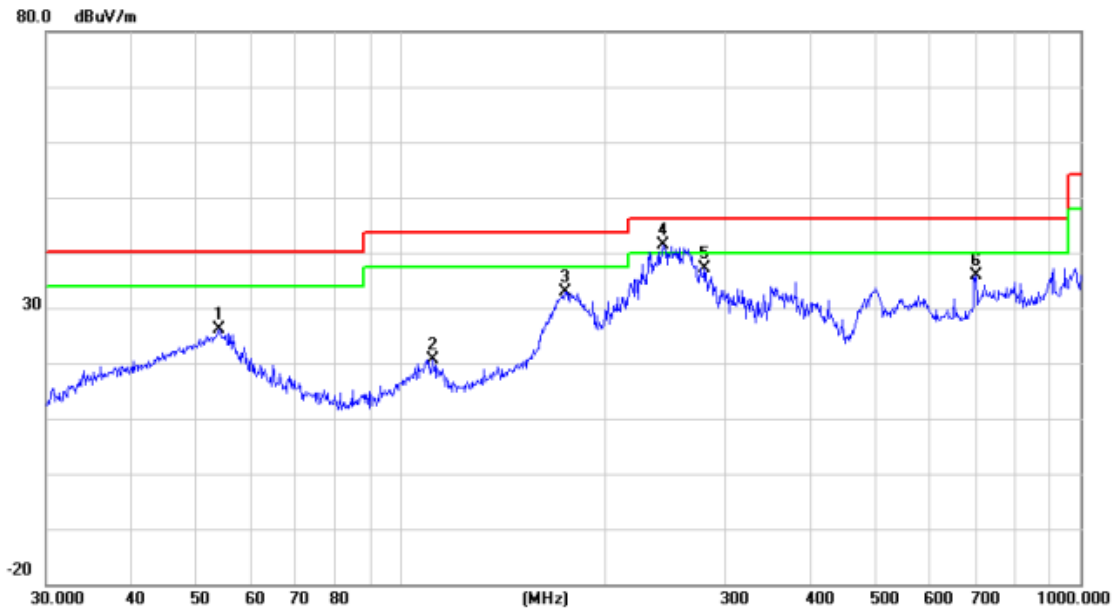

No.	Mk.	Freq.	Reading Level	Correct Factor	Measurement	Limit	Over	Antenna Height	Table Degree	
		MHz	dBuV	dB/m	dBuV/m	dBuV/m	dB	cm	degree	Comment
1		53.8817	36.79	-10.57	26.22	40.00	-13.78			peak
2		111.3468	33.21	-12.56	20.65	43.50	-22.85			peak
3		174.4240	43.81	-11.00	32.81	43.50	-10.69			peak
4	*	242.5252	51.92	-10.58	41.34	46.00	-4.66			peak
5		279.0436	46.42	-9.29	37.13	46.00	-8.87			peak
6		701.7610	35.46	0.34	35.80	46.00	-10.20			peak

**REMARKS:**

- (1) Measurement Value = Reading Level + Correct Factor.
- (2) Margin Level = Measurement Value - Limit Value.

## **APPENDIX D - RADIATED EMISSION - ABOVE 1000 MHZ**

Test Mode	TX 2402 MHz _CH00_1Mbps	Polarization	Vertical
-----------	-------------------------	--------------	----------

**Radiated Emission**

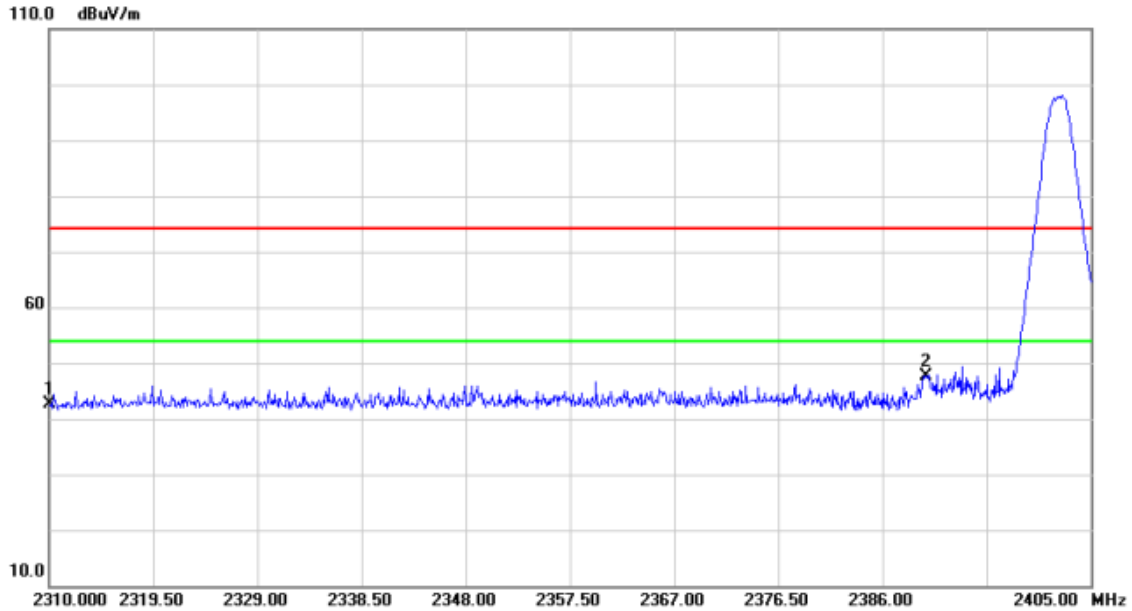

No.	Mk.	Freq.	Reading Level	Correct Factor	Measurement	Limit	Over	Antenna Height	Table Degree	
		MHz	dBuV	dB/m	dBuV/m	dBuV/m	dB	cm	degree	Comment
1		2310.000	54.67	-11.92	42.75	74.00	-31.25			peak
2	*	2390.000	59.30	-11.67	47.63	74.00	-26.37			peak

**REMARKS:**

- (1) Measurement Value = Reading Level + Correct Factor.
- (2) Margin Level = Measurement Value - Limit Value.

Test Mode	TX 2402 MHz _CH00_1Mbps	Polarization	Vertical
-----------	-------------------------	--------------	----------

### Radiated Emission

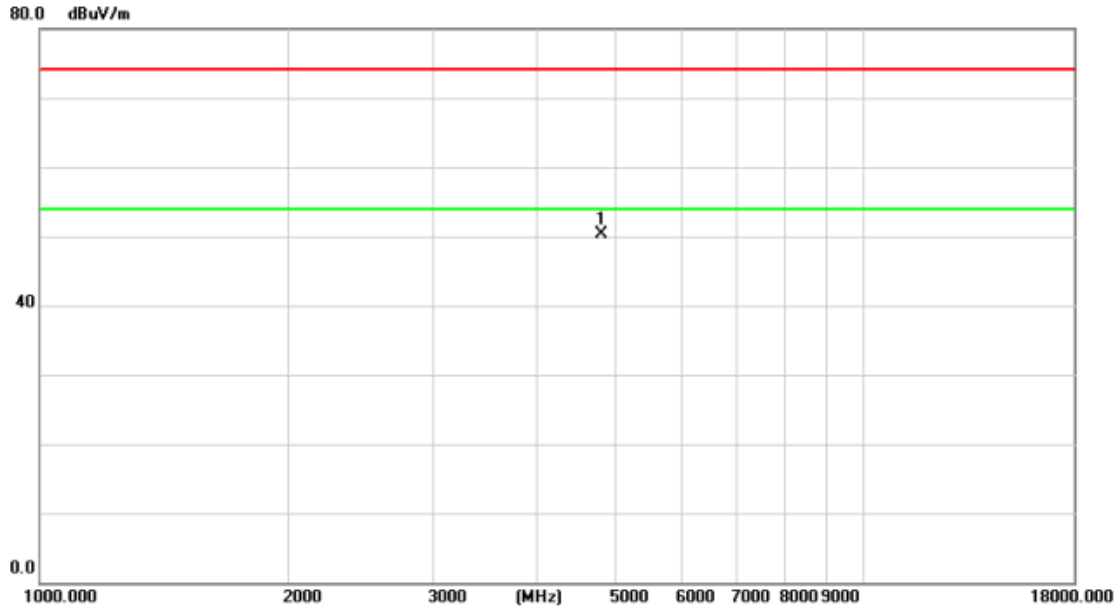

No.	Mk.	Freq.	Reading Level	Correct Factor	Measurement	Limit	Over	Antenna Height	Table Degree	
		MHz	dBuV	dB/m	dBuV/m	dBuV/m	dB	cm	degree	Comment
1	*	4804.000	52.31	-1.99	50.32	74.00	-23.68	peak		

**REMARKS:**

- (1) Measurement Value = Reading Level + Correct Factor.
- (2) Margin Level = Measurement Value - Limit Value.

Test Mode	TX 2402 MHz _CH00_1Mbps	Polarization	Horizontal
-----------	-------------------------	--------------	------------

### Radiated Emission

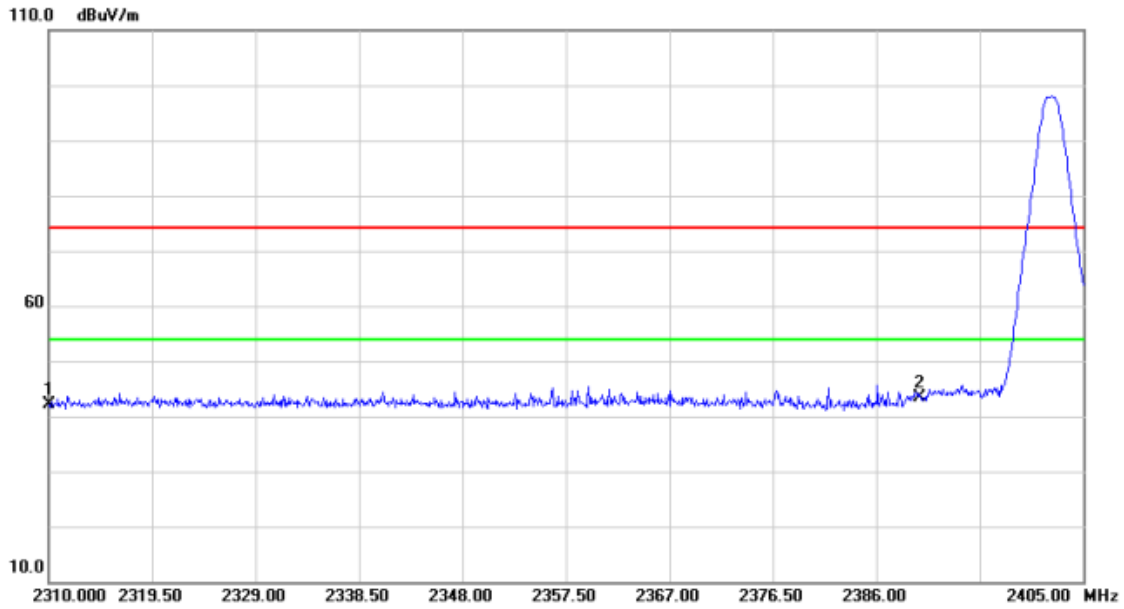

No.	Mk.	Freq.	Reading Level	Correct Factor	Measurement	Limit	Over	Antenna Height	Table Degree	
		MHz	dBuV	dB/m	dBuV/m	dBuV/m	dB	cm	degree	Comment
1		2310.000	54.01	-11.92	42.09	74.00	-31.91			peak
2 *		2390.000	54.98	-11.67	43.31	74.00	-30.69			peak

**REMARKS:**

(1) Measurement Value = Reading Level + Correct Factor.

(2) Margin Level = Measurement Value - Limit Value.

Test Mode	TX 2402 MHz _CH00_1Mbps	Polarization	Horizontal
-----------	-------------------------	--------------	------------

### Radiated Emission

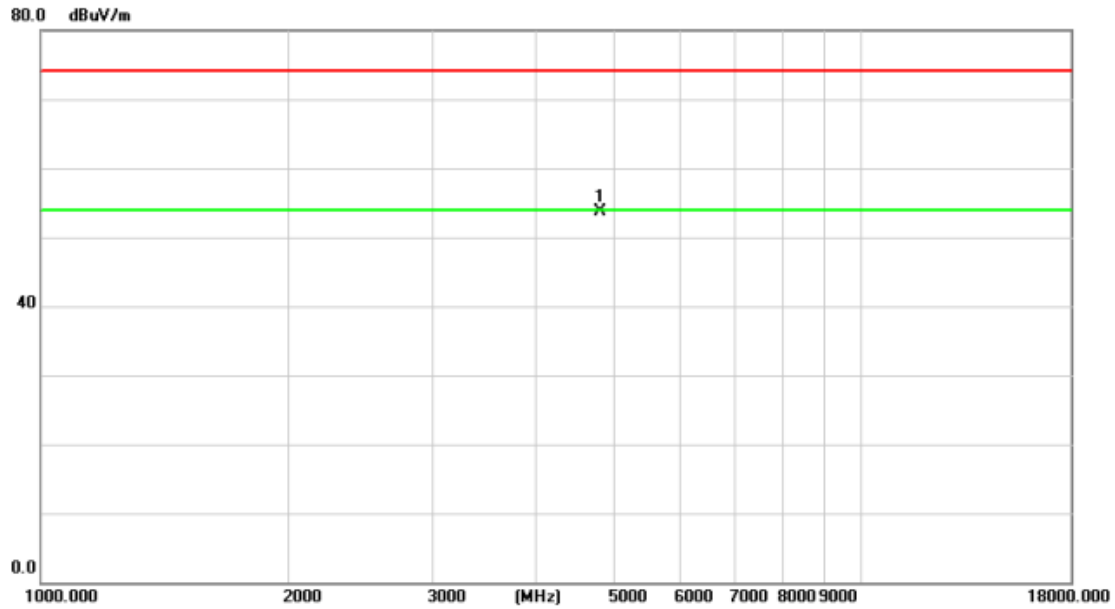

No.	Mk.	Freq.	Reading Level	Correct Factor	Measurement	Limit	Over	Antenna Height	Table Degree
		MHz	dBuV	dB/m	dBuV/m	dBuV/m	dB	cm	degree
1	*	4804.000	55.75	-1.99	53.76	74.00	-20.24	peak	

**REMARKS:**

- (1) Measurement Value = Reading Level + Correct Factor.
- (2) Margin Level = Measurement Value - Limit Value.



Test Mode	TX 2440 MHz _CH19_1Mbps	Polarization	Vertical
-----------	-------------------------	--------------	----------

### Radiated Emission

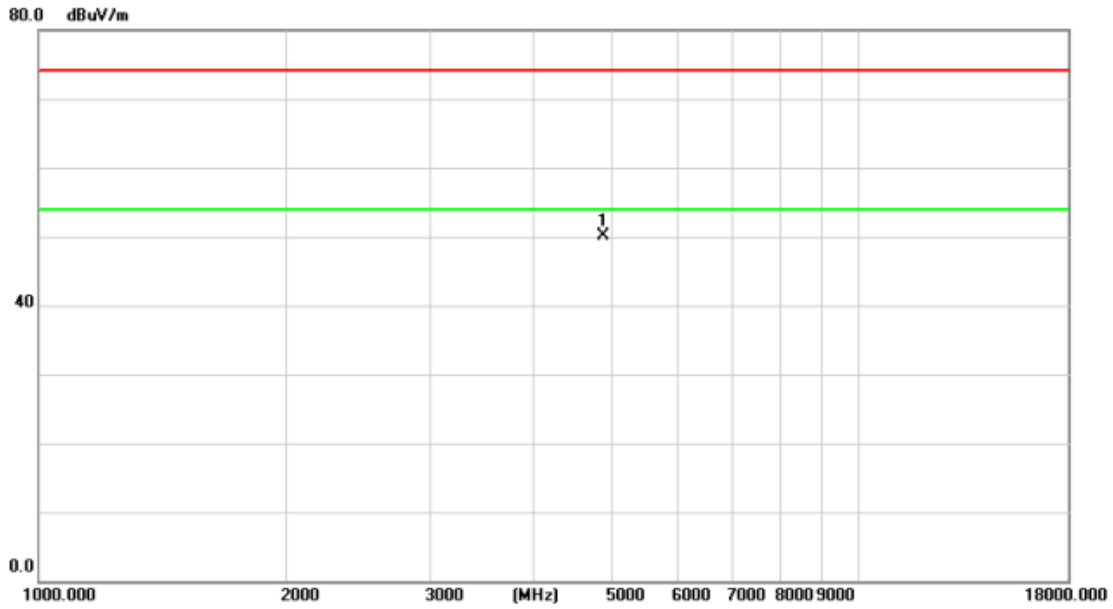

No.	Mk.	Freq.	Reading Level	Correct Factor	Measurement	Limit	Over	Antenna Height	Table Degree
		MHz	dBuV	dB/m	dBuV/m	dBuV/m	dB	cm	degree
1	*	4880.000	51.73	-1.56	50.17	74.00	-23.83	peak	

**REMARKS:**

- (1) Measurement Value = Reading Level + Correct Factor.
- (2) Margin Level = Measurement Value - Limit Value.

Test Mode	TX 2440 MHz _CH19_1Mbps	Polarization	Horizontal
-----------	-------------------------	--------------	------------

### Radiated Emission

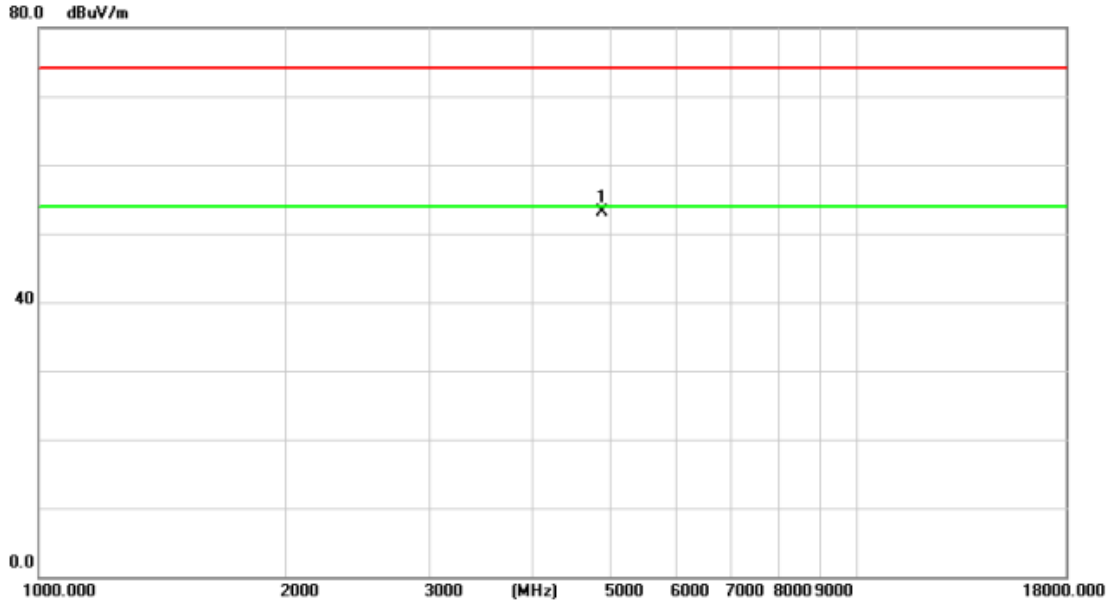

No.	Mk.	Freq.	Reading Level	Correct Factor	Measurement	Limit	Over	Antenna Height	Table Degree	
		MHz	dBuV	dB/m	dBuV/m	dBuV/m	dB	cm	degree	Comment
1	*	4880.000	54.75	-1.56	53.19	74.00	-20.81			peak

**REMARKS:**

- (1) Measurement Value = Reading Level + Correct Factor.
- (2) Margin Level = Measurement Value - Limit Value.

Test Mode	TX 2480 MHz _CH39_1Mbps	Polarization	Vertical
-----------	-------------------------	--------------	----------

### Radiated Emission

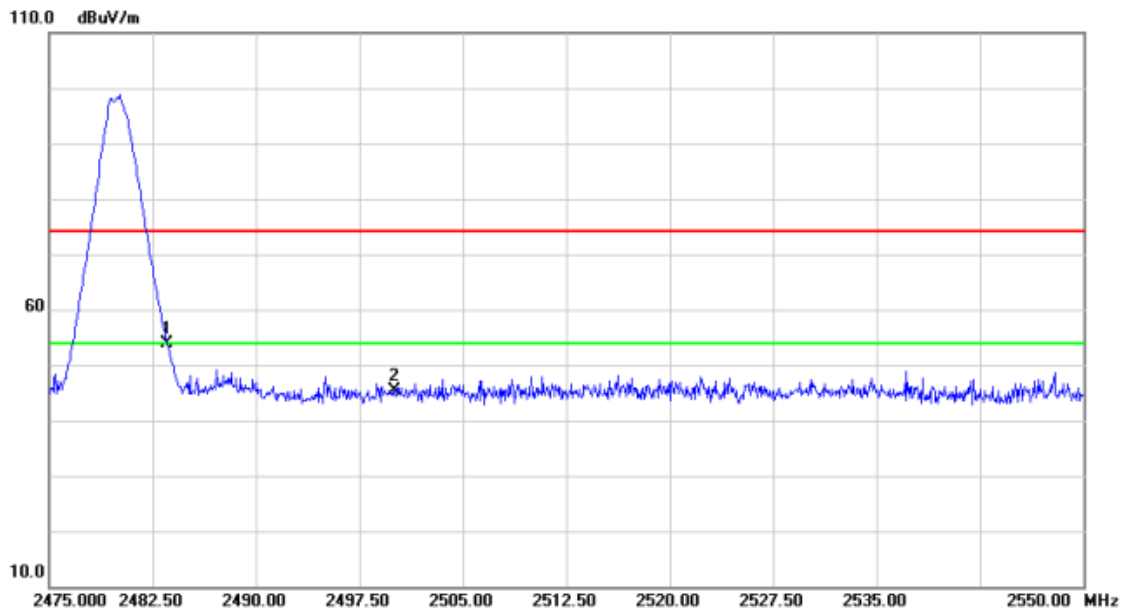

No.	Mk.	Freq.	Reading Level	Correct Factor	Measurement	Limit	Over	Antenna Height	Table Degree	
		MHz	dBuV	dB/m	dBuV/m	dBuV/m	dB	cm	degree	Comment
1	*	2483.500	65.09	-11.28	53.81	74.00	-20.19			peak
2		2500.000	56.51	-11.21	45.30	74.00	-28.70			peak

**REMARKS:**

- (1) Measurement Value = Reading Level + Correct Factor.
- (2) Margin Level = Measurement Value - Limit Value.

Test Mode	TX 2480 MHz _CH39_1Mbps	Polarization	Vertical
-----------	-------------------------	--------------	----------

### Radiated Emission

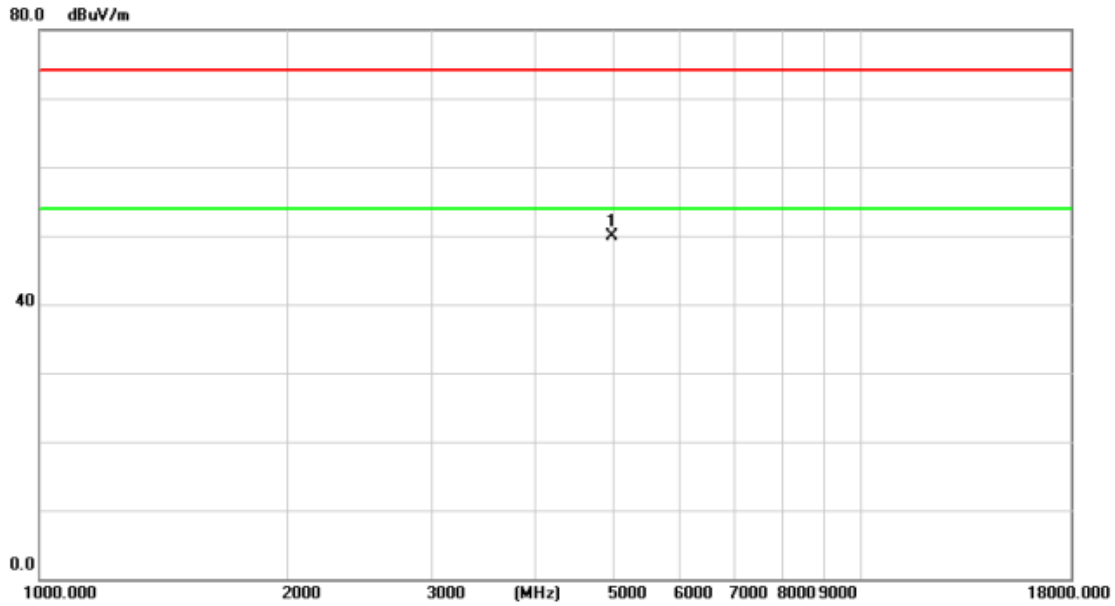

No.	Mk.	Freq.	Reading Level	Correct Factor	Measurement	Limit	Over	Antenna Height	Table Degree
		MHz	dBuV	dB/m	dBuV/m	dBuV/m	dB	cm	degree
1	*	4960.000	51.05	-1.10	49.95	74.00	-24.05	peak	

**REMARKS:**

- (1) Measurement Value = Reading Level + Correct Factor.
- (2) Margin Level = Measurement Value - Limit Value.

Test Mode	TX 2480 MHz _CH39_1Mbps	Polarization	Horizontal
-----------	-------------------------	--------------	------------

### Radiated Emission

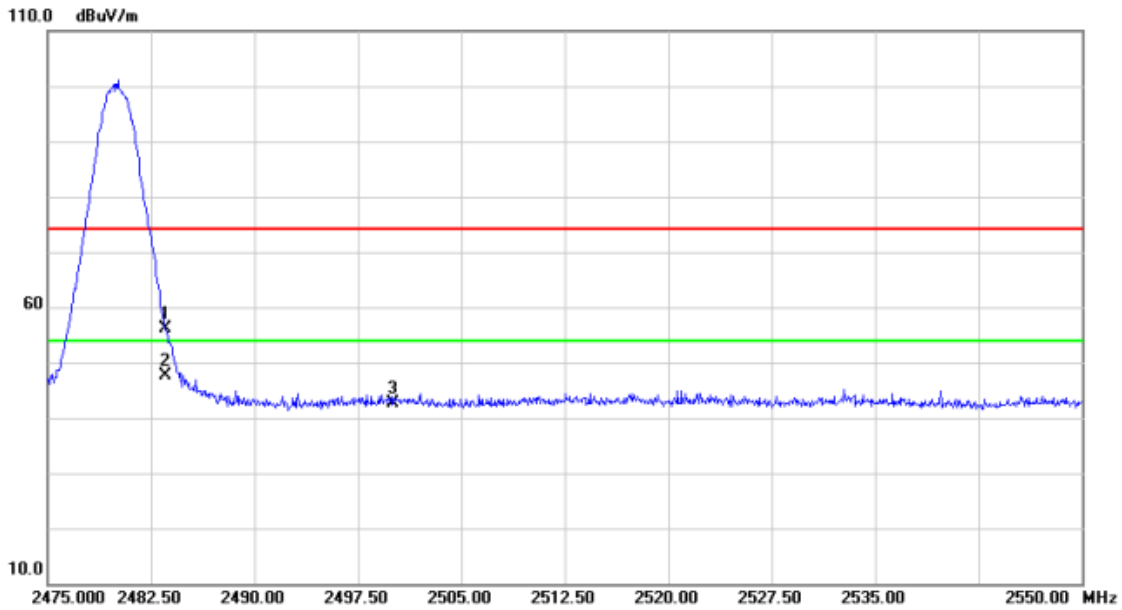

No.	Mk.	Freq.	Reading Level	Correct Factor	Measurement	Limit	Over	Antenna Height	Table Degree	
		MHz	dBuV	dB/m	dBuV/m	dBuV/m	dB	cm	degree	Comment
1		2483.500	67.35	-11.28	56.07	74.00	-17.93			peak
2	*	2483.500	58.90	-11.28	47.62	54.00	-6.38			AVG
3		2500.000	53.88	-11.21	42.67	74.00	-31.33			peak

**REMARKS:**

- (1) Measurement Value = Reading Level + Correct Factor.
- (2) Margin Level = Measurement Value - Limit Value.

Test Mode	TX 2480 MHz _CH39_1Mbps	Polarization	Horizontal
-----------	-------------------------	--------------	------------

### Radiated Emission

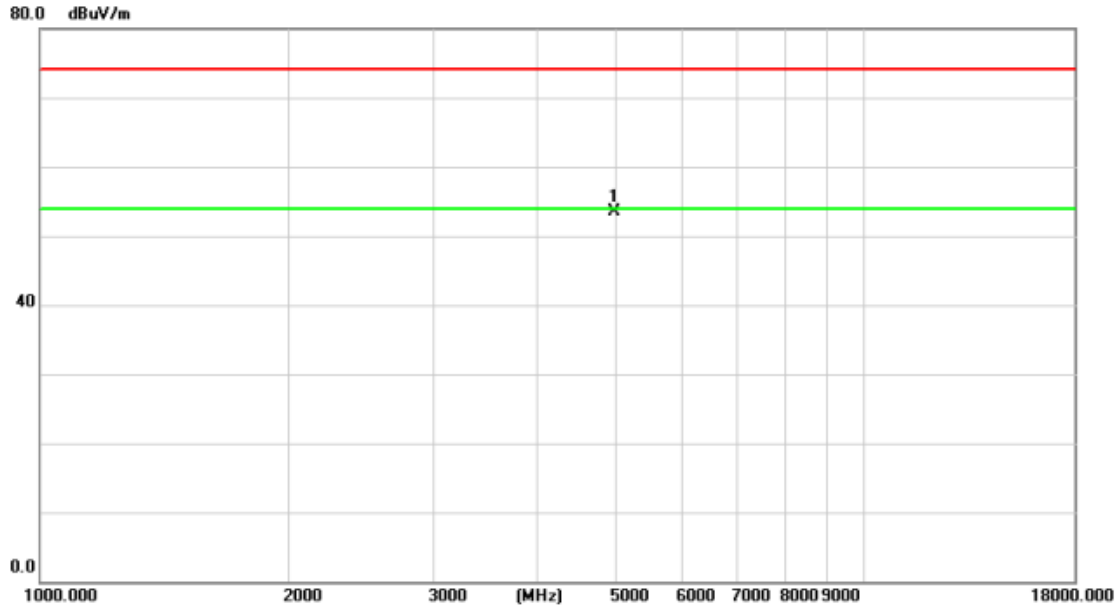

No.	Mk.	Freq.	Reading Level	Correct Factor	Measurement	Limit	Over	Antenna Height	Table Degree	
		MHz	dBuV	dB/m	dBuV/m	dBuV/m	dB	cm	degree	Comment
1	*	4960.000	54.57	-1.10	53.47	74.00	-20.53	peak		

**REMARKS:**

- (1) Measurement Value = Reading Level + Correct Factor.
- (2) Margin Level = Measurement Value - Limit Value.

## APPENDIX E - BANDWIDTH

### DTS Bandwidth

TestMode	Antenna	Channel	DTS BW [MHz]	FL[MHz]	FH[MHz]	Limit[MHz]	Verdict
BLE_1M	Ant1	2402	0.708	2401.652	2402.360	0.5	PASS
		2440	0.708	2439.660	2440.368	0.5	PASS
		2480	0.708	2479.660	2480.368	0.5	PASS

### Test Graphs





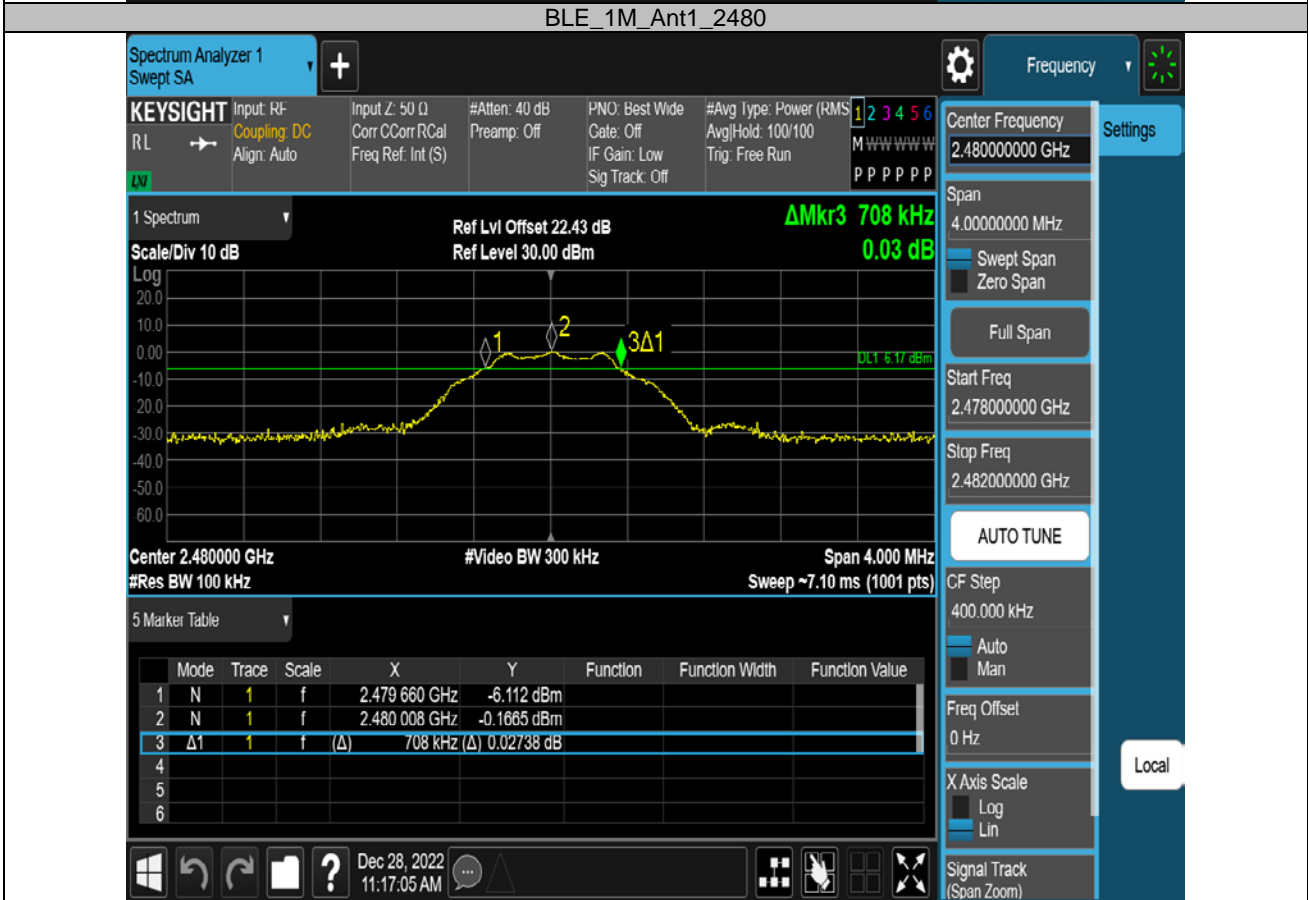

### Occupied Channel Bandwidth

TestMode	Antenna	Channel	OCB [MHz]	FL[MHz]	FH[MHz]	Limit[MHz]	Verdict
BLE_1M	Ant1	2402	1.0754	2401.4802	2402.5556	---	---
		2440	1.0865	2439.4747	2440.5612	---	---
		2480	1.1005	2479.4725	2480.5730	---	---

### Test Graphs

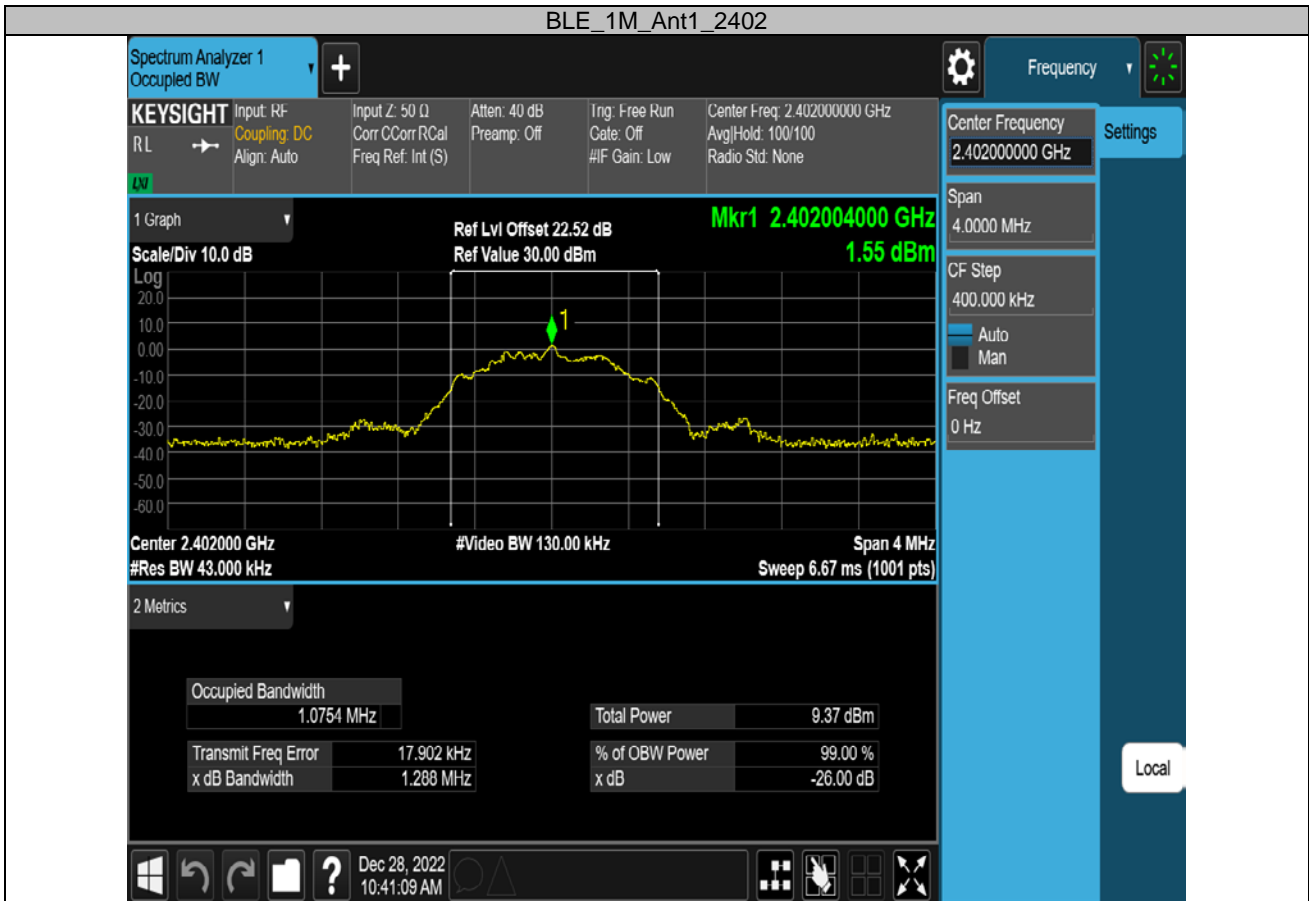

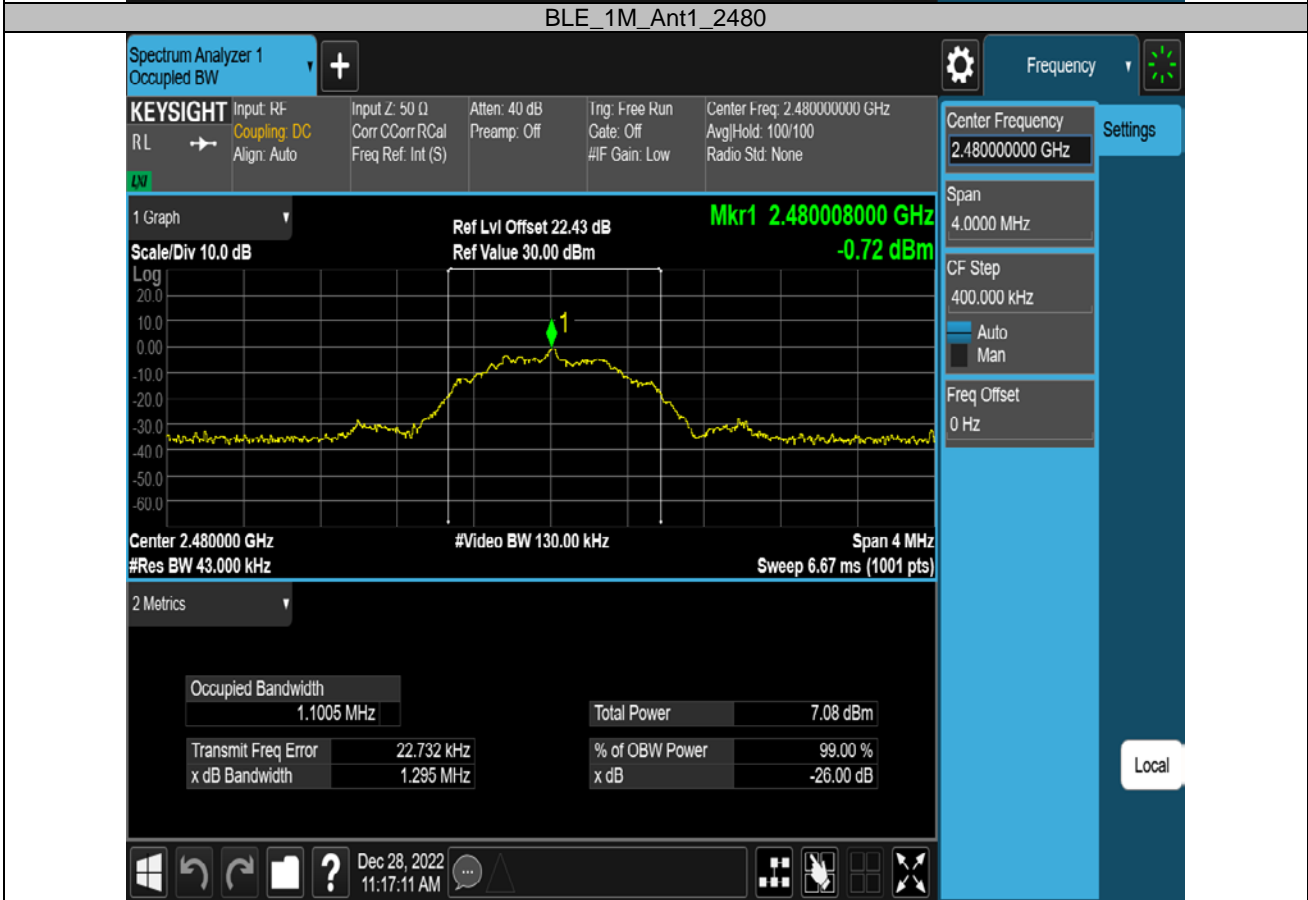
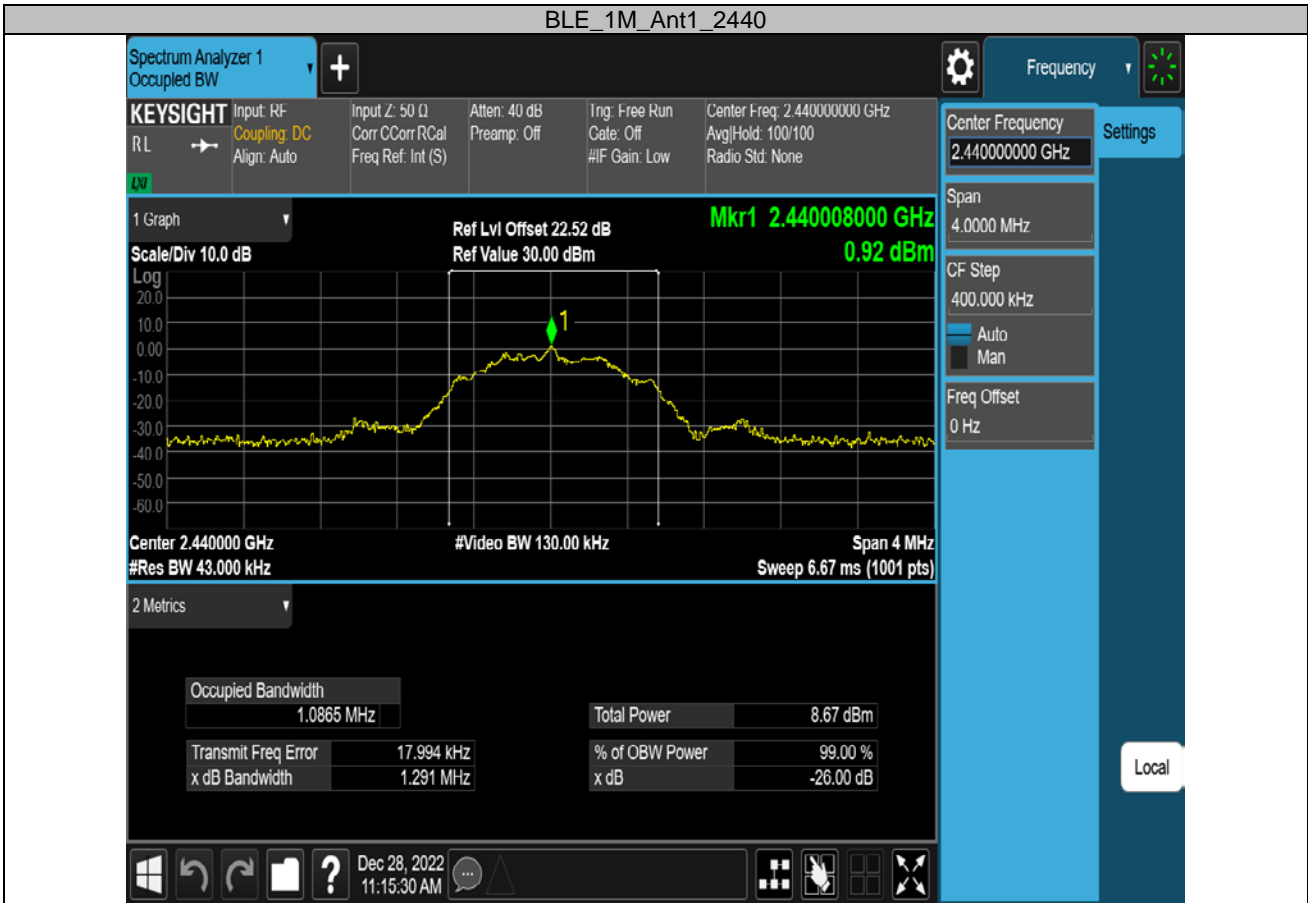

## APPENDIX F - MAXIMUM OUTPUT POWER

TestMode	Antenna	Channel	Conducted Peak Power[dBm]	Conducted Limit[dBm]	Verdict
BLE_1M	Ant1	2402	3.53	≤30	PASS
		2440	2.88	≤30	PASS
		2480	1.56	≤30	PASS

**Test Graphs Peak**

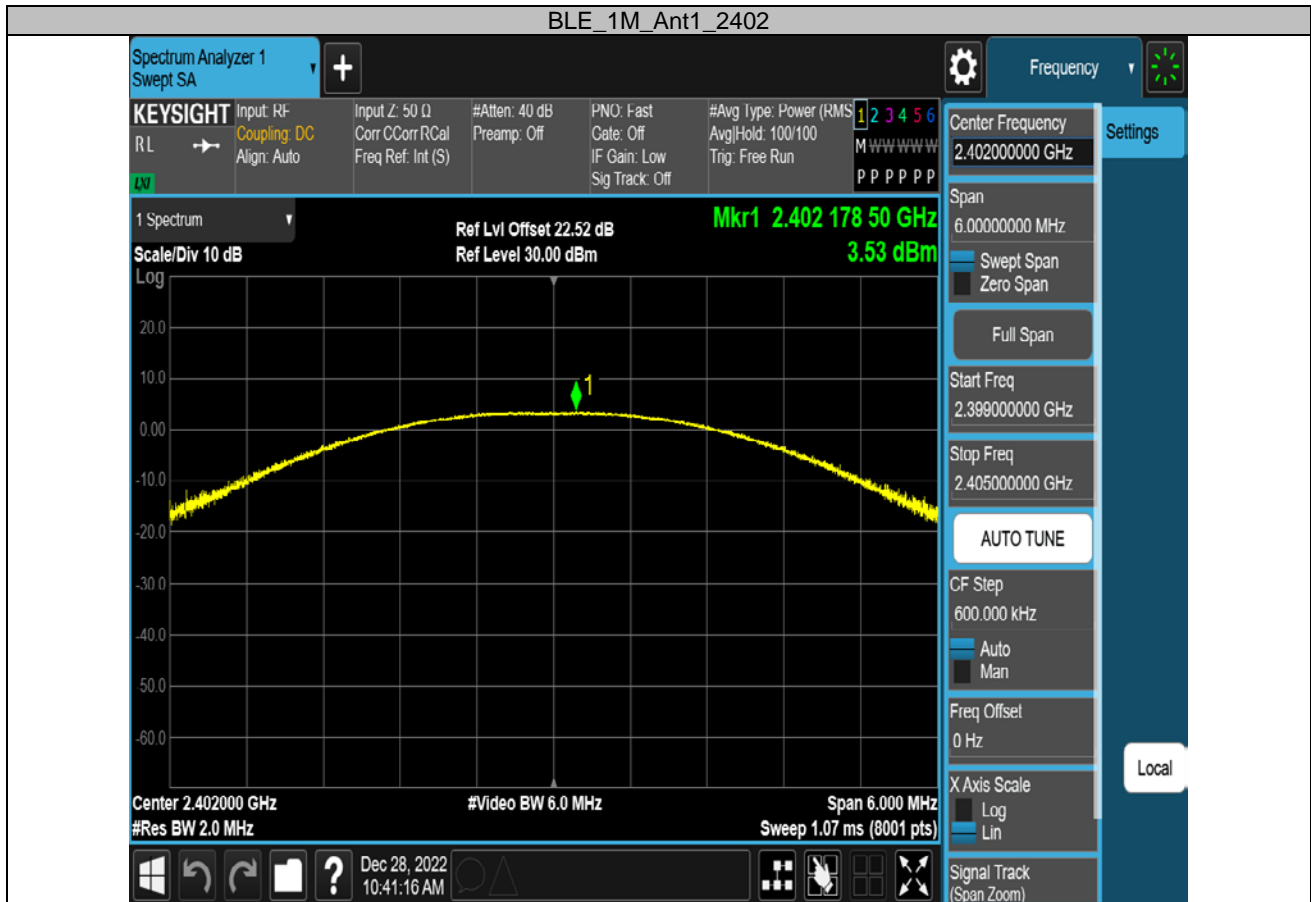

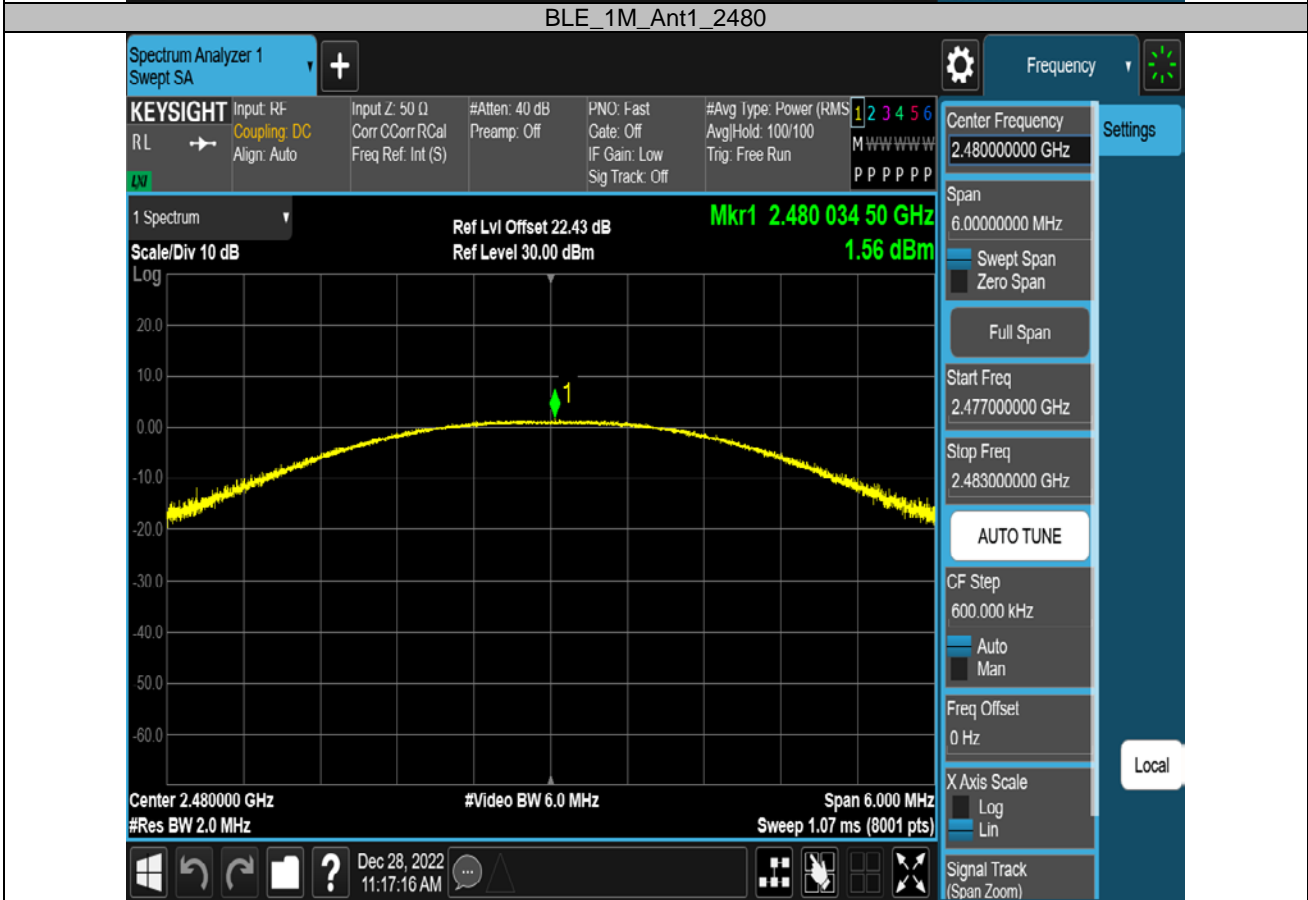
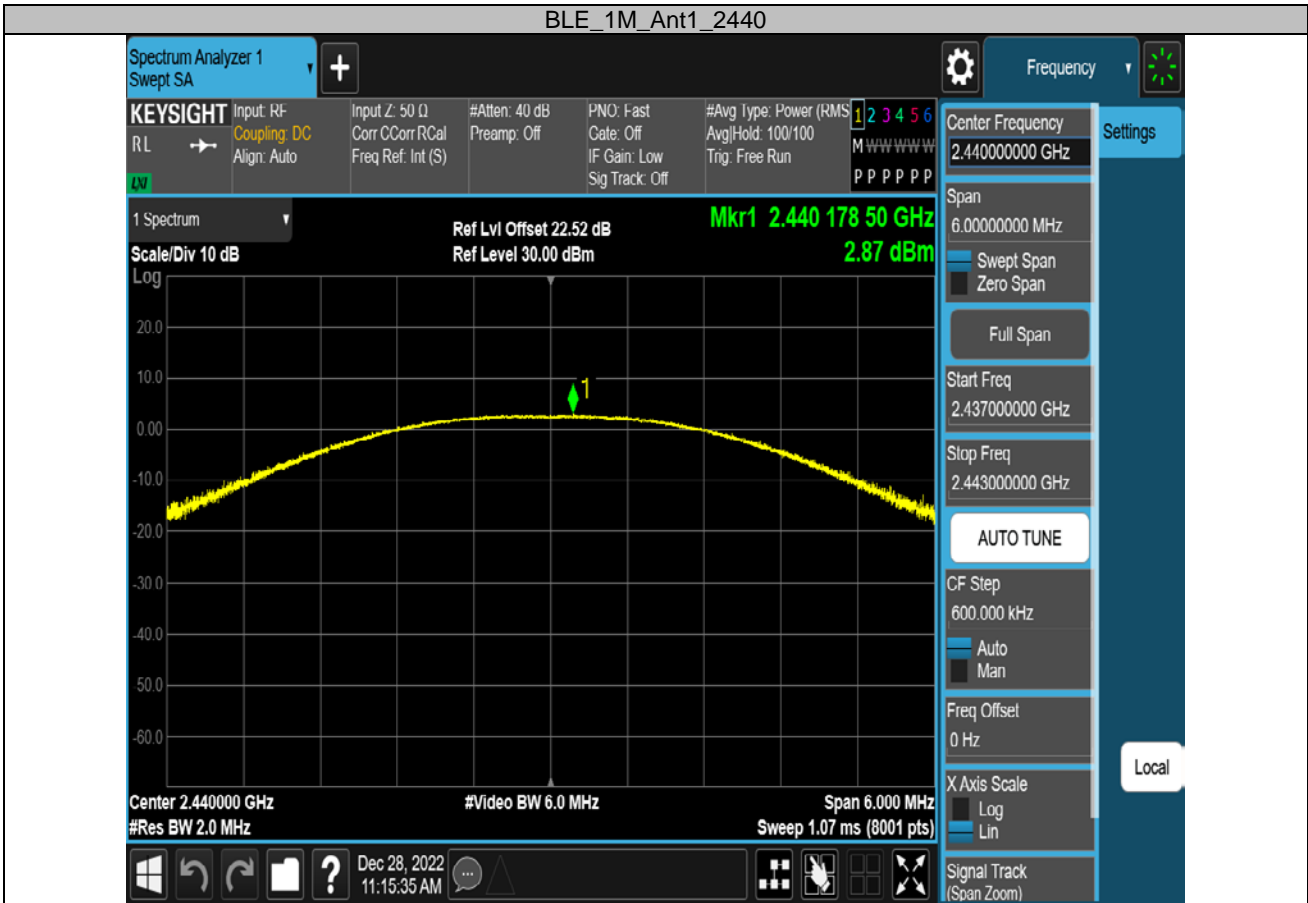

## APPENDIX G - CONDUCTED SPURIOUS EMISSION

TestMode	Antenna	Channel	FreqRange [MHz]	RefLevel [dBm]	Result[dBm]	Limit[dBm]	Verdict
BLE_1M	Ant1	2402	Reference	2.12	2.12	---	PASS
			30~1000	2.12	-57.66	≤-13.11	PASS
			1000~26500	2.12	-49.3	≤-13.11	PASS
		2440	Reference	1.58	1.58	---	PASS
			30~1000	1.58	-57.66	≤-13.56	PASS
			1000~26500	1.58	-49.05	≤-13.56	PASS
		2480	Reference	-0.14	-0.14	---	PASS
			30~1000	-0.14	-57.65	≤-14.16	PASS
			1000~26500	-0.14	-49.22	≤-14.16	PASS

**Test Graphs**

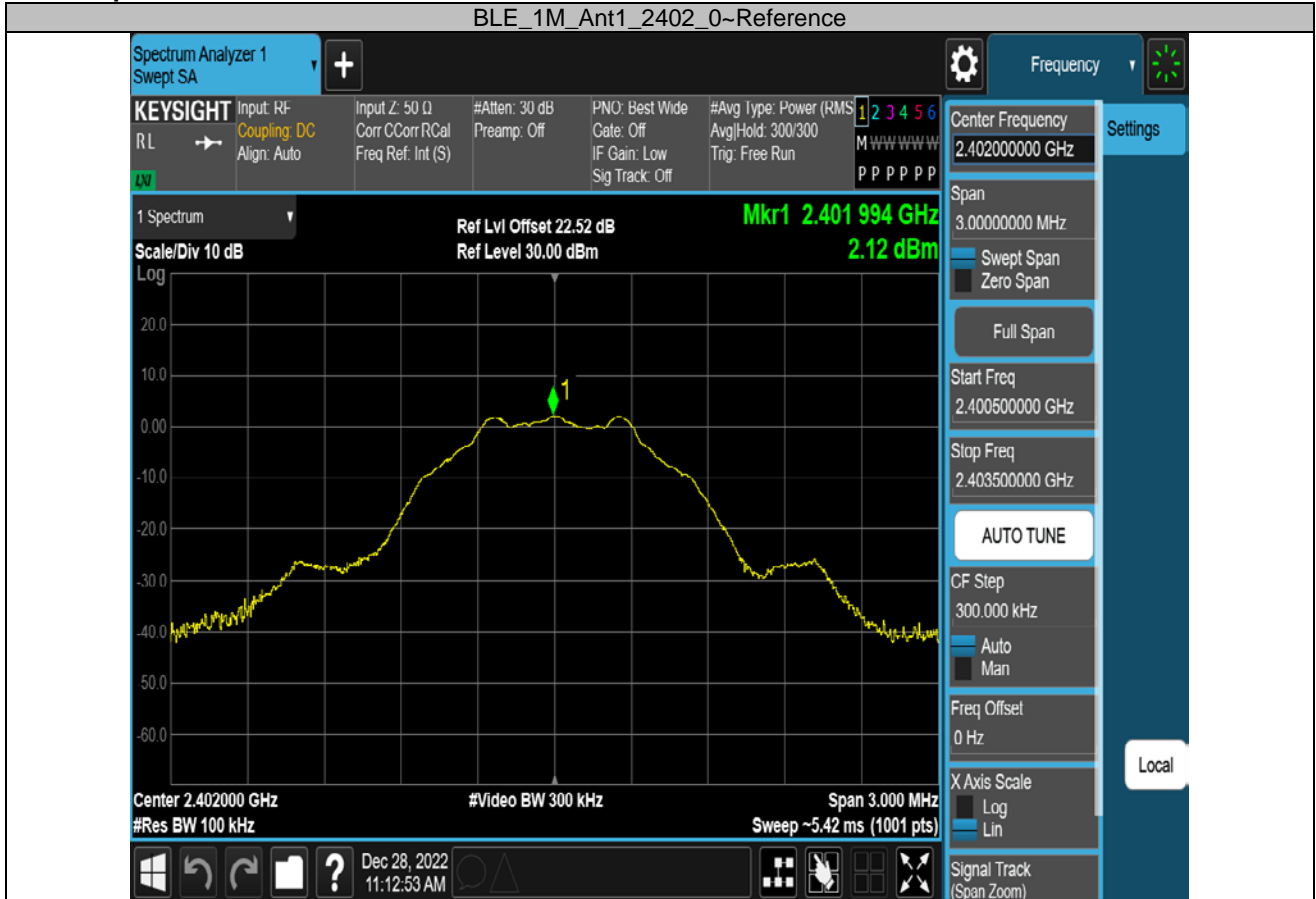



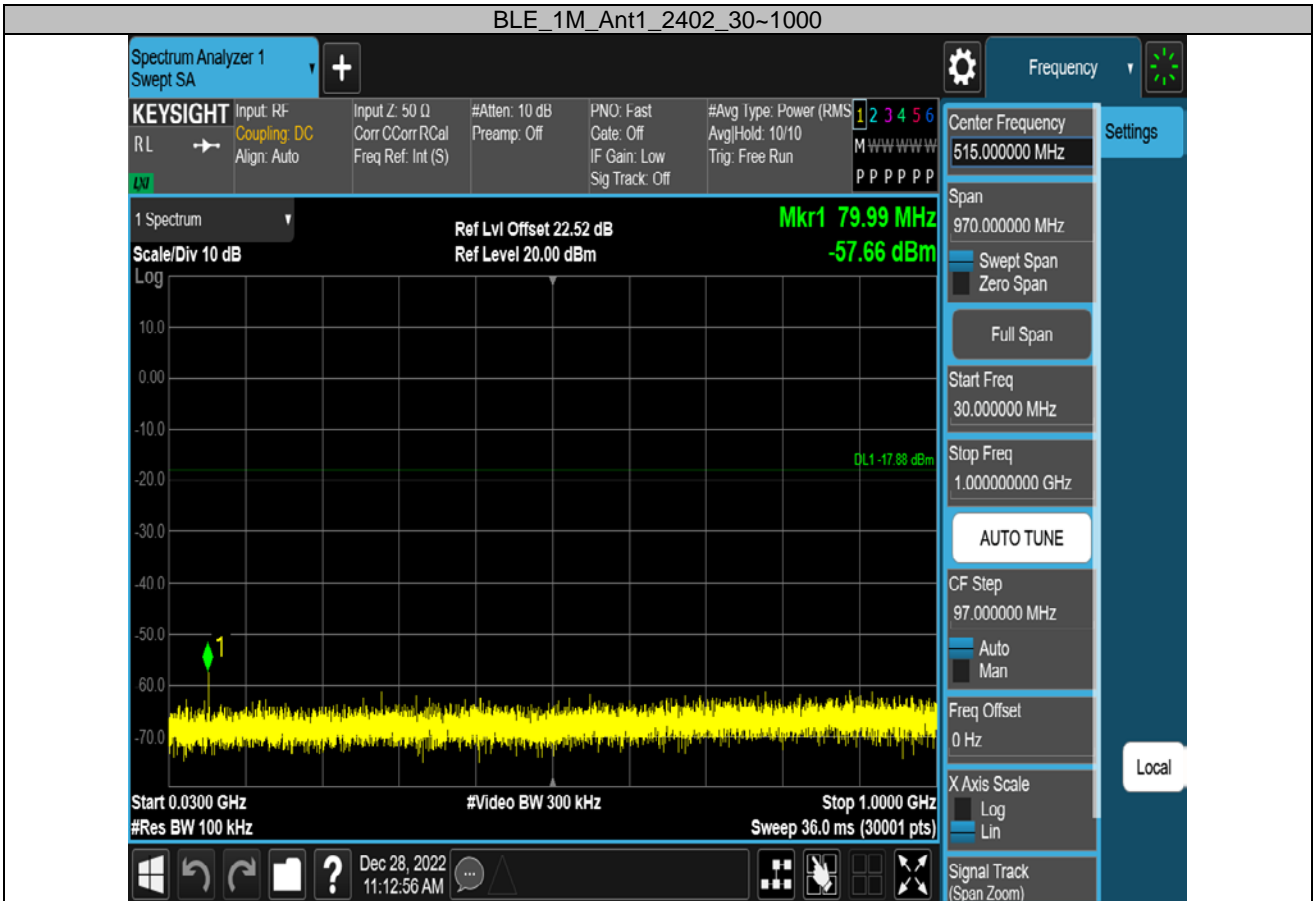

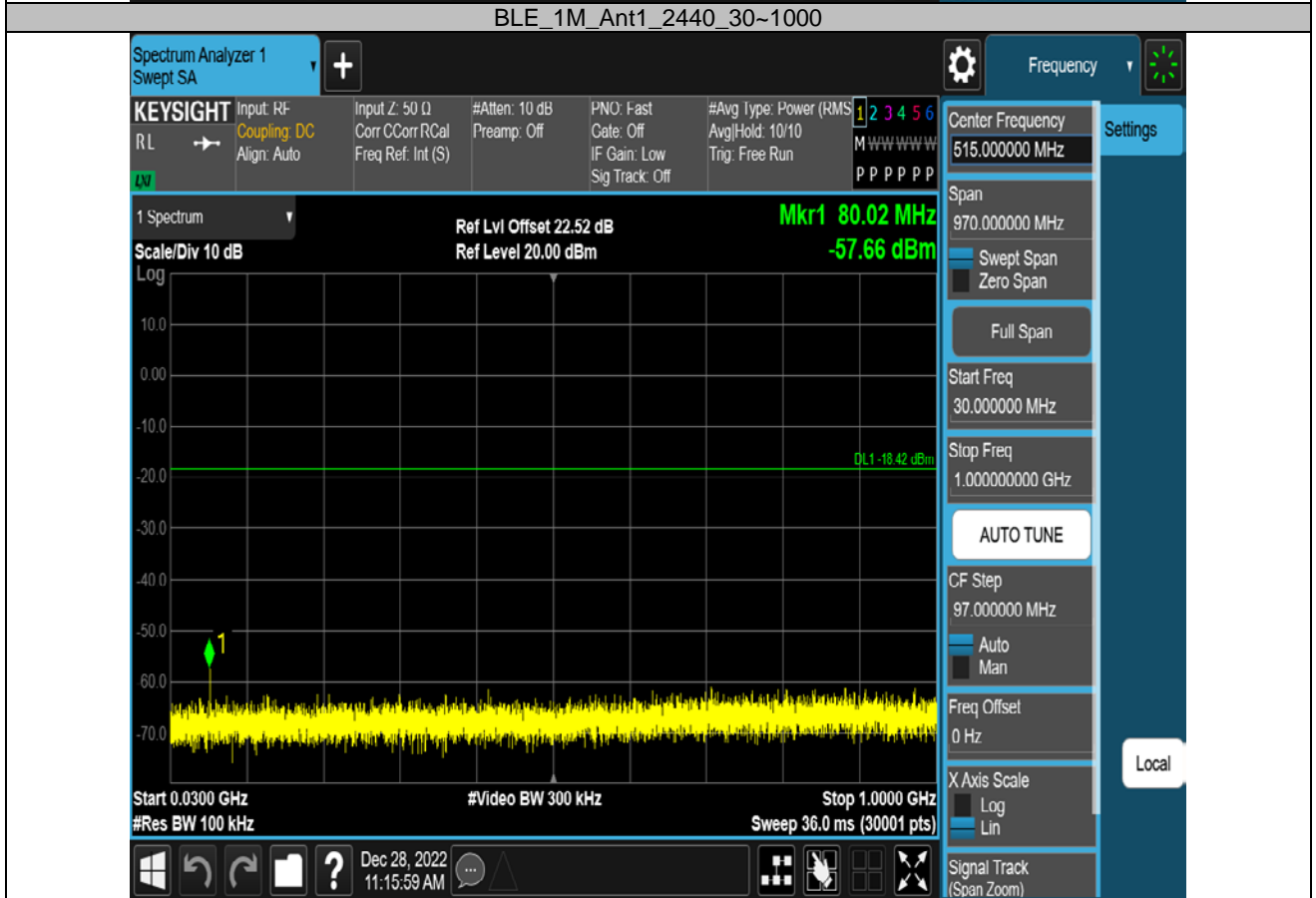
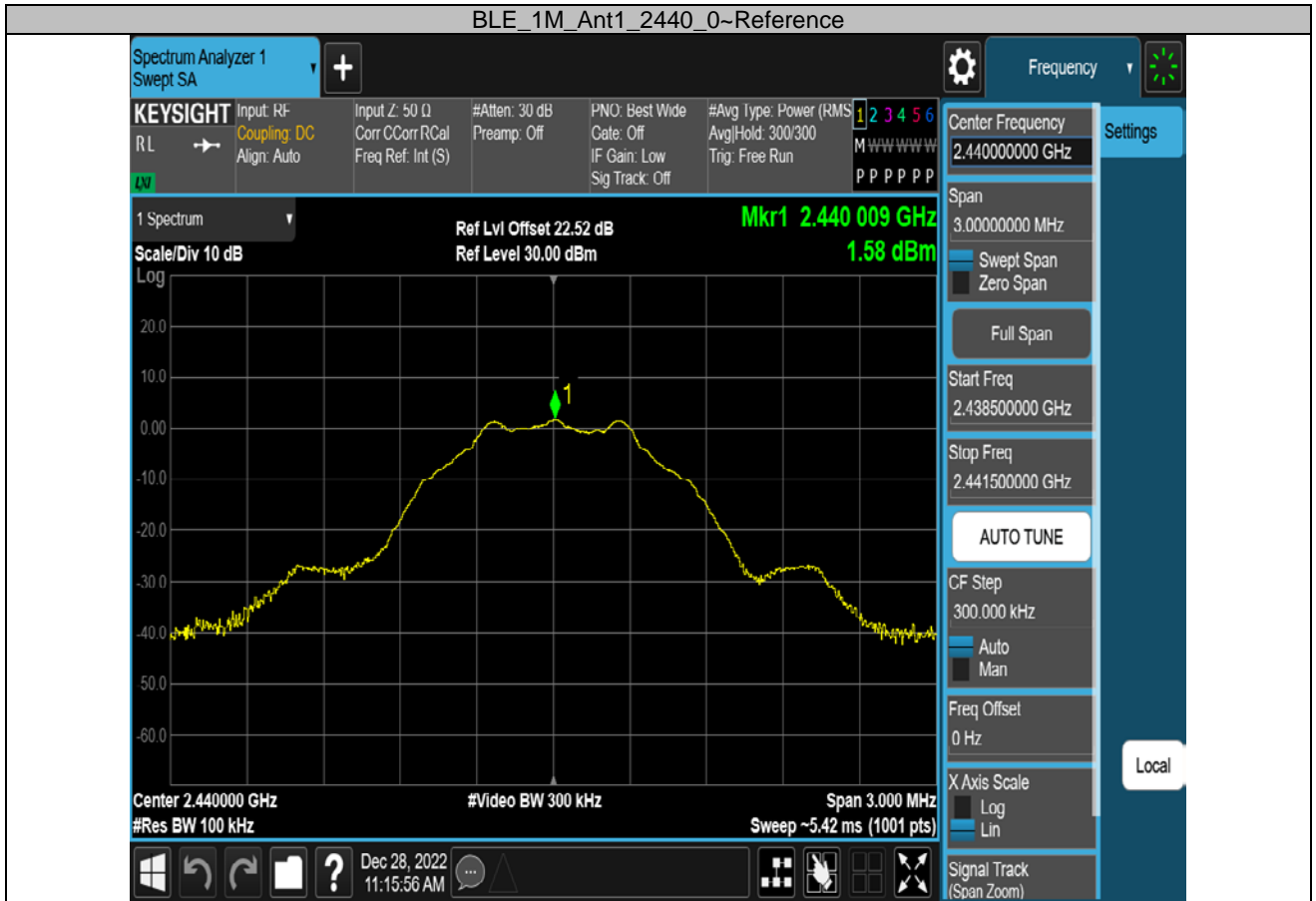



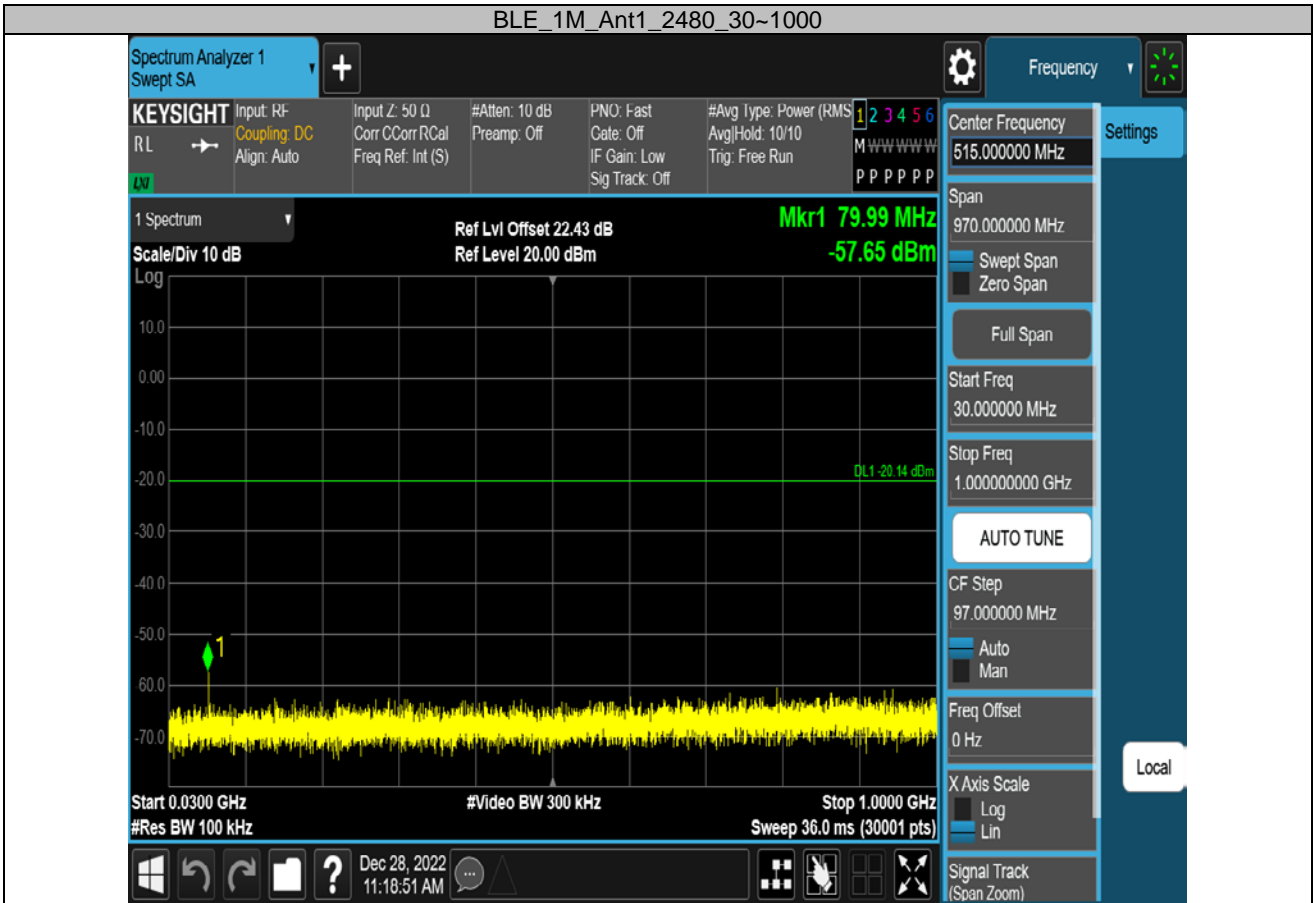

## APPENDIX H - POWER SPECTRAL DENSITY

TestMode	Antenna	Channel	Result[dBm/3kHz]	Limit[dBm/3kHz]	Verdict
BLE_1M	Ant1	2402	-11.38	≤8.00	PASS
		2440	-11.98	≤8.00	PASS
		2480	-13.67	≤8.00	PASS

**Test Graphs**

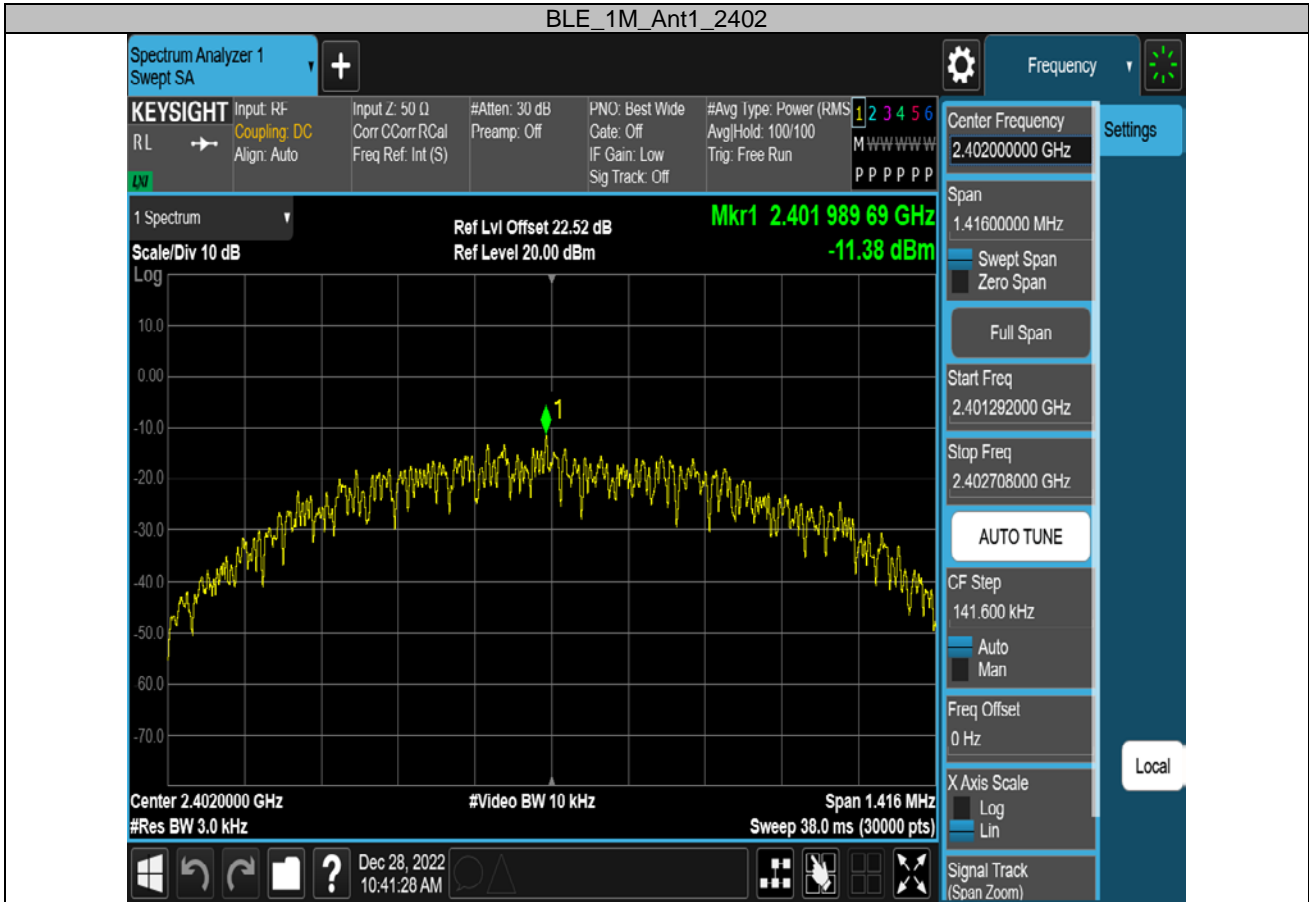

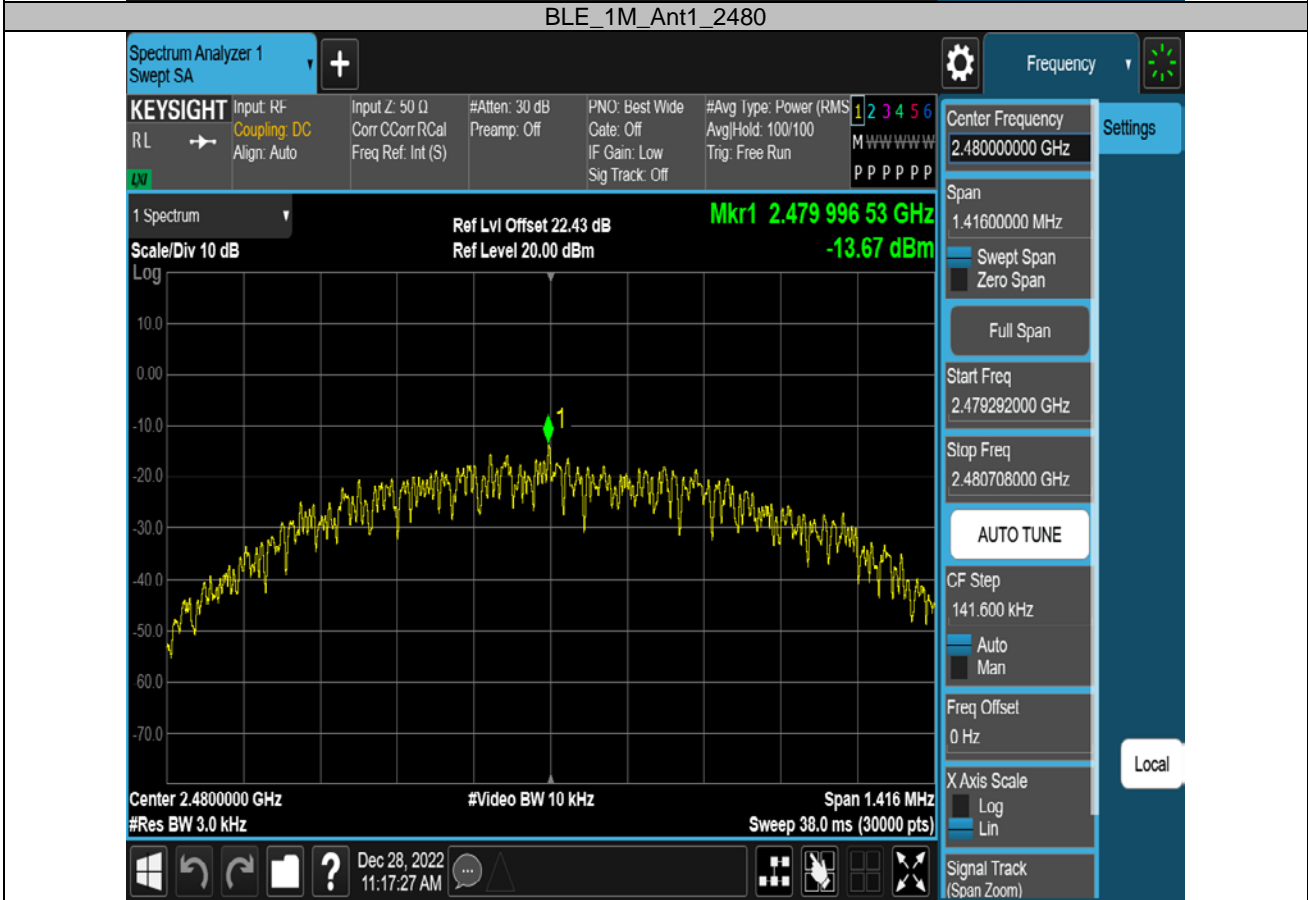
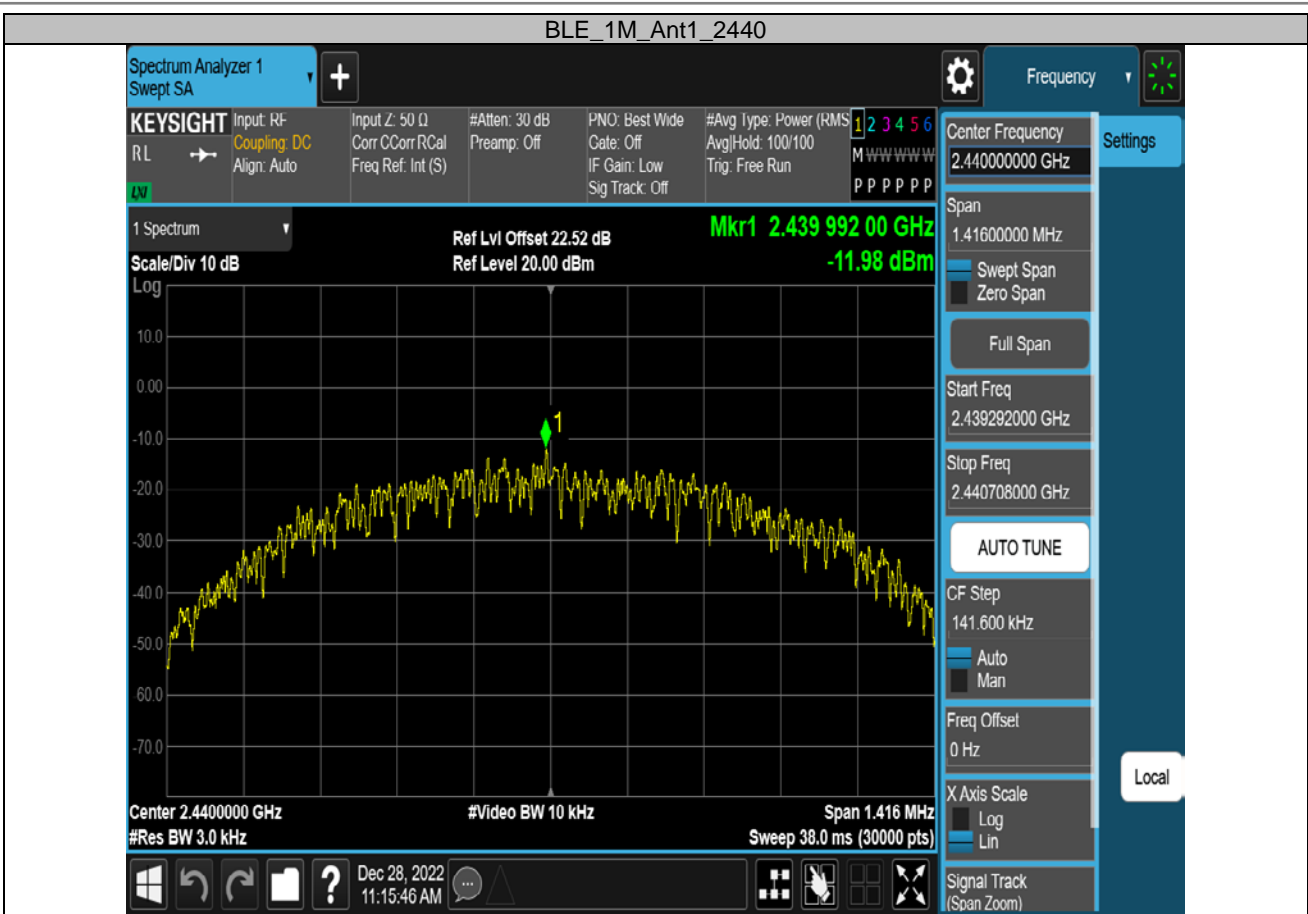

End of Test Report