

Antenna Specification

Specifications

Summary

ITEM	SPEC.	
Model Name	1.9GHz	
Model number	WHB640ANT	
Center Frequency	1880 MHz	2.41dBi
	1900 MHz	2.12dBi
	1930 MHz	1.20dBi
MAX. GAIN	2.41dBi	
Manufacturer	YEALINK(XIAMEN) NETWORK TECHNOLOGY CO.,LTD. No.666 Hu'an Rd. Huli District Xiamen City, Fujian, P.R. China	

Antenna Photo & Length

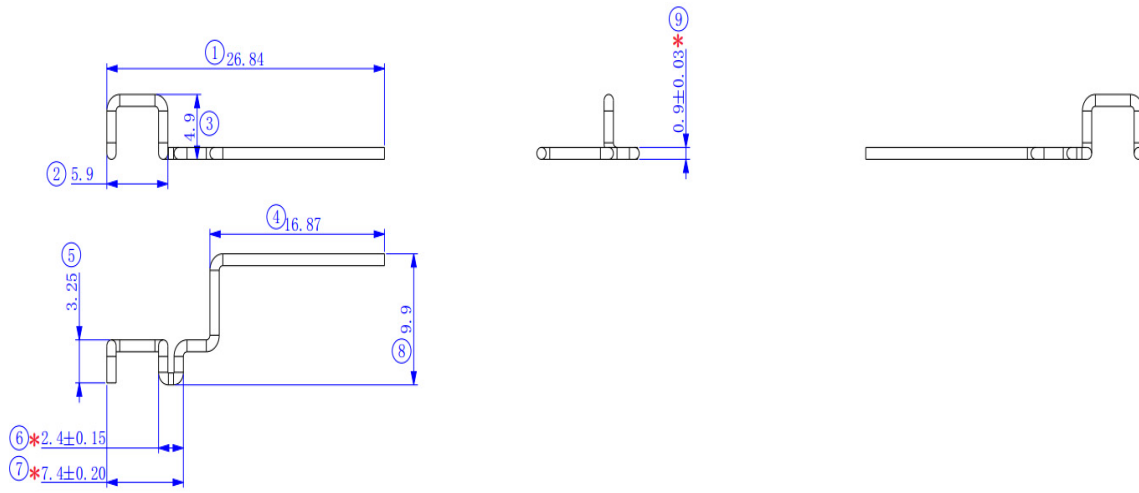

Unit: mm

1880MHz

3D

Total

Azimuth: 0
Elevation: 90
Roll: 90

Zoom Scale

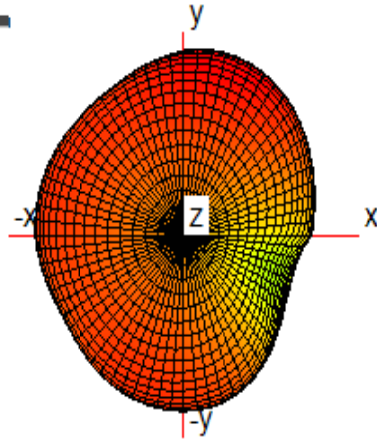

2D (X->Y;X->Z;Y->Z)

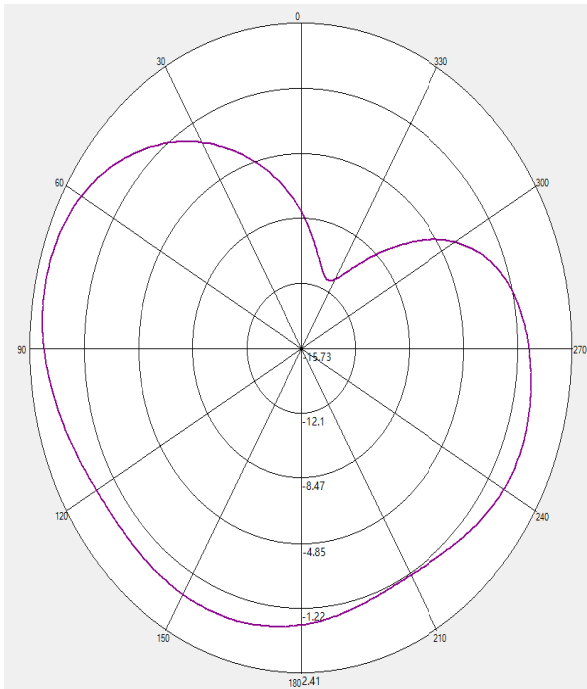



1900MHz

3D

Total

Azimuth: 0

Elevation: 90

Roll: 90

Zoom Scale

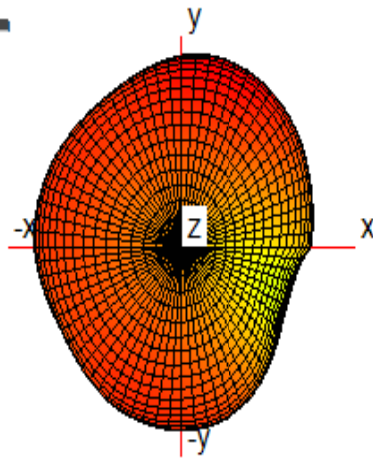

2D (X->Y;X->Z;Y->Z)

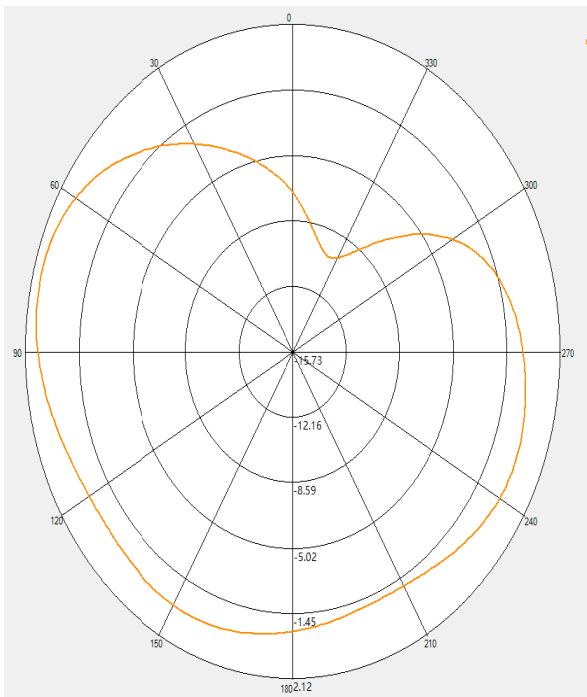

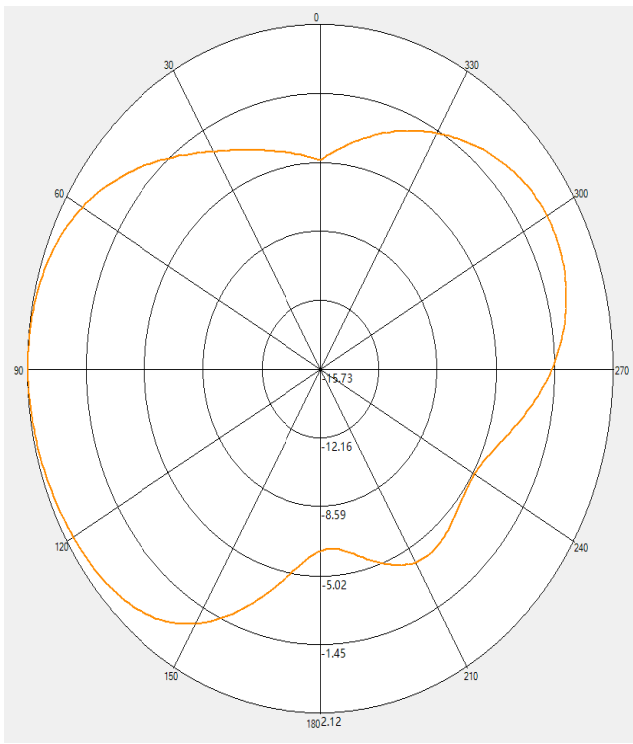
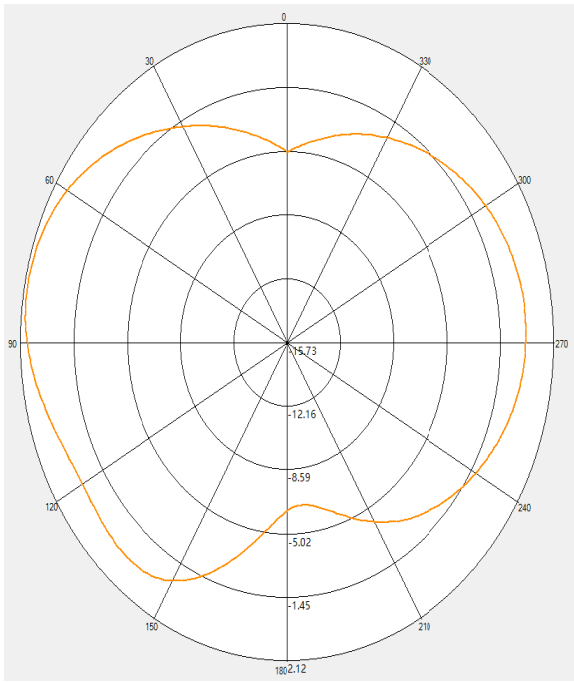

1930MHz

3D

Total

Azimuth: 0
Elevation: 90
Roll: 90

Zoom Scale

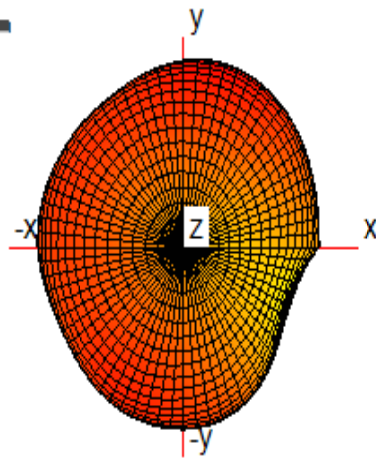

2D (X->Y; X->Z; Y->Z)

