

Yealink

DECT IP Phone W70B&W73H

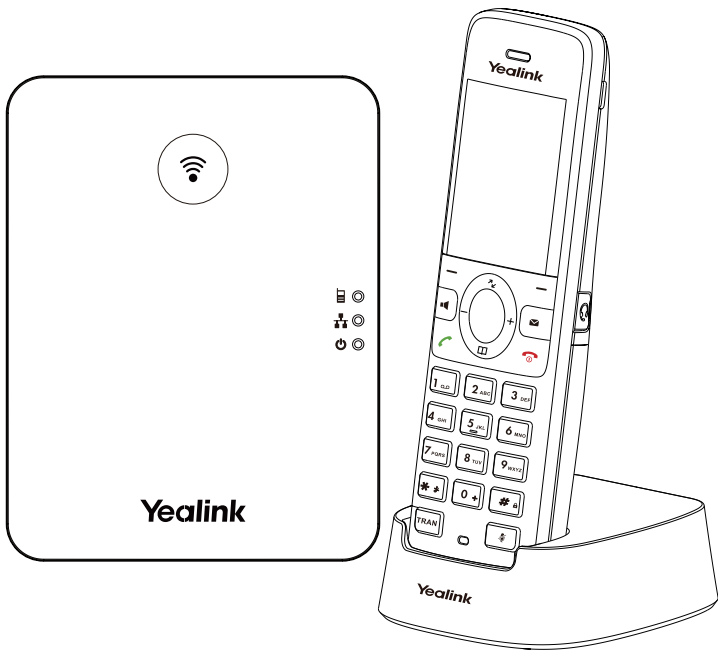

Quick Start Guide(V1.0)

W70B Package Contents



W70B Base Station



Power Adapters



Base Stand

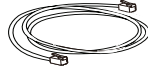

Ethernet Cable

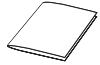

Quick Start Guide

W73H Package Contents



W73H Handset



Battery Cover



Rechargeable Battery

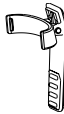

Belt Clip

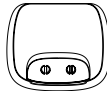

Charging Cradle



Power Adapters



Quick Start Guide

Assembling the DECT Phone

1. Connect the base station power and the network using method a or method b.

a. AC Power Option

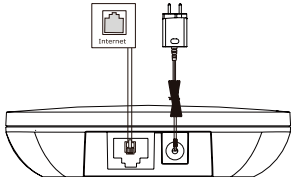

b. PoE (Power over Ethernet) Option

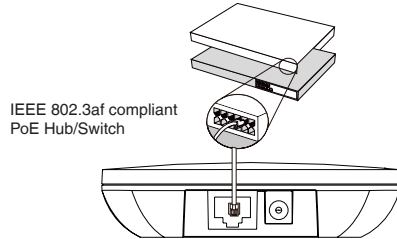

Note:

- If you choose method a, use Yealink supplied power adapter (5V/0.6A). A third-party power adapter may damage the base station.
- If you choose method b, you do not need to connect the power adapter. Make sure the hub/switch is PoE-compliant.

2a. (Desktop Installation) Attach and remove the base stand.

Attach the Base Stand

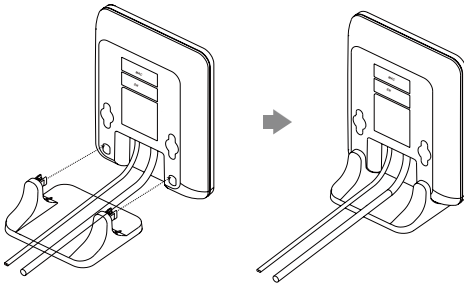

Align the snap-fits with the corresponding holes and push forward, snapping them into the holes.

Remove the Base Stand

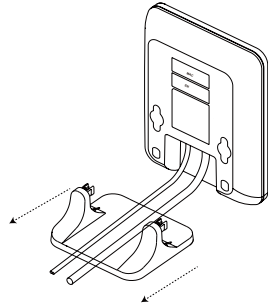

Remove the snap-fits from the holes horizontally.

2b. (Wall-Mount Installation) Attach the base station.

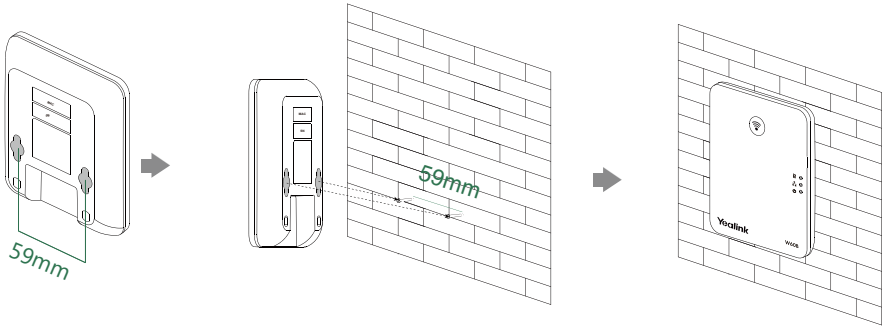

3. Insert the battery into the handset.

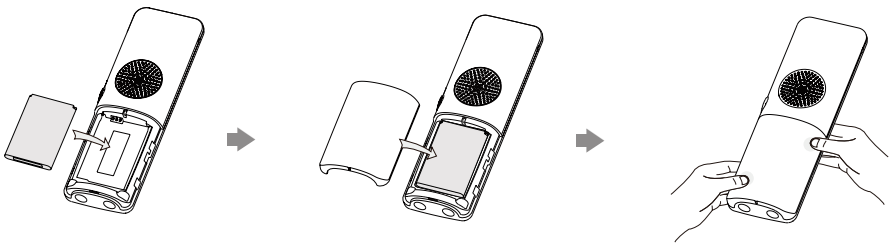

4. Attach the belt clip to the handset.

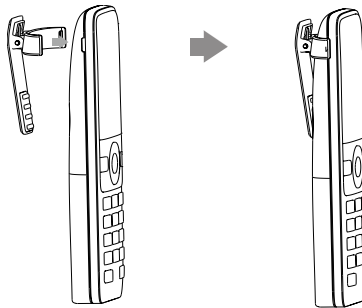

4. (Optional) Mount the charging cradle to the wall.

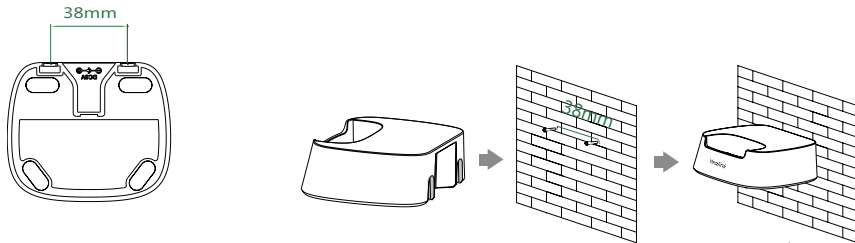

5. Connect the charging cradle and charge the handset.

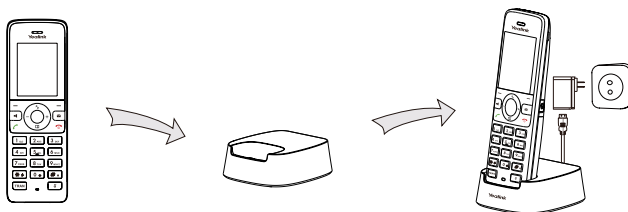

Note:

- Use Yealink-supplied power adapter (5V/0.6A). A third-party power adapter may damage the handset.
- Check the charging status on the top-right corner of the LCD screen.

Hardware Component Instructions

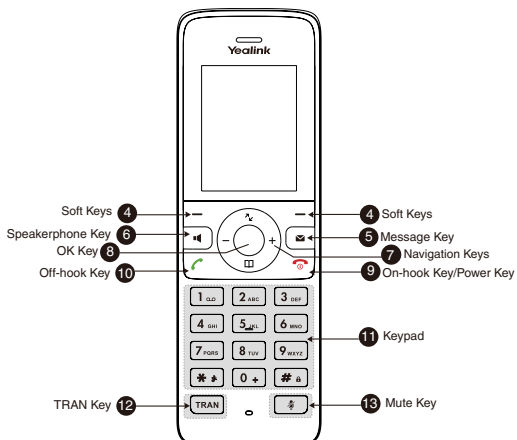

Regulatory Notices

Operating Ambient Temperatures

- Operating temperature: +32 to 104 °F (0 to 40 °C)
- Relative humidity: 5% to 90%, noncondensing
- Storage temperature: -22 to +160 °F (-30 to +70 °C)

Warranty

Our product warranty is limited only to the unit itself, when used normally in accordance with the operating instructions and the system environment. We are not liable for damage or loss resulting from the use of this product, or for any claim from a third party. We are not liable for problems with Yealink device arising from the use of this product; we are not liable for financial damages, lost profits, claims from third parties, etc., arising from the use of this product.

Explanation of the symbols

- DC symbol
- is the DC voltage symbol.
- WEEE Warning symbol



To avoid the potential effects on the environment and human health as a result of the presence of hazardous substances in electrical and electronic equipment, and users of electrical and electronic equipment should understand the meaning of the crossed-out wheeled bin symbol. Do not dispose of WEEE as unsorted municipal waste and have to collect such WEEE separately.

Restriction of Hazardous Substances Directive (RoHS)

This device complies with the requirements of the EU RoHS Directive. Statements of compliance can be obtained by contacting support@yealink.com.

Safety Instructions

Save these instructions. Read these safety instructions before use!



General Requirements

- Before you install and use the device, read the safety instructions carefully and observe the situation during operation.
- During the process of storage, transportation, and operation, please always keep the device dry and clean, avoid collision and crash.
- Please attempt not to dismantle the device by yourself. In case of any discrepancy, please contact the appointed maintenance center for repair.
- Please refer to the relevant laws and statutes while using the device. Legal rights of others should be respected as well.



Environmental Requirements

- Place the device at a well-ventilated place. Do not expose the device under direct sunlight.
- Keep the device dry and free of dusts.
- Do not place the device on or near any inflammable or fire-vulnerable object, such as rubber-mad materials.
- Keep the device away from any heat source or bare fire, such as a candle or an electric heater.



Operating Requirements

- Do not let a child operate the device without guidance.
- Do not let a child play with the device or any accessory in case of accidental swallowing.
- Please use the accessories provided or authorized by the manufacturer only.
- The power supply of the device shall meet the requirements of the input voltage of the device. Please use the provided surge protection power socket only.
- Before plugging or unplugging any cable, make sure that your hands are completely dry.
- Do not spill liquid of any kind on the product or use the equipment near water, for example, near a bathtub, washbowl, kitchen sink, wet basement or near a swimming pool.
- During a thunderstorm, stop using the device and disconnect it from the power supply. Unplug the power plug and the Asymmetric Digital Subscriber Line (ADSL) twisted pair (the radio frequency cable) to avoid lightning strike.
- If the device is left unused for a rather long time, disconnect it from the power supply and unplug the power plug.
- When there is smoke emitted from the device, or some abnormal noise or smell, disconnect the device from the power supply, and unplug the power plug immediately.
- Contact the specified maintenance center for repair.
- Do not insert any object into equipment slots that is not part of the product or auxiliary product.
- Before connecting a cable, correct the grounding cable of the device first. Do not disconnect the grounding cable until you disconnect all other cables.



Battery Requirements

- Do not immerse the battery into water, which could short-circuit and damage the battery.
- Do not expose the battery to an open flame or leave the battery where it could be subjected to extremely high temperatures, which could cause the battery to explode.
- Do power the handset off before removing the battery.
- Do not try to use the battery for the power supply of any device other than this handset.
- Do not open or mutilate the battery, released electrolyte is corrosive and may cause damage to your eyes or skin.
- Use only the rechargeable battery pack delivered with the handset or those rechargeable battery packs expressly recommended by Yealink.
- Defective or exhausted battery should never be disposed of as municipal waste. Return old battery to the battery supplier, a licensed battery dealer or a designated collection facility.



Cleaning Requirements

- Before cleaning the device, disconnect it from the power supply.
- Use a piece of soft, dry and anti-static cloth to clean the device.
- Keep the power plug clean and dry.

Troubleshooting

The unit cannot supply power to Yealink device.

There is a bad connection with the plug.

1. Clean the plug with a dry cloth.
2. Connect it to another wall outlet.

The usage environment is out of operating temperature range.

The cable between the unit and the Yealink device is connected incorrectly.

1. Connect the cable correctly.
 2. You cannot connect the cable properly.
 1. You may have connected a wrong Yealink device.
 2. Use the correct power supply.
- Some dust, etc., may be in the port.
1. Clean the port.

Contact your dealer or authorized service facility for any further questions.

FCC Statement

This device complies with part 15 of the FCC Rules. Operation is subject to the following two conditions: (1) this device may not cause harmful interference, and (2) this device must accept any interference received, including interference that may cause undesired operation.

Any changes or modifications not expressly approved by the party responsible for compliance could void the user's authority to operate the equipment.

IC Statement

This device complies with Industry Canada's licence-exempt RSSs. Operation is subject to the following two conditions:

- (1) this device may not cause interference, and
 - (2) this device must accept any interference, including interference that may cause undesired operation of the device. CAN ICES-3(B)
- Le présent appareil est conforme aux CNR d'Industrie Canada applicables aux appareils radio exempts de licence. L'exploitation est autorisée aux deux conditions suivantes :
- (1) l'appareil ne doit pas produire de brouillage;
 - (2) l'utilisateur de l'appareil doit accepter tout brouillage radioélectrique subi, même si le brouillage est susceptible d'en compromettre le fonctionnement. NMB-3(B)

Radiation Exposure Statement

For Base: This equipment complies with FCC and IC radiation exposure limits set forth for an uncontrolled environment. This equipment should be installed and operated with minimum distance 20cm between the radiator and your body. Cet équipement doit être installé et utilisé avec une distance minimum de 20 centimètres entre le radiateur et votre corps.

For Handset: The device has been tested and comply with FCC and IC SAR limits. L'appareil a été testé et est conforme aux restrictions FCC et IC SAR.

Contact Information

YEALINK NETWORK TECHNOLOGY CO., LTD.
300, 3rd Floor, No.16, Yun Ding North Road, Huli District, Xiamen City, Fujian, P.R.C
YEALINK (EUROPE) NETWORK TECHNOLOGY B.V.
Strawinskylaan 3127, Atrium Building, 8th floor, 1077XZ Amsterdam, The Netherlands
YEALINK (USA) NETWORK TECHNOLOGY CO., LTD.
999 Peachtree Street Suite 2300, Fulton, Atlanta, GA, 30309, USA
Made in China

Note: This equipment has been tested and found to comply with the limits for a Class B digital device, pursuant to part 15 of the FCC Rules.

This device is designed to provide reasonable protection against harmful interference in a residential installation.

The equipment generates, uses and can radiate radio frequency energy and, if not used and/or not according with the instructions, may cause harmful interference to radio communications. However, this does not guarantee that interference will not occur in a particular installation.

If this equipment does cause harmful interference to radio or television reception, which can be determined by turning the equipment off and on, the user is encouraged to try to correct the interference by one or more of the following measures:

- Reorient or relocate the receiving antenna.
- Increase the separation between the equipment and receiver.
- Connect the equipment into an outlet on a circuit different from that to which the receiver is connected.
- Consult the dealer or an experienced radio/TV technician for help.

Privacy of communications may not be ensured when using this telephone

About Yealink

Yealink (Stock Code: 300628) is a global brand that specializes in video conferencing, voice communications and collaboration solutions with best-in-class quality, innovative technology and user-friendly experience. As one of the best providers in more than 140 countries and regions, Yealink ranks No.1 in the global market share of SIP phone shipments (Global IP Desktop Phone Growth Excellence Leadership Award Report, Frost & Sullivan, 2019).

Technical Support

Visit Yealink WIKI (<http://support.yealink.com/>) for firmware downloads, product documents, FAQ, and more. For better service, we sincerely recommend you to use Yealink Ticketing system (<https://ticket.yealink.com/>) to submit all your technical issues.

