

FCC PART 15D
MEASUREMENT AND TEST REPORT

For

Yealink (Xiamen) Network Technology Co., Ltd.

4th-5th Floor, South Building, NO. 63 WangHai Road, 2nd Software Park, Xiamen, China

FCC ID: T2C-W52P

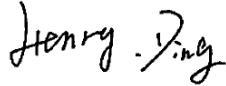
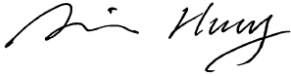
Report Type: Original Report	Product Type: IP DECT Phone (Base Unit)
Test Engineer: Henry Ding	
Report Number: RSZ120919003-00FP	
Report Date: 2012-10-19	
Reviewed By: Alvin Huang RF Leader	
Test Laboratory: Bay Area Compliance Laboratories Corp. (Shenzhen) 6/F, the 3rd Phase of WanLi Industrial Building ShiHua Road, FuTian Free Trade Zone Shenzhen, Guangdong, China Tel: +86-755-33320018 Fax: +86-755-33320008 www.baclcorp.com.cn	

Note: This test report is prepared for the customer shown above and for the device described herein. It may not be duplicated or used in part without prior written consent from Bay Area Compliance Laboratories Corp. (Shenzhen). This report **must not** be used by the customer to claim product certification, approval, or endorsement by NVLAP*, or any agency of the Federal Government.

* This report may contain data that are not covered by the NVLAP accreditation and shall be marked with an asterisk "★"

TABLE OF CONTENTS

GENERAL INFORMATION.....	4
PRODUCT DESCRIPTION FOR EQUIPMENT UNDER TEST (EUT).....	4
OBJECTIVE	4
RELATED SUBMITTAL(S)/GRANT(S).....	4
TEST METHODOLOGY	4
TEST FACILITY	5
SYSTEM TEST CONFIGURATION.....	6
DESCRIPTION OF TEST CONFIGURATION	6
EQUIPMENT MODIFICATIONS	6
LOCAL SUPPORT EQUIPMENT LIST AND DETAILS	6
EXTERNAL I/O CABLE.....	6
BLOCK DIAGRAM OF TEST SETUP	7
SUMMARY OF TEST RESULTS	8
FCC§ 15.319 (I) & 2.1091 - RF RADIATION EXPOSURE	9
LIMIT	9
MPE CALCULATION.....	9
FCC§15.317&§15.203 - ANTENNA REQUIREMENT	10
APPLICABLE STANDARD	10
ANTENNA CONNECTOR CONSTRUCTION	10
FCC§15.315 & §15.207 - CONDUCTED EMISSIONS.....	11
APPLICABLE STANDARD	11
MEASUREMENT UNCERTAINTY	11
EUT SETUP	11
EMI TEST RECEIVER SETUP.....	12
TEST EQUIPMENT LIST AND DETAILS.....	12
TEST PROCEDURE	12
TEST RESULTS SUMMARY.....	12
TEST DATA	12
FCC§15.323 (A) - EMISSION BANDWIDTH.....	15
APPLICABLE STANDARD	15
TEST EQUIPMENT LIST AND DETAILS.....	15
TEST DATA	16
FCC§15.319 (C) - PEAK TRANSMIT POWER.....	18
APPLICABLE STANDARD	18
TEST PROCEDURE	18
TEST EQUIPMENT LIST AND DETAILS.....	18
TEST DATA	19
FCC§15.319 (D) - POWER SPECTRAL DENSITY	21
APPLICABLE STANDARD	21
TEST PROCEDURE	21
TEST EQUIPMENT LIST AND DETAILS.....	21
TEST DATA	21
FCC§15.323 (D) - EMISSION INSIDE AND OUTSIDE THE SUB-BAND.....	26
APPLICABLE STANDARD	26

TEST EQUIPMENT LIST AND DETAILS.....26
 TEST DATA26

FCC§15.319 (G) - RADIATED EMISSIONS.....35

APPLICABLE STANDARD35
 MEASUREMENT UNCERTAINTY35
 EUT SETUP35
 EMI TEST RECEIVER & SPECTRUM ANALYZER SETUP36
 TEST EQUIPMENT LIST AND DETAILS.....36
 TEST PROCEDURE36
 CORRECTED AMPLITUDE & MARGIN CALCULATION36
 TEST RESULTS SUMMARY.....37
 TEST DATA37

FCC§15.323 (F) - FREQUENCY STABILITY.....41

APPLICABLE STANDARD41
 TEST PROCEDURE41
 TEST EQUIPMENT LIST AND DETAILS.....41
 TEST DATA41

FCC§15.323 (C) (E) & §15.319(F) – SPECIFIC REQUIREMENTS FOR UPCS DEVICE.....43

PRODUCT SIMILARITY DECLARATION LETTER.....49

GENERAL INFORMATION

Product Description for Equipment under Test (EUT)

The Yealink (Xiamen) Network Technology Co., Ltd.'s product, model number: W52P (FCC ID: T2C-W52P) (or the "EUT") in this report was a *base unit of IP DECT Phone*, which was measured approximately: 15.5 cm (L) x 11.0 cm (W) x 5.0 cm (H), input voltage: DC 5 V from adapter or PoE 48V power.

Adapter Information: AC/DC SWITCHING ADAPTER
Model: OH-1048A0500600U2
Input: 100-240V~50/60Hz 250mA
Output: 5VDC 600mA

Note: The product IP DECT Phone, the model W52P and W52Duo are different in model number due to different combinations, the base unit of these two models is the same, and W52P was selected to test, which was explained in the attached declaration letter.

** All measurement and test data in this report was gathered from production sample serial number: 1209089 (Assigned by BACL, Shenzhen). The EUT was received on 2012-09-19.*

Objective

This test report was based on the Electromagnetic Interference (EMI) tests performed on the EUT. The EMI measurements were performed according to the measurement procedure described in ANSI C63.17 – 2006 and ANSI C63.4-2009

The tests were performed in order to determine the compliance of the EUT with FCC Part 15-Subpart D, section 15.203, 15.207, 15.315, 15.317, 15.319 and 15.323 rules.

Related Submittal(s)/Grant(s)

Submitted with FCC Part 15D submission of Handset portion with FCC ID: T2C-W52P

Test Methodology

All measurements contained in this report were conducted with ANSI C63.17 - 2006 American National Standard for Methods of Measurement of Radio-Noise Emissions from Low-Voltage Electrical and Electronic Equipment in the range of 9 kHz to 40 GHz. All radiated and conducted emissions measurement was performed at Bay Area Compliance Laboratories Corp. (Shenzhen). The radiated testing was performed at an antenna-to-EUT distance of 3 meters.

Test Facility

The Test site used by Bay Area Compliance Laboratories Corp. (Shenzhen) to collect test data is located on the 6/F, the 3rd Phase of WanLi Industrial Building, ShiHua Road, FuTian Free Trade Zone Shenzhen, Guangdong, China.

Test site at Bay Area Compliance Laboratories Corp. (Shenzhen) has been fully described in reports submitted to the Federal Communication Commission (FCC). The details of these reports have been found to be in compliance with the requirements of Section 2.948 of the FCC Rules on December 06, 2010. The facility also complies with the radiated and AC line conducted test site criteria set forth in ANSI C63.4-2009.

The Federal Communications Commission has the reports on file and is listed under FCC Registration No.: 382179. The test site has been approved by the FCC for public use and is listed in the FCC Public Access Link (PAL) database.

Additionally, Bay Area Compliance Laboratories Corp. (Shenzhen) is an ISO/IEC 17025 accredited laboratory, and is accredited by National Voluntary Laboratory Accredited Program (Lab Code 200707-0).



The current scope of accreditations can be found at <http://ts.nist.gov/Standards/scopes/2007070.htm>

SYSTEM TEST CONFIGURATION

Description of Test Configuration

The EUT was configured for TBR6 mode, which is provided by the manufacturer.

Test mode 1: power by adapter

Test mode 2: power by PoE

Equipment Modifications

No modification was made to the EUT tested.

Local Support Equipment List and Details

Manufacturer	Description	Model	Serial Number
R&S	Digital Radio-Communication Tester	CMD60	829902/026
TP-Link	Router	TL-WR740N	N/A
NETGEAR	PoE	FS108P	1DL2943M003E5

External I/O Cable

Cable Description	Length (m)	From/Port	To
Unshielded Detectable DC Power Cable	1.8	EUT (Base)	Adapter
Unshielded Detectable RJ45 Cable	5.0	EUT (Base)	Router
Unshielded Detectable DC Power Cable	1.8	EUT (Charger)	Adapter

Block Diagram of Test Setup

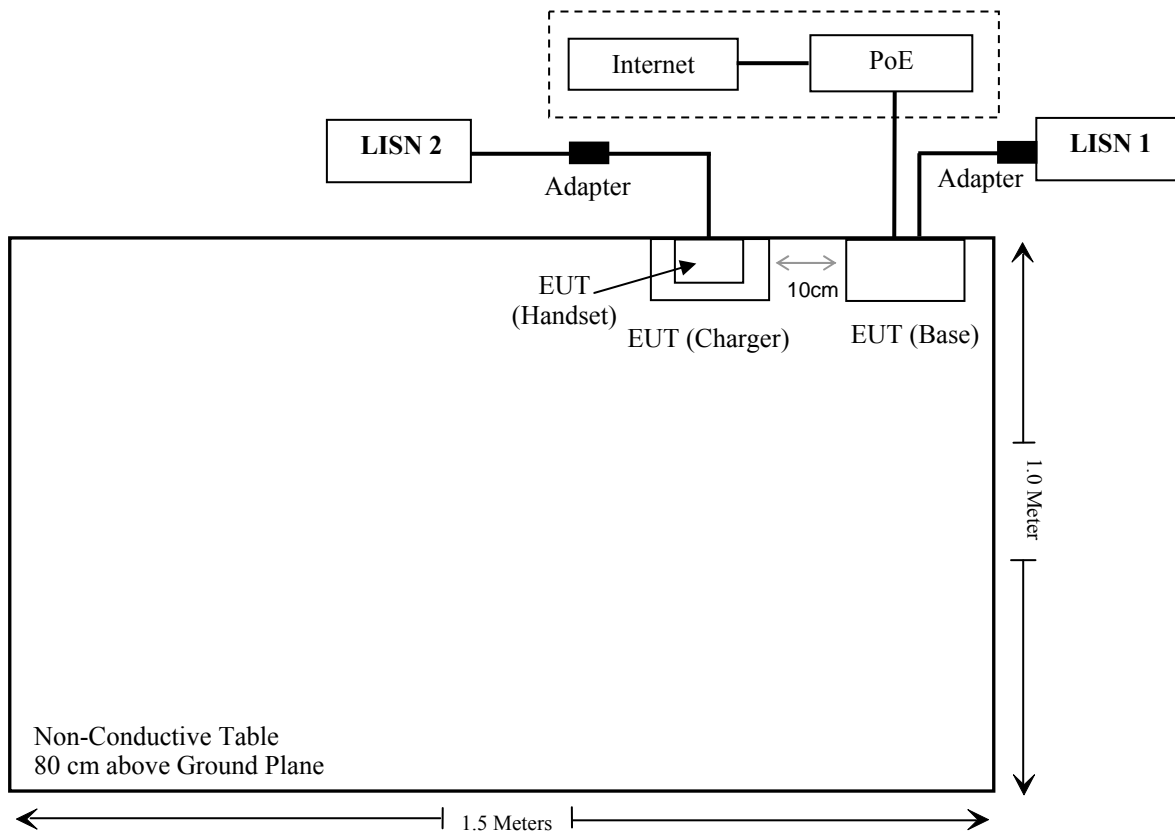

SUMMARY OF TEST RESULTS

FCC Rules	Description of Test	Result
§ 15.319 (i)&2.1091	RF Radiation Exposure	Compliance
§ 15.317 § 15.203	Antenna Requirement	Compliance
§ 15.315 § 15.207	Conducted Emission	Compliance
§ 15.323 (a)	Emission Bandwidth	Compliance
§ 15.319 (c)	Peak Transmit Power	Compliance
§ 15.319 (d)	Power Spectral Density	Compliance
§ 15.323 (d)	Emission Inside and Outside the sub-band	Compliance
§ 15.319 (g)	Radiated Emission	Compliance
§ 15.323 (f)	Frequency Stability	Compliance
§ 15.323 (c)(e) § 15.319 (f)	Specific Requirements for UPCS	Compliance

FCC§ 15.319 (i) &2.1091 - RF RADIATION EXPOSURE

Limit

According to FCC §15.319(i) and §1.1307(b)(1), systems operating under the provisions of this section shall be operated in a manner that ensures that the public is not exposed to radio frequency energy level in excess of the Commission’s guidelines.

Limits for Maximum Permissible Exposure (MPE) (§1.1310, §2.1091)

Frequency Range (MHz)	Electric Field Strength (V/m)	Magnetic Field Strength (A/m)	Power Density (mW/cm ²)	Averaging Time (minute)
Limits for General Population/Uncontrolled Exposure				
0.3-1.34	614	1.63	*(100)	30
1.34-30	842/f	2.19/f	*(180/f ²)	30
30-300	27.5	0.073	0.2	30
300-1500	/	/	f/1500	30
1500-100,000	/	/	1.0	30

f = frequency in MHz

* = Plane-wave equivalent power density

MPE Calculation

Predication of MPE limit at a given distance

$$S = PG/4\pi R^2$$

Where: S = power density (in appropriate units, e.g. mW/cm²);

P = power input to the antenna (in appropriate units, e.g., mW);

G = power gain of the antenna in the direction of interest relative to an isotropic radiator

R = distance to the center of radiation of the antenna (appropriate units, e.g., cm);

Frequency (MHz)	Antenna Gain		Conducted Power		Evaluation Distance (cm)	Power Density (mW/cm ²)	MPE Limit (mW/cm ²)
	(dBi)	(numeric)	(dBm)	(mW)			
1921.536	0	1.0	20.07	101.62	20	0.0202	1
1924.992	0	1.0	20.01	100.23	20	0.0199	1
1928.448	0	1.0	19.96	99.08	20	0.0197	1

Result: The device meets MPE limit at 20 cm distance.

FCC§15.317&§15.203 - ANTENNA REQUIREMENT

Applicable Standard

An intentional radiator shall be designed to ensure that no antenna other than that furnished by the responsible party shall be used with the device. The use of a permanently attached antenna or of an antenna that uses a unique coupling to the intentional radiator shall be considered sufficient to comply with the provisions of this section.

Antenna Connector Construction

This product has two integrated antenna with gain 0 dBi arrangement which was soldered on PCB, fulfill the requirement of this section, and please refer to the internal photos.

Test Result: Pass

FCC§15.315 & §15.207 - CONDUCTED EMISSIONS

Applicable Standard

FCC§15.315 An unlicensed PCS device that is designed to be connected to the public utility (AC) power line must meet the limits specified in §15.207.

Measurement Uncertainty

All measurements involve certain levels of uncertainties, especially in field of EMC. The factors contributing to uncertainties are spectrum analyzer, cable loss, and LISN.

Based on CISPR 16-4-4, The Treatment of Uncertainty in EMC Measurements, the best estimate of the uncertainty of any conducted emissions measurement at Bay Area Compliance Laboratories Corp. (Shenzhen) is 2.4 dB (k=2, 95% level of confidence), and the uncertainty will not be taken into consideration for all the test data recorded in the report.

EUT Setup

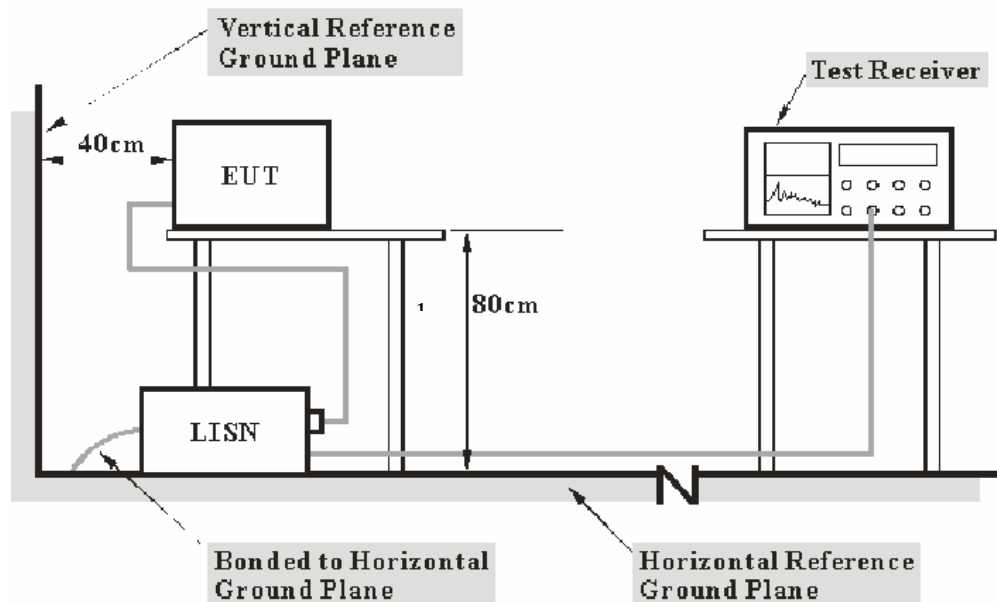

- Note:**
1. Support units were connected to second LISN.
 2. Both of LISNs (AMN) 80 cm from EUT and at the least 80 cm from other units and other metal planes support units.

The setup of EUT is according with per ANSI C63.4-2009 measurement procedure. The specification used was with the FCC 15.315 and FCC 15.207 limits.

The external I/O cables were draped along the test table and formed a bundle 30 to 40 cm long in the middle.

The adapter was connected to a 120 VAC/60 Hz power source.

EMI Test Receiver Setup

The EMI test receiver was set to investigate the spectrum from 150 kHz to 30 MHz.

During the conducted emission test, the EMI test receiver was set with the following configurations:

<i>Frequency Range</i>	<i>IF B/W</i>
150 kHz – 30 MHz	9 kHz

Test Equipment List and Details

Manufacturer	Description	Model	Serial Number	Calibration Date	Calibration Due Date
Rohde & Schwarz	EMI Test Receiver	ESCS30	100176	2011-11-24	2012-11-23
Rohde & Schwarz	L.I.S.N.	ESH2-Z5	892107/021	2011-11-17	2012-11-16
Com-Power	L.I.S.N.	LI-200	12005	N/A	N/A
Rohde & Schwarz	Pulse limiter	ESH3Z2	DE25985	2012-07-08	2013-07-07
BACL	CE Test software	BACL-CE	V1.0	-	-

* **Statement of Traceability:** Bay Area Compliance Laboratories Corp. (Shenzhen) attests that all calibrations have been performed in accordance to NVLAP requirements that traceable to National Primary Standards and International System of Units (SI).

Test Procedure

During the conducted emission test, the adapter was connected to the outlet of the LISN.

Maximizing procedure was performed on the six (6) highest emissions of the EUT.

All data was recorded in the Quasi-peak and average detection mode.

Test Results Summary

According to the recorded data in following table, the EUT complied with the FCC Part 15 .207, with the worst margin reading of:

11.96 dB at 0.400 MHz in the **Line** conducted mode

Test Data

Environmental Conditions

Temperature:	26 °C
Relative Humidity:	56 %
ATM Pressure:	100.0 kPa

The testing was performed by Henry Ding on 2012-10-17.

Test Mode: Talking (Scan with adapter & PoE power supply separately, and worst case data adapter power, as below)

AC 120V/60 Hz, Line

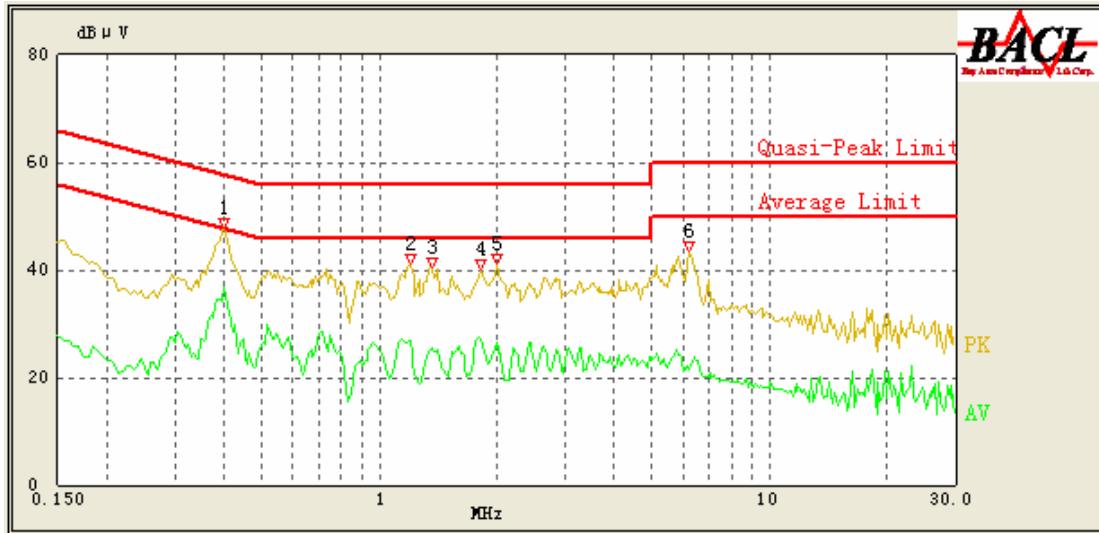

Frequency (MHz)	Corrected Amplitude (dBμV)	Correction Factor (dB)	Limit (dBμV)	Margin (dB)	Detector (PK/Ave./QP)
0.400	36.90	10.25	48.86	11.96	Ave.
0.400	44.27	10.25	58.86	14.59	QP
1.820	27.13	10.19	46.00	18.87	Ave.
1.200	26.77	10.18	46.00	19.23	Ave.
2.010	26.46	10.20	46.00	19.54	Ave.
1.370	25.64	10.18	46.00	20.36	Ave.
1.815	33.84	10.19	56.00	22.16	QP
1.200	33.61	10.18	56.00	22.39	QP
1.370	33.49	10.18	56.00	22.51	QP
2.010	32.64	10.20	56.00	23.36	QP
6.225	21.57	10.34	50.00	28.43	Ave.
6.235	30.59	10.34	60.00	29.41	QP

AC 120V/ 60 Hz, Neutral:

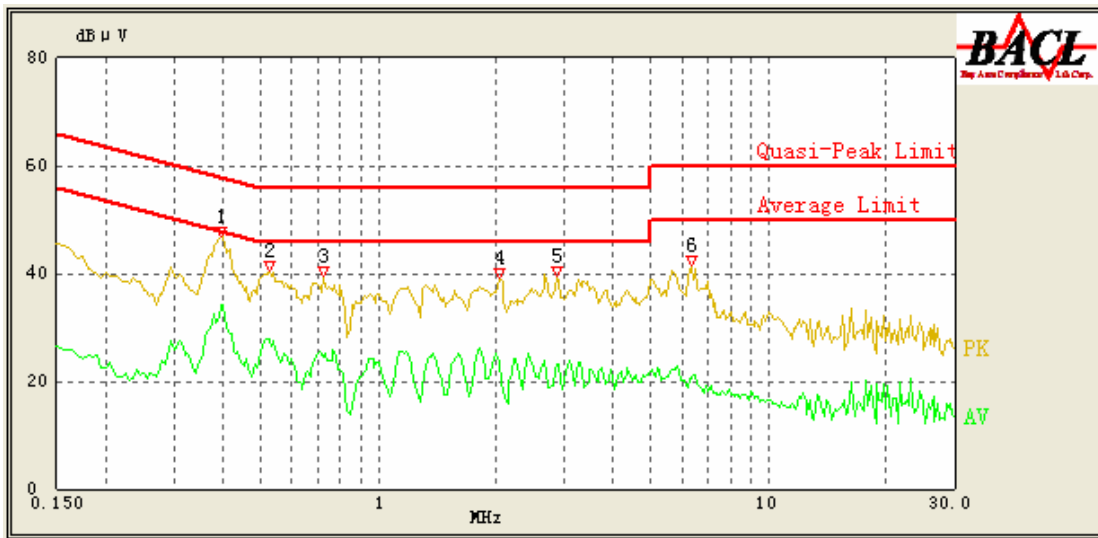

Frequency (MHz)	Corrected Amplitude (dBμV)	Correction Factor (dB)	Limit (dBμV)	Margin (dB)	Detector (PK/Ave./QP)
0.395	34.32	10.25	49.00	14.68	Ave.
0.395	42.74	10.25	59.00	16.26	QP
0.525	27.77	10.24	46.00	18.23	Ave.
0.525	36.21	10.24	56.00	19.79	QP
0.720	34.75	10.21	56.00	21.25	QP
0.725	24.40	10.21	46.00	21.60	Ave.
2.045	23.77	10.20	46.00	22.23	Ave.
2.855	23.29	10.23	46.00	22.71	Ave.
2.040	32.58	10.20	56.00	23.42	QP
2.855	31.00	10.23	56.00	25.00	QP
6.345	30.79	10.34	60.00	29.21	QP
6.335	20.57	10.34	50.00	29.43	Ave.

FCC§15.323 (a) - EMISSION BANDWIDTH

Applicable Standard

Operation shall be contained within the 1920–1930 MHz band. The emission bandwidth shall be less than 2.5 MHz and greater than 50 kHz.

The emission bandwidth is measured in accordance with ANSI C63.17 sub-clause 6.1.3 using the setup below:

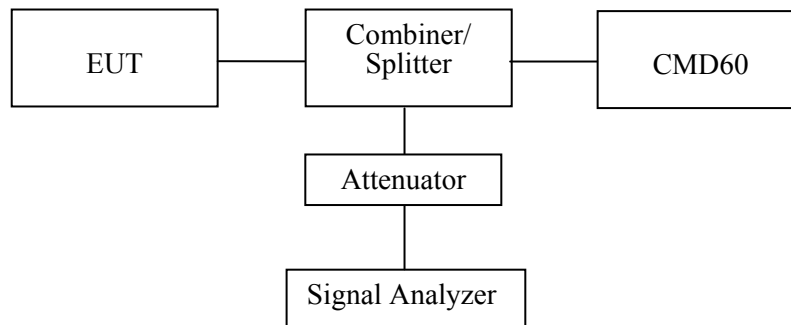

The width, in Hz, of the signal between two points, one below the carrier center frequency and one above the carrier center frequency, that is 26 dB down relative to the maximum level of the modulated carrier. It is based on the use of measurement instrumentation employing a peak detector function with an instrument resolution bandwidth approximately equal to 1% of the emission band-width of the device under measurement. [Extraction from 47 VFR 15, subpart D, 15.303 (C)].

Test Equipment List and Details

Manufacturer	Description	Model	Serial Number	Calibration Date	Calibration Due Date
Rohde & Schwarz	Signal Analyzer	FSIQ26	8386001028	2011-11-24	2012-11-23

* **Statement of Traceability:** Bay Area Compliance Laboratories Corp. (Shenzhen) attests that all calibrations have been performed in accordance to NVLAP requirements that traceable to National Primary Standards and International System of Units (SI).

Test Data

Environmental Conditions

Temperature:	26 °C
Relative Humidity:	56 %
ATM Pressure:	100.0 kPa

The testing was performed by Henry Ding on 2012-10-17.

Test Mode: Transmitting

Channel	Center Frequency (MHz)	26 dB Bandwidth (MHz)	Limit
Low	1921.536	1.371	50kHz < OBW <2.5MHz
Middle	1924.992	1.371	50kHz < OBW <2.5MHz
High	1928.448	1.371	50kHz < OBW <2.5MHz

Test Result: Pass

Refer to the attached plots.

Low Channel

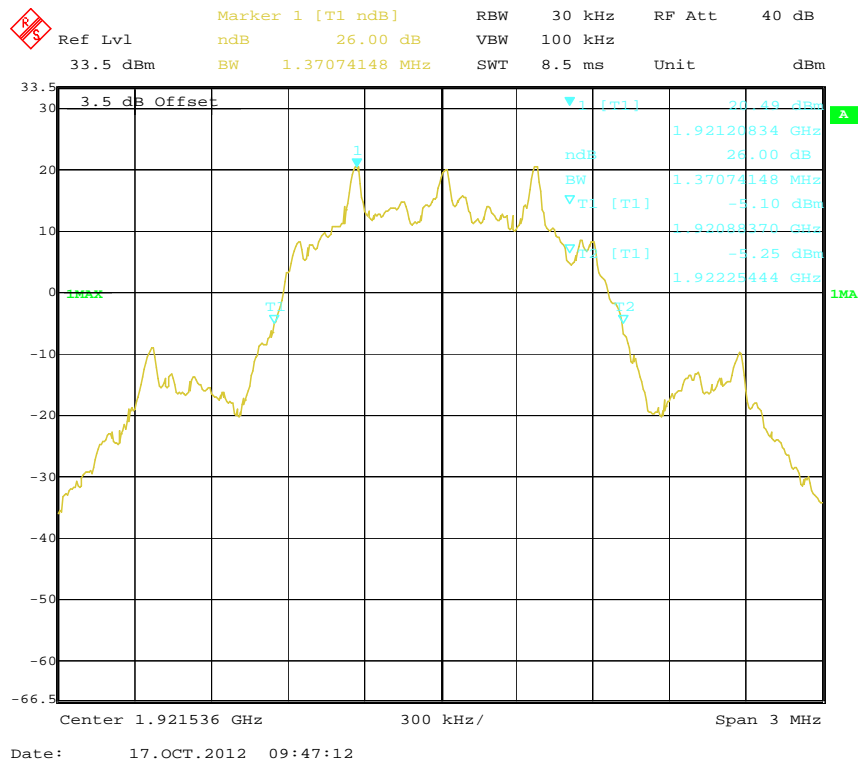

Middle Channel

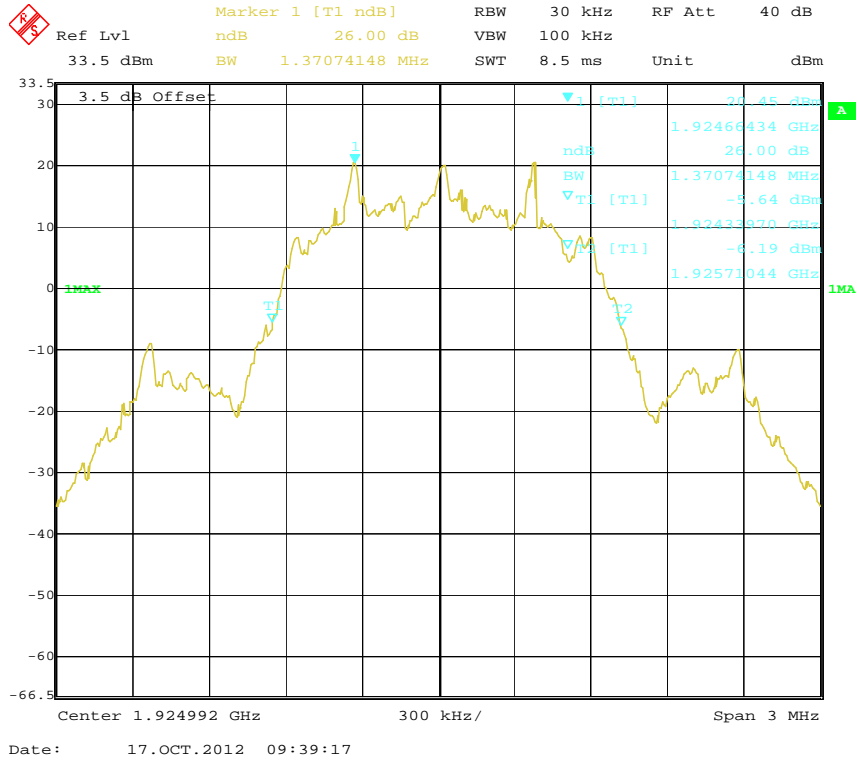

High Channel

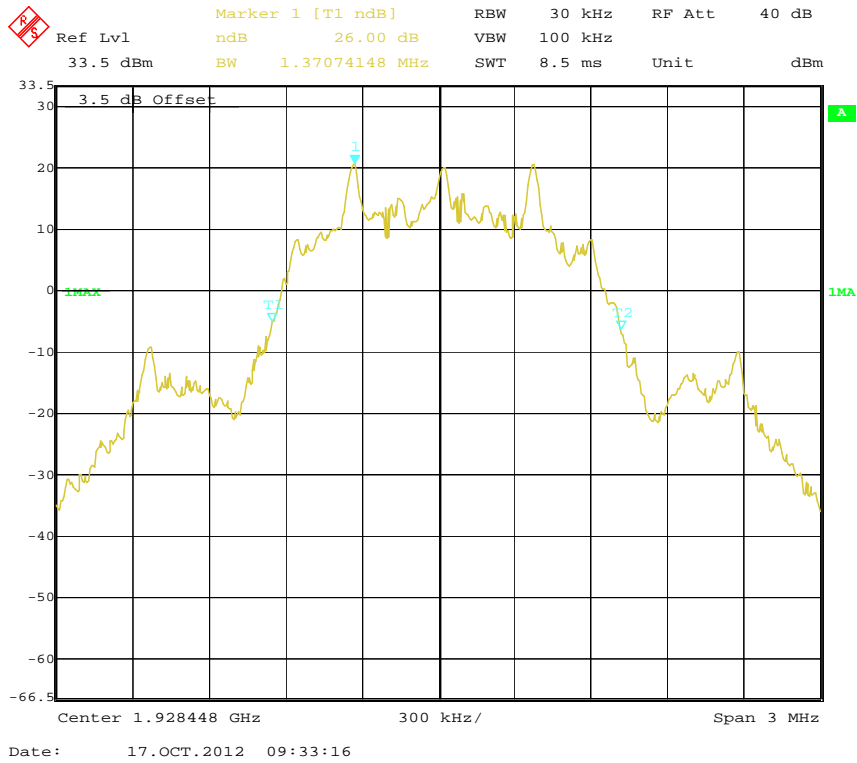

FCC§15.319 (c) - PEAK TRANSMIT POWER

Applicable Standard

The peak transmit power is according to ANSI C63.17-2006 §6.1.2

Per FCC Part15.319 (a), Peak transmit power shall not exceed 100 microwatts multiplied by the square root of the emission bandwidth in hertz.

Per FCC Part15.319 (e), the peak transmit power shall be reduced by the amount in decibels that the maximum directional gain of the antenna exceeds 3 dBi.

Calculation of Peak Transmit Power Limit:

$$\text{Peak Transmit Power Limit} = 100\mu\text{w} \times (\text{EBW})^{1/2}$$

EBW is the transmit emission bandwidth in Hz determined in the other test item:

Test Procedure

Using the manufacturer's information on occupied bandwidth set the spectrum analyzer as follows:

RBW	≥ Emission bandwidth
Video bandwidth	≥ RBW
Span	Zero
Center frequency	Nominal center frequency of channels
Amplitude scale	Log (linear may be used if analyzer has sufficient linear dynamic range and accuracy)
Detection	Peak detection
Trigger	Video
Sweep rate	Sufficiently rapid to permit the transmit pulse to be resolved accurately

Test Equipment List and Details

Manufacturer	Description	Model	Serial Number	Calibration Date	Calibration Due Date
Rohde & Schwarz	Signal Analyzer	FSIQ26	8386001028	2011-11-24	2012-11-23

* **Statement of Traceability:** Bay Area Compliance Laboratories Corp. (Shenzhen) attests that all calibrations have been performed in accordance to NVLAP requirements that traceable to National Primary Standards and International System of Units (SI).

Test Data

Environmental Conditions

Temperature:	26 °C
Relative Humidity:	56 %
ATM Pressure:	100.0 kPa

The testing was performed by Henry Ding on 2012-10-17.

Test Result: Pass

Please refer to the attached plots.

Channel	Frequency (MHz)	Peak Transmit Power (dBm)	Limit (dBm)
Low	1921.536	20.07	20.69
Middle	1924.992	20.01	20.69
High	1928.448	19.96	20.69
EBW = 1371000 Hz, Peak Transmit Power Limit = $100\mu\text{W} \times (\text{EBW})^{1/2} = 20.69$			

Low Channel

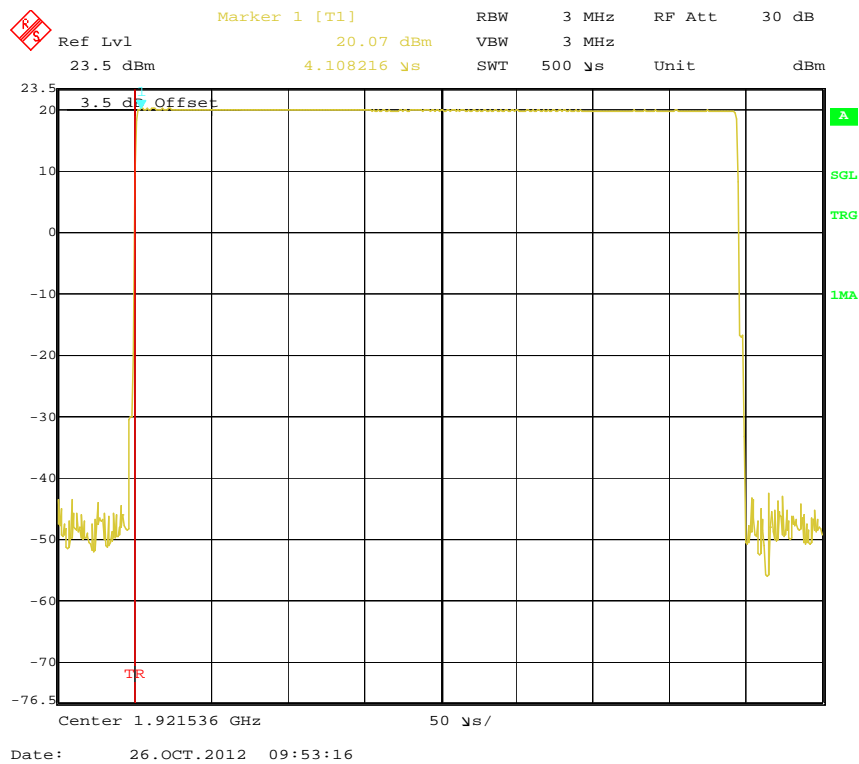

Middle Channel

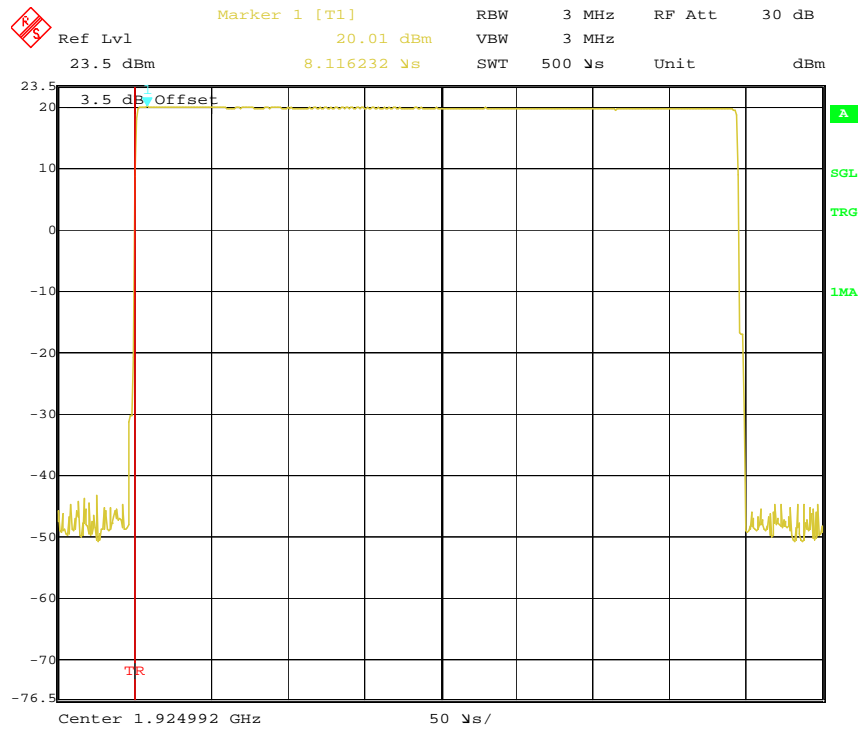

High Channel

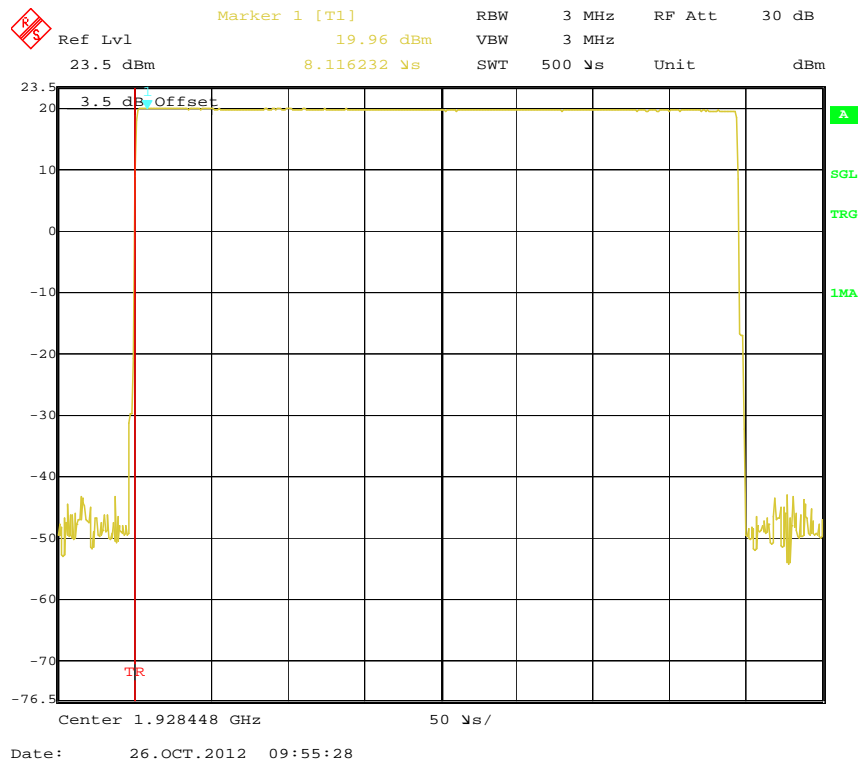

FCC§15.319 (d) - POWER SPECTRAL DENSITY

Applicable Standard

The power spectral density is according to ANSI C63.17-2006 §6.1.5

The average pulse energy in a 3 kHz bandwidth is divided by the pulse duration.

The power spectral density shall not exceed 3mW in any 3 kHz bandwidth as measured with a spectrum analyzer having a resolution bandwidth of 3 kHz.

Test Procedure

Using the manufacturer's information on occupied bandwidth set the spectrum analyzer as follows:

RBW	3 kHz
Video bandwidth	$\geq 3 \times \text{RBW}$
Span	Zero span at frequency with the maximum level (frequency determined in 6.1.3 if the same type of signal (continuous versus burst) was used in 6.1.3)
Center frequency	Spectral peak as determined in 6.1.3
Sweep time	For burst signals, sufficient to include essentially all of the maximum length burst at the output of a 3 kHz filter (e.g., maximum input burst duration plus 600 μs). For continuous signals, 20 ms.
Amplitude scale	Log power
Detection	Sample detection and averaged for a minimum of 100 sweeps
Trigger	External or internal

Test Equipment List and Details

Manufacturer	Description	Model	Serial Number	Calibration Date	Calibration Due Date
Rohde & Schwarz	EMI Test Receiver	ESCI	101122	2012-08-08	2013-08-07

* **Statement of Traceability:** Bay Area Compliance Laboratories Corp. (Shenzhen) attests that all calibrations have been performed in accordance to NVLAP requirements that traceable to National Primary Standards and International System of Units (SI).

Test Data

Environmental Conditions

Temperature:	26 °C
Relative Humidity:	56 %
ATM Pressure:	100.0 kPa

The testing was performed by Henry Ding on 2012-10-17.

Test Mode: Transmitting

Test Result: Compliance. Please refer to following tables and plots.

Frequency (MHz)	Power Spectral Density		Limit (mW/3 kHz)	Result
	(dBm/3 kHz)	(mW/3 kHz)		
1921.536	-4.39	0.364	3	Pass
1924.992	-4.40	0.363	3	Pass
1928.448	-3.03	0.498	3	Pass

Low Channel

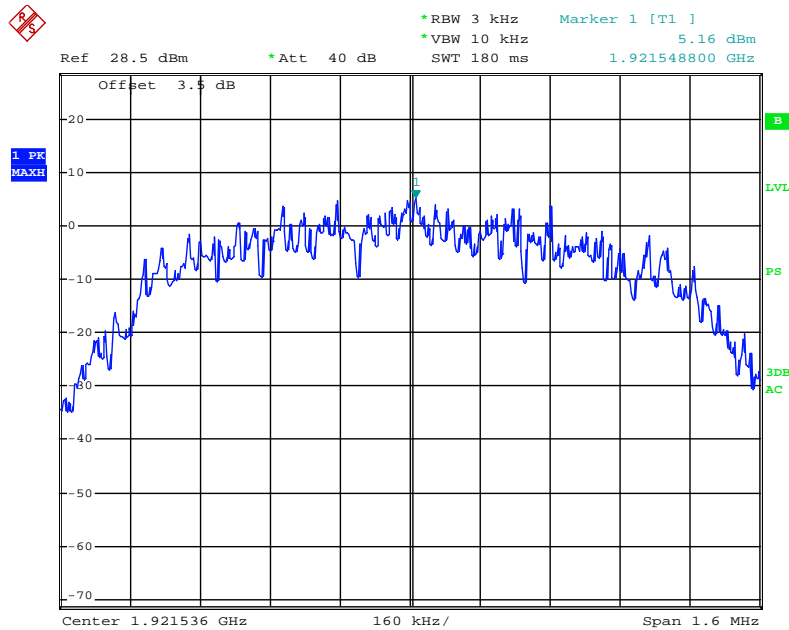

Date: 17.OCT.2012 08:26:45

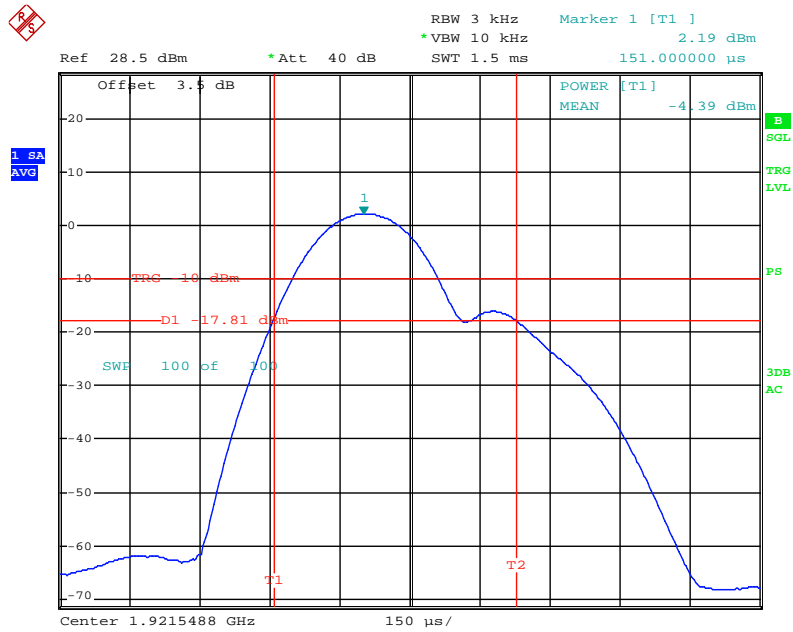

Date: 17.OCT.2012 08:30:38

Middle Channel

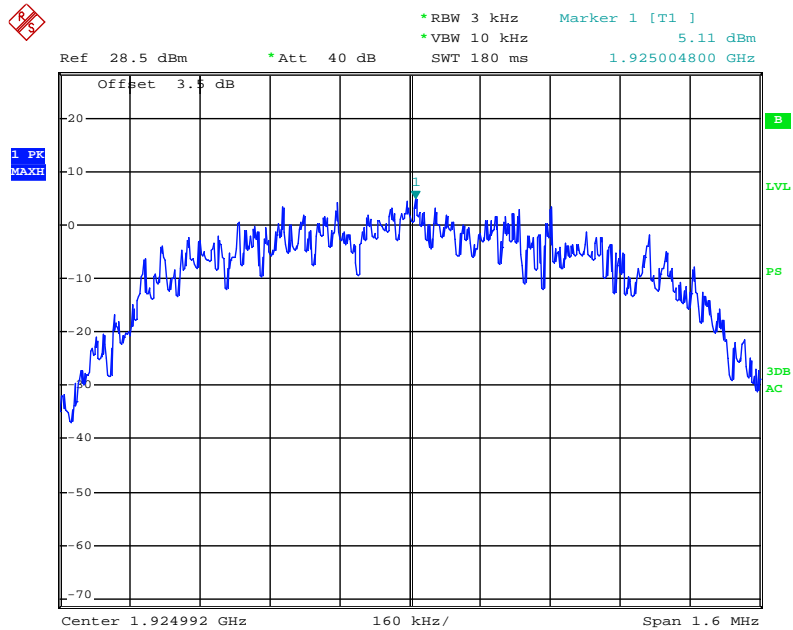

Date: 17.OCT.2012 08:34:31

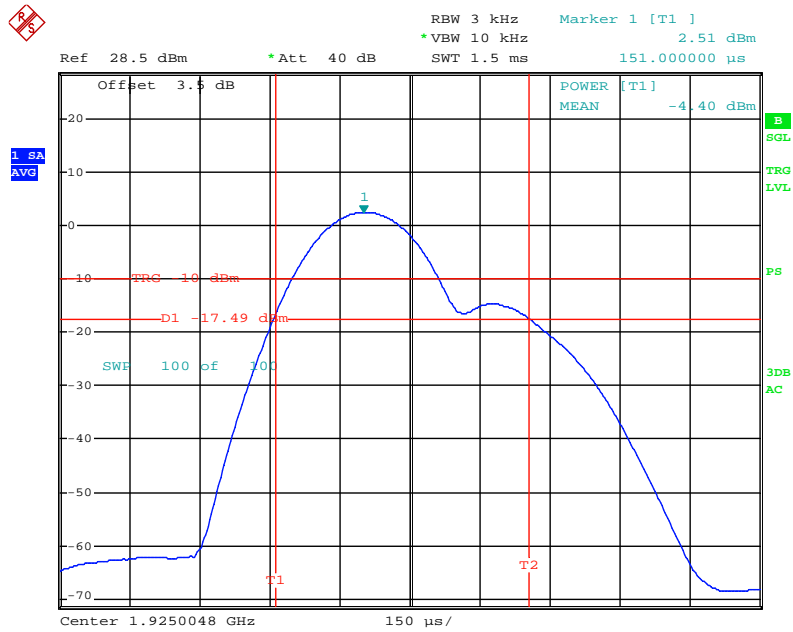

Date: 17.OCT.2012 08:36:48

High Channel

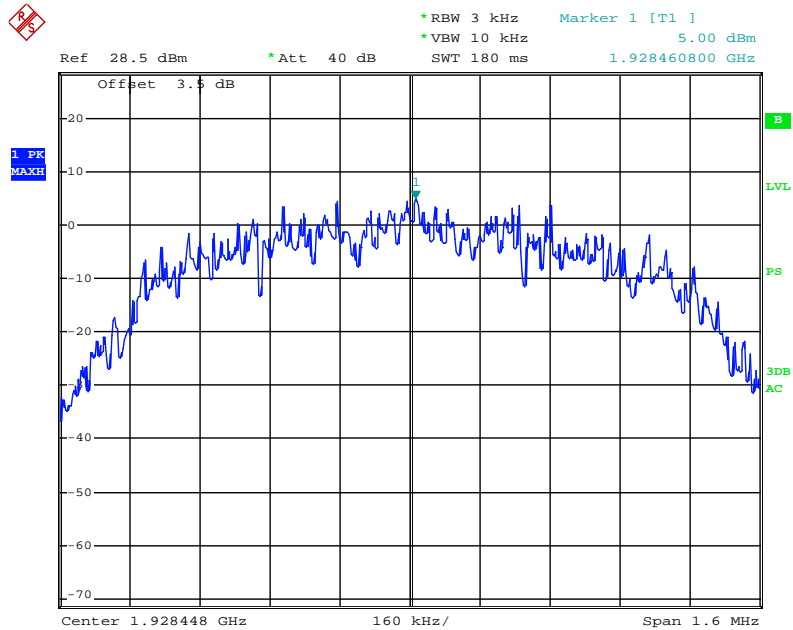

Date: 17.OCT.2012 08:38:43

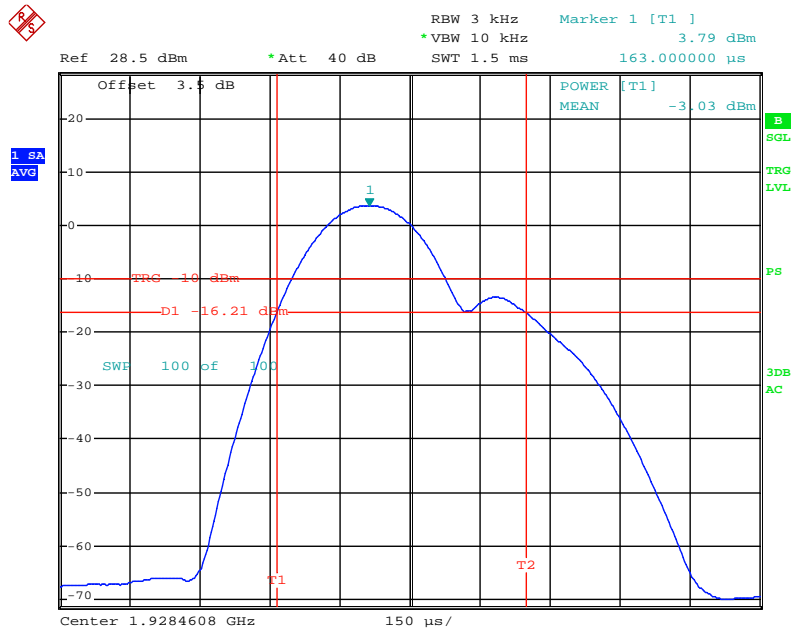

Date: 17.OCT.2012 08:40:41

FCC§15.323 (d) - EMISSION INSIDE AND OUTSIDE THE SUB-BAND

Applicable Standard

Emissions inside the sub-band must comply with the following emission mask:

1. In the bands between 1B and 2B measured from the center of the emission bandwidth the total power emitted by the device shall be at least 30 dB below the transmit power permitted for that device;
2. in the bands between 2B and 3B measured from the center of the emission bandwidth the total power emitted by an intentional radiator shall be at least 50 dB below the transmit power permitted for that radiator;
3. in the bands between 3B and the sub-band edge the total power emitted by an intentional radiator in the measurement bandwidth shall be at least 60 dB below the transmit power permitted for that radiator.

Where B = emission bandwidth

Emission Outside the sub-band shall be attenuated below a reference power of 112 mW (20.5 dBm) as follows:

1. 30 dB between the sub-band and 1.25 MHz above or below the sub-band;
2. 50 dB between 1.25 and 2.5 MHz above or below the sub-band;
3. 60 dB at 2.5 MHz or greater above or below the sub-band.

Test Equipment List and Details

Manufacturer	Description	Model	Serial Number	Calibration Date	Calibration Due Date
Rohde & Schwarz	Signal Analyzer	FSIQ26	8386001028	2011-11-24	2012-11-23

* **Statement of Traceability:** Bay Area Compliance Laboratories Corp. (Shenzhen) attests that all calibrations have been performed in accordance to NVLAP requirements that traceable to National Primary Standards and International System of Units (SI).

Test Data

Environmental Conditions

Temperature:	26 °C
Relative Humidity:	56 %
ATM Pressure:	100.0 kPa

The testing was performed by Henry Ding from 2012-10-17.

Test Mode: Transmitting

Test Result: Compliance. Please refer to following plots

Low Channel (Unwanted Emission inside the Sub-band)

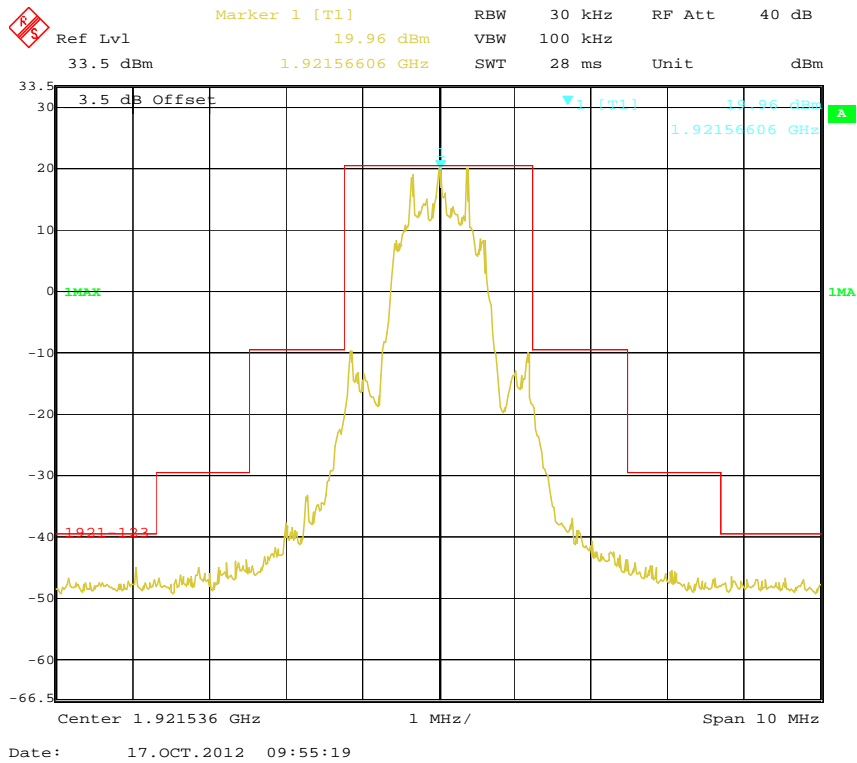

Middle Channel (Unwanted Emission inside the Sub-band)

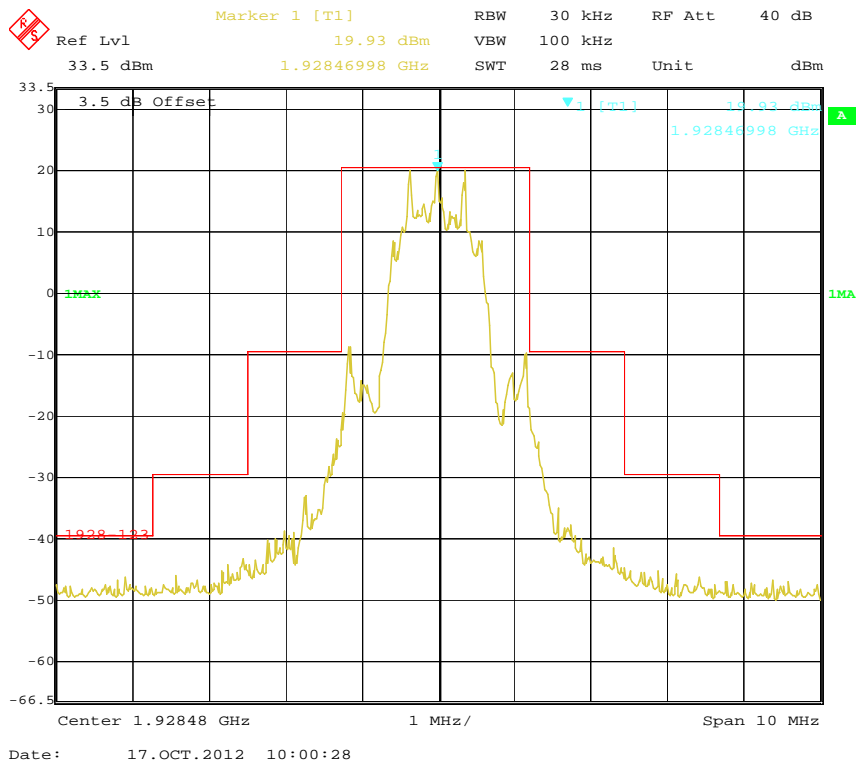

High Channel (Unwanted Emission inside the Sub-band)

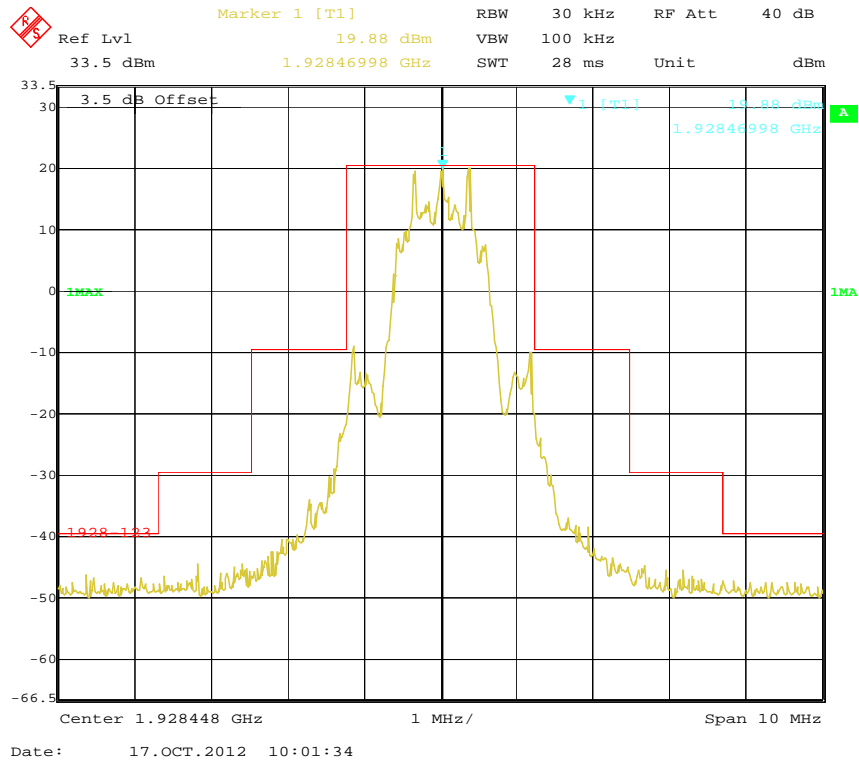

Low Channel (Unwanted Emission outside the Sub-band)

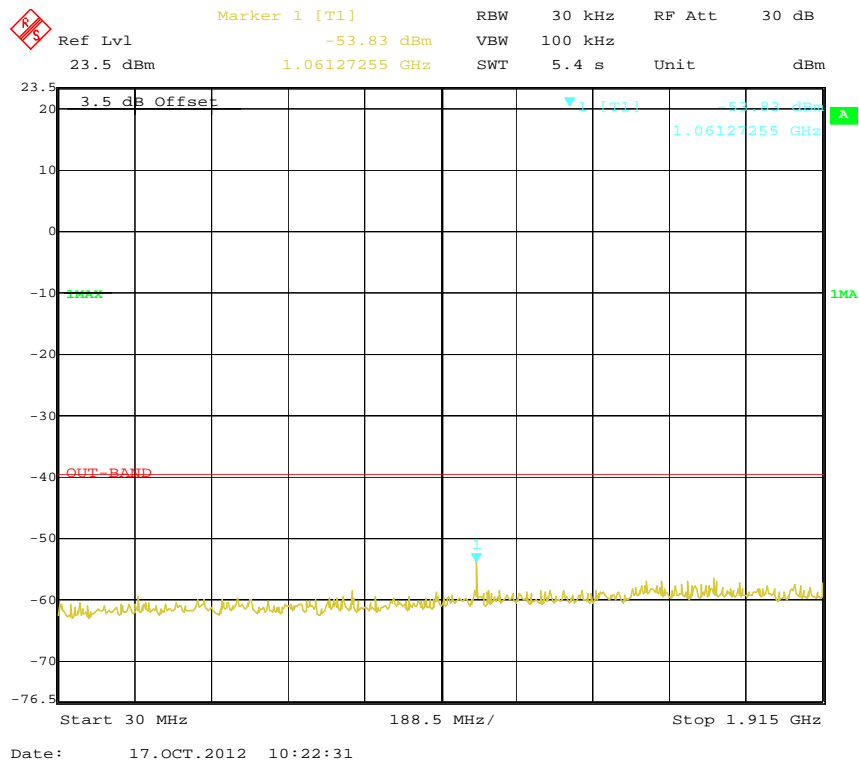

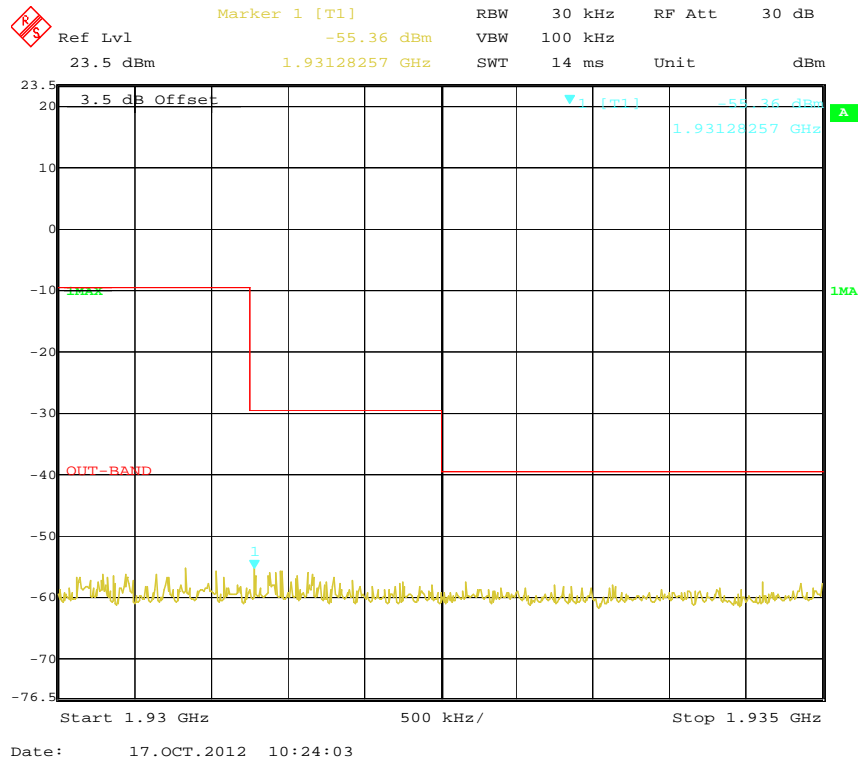
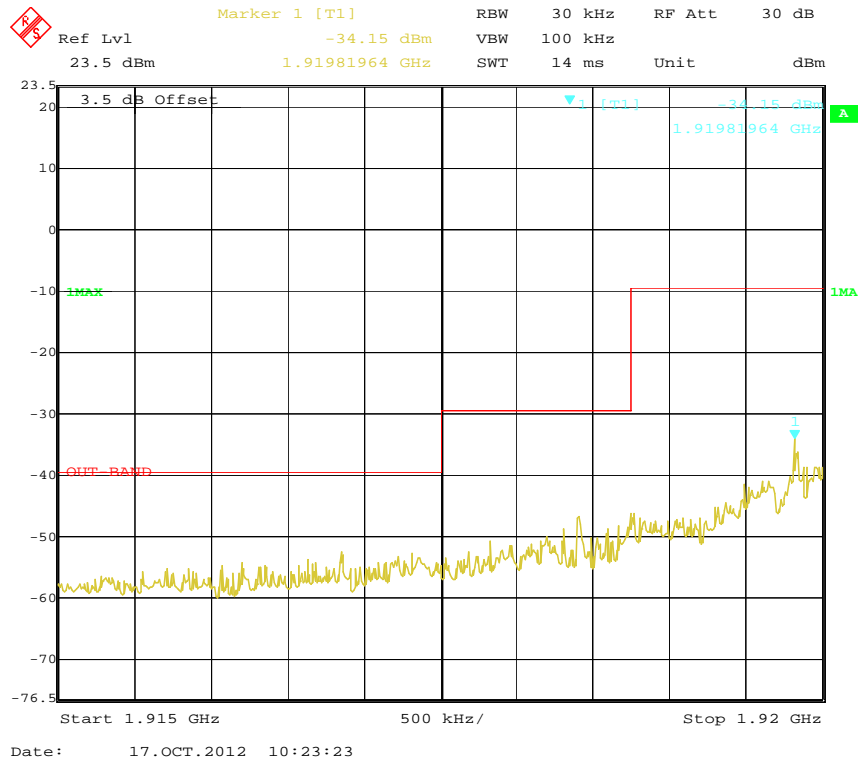

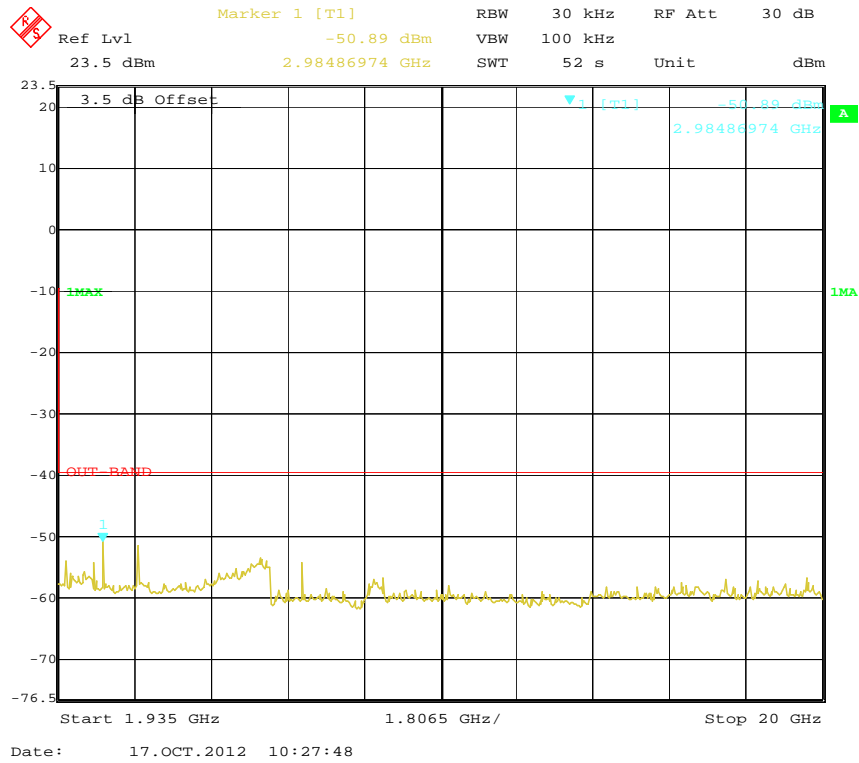

Middle Channel (Unwanted Emission outside the Sub-band)

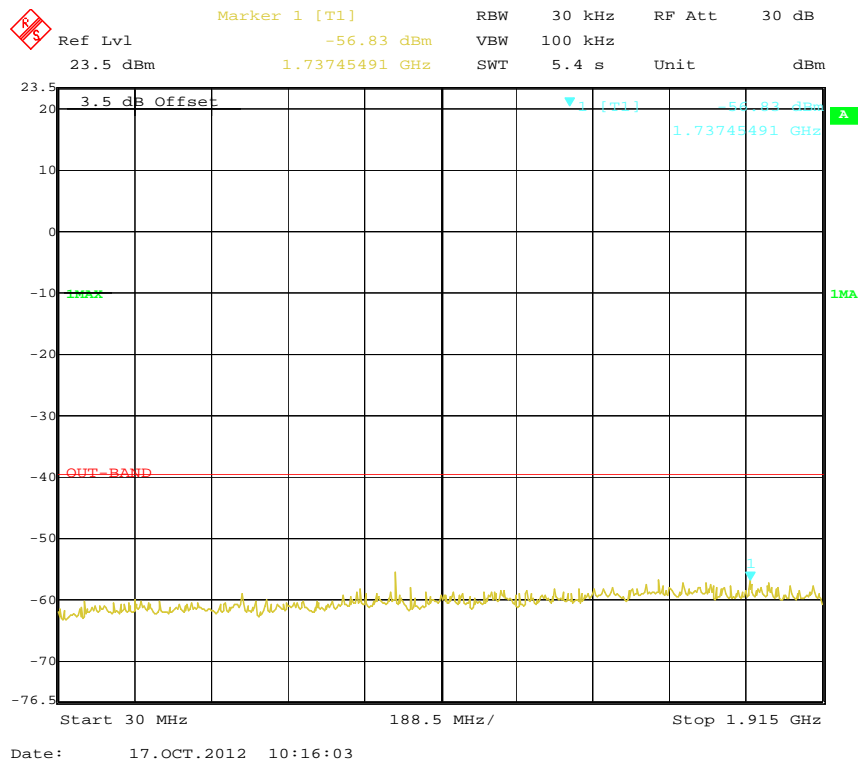

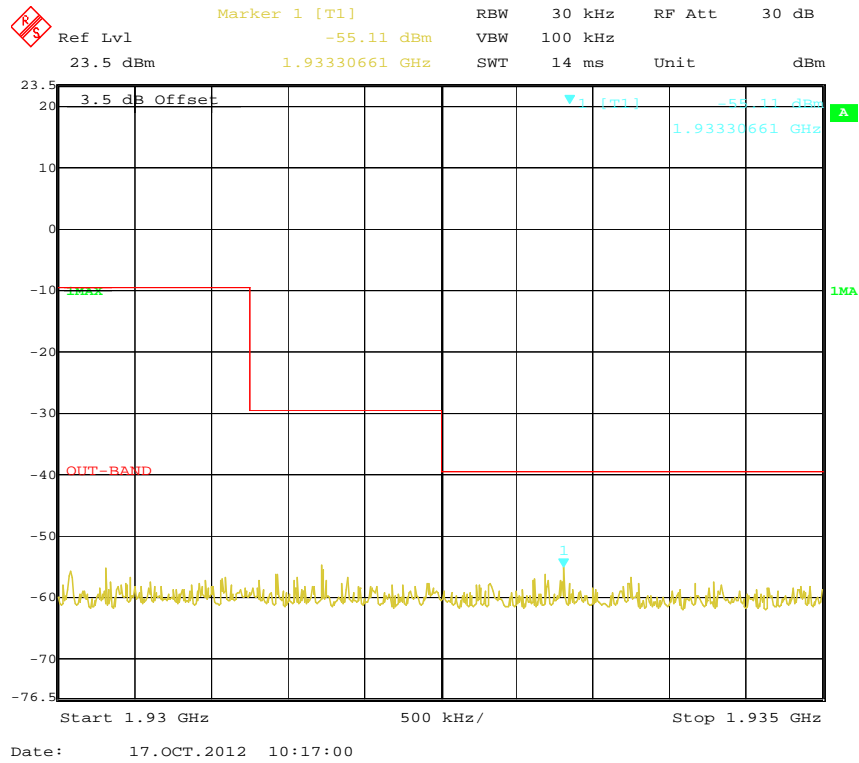
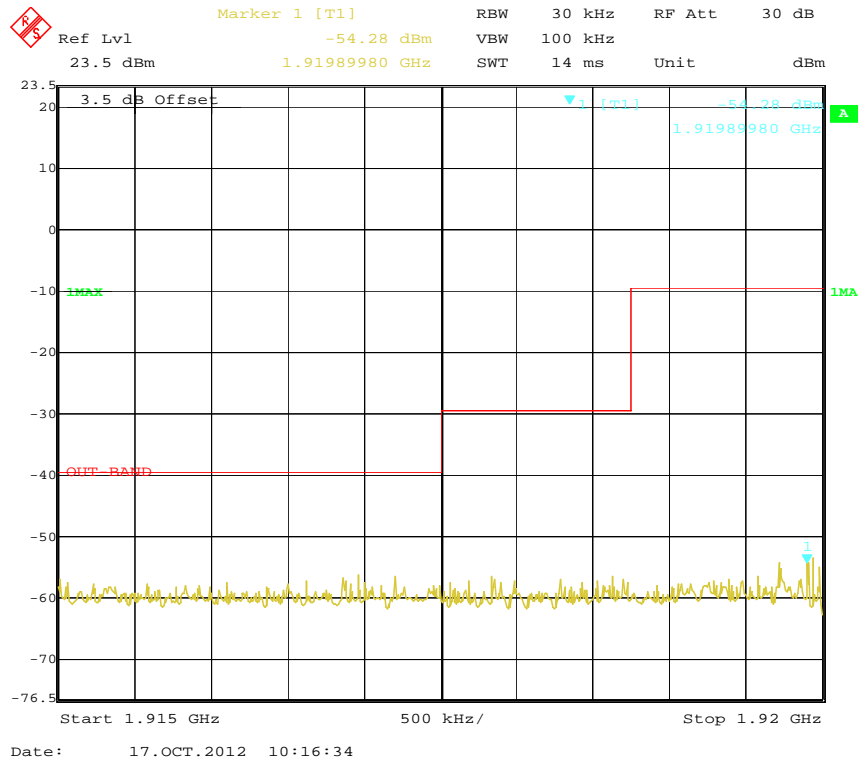

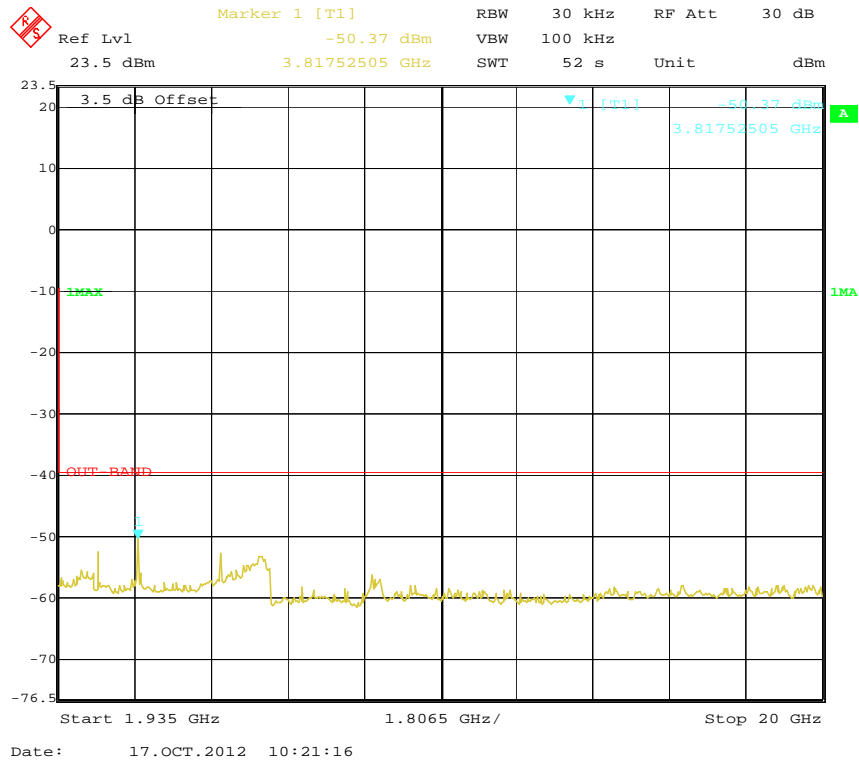

High Channel (Unwanted Emission outside the Sub-band)

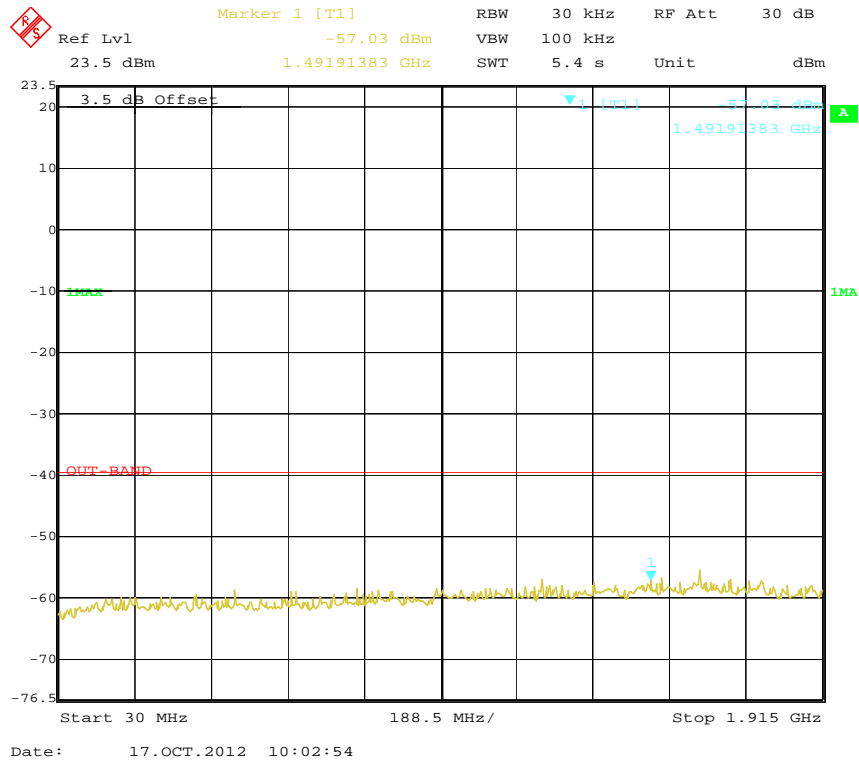

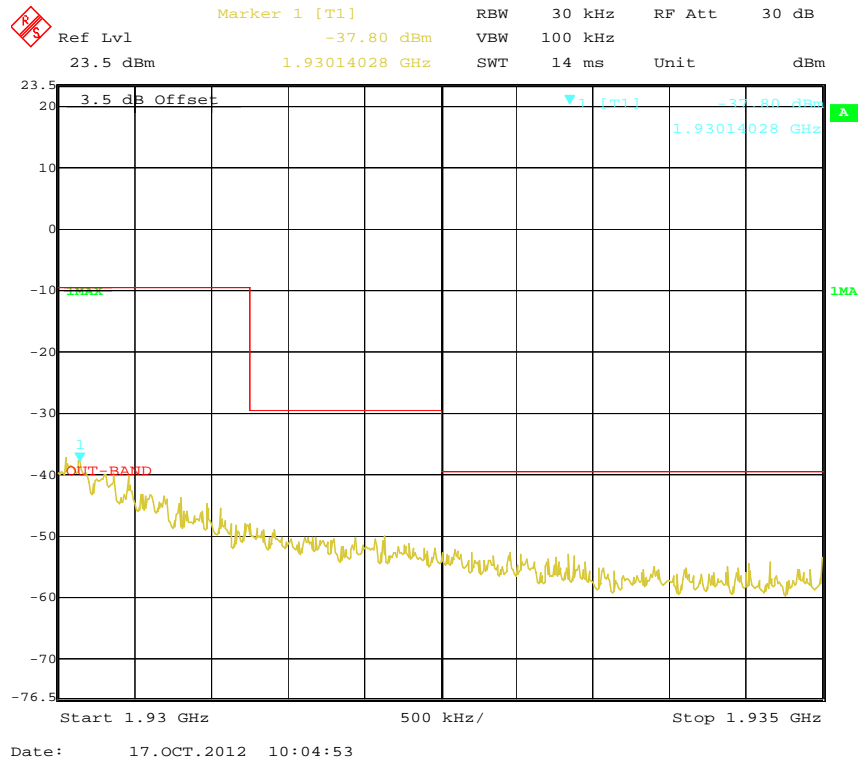
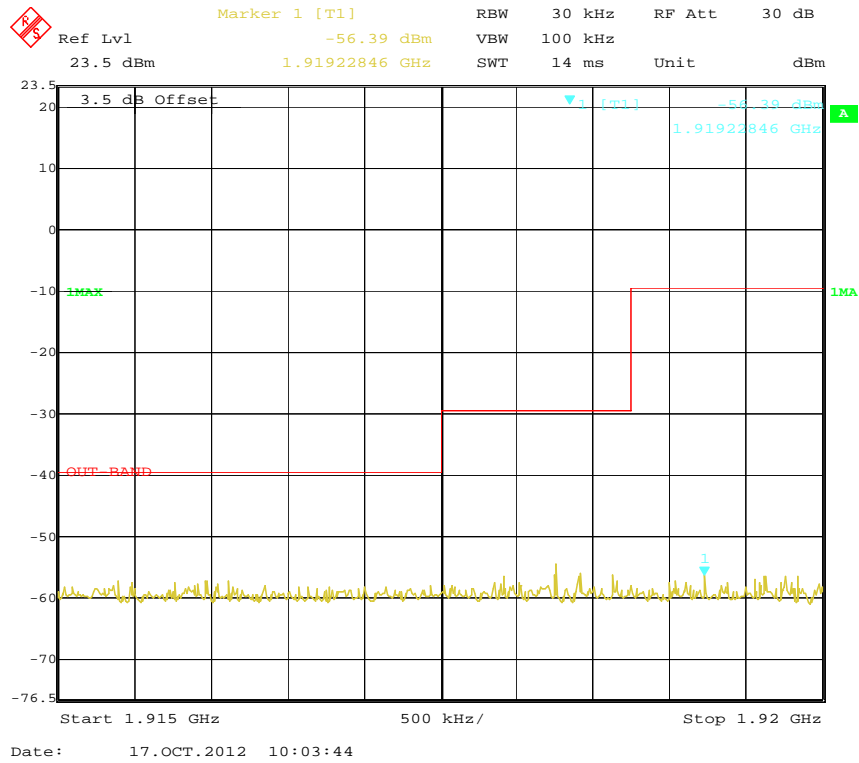

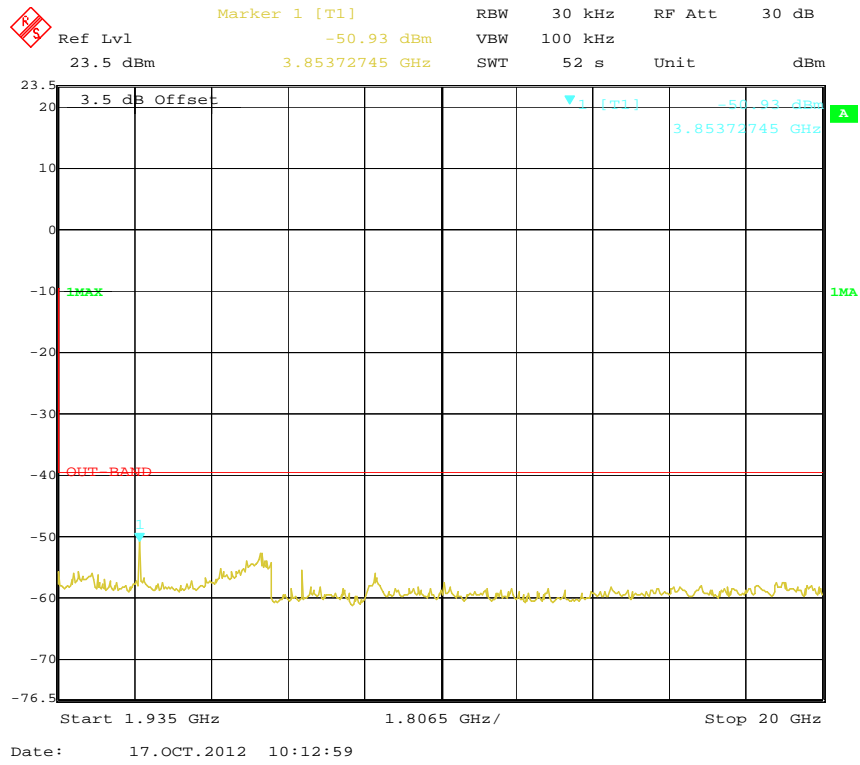

FCC§15.319 (g) - RADIATED EMISSIONS

Applicable Standard

FCC§15.319(g) Notwithstanding other technical requirements specified in this subpart, attenuation of emissions below the general emission limits in §15.209 is not required.

Measurement Uncertainty

All measurements involve certain levels of uncertainties, especially in field of EMC. The factors contributing to uncertainties are spectrum analyzer, cable loss, antenna factor calibration, antenna directivity, antenna factor variation with height, antenna phase center variation, antenna factor frequency interpolation, measurement distance variation, site imperfections, mismatch (average), and system repeatability.

Based on CISPR 16-4-4, The Treatment of Uncertainty in EMC Measurements, the best estimate of the uncertainty of a radiation emissions measurement at Bay Area Compliance Laboratories Corp. (Shenzhen) is 4.0 dB ($k=2$, 95% level of confidence), and the uncertainty will not be taken into consideration for all the test data recorded in the report.

EUT Setup

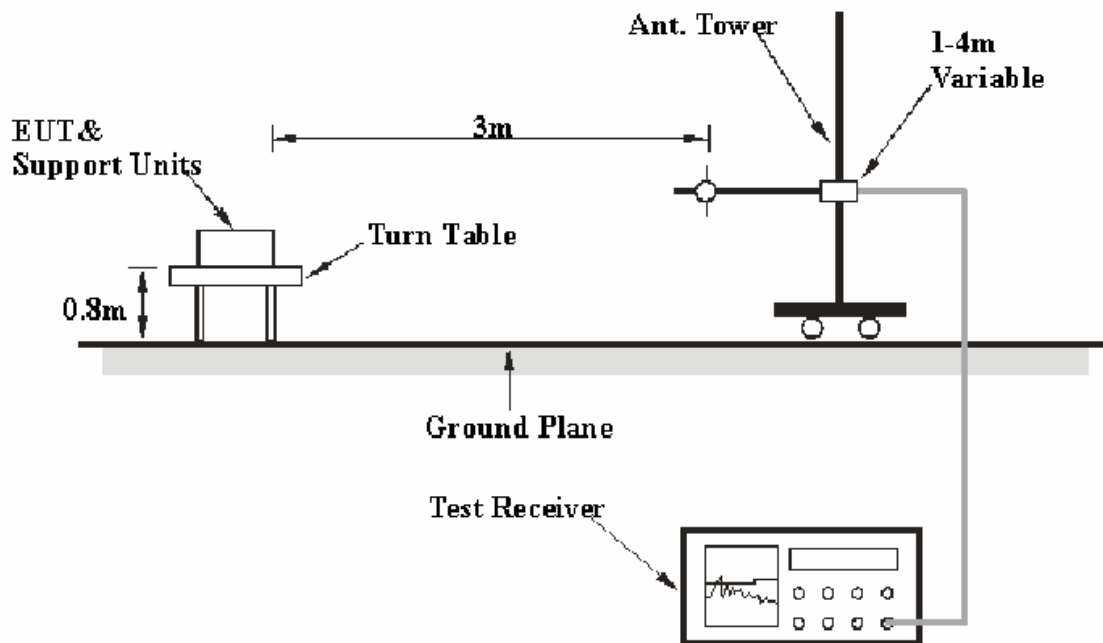

The radiated emission tests were performed in the 3 meters test site, using the setup accordance with the ANSI C63.17 - 2006. The specification used was the FCC 15§ 15.319(g).

The external I/O cables were draped along the test table and formed a bundle 30 to 40 cm long in the middle.

EMI Test Receiver & Spectrum Analyzer Setup

The system was investigated from 30 MHz to 20 GHz.

During the radiated emission test, the EMI test receiver & Spectrum Analyzer Setup were set with the following configurations:

<i>Frequency Range</i>	<i>RBW</i>	<i>Video B/W</i>
30MHz – 1000 MHz	100 kHz	300 kHz
Above 1 GHz	1 MHz	3 MHz

Test Equipment List and Details

Manufacturer	Description	Model	Serial Number	Calibration Date	Calibration Due Date
HP	Amplifier	8447E	1937A01046	2011-11-24	2012-11-23
Rohde & Schwarz	EMI Test Receiver	ESCI	101122	2012-08-08	2013-08-07
Sunol Sciences	Broadband Antenna	JB1	A040904-2	2011-11-28	2012-11-27
SUPER ULTRA	Amplifier	ZVA-213+	N/A	2011-11-24	2012-11-23
Sunol Sciences	Horn Antenna	DRH-118	A052304	2011-12-01	2012-11-30
Rohde & Schwarz	Signal Analyzer	FSIQ26	8386001028	2011-11-24	2012-11-23
the electro-Mechanics Co.	Horn Antenna	3116	9510-2270	2011-10-14	2012-10-13
R&S	Auto test Software	EMC32	V6.30	-	-

* **Statement of Traceability:** Bay Area Compliance Laboratories Corp. (Shenzhen) attests that all calibrations have been performed in accordance to NVLAP requirements that traceable to National Primary Standards and International System of Units (SI).

Test Procedure

Maximizing procedure was performed on the highest emissions to ensure that the EUT complied with all installation combinations.

Data was recorded in Quasi-peak detection mode for frequency range of 30 MHz-1 GHz and peak and Average detection modes for frequencies above 1 GHz.

Corrected Amplitude & Margin Calculation

The Corrected Amplitude is calculated by adding the Antenna Factor and Cable Loss, and subtracting the Amplifier Gain from the Meter Reading. The basic equation is as follows:

$$\text{Corrected Amplitude} = \text{Meter Reading} + \text{Antenna Factor} + \text{Cable Loss} - \text{Amplifier Gain}$$

The “**Margin**” column of the following data tables indicates the degree of compliance with the applicable limit. For example, a margin of 7dB means the emission is 7dB below the maximum limit. The equation for margin calculation is as follows:

$$\text{Margin} = \text{Limit} - \text{Corrected Amplitude}$$

Test Results Summary

According to the data in the following table, the EUT complied with the FCC Part 15.319 (g), with the worst margin reading of:

6.60 dB at 9624.7 MHz in the Vertical polarization

Test Data

Environmental Conditions

Temperature:	25 °C
Relative Humidity:	55 %
ATM Pressure:	100.0 kPa

The testing was performed by Henry Ding on 2012-10-10.

Test Mode: Transmitting (Scan with adapter & PoE power supply separately, and worst case data PoE power, as below)

30 MHz ~ 20 GHz:

Frequency (MHz)	Receiver		Turntable Degree	Rx Antenna		Corrected Factor (dB)	Corrected Amplitude (dBuV/m)	FCC Part 15.319(g)/209/205	
	Reading (dBuV)	Detector (PK/QP/Ave.)		Height (m)	Polar (H/V)			Limit (dBuV/m)	Margin (dB)
Low Channel									
1921.5	110.28	PK	69	1.3	H	3.07	113.35	/	/
1921.5	111.86	PK	53	1.3	V	3.07	114.93	/	/
60.23	52.20	QP	136	1.0	V	-20.70	31.50	40	8.50
9607.1	47.54	PK	55	1.3	V	19.28	66.82	74	7.18
11528.6	44.27	PK	81	1.4	H	20.09	64.36	74	9.64
3842.6	51.09	PK	226	1.2	V	10.23	61.32	74	12.68
5764.3	47.16	PK	234	1.2	V	13.87	61.03	74	12.97
7685.7	44.18	PK	15	1.3	V	16.47	60.65	74	13.35
8959.9	40.29	PK	4	1.4	V	17.19	57.48	74	16.52
Middle Channel									
1924.9	106.66	PK	22	1.4	H	3.07	109.73	/	/
1924.9	110.73	PK	95	1.4	V	3.07	113.80	/	/
9624.7	48.12	PK	22	1.3	V	19.28	67.40	74	6.60
60.23	52.00	QP	125	1.0	V	-20.70	31.30	40.0	8.70
11549.3	43.06	PK	59	1.2	H	20.09	63.15	74	10.85
5774.9	47.96	PK	68	1.3	V	13.87	61.83	74	12.17
3849.8	50.87	PK	88	1.3	V	10.23	61.10	74	12.90
7699.6	43.91	PK	71	1.3	V	16.47	60.38	74	13.62
8955.6	40.12	PK	138	1.2	V	17.19	57.31	74	16.69
High Channel									
1928.4	110.69	PK	22	1.3	H	3.07	113.76	/	/
1928.4	110.83	PK	58	1.3	V	3.07	113.90	/	/
60.23	52.31	QP	125	1.0	V	-20.70	31.61	40.0	8.39
9642.3	45.92	PK	44	1.2	V	19.29	65.21	74	8.79
7713.6	46.85	PK	78	1.2	V	16.47	63.32	74	10.68
11570.6	42.69	PK	16	1.4	H	20.41	63.10	74	10.90
3856.8	52.52	PK	9	1.4	V	10.23	62.75	74	11.25
5785.2	46.47	PK	75	1.4	V	13.87	60.34	74	13.66
8953.7	40.51	PK	36	1.4	V	17.19	57.70	74	16.30

Field Strength of Radiated Emission							
Average							
Freq. (MHz)	Peak Corrected Amplitude. @3m (dBμV/m)	Polar (H/V)	Duty Cycle Factor (dB)	Corrected Amplitude. (dBμV/m)	FCC 15.319		Comment
					Limit (dBμV/m)	Margin	
Low Channel							
1921.5	110.28	H	-28.29	81.99	/	/	Fund.
1921.5	111.86	V	-28.29	83.57	/	/	Fund.
3842.6	51.09	V	-28.29	22.80	54	31.20	Harmonic
9607.1	47.54	V	-28.29	19.25	54	34.75	Harmonic
5764.3	47.16	V	-28.29	18.87	54	35.13	Harmonic
11528.6	44.27	H	-28.29	15.98	54	38.02	Harmonic
7685.7	44.18	V	-28.29	15.89	54	38.11	Harmonic
8959.9	40.29	V	-28.29	12.00	54	42.00	Harmonic
Middle Channel							
1924.9	106.66	H	-28.29	78.37	/	/	Fund.
1924.9	110.73	V	-28.29	82.44	/	/	Fund.
3849.8	50.87	V	-28.29	22.58	54	31.42	Harmonic
9624.7	48.12	V	-28.29	19.83	54	34.17	Harmonic
5774.9	47.96	V	-28.29	19.67	54	34.33	Harmonic
7699.6	43.91	V	-28.29	15.62	54	38.38	Harmonic
11549.3	43.06	H	-28.29	14.77	54	39.23	Harmonic
8955.6	40.12	V	-28.29	11.83	54	42.17	Harmonic
High Channel							
1928.4	110.69	H	-28.29	82.40	/	/	Fund.
1928.4	110.83	V	-28.29	82.54	/	/	Fund.
3856.8	52.52	V	-28.29	24.23	54	29.77	Harmonic
7713.6	46.85	V	-28.29	18.56	54	35.44	Harmonic
5785.2	46.47	V	-28.29	18.18	54	35.82	Harmonic
9642.3	45.92	V	-28.29	17.63	54	36.37	Harmonic
11570.6	42.69	H	-28.29	14.40	54	39.60	Harmonic
8953.7	40.51	V	-28.29	12.22	54	41.78	Harmonic

Note: Duty Cycle=Ton/Tp*100%
 Ton =0.392 ms
 Tp=10.178 ms
 Duty Cycle= Ton/Tp =3.85%
 Duty cycle factor = 20lg (Duty Cycle) = -28.29
 Ave.=PK+20* lg(Duty Cycle)

T_{on}:

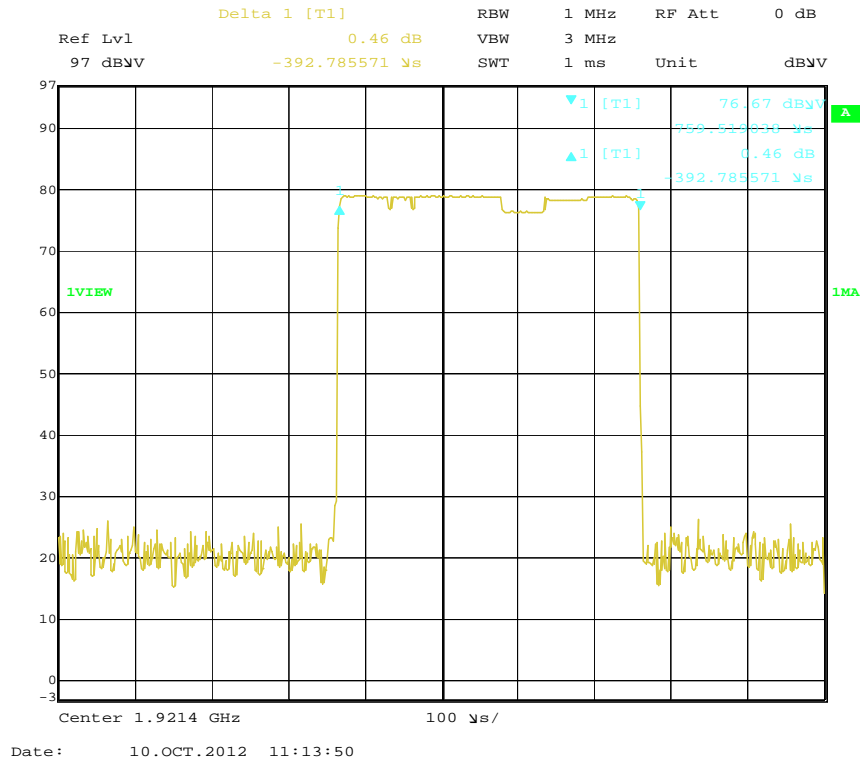

T_p:

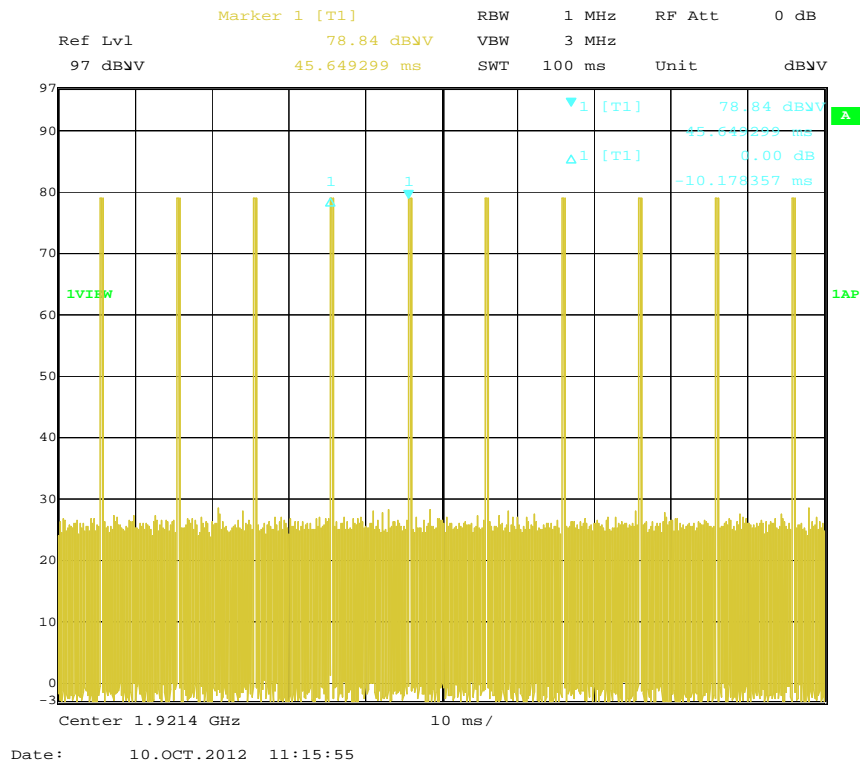

FCC§15.323 (f) - FREQUENCY STABILITY

Applicable Standard

Per §15.323(f), the frequency stability of the carrier frequency of the intentional radiator shall be maintained within ± 10 ppm over 1 hour or the interval between channel access monitoring, whichever is shorter. The frequency stability shall be maintained over a temperature variation of -20°C to $+50^{\circ}\text{C}$ at normal supply voltage, and over a variation in the primary supply voltage of 85 percent to 115 percent of the rated supply voltage at a temperature of 20°C . For equipment that is capable only of operating from a battery, the frequency stability tests shall be performed using a new battery without any further requirement to vary supply voltage.

Test Procedure

This procedure should be carried out for each of the following test cases:

Temperature	Supply Voltage
20°C	85-115% of declared nominal voltage
-20°C	Normal
+50°C	Normal

^a Use the lowest temperature at which the EUT is specified to operate if it is above -20°C .

Using the mean carrier frequency at 20°C and at nominal supply voltage as the reference, the mean carrier frequency shall be maintained within ± 10 ppm at the two extreme temperatures (or as declared by the manufacturer) and at normal temperature (typically 20°C) at the two extreme supply voltages.

Test Equipment List and Details

Manufacturer	Description	Model	Serial Number	Calibration Date	Calibration Due Date
ESPEC	Temperature & Humidity Chamber	EL-10KA	09107726	2011-11-24	2012-11-23
R & S	Digital Radio-Communication Tester	CMD60	829902/026	2012-03-16	2013-03-15

* **Statement of Traceability:** Bay Area Compliance Laboratories Corp. (Shenzhen) attests that all calibrations have been performed in accordance to NVLAP requirements that traceable to National Primary Standards and International System of Units (SI).

Test Data

Environmental Conditions

Temperature:	25 °C
Relative Humidity:	55 %
ATM Pressure:	100.0 kPa

The testing was performed by Henry Ding on 2012-10-10.

Test Result: Compliance.

Test Mode: Transmitting

Temperature (°C)	Voltage (V _{AC})	Channel Frequency (MHz)	Measured Frequency Offset (kHz)	Measured Frequency Offset (ppm)	Limit (ppm)
20	102	1924.992	3.4	1.766	±10
	138	1924.992	2.0	1.039	±10
-20	120	1924.992	3.8	1.974	±10
50	120	1924.992	1.7	0.883	±10

FCC§15.323 (c) (e) & §15.319(f) – SPECIFIC REQUIREMENTS FOR UPCS DEVICE

Automatic Discontinuation of Transmission, FCC Part 15.319(f)

The device shall automatically discontinue transmission in case of either absence of information to transmit or operational failure. The provisions in this section are not intended to preclude transmission of control and signaling information or use of repetitive codes used by certain digital technologies to complete frame or burst intervals.

Test result:

Meet the requirement; please refer to the declaration provided by manufacturer.

Monitoring Time FCC 15.323 (c) (1)

Immediately prior to initiating transmission, devices must monitor the combined time and spectrum window in which they intend to transmit. For a period of at least 10 milliseconds for systems designed to use a 10 milliseconds or shorter frame period or at least 20 milliseconds for systems designed to use a 20 milliseconds frame period

Test procedure:

Measurement method according to ANSI C63.17 2006 clause 7.3.4

Test result:

EUT monitors the combined time and spectrum window prior to initiation of transmission. Test result is following

Interference (Refer to ANSI C63.17 clause 7.3.4)	Reaction of EUT	Results
1) Apply the interference on f1 at level TU+UM, and no interference on f2. Initiate transmission and verify the transmission on f2.	EUT transmits on f2	Pass
2) Apply the interference on f2 at level TU+UM, at the same time, no interference on f1. After about 20ms, initiate transmission and verify the transmission on f1.	EUT transmits on f1	Pass

Lower Monitoring Threshold Part15.323 (c) (2)

The monitoring threshold must not be more than 30 dB above the thermal noise power for a bandwidth equivalent to the emission bandwidth used by the device.

Test procedure:

Measurement method according to ANSI C63.17 2006 clause 7.3.1

Test result: Not Apply

Maximum Transmit Period FCC Part15.323 (c) (3)

If no signal above the threshold level is detected, transmission may commence and continue with the same emission bandwidth in the monitored time and spectrum windows without further monitoring. However, occupation of the same combined time and spectrum windows by a device or group of cooperating devices continuously over a period of time longer than 8 hours is not permitted without repeating the access criteria.

Test procedure:

Measurement method according to ANSI C63.17 2006 clause 8.2.2

Test result:

Repetition of Access Criteria	Measured Maximum Transmission Time (Second)	Limit (Second)	Results
First	21600	28,800	Pass
Second	21600	28,800	Pass

System Acknowledgement, FCC Part15.323 (c) (4)

Once access to specific combined time and spectrum windows is obtained an acknowledgment from a system participant must be received by the initiating transmitter within one second or transmission must cease. Periodic acknowledgments must be received at least every 30 seconds or transmission must cease. Channels used exclusively for control and signaling information may transmit continuously for 30 seconds without receiving an acknowledgment, at which time the access criteria must be repeated.

Test procedure:

Measurement method according to ANSI C63.17 2006 clause 8.1.1, 8.2.1

Test result:

Test	Time taken (second)	Limit (second)	Result
Connection acknowledgement	0.08	1	Pass
Change of access criteria for control information	N/A	30	Pass
Transmission cease time	2.3	30	Pass
Pulse length	0.000393	0.01	Pass

Note: N/A=Not Applicable

Least Interfered Channel (LIC) Selection, FCC Part15.323 (c) (5)

If access to spectrum is not available as determined by the above, and a minimum of 40 duplex system access channels are defined for the system, the time and spectrum windows with the lowest power level below a monitoring threshold of 50 dB above the thermal noise power determined for the emission bandwidth may be accessed.

Calculation of monitoring threshold limits for isochroous devices:

Lower threshold: $T_L = -174 + 10\text{Log}_{10}B + M_u + P_{MAX} - P_{EUT}$ (dBm)

Upper threshold: $T_U = -174 + 10\text{Log}_{10}B + M_u + P_{MAX} - P_{EUT}$ (dBm)

Where: B=Emission bandwidth (Hz)

M_u =dB the threshold may exceed thermal noise (30 for T_L & 50 for T_U)

$P_{MAX} = 5\text{Log}_{10}B - 10$ (dBm)

P_{EUT} =Transmitted power (dBm)

Limit:

Monitor Threshold	B (MHz)	M_U (dB)	P_{MAX} (dBm)	P_{EUT} (dBm)	Threshold (dBm)
T_L	1.371	30	20.69	20.46	-82.40
T_U	1.371	50	20.69	20.46	-62.40

The EUT must not transmit until the interference level is less than or equal to:

Measured Threshold Level $\leq T_U$

Where: T_U =Upper threshold level

Test procedure:

Measurement method according to ANSI C63.17 clause 7.3.2, 7.3.3, 7.3.4

Test result:

Monitor threshold	Measured Threshold Level	Limit (dBm)
Lower Threshold (dBm)	N/A	-82.40
Upper Threshold (dBm)	N/A	-62.40

Note: N/A Not applicable- EUT which supports at least of 40 duplex system access channels and implements Least Interfered Channel (LIC) algorithm is permitted to use an upper monitoring threshold. Please refer to the section 4.16.2 for more details.

Random waiting FCC 15.323(c) (6)

If the selected combined time and spectrum windows are unavailable, the device may either monitor and select different windows or seek to use the same window after waiting an amount of time, randomly chosen from a uniform random distribution between 10 and 150 milliseconds, commencing when the channel becomes available.

Test procedure:

Measurement method according to ANSI C63.17 2006 clause 8.1.3

Test result:

The manufacturer declares that this provision is not utilized by the EUT.

Monitoring Bandwidth, FCC Part 15.323 (c) (7)

The monitoring system bandwidth must be equal to or greater than the emission bandwidth of the intended transmission and have a maximum reaction time less than $50 \times \text{SQRT}(1.25/\text{emission bandwidth in MHz})$ microseconds for signals at the applicable threshold level but shall not be required to be less than 50 microseconds

Test procedure:

Measurement method according to ANSI C63.17 2006 clause 7.5

Test result:

Test Equation (μs)	B(bandwidth)(MHz)	Pulse width(μs)	Limit(μs)	Result
$50 (1.25/B)^{1/2}$	1.371	47.74	50	Pass
$35 (1.25/B)^{1/2}$	1.371	33.42	35	Pass

Monitoring Antenna, FCC Part 15.323 (c) (8)

The monitoring system shall use the same antenna used for transmission, or an antenna that yields equivalent reception at that location.

Test procedure:

Measurement method according to ANSI C63.17 2006 paragraph 4

Test result:

The antenna of the EUT used for transmission is the same interior antenna that used for monitoring.

Monitoring threshold relation FCC 15.323(c) (9)

Devices that have a power output lower than the maximum permitted under the rules can increase their monitoring detection threshold by one decibel for each one decibel that the transmitter power is below the maximum permitted.

Test procedure:

Measurement method according to ANSI C63.17 2006 paragraph 4

Test result:

Not apply based on 15.323 (c) (5)

Duplex Connections, FCC Part 15.323 (c) (10)

An initiating device may attempt to establish a duplex connection by monitors both its intended transmit and receive time and spectrum windows. If both the intended transmit and receive time and spectrum windows meet the access criteria, then the initiating device can initiate a transmission in the intended transmit time and spectrum window. If the power detected by the responding device can be decoded as a duplex connection signal from the initiating device, then the responding device may immediately begin transmitting on the receive time and spectrum window monitored by the initiating device.

Test procedure:

Measurement method according to ANSI C63.17 clause 8.3

Test result:

The EUT is the initiating device of the duplex connection.

1) EUTs that do NOT implement the Upper Threshold

Interference (Refer to ANSI C63.17 § 8.3.1)	Reaction of EUT	Results
b) Only a single carrier f1 for EUT TDMA systems.	EUT can transmit	Pass
c)d) All Tx and Rx windows block, except one for Rx window	No connection possible	Pass
e)f) All Tx and Rx windows block, except one for Tx window	No connection possible	Pass

2) EUTs that implements the Upper Threshold

Interference (Refer to ANSI C63.17 § 8.3.2)	Reaction of EUT	Results
b) Only a single carrier f1 for EUT TDMA systems.	EUT can transmit	Pass
c)d) All Tx windows with level TL+UM & Rx windows with level TL+UM+7dB, except one for Rx window & one for Rx window, which are not duplex.	Connected on the target Rx window and its duplex mate.	Pass
e)f) All Tx windows with level TL+UM+7dB & Rx windows with level TL+UM, except one for Rx window & one for Rx window, which are not duplex.	Connected on the target Tx window and its duplex mate.	Pass
g) All Tx & Rx windows with level TU+UM, except one for Rx window & one for Rx window, which are not duplex.	No connection possible	Pass

Alternative monitoring interval for co-located devices, FCC Part 15.323 (c) (11)

An initiating device that is prevented from monitoring during its intended transmit window due to monitoring system blocking from the transmissions of a co-located (within one meter) transmitter of the same system, may monitor the portions of the time and spectrum windows in which they intend to receive over a period of at least 10 milliseconds. The monitored time and spectrum window must total at least 50 percent of the 10 millisecond frame interval and the monitored spectrum must be within 1.25 MHz of the center frequency of channel(s) already occupied by that device or co-located co-operating devices. If the access criteria is met for the intended receive time and spectrum window under the above conditions, then transmission in the intended transmit window by the initiating device may commence.

Test procedure:

Measurement method according to ANSI C63.17 2006 clause 8.4

Test result:

The manufacturer declares that this provision is not utilized by the EUT.

Fair Access, FCC Part 15.323 (c) (12)

The provisions of FCC Part 15.323(c)(10) or (c)(11) shall not be used to extend the range of spectrum occupied over space or time for the purpose of denying fair access to spectrum to other devices.

Test result:

The manufacturer declares that this device does not use any mechanisms as provided by Part 15.323 (c) (10) or (c) (11) to extend the range of spectrum occupied over space or time for the purpose of denying fair access to spectrum to other device.

Frame Repetition Stability, Part 15.323 (e)

The frame period (a set of consecutive time slots in which the position of each time slot can be identified by reference to a synchronizing source) of an intentional radiator operating in these sub-bands shall be 20 milliseconds or 10 milliseconds/X where X is a positive whole number.

Test procedure:

Measurement method according to ANSI C63.17 2006 clause 6.2.2, 6.2.3

Test result:

Frame Repetition Stability:

Frame Repetition Stability (ppm)	Limit (ppm)	Result (Pass/Fail)
1.974	10	Pass

Frame Period and Jitter:

Max. pos. Jitter (us)	Max. neg. Jitter (us)	Frame period (ms)	Limit	
			Frame Period (ms)	Jitter (μs)
0.01	-0.05	10.00000	20 or 10/X	25

Note: X is a positive whole number.

PRODUCT SIMILARITY DECLARATION LETTER



Yealink (Xiamen) Network Technology Co., LTD.
4th-5th Floor, South Building, No.63 Wanghai Road, 2nd Software Park, Xiamen, China.
Tel: 86-592-5702000-2801 Fax: 86-592-5702455

2012-11-20

Product Similarity Declaration Letter

To Whom It May Concern,

We, Yealink (Xiamen) Network Technology Co.,Ltd. hereby declare that our product IP DECT Phone, the model W52P, W52H, W52Duo, the difference is W52P has one base and one handset, W52H has only one handset, and W52Duo has one base and two handsets. Model W52P was tested by BACL.

Please contact me if you have any question.

Signature:

A handwritten signature in black ink that reads "Stone Lu".

Stone Lu :
Vice General Manager

******* END OF REPORT *******