

FILE	
Size	Number
A2	Revision
A3	2010/12/29
A4	2011/12/29
A5	2012/12/29
A6	2013/12/29
A7	2014/12/29
A8	2015/12/29
A9	2016/12/29
A10	2017/12/29
A11	2018/12/29
A12	2019/12/29
A13	2020/12/29
A14	2021/12/29
A15	2022/12/29
A16	2023/12/29
A17	2024/12/29
A18	2025/12/29
A19	2026/12/29
A20	2027/12/29
A21	2028/12/29
A22	2029/12/29
A23	2030/12/29
A24	2031/12/29
A25	2032/12/29
A26	2033/12/29
A27	2034/12/29
A28	2035/12/29
A29	2036/12/29
A30	2037/12/29
A31	2038/12/29
A32	2039/12/29
A33	2040/12/29
A34	2041/12/29
A35	2042/12/29
A36	2043/12/29
A37	2044/12/29
A38	2045/12/29
A39	2046/12/29
A40	2047/12/29
A41	2048/12/29
A42	2049/12/29
A43	2050/12/29
A44	2051/12/29
A45	2052/12/29
A46	2053/12/29
A47	2054/12/29
A48	2055/12/29
A49	2056/12/29
A50	2057/12/29
A51	2058/12/29
A52	2059/12/29
A53	2060/12/29
A54	2061/12/29
A55	2062/12/29
A56	2063/12/29
A57	2064/12/29
A58	2065/12/29
A59	2066/12/29
A60	2067/12/29
A61	2068/12/29
A62	2069/12/29
A63	2070/12/29
A64	2071/12/29
A65	2072/12/29
A66	2073/12/29
A67	2074/12/29
A68	2075/12/29
A69	2076/12/29
A70	2077/12/29
A71	2078/12/29
A72	2079/12/29
A73	2080/12/29
A74	2081/12/29
A75	2082/12/29
A76	2083/12/29
A77	2084/12/29
A78	2085/12/29
A79	2086/12/29
A80	2087/12/29
A81	2088/12/29
A82	2089/12/29
A83	2090/12/29
A84	2091/12/29
A85	2092/12/29
A86	2093/12/29
A87	2094/12/29
A88	2095/12/29
A89	2096/12/29
A90	2097/12/29
A91	2098/12/29
A92	2099/12/29
A93	2100/12/29
A94	2101/12/29
A95	2102/12/29
A96	2103/12/29
A97	2104/12/29
A98	2105/12/29
A99	2106/12/29
A100	2107/12/29
A101	2108/12/29
A102	2109/12/29
A103	2110/12/29
A104	2111/12/29
A105	2112/12/29
A106	2113/12/29
A107	2114/12/29
A108	2115/12/29
A109	2116/12/29
A110	2117/12/29
A111	2118/12/29
A112	2119/12/29
A113	2120/12/29
A114	2121/12/29
A115	2122/12/29
A116	2123/12/29
A117	2124/12/29
A118	2125/12/29
A119	2126/12/29
A120	2127/12/29
A121	2128/12/29
A122	2129/12/29
A123	2130/12/29
A124	2131/12/29
A125	2132/12/29
A126	2133/12/29
A127	2134/12/29
A128	2135/12/29
A129	2136/12/29
A130	2137/12/29
A131	2138/12/29
A132	2139/12/29
A133	2140/12/29
A134	2141/12/29
A135	2142/12/29
A136	2143/12/29
A137	2144/12/29
A138	2145/12/29
A139	2146/12/29
A140	2147/12/29
A141	2148/12/29
A142	2149/12/29
A143	2150/12/29
A144	2151/12/29
A145	2152/12/29
A146	2153/12/29
A147	2154/12/29
A148	2155/12/29
A149	2156/12/29
A150	2157/12/29
A151	2158/12/29
A152	2159/12/29
A153	2160/12/29
A154	2161/12/29
A155	2162/12/29
A156	2163/12/29
A157	2164/12/29
A158	2165/12/29
A159	2166/12/29
A160	2167/12/29
A161	2168/12/29
A162	2169/12/29
A163	2170/12/29
A164	2171/12/29
A165	2172/12/29
A166	2173/12/29
A167	2174/12/29
A168	2175/12/29
A169	2176/12/29
A170	2177/12/29
A171	2178/12/29
A172	2179/12/29
A173	2180/12/29
A174	2181/12/29
A175	2182/12/29
A176	2183/12/29
A177	2184/12/29
A178	2185/12/29
A179	2186/12/29
A180	2187/12/29
A181	2188/12/29
A182	2189/12/29
A183	2190/12/29
A184	2191/12/29
A185	2192/12/29
A186	2193/12/29
A187	2194/12/29
A188	2195/12/29
A189	2196/12/29
A190	2197/12/29
A191	2198/12/29
A192	2199/12/29
A193	2200/12/29
A194	2201/12/29
A195	2202/12/29
A196	2203/12/29
A197	2204/12/29
A198	2205/12/29
A199	2206/12/29
A200	2207/12/29
A201	2208/12/29
A202	2209/12/29
A203	2210/12/29
A204	2211/12/29
A205	2212/12/29
A206	2213/12/29
A207	2214/12/29
A208	2215/12/29
A209	2216/12/29
A210	2217/12/29
A211	2218/12/29
A212	2219/12/29
A213	2220/12/29
A214	2221/12/29
A215	2222/12/29
A216	2223/12/29
A217	2224/12/29
A218	2225/12/29
A219	2226/12/29
A220	2227/12/29
A221	2228/12/29
A222	2229/12/29
A223	2230/12/29
A224	2231/12/29
A225	2232/12/29
A226	2233/12/29
A227	2234/12/29
A228	2235/12/29
A229	2236/12/29
A230	2237/12/29
A231	2238/12/29
A232	2239/12/29
A233	2240/12/29
A234	2241/12/29
A235	2242/12/29
A236	2243/12/29
A237	2244/12/29
A238	2245/12/29
A239	2246/12/29
A240	2247/12/29
A241	2248/12/29
A242	2249/12/29
A243	2250/12/29
A244	2251/12/29
A245	2252/12/29
A246	2253/12/29
A247	2254/12/29
A248	2255/12/29
A249	2256/12/29
A250	2257/12/29
A251	2258/12/29
A252	2259/12/29
A253	2260/12/29
A254	2261/12/29
A255	2262/12/29
A256	2263/12/29
A257	2264/12/29
A258	2265/12/29
A259	2266/12/29
A260	2267/12/29
A261	2268/12/29
A262	2269/12/29
A263	2270/12/29
A264	2271/12/29
A265	2272/12/29
A266	2273/12/29
A267	2274/12/29
A268	2275/12/29
A269	2276/12/29
A270	2277/12/29
A271	2278/12/29
A272	2279/12/29
A273	2280/12/29
A274	2281/12/29
A275	2282/12/29
A276	2283/12/29
A277	2284/12/29
A278	2285/12/29
A279	2286/12/29
A280	2287/12/29
A281	2288/12/29
A282	2289/12/29
A283	2290/12/29
A284	2291/12/29
A285	2292/12/29
A286	2293/12/29
A287	2294/12/29
A288	2295/12/29
A289	2296/12/29
A290	2297/12/29
A291	2298/12/29
A292	2299/12/29
A293	2300/12/29
A294	2301/12/29
A295	2302/12/29
A296	2303/12/29
A297	2304/12/29
A298	2305/12/29
A299	2306/12/29
A300	2307/12/29
A301	2308/12/29
A302	2309/12/29
A303	2310/12/29
A304	2311/12/29
A305	2312/12/29
A306	2313/12/29
A307	2314/12/29
A308	2315/12/29
A309	2316/12/29
A310	2317/12/29
A311	2318/12/29
A312	2319/12/29
A313	2320/12/29
A314	2321/12/29
A315	2322/12/29
A316	2323/12/29
A317	2324/12/29
A318	2325/12/29
A319	2326/12/29
A320	2327/12/29
A321	2328/12/29
A322	2329/12/29
A323	2330/12/29
A324	2331/12/29
A325	2332/12/29
A326	2333/12/29
A327	2334/12/29
A328	2335/12/29
A329	2336/12/29
A330	2337/12/29
A331	2338/12/29
A332	2339/12/29
A333	2340/12/29
A334	2341/12/29
A335	2342/12/29
A336	2343/12/29
A337	2344/12/29
A338	2345/12/29
A339	2346/12/29
A340	2347/12/29
A341	2348/12/29
A342	2349/12/29
A343	2350/12/29
A344	2351/12/29
A345	2352/12/29
A346	2353/12/29
A347	2354/12/29
A348	2355/12/29
A349	2356/12/29
A350	2357/12/29
A351	2358/12/29
A352	2359/12/29
A353	2360/12/29
A354	2361/12/29
A355	2362/12/29
A356	2363/12/29
A357	2364/12/29
A358	2365/12/29
A359	2366/12/29
A360	2367/12/29
A361	2368/12/29
A362	2369/12/29
A363	2370/12/29
A364	2371/12/29
A365	2372/12/29
A366	2373/12/29
A367	2374/12/

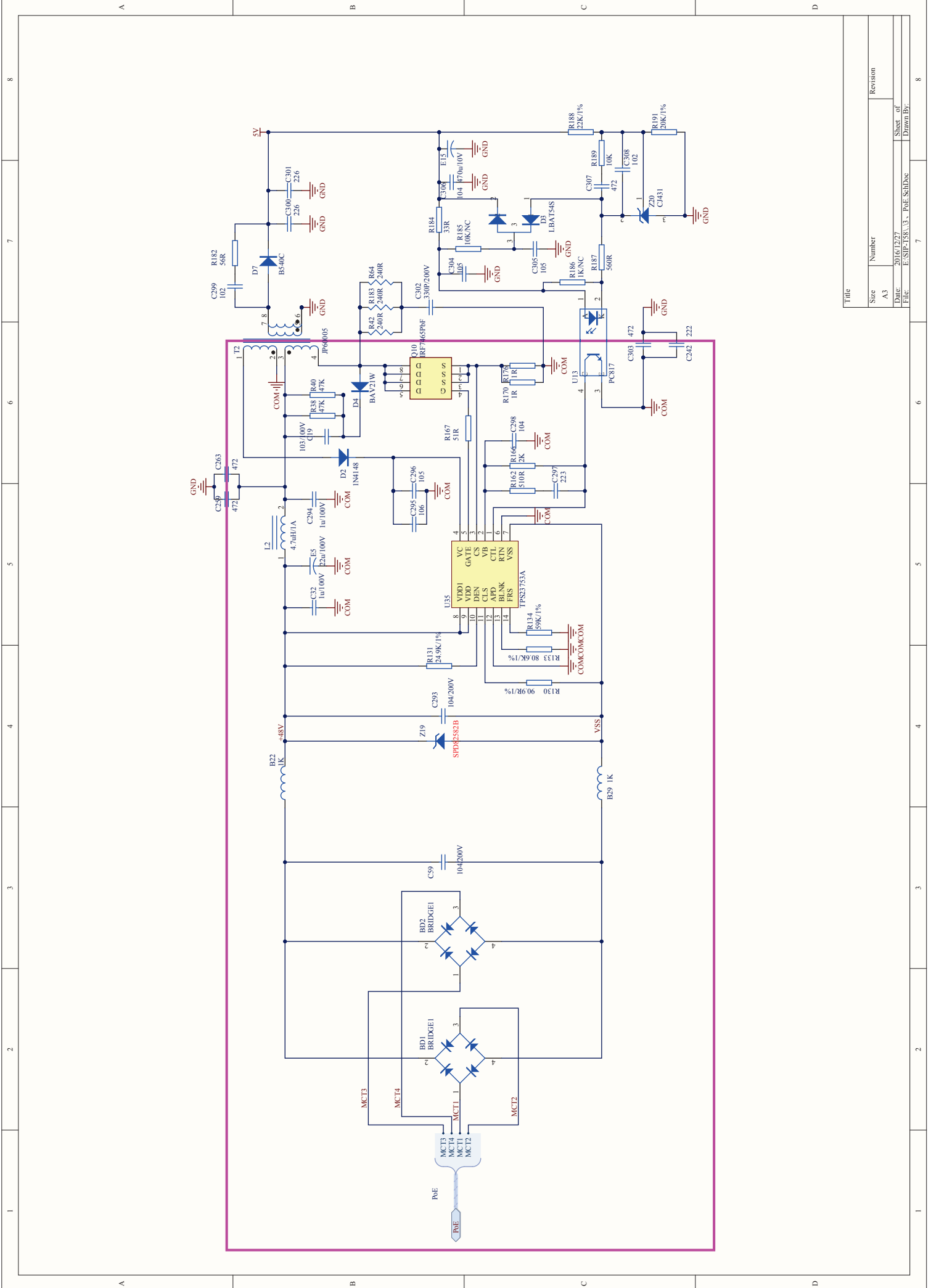

Title	
Size	Number
A3	A3
Date	20161227
File	E:\SHP138\1.3_P06_SchDoc
Sheet of 8	
Drawn By:	

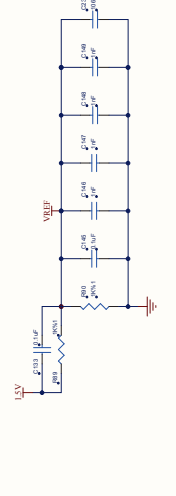
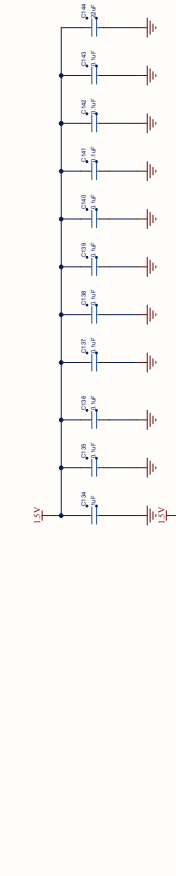
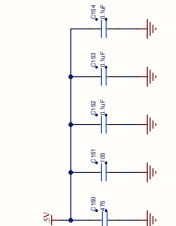
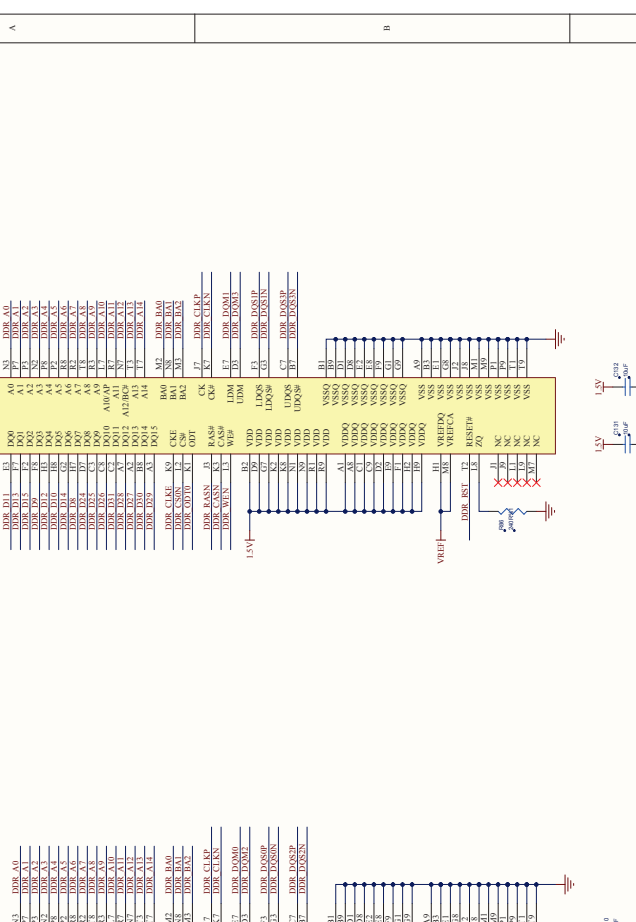
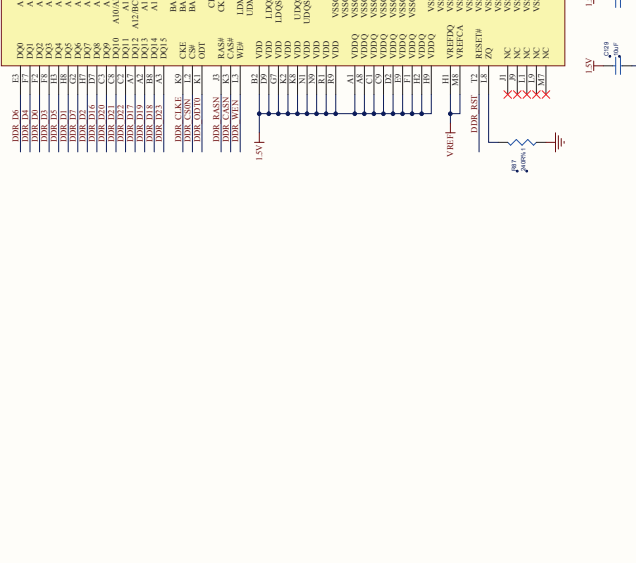
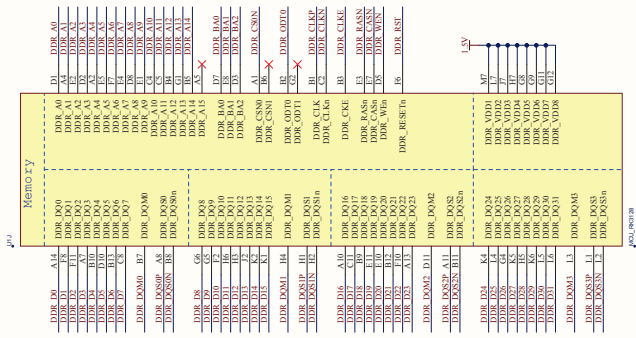

File	Number	Revision
DDR0-DDR15	A1	1.0
DDR16-DDR31	A2	1.0
DDR32-DDR47	A3	1.0

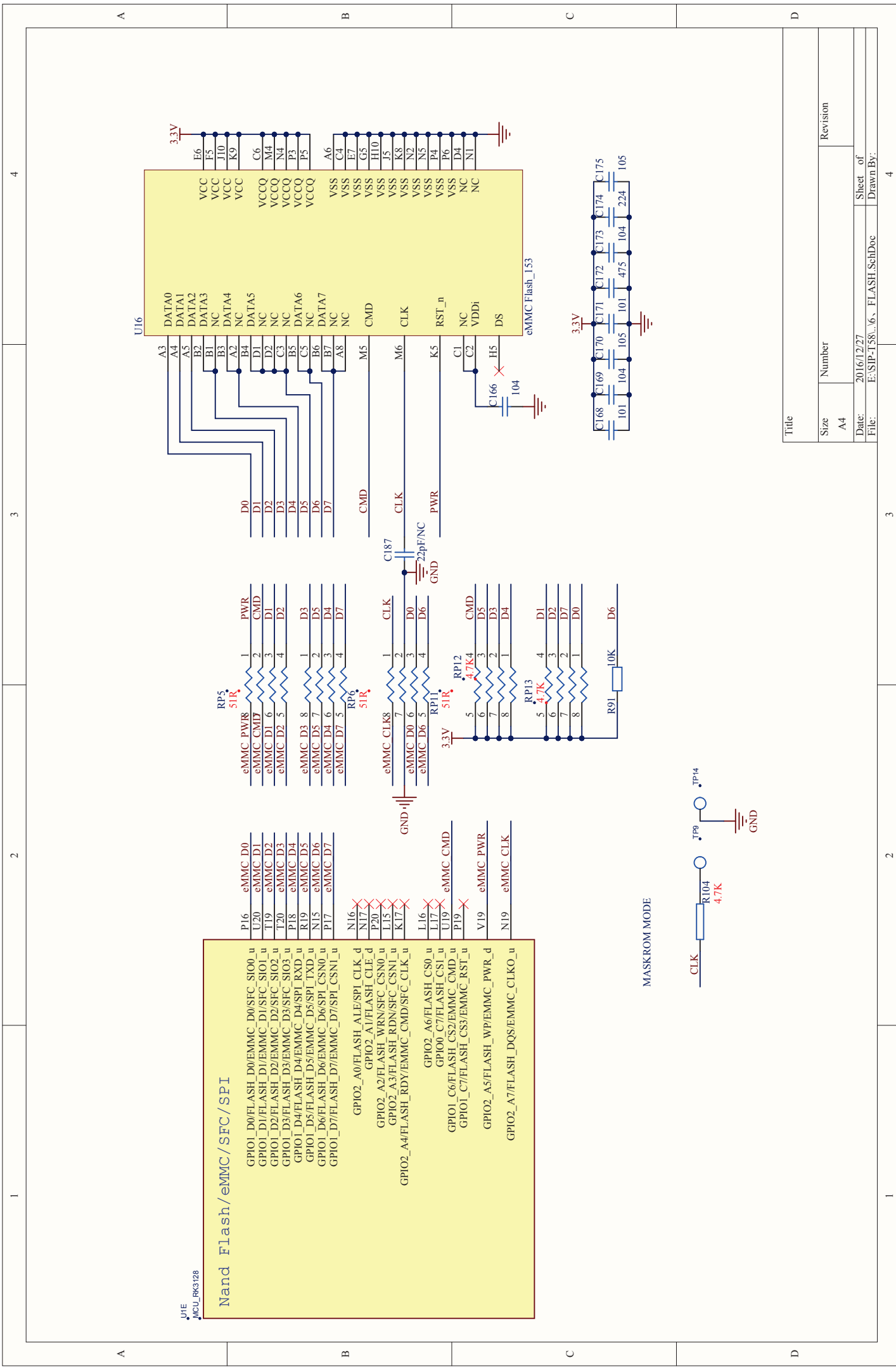

Title	
Size	Number
A4	
Date:	2016/12/27
File:	E:\SIP-T58\6_FLASH.SchDoc
Sheet of	4
Drawn By:	
Revision	

SoC		AP6212	
Ball Name	Ball No.	Ball Name	Ball No.
UART1_TX	H18	UART1_RXD	43
UART1_RX	H19	UART1_TXD	42
UART1_RTSN	G18	UART1_CTS_N	44
UART1_CTSN	G19	UART1_RTS_N	41

NOTE:
 1. RF matching components are needed to close to module as possible.
 2. Impedance of RF path must be reached 50 ohm by PCB structure.

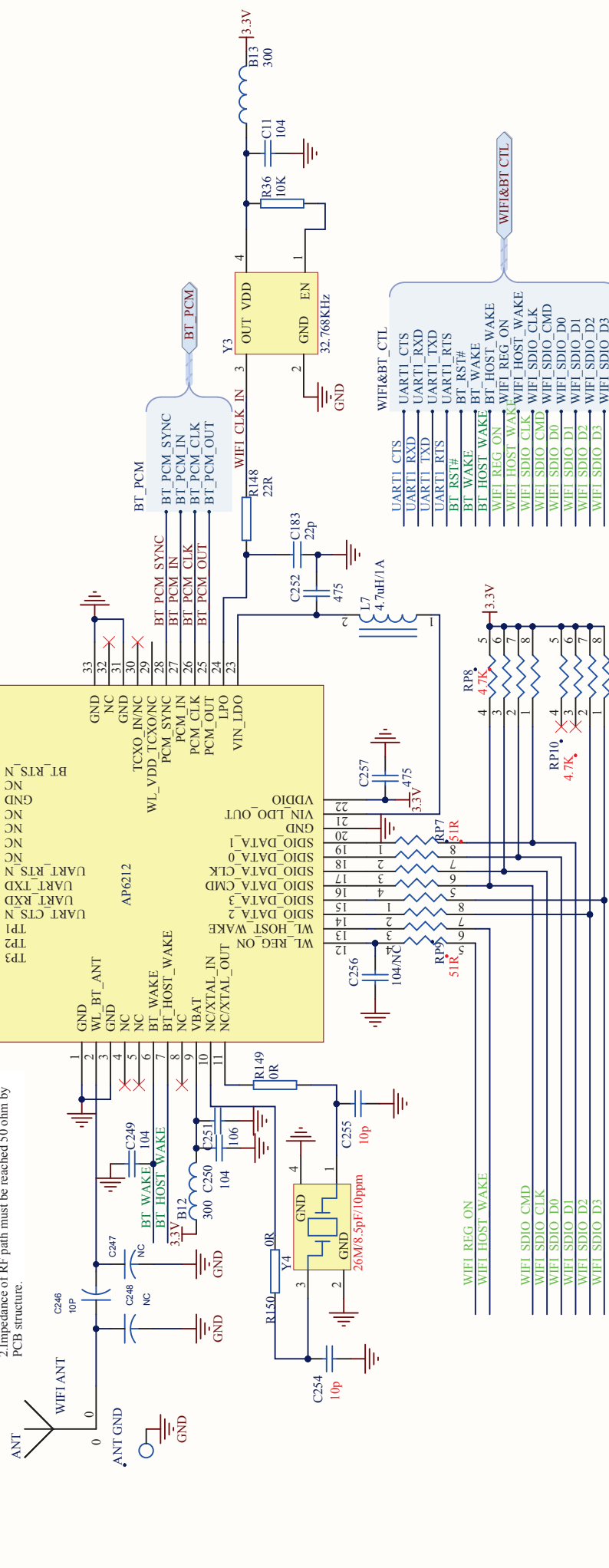

Title		Revision	
Size	Number	Sheet of	Drawn By:
A4		2016/12/27	
Date:		File:	E:\SIP-T58\8_ WiFi & BT_SchDoc
			4

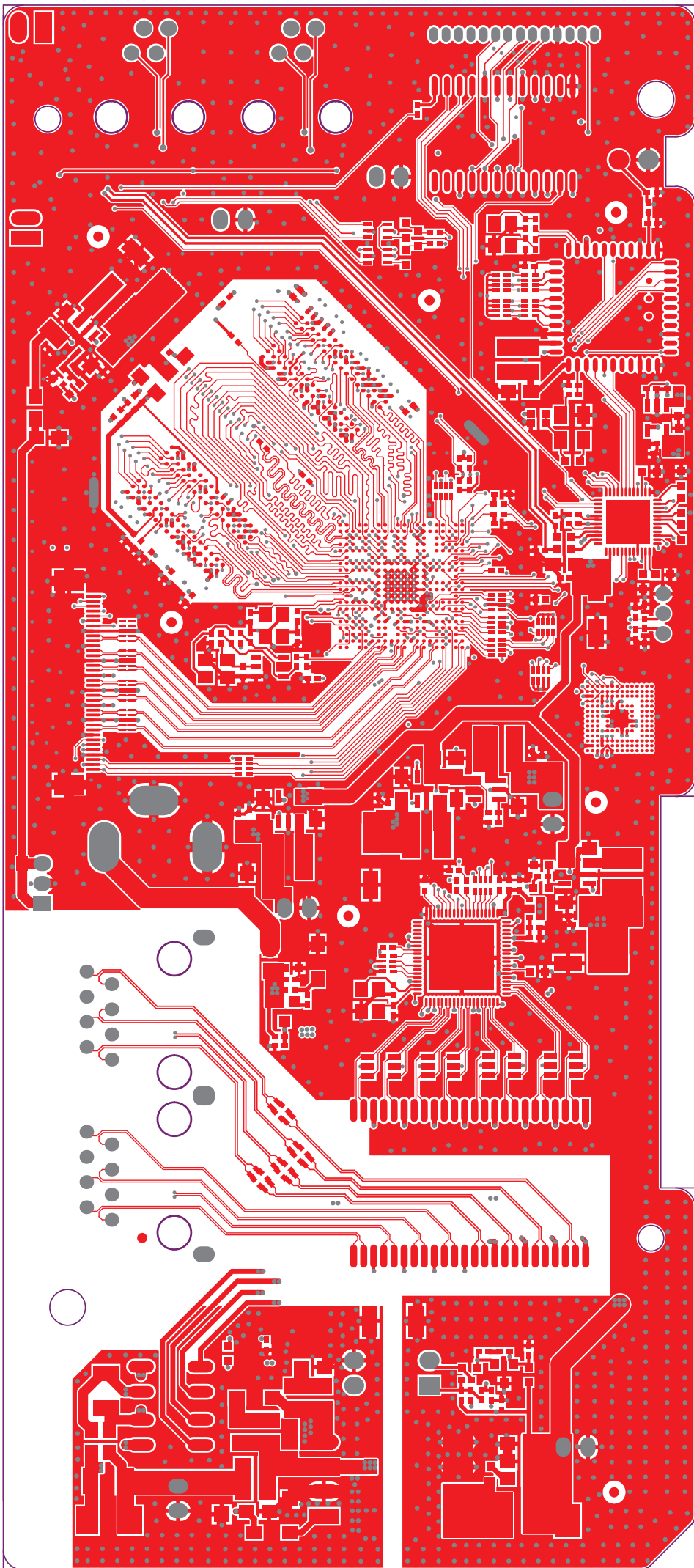

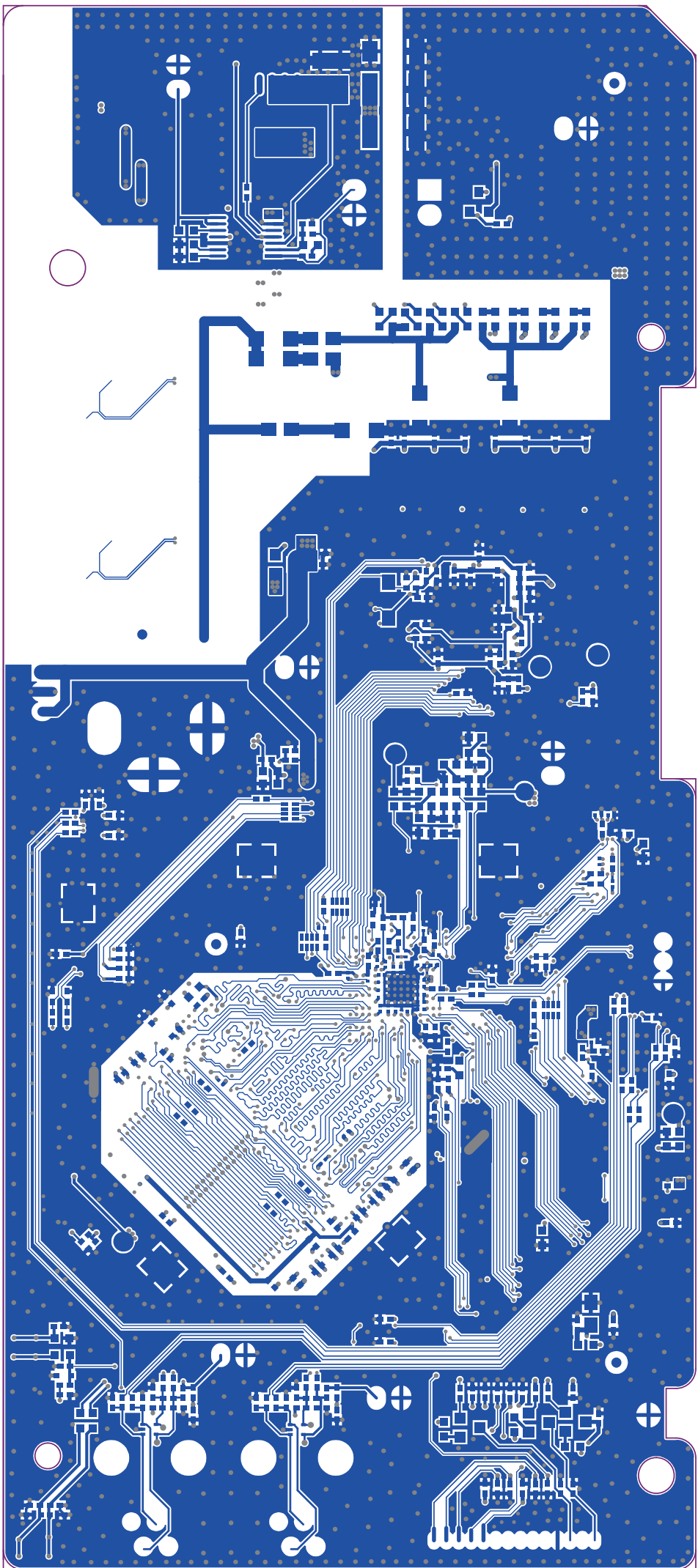

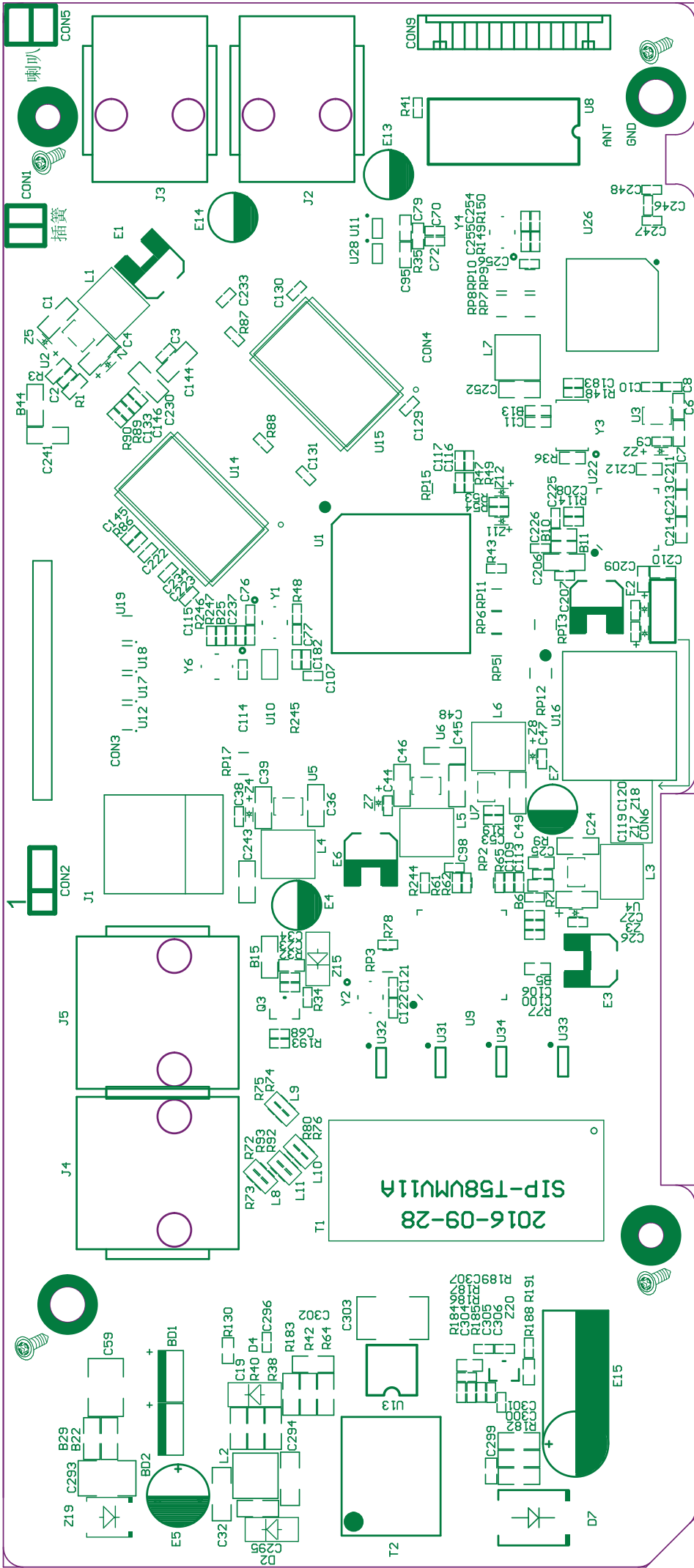

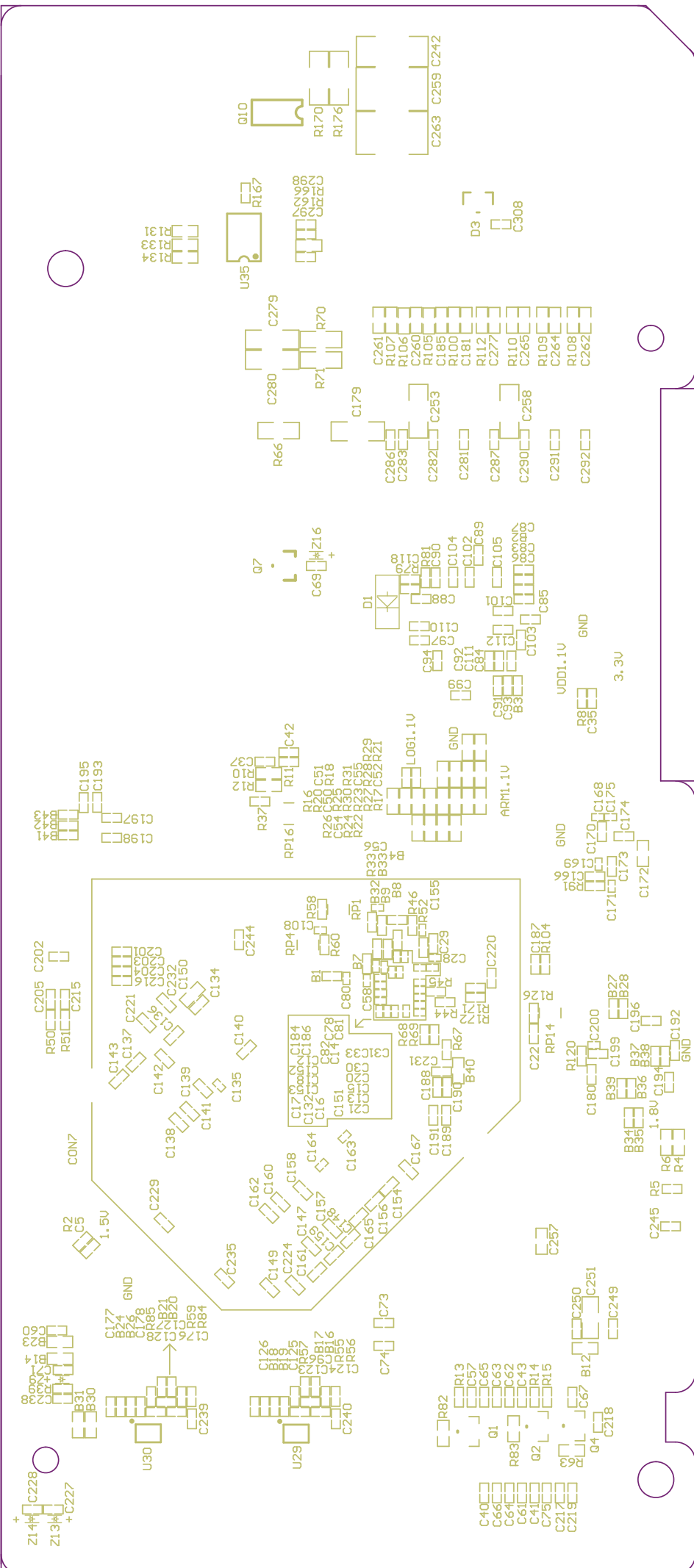

Z14
Z13
Z12
Z11
Z10
Z9
Z8
Z7
Z6
Z5
Z4
Z3
Z2
Z1

C228
C227
C226
C225
C224
C223
C222
C221
C220
C219
C218
C217
C216
C215
C214
C213
C212
C211
C210
C209
C208
C207
C206
C205
C204
C203
C202
C201

R2
R1
R0
R99
R98
R97
R96
R95
R94
R93
R92
R91
R90
R89
R88
R87
R86
R85
R84
R83
R82
R81
R80
R79
R78
R77
R76
R75
R74
R73
R72
R71
R70
R69
R68
R67
R66
R65
R64
R63
R62
R61
R60
R59
R58
R57
R56
R55
R54
R53
R52
R51
R50
R49
R48
R47
R46
R45
R44
R43
R42
R41
R40
R39
R38
R37
R36
R35
R34
R33
R32
R31
R30
R29
R28
R27
R26
R25
R24
R23
R22
R21
R20
R19
R18
R17
R16
R15
R14
R13
R12
R11
R10
R9
R8
R7
R6
R5
R4
R3
R2
R1

C177
C176
C175
C174
C173
C172
C171
C170
C169
C168
C167
C166
C165
C164
C163
C162
C161
C160
C159
C158
C157
C156
C155
C154
C153
C152
C151
C150
C149
C148
C147
C146
C145
C144
C143
C142
C141
C140
C139
C138
C137
C136
C135
C134
C133
C132
C131
C130
C129
C128
C127
C126
C125
C124
C123
C122
C121
C120
C119
C118
C117
C116
C115
C114
C113
C112
C111
C110
C109
C108
C107
C106
C105
C104
C103
C102
C101
C100
C99
C98
C97
C96
C95
C94
C93
C92
C91
C90
C89
C88
C87
C86
C85
C84
C83
C82
C81
C80
C79
C78
C77
C76
C75
C74
C73
C72
C71
C70
C69
C68
C67
C66
C65
C64
C63
C62
C61
C60
C59
C58
C57
C56
C55
C54
C53
C52
C51
C50
C49
C48
C47
C46
C45
C44
C43
C42
C41
C40
C39
C38
C37
C36
C35
C34
C33
C32
C31
C30
C29
C28
C27
C26
C25
C24
C23
C22
C21
C20
C19
C18
C17
C16
C15
C14
C13
C12
C11
C10
C9
C8
C7
C6
C5
C4
C3
C2
C1

U30
U29
U28
U27
U26
U25
U24
U23
U22
U21
U20
U19
U18
U17
U16
U15
U14
U13
U12
U11
U10
U9
U8
U7
U6
U5
U4
U3
U2
U1

D1
D2
D3
D4
D5
D6
D7
D8
D9
D10
D11
D12
D13
D14
D15
D16
D17
D18
D19
D20
D21
D22
D23
D24
D25
D26
D27
D28
D29
D30
D31
D32
D33
D34
D35
D36
D37
D38
D39
D40
D41
D42
D43
D44
D45
D46
D47
D48
D49
D50
D51
D52
D53
D54
D55
D56
D57
D58
D59
D60
D61
D62
D63
D64
D65
D66
D67
D68
D69
D70
D71
D72
D73
D74
D75
D76
D77
D78
D79
D80
D81
D82
D83
D84
D85
D86
D87
D88
D89
D90
D91
D92
D93
D94
D95
D96
D97
D98
D99
D100

Q10
Q9
Q8
Q7
Q6
Q5
Q4
Q3
Q2
Q1

R167
R166
R165
R164
R163
R162
R161
R160
R159
R158
R157
R156
R155
R154
R153
R152
R151
R150
R149
R148
R147
R146
R145
R144
R143
R142
R141
R140
R139
R138
R137
R136
R135
R134
R133
R132
R131
R130
R129
R128
R127
R126
R125
R124
R123
R122
R121
R120
R119
R118
R117
R116
R115
R114
R113
R112
R111
R110
R109
R108
R107
R106
R105
R104
R103
R102
R101
R100
R99
R98
R97
R96
R95
R94
R93
R92
R91
R90
R89
R88
R87
R86
R85
R84
R83
R82
R81
R80
R79
R78
R77
R76
R75
R74
R73
R72
R71
R70
R69
R68
R67
R66
R65
R64
R63
R62
R61
R60
R59
R58
R57
R56
R55
R54
R53
R52
R51
R50
R49
R48
R47
R46
R45
R44
R43
R42
R41
R40
R39
R38
R37
R36
R35
R34
R33
R32
R31
R30
R29
R28
R27
R26
R25
R24
R23
R22
R21
R20
R19
R18
R17
R16
R15
R14
R13
R12
R11
R10
R9
R8
R7
R6
R5
R4
R3
R2
R1

C280
C279
C278
C277
C276
C275
C274
C273
C272
C271
C270
C269
C268
C267
C266
C265
C264
C263
C262
C261
C260
C259
C258
C257
C256
C255
C254
C253
C252
C251
C250
C249
C248
C247
C246
C245
C244
C243
C242
C241
C240
C239
C238
C237
C236
C235
C234
C233
C232
C231
C230
C229
C228
C227
C226
C225
C224
C223
C222
C221
C220
C219
C218
C217
C216
C215
C214
C213
C212
C211
C210
C209
C208
C207
C206
C205
C204
C203
C202
C201

U35
U34
U33
U32
U31
U30
U29
U28
U27
U26
U25
U24
U23
U22
U21
U20
U19
U18
U17
U16
U15
U14
U13
U12
U11
U10
U9
U8
U7
U6
U5
U4
U3
U2
U1

C40
C39
C38
C37
C36
C35
C34
C33
C32
C31
C30
C29
C28
C27
C26
C25
C24
C23
C22
C21
C20
C19
C18
C17
C16
C15
C14
C13
C12
C11
C10
C9
C8
C7
C6
C5
C4
C3
C2
C1

