



FCC/ IC TEST REPORT

According to

CFR47 §15.247/ RSS-247 Issue 2

Applicant : YEALINK (XIAMEN) NETWORK TECHNOLOGY CO., LTD.
Address : 309, 3th Floor, No.16, Yun Ding North Road, Huli District, Xiamen City, Fujian, China
Manufacturer : YEALINK (XIAMEN) NETWORK TECHNOLOGY CO., LTD.
Address : 309, 3th Floor, No.16, Yun Ding North Road, Huli District, Xiamen City, Fujian, China
Equipment : Media IP Phone
Model No. : SIP-T54S
Brand : Yealink
FCC ID : T2C-T54S
RSS ID : 10741A-T54S

- The test result refers exclusively to the test presented test model / sample.
- Without written approval of **CerpPASS Technology (Suzhou) Corp.**, the test report shall not be reproduced except in full.

I **HEREBY CERTIFY THAT** :

The measurements shown in this test report were made in accordance with the procedures given in **ANSI C63.10 – 2013** and the energy emitted by this equipment was **passed**.

CISPR PUB. 22 and FCC Part 15 in both radiated and conducted emission class B limits. Testing was carried out on Feb 01,2017~Feb 28,2017 at **CerpPASS Technology (Suzhou) Co., Ltd.**

Prepared By:

Kerry Zhou

Approved by:

Miro Chueh (EMC/RF Manager)

Laboratory Accreditation:

CerpPASS Technology Corporation Test Laboratory

NVLAP LAB Code:	200954-0
TAF LAB Code:	1439

CerpPASS Technology (SuZhou) Co., Ltd.

NVLAP LAB Code:	200814-0
CNAS LAB Code:	L5515



Contents

1. Report of Measurements and Examinations	5
2. General Info.....	6
2.1 Description of EUT.....	6
2.2 Description of wireless module	6
2.3 Description of Antenna.....	6
2.4 Carrier Frequency of Channels.....	7
2.5 The Worst Case Configuration.....	7
2.6 EUT Exercise Software.....	8
2.7 Support equipment.....	9
3. General Information of Test Site	10
3.1 Information of Test Site	10
3.2 Measuring Equipment.....	10
3.3 Measurement Uncertainty.....	11
4. AC Conducted Emission Measurement	13
4.1 Test Limit.....	13
4.2 Test Procedures	13
4.3 Typical Test Setup.....	13
4.4 Test Result and Data.....	14
5. Radiated Emission Measurement	16
5.1 Test Limit.....	16
5.2 Test Standard	17
5.3 Test Procedures.....	17
5.4 Typical Test Setup	17
5.5 Test Result and Data.....	19
6. 20dB Bandwidth Measurement	39
6.1 Test Limit.....	39
6.2 Test Standard	39
6.3 Test Setup	39
6.4 Test Setup Layout	39
6.5 Test Result and Data.....	40
7. Channel Carrier Frequencies Separation Measurement	43
7.1 Test Limit.....	43
7.2 Test Standard	43
7.3 Test Setup	43
7.4 Test Setup Layout	43
7.5 Test Result and Data.....	44
8. Dwell Time Measurement.....	47
8.1 Test Limit.....	47
8.2 Test Standard	47
8.3 Test Setup	47
8.4 Test Setup Layout	47
8.5 Test Result and Data.....	48
9. Number of Hopping Channels Measurement	51



9.1 Test Limit 51

9.2 Test Standard 51

9.3 Test Setup 51

9.4 Test Setup Layout 51

9.5 Test Result and Data 52

10. Peak Output Power Measurement 55

10.1 Test Limit 55

10.2 Test Standard 55

10.3 Test Setup 55

10.4 Test Setup Layout 55

10.5 Test Result and Data 56

11. Conducted Spurious Emissions Measurement 59

11.1 Limit 59

11.2 Test Procedure 60

11.3 Test Setup 60

11.4 Test Result 61

12. Radiated Emission Band Edge Measurement 67

12.1 Limit 67

12.2 Test Procedure 67

12.3 Test Setup 68

12.4 Test Result 69



History of this Test Report

Report No.	Version	Issue Date	Description
SEFI1702033	Rev 01	Mar 10, 2017	Original.



1. Report of Measurements and Examinations

	Reference STD	Description of Test	Compliance results
1	FCC Rules §15.207(a); RSS-GEN Section 8.8	AC Conducted Emission	PASS
2	FCC Rules §15.209(a); RSS-247 Issue 2 Section 5.5	Radiated Emission	PASS
3	FCC Rules §15.247(a)(1); RSS-247 Issue 2 Section5.1(a)	20dB Bandwidth	PASS
4	FCC Rules §15.247(a)(1); RSS-247 Issue 2 Section5.1(b)	Channel Carrier Frequencies Separation	PASS
5	FCC Rules§15.247(a)(1); RSS-247 Issue 2 Section5.1(c)	Dwell Time	PASS
6	FCC Rules§15.247(b); RSS-247 Issue 2 Section5.1(b)	Number of Hopping Channels	PASS
7	FCC Rules §15.247(b); RSS-247 Issue 2 Section5.1(b)	Peak Output Power	PASS
8	FCC Rules §15.247(d)	Band-edge Compliance & Conducted Spurious Emissions	PASS
9	FCC Rules §15.247(d); RSS-247 Issue 2 Section 5.5	Radiated Emission Band Edges	PASS



2. General Info

2.1 Description of EUT

Product name	Media IP Phone
Model No.	SIP-T54S
Power supply#1	YLPS052000B-US
	100-240V~50/60Hz, 350mA
	5.0V $\frac{---}{---}$ 2.0A
Power supply#2	YLPS052000C-US
	100-240V~50/60Hz, 0.5A
	5.0V $\frac{---}{---}$ 2.0A

2.2 Description of wireless module

Module Name	RDA5876A
Bluetooth Specification	V2.1 + EDR
Modulation Type	GFSK, Pi/4 DQPSK, 8DPSK
Frequency Range	2402 - 2480 MHz
Channel Number	79
Data Rate	1Mbps(GFSK), 2Mbps(Pi/4 DQPSK), 3Mbps (8DPSK)
Channel Separation	1MHz

Note: For more details, please refer to the EUT User manual.

2.3 Description of Antenna

Antenna	Model No.	Peak Gain
PCB Antenna	HT1303	1.2dBi for 2.40~2.50GHz band



2.4 Carrier Frequency of Channels

Bluetooth Working Frequency of Each Channel:							
Channel	Frequency	Channel	Frequency	Channel	Frequency	Channel	Frequency
00	2402 MHz	01	2403 MHz	02	2404 MHz	03	2405 MHz
04	2406 MHz	05	2407 MHz	06	2408 MHz	07	2409 MHz
08	2410 MHz	09	2411 MHz	10	2412 MHz	11	2413 MHz
12	2414 MHz	13	2415 MHz	14	2416 MHz	15	2417 MHz
16	2418 MHz	17	2419 MHz	18	2420 MHz	19	2421 MHz
20	2422 MHz	21	2423 MHz	22	2424 MHz	23	2425 MHz
24	2426 MHz	25	2427 MHz	26	2428 MHz	27	2429 MHz
28	2430 MHz	29	2431 MHz	30	2432 MHz	31	2433 MHz
32	2434 MHz	33	2435 MHz	34	2436 MHz	35	2437 MHz
36	2438 MHz	37	2439 MHz	38	2440 MHz	39	2441 MHz
40	2442 MHz	41	2443 MHz	42	2444 MHz	43	2445 MHz
44	2446 MHz	45	2447 MHz	46	2448 MHz	47	2449 MHz
48	2450 MHz	49	2451 MHz	50	2452 MHz	51	2453 MHz
52	2454 MHz	53	2455 MHz	54	2456 MHz	55	2457 MHz
56	2458 MHz	57	2459 MHz	58	2460 MHz	59	2461 MHz
60	2462 MHz	61	2463 MHz	62	2464 MHz	63	2465 MHz
64	2466 MHz	65	2467 MHz	66	2468 MHz	67	2469 MHz
68	2470 MHz	69	2471 MHz	70	2472 MHz	71	2473 MHz
72	2474 MHz	73	2475 MHz	74	2476 MHz	75	2477 MHz
76	2478 MHz	77	2479 MHz	78	2480 MHz	N/A	N/A

2.5 The Worst Case Configuration

Data rate Configuration:

Test Mode	
DH5	✓
2DH5	✓
3DH5	✓



2.6 EUT Exercise Software

1	Turn on the power of equipment.
2	Run telnet command, input RF test command and set the test mode and channel, then press OK to start continue transmit or receive.



2.7 Support equipment

No.	Device	Manufacturer	Model No.	Description
1	Earphone	Yealink	N/A	N/A
2	POE Switch	D-Link	NES-1008P	Non-Shielded,1.8m
3	Notebook PC	Lenovo	G50	Non-Shielded,1.5m
4	Media IP Phone	Yealink	SIP-T54S	Non-Shielded,1.8m
5	Color-screen Expansion Modulec	Yealink	EXP50	N/A

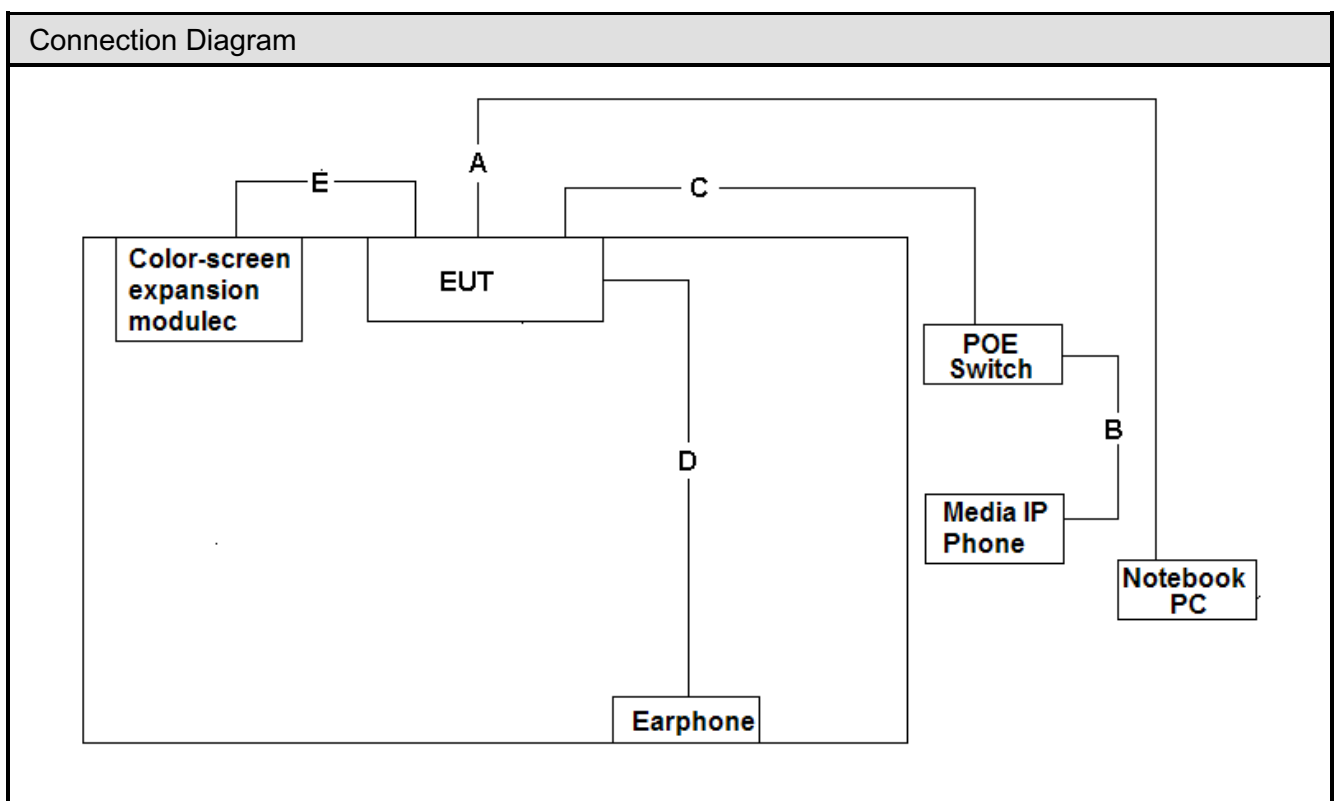

No.	Cable	Quantity	Description
A	LAN Cable	1	Shielded, > 3.0m
B	LAN Cable	1	Shielded, 2.0m
C	LAN Cable	1	Shielded, >3.0m
D	Audio Cable	1	Non-shielded, 2.0m
E	USB Cable	1	Shielded, 0.2m with a core



3. General Information of Test Site

3.1 Information of Test Site

Test Site	CerpPASS Technology(Suzhou) Co., Ltd.
Test Site Location	No.66,Tangzhuang Road, Suzhou Industrial Park, Jiangsu 215006, China
NVLAP LAB Code	200814-0
FCC Registration Number	916572, 331395
IC Registration Number	7290A-1, 7290A-2
VCCI Registration Number	T-1945 for Telecommunication Test C-2919 for Conducted emission test R-2670 for Radiated emission test below 1GHz G-227 for Radiated emission test above 1GHz

3.2 Measuring Equipment

RF Conducted Measuring Equipment-AC104					
Instrument/Ancillary	Manufacturer	Model No.	Serial No.	Calibration Date	Valid Date.
PC	Lenovo	E40-70	MP078UQV	N/A	N/A
Peak Power Sensor	Boonton	55006	9778	2016.06.08	2017.06.07
Series Power Meter	ANRITSU	ML2495A	1224005	2016/3/27	2017/3/26
Temperature/Humidity Meter	Zhicheng	ZC1-11	CEP-TH-003	2016/3/31	2017/3/30
Spectrum Analyzer	N9010A	Agilent	MY53400169	2015.11.11	2017.11.11
Spectrum Analyzer	E4407B	Agilent	MY44211883	2015.10.15	2017.10.14

AC Conducted Measuring Equipment-SR101					
Instrument/Ancillary	Manufacturer	Model No.	Serial No.	Calibration Date	Valid Date.
Test Receiver	R&S	ESCI	100565	2016.07.07	2017.07.06
AMN	R&S	ESH2-Z5	100182	2016.09.06	2017.09.05
Two-Line V-Network	R&S	ENV216	100325	N/A	N/A
ISN	FCC	FCC-TLISN-T2-02	20379	2016.03.26	2017.03.25
ISN	FCC	FCC-TLISN-T4-02	20380	2016.06.24	2017.06.24
ISN	FCC	FCC-TLISN-T8-02	20381	2016.03.26	2017.03.25
ISN	TESEQ	ISN ST08	30175	2016.03.26	2017.03.25
Current Probe	R&S	EZ-17	100303	2016.03.26	2017.03.25
Passive Voltage Probe	R&S	ESH2-Z3	100026	2016.03.26	2017.03.25
Pulse Limiter	R&S	ESH3-Z2	100529	2016.03.26	2017.03.25
Temperature/Humidity Meter	Zhicheng	ZC1-11	CEP-TH-004	2016.03.29	2017.03.28
EZ-EMC	Fala	Ver CT3A1	N/A	N/A	N/A



Radiated Measuring Equipment-AC102					
Instrument/Ancillary	Manufacturer	Model No.	Serial No.	Calibration Date	Valid Date.
EMI Test Receiver	R&S	ESCI	101183	2016.06.29	2017.06.28
Spectrum Analyzer	N9010A	Agilent	MY53400169	2016.11.11	2017.11.11
Spectrum Analyzer	R&S	FSP40	100324	2016.03.26	2017.03.25
Preamplifier	COM-POWER	PA-840	711885	2016.03.26	2017.03.25
Loop Antenna	R&S	HFH2-Z2	100150	2016.09.10	2017.09.09
Bilog Antenna	Sunol Science	JB1	A072414-1	2016.04.16	2017.04.15
Broad-Band Horn Antenna	Schwarzbeck	BBHA9120D	9120D-619	2016.04.16	2017.04.15
Broad-Band Horn Antenna	Schwarzbeck	BBHA9170	9170-347	2016.04.16	2017.04.15
Temperature/ Humidity Meter	Zhicheng	ZC1-11	CEP-TH-002	2016.03.31	2017.03.30

3.3 Measurement Uncertainty

ISO/IEC 17025 requires that an estimate of the measurement uncertainties associated with the emissions test results be included in the report. The measurement uncertainties given below are based on a 95% confidence level (based on a coverage factor (k=2)).

RF Conducted Measurement

Test Item		Uncertainty	Limit
Radio Frequency		$\pm 8.7 \times 10^{-7}$	$\pm 1 \times 10^{-5}$
RF output power, conducted		$\pm 0.63\text{dB}$	$\pm 1.5\text{dB}$
Power density, conducted		$\pm 1.21\text{dB}$	$\pm 3\text{dB}$
Unwanted emissions, conducted	30-1000MHz	$\pm 0.51\text{dB}$	$\pm 3\text{dB}$
	1-12.75GHz	$\pm 0.67\text{dB}$	$\pm 3\text{dB}$
All emissions, radiated	30-1000MHz	$\pm 2.28\text{dB}$	$\pm 6\text{dB}$
	1-12.75GHz	$\pm 2.59\text{dB}$	$\pm 6\text{dB}$
Temperature		$\pm 0.8^\circ\text{C}$	$\pm 1^\circ\text{C}$
Humidity		$\pm 3\%$	$\pm 5\%$
DC and low frequency voltages		$\pm 3\%$	$\pm 3\%$



AC Conducted Measurement

Measurement	Frequency	Uncertainty
Conducted emissions(LINE)	9KHz-30MHz	+/- 0.7738 dB
Conducted emissions(NEUTRAL)	9KHz-30MHz	+/- 0.7886 dB
Conducted emissions(10Mbps)	150KHz-30MHz	+/- 1.3013dB
Conducted emissions(100Mbps)	150KHz-30MHz	+/- 1.3197 dB
Conducted emissions(1000Mbps)	150KHz-30MHz	+/- 1.2987 dB

Radiated Measurement

Measurement	Polarity	Frequency	Uncertainty
Radiated emissions	Horizontal	below 1GHz	+/- 3.8936 dB
	Vertical	below 1GHz	+/- 3.8928 dB
	Horizontal	above 1GHz	+/- 5.18858dB
	Vertical	above 1GHz	+/- 5.18928 dB



4. AC Conducted Emission Measurement

4.1 Test Limit

Conducted Emissions were measured from 150 kHz to 30 MHz with a bandwidth of 9 KHz on the 120 VAC power and return leads of the EUT according to the methods defined in ANSI C63.10-2013 Section 6.2. The EUT was placed on a nonmetallic stand in a shielded room 0.8 meters above the ground plane as shown in section 6.2.2. The interface cables and equipment positioning were varied within limits of reasonable applications to determine the position produced maximum conducted emissions.

Frequency (MHz)	Quasi Peak (dB μ V)	Average (dB μ V)
0.15 – 0.5	66-56*	56-46*
0.5 – 5.0	56	46
5.0 – 30.0	60	50

*Decreases with the logarithm of the frequency.

4.2 Test Procedures

- The EUT was placed 0.4 meter from the conducting wall of the shielding room was kept at least 80 centimeters from any other grounded conducting surface.
- Connect EUT to the power mains through a line impedance stabilization network (LISN).
- All the support units are connecting to the other LISN.
- The LISN provides 50 ohm coupling impedance for the measuring instrument.
- The FCC states that a 50 ohm, 50 micro-Henry LISN should be used.
- Both sides of AC line were checked for maximum conducted interference.
- The frequency range from 150 kHz to 30 MHz was searched.
- Set the test-receiver system to Peak Detect Function and Specified Bandwidth with Maximum Hold Mode.

4.3 Typical Test Setup

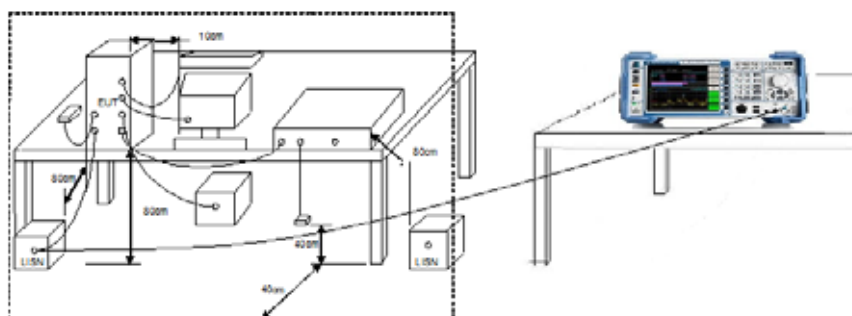



4.4 Test Result and Data

Test Mode :	Mode 1: Normal Operation with BT on		
AC Power :	AC 120V/60Hz	Phase:	LINE
Temperature :	26°C	Humidity:	60%
Pressure(mbar) :	1002	Date:	2017/02/24

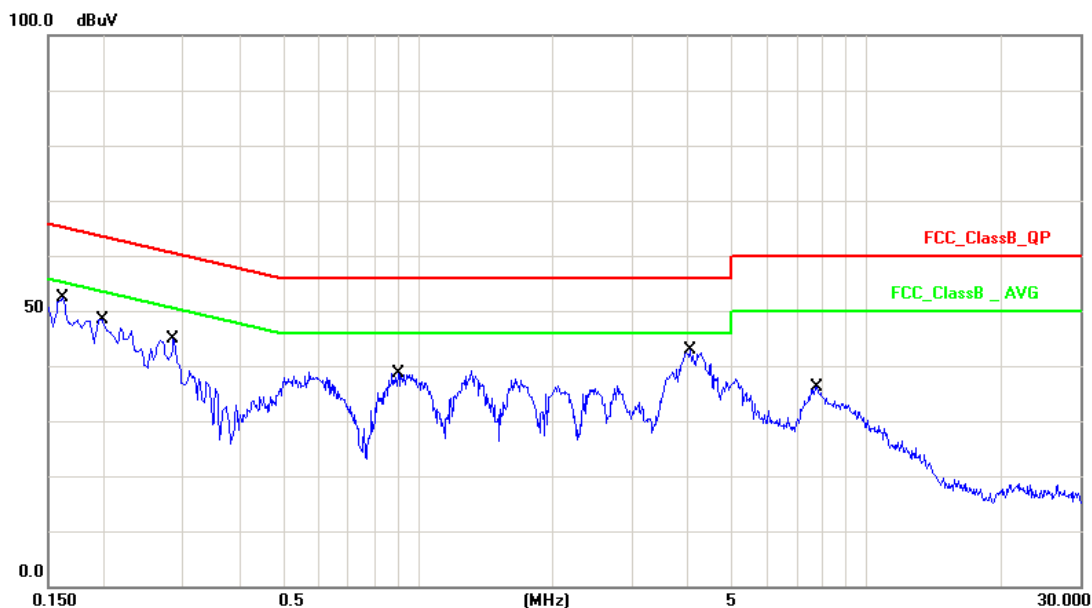

No.	Frequency (MHz)	Factor (dB)	Reading (dBuV)	Level (dBuV)	Limit (dBuV)	Margin (dB)	Detector
1	0.1620	10.13	35.50	45.63	65.36	-19.73	QP
2	0.1620	10.13	21.35	31.48	55.36	-23.88	AVG
3	0.1980	10.12	31.24	41.36	63.69	-22.33	QP
4	0.1980	10.12	16.46	26.58	53.69	-27.11	AVG
5	0.2860	10.14	30.04	40.18	60.64	-20.46	QP
6	0.2860	10.14	24.39	34.53	50.64	-16.11	AVG
7	0.9060	10.15	24.72	34.87	56.00	-21.13	QP
8	0.9060	10.15	19.53	29.68	46.00	-16.32	AVG
9	4.0580	10.20	28.44	38.64	56.00	-17.36	QP
10	4.0580	10.20	21.78	31.98	46.00	-14.02	AVG
11	7.8020	10.25	20.28	30.53	60.00	-29.47	QP
12	7.8020	10.25	12.50	22.75	50.00	-27.25	AVG

Note: Measurement Level = Reading Level + Correct Factor



Test Mode :	Mode 1: Normal Operation with BT on		
AC Power :	AC 120V/60Hz	Phase :	NEUTRAL
Temperature :	26°C	Humidity :	60%
Pressure(mbar) :	1002	Date:	2017/02/24

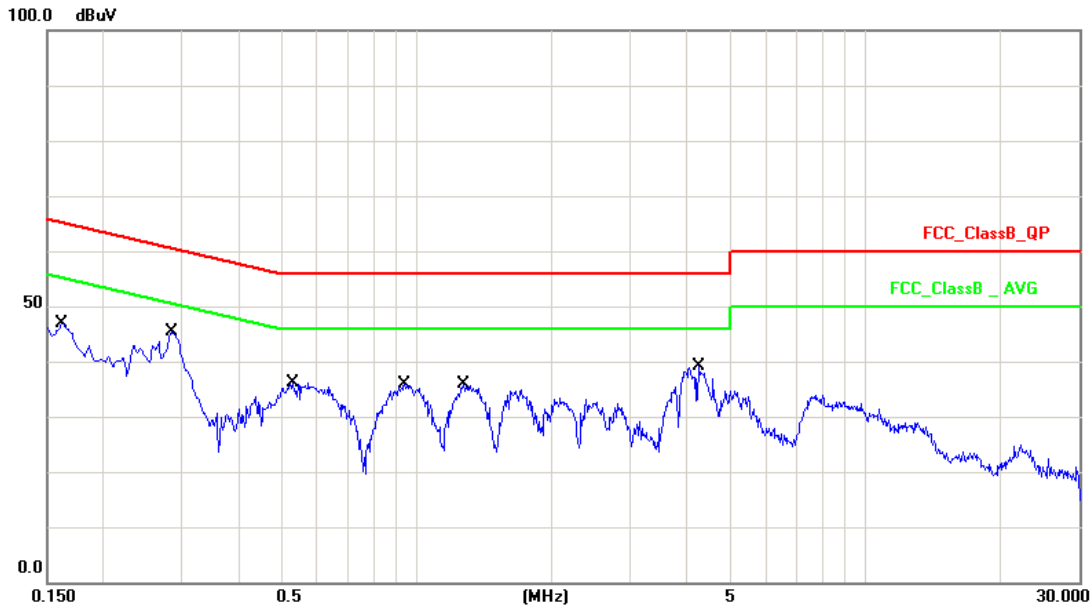

No.	Frequency (MHz)	Factor (dB)	Reading (dBuV)	Level (dBuV)	Limit (dBuV)	Margin (dB)	Detector
1	0.1620	10.13	30.70	40.83	65.36	-24.53	QP
2	0.1620	10.13	18.54	28.67	55.36	-26.69	AVG
3	0.2860	10.14	29.97	40.11	60.64	-20.53	QP
4	0.2860	10.14	21.34	31.48	50.64	-19.16	AVG
5	0.5299	10.15	21.99	32.14	56.00	-23.86	QP
6	0.5299	10.15	16.38	26.53	46.00	-19.47	AVG
7	0.9420	10.17	22.00	32.17	56.00	-23.83	QP
8	0.9420	10.17	16.63	26.80	46.00	-19.20	AVG
9	1.2740	10.18	20.59	30.77	56.00	-25.23	QP
10	1.2740	10.18	15.34	25.52	46.00	-20.48	AVG
11	4.2580	10.24	21.79	32.03	56.00	-23.97	QP
12	4.2580	10.24	12.28	22.52	46.00	-23.48	AVG

Note: Measurement Level = Reading Level + Correct Factor



5. Radiated Emission Measurement

5.1 Test Limit

In any 100kHz bandwidth outside the frequency band in which the spread spectrum or digitally modulated intentional radiator is operating, the radio frequency power that is produced by the intentional radiator shall be at least 20dB below that in the 100kHz bandwidth within the band that contains the highest level of the desired power, based on either an RF conducted or a radiated measurement. If the transmitter measurement is based on the maximum conducted output power, the attenuation required under this paragraph shall be 30dB instead of 20dB. In addition, radiated emissions which fall in section 15.205(a) the restricted bands must also comply with the radiated emission limit specified in section 15.209(a).

FREQUENCIES (MHz)	FIELD STRENGTH (micro volts/meter)	MEASUREMENT DISTANCE (meters)
0.009~0.490	2400/F(kHz)	300
0.490~1.705	24000/F(kHz)	30
1.705~30.0	30	30
30~88	100	3
88~216	150	3
216~960	200	3
Above 960	500	3

For unintentional device, according to CISPR PUB.22, for Class B digital devices, the general requirement of field strength of radiated emissions from intentional radiators at a distance of 10 meters shall not exceed the above table.

Frequency (MHz)	Distance Meters	Radiated (dB μ V/ M)
30-230	10	30
230-1000	10	37



5.2 Test Standard

ANSI C63.10-2013-Section 6.10.5

5.3 Test Procedures

- a. The EUT was placed on a rotatable table top 0.8 meter for frequency below 1GHz and 1.5meter for frequency above 1GHz above ground.
- b. The EUT was set 3 meters from the interference receiving antenna which was mounted on the top of a variable height antenna tower.
- c. The table was rotated 360 degrees to determine the position of the highest radiation.
- d. The antenna is a broadband antenna and its height is varied between one meter and four meters above ground to find the maximum value of the field strength both horizontal polarization and vertical polarization of the antenna are set to make the measurement.
- e. For each suspected emission the EUT was arranged to its worst case and then tune the antenna tower (from 1 M to 4 M) and turn table (from 0 degree to 360 degrees) to find the maximum reading.
- f. Set the test-receiver system to Peak or CISPR quasi-peak Detect Function and specified bandwidth with Maximum Hold Mode.
- g. If the emission level of the EUT in peak mode was 3 dB lower than the limit specified, then testing will be stopped and peak values of EUT will be reported, otherwise, the emissions which do not have 3 dB margin will be repeated one by one using the quasi-peak method and reported.
- h. For testing above 1GHz, the emission level of the EUT in peak mode was 20dB lower than average limit (that means the emission level in peak mode also complies with the limit in average mode), then testing will be stopped and peak values of EUT will be reported, otherwise, the emissions will be measured in average mode again and reported.

5.4 Typical Test Setup

9kHz~30MHz Test Setup

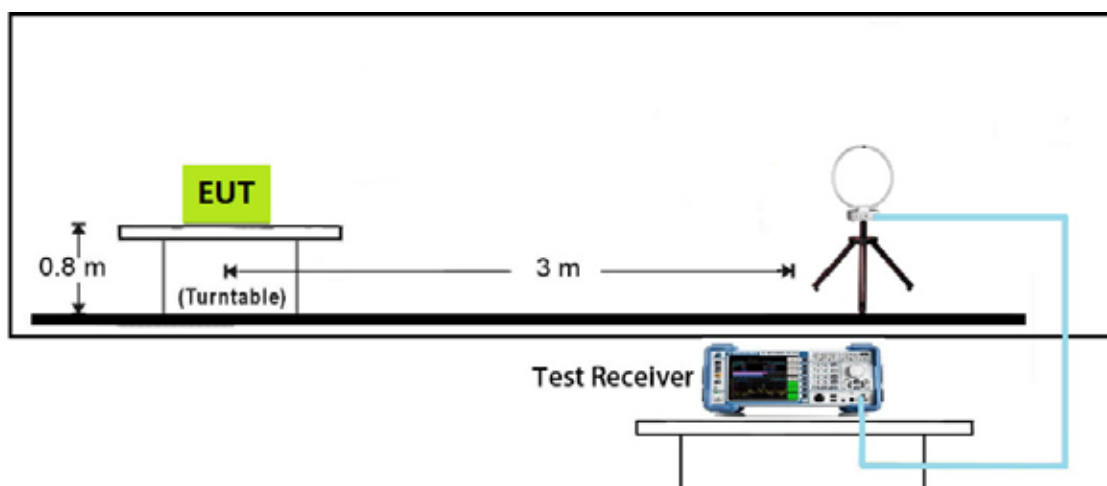



Below 1GHz Test Setup

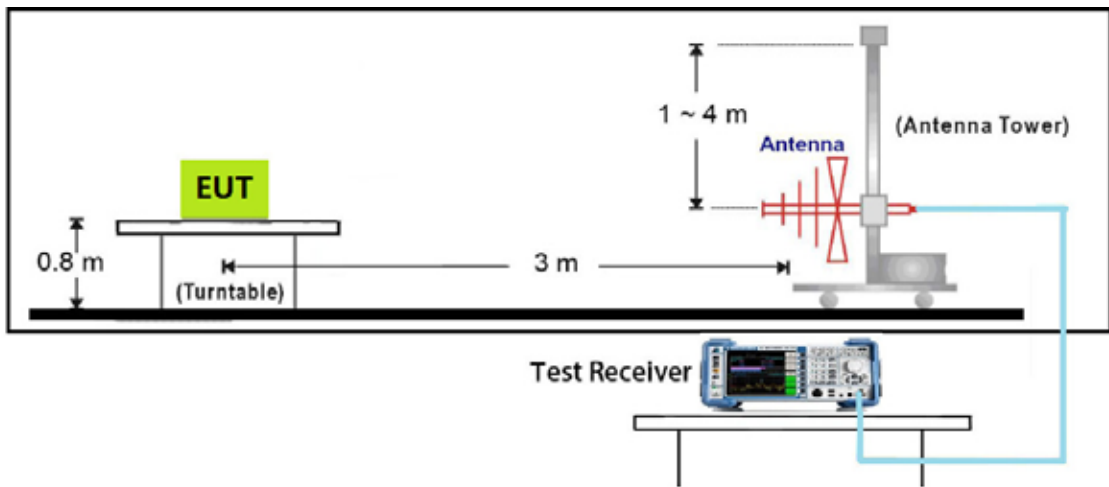

1GHz~18GHz Test Setup

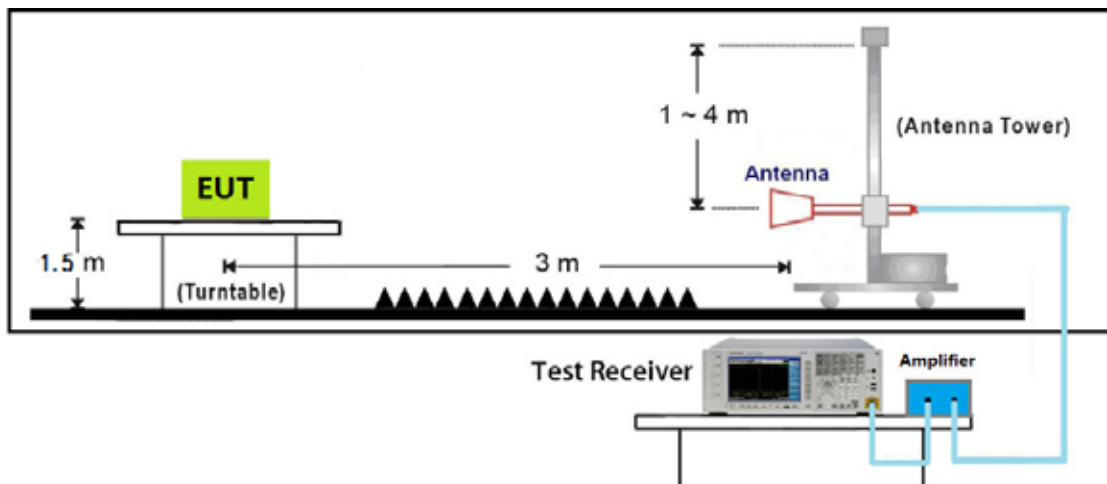

18GHz~40GHz Test Setup

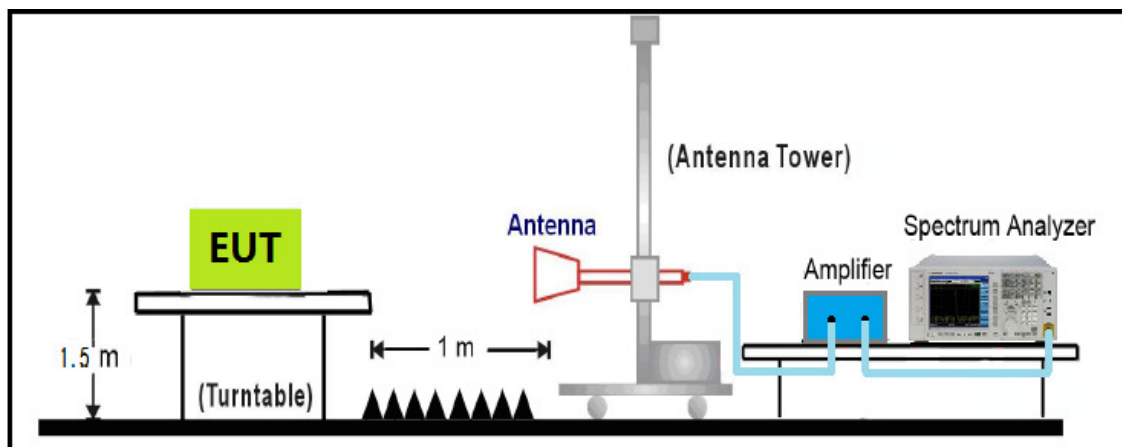



5.5 Test Result and Data

The worst case of Radiated Emission below 1GHz:

Limit: FCC_Part15.209_RE(3m)	Margin: 0
Probe: CBL6112D (30-1000MHz)	Polarity: Horizontal
EUT: SIP-T54S	Power: AC 120V/60Hz
Note: Mode1: Transmit at channel 2402MHz by DH5	

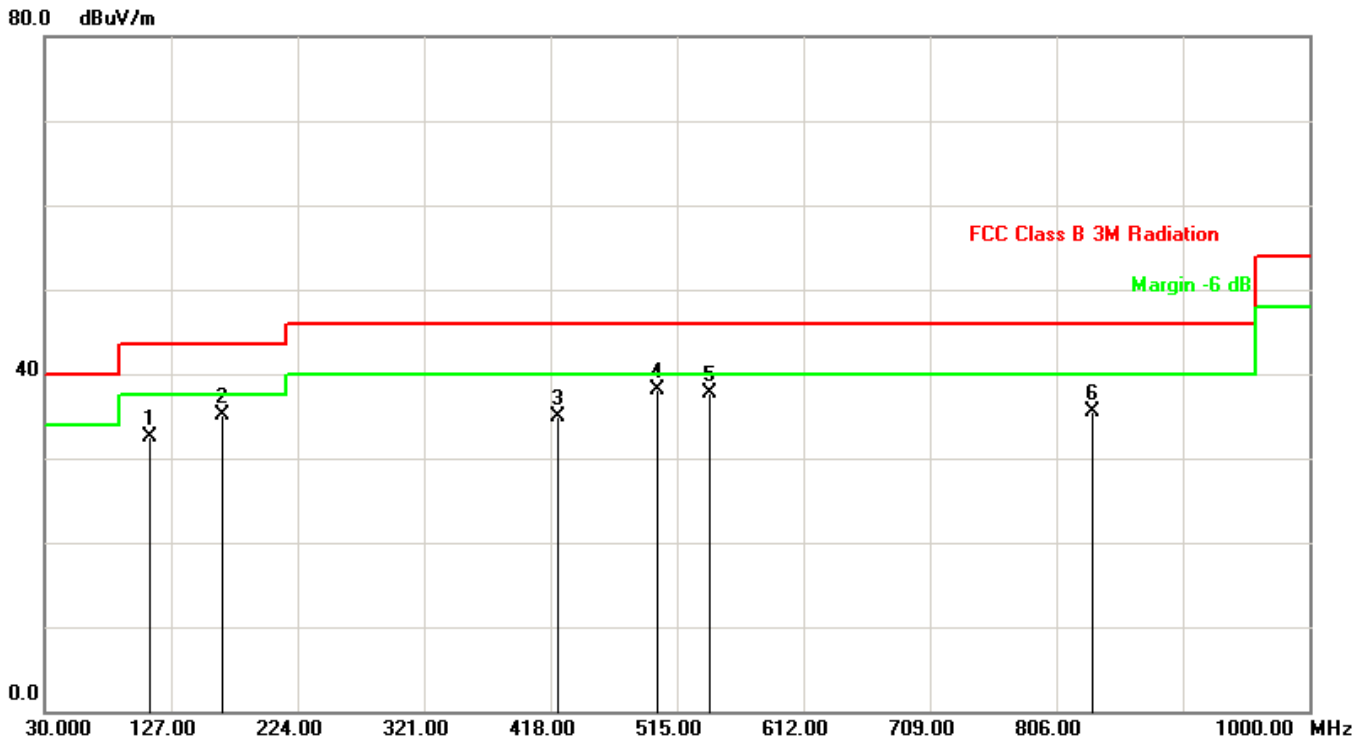

No.	Frequency (MHz)	Factor (dB/m)	Reading (dBuV)	Level (dBuV/m)	Limit (dBuV/m)	Margin (dB)	Det.
1	110.5100	-11.23	43.82	32.59	43.50	-10.91	QP
2	166.7700	-7.54	42.74	35.20	43.50	-8.30	QP
3	423.8199	-3.69	38.63	34.94	46.00	-11.06	QP
4	500.4499	-4.85	42.93	38.08	46.00	-7.92	QP
5	540.2199	-4.01	41.78	37.77	46.00	-8.23	QP
6	834.1299	1.31	34.21	35.52	46.00	-10.48	QP



Limit: FCC_Part15.209_RE(3m)	Margin: 0
Probe: CBL6112D (30-1000MHz)	Polarity: Vertical
EUT: SIP-T54S	Power: AC 120V/60Hz
Note: Mode1: Transmit at channel 2402MHz by DH5	

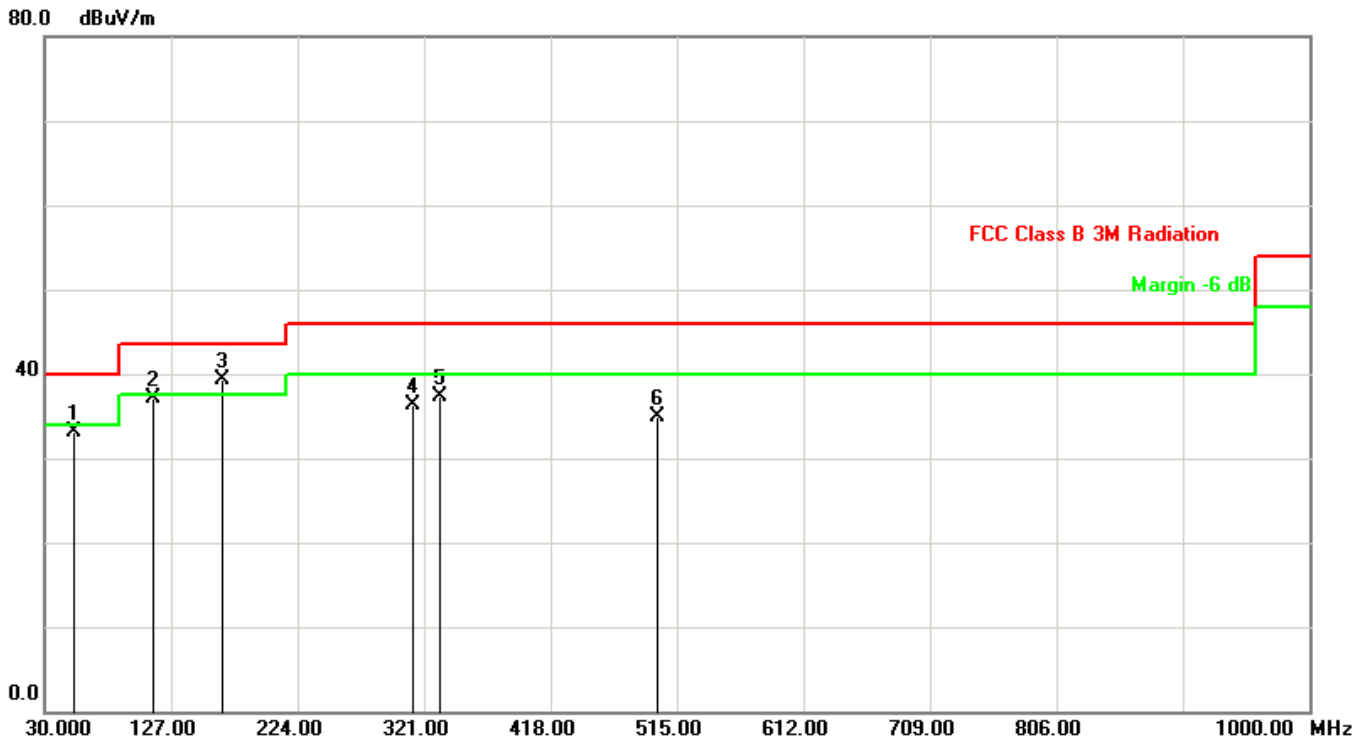

No.	Frequency (MHz)	Factor (dB/m)	Reading (dBuV)	Level (dBuV/m)	Limit (dBuV/m)	Margin (dB)	Det.
1	52.3100	-11.37	44.48	33.11	40.00	-6.89	QP
2	113.4200	-10.80	47.83	37.03	43.50	-6.47	QP
3	166.7700	-7.54	46.88	39.34	43.50	-4.16	QP
4	312.2699	-7.03	43.33	36.30	46.00	-9.70	QP
5	333.6099	-6.47	43.85	37.38	46.00	-8.62	QP
6	500.4499	-4.85	39.67	34.82	46.00	-11.18	QP



Radiated Emission above 1GHz:

Engineer: Ternence	
Site: AC102	Time: 2017/02/28
Limit: FCC_Part15.209_RE(3m)	Margin: 0
Probe: BBHA9120D_1-18GHz	Polarity: Vertical
EUT: SIP-T54S	Power: AC 120V/60Hz
Note: Mode : Transmits at 2402MHz by DH5	

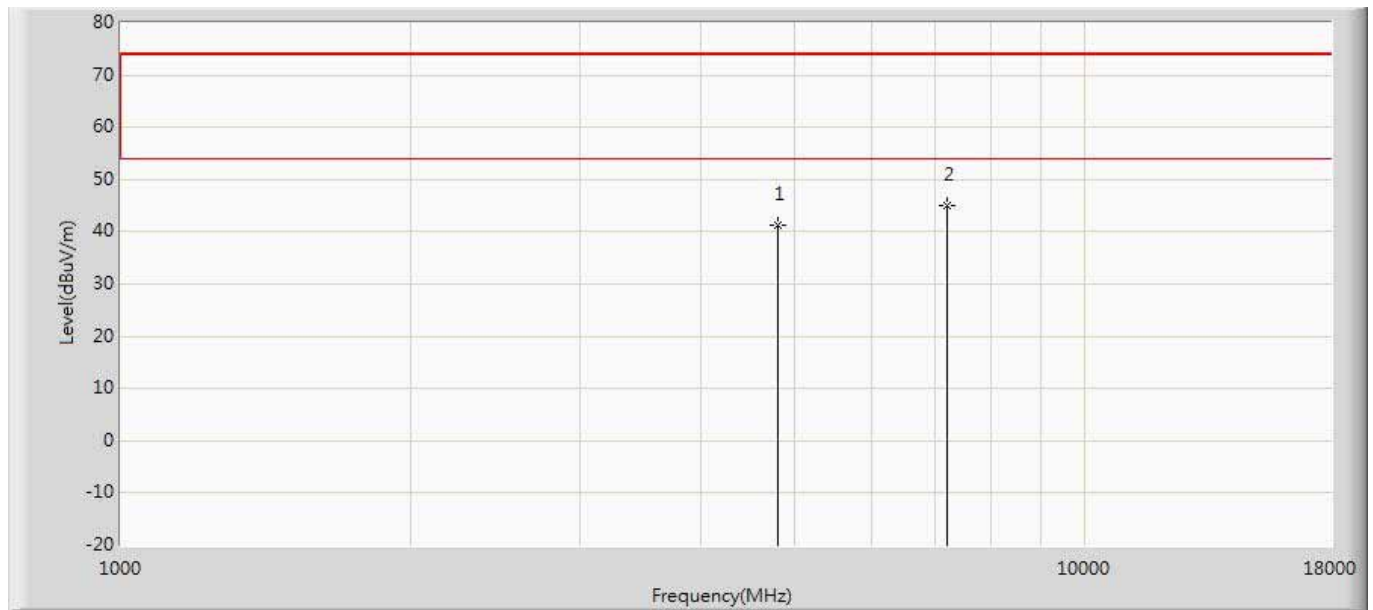

No	Mark	Frequency (MHz)	Measure Level (dBuV/m)	Reading Level (dBuV)	Over Limit (dB)	Limit (dBuV/m)	Factor (dB)	Type
1		4804.000	44.328	52.638	-29.672	74.000	-8.310	PK
2	*	7206.000	43.039	46.499	-30.961	74.000	-3.460	PK



Engineer: Ternence	
Site: AC102	Time: 2017/02/28
Limit: FCC_Part15.209_RE(3m)	Margin: 0
Probe: BBHA9120D_1-18GHz	Polarity: Horizontal
EUT: SIP-T54S	Power: AC 120V/60Hz
Note: Mode : Transmits at 2402MHz by DH5	

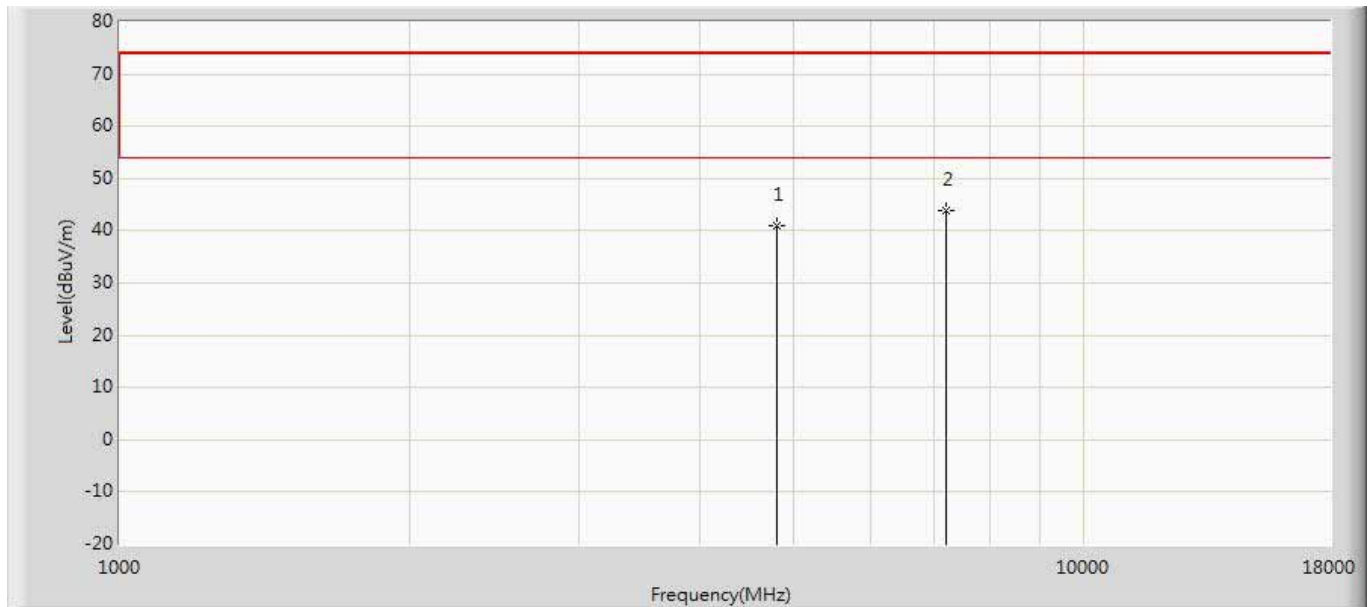

No	Mark	Frequency (MHz)	Measure Level (dBuV/m)	Reading Level (dBuV)	Over Limit (dB)	Limit (dBuV/m)	Factor (dB)	Type
1		4804.000	45.024	53.458	-28.976	74.000	-8.434	PK
2	*	7206.000	40.616	44.112	-33.384	74.000	-3.496	PK



Engineer: Ternence	
Site: AC102	Time: 2017/02/28
Limit: FCC_Part15.209_RE(3m)	Margin: 0
Probe: BBHA9120D_1-18GHz	Polarity: Horizontal
EUT: SIP-T54S	Power: AC 120V/60Hz
Note: Mode : Transmits at 2441MHz by DH5	

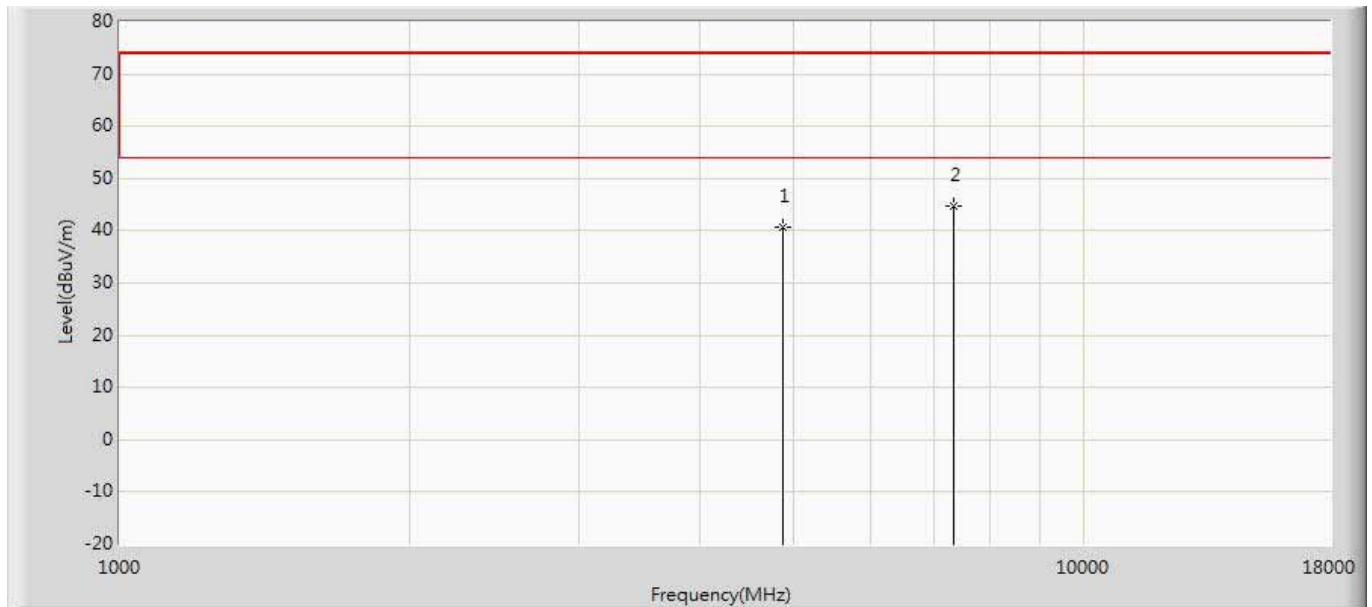

No	Mark	Frequency (MHz)	Measure Level (dBuV/m)	Reading Level (dBuV)	Over Limit (dB)	Limit (dBuV/m)	Factor (dB)	Type
1		4882.000	45.192	53.495	-28.808	74.000	-8.303	PK
2	*	7323.000	43.461	46.721	-30.539	74.000	-3.260	PK



Engineer: Ternence	
Site: AC102	Time: 2017/02/28
Limit: FCC_Part15.209_RE(3m)	Margin: 0
Probe: BBHA9120D_1-18GHz	Polarity: Vertical
EUT: SIP-T54S	Power: AC 120V/60Hz
Note: Mode : Transmits at 2441MHz by DH5	

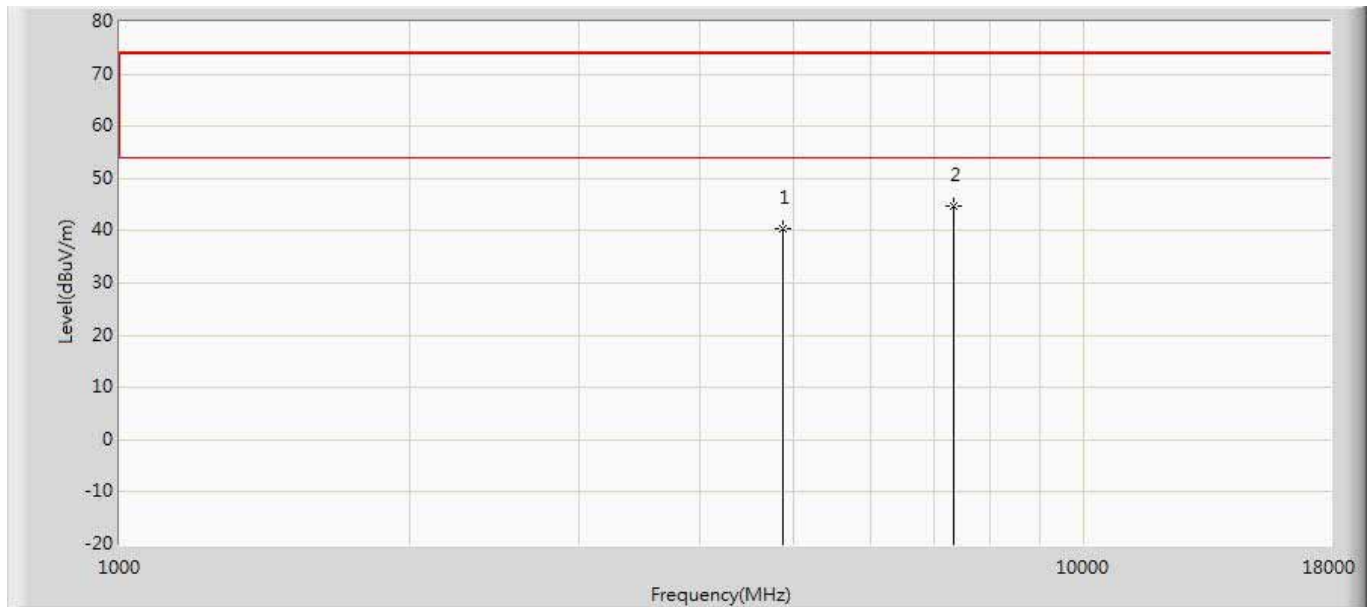

No	Mark	Frequency (MHz)	Measure Level (dBuV/m)	Reading Level (dBuV)	Over Limit (dB)	Limit (dBuV/m)	Factor (dB)	Type
1		4882.000	45.543	53.831	-28.457	74.000	-8.288	PK
2	*	7323.000	39.389	42.882	-34.611	74.000	-3.493	PK



Engineer: Ternence	
Site: AC102	Time: 2017/02/28
Limit: FCC_Part15.209_RE(3m)	Margin: 0
Probe: BBHA9120D_1-18GHz	Polarity: Vertical
EUT: SIP-T54S	Power: AC 120V/60Hz
Note: Mode : Transmits at 2480MHz by DH5	

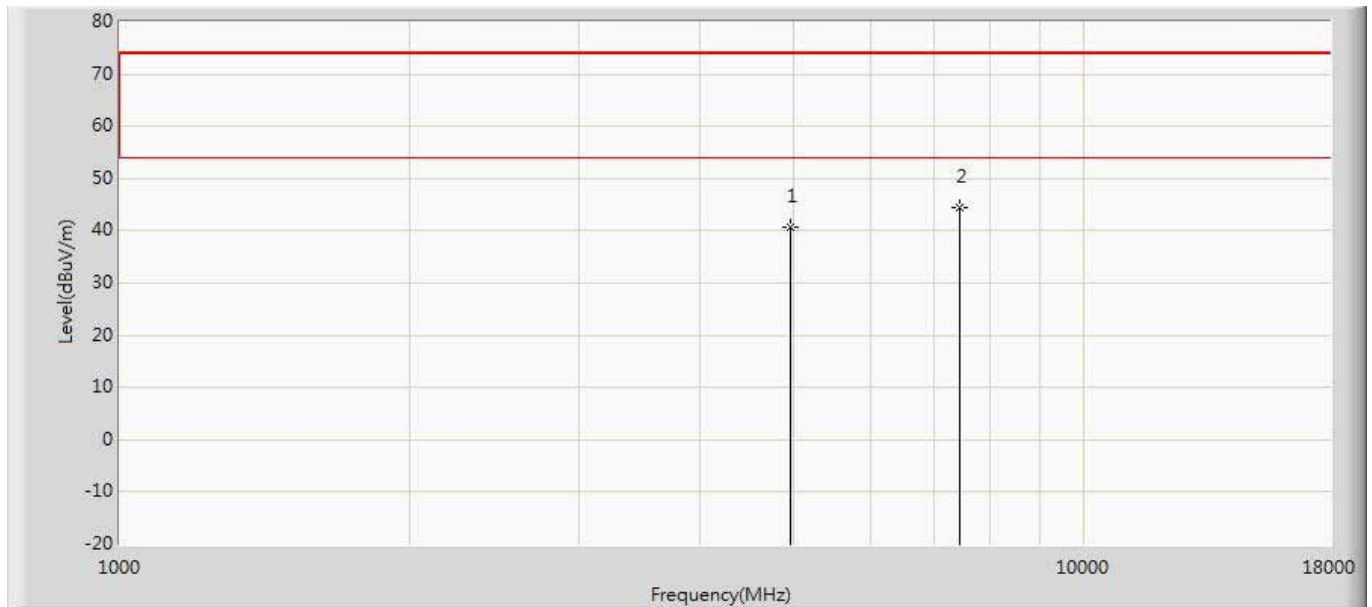

No	Mark	Frequency (MHz)	Measure Level (dBuV/m)	Reading Level (dBuV)	Over Limit (dB)	Limit (dBuV/m)	Factor (dB)	Type
1		4960.000	47.296	55.635	-26.704	74.000	-8.339	PK
2	*	7440.000	43.008	45.901	-30.992	74.000	-2.893	PK



Engineer: Ternence	
Site: AC102	Time: 2017/02/28
Limit: FCC_Part15.209_RE(3m)	Margin: 0
Probe: BBHA9120D_1-18GHz	Polarity: Horizontal
EUT: SIP-T54S	Power: AC 120V/60Hz
Note: Mode : Transmits at 2480MHz by DH5	

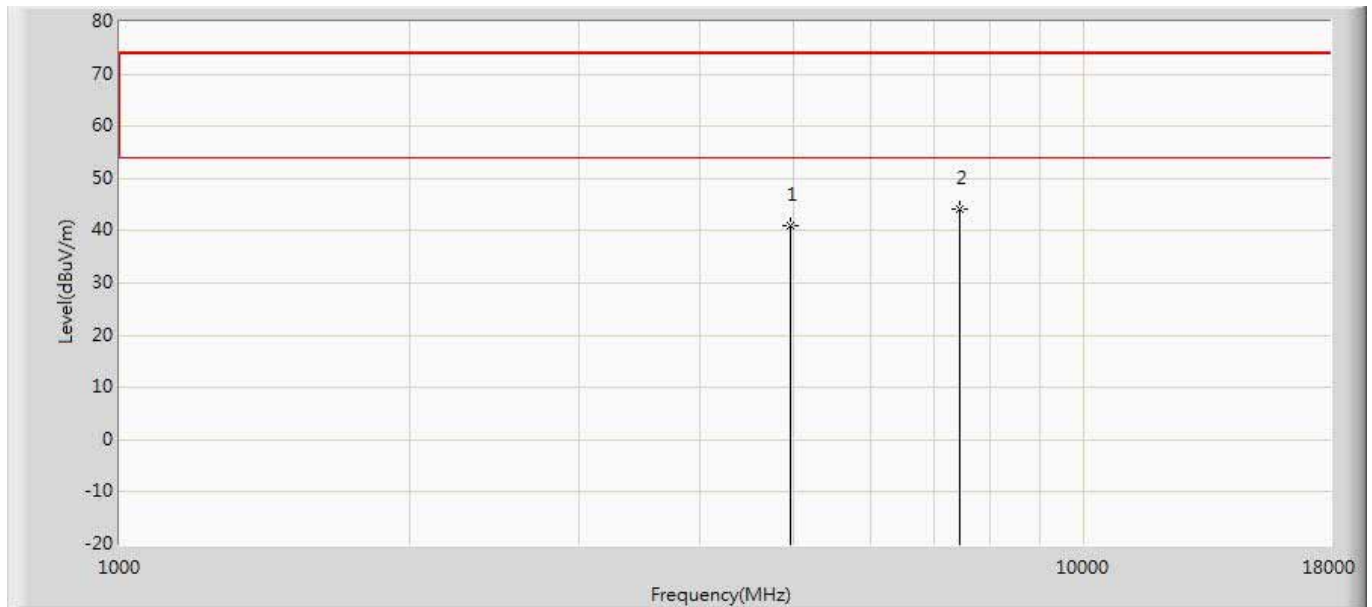

No	Mark	Frequency (MHz)	Measure Level (dBuV/m)	Reading Level (dBuV)	Over Limit (dB)	Limit (dBuV/m)	Factor (dB)	Type
1		4960.000	46.785	54.986	-27.215	74.000	-8.201	PK
2	*	7440.000	40.785	43.678	-33.215	74.000	-2.893	PK



Engineer: Ternence	
Site: AC102	Time: 2017/02/28
Limit: FCC_Part15.209_RE(3m)	Margin: 0
Probe: BBHA9120D_1-18GHz	Polarity: Horizontal
EUT: SIP-T54S	Power: AC 120V/60Hz
Note: Mode : Transmits at 2402MHz by 2DH5	

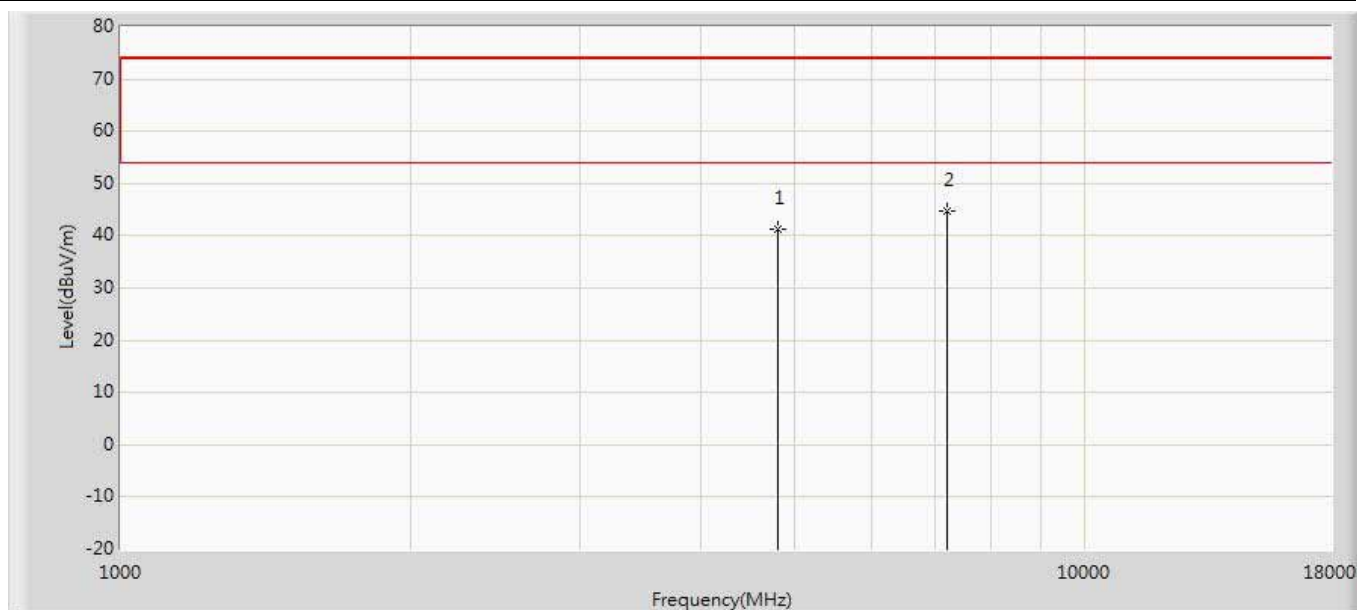

No	Mark	Frequency (MHz)	Measure Level (dBuV/m)	Reading Level (dBuV)	Over Limit (dB)	Limit (dBuV/m)	Factor (dB)	Type
1		4804.000	41.619	49.929	-32.381	74.000	-8.310	PK
2	*	7206.000	40.033	43.493	-33.967	74.000	-3.460	PK



Engineer: Ternence	
Site: AC102	Time: 2017/02/28
Limit: FCC_Part15.209_RE(3m)	Margin: 0
Probe: BBHA9120D_1-18GHz	Polarity: Vertical
EUT: SIP-T54S	Power: AC 120V/60Hz
Note: Mode : Transmits at 2402MHz by 2DH5	

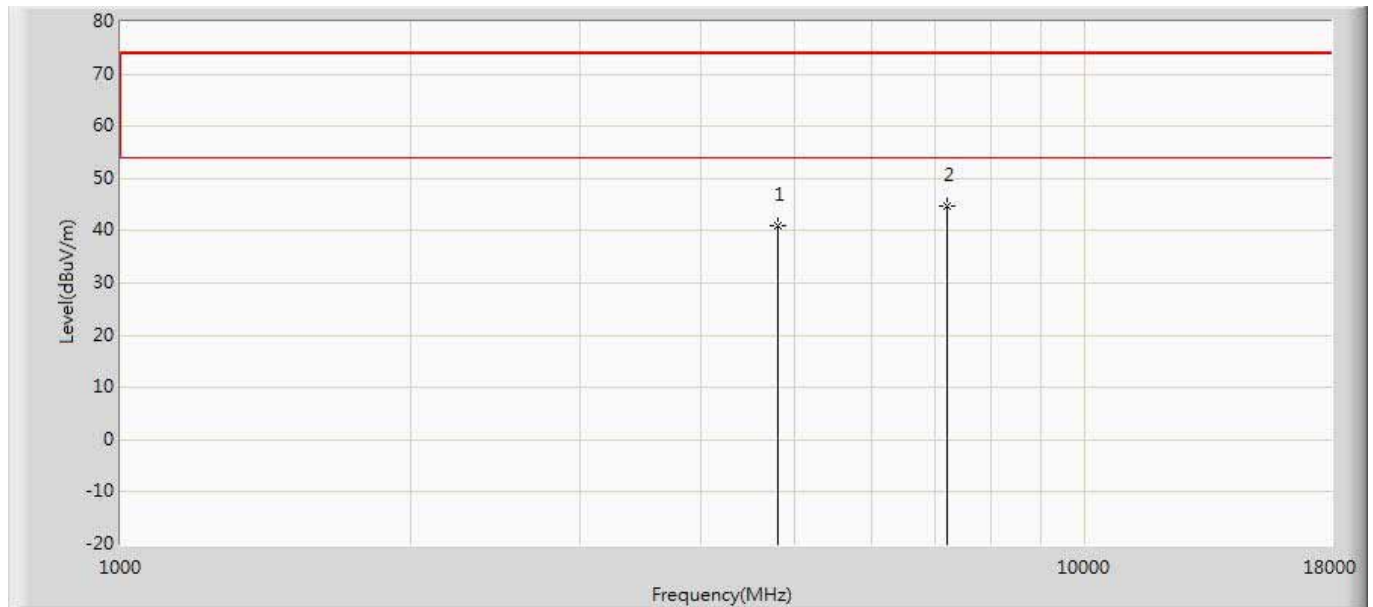

No	Mark	Frequency (MHz)	Measure Level (dBuV/m)	Reading Level (dBuV)	Over Limit (dB)	Limit (dBuV/m)	Factor (dB)	Type
1		4804.000	43.209	51.643	-30.791	74.000	-8.434	PK
2	*	7206.000	39.847	43.343	-34.153	74.000	-3.496	PK



Engineer: Ternence	
Site: AC102	Time: 2017/02/28
Limit: FCC_Part15.209_RE(3m)	Margin: 0
Probe: BBHA9120D_1-18GHz	Polarity: Vertical
EUT: SIP-T54S	Power: AC 120V/60Hz
Note: Mode : Transmits at 2441MHz by 2DH5	

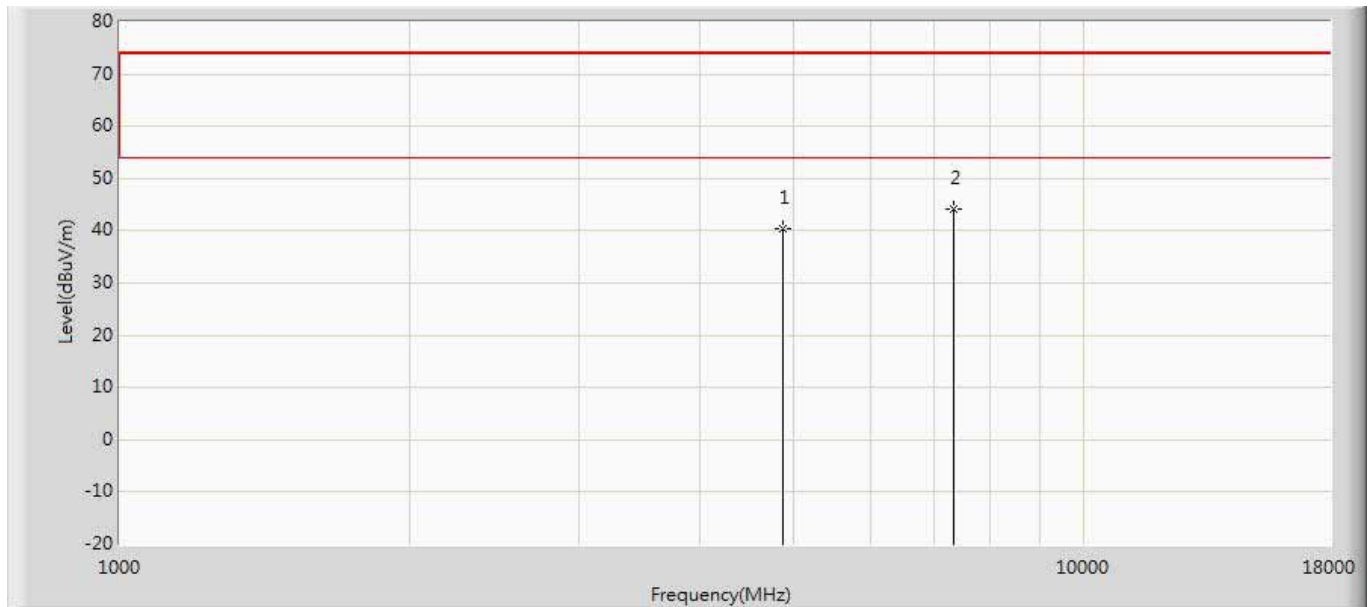

No	Mark	Frequency (MHz)	Measure Level (dBuV/m)	Reading Level (dBuV)	Over Limit (dB)	Limit (dBuV/m)	Factor (dB)	Type
1		4882.000	42.415	50.718	-31.585	74.000	-8.303	PK
2	*	7323.000	39.935	43.195	-34.065	74.000	-3.260	PK



Engineer: Ternence	
Site: AC102	Time: 2017/02/28
Limit: FCC_Part15.209_RE(3m)	Margin: 0
Probe: BBHA9120D_1-18GHz	Polarity: Horizontal
EUT: SIP-T54S	Power: AC 120V/60Hz
Note: Mode : Transmits at 2441MHz by 2DH5	

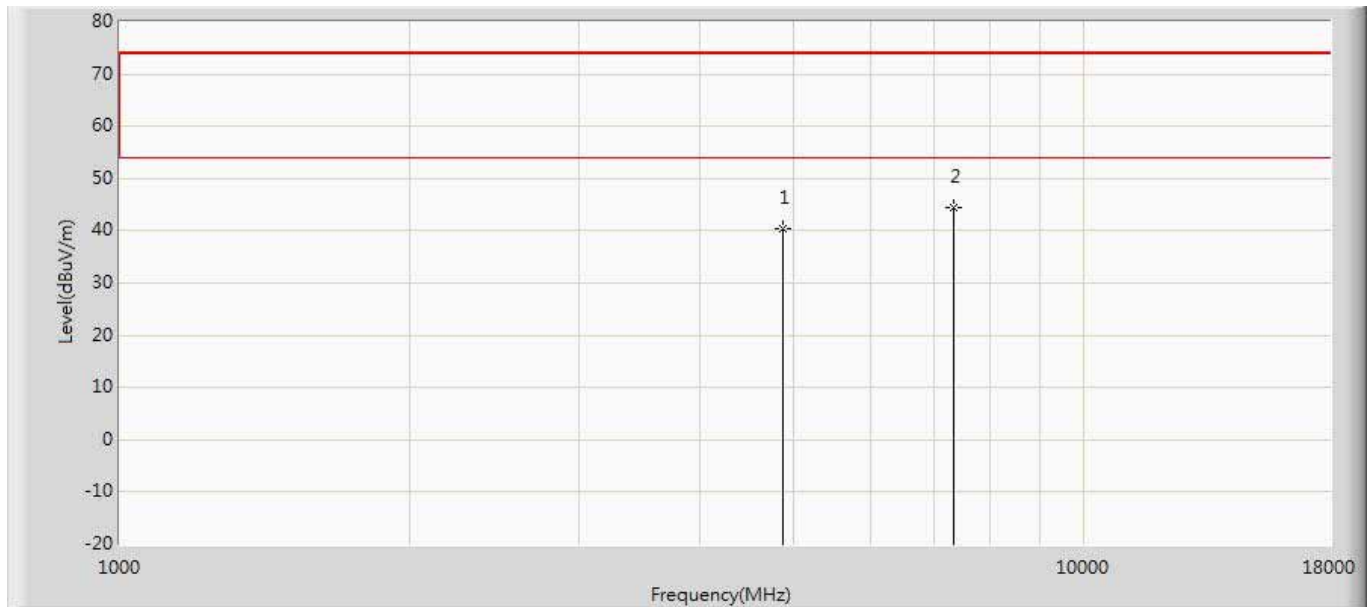

No	Mark	Frequency (MHz)	Measure Level (dBuV/m)	Reading Level (dBuV)	Over Limit (dB)	Limit (dBuV/m)	Factor (dB)	Type
1		4882.000	44.034	52.322	-29.966	74.000	-8.288	PK
2	*	7323.000	38.455	41.948	-35.545	74.000	-3.493	PK



Engineer: Ternence	
Site: AC102	Time: 2017/02/28
Limit: FCC_Part15.209_RE(3m)	Margin: 0
Probe: BBHA9120D_1-18GHz	Polarity: Horizontal
EUT: SIP-T54S	Power: AC 120V/60Hz
Note: Mode : Transmits at 2480MHz by 2DH5	

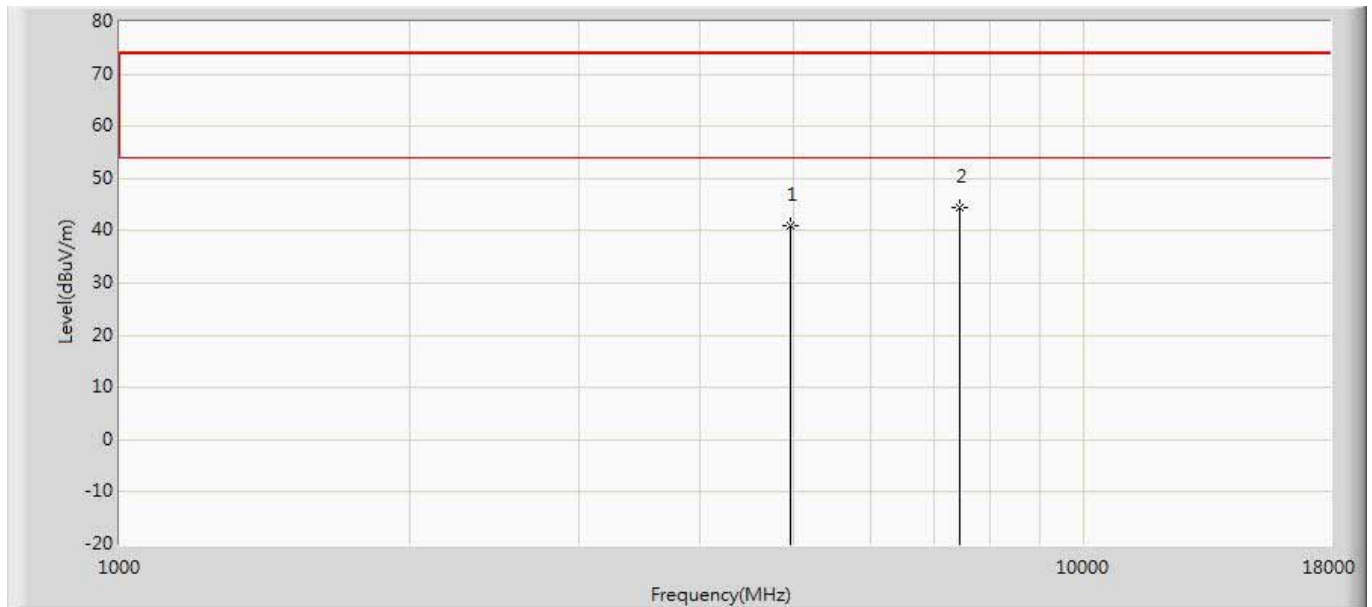

No	Mark	Frequency (MHz)	Measure Level (dBuV/m)	Reading Level (dBuV)	Over Limit (dB)	Limit (dBuV/m)	Factor (dB)	Type
1		4960.000	43.914	52.253	-30.086	74.000	-8.339	PK
2	*	7440.000	39.489	42.382	-34.511	74.000	-2.893	PK



Engineer: Ternence	
Site: AC102	Time: 2017/02/28
Limit: FCC_Part15.209_RE(3m)	Margin: 0
Probe: BBHA9120D_1-18GHz	Polarity: Vertical
EUT: SIP-T54S	Power: AC 120V/60Hz
Note: Mode : Transmits at 2480MHz by 2DH5	

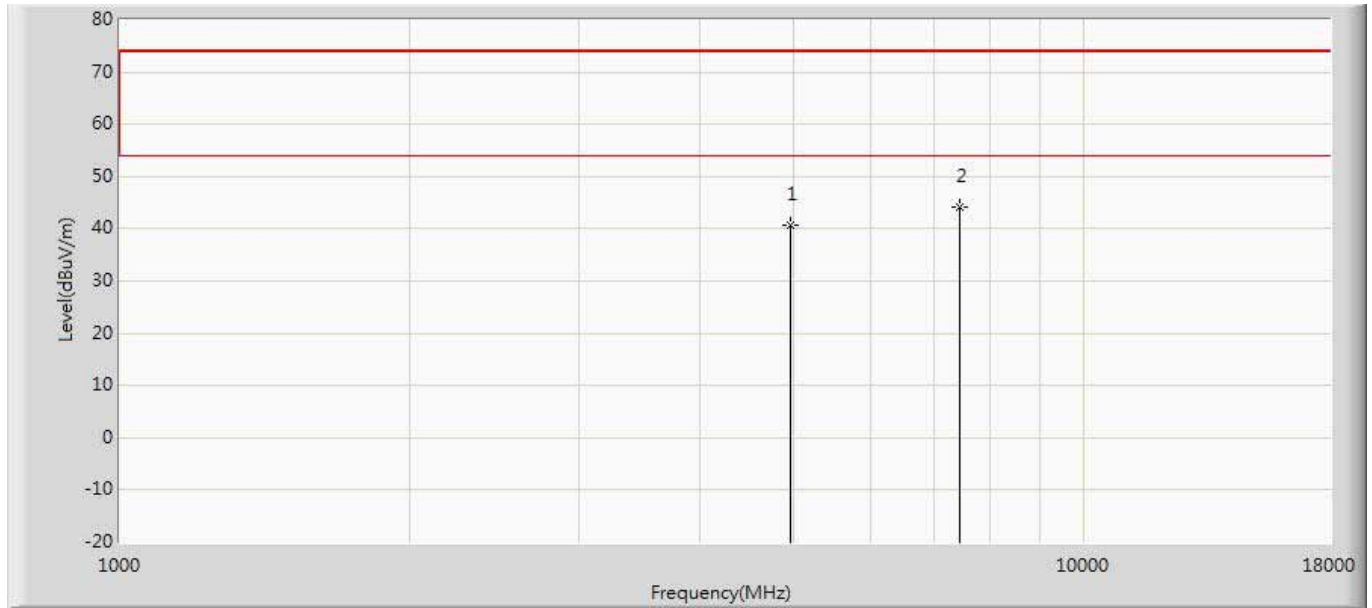

No	Mark	Frequency (MHz)	Measure Level (dBuV/m)	Reading Level (dBuV)	Over Limit (dB)	Limit (dBuV/m)	Factor (dB)	Type
1		4960.000	43.916	52.117	-30.084	74.000	-8.201	PK
2	*	7440.000	39.425	42.318	-34.575	74.000	-2.893	PK



Engineer: Ternence	
Site: AC102	Time: 2017/02/28
Limit: FCC_Part15.209_RE(3m)	Margin: 0
Probe: BBHA9120D_1-18GHz	Polarity: Vertical
EUT: SIP-T54S	Power: AC 120V/60Hz
Note: Mode : Transmits at 2402MHz by 3DH5	

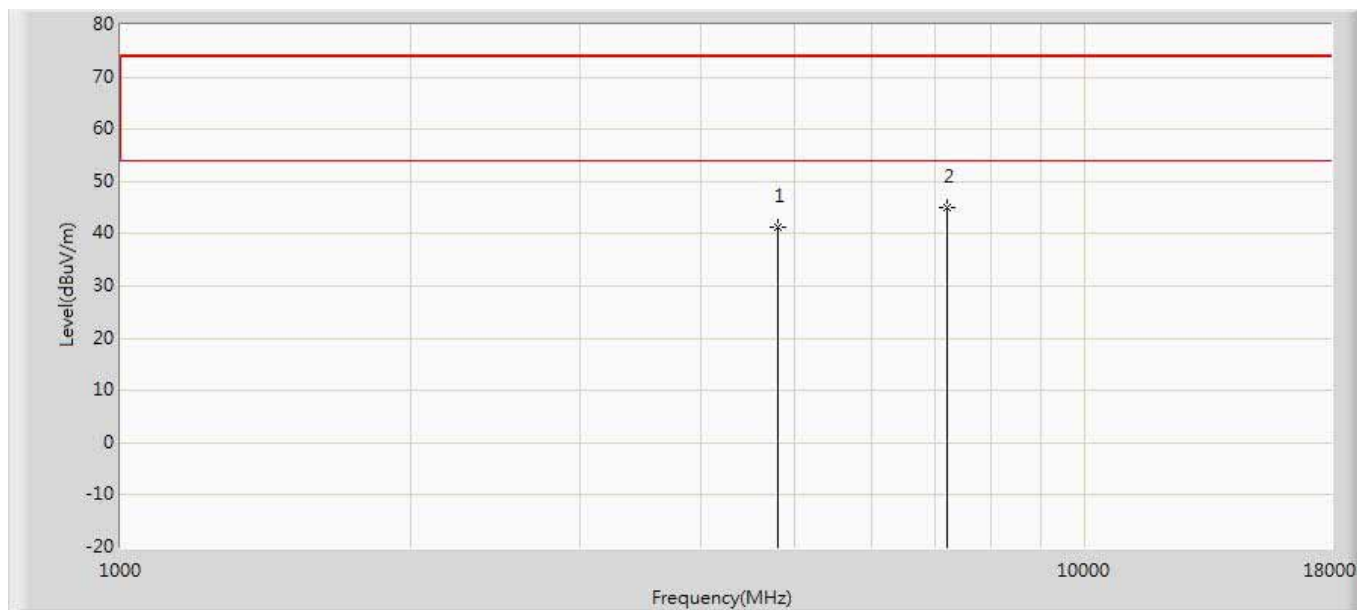

No	Mark	Frequency (MHz)	Measure Level (dBuV/m)	Reading Level (dBuV)	Over Limit (dB)	Limit (dBuV/m)	Factor (dB)	Type
1		4804.000	41.468	49.778	-32.532	74.000	-8.310	PK
2	*	7206.000	40.024	43.484	-33.976	74.000	-3.460	PK



Engineer: Ternence	
Site: AC102	Time: 2017/02/28
Limit: FCC_Part15.209_RE(3m)	Margin: 0
Probe: BBHA9120D_1-18GHz	Polarity: Horizontal
EUT: SIP-T54S	Power: AC 120V/60Hz
Note: Mode : Transmits at 2402MHz by 3DH5	

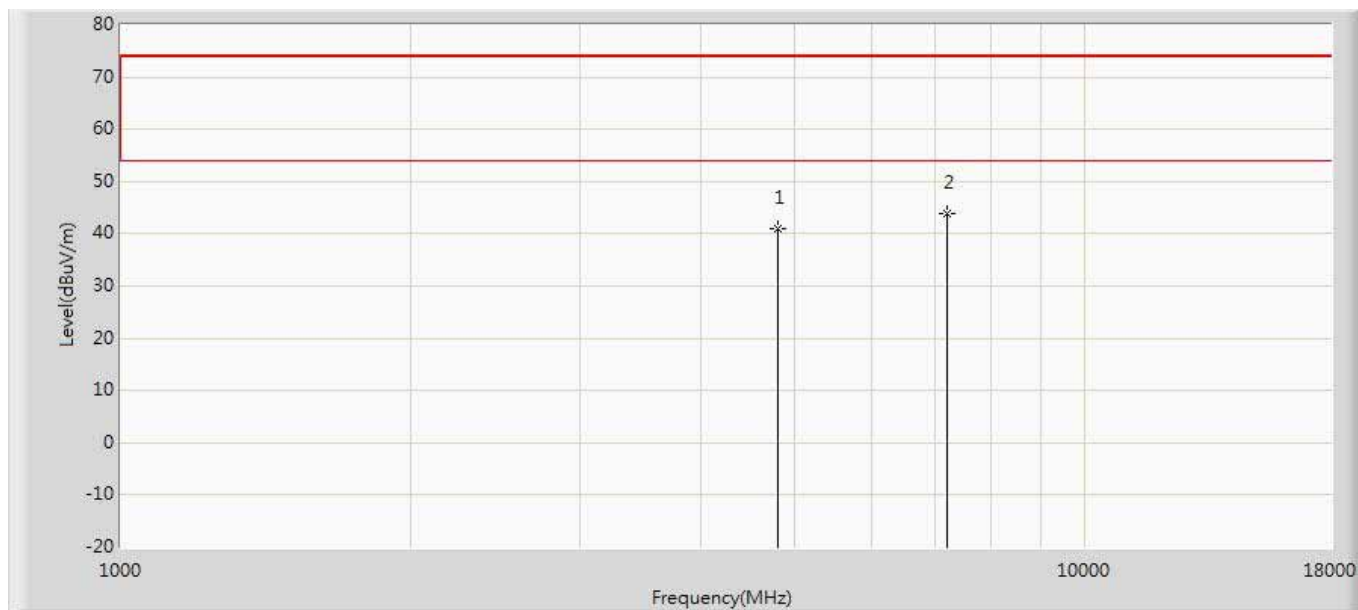

No	Mark	Frequency (MHz)	Measure Level (dBuV/m)	Reading Level (dBuV)	Over Limit (dB)	Limit (dBuV/m)	Factor (dB)	Type
1		4804.000	44.188	52.622	-29.812	74.000	-8.434	PK
2	*	7206.000	39.248	42.744	-34.752	74.000	-3.496	PK



Engineer: Ternence	
Site: AC102	Time: 2017/02/28
Limit: FCC_Part15.209_RE(3m)	Margin: 0
Probe: BBHA9120D_1-18GHz	Polarity: Horizontal
EUT: SIP-T54S	Power: AC 120V/60Hz
Note: Mode : Transmits at 2441MHz by 3DH5	

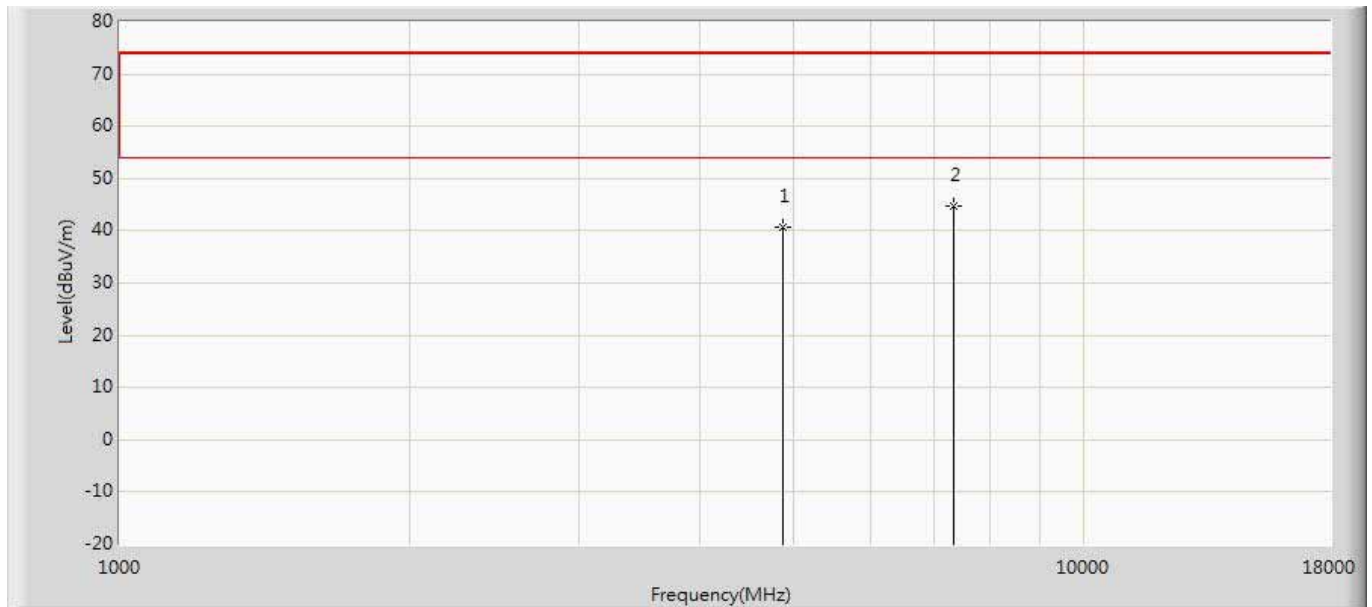

No	Mark	Frequency (MHz)	Measure Level (dBuV/m)	Reading Level (dBuV)	Over Limit (dB)	Limit (dBuV/m)	Factor (dB)	Type
1		4882.000	44.029	52.332	-29.971	74.000	-8.303	PK
2	*	7323.000	41.322	44.582	-32.678	74.000	-3.260	PK



Engineer: Ternence	
Site: AC102	Time: 2017/02/28
Limit: FCC_Part15.209_RE(3m)	Margin: 0
Probe: BBHA9120D_1-18GHz	Polarity: Vertical
EUT: SIP-T54S	Power: AC 120V/60Hz
Note: Mode : Transmits at 2441MHz by 3DH5	

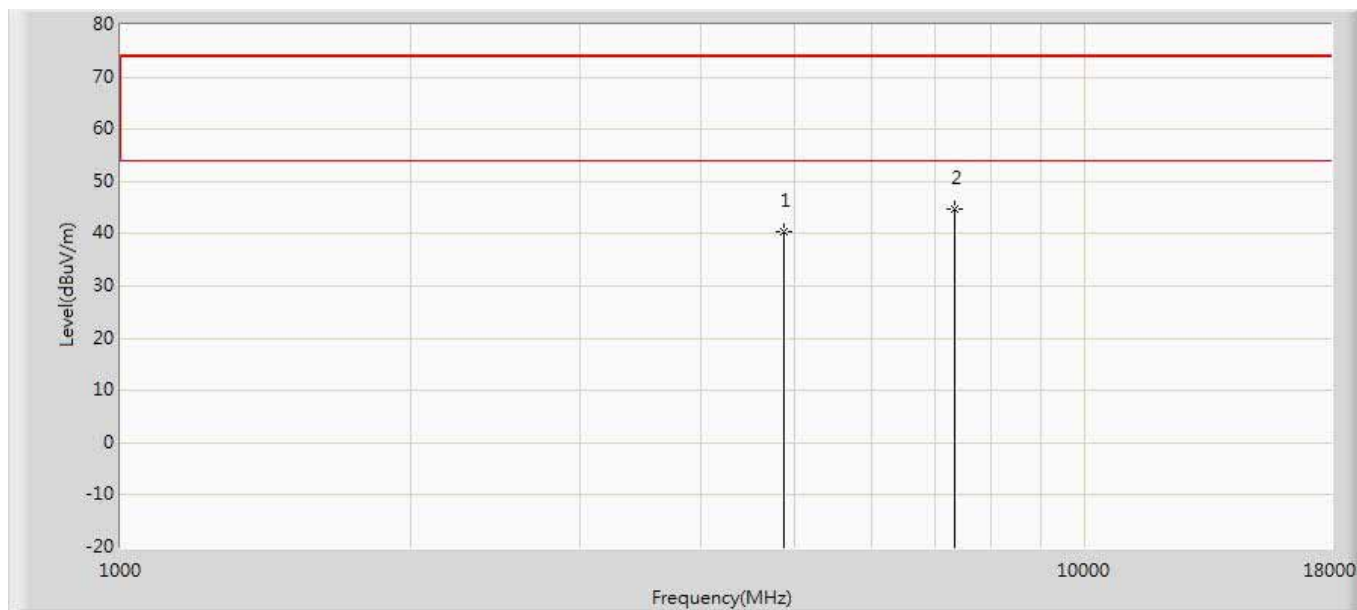

No	Mark	Frequency (MHz)	Measure Level (dBuV/m)	Reading Level (dBuV)	Over Limit (dB)	Limit (dBuV/m)	Factor (dB)	Type
1		4882.000	44.709	52.997	-29.291	74.000	-8.288	PK
2	*	7323.000	39.000	42.493	-35.000	74.000	-3.493	PK



Engineer: Ternence	
Site: AC102	Time: 2017/02/28
Limit: FCC_Part15.209_RE(3m)	Margin: 0
Probe: BBHA9120D_1-18GHz	Polarity: Vertical
EUT: SIP-T54S	Power: AC 120V/60Hz
Note: Mode : Transmits at 2480MHz by 3DH5	

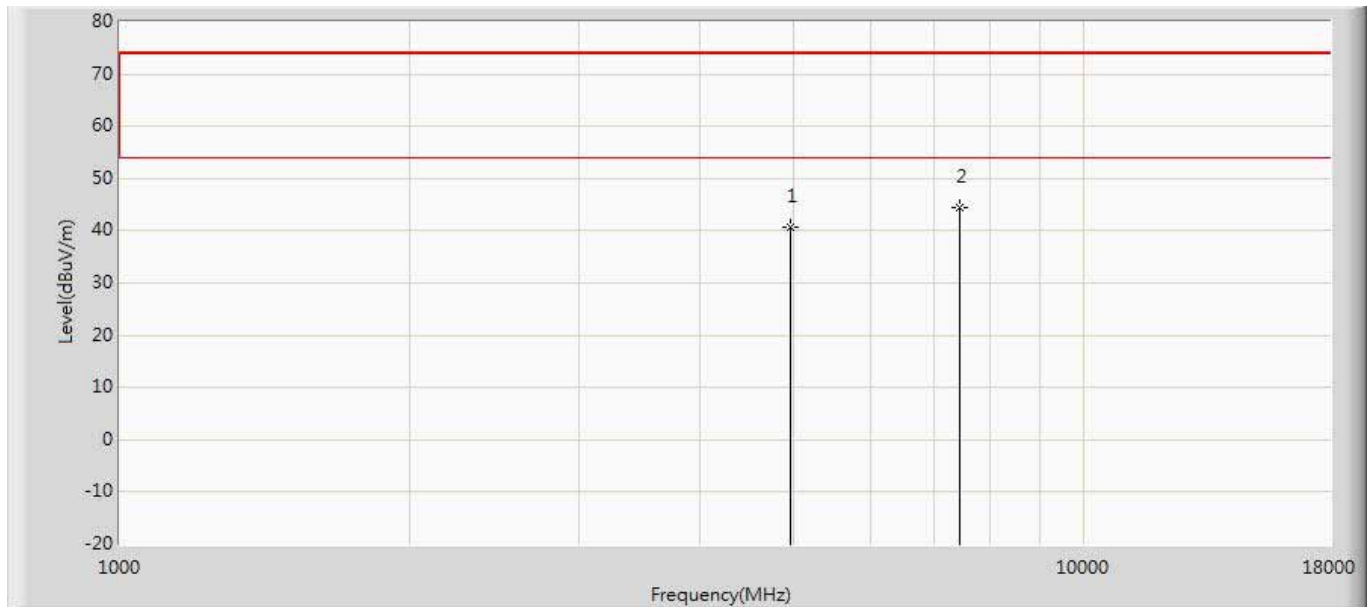

No	Mark	Frequency (MHz)	Measure Level (dBuV/m)	Reading Level (dBuV)	Over Limit (dB)	Limit (dBuV/m)	Factor (dB)	Type
1		4960.000	46.014	54.353	-27.986	74.000	-8.339	PK
2	*	7440.000	39.783	42.676	-34.217	74.000	-2.893	PK



Engineer: Ternence	
Site: AC102	Time: 2017/02/28
Limit: FCC_Part15.209_RE(3m)	Margin: 0
Probe: BBHA9120D_1-18GHz	Polarity: Horizontal
EUT: SIP-T54S	Power: AC 120V/60Hz
Note: Mode : Transmits at 2480MHz by 3DH5	

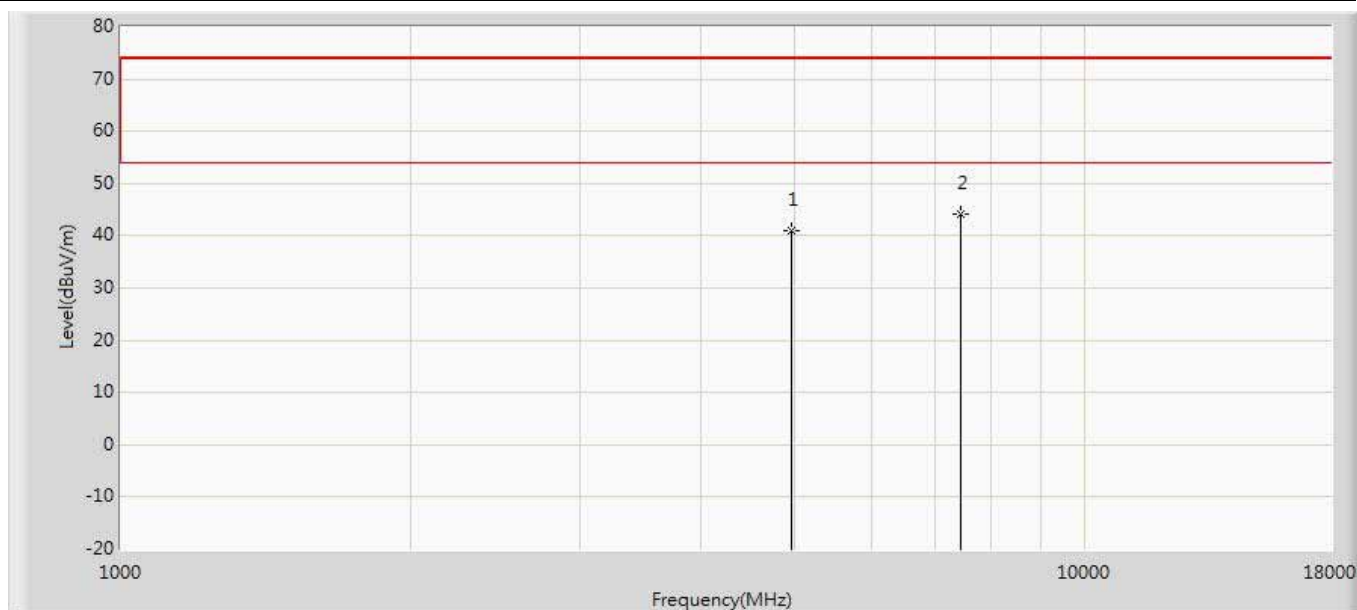

No	Mark	Frequency (MHz)	Measure Level (dBuV/m)	Reading Level (dBuV)	Over Limit (dB)	Limit (dBuV/m)	Factor (dB)	Type
1		4960.000	43.648	51.849	-30.352	74.000	-8.201	PK
2	*	7440.000	40.264	43.157	-33.736	74.000	-2.893	PK

Note: 1. Measure Level = Reading Level + Factor.

2. This limit applies for using average detector, if the test result on peak is lower than average limit, then average measurement needn't be performed.

3. The test trace is same as the ambient noise (the test frequency range: 9kHz~30MHz, 18GHz~25GHz), therefore no data appear in the report.



6. 20dB Bandwidth Measurement

6.1 Test Limit

Frequency hopping systems shall have hopping channel carrier frequencies separated by a minimum of 25 kHz or the 20 dB bandwidth of the hopping channel, whichever is greater. Alternatively, frequency hopping systems operating in the 2400–2483.5 MHz band may have hopping channel carrier frequencies that are separated by 25 kHz or two-thirds of the 20 dB bandwidth of the hopping channel, whichever is greater, provided the systems operate with an output power no greater than 125mW.

6.2 Test Standard

ANSI C63.10-2013- Section 7.8.7

6.3 Test Setup

1. Set RBW $\geq 1\%$ of the 20dB bandwidth
2. VBW $\geq 3 \times$ RBW
3. Span = approximately 2 to 3 times the 20dB bandwidth, centered on a hopping channel
4. Detector = Peak
5. Trace mode = max hold
6. Sweep = auto couple
7. Allow the trace to stabilize
8. Measure the maximum width of the emission that is constrained by the frequencies associated with the two outermost amplitude points (upper and lower frequencies) that are attenuated by 20dB relative to the maximum level measured in the fundamental emission

6.4 Test Setup Layout

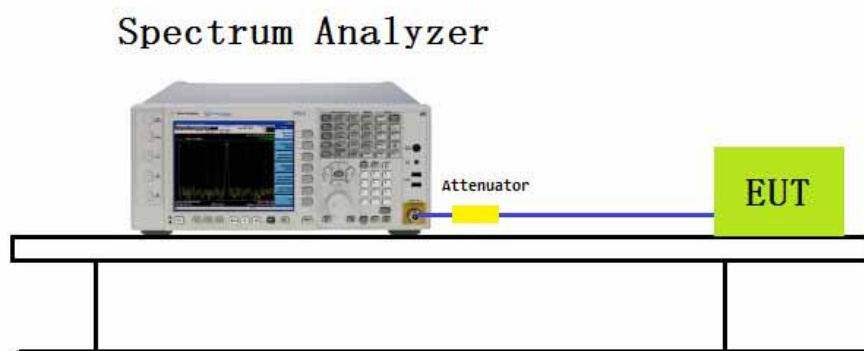



6.5 Test Result and Data

Test Item	Occupied Bandwidth
Test Mode	Mode 1: Transmitter DH5

Channel No.	Frequency(MHz)	20dB Bandwidth(kHz)	99% Bandwidth(kHz)
00	2402	1020.0	1005.7
39	2441	1019.0	1005.5
78	2480	1019.0	1005.3

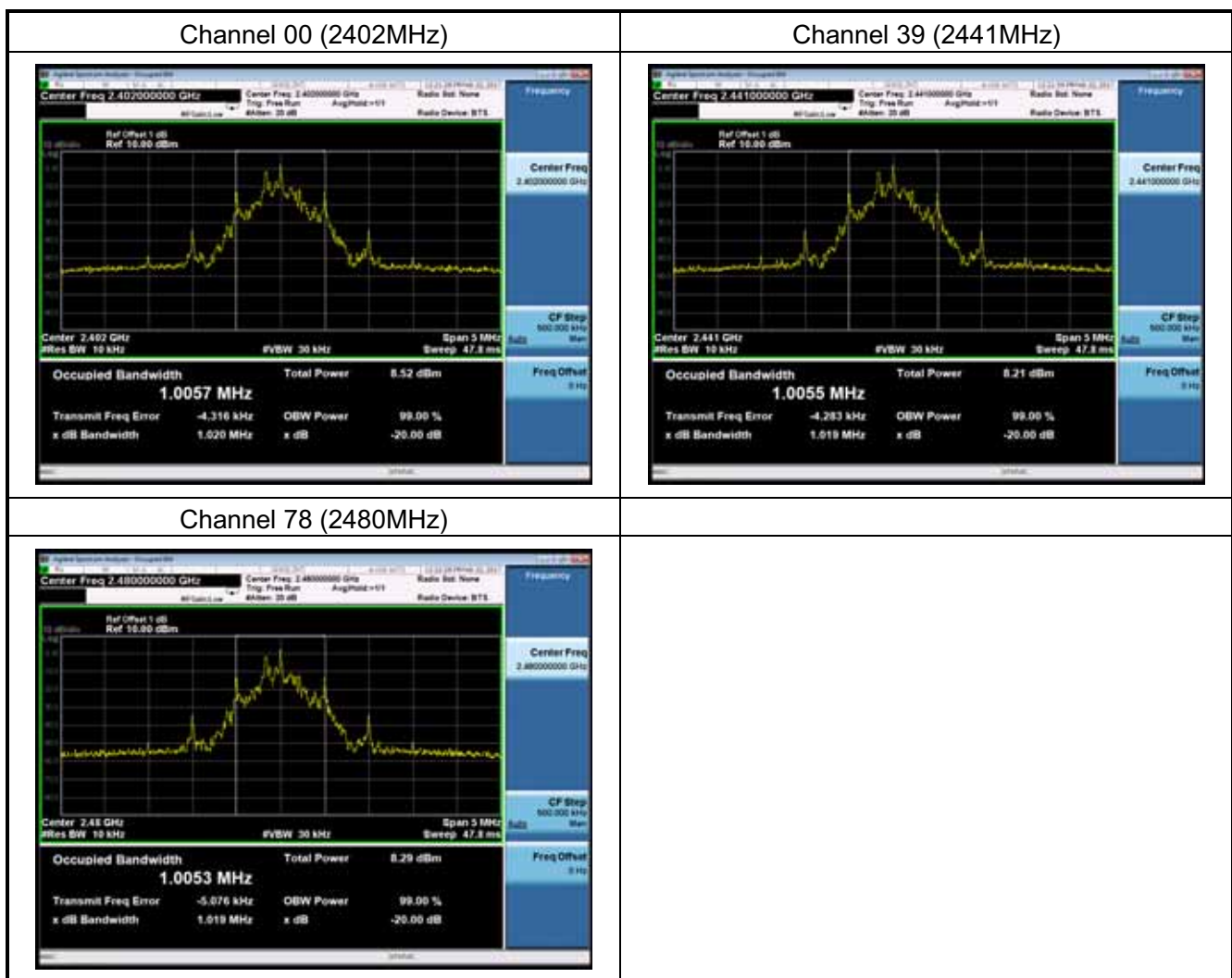



Test Item	Occupied Bandwidth
Test Mode	Mode 2: Transmitter 2DH5

Channel No.	Frequency(MHz)	20dB Bandwidth(kHz)	99% Bandwidth(kHz)
00	2402	1040.0	1159.9
39	2441	1040.0	1161.8
78	2480	1039.0	1163.6

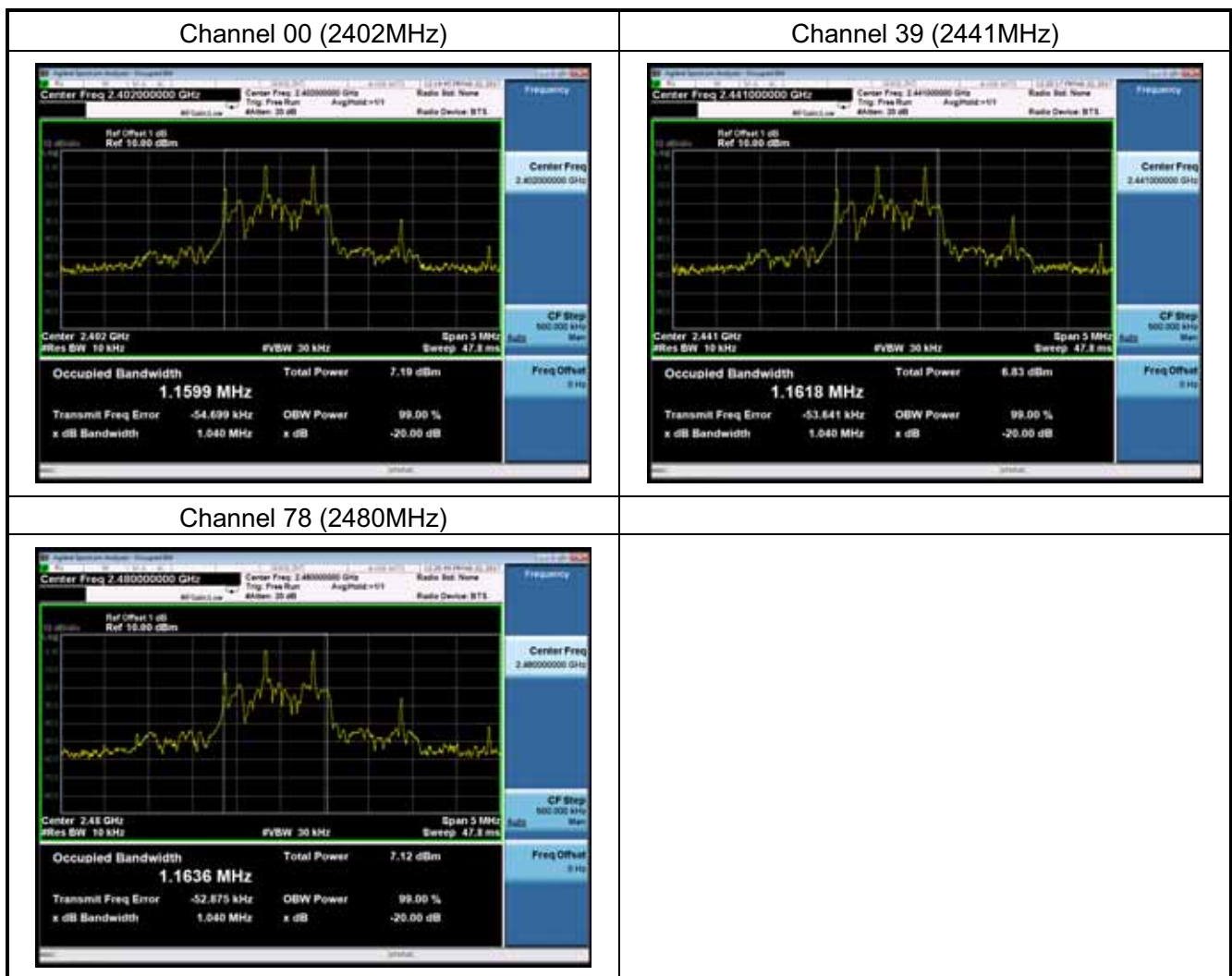



Test Item	Occupied Bandwidth
Test Mode	Mode 3: Transmitter 3DH5

Channel No.	Frequency(MHz)	20dB Bandwidth(kHz)	99% Bandwidth(kHz)
00	2402	1165.0	1166.4
39	2441	1165.0	1167.6
78	2480	1168.0	1169.4





7. Channel Carrier Frequencies Separation Measurement

7.1 Test Limit

Frequency hopping systems shall have hopping channel carrier frequencies separated by a minimum of 25 kHz or the 20 dB bandwidth of the hopping channel, whichever is greater.

7.2 Test Standard

ANSI C63.10-2013- Section 7.8.2

7.3 Test Setup

The EUT shall have its hopping function enabled. Use the following spectrum analyzer settings:

- Span: Wide enough to capture the peaks of two adjacent channels.
- RBW: Start with the RBW set to approximately 30% of the channel spacing; adjust as necessary to best identify the center of each individual channel.
- Video (or average) bandwidth (VBW) \geq RBW
- Sweep: Auto
- Detector function: Peak
- Trace: Max hold
- Allow the trace to stabilize

Use the marker-delta function to determine the separation between the peaks of the adjacent channels. Compliance of an EUT with the appropriate regulatory limit shall be determined. A plot of the data shall be included in the test report.

7.4 Test Setup Layout

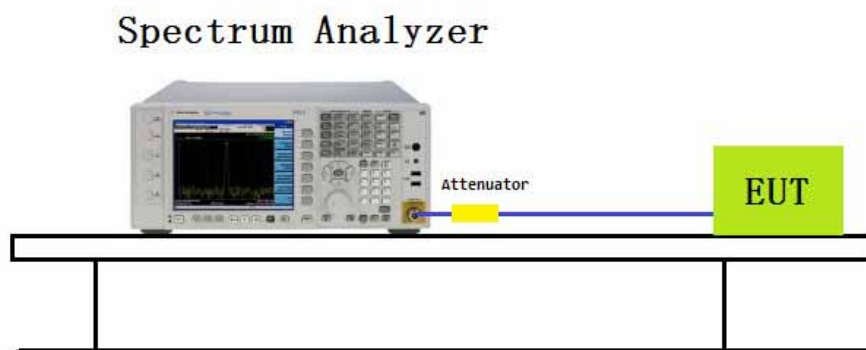



7.5 Test Result and Data

Test Item	:	Channel Carrier Frequency Separation
Test Mode	:	Mode 1: Transmitter DH5

Channel No.	Frequency (MHz)	Carrier Frequency Separation (kHz)	Limit (kHz)	Result
00	2402	1000	>25 kHz or 2/3 of 20 dB BW	Pass
39	2441	1000	>25 kHz or 2/3 of 20 dB BW	Pass
78	2480	1000	>25 kHz or 2/3 of 20 dB BW	Pass

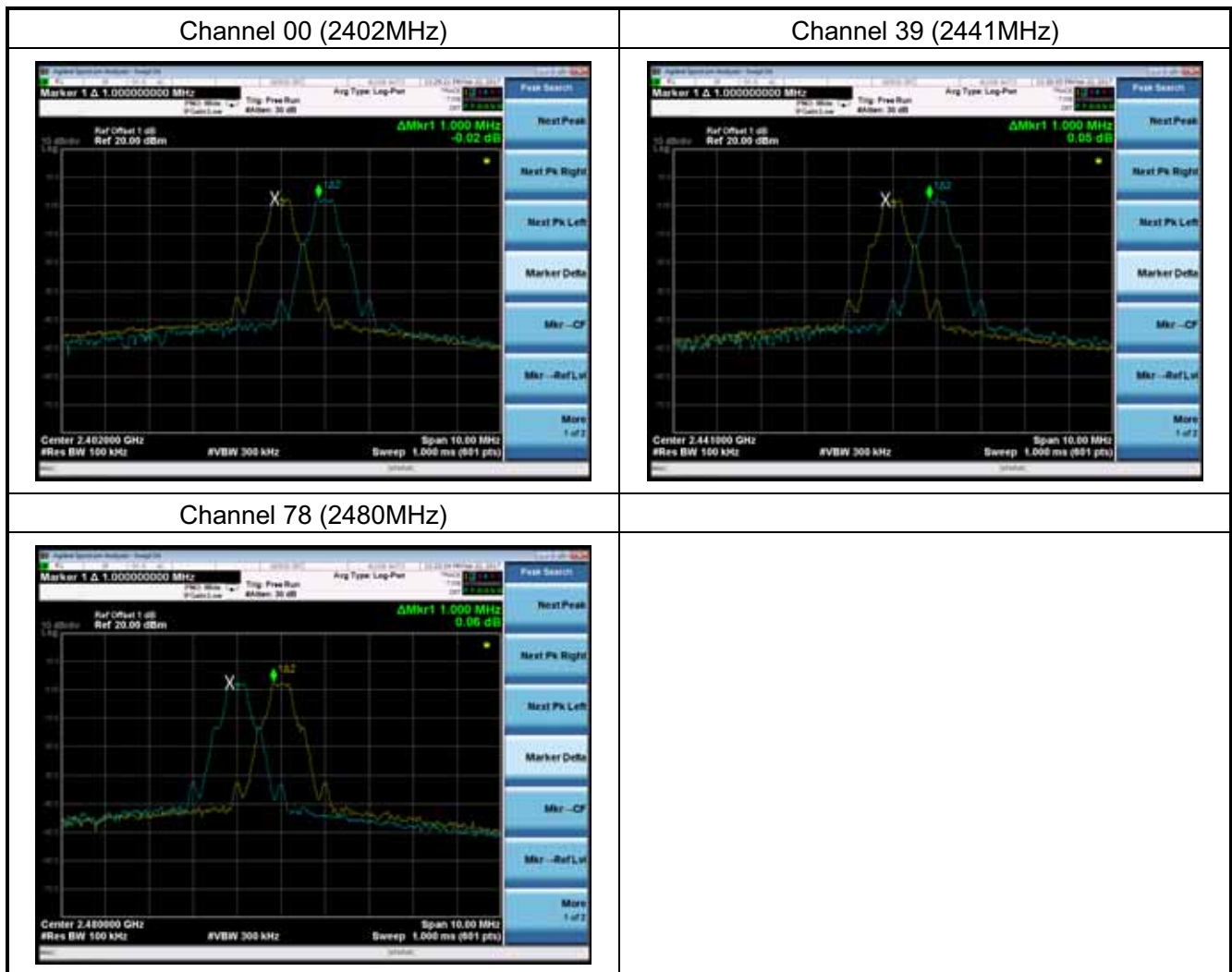



Test Item	:	Carrier Frequency Separation
Test Mode	:	Mode 2: Transmitter 2DH5

Channel No.	Frequency (MHz)	Carrier Frequency Separation(kHz)	Limit (kHz)	Result
00	2402	1000	>25 kHz or 2/3 of 20 dB BW	Pass
39	2441	1000	>25 kHz or 2/3 of 20 dB BW	Pass
78	2480	1000	>25 kHz or 2/3 of 20 dB BW	Pass

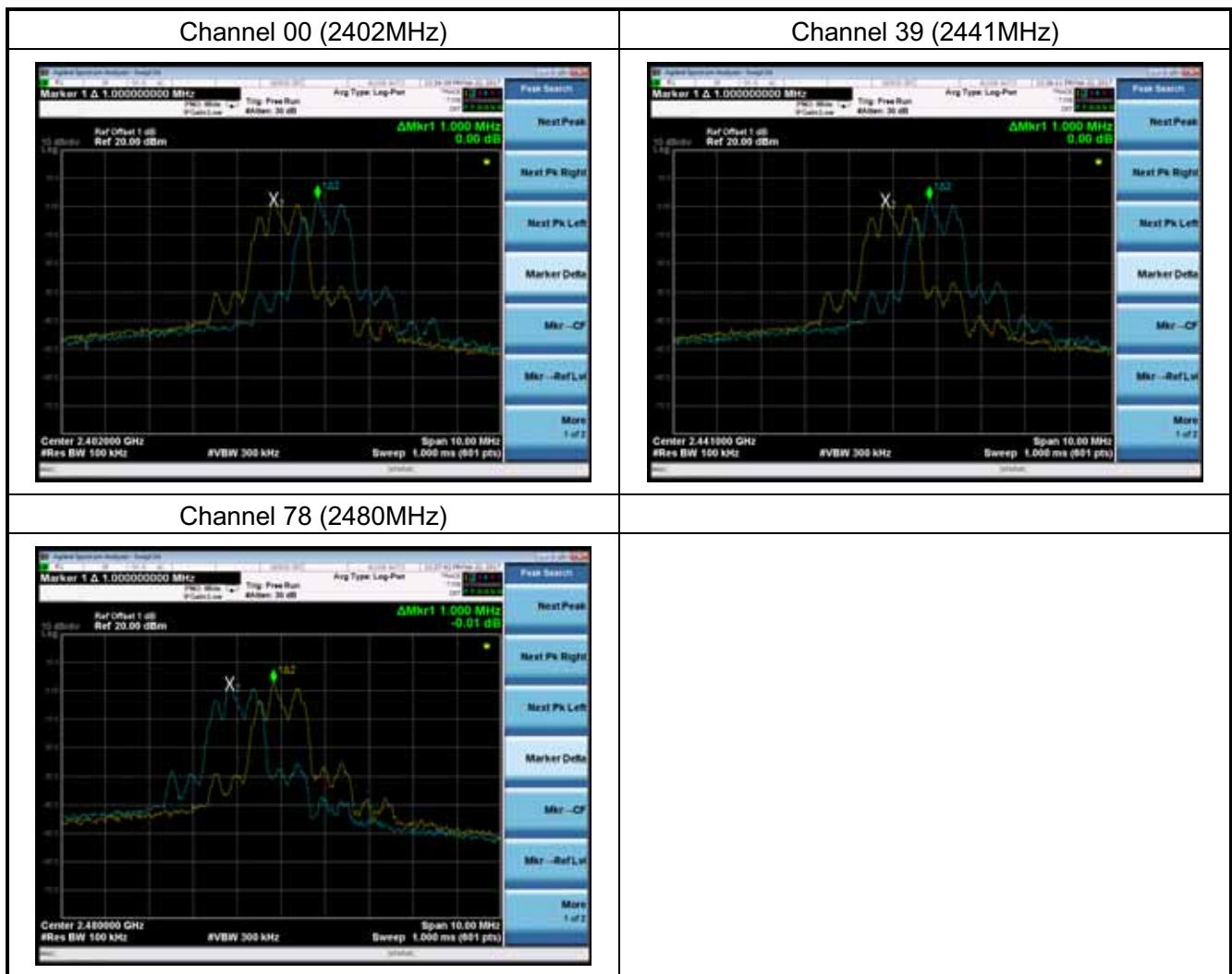



Test Item	:	Carrier Frequency Separation
Test Mode	:	Mode 2: Transmitter 3DH5

Channel No.	Frequency (MHz)	Carrier Frequency Separation (kHz)	Limit (kHz)	Result
00	2402	1000	>25 kHz or 2/3 of 20 dB BW	Pass
39	2441	1000	>25 kHz or 2/3 of 20 dB BW	Pass
78	2480	1000	>25 kHz or 2/3 of 20 dB BW	Pass

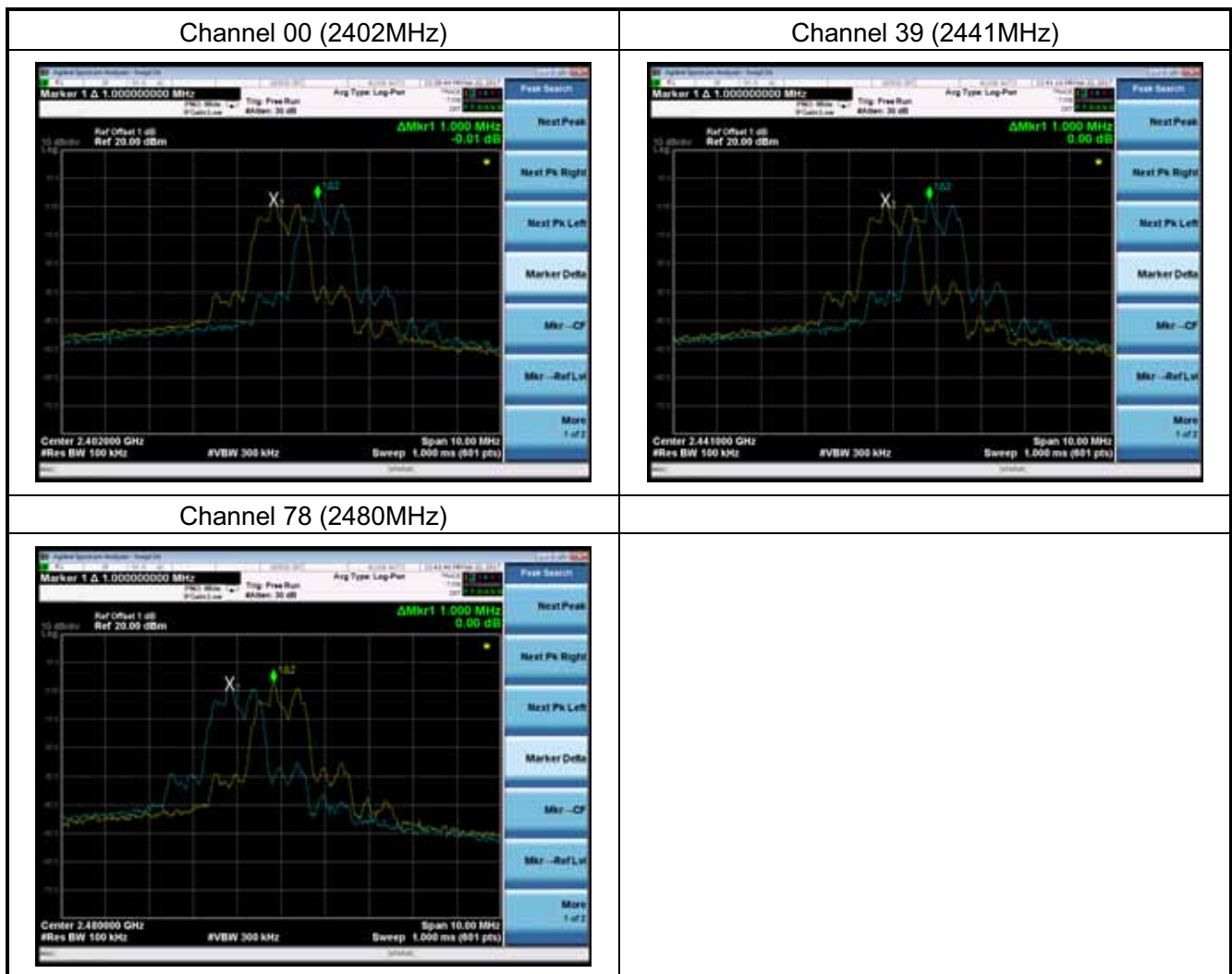



8. Dwell Time Measurement

8.1 Test Limit

The average time of occupancy on any channel shall not be greater than 0.4 seconds within a period of 0.4 seconds multiplied by the number of hopping channels employed.

8.2 Test Standard

ANSI C63.10-2013- Section 7.8.3

8.3 Test Setup

The EUT shall have its hopping function enabled. Use the following spectrum analyzer settings:

- a) Span: Zero span, centered on a hopping channel.
- b) RBW shall be \leq channel spacing and where possible RBW should be set $\gg 1 / T$, where T is the expected dwell time per channel.
- c) Sweep: As necessary to capture the entire dwell time per hopping channel; where possible use a video trigger and trigger delay so that the transmitted signal starts a little to the right of the start of the plot. The trigger level might need slight adjustment to prevent triggering when the system hops on an adjacent channel; a second plot might be needed with a longer sweep time to show two successive hops on a channel.
- d) Detector function: Peak
- e) Trace: Max hold

8.4 Test Setup Layout

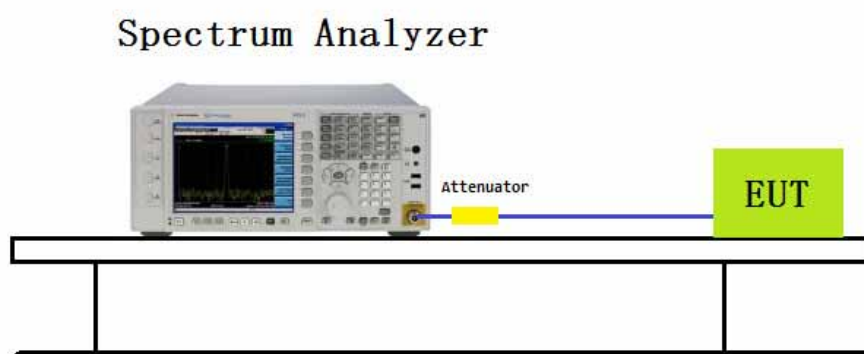



8.5 Test Result and Data

Test Item	:	Time of Occupancy (Dwell Time)
Test Mode	:	Transmitter 3DH1

Channel No.	Frequency (MHz)	Time of Occupancy (ms)	Limit (ms)	Result
39	2441	125.4	< 400	Pass

Test Time Period: $0.4 \times 79 = 31.6$ sec, Hopping Times Within 1sec: $40/50$ msec = 800 hops/sec.

2441MHz, The Maximum Occupancy Time Within 31.6sec: $[(0.392\text{ms} \times 800)/79] \times 31.6 = 125.4$ msec

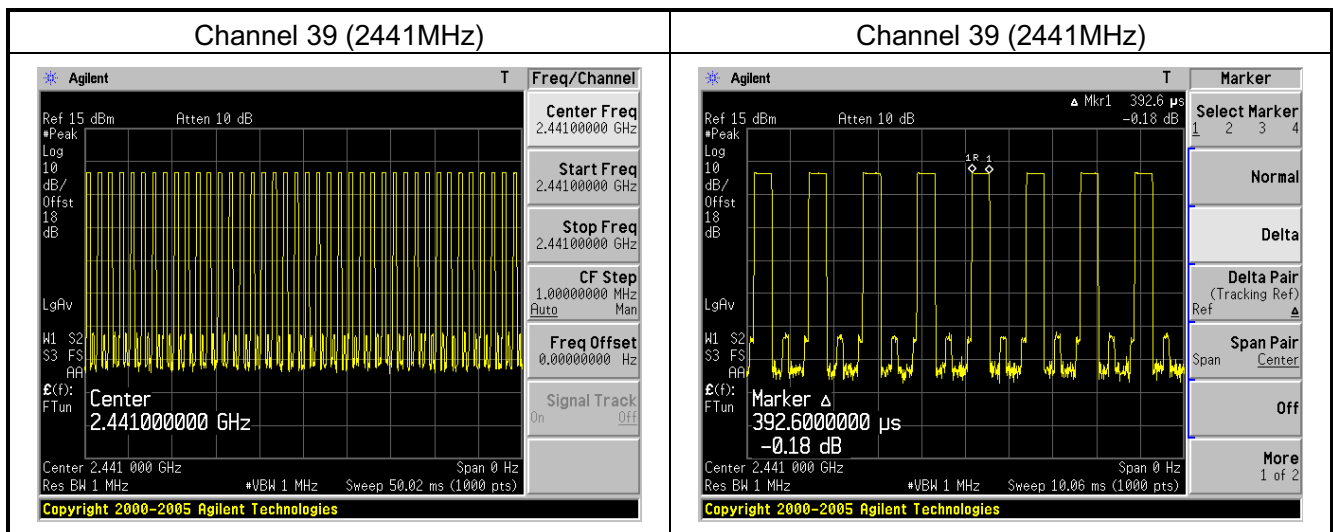



Test Item	:	Time of Occupancy (Dwell Time)
Test Mode	:	Transmitter 3DH3

Channel No.	Frequency (MHz)	Time of Occupancy (ms)	Limit (ms)	Result
39	2441	264	< 400	Pass

Test Time Period: $0.4 \times 79 = 31.6$ sec, Hopping Times Within 1sec: $20/50$ msec= 400 hops/sec.

2441MHz, The Maximum Occupancy Time Within 31.6sec: $[(1.65\text{ms} \times 400) / 79] \times 31.6 = 264$ msec

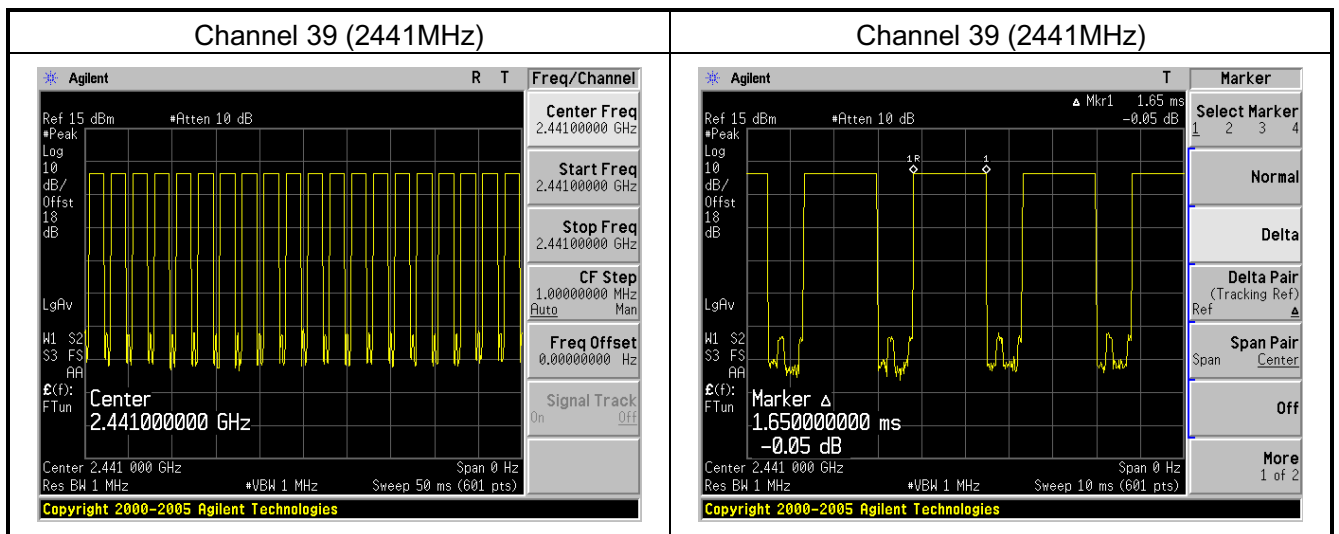



Test Item	:	Time of Occupancy (Dwell Time)
Test Mode	:	Transmitter 3DH5

Channel No.	Frequency (MHz)	Time of Occupancy (ms)	Limit (ms)	Result
39	2441	301.6	< 400	Pass

Test Time Period: 0.4*79=31.6sec, Hopping Times Within 1sec: 13/50msec=260 hops/sec.

2441MHz, The Maximum Occupancy Time Within 31.6sec: [(2.9ms*260)/79]*31.6= 301.6msec

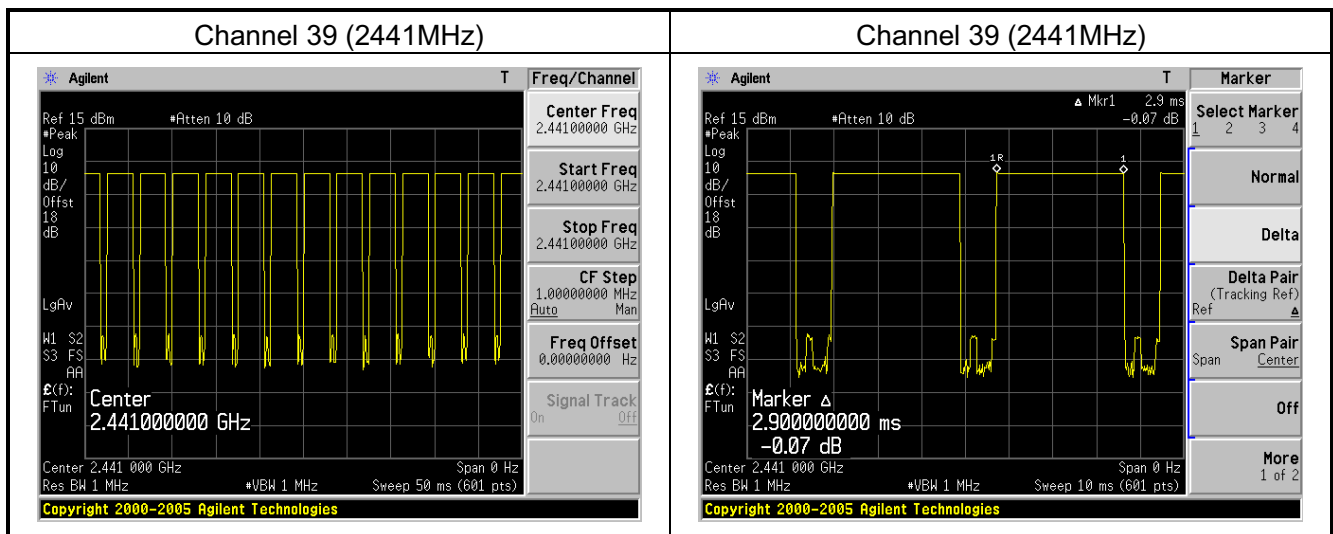



9. Number of Hopping Channels Measurement

9.1 Test Limit

Frequency hopping systems in the 2400 ~ 2483.5 MHz band shall use at least 15 channels.

9.2 Test Standard

ANSI C63.10-2013- Section 7.8.3

9.3 Test Setup

The EUT shall have its hopping function enabled. Use the following spectrum analyzer settings:

- Span: The frequency band of operation. Depending on the number of channels the device supports, it may be necessary to divide the frequency range of operation across multiple spans, to allow the individual channels to be clearly seen.
- RBW: To identify clearly the individual channels, set the RBW to less than 30% of the channel spacing or the 20 dB bandwidth, whichever is smaller.
- VBW \geq RBW
- Sweep: Auto
- Detector function: Peak
- Trace: Max hold
- Allow the trace to stabilize

9.4 Test Setup Layout

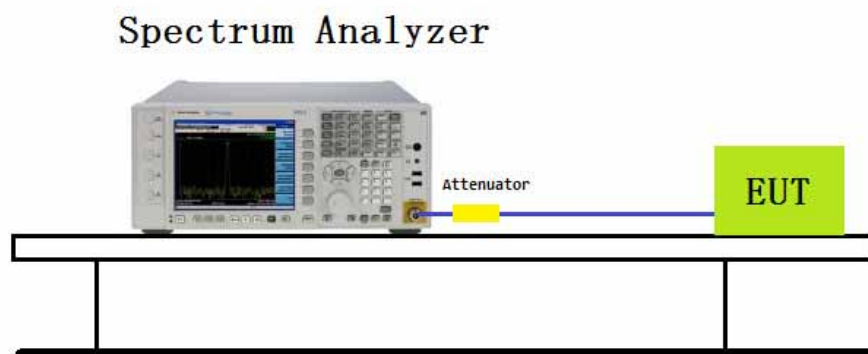



9.5 Test Result and Data

Test Item	:	Number of Hopping Frequencies
Test Mode	:	Mode 1: Transmitter DH5

Frequency Band (MHz)	Number of Hopping Frequencies	Limit	Result
2400 - 2483.5	79	>15	Pass

2402 - 2480 MHz

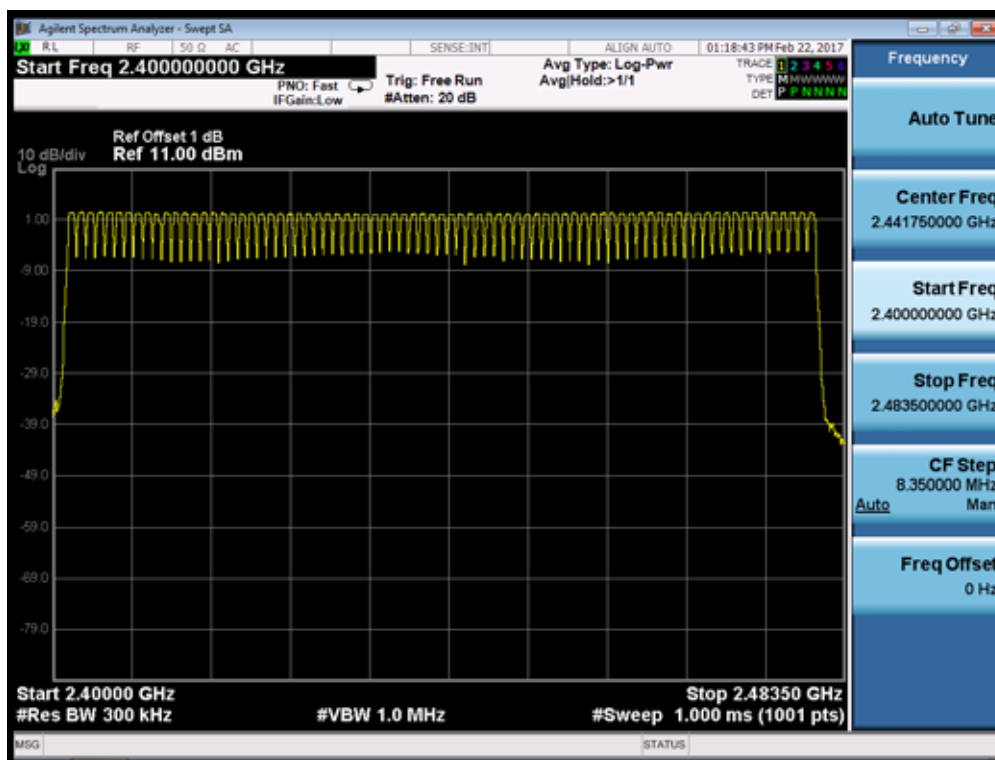



Test Item	:	Number of Hopping Frequencies
Test Mode	:	Mode 2: Transmitter 2DH5

Frequency Band (MHz)	Number of Hopping Frequencies	Limit	Result
2400 - 2483.5	79	>15	Pass

2402 - 2480 MHz

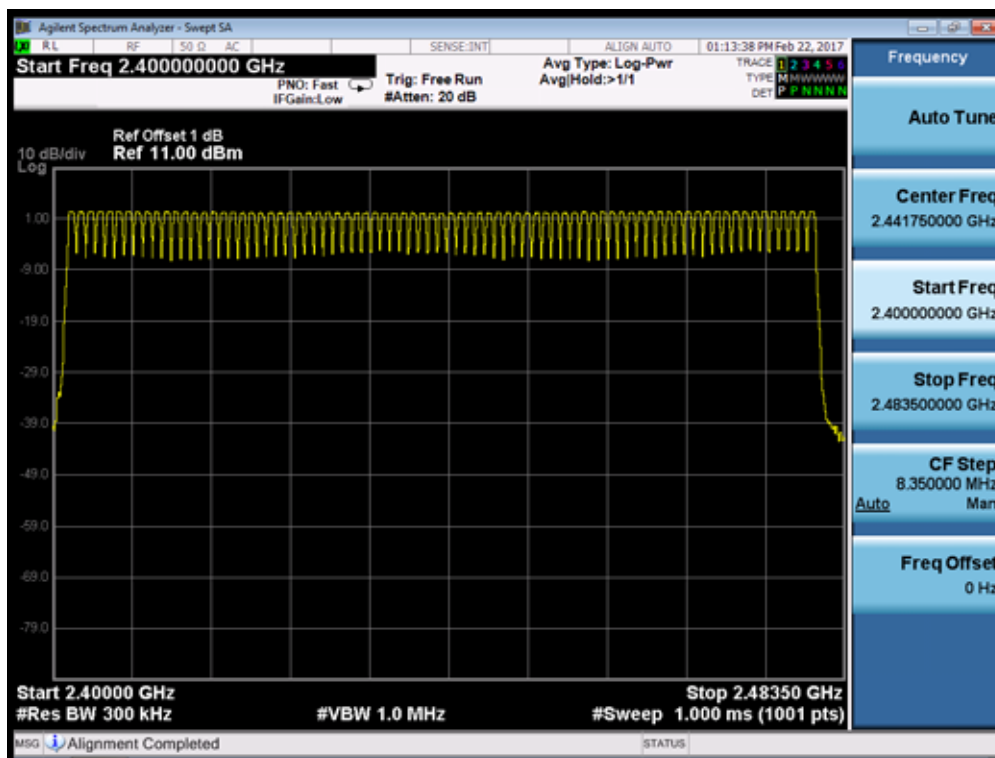



Test Item	:	Number of Hopping Frequencies
Test Mode	:	Mode 3: Transmitter 3DH5

Frequency Band (MHz)	Number of Hopping Frequencies	Limit	Result
2400 - 2483.5	79	>15	Pass

2402 - 2480 MHz

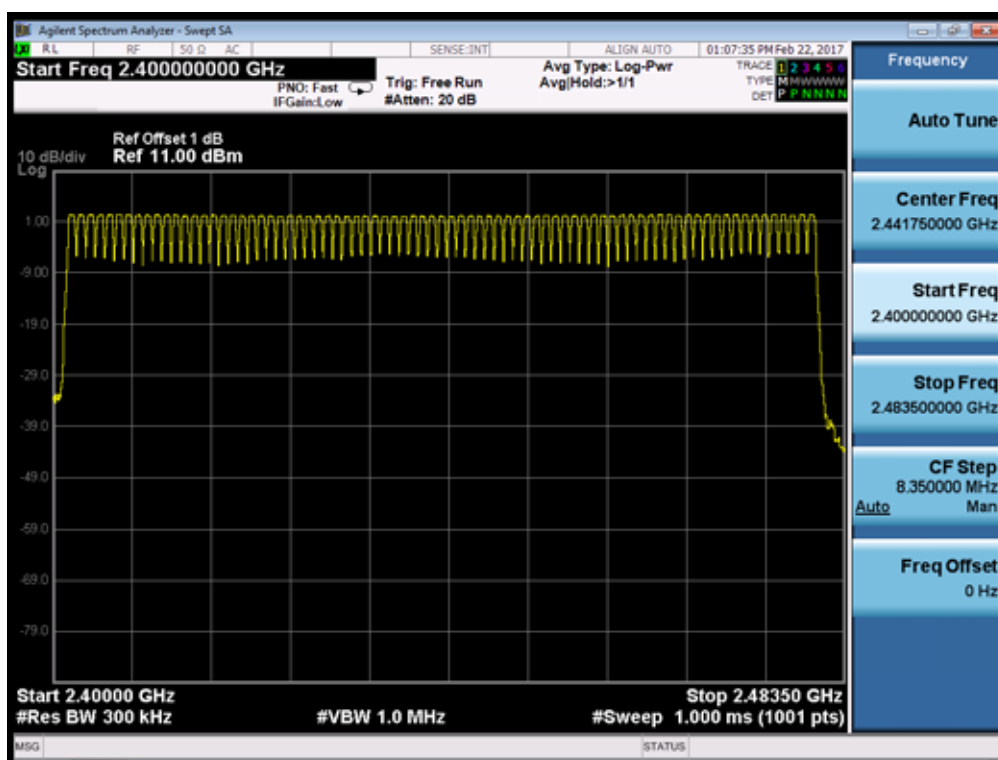



10. Peak Output Power Measurement

10.1 Test Limit

The Maximum Peak Output Power Measurement is 125mW (20.97dBm).

10.2 Test Standard

ANSI C63.10-2013- Section 7.8.5

10.3 Test Setup

Spectrum analyzer method

a) Use the following spectrum analyzer settings:

- 1) Span: Approximately five times the 20 dB bandwidth, centered on a hopping channel.
 - 2) RBW > 20 dB bandwidth of the emission being measured.
 - 3) VBW \geq RBW.
 - 4) Sweep: Auto.
 - 5) Detector function: Peak.
 - 6) Trace: Max hold.
- b) Allow trace to stabilize.
- c) Use the marker-to-peak function to set the marker to the peak of the emission.
- d) The indicated level is the peak output power, after any corrections for external attenuators and cables.
- e) A plot of the test results and setup description shall be included in the test report

Peak power meter method

The antenna port (RF output) of the EUT was connected to the input (RF input) of a power meter. Power was read directly from the meter and cable loss connection was added to the reading to obtain power at the EUT antenna terminal. The EUT Output Power was set to maximum to produce the worse case test result.

10.4 Test Setup Layout

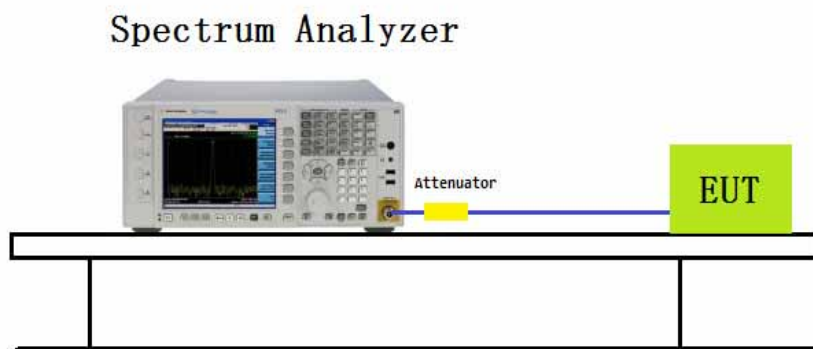



10.5 Test Result and Data

Test Item	:	Peak Output Power
Test Mode	:	Mode 1: Transmitter DH5

Channel No.	Frequency (MHz)	Measurement Power Output (dBm)	Limit (dBm)	Result
0	2402	2.300	20.97	Pass
39	2441	1.920	20.97	Pass
78	2480	2.196	20.97	Pass

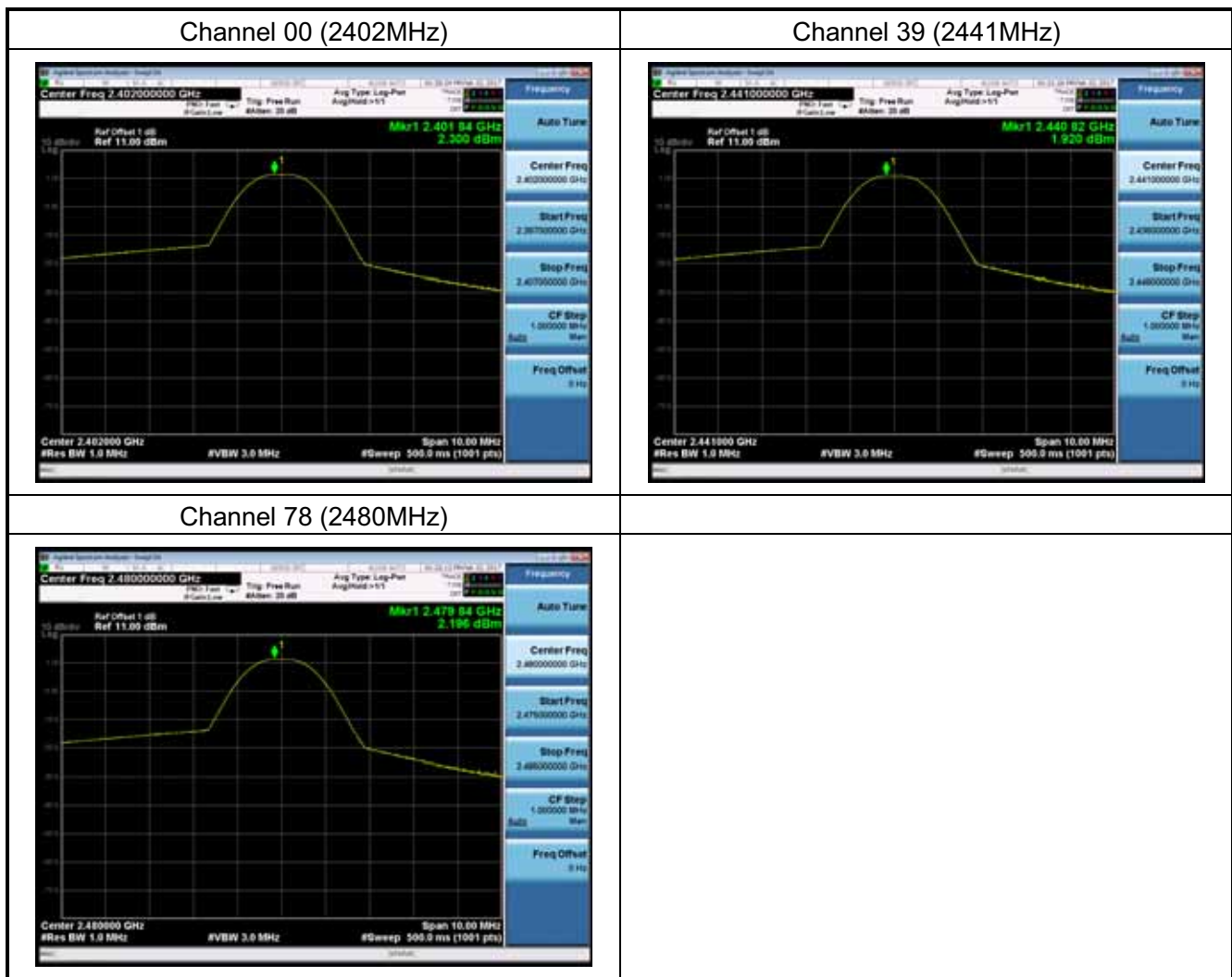



Test Item	:	Peak Output Power
Test Mode	:	Mode 2: Transmitter 2DH5

Channel No.	Frequency (MHz)	Measurement Power Output (dBm)	Limit (dBm)	Result
0	2402	2.514	20.97	Pass
39	2441	2.160	20.97	Pass
78	2480	2.455	20.97	Pass

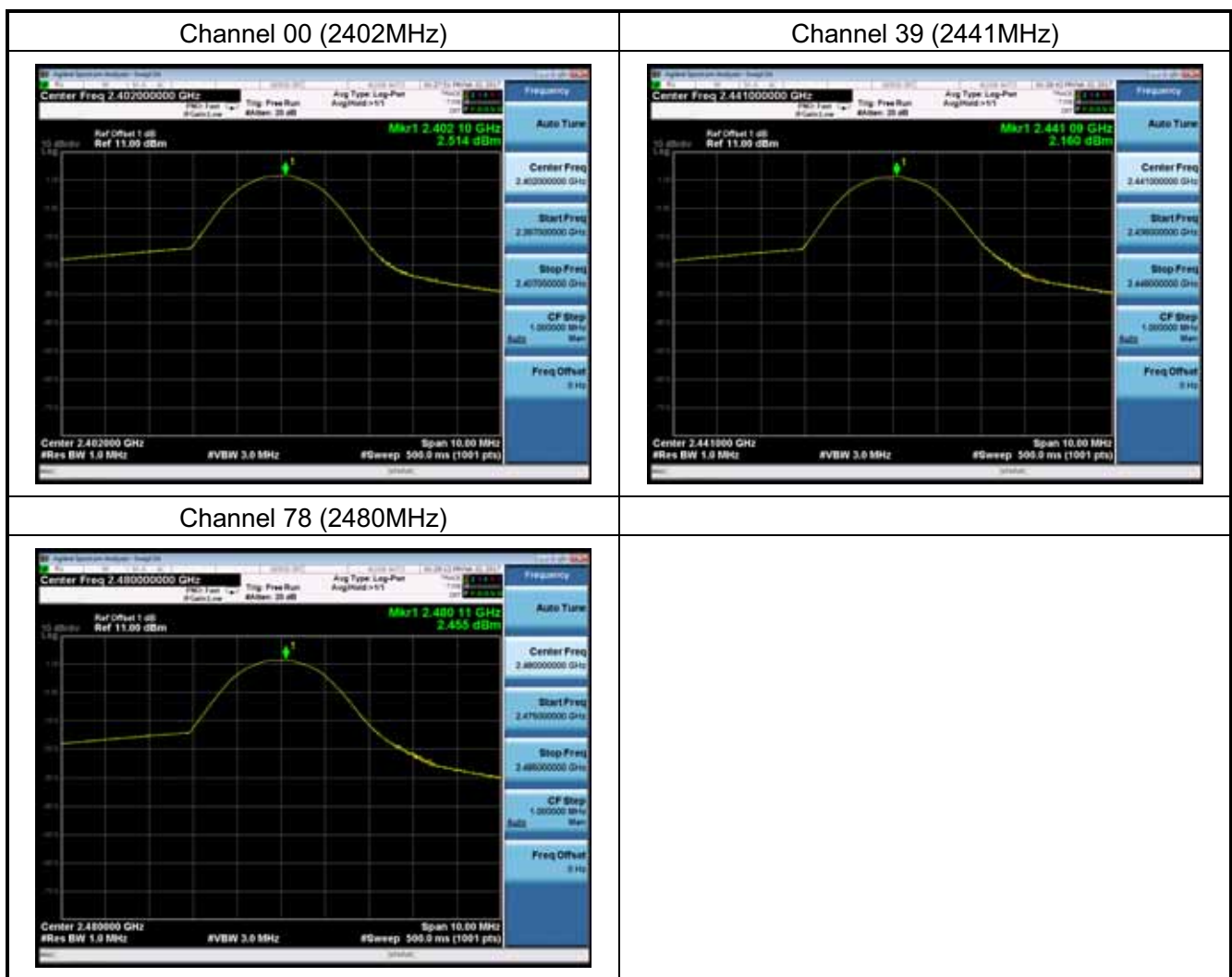



Test Item	:	Peak Output Power
Test Mode	:	Mode 3: Transmitter 3DH5

Channel No.	Frequency (MHz)	Measurement Power Output (dBm)	Limit (dBm)	Result
0	2402	2.406	20.97	Pass
39	2441	2.045	20.97	Pass
78	2480	2.342	20.97	Pass

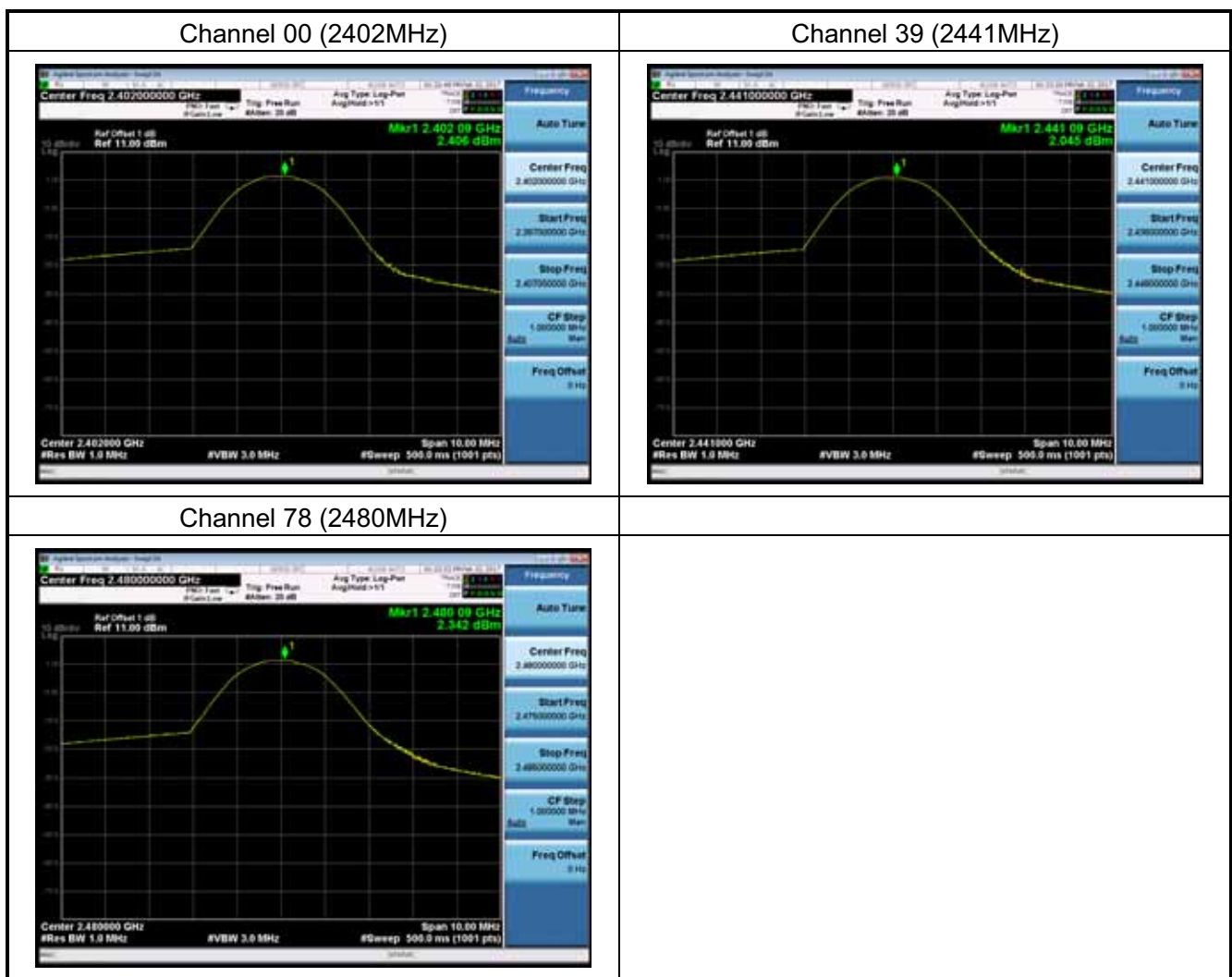



11. Conducted Spurious Emissions Measurement

11.1 Limit

In any 100 kHz bandwidth outside the frequency band in which the spread spectrum or digitally modulated intentional radiator is operating, the radio frequency power that is produced by the intentional radiator shall be at least 20 dB below that in the 100 kHz bandwidth within the band that contains the highest level of the desired power, based on either an RF conducted or a radiated measurement, provided the transmitter demonstrates compliance with the peak conducted or a radiated measurement, provided the transmitter demonstrates compliance with the peak conducted power limits. If the transmitter complies with the conducted power limits based on the use of RMS averaging over a time interval, the attenuation required under this paragraph shall be 30 dB instead of 20 dB. Attenuation below the general limits specified in Section 15.209(a) of FCC part 15 is not required.



11.2 Test Procedure

According to ANSI C63.10: 2010.

Use the following spectrum analyzer settings:

Span = wide enough to capture the peak level of the in-band emission and all spurious emissions (e.g., harmonics) from the lowest frequency generated in the EUT up through the 10th harmonic. Typically, several plots are required to cover this entire span.

RBW = 100 kHz

VBW \geq RBW

Sweep = auto

Detector function = peak

Trace = max hold

Allow the trace to stabilize. Set the marker on the peak of any spurious emission recorded. The level displayed must comply with the limit specified in this section.

11.3 Test Setup

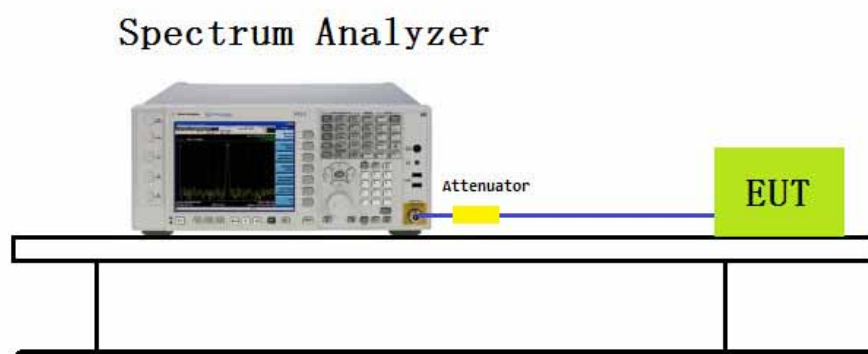



11.4 Test Result

Test Item	: Conducted Spurious Emissions
Test Mode	: Mode 1: Transmitter DH5

Mode 1: Transmit by DH5 (2402MHz)

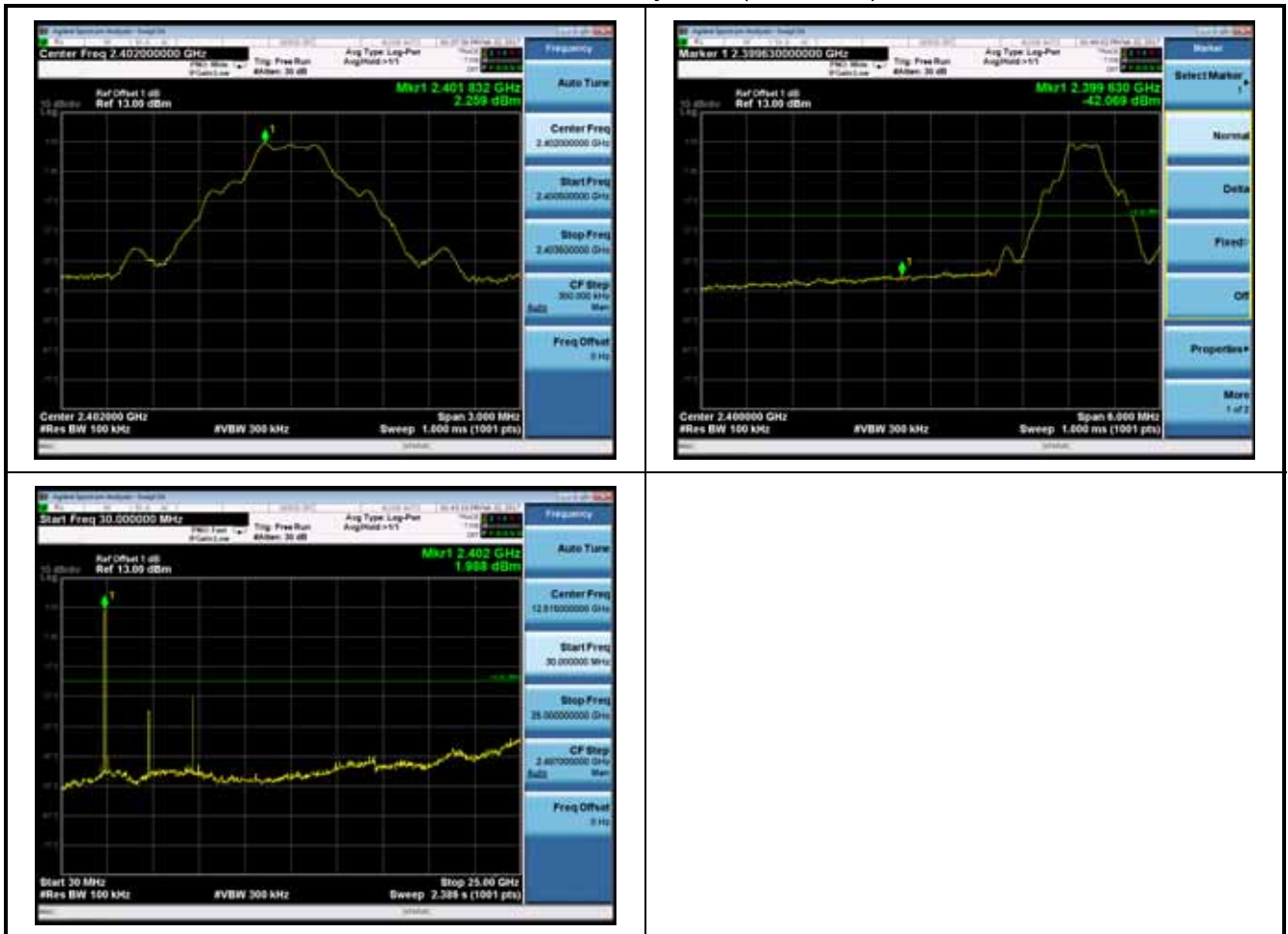



Mode 1: Transmit by DH5 (2441MHz)

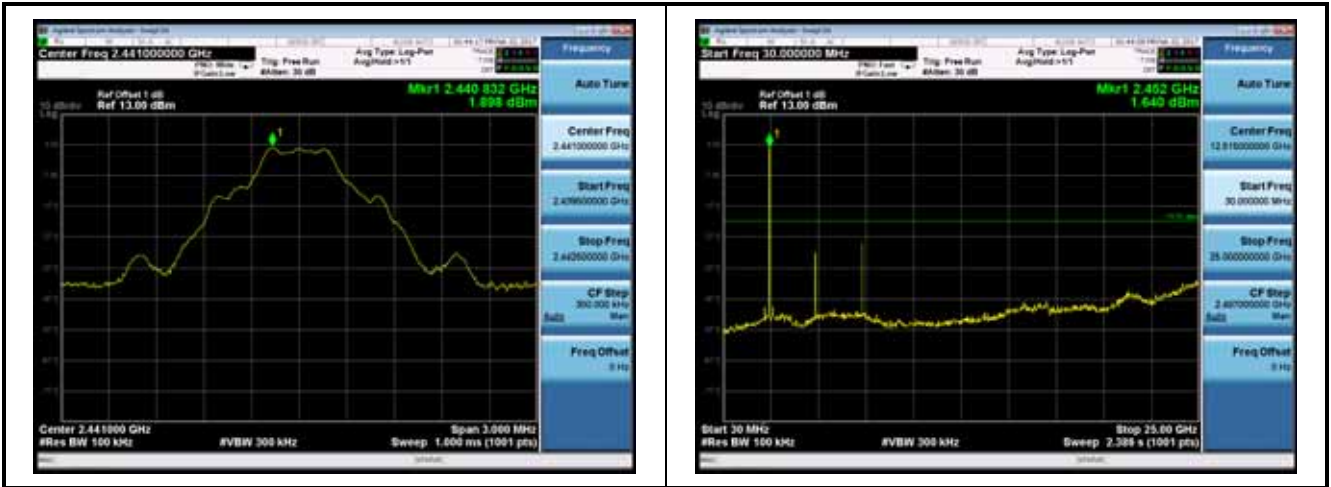

Mode 1: Transmit by DH5 (2480MHz)

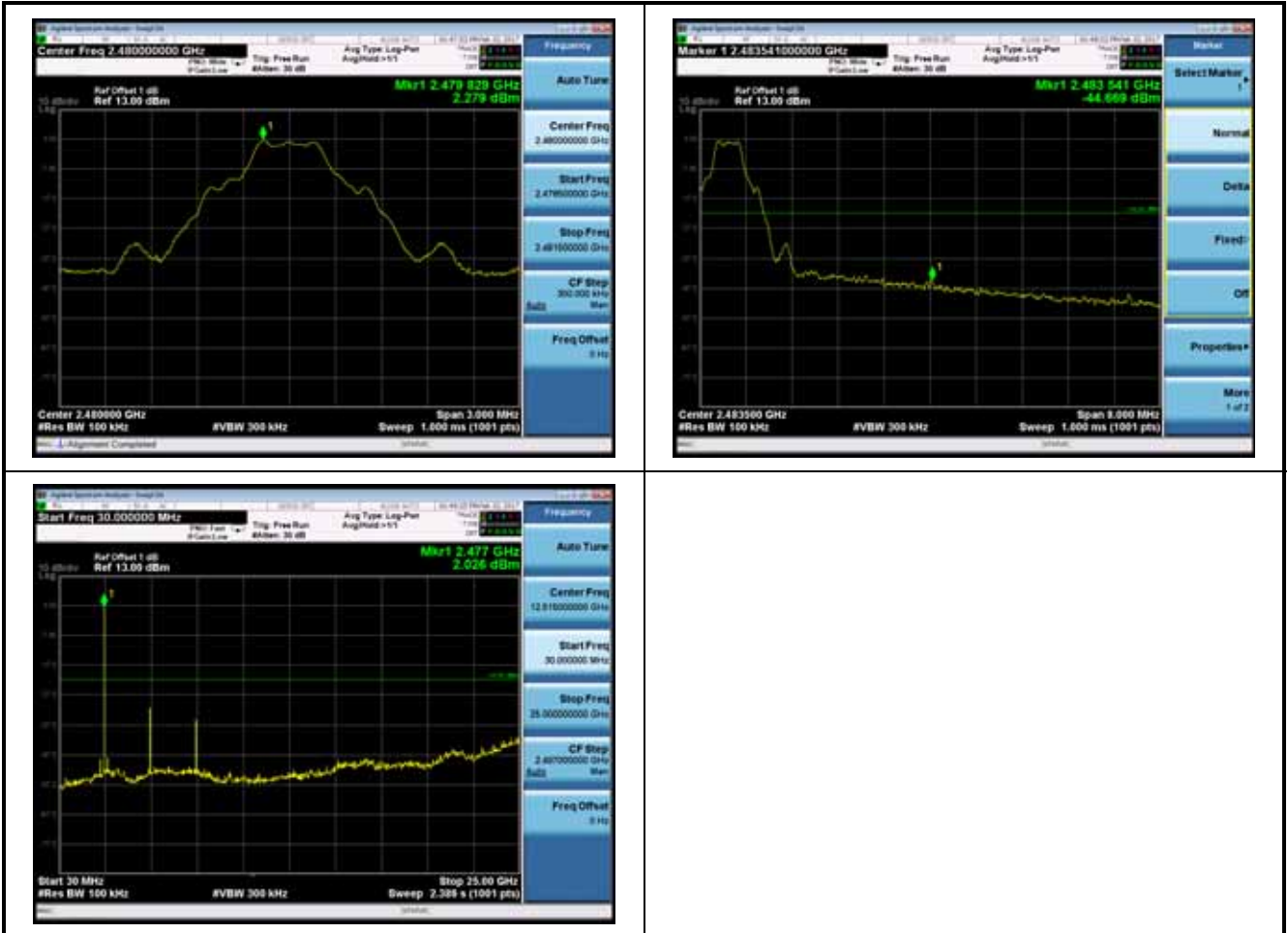



Test Item	:	Conducted Spurious Emissions
Test Mode	:	Mode 2: Transmitter 2DH5

Mode 2: Transmit by 2DH5 (2402MHz)





Mode 2: Transmit by 2DH5 (2441MHz)

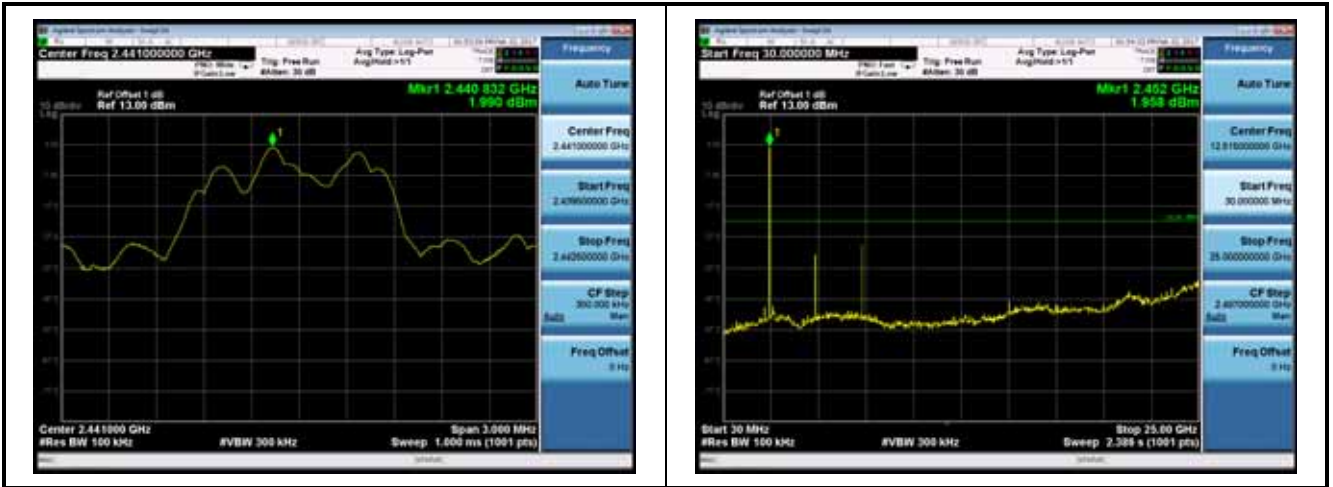

Mode 2: Transmit by 2DH5 (2480MHz)

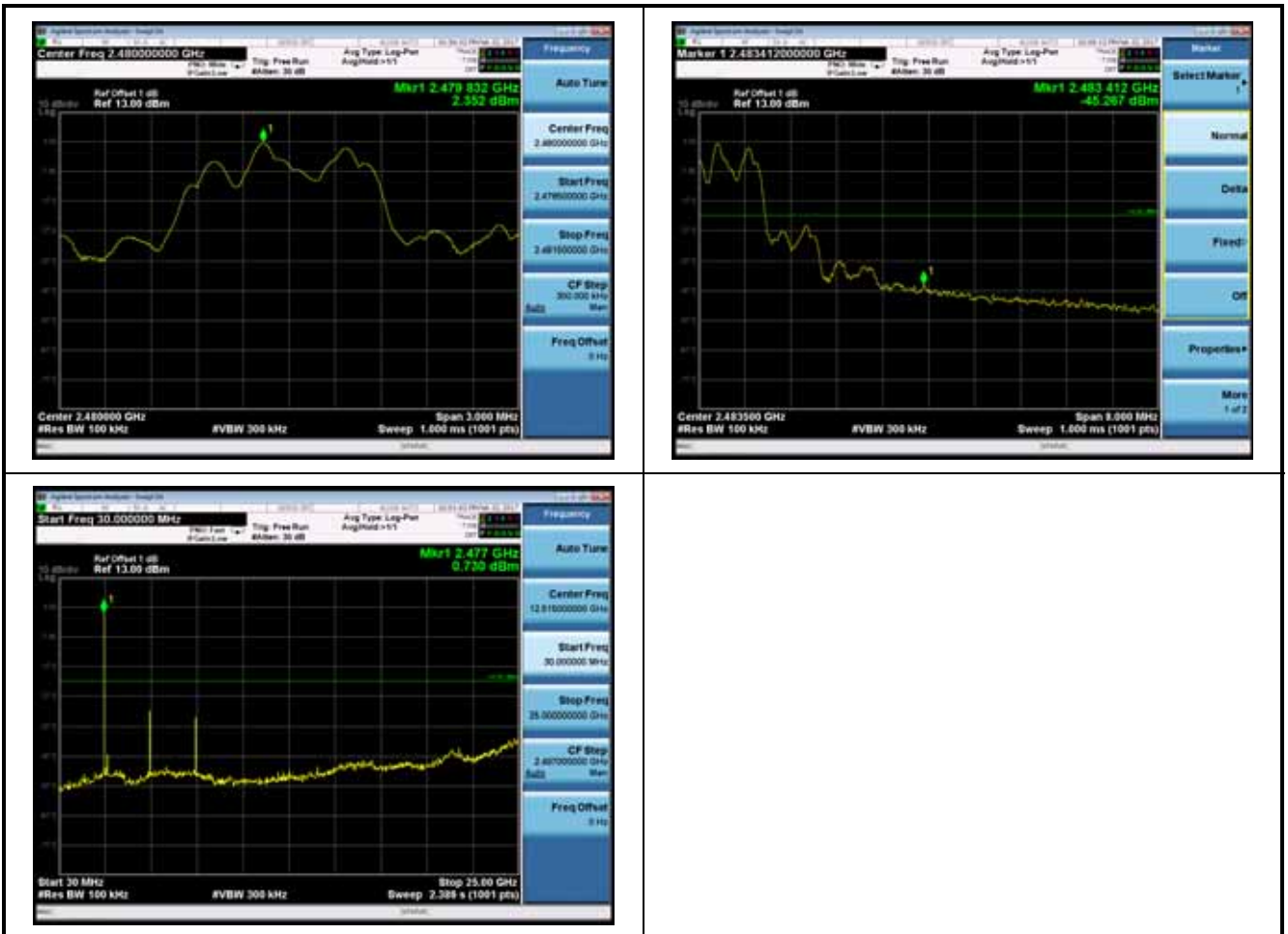



Test Item	:	Conducted Spurious Emissions
Test Mode	:	Mode 3: Transmitter 3DH5

Mode 3: Transmit by 3DH5 (2402MHz)





Mode 3: Transmit by 3DH5 (2441MHz)



Mode 3: Transmit by 3DH5 (2480MHz)

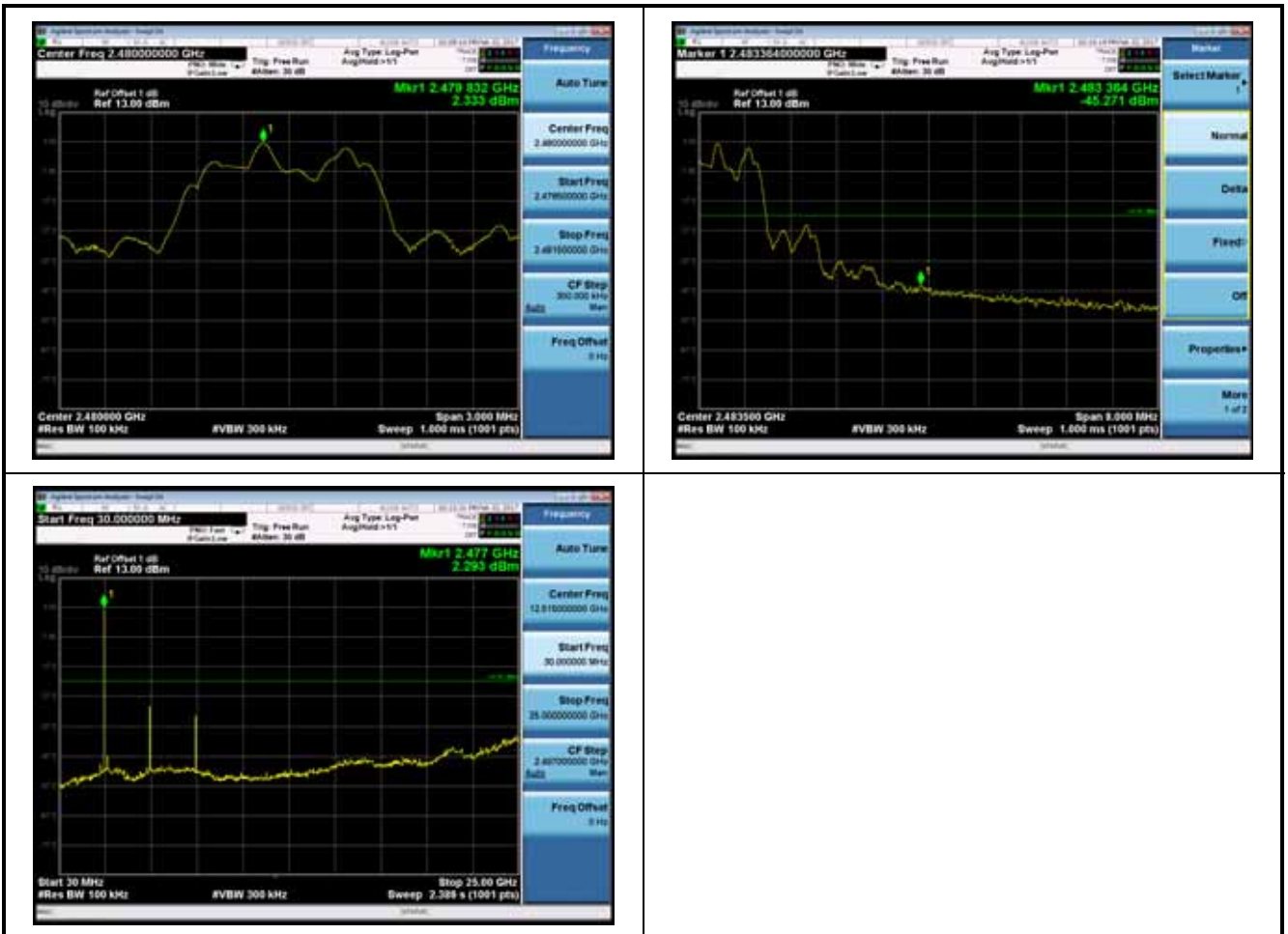



12. Radiated Emission Band Edge Measurement

12.1 Limit

Radiated emissions which fall in the restricted bands, as defined in Section 15.205(a) of FCC part 15, must also comply with the radiated emission limits specified in Section 15.209(a) of FCC part 15.

12.2 Test Procedure

According to ANSI C63.10: 2013.

This test is required for any spurious emission or modulation product that falls in a Restricted Band, as defined in Section 15.205 of FCC part 15. It must be performed with the highest gain of each type of antenna proposed for use with the EUT. Use the following spectrum analyzer settings:

Span = wide enough to fully capture the emission being measured

RBW = 1 MHz for $f \geq 1$ GHz, 100 kHz for $f < 1$ GHz

VBW \geq RBW

Sweep = auto

Detector function = peak

Trace = max hold

Follow the guidelines in ANSI C63.10 with respect to maximizing the emission by rotating the EUT, measuring the emission while the EUT is situated in three orthogonal planes (if appropriate), adjusting the measurement antenna height and polarization, etc. A pre-amp and a high pass filter are required for this test, in order to provide the measuring system with sufficient sensitivity. Allow the trace to stabilize. The peak reading of the emission, after being corrected by the antenna factor, cable loss, pre-amp gain, etc., is the peak field strength, which must comply with the limit specified in Section 15.35(b) of FCC part 15.

Now set the VBW to 10 Hz, while maintaining all of the other instrument settings. This peak level, once corrected, must comply with the limit specified in Section 15.209 of FCC Part 15. If the dwell time per channel of the hopping signal is less than 100 ms, then the reading obtained with the 10 Hz VBW may be further adjusted by a “duty cycle correction factor”, derived from $20\log(\text{dwell time}/100 \text{ ms})$, in an effort to demonstrate compliance with the 15.209 limit of FCC part 15.

If the emission on which a radiated measurement must be made is located at the edge of the authorized band of operation, then the alternative “marker-delta” method may be employed.



12.3 Test Setup

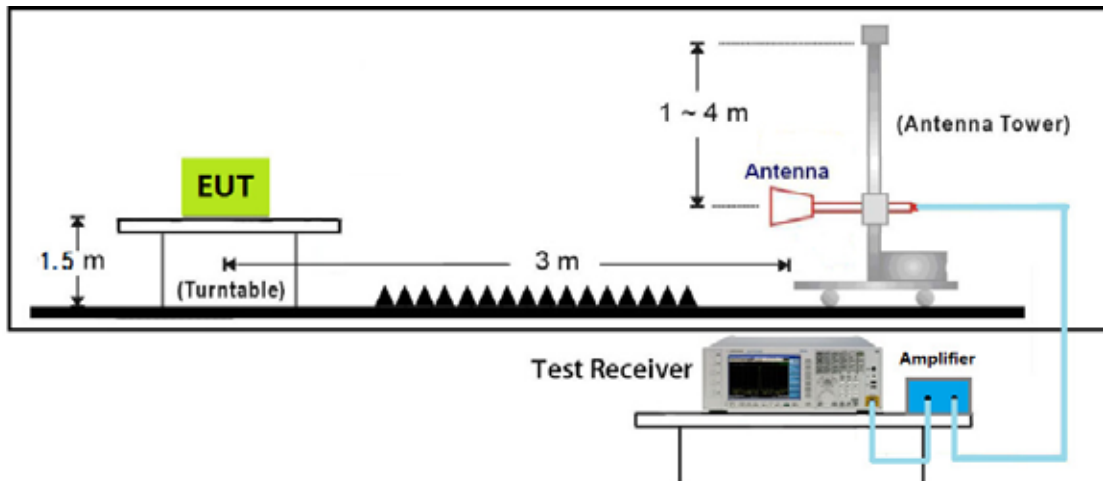



12.4 Test Result

Site: AC102	Time: 2017/02/28 - 17:30
Limit: FCC_Part15.209_RE(3m)	Margin: 0
Probe: N/A	Polarity: Horizontal
EUT: SIP-T54S	Power: AC 120V/60Hz
Note: Mode 1: Transmit DH5 at 2402MHz	

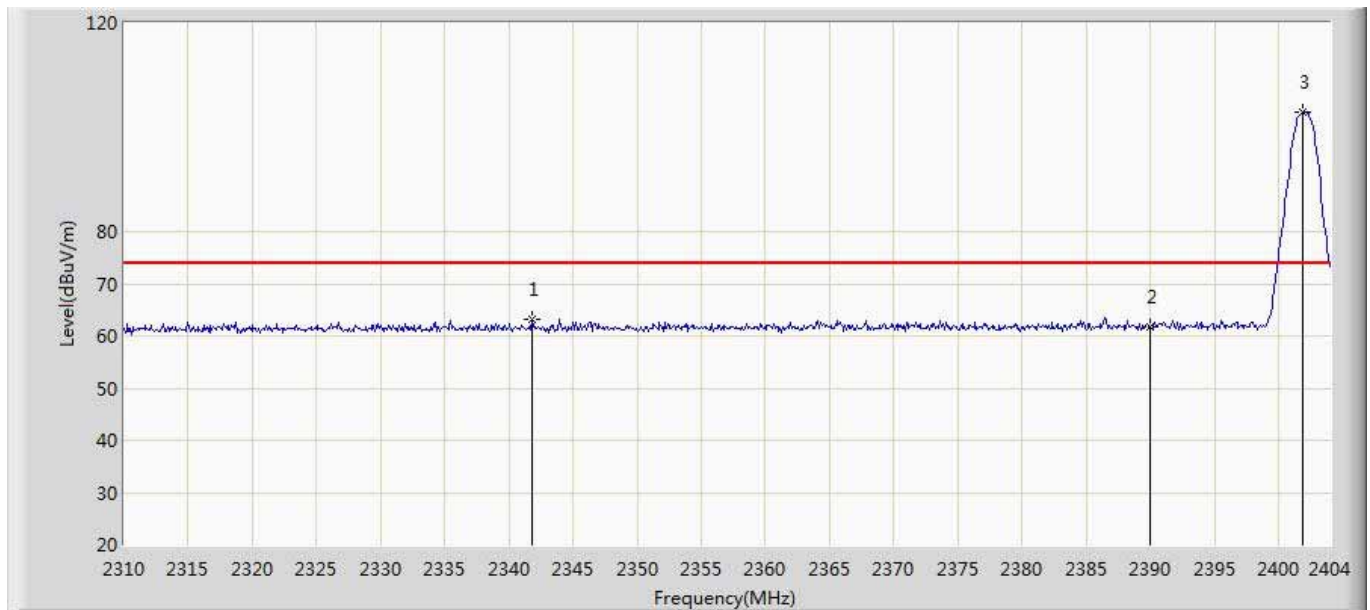

No	Mark	Frequency (MHz)	Measure Level (dBuV/m)	Reading Level (dBuV)	Over Limit (dB)	Limit (dBuV/m)	Factor (dB)	Type
1		2341.772	63.328	30.414	-10.672	74.000	32.915	PK
2		2390.000	61.698	28.587	-12.302	74.000	33.111	PK
3	*	2401.838	102.787	69.627	N/A	N/A	33.160	PK

Note: Measure Level (dBμV/m) = Reading Level (dBμV) + Factor (dB)

Factor (dB) = Cable Loss (dB) + Antenna Factor (dB/m).



Site: AC102	Time: 2017/02/28 - 17:36
Limit: FCC_Part15.209_RE(3m)	Margin: 0
Probe: N/A	Polarity: Horizontal
EUT: SIP-T54S	Power: AC 120V/60Hz
Note: Mode 1: Transmit DH5 at 2402MHz	

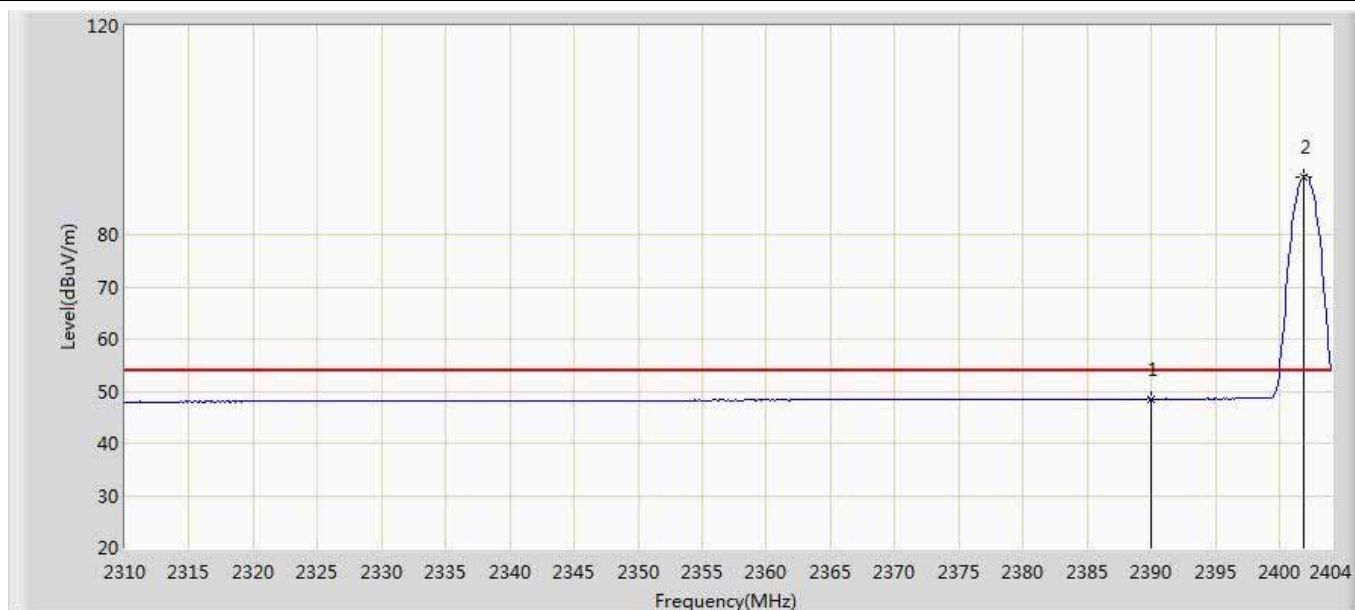

No	Mark	Frequency (MHz)	Measure Level (dBuV/m)	Reading Level (dBuV)	Over Limit (dB)	Limit (dBuV/m)	Factor (dB)	Type
1		2390.000	48.525	15.414	-5.475	54.000	33.111	AV
2	*	2401.838	91.102	57.942	N/A	N/A	33.160	AV

Note: Measure Level (dBμV/m) = Reading Level (dBμV) + Factor (dB)

Factor (dB) = Cable Loss (dB) + Antenna Factor (dB/m).



Site: AC102	Time: 2017/02/28 - 17:37
Limit: FCC_Part15.209_RE(3m)	Margin: 0
Probe: N/A	Polarity: Vertical
EUT: SIP-T54S	Power: AC 120V/60Hz
Note: Mode 1: Transmit DH5 at 2402MHz	

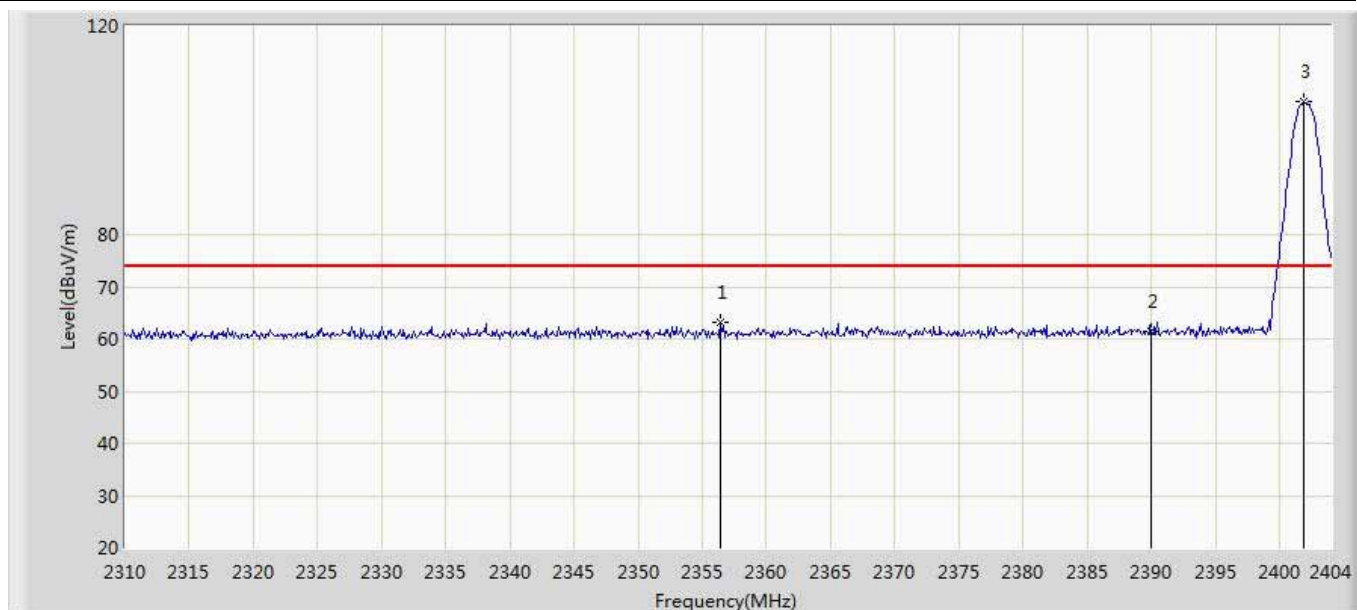

No	Mark	Frequency (MHz)	Measure Level (dBuV/m)	Reading Level (dBuV)	Over Limit (dB)	Limit (dBuV/m)	Factor (dB)	Type
1		2356.436	63.204	30.230	-10.796	74.000	32.974	PK
2		2390.000	61.345	28.234	-12.655	74.000	33.111	PK
3	*	2401.932	105.368	72.208	N/A	N/A	33.160	PK

Note: Measure Level (dBμV/m) = Reading Level (dBμV) + Factor (dB)

Factor (dB) = Cable Loss (dB) + Antenna Factor (dB/m).



Site: AC102	Time: 2017/02/28 - 17:41
Limit: FCC_Part15.209_RE(3m)	Margin: 0
Probe: N/A	Polarity: Vertical
EUT: SIP-T54S	Power: AC 120V/60Hz
Note: Mode 1: Transmit DH5 at 2402MHz	

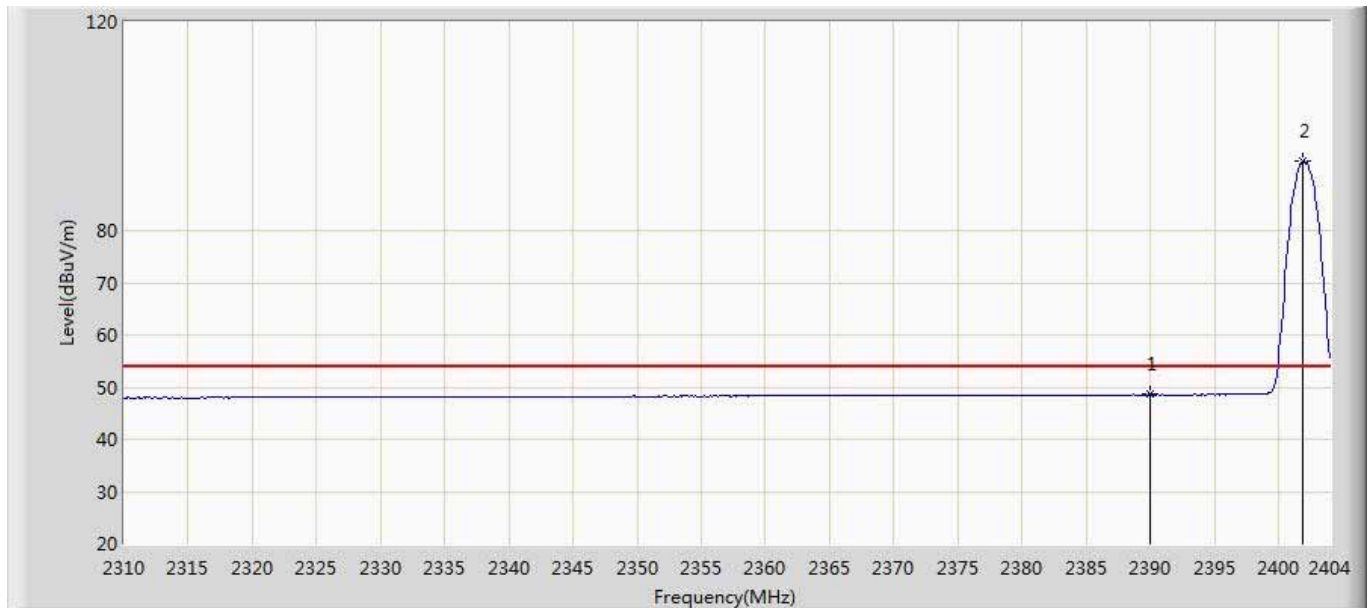

No	Mark	Frequency (MHz)	Measure Level (dBuV/m)	Reading Level (dBuV)	Over Limit (dB)	Limit (dBuV/m)	Factor (dB)	Type
1		2390.000	48.564	15.453	-5.436	54.000	33.111	AV
2	*	2401.932	93.242	60.082	N/A	N/A	33.160	AV

Note: Measure Level (dBμV/m) = Reading Level (dBμV) + Factor (dB)

Factor (dB) = Cable Loss (dB) + Antenna Factor (dB/m).



Site: AC102	Time: 2017/02/28 - 17:42
Limit: FCC_Part15.209_RE(3m)	Margin: 0
Probe: N/A	Polarity: Horizontal
EUT: SIP-T54S	Power: AC 120V/60Hz
Note: Mode 1: Transmit DH5 at 2480MHz	

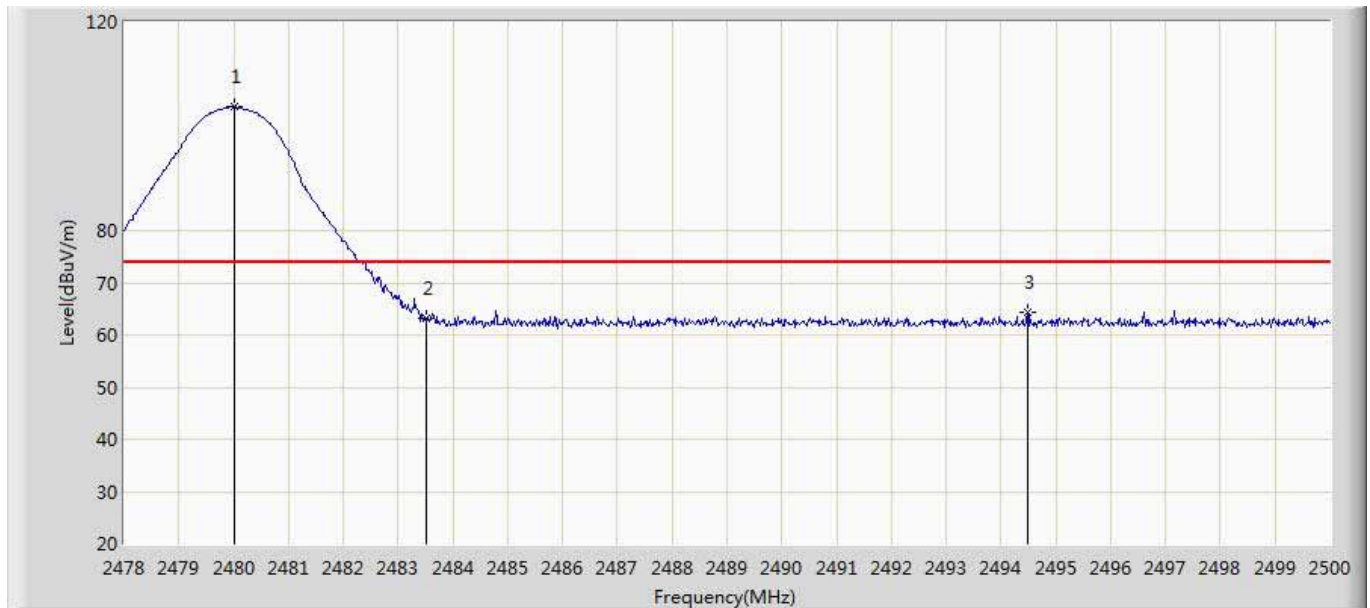

No	Mark	Frequency (MHz)	Measure Level (dBuV/m)	Reading Level (dBuV)	Over Limit (dB)	Limit (dBuV/m)	Factor (dB)	Type
1	*	2480.024	103.711	70.232	N/A	N/A	33.479	PK
2		2483.500	63.065	29.573	-10.935	74.000	33.493	PK
3		2494.478	64.253	30.716	-9.747	74.000	33.537	PK

Note: Measure Level (dBμV/m) = Reading Level (dBμV) + Factor (dB)

Factor (dB) = Cable Loss (dB) + Antenna Factor (dB/m).



Site: AC102	Time: 2017/02/28 - 17:48
Limit: FCC_Part15.209_RE(3m)	Margin: 0
Probe: N/A	Polarity: Horizontal
EUT: SIP-T54S	Power: AC 120V/60Hz
Note: Mode 1: Transmit DH5 at 2480MHz	

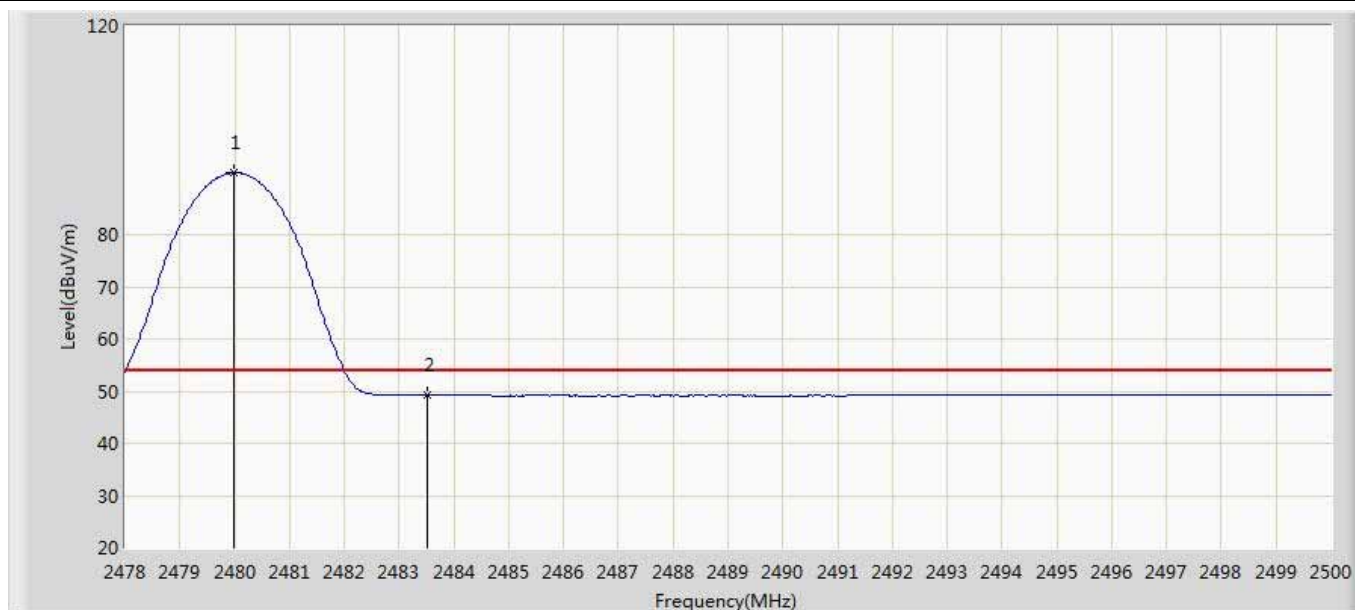

No	Mark	Frequency (MHz)	Measure Level (dBuV/m)	Reading Level (dBuV)	Over Limit (dB)	Limit (dBuV/m)	Factor (dB)	Type
1	*	2479.980	91.839	58.361	N/A	N/A	33.478	AV
2		2483.500	49.194	15.702	-4.806	54.000	33.493	AV

Note: Measure Level (dBμV/m) = Reading Level (dBμV) + Factor (dB)

Factor (dB) = Cable Loss (dB) + Antenna Factor (dB/m).



Site: AC102	Time: 2017/02/28 - 17:48
Limit: FCC_Part15.209_RE(3m)	Margin: 0
Probe: N/A	Polarity: Vertical
EUT: SIP-T54S	Power: AC 120V/60Hz
Note: Mode 1: Transmit DH5 at 2480MHz	

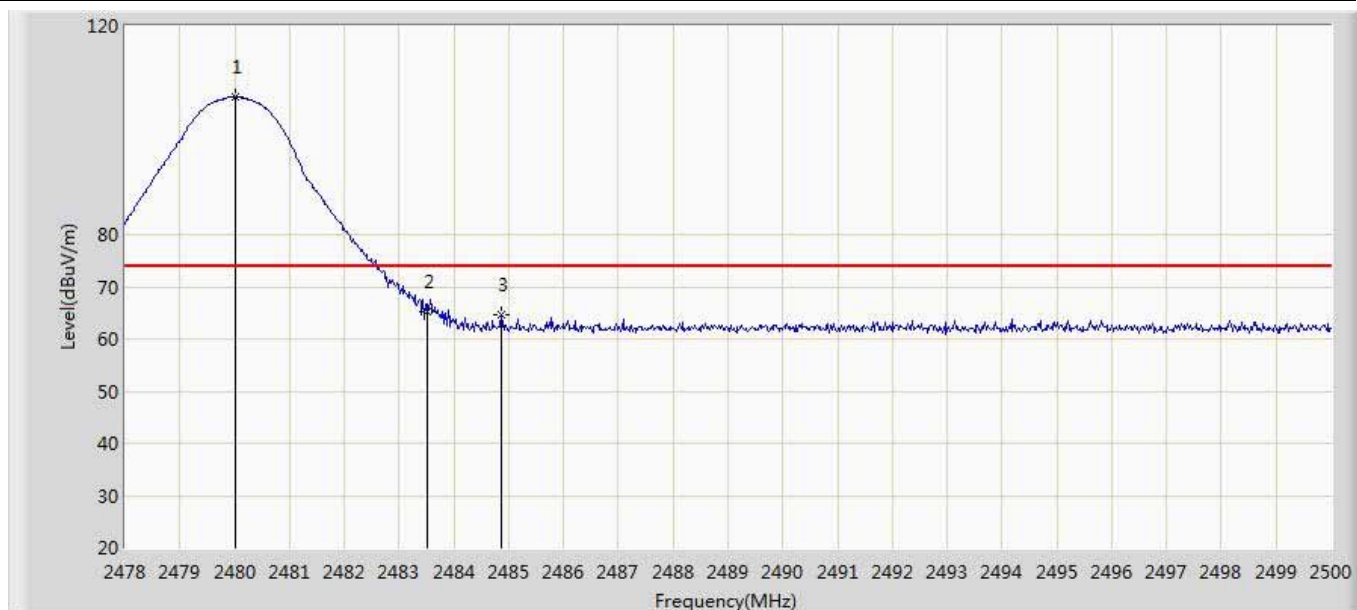

No	Mark	Frequency (MHz)	Measure Level (dBuV/m)	Reading Level (dBuV)	Over Limit (dB)	Limit (dBuV/m)	Factor (dB)	Type
1	*	2480.024	106.407	72.928	N/A	N/A	33.479	PK
2		2483.500	65.350	31.858	-8.650	74.000	33.493	PK
3		2484.864	64.678	31.180	-9.322	74.000	33.498	PK

Note: Measure Level (dBμV/m) = Reading Level (dBμV) + Factor (dB)

Factor (dB) = Cable Loss (dB) + Antenna Factor (dB/m).



Site: AC102	Time: 2017/02/28 - 17:51
Limit: FCC_Part15.209_RE(3m)	Margin: 0
Probe: N/A	Polarity: Vertical
EUT: SIP-T54S	Power: AC 120V/60Hz
Note: Mode 1: Transmit DH5 at 2480MHz	

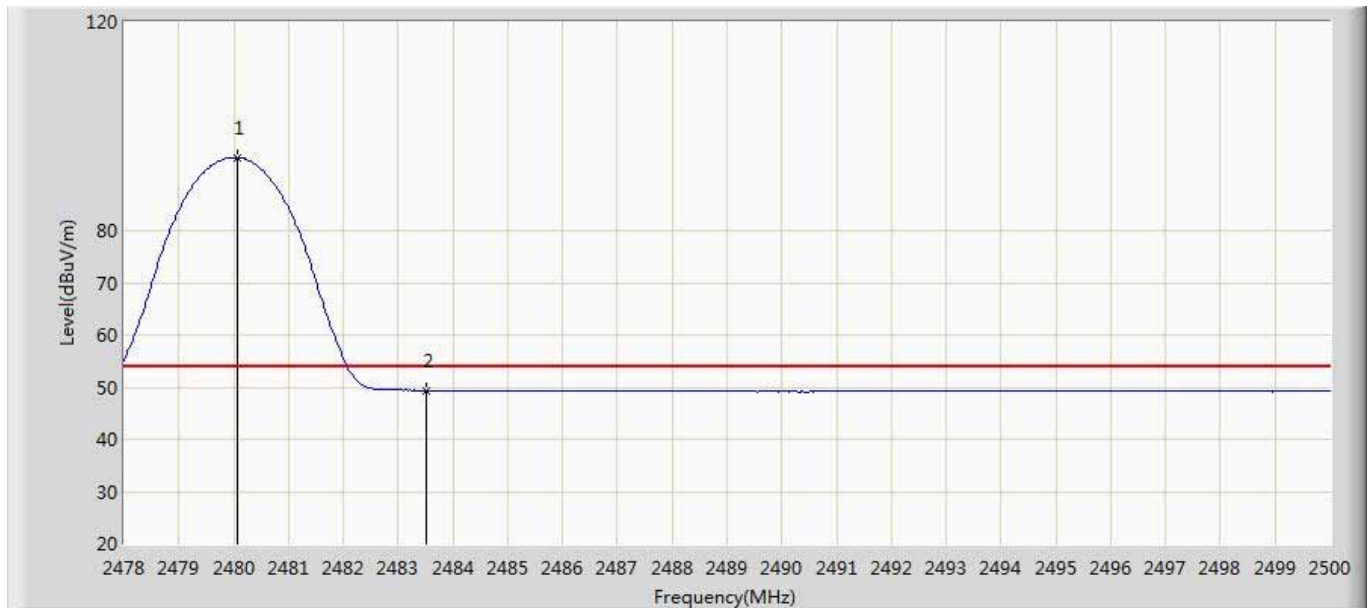

No	Mark	Frequency (MHz)	Measure Level (dBuV/m)	Reading Level (dBuV)	Over Limit (dB)	Limit (dBuV/m)	Factor (dB)	Type
1	*	2480.068	94.008	60.529	N/A	N/A	33.479	AV
2		2483.500	49.362	15.870	-4.638	54.000	33.493	AV

Note: Measure Level (dBμV/m) = Reading Level (dBμV) + Factor (dB)

Factor (dB) = Cable Loss (dB) + Antenna Factor (dB/m).



Site: AC102	Time: 2017/02/28 - 18:26
Limit: FCC_Part15.209_RE(3m)	Margin: 0
Probe: N/A	Polarity: Horizontal
EUT: SIP-T54S	Power: AC 120V/60Hz
Note: Mode 2: Transmit 2DH5 at 2402MHz	

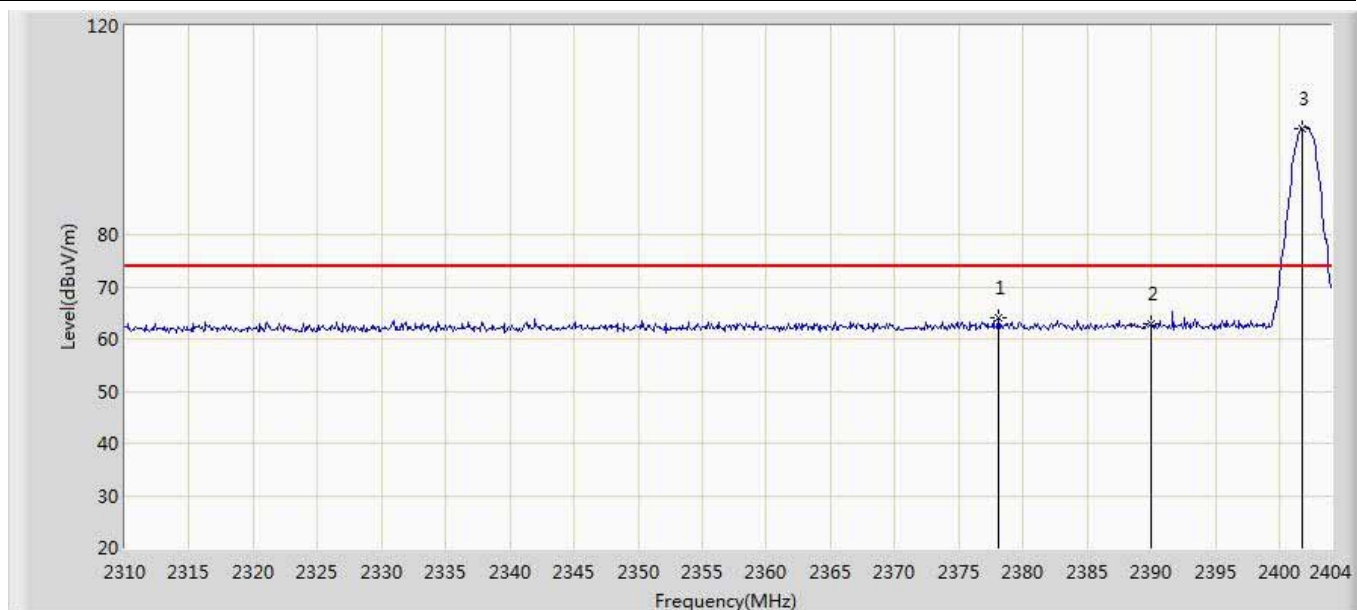

No	Mark	Frequency (MHz)	Measure Level (dBuV/m)	Reading Level (dBuV)	Over Limit (dB)	Limit (dBuV/m)	Factor (dB)	Type
1		2378.056	64.081	31.019	-9.919	74.000	33.063	PK
2		2390.000	62.880	29.769	-11.120	74.000	33.111	PK
3	*	2401.744	100.393	67.234	N/A	N/A	33.160	PK

Note: Measure Level (dBμV/m) = Reading Level (dBμV) + Factor (dB)

Factor (dB) = Cable Loss (dB) + Antenna Factor (dB/m).



Site: AC102	Time: 2017/02/28 - 18:29
Limit: FCC_Part15.209_RE(3m)	Margin: 0
Probe: N/A	Polarity: Horizontal
EUT: SIP-T54S	Power: AC 120V/60Hz
Note: Mode 2: Transmit 2DH5 at 2402MHz	

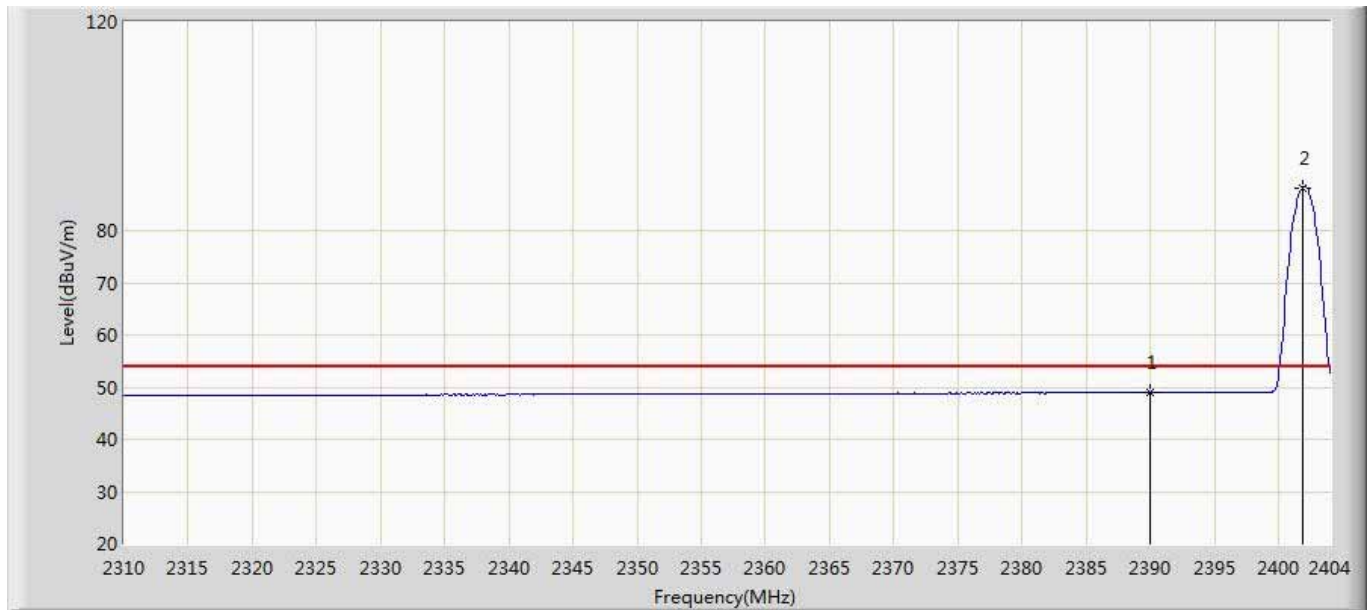

No	Mark	Frequency (MHz)	Measure Level (dBuV/m)	Reading Level (dBuV)	Over Limit (dB)	Limit (dBuV/m)	Factor (dB)	Type
1		2390.000	48.960	15.849	-5.040	54.000	33.111	AV
2	*	2401.838	88.168	55.008	N/A	N/A	33.160	AV

Note: Measure Level (dBμV/m) = Reading Level (dBμV) + Factor (dB)

Factor (dB) = Cable Loss (dB) + Antenna Factor (dB/m).



Site: AC102	Time: 2017/02/28 - 18:30
Limit: FCC_Part15.209_RE(3m)	Margin: 0
Probe: N/A	Polarity: Vertical
EUT: SIP-T54S	Power: AC 120V/60Hz
Note: Mode 2: Transmit 2DH5 at 2402MHz	

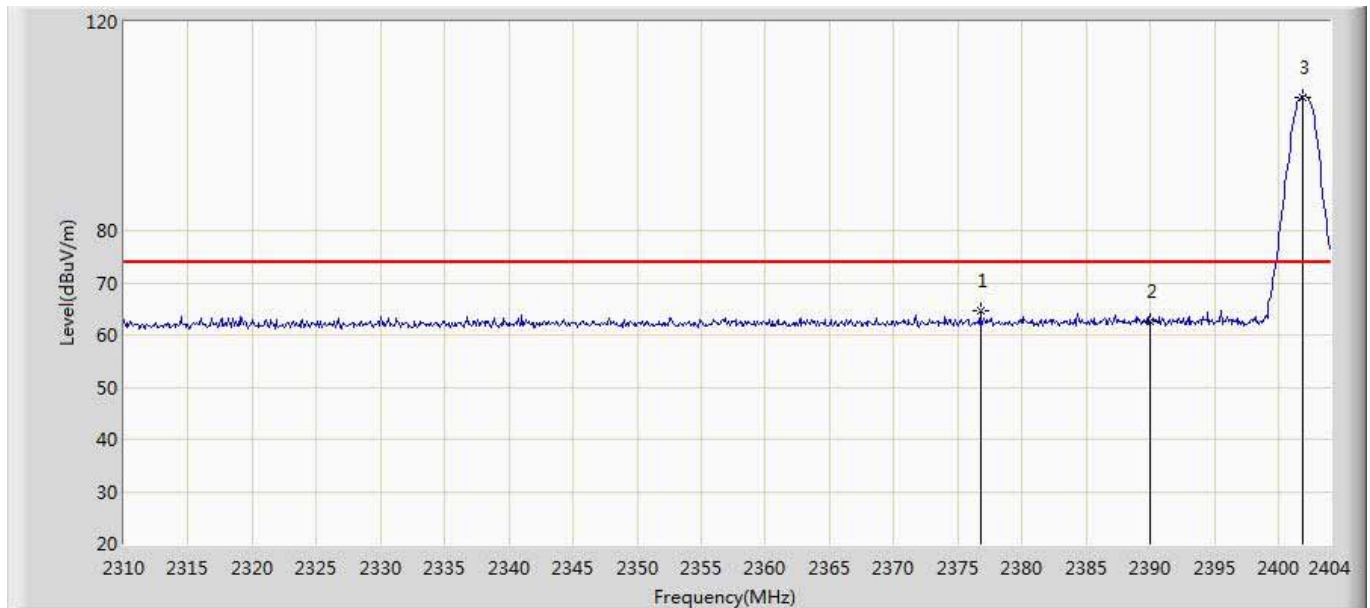

No	Mark	Frequency (MHz)	Measure Level (dBuV/m)	Reading Level (dBuV)	Over Limit (dB)	Limit (dBuV/m)	Factor (dB)	Type
1		2376.740	64.545	31.488	-9.455	74.000	33.057	PK
2		2390.000	62.634	29.523	-11.366	74.000	33.111	PK
3	*	2401.838	105.649	72.489	N/A	N/A	33.160	PK

Note: Measure Level (dBμV/m) = Reading Level (dBμV) + Factor (dB)

Factor (dB) = Cable Loss (dB) + Antenna Factor (dB/m).



Site: AC102	Time: 2017/02/28 - 18:32
Limit: FCC_Part15.209_RE(3m)	Margin: 0
Probe: N/A	Polarity: Vertical
EUT: SIP-T54S	Power: AC 120V/60Hz
Note: Mode 2: Transmit 2DH5 at 2402MHz	

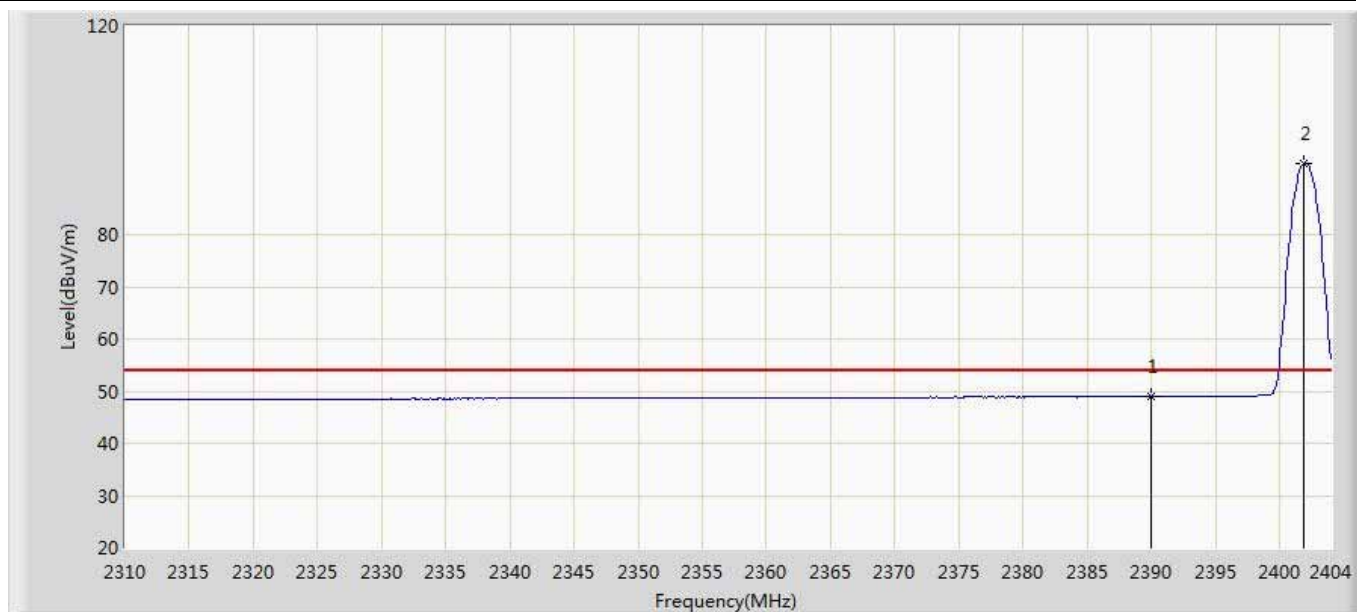

No	Mark	Frequency (MHz)	Measure Level (dBuV/m)	Reading Level (dBuV)	Over Limit (dB)	Limit (dBuV/m)	Factor (dB)	Type
1		2390.000	48.967	15.856	-5.033	54.000	33.111	AV
2	*	2401.838	93.519	60.359	N/A	N/A	33.160	AV

Note: Measure Level (dBμV/m) = Reading Level (dBμV) + Factor (dB)

Factor (dB) = Cable Loss (dB) + Antenna Factor (dB/m).



Site: AC102	Time: 2017/02/28 - 18:33
Limit: FCC_Part15.209_RE(3m)	Margin: 0
Probe: N/A	Polarity: Horizontal
EUT: SIP-T54S	Power: AC 120V/60Hz
Note: Mode 2: Transmit 2DH5 at 2480MHz	

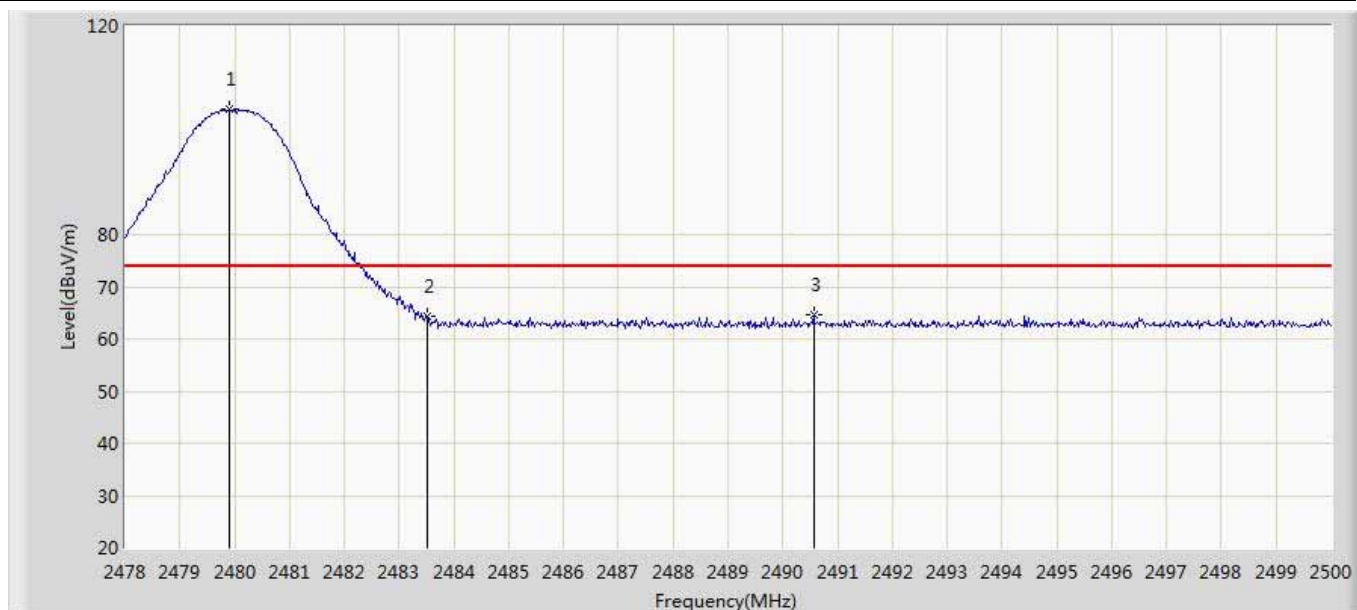

No	Mark	Frequency (MHz)	Measure Level (dBuV/m)	Reading Level (dBuV)	Over Limit (dB)	Limit (dBuV/m)	Factor (dB)	Type
1	*	2479.914	104.201	70.723	N/A	N/A	33.478	PK
2		2483.500	64.410	30.918	-9.590	74.000	33.493	PK
3		2490.562	64.718	31.197	-9.282	74.000	33.521	PK

Note: Measure Level (dBμV/m) = Reading Level (dBμV) + Factor (dB)

Factor (dB) = Cable Loss (dB) + Antenna Factor (dB/m).



Site: AC102	Time: 2017/02/28 - 18:40
Limit: FCC_Part15.209_RE(3m)	Margin: 0
Probe: N/A	Polarity: Horizontal
EUT: SIP-T54S	Power: AC 120V/60Hz
Note: Mode 2: Transmit 2DH5 at 2480MHz	

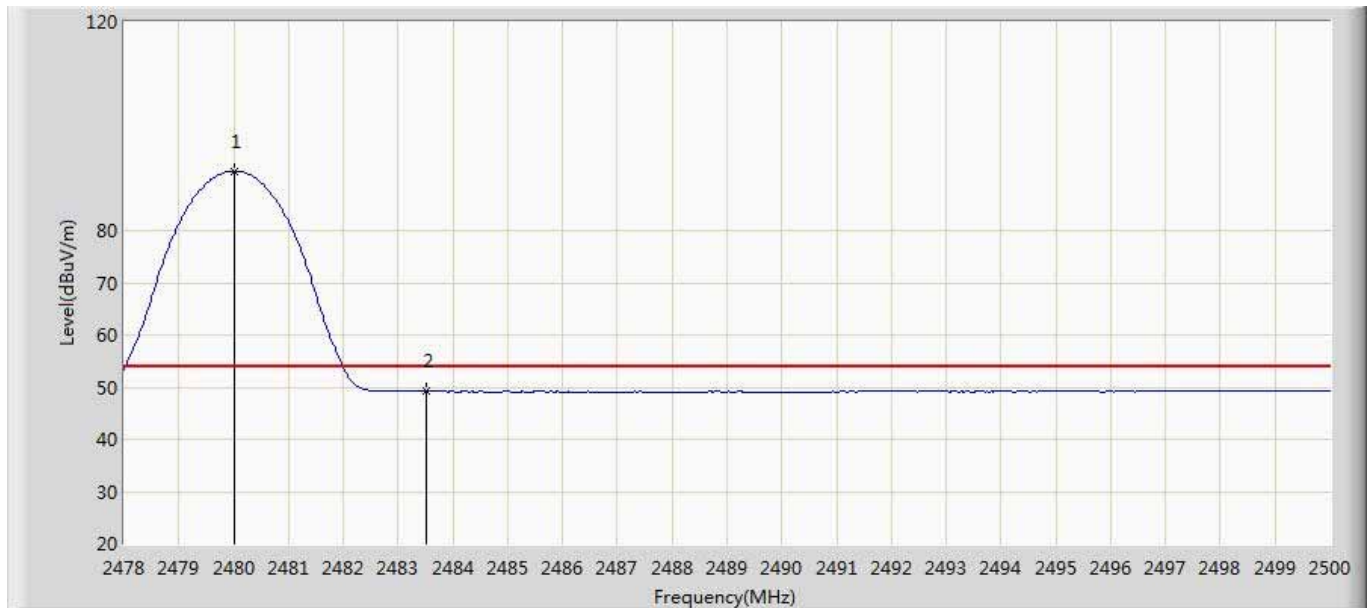

No	Mark	Frequency (MHz)	Measure Level (dBuV/m)	Reading Level (dBuV)	Over Limit (dB)	Limit (dBuV/m)	Factor (dB)	Type
1	*	2480.024	91.429	57.950	N/A	N/A	33.479	AV
2		2483.500	49.166	15.674	-4.834	54.000	33.493	AV

Note: Measure Level (dBμV/m) = Reading Level (dBμV) + Factor (dB)

Factor (dB) = Cable Loss (dB) + Antenna Factor (dB/m).



Site: AC102	Time: 2017/02/28 - 18:41
Limit: FCC_Part15.209_RE(3m)	Margin: 0
Probe: N/A	Polarity: Vertical
EUT: SIP-T54S	Power: AC 120V/60Hz
Note: Mode 2: Transmit 2DH5 at 2480MHz	

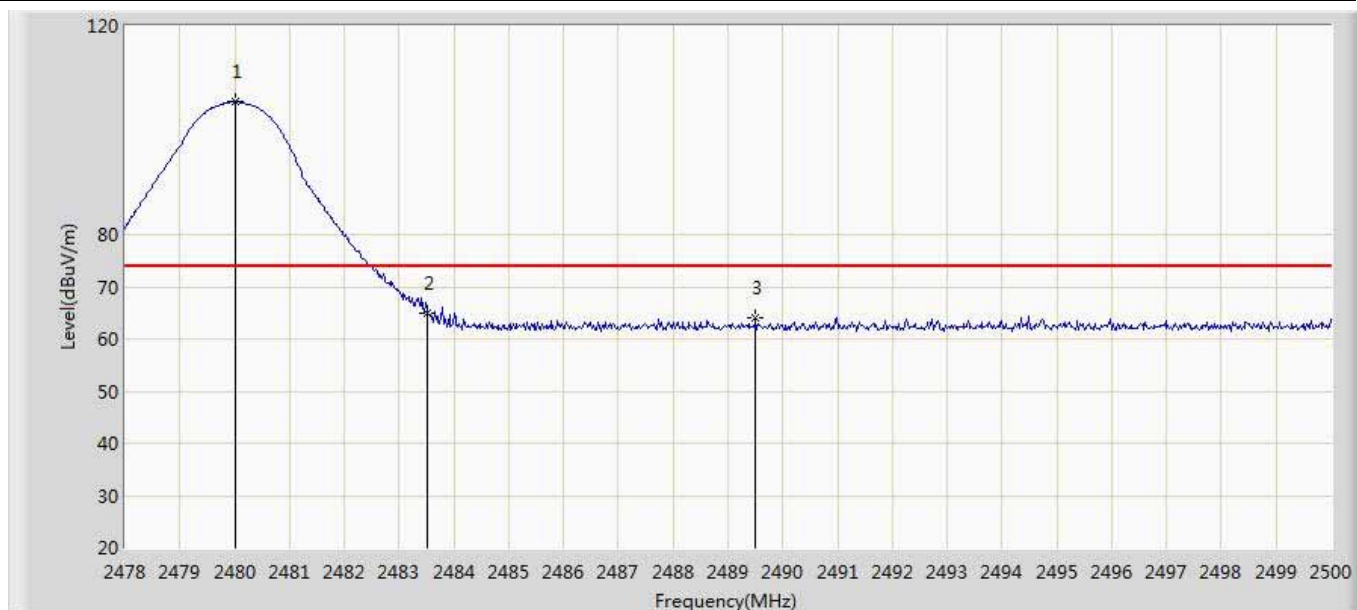

No	Mark	Frequency (MHz)	Measure Level (dBuV/m)	Reading Level (dBuV)	Over Limit (dB)	Limit (dBuV/m)	Factor (dB)	Type
1	*	2480.024	105.424	71.945	N/A	N/A	33.479	PK
2		2483.500	65.029	31.537	-8.971	74.000	33.493	PK
3		2489.506	63.946	30.429	-10.054	74.000	33.516	PK

Note: Measure Level (dBμV/m) = Reading Level (dBμV) + Factor (dB)

Factor (dB) = Cable Loss (dB) + Antenna Factor (dB/m).



Site: AC102	Time: 2017/02/28 - 18:43
Limit: FCC_Part15.209_RE(3m)	Margin: 0
Probe: N/A	Polarity: Vertical
EUT: SIP-T54S	Power: AC 120V/60Hz
Note: Mode 2: Transmit 2DH5 at 2480MHz	

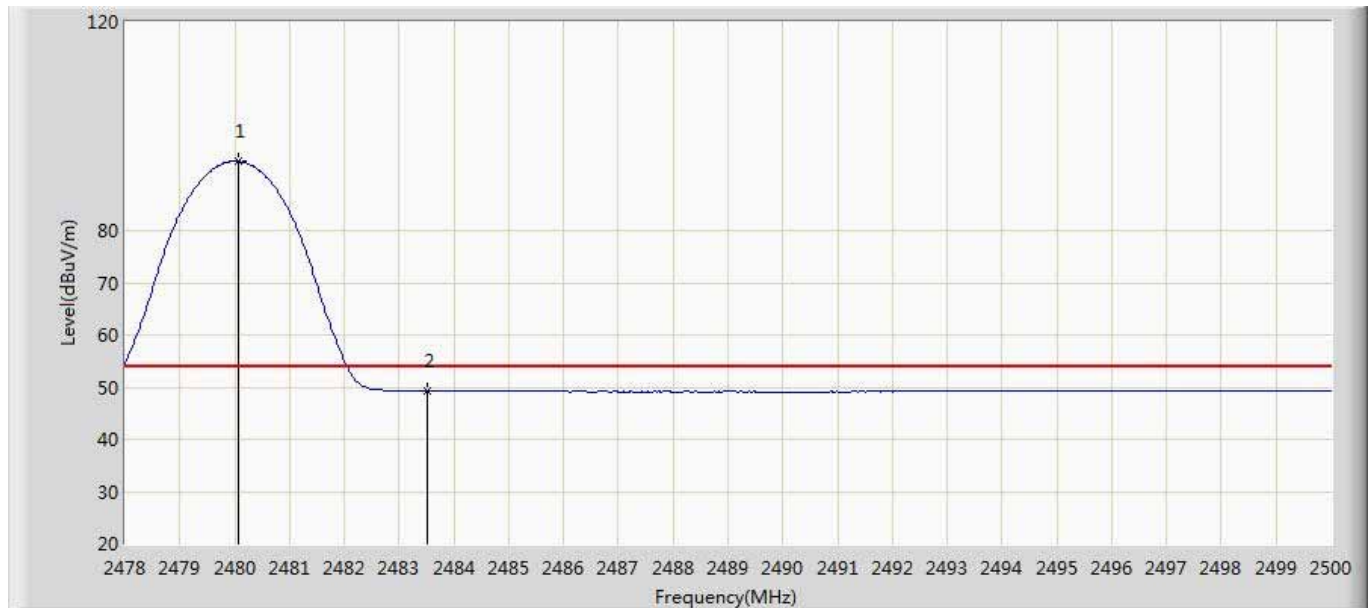

No	Mark	Frequency (MHz)	Measure Level (dBuV/m)	Reading Level (dBuV)	Over Limit (dB)	Limit (dBuV/m)	Factor (dB)	Type
1	*	2480.068	93.250	59.771	N/A	N/A	33.479	AV
2		2483.500	49.296	15.804	-4.704	54.000	33.493	AV

Note: Measure Level (dBμV/m) = Reading Level (dBμV) + Factor (dB)

Factor (dB) = Cable Loss (dB) + Antenna Factor (dB/m).



Site: AC102	Time: 2017/02/28 - 18:43
Limit: FCC_Part15.209_RE(3m)	Margin: 0
Probe: N/A	Polarity: Horizontal
EUT: SIP-T54S	Power: AC 120V/60Hz
Note: Mode 3: Transmit 3DH5 at 2402MHz	

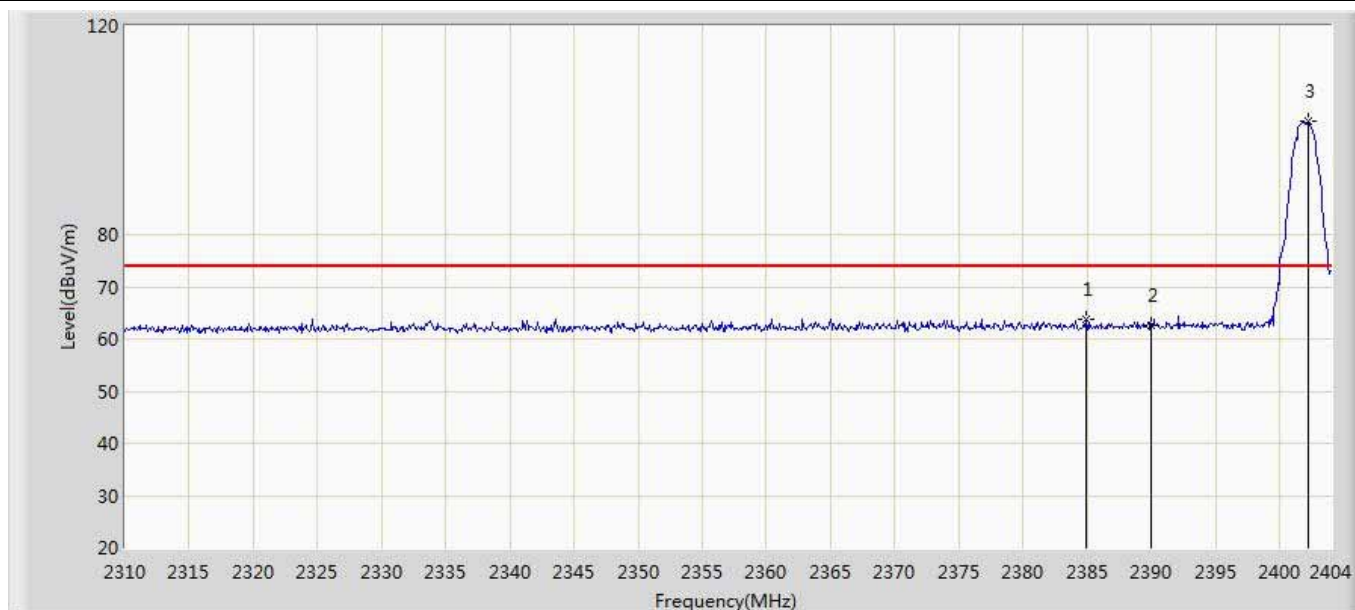

No	Mark	Frequency (MHz)	Measure Level (dBuV/m)	Reading Level (dBuV)	Over Limit (dB)	Limit (dBuV/m)	Factor (dB)	Type
1		2384.918	63.812	30.722	-10.188	74.000	33.090	PK
2		2390.000	62.743	29.632	-11.257	74.000	33.111	PK
3	*	2402.214	101.619	68.458	N/A	N/A	33.162	PK

Note: Measure Level (dBμV/m) = Reading Level (dBμV) + Factor (dB)

Factor (dB) = Cable Loss (dB) + Antenna Factor (dB/m).



Site: AC102	Time: 2017/02/28 - 18:47
Limit: FCC_Part15.209_RE(3m)	Margin: 0
Probe: N/A	Polarity: Horizontal
EUT: SIP-T54S	Power: AC 120V/60Hz
Note: Mode 3: Transmit 3DH5 at 2402MHz	

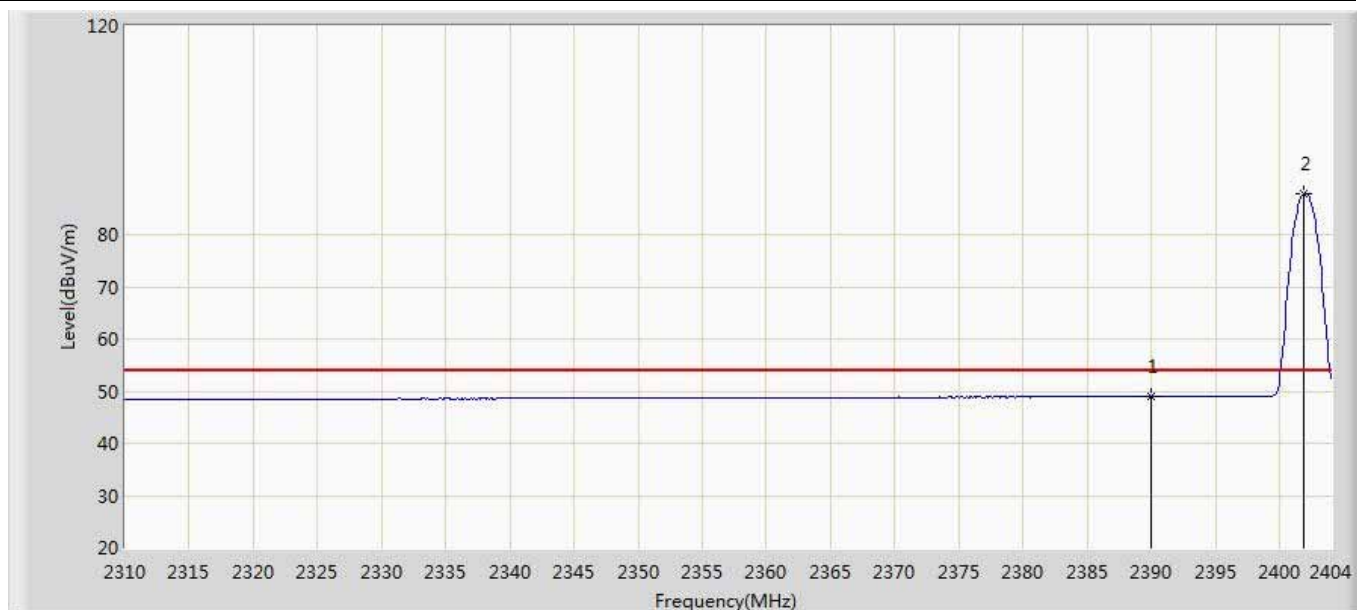

No	Mark	Frequency (MHz)	Measure Level (dBuV/m)	Reading Level (dBuV)	Over Limit (dB)	Limit (dBuV/m)	Factor (dB)	Type
1		2390.000	48.977	15.866	-5.023	54.000	33.111	AV
2	*	2401.932	87.958	54.798	N/A	N/A	33.160	AV

Note: Measure Level (dBμV/m) = Reading Level (dBμV) + Factor (dB)

Factor (dB) = Cable Loss (dB) + Antenna Factor (dB/m).



Site: AC102	Time: 2017/02/28 - 18:48
Limit: FCC_Part15.209_RE(3m)	Margin: 0
Probe: N/A	Polarity: Vertical
EUT: SIP-T54S	Power: AC 120V/60Hz
Note: Mode 3: Transmit 3DH5 at 2402MHz	

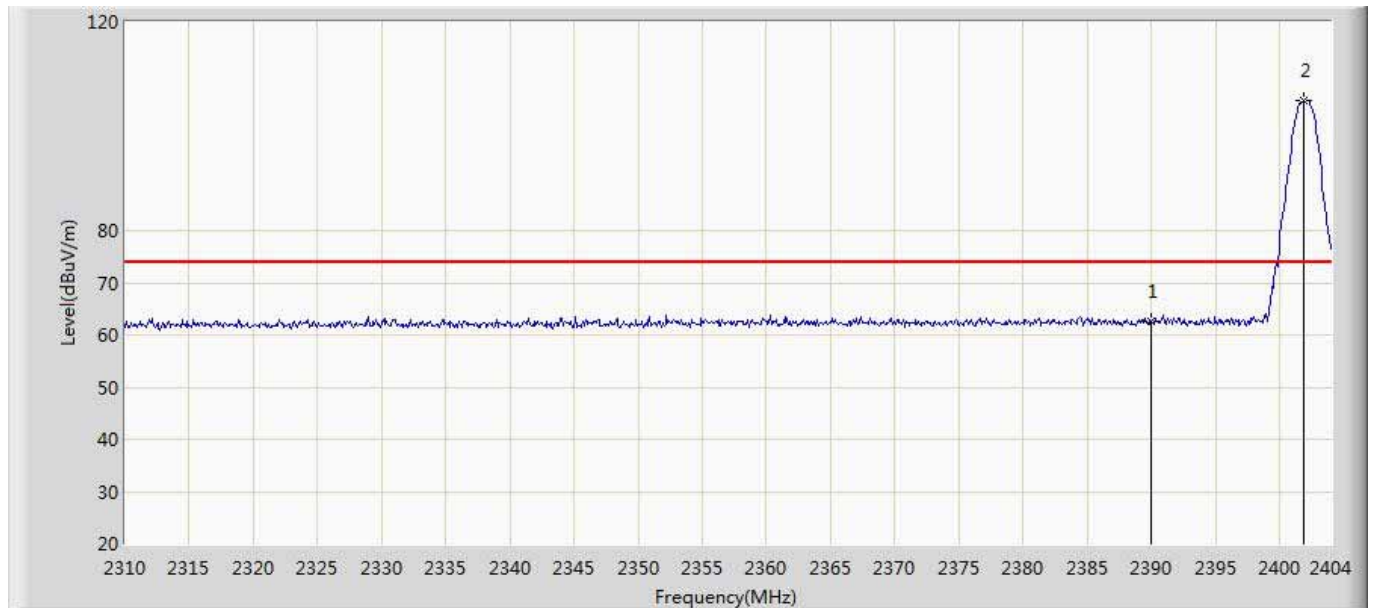

No	Mark	Frequency (MHz)	Measure Level (dBuV/m)	Reading Level (dBuV)	Over Limit (dB)	Limit (dBuV/m)	Factor (dB)	Type
1		2390.000	62.709	29.598	-11.291	74.000	33.111	PK
2	*	2401.932	105.068	71.908	N/A	N/A	33.160	PK

Note: Measure Level (dBμV/m) = Reading Level (dBμV) + Factor (dB)

Factor (dB) = Cable Loss (dB) + Antenna Factor (dB/m).



Site: AC102	Time: 2017/02/28 - 18:50
Limit: FCC_Part15.209_RE(3m)	Margin: 0
Probe: N/A	Polarity: Vertical
EUT: SIP-T54S	Power: AC 120V/60Hz
Note: Mode 3: Transmit 3DH5 at 2402MHz	

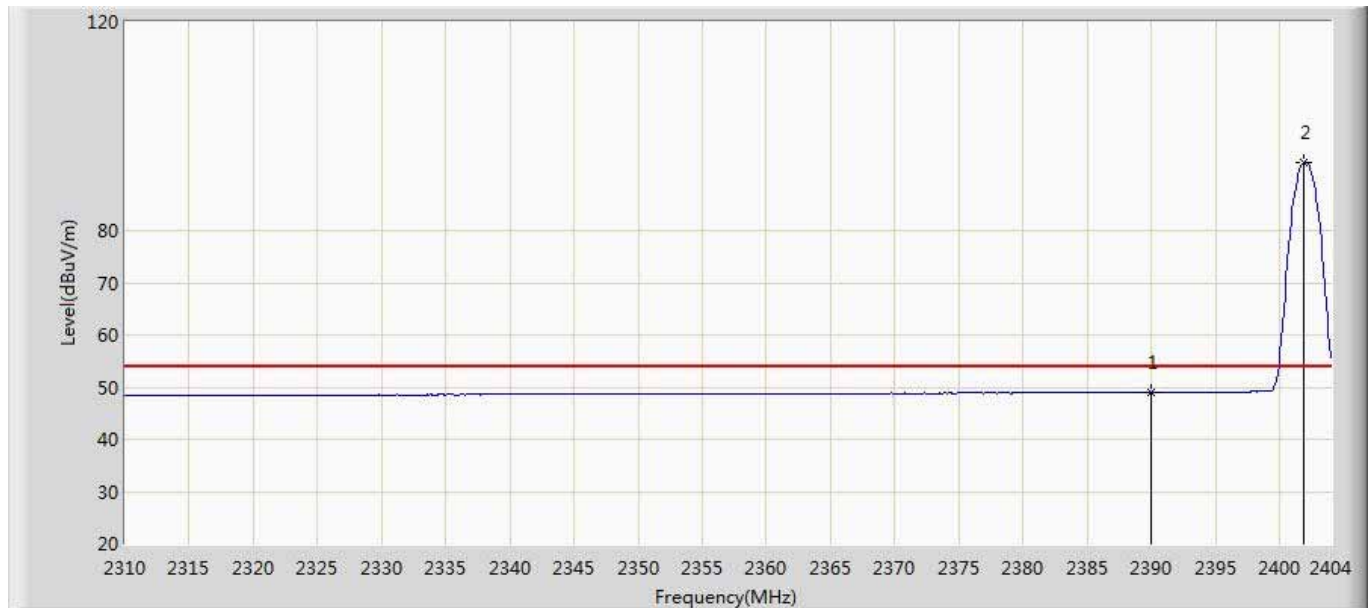

No	Mark	Frequency (MHz)	Measure Level (dBuV/m)	Reading Level (dBuV)	Over Limit (dB)	Limit (dBuV/m)	Factor (dB)	Type
1		2390.000	48.984	15.873	-5.016	54.000	33.111	AV
2	*	2401.838	92.975	59.815	N/A	N/A	33.160	AV

Note: Measure Level (dBμV/m) = Reading Level (dBμV) + Factor (dB)

Factor (dB) = Cable Loss (dB) + Antenna Factor (dB/m).



Site: AC102	Time: 2017/02/28 - 18:51
Limit: FCC_Part15.209_RE(3m)	Margin: 0
Probe: N/A	Polarity: Horizontal
EUT: SIP-T54S	Power: AC 120V/60Hz
Note: Mode 3: Transmit 3DH5 at 2480MHz	

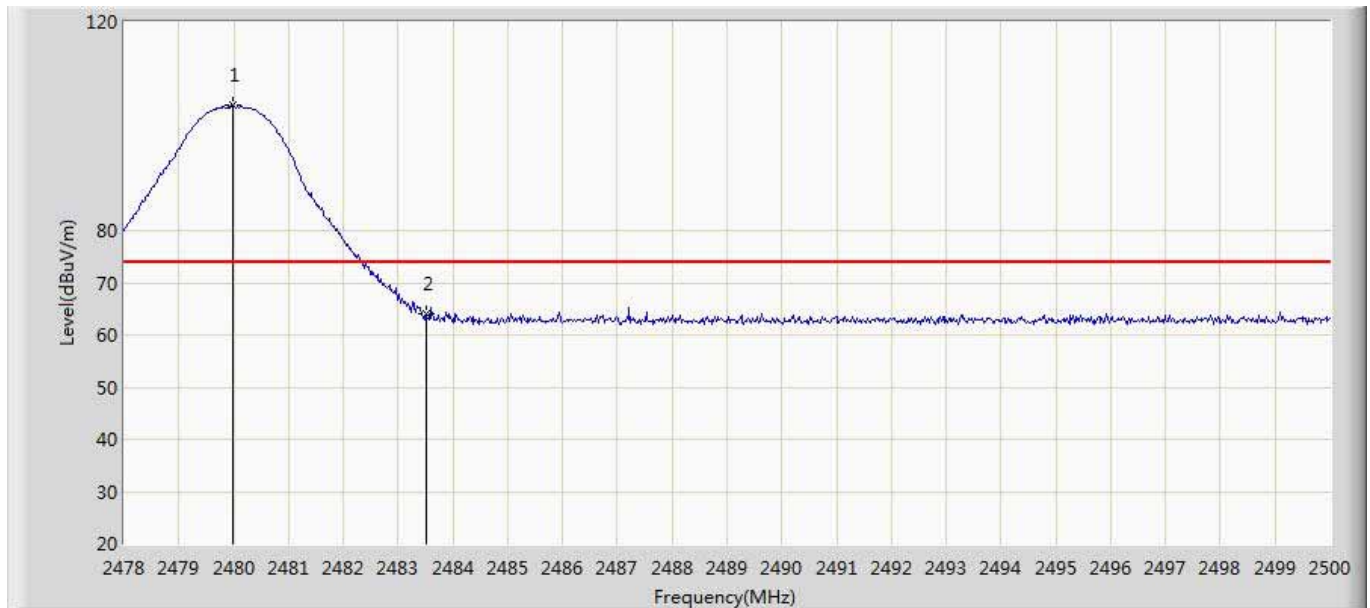

No	Mark	Frequency (MHz)	Measure Level (dBuV/m)	Reading Level (dBuV)	Over Limit (dB)	Limit (dBuV/m)	Factor (dB)	Type
1	*	2479.980	104.144	70.666	N/A	N/A	33.478	PK
2		2483.500	63.980	30.488	-10.020	74.000	33.493	PK

Note: Measure Level (dBμV/m) = Reading Level (dBμV) + Factor (dB)

Factor (dB) = Cable Loss (dB) + Antenna Factor (dB/m).



Site: AC102	Time: 2017/02/28 - 18:55
Limit: FCC_Part15.209_RE(3m)	Margin: 0
Probe: N/A	Polarity: Horizontal
EUT: SIP-T54S	Power: AC 120V/60Hz
Note: Mode 3: Transmit 3DH5 at 2480MHz	

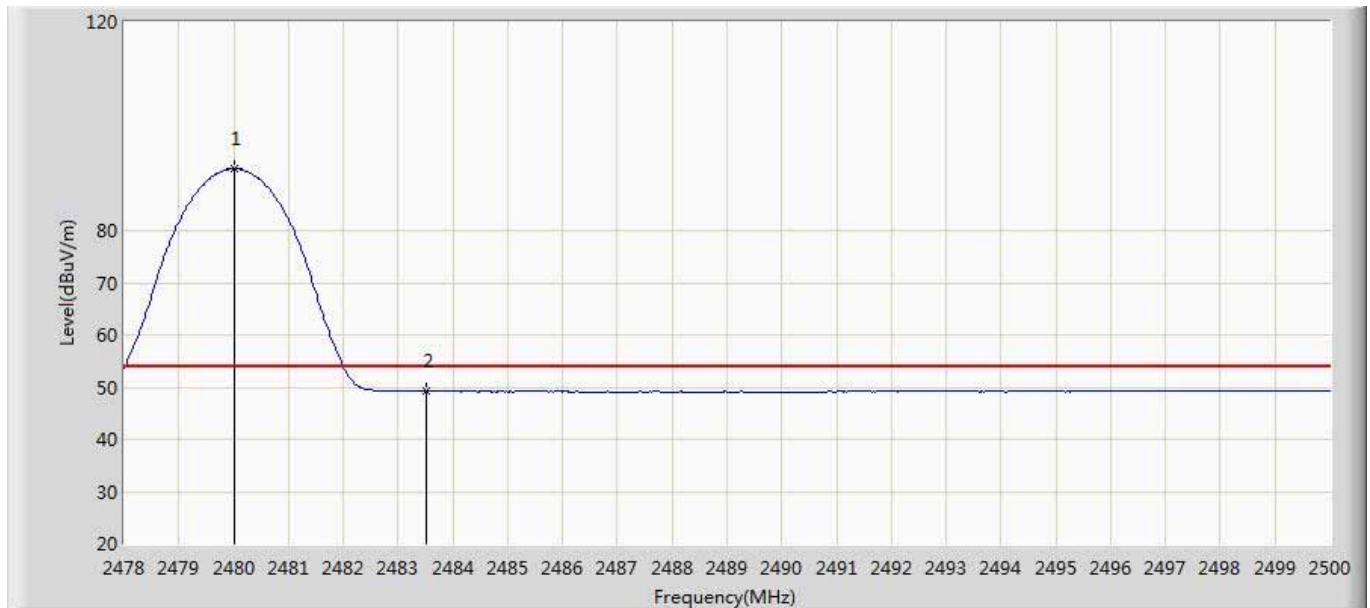

No	Mark	Frequency (MHz)	Measure Level (dBuV/m)	Reading Level (dBuV)	Over Limit (dB)	Limit (dBuV/m)	Factor (dB)	Type
1	*	2480.024	91.808	58.329	N/A	N/A	33.479	AV
2		2483.500	49.193	15.701	-4.807	54.000	33.493	AV

Note: Measure Level (dBμV/m) = Reading Level (dBμV) + Factor (dB)

Factor (dB) = Cable Loss (dB) + Antenna Factor (dB/m).



Site: AC102	Time: 2017/02/28 - 18:56
Limit: FCC_Part15.209_RE(3m)	Margin: 0
Probe: N/A	Polarity: Vertical
EUT: SIP-T54S	Power: AC 120V/60Hz
Note: Mode 3: Transmit 3DH5 at 2480MHz	

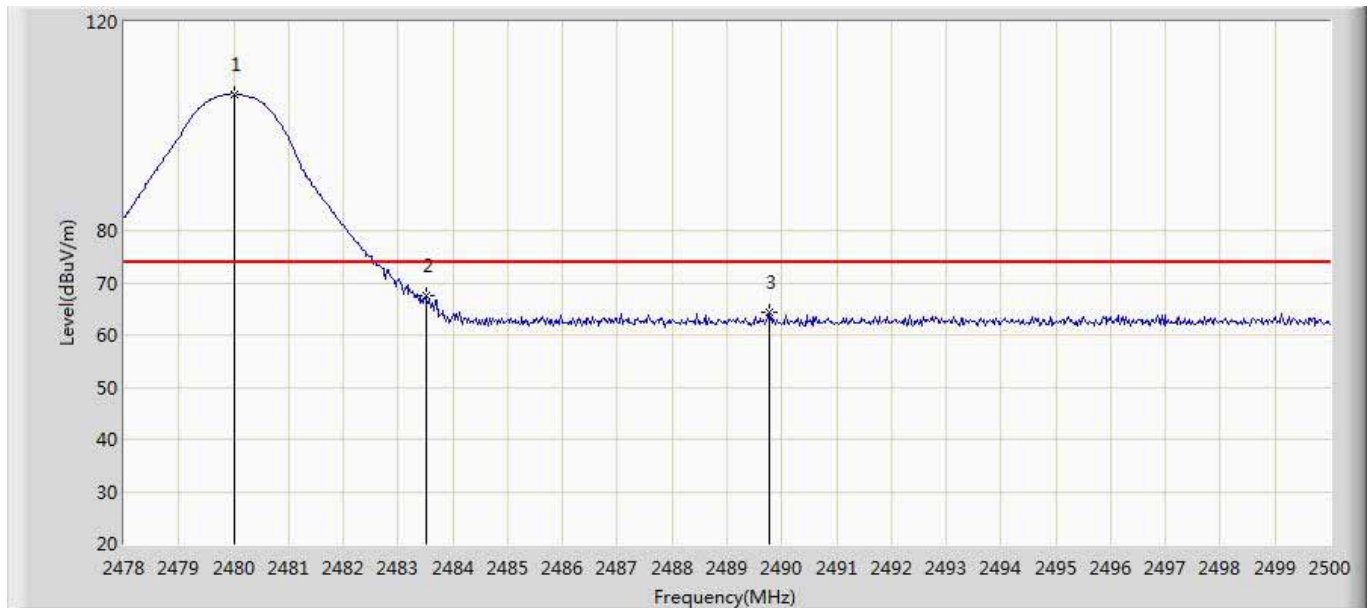

No	Mark	Frequency (MHz)	Measure Level (dBuV/m)	Reading Level (dBuV)	Over Limit (dB)	Limit (dBuV/m)	Factor (dB)	Type
1	*	2480.024	106.190	72.711	N/A	N/A	33.479	PK
2		2483.500	67.539	34.047	-6.461	74.000	33.493	PK
3		2489.770	64.291	30.773	-9.709	74.000	33.518	PK

Note: Measure Level (dBμV/m) = Reading Level (dBμV) + Factor (dB)

Factor (dB) = Cable Loss (dB) + Antenna Factor (dB/m).



Site: AC102	Time: 2017/02/28 - 18:57
Limit: FCC_Part15.209_RE(3m)	Margin: 0
Probe: N/A	Polarity: Vertical
EUT: SIP-T54S	Power: AC 120V/60Hz
Note: Mode 3: Transmit 3DH5 at 2480MHz	

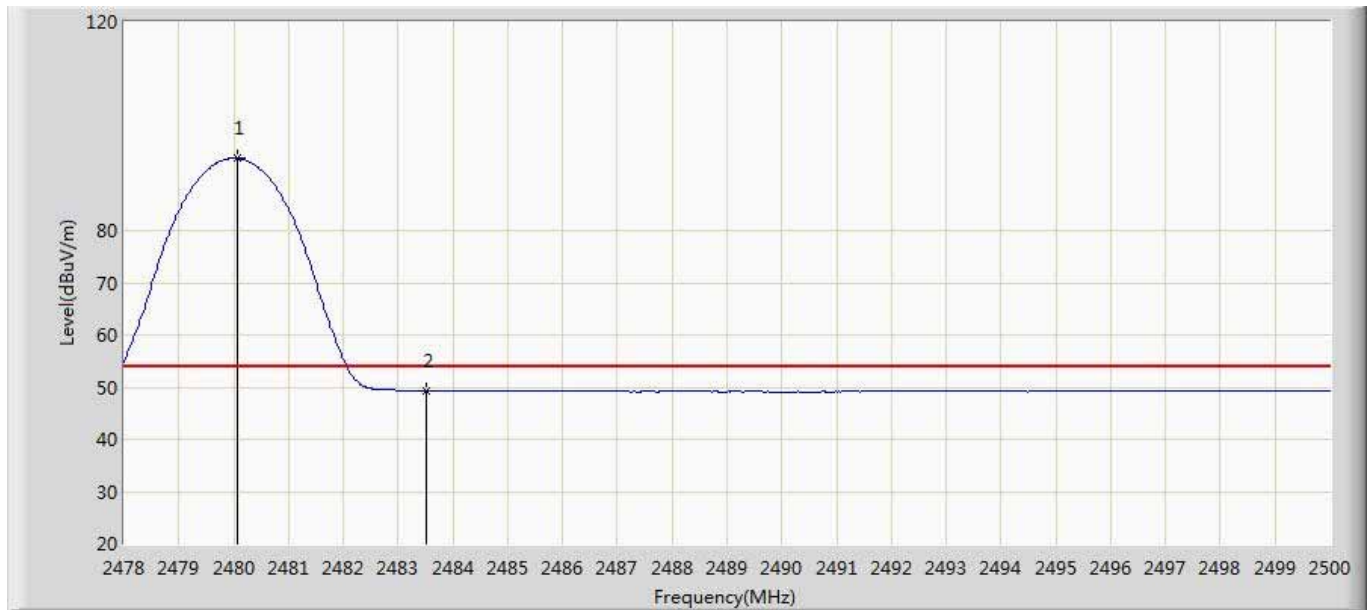

No	Mark	Frequency (MHz)	Measure Level (dBuV/m)	Reading Level (dBuV)	Over Limit (dB)	Limit (dBuV/m)	Factor (dB)	Type
1	*	2480.068	93.836	60.357	N/A	N/A	33.479	AV
2		2483.500	49.368	15.876	-4.632	54.000	33.493	AV

Note: Measure Level (dBμV/m) = Reading Level (dBμV) + Factor (dB)

Factor (dB) = Cable Loss (dB) + Antenna Factor (dB/m).

The End