



FCC PART 15, SUBPART B, CLASS B

TEST REPORT

For

YEALINK (XIAMEN) NETWORK

TECHNOLOGY CO., LTD.

309, 3th Floor, No.16, Yun Ding North Road, Huli District, Xiamen City, Fujian China

Model: SIP-T46S, SIP-T46G
FCC ID: T2C-T46S

Report Type Original Report	Product Type: IP Phone
<p>Test Engineer : <u>Kevin Kao</u> <i>Kevin Kao</i></p> <p>Report Number : <u>RTWS160627001-00</u></p> <p>Report Date : <u>2016-07-11</u></p> <p>Reviewed By: <u>Jerry Chang</u> <i>Jerry Chang</i></p> <p>Prepared By: Bay Area Compliance Laboratories Corp.(Taiwan) 70, Lane 169, Sec. 2, Datong Road, Xizhi Dist., New Taipei City 22183, Taiwan, R.O.C. Tel: +886 (2)2647 6898 Fax: +886 (2) 2647 6895 www.bacl.com.tw</p>	

Note: This test report is prepared for the customer shown above and for the device described herein. It may not be duplicated or used in part without prior written consent from Bay Area Compliance Laboratories Corp. (Taiwan)

Revision History

Revision	Issue Date	Description
1.0	2016.07.11	Original Report

TABLE OF CONTENTS

1. GENERAL INFORMATION	4
1.1 Product Description for Equipment under Test (EUT)	4
1.2 Objective	4
1.3 Related Submittal(s)/Grant(s)	4
2. SYSTEM TEST CONFIGURATION	5
2.1 Description of Test Configuration	5
2.2 Test Mode	5
2.3 EUT Exercise Software	5
2.4 Special Accessories	5
2.5 Equipment Modifications	5
2.6 Description of operation:	5
2.7 Support Equipment List and Details	6
2.8 External Cable List and Details	6
2.9 Block Diagram of Test Setup	7
3. SUMMARY OF TEST RESULTS	8
4. FCC §15.107 – AC LINE CONDUCTED EMISSIONS	9
4.1 Applicable Standard	9
4.2 Measurement Uncertainty	9
4.3 EUT Setup	9
4.4 EMI Test Receiver Setup	10
4.5 Test Procedure	10
4.6 Test Equipment List and Details	10
4.7 Factor & Over Limit Calculation	11
4.8 Test Results Summary	11
4.9 Test Data	11
5. FCC §15.109 – RADIATED EMISSION	18
5.1 Applicable Standard	18
5.2 Measurement Uncertainty	18
5.3 EUT Setup	18
5.4 EMI Test Receiver Setup	19
5.5 Test Procedure	19
5.6 Test Equipment List and Details	20
5.7 Correct Factor & Margin Calculation	20
5.8 Test Results Summary	21
5.9 Test Data	21

1. GENERAL INFORMATION

1.1 Product Description for Equipment under Test (EUT)

Applicant:	YEALINK (XIAMEN) NETWORK TECHNOLOGY CO., LTD. 309, 3th Floor, No.16, Yun Ding North Road, Huli District, Xiamen City, Fujian China
Manufacturer:	YEALINK (XIAMEN) NETWORK TECHNOLOGY CO., LTD. 309, 3th Floor, No.16, Yun Ding North Road, Huli District, Xiamen City, Fujian China
Product:	IP Phone
Model:	SIP-T46S, SIP-T46G
Trade Name:	Yealink
Operating Frequency:	500MHz
Voltage Range:	I/P: 100-240Vac, 50/60Hz, 350mA O/P: 5V, 2A
Date of Test:	June 27, 2016 ~July 11, 2016

**All measurement and test data in this report was gathered from production sample serial number: 16062701
(Assigned by BACL, Taiwan). The EUT supplied by the applicant was received on 2016-06-27.*

Designation Number: TW1101

Adapter 1 Information:

Model: YLPS052000B-US

I/P: 100-240Vac, 50/60Hz, 350mA

O/P: 5V, 2A

Adapter 2 Information:

Model: OH-1015A0502000U2-UL

I/P: 100-240Vac, 50/60Hz, 350mA

O/P: 5V, 2A

Model Difference: The major electrical and mechanical constructions of series models are identical to the basic model, except different model name.

1.2 Objective

This test report is prepared on behalf of *YEALINK (XIAMEN) NETWORK TECHNOLOGY CO., LTD.* in accordance with Part 2, Subpart J, Part 15, Subparts A and B of the Federal Communication Commission's rules.

The tests were performed in order to determine the compliance of the EUT with FCC Part 15 B.

1.3 Related Submittal(s)/Grant(s)

No related submittal(s).

2. SYSTEM TEST CONFIGURATION

2.1 Description of Test Configuration

The system was configured for testing in testing mode which was provided by manufacturer.

2.2 Test Mode

Pretest Mode	Description
MODE 1	Normal operation(Adapter:YLPS052000B-US)
MODE 2	Normal operation(Adapter:OH-1015A0502000U2-UL)
MODE 3	Normal operation(PoE)

Final Test Mode	Description
MODE 1	Normal operation(Adapter:YLPS052000B-US)
MODE 2	Normal operation(Adapter:OH-1015A0502000U2-UL)

2.3 EUT Exercise Software

“myHwin” exercise software was used.

2.4 Special Accessories

No special accessory.

2.5 Equipment Modifications

No modification was made to the EUT.

2.6 Description of operation:

1. Turn on EUT and test equipment
2. NB use myHwin.exe that sends "H" to the Panel
3. Use "Brunin" Drive do for Read/Write work
4. Use "ping.exe for EUT to transmit and receive
5. Repeat steps 2-4

2.7 Support Equipment List and Details

No.	Description	Manufacturer	Model Number	BSMI	FCC ID	S/N
A	LOAD	N/A	N/A	N/A	N/A	N/A
B	NB	ASUS	X550J	R31018	DOC	F9N0CV2281 0937G
C	Mouse	DELL	MS111-P	R41108	DOC	N/A
D	USB Keyboard	DELL	SK-8120	R3A002	DOC	N/A
E	USB3.0 HDD	WD	My Passport Ultra	D33015	DOC	WX21A557K R62
F	PC	DELL	OptiPlex 790 SFF	R33002	DOC	H9WPSR1

2.8 External Cable List and Details

No.	Description	Shielded Type	Ferrite Core	Length
1	USB Cable	Non-Shielded	N/A	1 M
2	Power Cable	Non-Shielded	N/A	1.8M
3	RJ-45 Cable	Non-Shielded	N/A	1.5M
4	USB Cable	Non-Shielded	N/A	1.8M
5	USB Cable	Non-Shielded	N/A	1.8M
6	USB Cable	Shielded	N/A	0.5M
7	RJ-45 Cable	Non-Shielded	N/A	10M
8	RJ-9 Cable	Non-Shielded	N/A	1.5M
9	RJ-11 Cable	Non-Shielded	N/A	2.2M
10	Power Cable	Non-Shielded	N/A	3M

2.9 Block Diagram of Test Setup

Mode 1

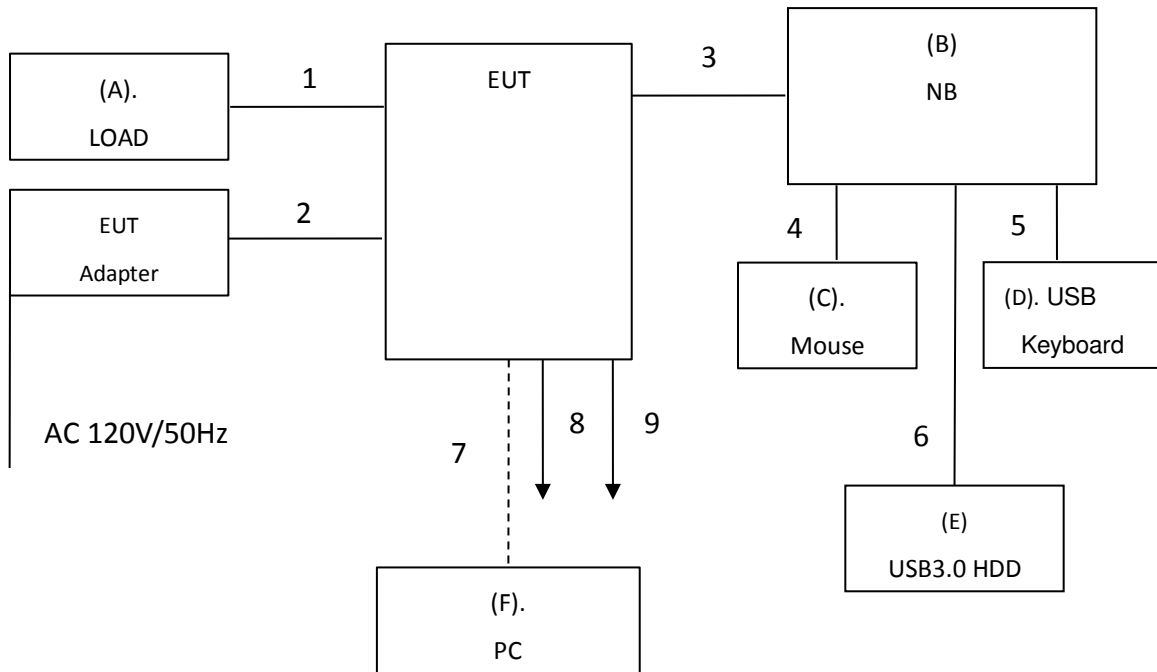

Mode 2

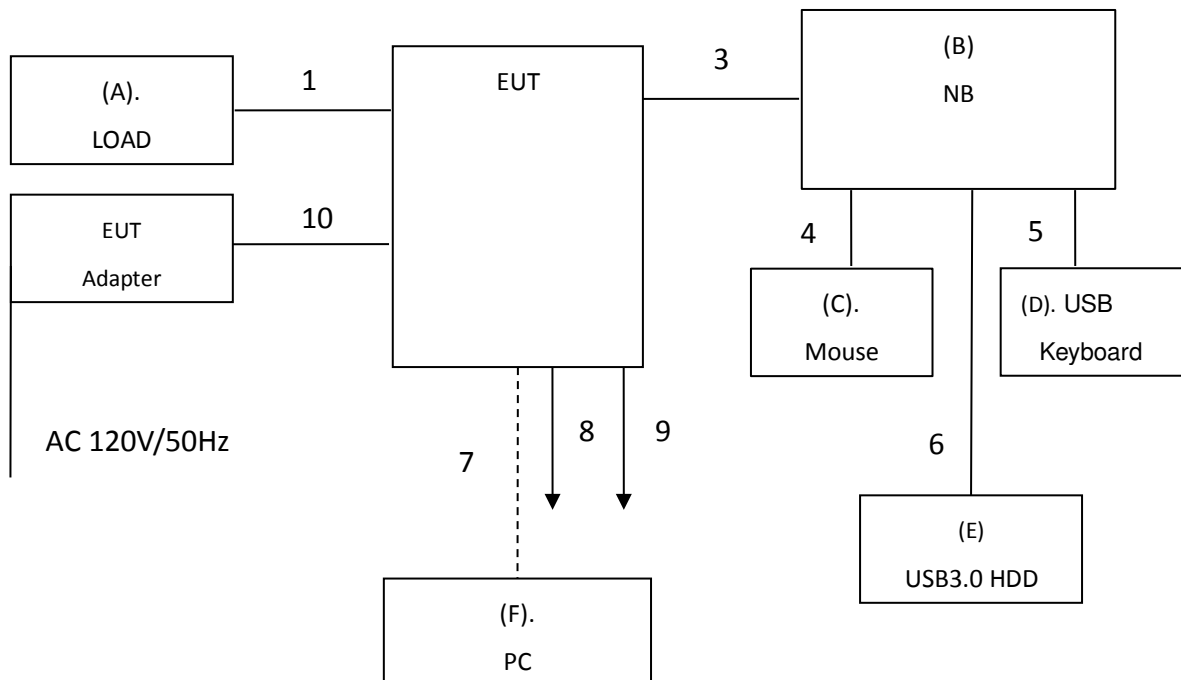

3. SUMMARY OF TEST RESULTS

FCC Rules	Description of Test	Results
§15.107	AC Line Conducted Emission	Compliance
§15.109	Radiated Emission	Compliance

4. FCC §15.107 – AC LINE CONDUCTED EMISSIONS

4.1 Applicable Standard

According to FCC §15.107

4.2 Measurement Uncertainty

Input quantities to be considered for conducted disturbance measurements maybe receiver reading, attenuation of the connection between LISN/ISN and receiver, LISN/ISN voltage division factor, LISN/ISN VDF frequency interpolation and receiver related input quantities, etc.

Based on CISPR 16-4-2:2011, the expended combined standard uncertainty of conducted disturbance test at Bay Area Compliance Laboratories Corp. (Taiwan) is shown as below. And the uncertainty will not be taken into consideration for the test data recorded in the report.

Port	Expanded Measurement uncertainty
AC Mains	2.71 dB (k=2, 95% level of confidence)
CAT 3	3.81 dB (k=2, 95% level of confidence)
CAT 5	4.24 dB (k=2, 95% level of confidence)
CAT 6	4.71 dB (k=2, 95% level of confidence)

4.3 EUT Setup

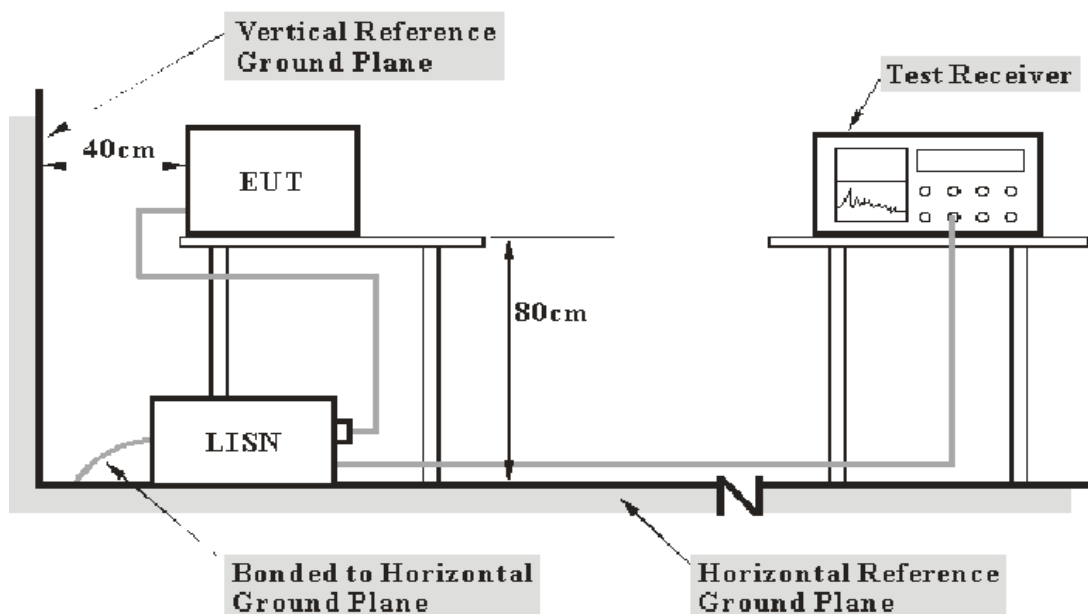

- Note:**
1. Support units were connected to second LISN.
 2. Both of LISNs (AMN) 80 cm from EUT and at the least 80 cm from other units and other metal planes support units.

The measurement procedure of EUT setup is according with per ANSI C63.4-2014. The related limit was specified in FCC Part 15.107 Class B.

The spacing between the peripherals is 10 cm.

4.4 EMI Test Receiver Setup

The EMI test receiver was set to investigate the spectrum from 150 kHz to 30 MHz.

During the conducted emission test, the EMI test receiver was set with the following configurations

Frequency Range	IF B/W
150 kHz – 30 MHz	9 kHz

4.5 Test Procedure

During the conducted emission test, the power cord was connected to the first LISN and the other relevant equipments were connected to the second LISN.

Maximizing procedure was performed on the six (6) highest emissions of the EUT.

All data was recorded in the Quasi-peak and average detection mode.

4.6 Test Equipment List and Details

Description	Manufacturer	Model	Serial Number	Calibration Date	Calibration Due Date
LISN	Rohde & Schwarz	ENV216	101248	2015/8/3	2016/8/2
LISN	EMCO	699837	75848	2015/7/8	2016/7/7
EMI Test Receiver	Rohde & Schwarz	ESCI	100540	2015/7/25	2016/7/24
Pulse Limiter	Rohde & Schwarz	ESH3Z2	TXZEM025	2015/8/28	2016/8/27
RF Cable	EMEC	EM-CB5D	001	2015/7/29	2016/7/28
Software	AUDIX	E3	V9.150826k	N.C.R	N.C.R

* **Statement of Traceability:** Bay Area Compliance Laboratories Corp. (Taiwan) attests that all calibrations have been performed in accordance to requirements that traceable to National Primary Standards and International System of Units (SI).

4.7 Factor & Over Limit Calculation

The factor is calculated by adding LISN/ISN VDF (Voltage Division Factor), Cable Loss and Transient Limiter Attenuation. The basic equation is as follows:

$$\text{Factor} = \text{LISN VDF} + \text{Cable Loss} + \text{Transient Limiter Attenuation}$$

The “**Over Limit**” column of the following data tables indicates the degree of compliance with the applicable limit. For example, an over limit of -7 dB means the emission is 7 dB below the limit. The equation for Over Limit calculation is as follows:

$$\text{Over Limit} = \text{Level} - \text{Limit Line}$$

4.8 Test Results Summary

According to the recorded data in following table, the EUT complied with the FCC Part 15.107. Refer to CISPR16-4-2:2011 and CISPR 16-4-1:2009, the measured level is in complies with the limit if

$$L_m + U_{(L_m)} \leq L_{\text{lim}} + U_{\text{cispr}}$$

In BAEL, $U_{(L_m)}$ is less than U_{cispr} , if L_m is less than L_{lim} , it implies that the EUT complies with the limit.

4.9 Test Data

Environmental Conditions

Temperature:	28.7 °C
Relative Humidity:	48 %
ATM Pressure:	101.0 kPa

The testing was performed by Kevin Kao on 2016-06-28.

Mode 1:
AC 120V/60 Hz, Line

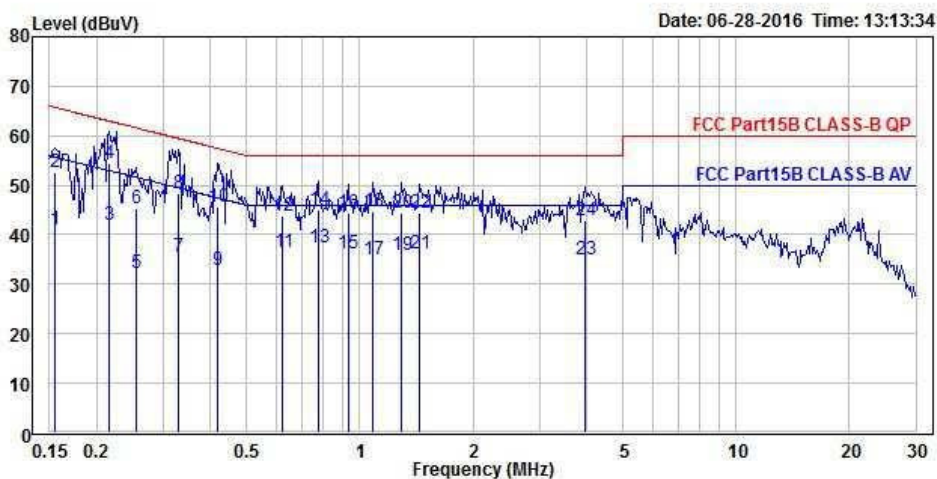

Condition: limit\FCC Part15B CLASS-B QP.csv Line
 EUT : IP Phone
 Model : SIP-T46S
 Note : 120V/60Hz,Adapter:YLPS52000B-US

	Freq	Level	Limit	Over	Read		
	MHz	dBuV	Line	Limit	Factor	Level	
	MHz	dBuV	dBuV	dB	dB	dBuV	
1	0.155	41.02	55.74	-14.72	19.57	21.45	Average
2	0.155	52.77	65.74	-12.97	19.57	33.20	QP
3	0.216	41.97	52.96	-10.99	19.56	22.41	Average
4	0.216	54.50	62.96	-8.46	19.56	34.94	QP
5	0.254	32.36	51.63	-19.27	19.56	12.80	Average
6	0.254	45.47	61.63	-16.16	19.56	25.91	QP
7	0.330	35.65	49.45	-13.80	19.55	16.10	Average
8	0.330	48.51	59.45	-10.94	19.55	28.96	QP
9	0.419	32.78	47.46	-14.68	19.55	13.23	Average
10	0.419	45.63	57.46	-11.83	19.55	26.08	QP
11	0.624	36.52	46.00	-9.48	19.56	16.96	Average
12	0.624	43.93	56.00	-12.07	19.56	24.37	QP
13	0.774	37.50	46.00	-8.50	19.57	17.93	Average
14	0.774	44.97	56.00	-11.03	19.57	25.40	QP
15	0.930	36.35	46.00	-9.65	19.58	16.77	Average
16	0.930	44.50	56.00	-11.50	19.58	24.92	QP
17	1.082	35.00	46.00	-11.00	19.58	15.42	Average



	Freq	Level	Limit	Over		Read	Remark
	MHz	dBuV	dBuV	dB	dB	dBuV	
18	1.082	44.76	56.00	-11.24	19.58	25.18	QP
19	1.289	35.85	46.00	-10.15	19.59	16.26	Average
20	1.289	44.53	56.00	-11.47	19.59	24.94	QP
21	1.441	36.06	46.00	-9.94	19.62	16.44	Average
22	1.441	44.42	56.00	-11.58	19.62	24.80	QP
23	3.965	34.93	46.00	-11.07	19.68	15.25	Average
24	3.965	42.75	56.00	-13.25	19.68	23.07	QP

AC 120V/60 Hz, Neutral

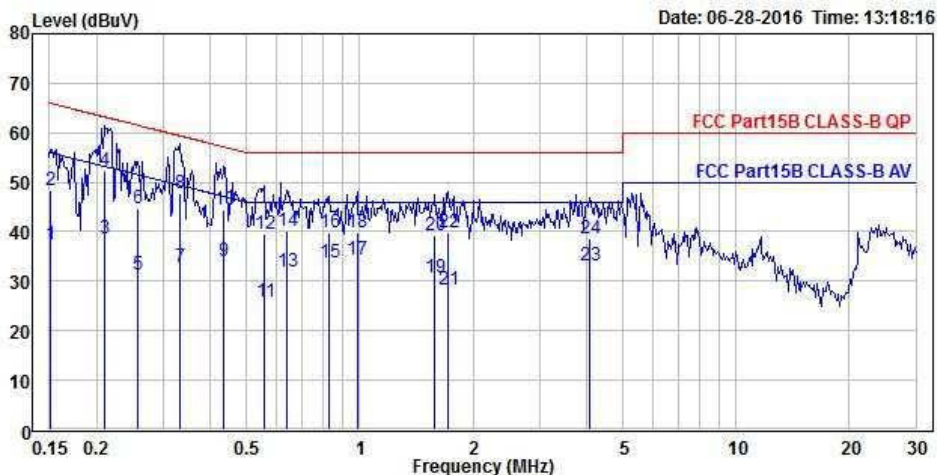

Condition: limit\FCC Part15B CLASS-B QP.csv Neutral
 EUT : IP Phone
 Model : SIP-T46S
 Note : 120V/60Hz,Adapter:YLPS5200B-US

	Freq	Level	Limit	Over	Read	Remark
	MHz	dBuV	Line	Limit	Factor	Level
			dBuV	dB	dB	dBuV
1	0.151	37.52	55.93	-18.41	19.58	17.94 Average
2	0.151	48.40	65.93	-17.53	19.58	28.82 QP
3	0.210	38.72	53.22	-14.50	19.57	19.15 Average
4	0.210	52.47	63.22	-10.75	19.57	32.90 QP
5	0.258	31.48	51.50	-20.02	19.57	11.91 Average
6	0.258	44.83	61.50	-16.67	19.57	25.26 QP
7	0.333	32.99	49.38	-16.39	19.56	13.43 Average
8	0.333	47.79	59.38	-11.59	19.56	28.23 QP
9	0.436	34.06	47.13	-13.07	19.56	14.50 Average
10	0.436	44.55	57.13	-12.58	19.56	24.99 QP
11	0.559	25.73	46.00	-20.27	19.56	6.17 Average
12	0.559	39.47	56.00	-16.53	19.56	19.91 QP
13	0.640	31.91	46.00	-14.09	19.57	12.34 Average
14	0.640	40.01	56.00	-15.99	19.57	20.44 QP
15	0.832	33.63	46.00	-12.37	19.57	14.06 Average
16	0.832	39.83	56.00	-16.17	19.57	20.26 QP
17	0.983	34.39	46.00	-11.61	19.58	14.81 Average



	Freq	Level	Limit	Over	Read	Remark
	MHz	dBuV	Line	Limit	Factor	Level
			dBuV	dB	dB	dBuV
18	0.983	39.82	56.00	-16.18	19.58	20.24 QP
19	1.586	30.70	46.00	-15.30	19.62	11.08 Average
20	1.586	39.15	56.00	-16.85	19.62	19.53 QP
21	1.718	28.37	46.00	-17.63	19.62	8.75 Average
22	1.718	39.77	56.00	-16.23	19.62	20.15 QP
23	4.093	33.18	46.00	-12.82	19.68	13.50 Average
24	4.093	38.69	56.00	-17.31	19.68	19.01 QP

Mode 2:
AC 120V/60 Hz, Line

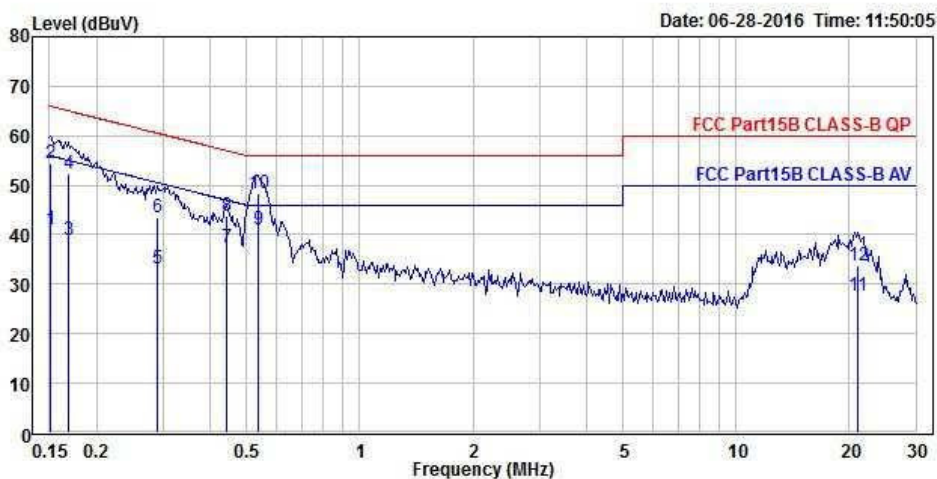

Condition: limit\FCC Part15B CLASS-B QP.csv Line
 EUT : IP Phone
 Model : SIP-T46S
 Note : 120V/60Hz,Adapter:OH-1015A502000U-UL

	Freq	Level	Limit	Over	Read	
	MHz	dBuV	Line	Limit	Factor	Level
	MHz	dBuV	dBuV	dB	dB	dBuV
1	0.151	40.96	55.93	-14.97	19.57	21.39 Average
2	0.151	54.53	65.93	-11.40	19.57	34.96 QP
3	0.169	38.79	55.01	-16.22	19.57	19.22 Average
4	0.169	52.24	65.01	-12.77	19.57	32.67 QP
5	0.291	33.22	50.51	-17.29	19.55	13.67 Average
6	0.291	43.50	60.51	-17.01	19.55	23.95 QP
7	0.443	37.49	47.00	-9.51	19.55	17.94 Average
8	0.443	43.88	57.00	-13.12	19.55	24.33 QP
9	0.537	40.97	46.00	-5.03	19.55	21.42 Average
10	0.537	48.36	56.00	-7.64	19.55	28.81 QP
11	20.961	27.79	50.00	-22.21	19.87	7.92 Average
12	20.961	33.84	60.00	-26.16	19.87	13.97 QP

AC 120V/60 Hz, Neutral

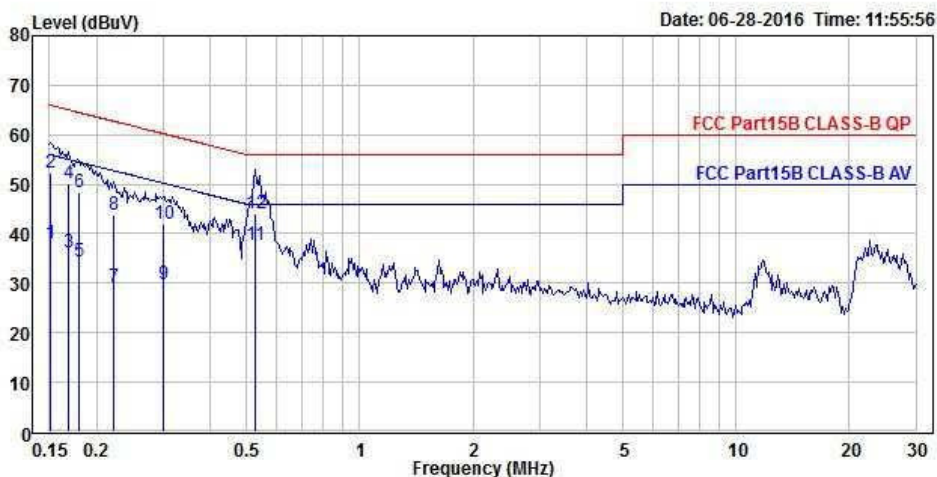

Condition: limit\FCC Part15B CLASS-B QP.csv Neutral

EUT : IP Phone

Model : SIP-T46S

Note : 120V/60Hz, Adapter:OH-1015A502000U-UL

	Freq	Level	Limit	Over	Read	Remark
	MHz	dBuV	Line	Limit	Factor	Level
	MHz	dBuV	dBuV	dB	dB	dBuV
1	0.151	37.88	55.93	-18.05	19.58	18.30 Average
2	0.151	52.36	65.93	-13.57	19.58	32.78 QP
3	0.168	36.26	55.07	-18.81	19.58	16.68 Average
4	0.168	50.09	65.07	-14.98	19.58	30.51 QP
5	0.180	34.27	54.48	-20.21	19.57	14.70 Average
6	0.180	48.37	64.48	-16.11	19.57	28.80 QP
7	0.222	29.29	52.76	-23.47	19.57	9.72 Average
8	0.222	43.84	62.76	-18.92	19.57	24.27 QP
9	0.300	29.74	50.24	-20.50	19.56	10.18 Average
10	0.300	41.84	60.24	-18.40	19.56	22.28 QP
11	0.528	37.66	46.00	-8.34	19.56	18.10 Average
12	0.528	44.17	56.00	-11.83	19.56	24.61 QP

5. FCC §15.109 – RADIATED EMISSION

5.1 Applicable Standard

FCC §15.109

5.2 Measurement Uncertainty

All measurements involve certain levels of uncertainties, especially in field of EMC. The factors contributing to uncertainties are spectrum analyzer, cable loss, antenna factor calibration, antenna directivity, antenna factor variation with height, antenna phase center variation, antenna factor frequency interpolation, measurement distance variation, site imperfections, mismatch (average), and system repeatability.

Based on CISPR 16-4-2:2011, the expended combined standard uncertainty of radiation emissions at Bay Area Compliance Laboratories Corp. (Taiwan) is shown in below table. And the uncertainty will not be taken into consideration for the test data recorded in the report

Frequency	Measurement uncertainty
9 kHz~30MHz	4.11 dB (k=2, 95% level of confidence)
30MHz~200MHz	4.21 dB (k=2, 95% level of confidence)
200MHz~1GHz	4.41 dB (k=2, 95% level of confidence)
1 GHz~6 GHz	4.51 dB (k=2, 95% level of confidence)
Above 6 GHz	4.88 dB (k=2, 95% level of confidence)

5.3 EUT Setup

Below 1GHz:

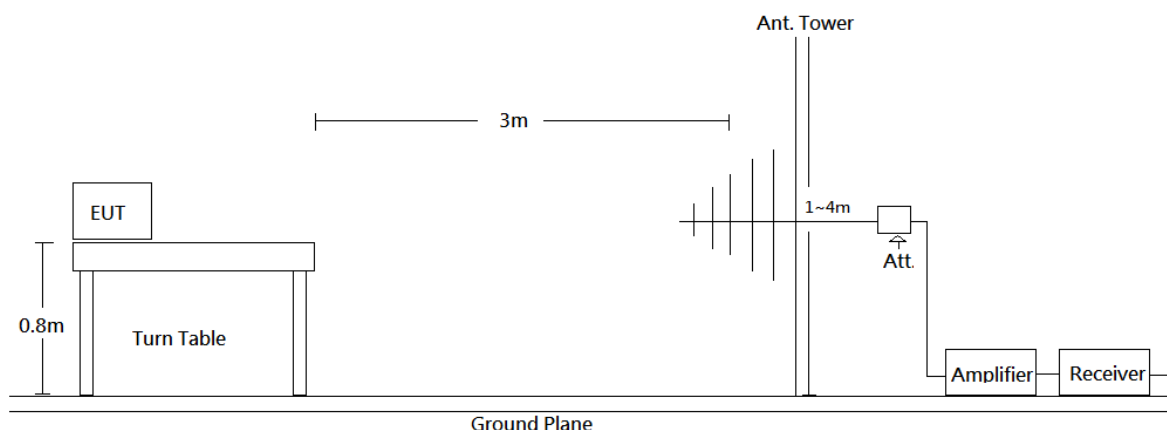

Above 1GHz:

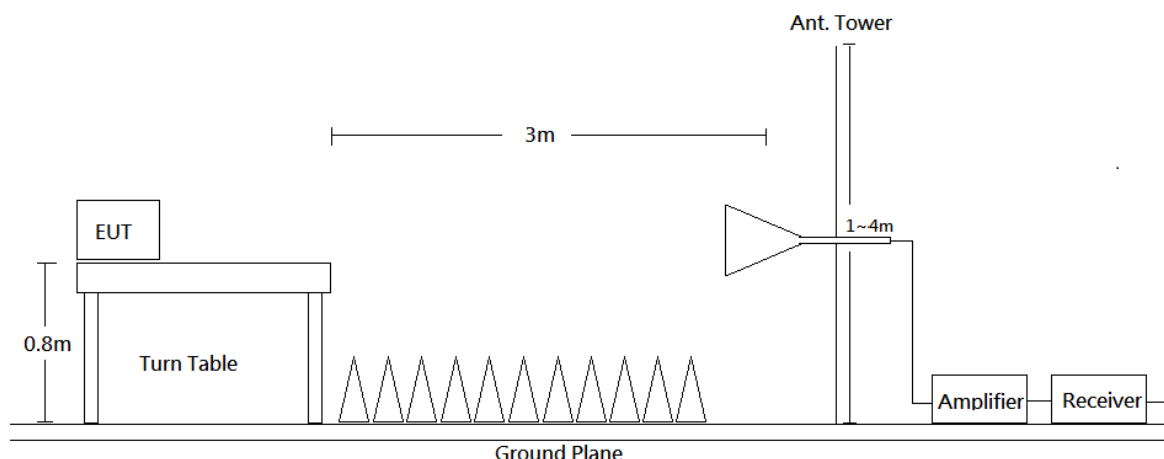

The radiated emission tests were performed in the 3 meters chamber test site, using the setup accordance with the ANSI C63.4-2014. The specification used was the FCC Part 15.109 Class B limits. The external I/O cables were draped along the test table and formed a bundle 30 to 40 cm long in the middle.

The spacing between the peripherals was 10 cm.

The power cord was connected to a 120 VAC/60 Hz power source.

5.4 EMI Test Receiver Setup

The system was investigated from 30 MHz to 40 GHz.

During the radiated emission test, the EMI test receiver was set with the following configurations

Frequency Range	RBW	RBW Video B/W	IF B/W	Detector
30MHz – 1000 MHz	100 kHz	300 kHz	120 kHz	QP
Above 1 GHz	1MHz	3MHz	/	PK
	1MHz	10 Hz	/	Ave.

5.5 Test Procedure

Maximizing procedure was performed on the highest emissions to ensure that the EUT complied with all installation combinations.

All data was recorded in the Quasi-peak detector mode from 30 MHz to 1 GHz and PK and average detector modes for frequencies above 1 GHz.

5.6 Test Equipment List and Details

Description	Manufacturer	Model	Serial Number	Calibration Date	Calibration Interval
Broadband Antenna	Sunol Sciences	JB6	A050115	2015/12/8	2016/12/7
EMEC Attenuator	EMEC	UNAT-6+	15542	2015/12/8	2016/12/7
Amplifier	Sonoma	310N	130601	2016/7/3	2017/7/2
Horn Antenna	EMCO	3115	9311-4158	2016/5/10	2017/5/9
Preamplifier	EMEC	EM01G18G	060657	2015/12/21	2016/12/20
Loop Antenna	ETS-Lindgren	6502	00035796	2015/7/23	2016/7/22
EMI Test Receiver	Rohde & Schwarz	ESR7	101419	2015/11/4	2016/11/3
Mircoflex Cable	UTIFLEX	UFB311A-Q-1440-300300	220490-006	2015/11/4	2016/11/3
Mircoflex Cable	UTIFLEX	UFB197C-1-2362-70U-70U	225757-001	2016/7/3	2017/7/2
Mircoflex Cable	UTIFLEX	UFA210A-1-3149-300300	MFR64639 226389-001	2015/12/2	2016/12/1
Mircoflex Cable	ROSNAL	K1K50-UP0264-K1K50-80CM	160309-2	2016/3/24	2017/3/23
Turn Table	Champro	TT-2000	060772-T	N.C.R	N.C.R
Antenna Tower	Champro	AM-BS-4500-B	060772-A	N.C.R	N.C.R
Controller	Champro	EM1000	060772	N.C.R	N.C.R
software	Rohde & Schwarz	EMC32	V9.10.00	N.C.R	N.C.R

* **Statement of Traceability:** Bay Area Compliance Laboratories Corp. (Taiwan) attests that all calibrations have been performed in accordance to requirements that traceable to National Primary Standards and International System of Units (SI).

5.7 Correct Factor & Margin Calculation

The Correct Factor is calculated by adding the Antenna Factor and Cable Loss, and subtracting the Amplifier Gain from the Meter Reading. The basic equation is as follows:

$$\text{Correct Factor} = \text{Antenna Factor} + \text{Cable Loss} - \text{Amplifier Gain} + \text{Attenuator}$$

The “Margin” column of the following data tables indicates the degree of compliance with the applicable limit. For example, a margin of 7 dB means the emission is 7 dB below the limit. The equation for margin calculation is as follows:

$$\text{Margin} = \text{Limit} - \text{Result}$$

5.8 Test Results Summary

According to the data in the following table, the EUT complied with the FCC §15.109 Class B. Refer to CISPR16-4-2:2011 and CISPR 16-4-1:2009, the measured level complies with the limit if

$$L_m + U_{(L_m)} \leq L_{lim} + U_{cispr}$$

In BAACL, $U_{(L_m)}$ is less than U_{cispr} , if L_m is less than L_{lim} , it implies that the EUT complies with the limit.

5.9 Test Data

Environmental Conditions

Temperature:	22.6°C
Relative Humidity:	58 %
ATM Pressure:	101.0 kPa

The testing was performed by Mike Cai on 2016-07-06.

Mode 1: Below 1GHz

Horizontal

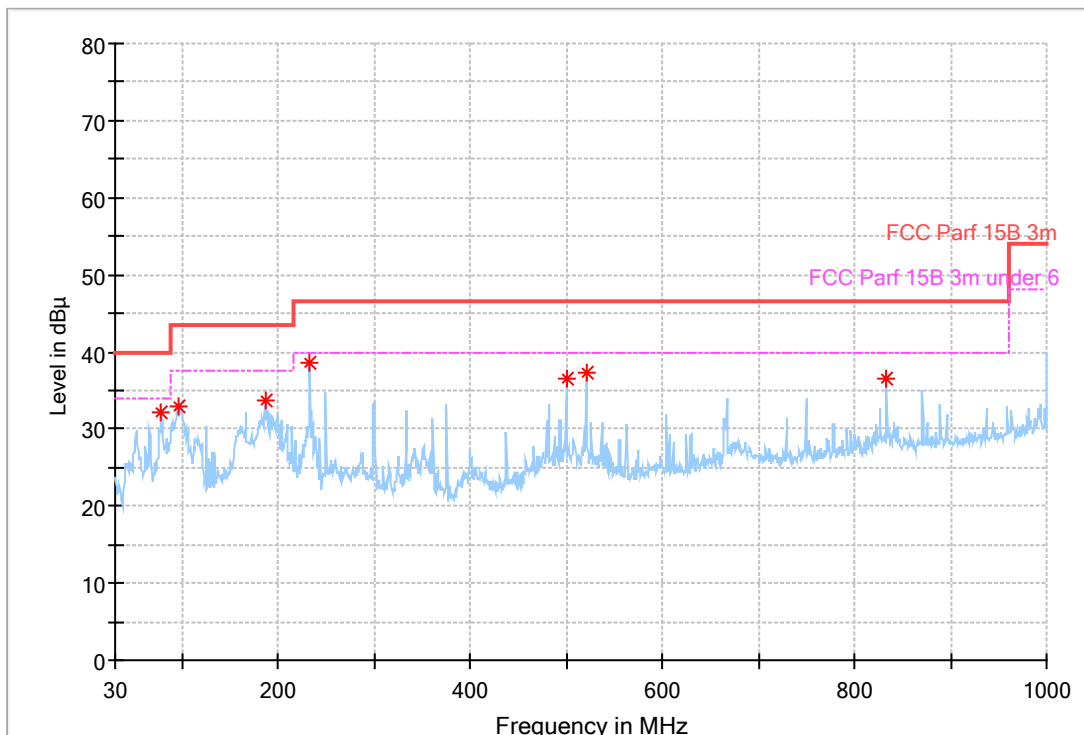

Frequency (MHz)	Reading (dBuV)	Detector	Correct Factor (dB/m)	Result (dBuV/m)	Limit (dBuV/m)	Margin (dB)
77.81	49.01	QP	-16.8	32.21	40	7.79
95.82	48.53	QP	-15.7	32.83	43.5	10.67
185.89	46.69	QP	-13	33.69	43.5	9.81
233.01	51.11	QP	-12.6	38.51	46.5	7.99
499.76	42.35	QP	-5.9	36.45	46.5	10.05
520.54	43.11	QP	-5.7	37.41	46.5	9.09
833.71	36.85	QP	-0.4	36.45	46.5	10.05

Note: Result = Reading + Correct Factor

Margin = Limit - Result

Correct Factor = Antenna Factor + Cable Loss - Amplifier Gain + Attenuator

Vertical

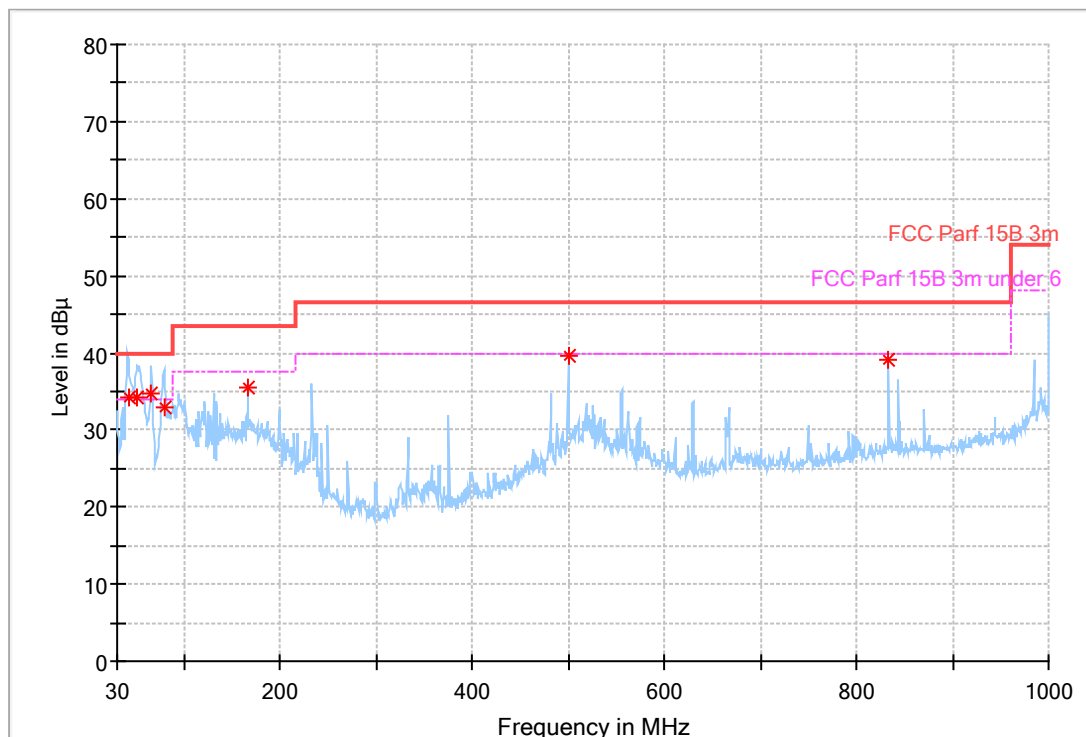

Frequency (MHz)	Reading (dBuV)	Detector	Correct Factor (dB/m)	Result (dBuV/m)	Limit (dBuV/m)	Margin (dB)
41.49	45.7	QP	-11.6	34.1	40	5.9
52.39	50.8	QP	-16.5	34.3	40	5.7
66.03	52	QP	-17.2	34.8	40	5.2
78.57	49.7	QP	-16.8	32.9	40	7.1
166.49	47.53	QP	-12.1	35.43	43.5	8.07
499.76	45.47	QP	-5.9	39.57	46.5	6.93
833.71	39.42	QP	-0.4	39.02	46.5	7.48

Note: Result = Reading + Correct Factor

Margin = Limit - Result

Correct Factor = Antenna Factor + Cable Loss - Amplifier Gain + Attenuator

Mode 2: Below 1GHz

Horizontal

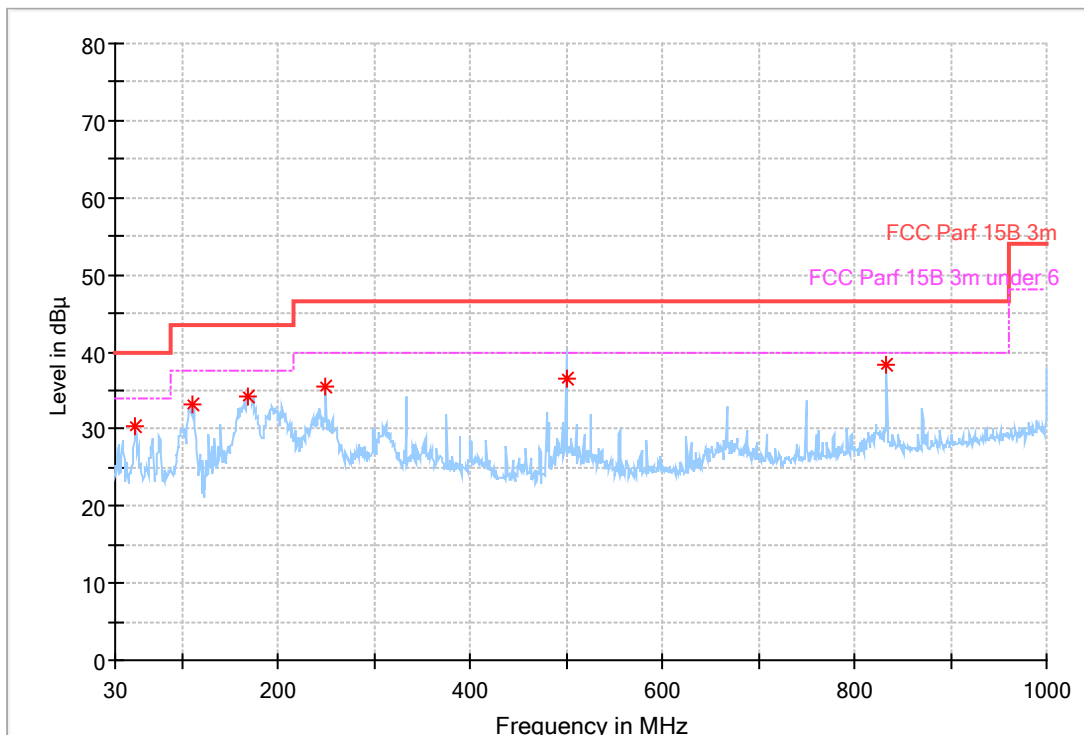

Frequency (MHz)	Reading (dBuV)	Detector	Correct Factor (dB/m)	Result (dBuV/m)	Limit (dBuV/m)	Margin (dB)
50.79	46.65	QP	-16.4	30.25	40	9.75
111.06	45.2	QP	-12.1	33.1	43.5	10.4
169.26	46.73	QP	-12.4	34.33	43.5	9.17
249.64	47.81	QP	-12.3	35.51	46.5	10.99
500.01	42.5	QP	-5.9	36.6	46.5	9.9
833.71	38.73	QP	-0.4	38.33	46.5	8.17

Note: Result = Reading + Correct Factor

Margin = Limit - Result

Correct Factor = Antenna Factor + Cable Loss - Amplifier Gain + Attenuator

Vertical

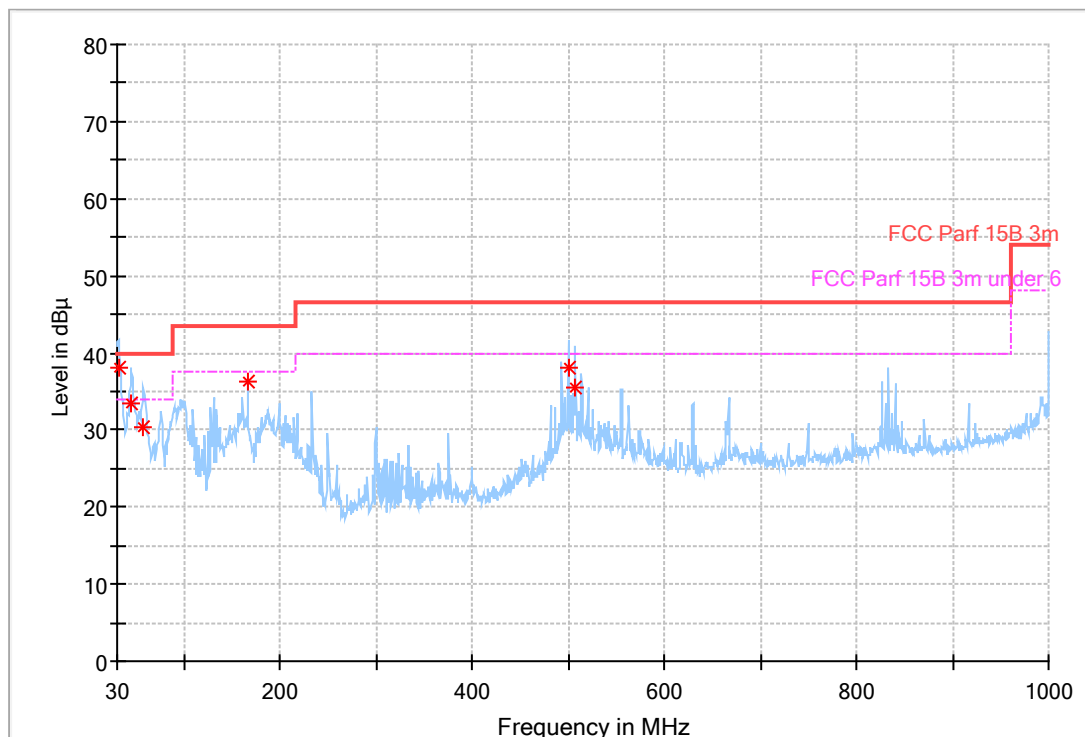

Frequency (MHz)	Reading (dBuV)	Detector	Correct Factor (dB/m)	Result (dBuV/m)	Limit (dBuV/m)	Margin (dB)
31.39	42.6	QP	-4.6	38	40	2
44.55	47.2	QP	-13.8	33.4	40	6.6
57.71	47.6	QP	-17.3	30.3	40	9.7
166.49	48.47	QP	-12.1	36.37	43.5	7.13
499.76	43.9	QP	-5.9	38	46.5	8.5
506.94	41.5	QP	-5.9	35.6	46.5	10.9

Note: Result = Reading + Correct Factor

Margin = Limit - Result

Correct Factor = Antenna Factor + Cable Loss - Amplifier Gain + Attenuator

Mode 1: Above 1GHz

Horizontal

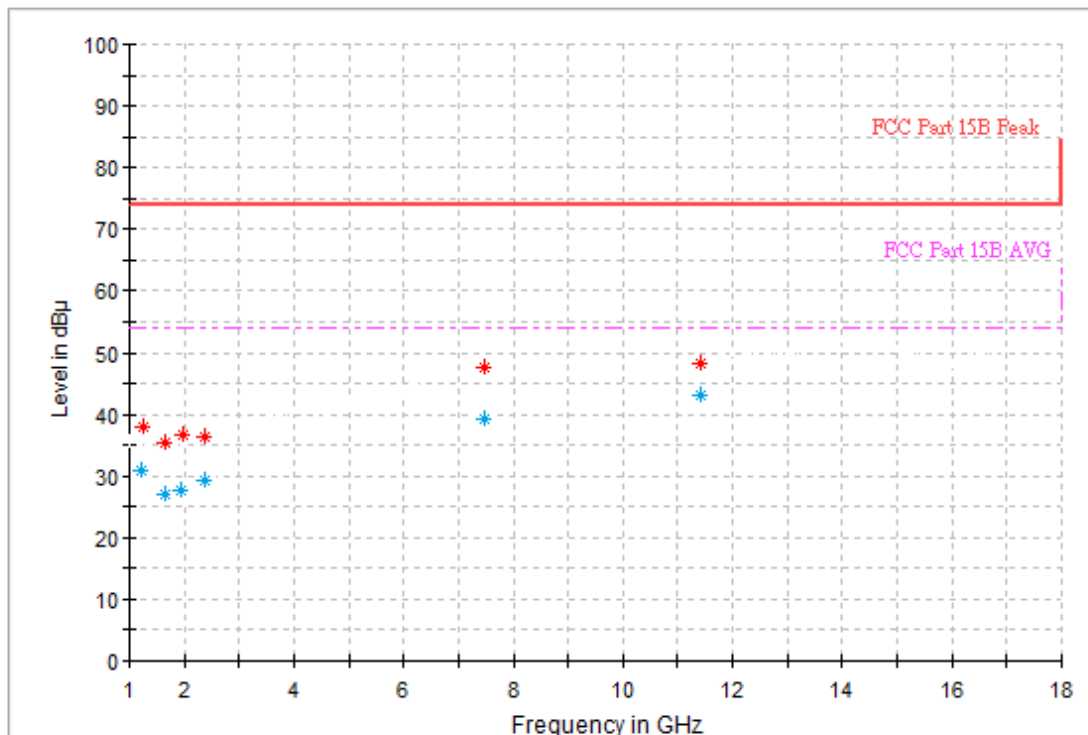

Frequency (MHz)	Reading (dBuV)	Detector	Correct Factor (dB/m)	Result (dBuV/m)	Limit (dBuV/m)	Margin (dB)
1238.48	47.67	PEAK	-9.8	37.87	74	36.13
1238.48	40.25	AVG	-9.8	30.45	54	23.55
1647.29	43.53	PEAK	-8	35.53	74	38.47
1647.29	35.32	AVG	-8	27.32	54	26.68
1987.98	42.97	PEAK	-6.3	36.67	74	37.33
1987.98	34.22	AVG	-6.3	27.92	54	26.08
2362.73	41.75	PEAK	-5.3	36.45	74	37.55
2362.73	34.86	AVG	-5.3	29.56	54	24.44
7472.95	40.21	PEAK	7.4	47.61	74	26.39
7472.95	32.52	AVG	7.4	39.92	54	14.08
11424.85	35.56	PEAK	12.8	48.36	74	25.64
11424.85	30.25	AVG	12.8	43.05	54	10.95

Note: Result = Reading + Correct Factor

Margin = Limit - Result

Correct Factor = Antenna Factor + Cable Loss - Amplifier Gain + Attenuator

Vertical

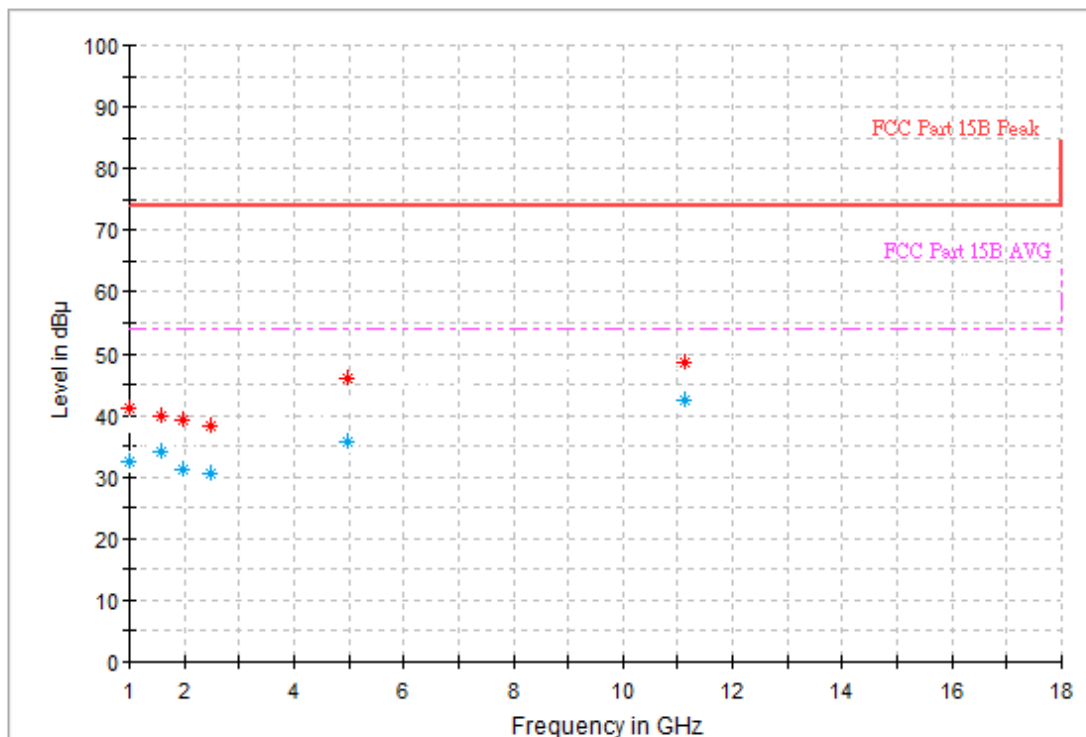

Frequency (MHz)	Reading (dBuV)	Detector	Correct Factor (dB/m)	Result (dBuV/m)	Limit (dBuV/m)	Margin (dB)
1000	51.99	PEAK	-10.7	41.29	74	32.71
1000	44.23	AVG	-10.7	33.53	54	20.47
1579.16	48.02	PEAK	-8.3	39.72	74	34.28
1579.16	42.32	AVG	-8.3	34.02	54	19.98
1987.98	45.56	PEAK	-6.3	39.26	74	34.74
1987.98	38.22	AVG	-6.3	31.92	54	22.08
2464.93	43.51	PEAK	-5.1	38.41	74	35.59
2464.93	35.47	AVG	-5.1	30.37	54	23.63
4985.97	44.72	PEAK	1.3	46.02	74	27.98
4985.97	35.21	AVG	1.3	36.51	54	17.49
11118.24	35.95	PEAK	12.6	48.55	74	25.45
11118.24	31.22	AVG	12.6	43.82	54	10.18

Note: Result = Reading + Correct Factor

Margin = Limit - Result

Correct Factor = Antenna Factor + Cable Loss - Amplifier Gain + Attenuator

Mode 2: Above 1GHz

Horizontal

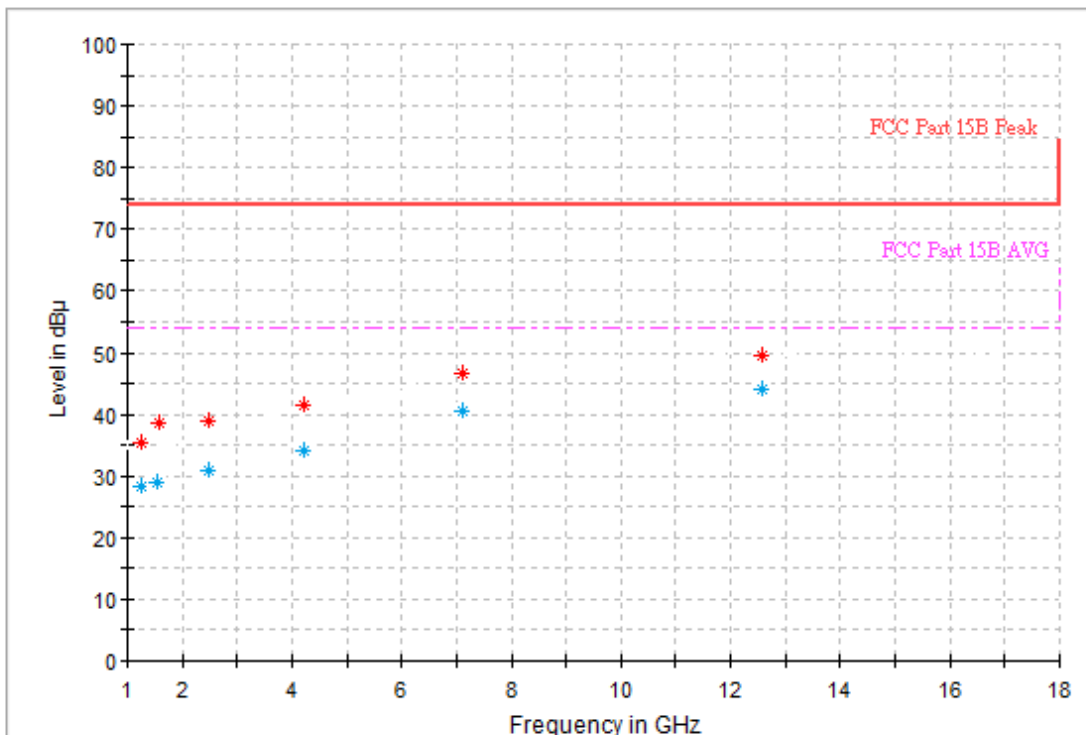

Frequency (MHz)	Reading (dBuV)	Detector	Correct Factor (dB/m)	Result (dBuV/m)	Limit (dBuV/m)	Margin (dB)
1238.48	45.33	PEAK	-9.8	35.53	74	38.47
1238.48	38.22	AVG	-9.8	28.42	54	25.58
1579.16	46.73	PEAK	-8.3	38.43	74	35.57
1579.16	37.12	AVG	-8.3	28.82	54	25.18
2464.93	44.15	PEAK	-5.1	39.05	74	34.95
2464.93	36.58	AVG	-5.1	31.48	54	22.52
4236.47	41.8	PEAK	-0.4	41.4	74	32.6
4236.47	35.12	AVG	-0.4	34.72	54	19.28
7098.2	40.7	PEAK	6	46.7	74	27.3
7098.2	34.85	AVG	6	40.85	54	13.15
12583.17	37.31	PEAK	12.3	49.61	74	24.39
12583.17	32.15	AVG	12.3	44.45	54	9.55

Note: Result = Reading + Correct Factor

Margin = Limit -Result

Correct Factor = Antenna Factor + Cable Loss - Amplifier Gain + Attenuator

Vertical

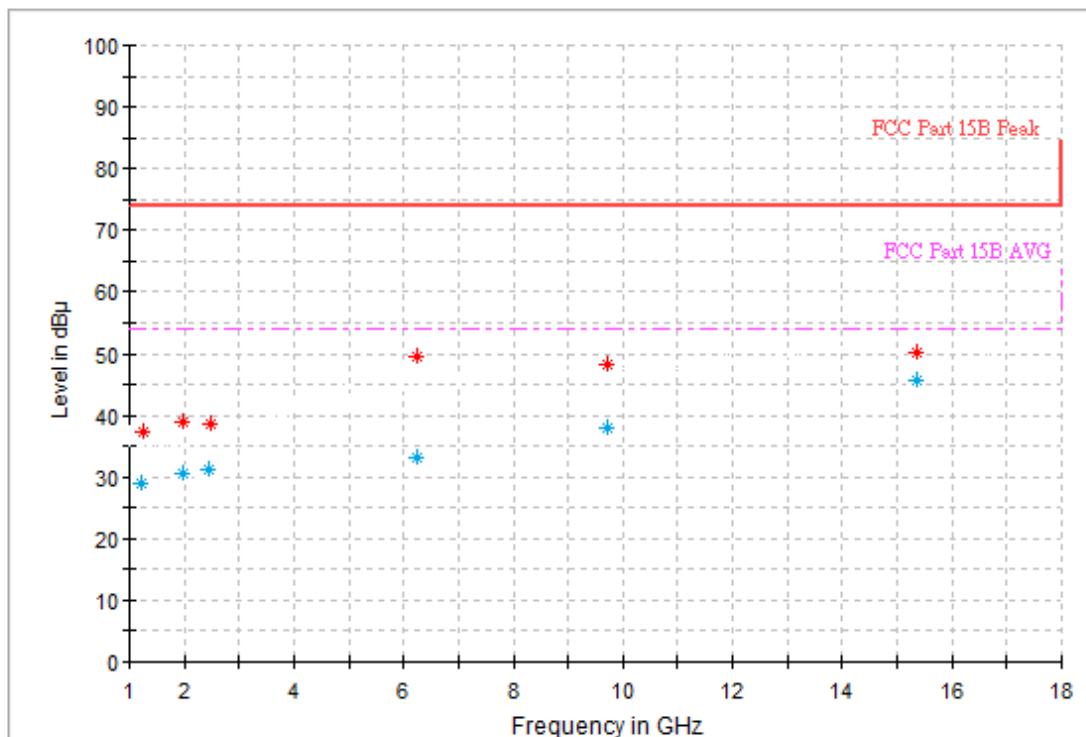

Frequency (MHz)	Reading (dBuV)	Detector	Correct Factor (dB/m)	Result (dBuV/m)	Limit (dBuV/m)	Margin (dB)
1238.48	45.33	PEAK	-9.8	35.53	74	38.47
1238.48	39.25	AVG	-9.8	29.45	54	24.55
1579.16	46.73	PEAK	-8.3	38.43	74	35.57
1579.16	38.45	AVG	-8.3	30.15	54	23.85
2464.93	44.15	PEAK	-5.1	39.05	74	34.95
2464.93	36.54	AVG	-5.1	31.44	54	22.56
4236.47	41.8	PEAK	-0.4	41.4	74	32.6
4236.47	34.11	AVG	-0.4	33.71	54	20.29
7098.2	40.7	PEAK	6	46.7	74	27.3
7098.2	32.86	AVG	6	38.86	54	15.14
12583.17	37.31	PEAK	12.3	49.61	74	24.39
12583.17	32.88	AVG	12.3	45.18	54	8.82

Note: Result = Reading + Correct Factor

Margin = Limit - Result

Correct Factor = Antenna Factor + Cable Loss - Amplifier Gain + Attenuator

***** END OF REPORT *****