

FCC Part 15.407
RSS-247 Issue 2, February 2017
Dynamic Frequency Selection
TEST REPORT

For

YEALINK(XIAMEN) NETWORK
TECHNOLOGY CO.,LTD.

No.666 Hu'an Rd,Huli District Xiamen City, Fujian, P.R. China

FCC ID: T2C-T34W
IC: 10741A-T34W

Report Type: Original Report	Product Type: Classic IP Phone
Report Producer : <u>Coco Lin</u>	
Report Number : <u>RXZ230919076RF01</u>	
Report Date : <u>2023-10-25</u>	
Reviewed By: <u>Andy Shih</u> <i>Andy Shih</i>	
Prepared By: Bay Area Compliance Laboratories Corp. (New Taipei Laboratory) 70, Lane 169, Sec. 2, Datong Road, Xizhi Dist., New Taipei City 22183, Taiwan, R.O.C. Tel: +886 (2) 2647 6898 Fax: +886 (2) 2647 6895 www.bacl.com.tw	

Revision History

Revision	No.	Report Number	Issue Date	Description	Author/ Revised by
0.0	RXZ230919076	RXZ230919076RF01	2023-10-25	Original Report	Coco Lin

TABLE OF CONTENTS

1	General Information	4
1.1	Product Description for Equipment under Test (EUT)	4
1.2	Objective	5
1.3	Test Methodology.....	5
1.4	Statement	5
1.5	Measurement Uncertainty	5
1.6	Environmental Conditions.....	6
1.7	Test Facility	6
2	System Test Configuration	7
2.1	Description of Test Configuration.....	7
2.2	Equipment Modifications	7
2.2	EUT Software.....	7
2.3	Support Equipment List and Details.....	7
2.4	External Cable List and Details	7
2.5	Block Diagram of Test Setup	7
3	Summary of Test Results	8
4	Test Equipment List and Details	9
5	Applicable Standards	10
5.1	DFS Requirement	10
5.2	DFS Measurement System	14
5.3	Test Procedure	14
6	Test Result	15
6.1	Description of EUT	15
6.2	Channel Loading	15
6.3	Radar Waveform Calibration	16
7	Channel Move Time and Channel Closing Transmission Time	17
7.1	Test Procedure.....	17
7.2	Test Results	17
8	Non-Occupancy Period	24
8.1	Test Procedure.....	24
8.2	Test Result.....	24

1 General Information

1.1 Product Description for Equipment under Test (EUT)

Applicant	YEALINK(XIAMEN) NETWORK TECHNOLOGY CO.,LTD.
	No.666 Hu'an Rd,Huli District Xiamen City, Fujian, P.R. China
Brand(Trade) Name	Yealink
Product (Equipment) / PMN	Classic IP Phone
Main Model Name	SIP-T34W
HVIN	T34W
Frequency Range	5250 MHz ~ 5350 MHz, 5470 MHz ~ 5725 MHz Note: frequency range 5600-5650MHz can't be used in Canada
Modulation Technique	OFDM
Antenna Specification	PCB Antenna Band 2 Gain: -0.08 dBi Band 3 Gain: 2.03 dBi
Power Operation (Voltage Range)	<input checked="" type="checkbox"/> AC 120V/60Hz <input checked="" type="checkbox"/> Adapter I/P: 100-240V 50~60Hz 0.2A , O/P: 5Vdc, 1.2A <input type="checkbox"/> By AC Power Cord
	<input checked="" type="checkbox"/> PoE: DC 48V/ 0.27A
	<input type="checkbox"/> DC from Battery <input type="checkbox"/> DC from Adapter <input type="checkbox"/> Host System
Received Date	2023/9/19
Date of Test	2023/9/22~2023/10/24

*All measurement and test data in this report was gathered from production sample serial number: RXZ230919076-01 (Assigned by BAACL, New Taipei Laboratory).

1.2 Objective

This report is prepared on behalf of YEALINK(XIAMEN) NETWORK TECHNOLOGY CO.,LTD. in accordance with Part 2 Subpart J, Part 15 Subparts E of the Federal Communication Commission's rules and RSS-247 Issue 2, February 2017 and RSS-GEN Issue 5, February 2021 Amendment 2 of the Innovation, Science and Economic Development Canada.

The tests were performed in order to determine compliance with FCC Part 15.407(h) and RSS-247 Issue 2, February 2017 Radar Detection Function of Dynamic Frequency Selection (DFS).

1.3 Test Methodology

FCC CFR 47 Part15.407 (h)

RSS-247 Issue 2, February 2017

FCC KDB 905462 D02 UNII DFS Compliance Procedures New Rules v02

1.4 Statement

Decision Rule: No, (The test results do not include MU judgment)

It may not be duplicated or used in part without prior written consent from Bay Area Compliance Laboratories Corp. (New Taipei Laboratory).

Any unauthorized alteration, forgery or falsification of the content or appearance of this document is unlawful and offenders may be prosecuted to the fullest extent of the law.

Unless otherwise stated the results shown in this test report refer only to the sample(s) tested.

The determination of the test results does not require consideration of the uncertainty of the measurement, unless the assessment is required by customer agreement, regulation or standard document specification.

Bay Area Compliance Laboratories Corp. (New Taipei Laboratory) is not responsible for the authenticity of the information provided by the applicant that affects the test results.

1.5 Measurement Uncertainty

Parameter	Uncertainty
DFS Level	±3.06 dB
Time Domain	±0.21 s
Temperature	±0.79 °C
Humidity	±0.44 %

Note: The extended uncertainty given in this report is obtained by combining the standard uncertainty times the coverage factor K with the 95% confidence interval. Otherwise required by the applicant or Product Regulations, Decision Rule in this report did not consider the uncertainty

1.6 Environmental Conditions

Test Site	Test Date	Temperature (°C)	Relative Humidity (%)	ATM Pressure (hPa)	Test Engineer
DFS	2023/9/22~2023/10/24	24.7~25.9	51~52	1010	Jing

1.7 Test Facility

The Test site used by Bay Area Compliance Laboratories Corp. (New Taipei Laboratory) to collect test data is located on

☒70, Lane 169, Sec. 2, Datong Road, Xizhi Dist., New Taipei City 22183, Taiwan, R.O.C.

Bay Area Compliance Laboratories Corp. (New Taipei Laboratory) is accredited to ISO 17025 by Taiwan Accreditation Foundation (TAF code: 3732) and the FCC designation No.TW3732 under the Mutual Recognition Agreement (MRA) in FCC Test.

The lab has been recognized by Innovation, Science and Economic Development Canada to test to Canadian radio equipment requirements, the CAB identifier: TW3732.

2 System Test Configuration

2.1 Description of Test Configuration

The EUT was configured for testing in a normal mode which was provided by the manufacturer.

2.2 Equipment Modifications

No modification was made to the EUT.

2.2 EUT Software

EUT the firmware version is “124.86.254.135”

2.3 Support Equipment List and Details

Description	Manufacturer	Model Number
Adapter	Yealink	YLPS051200B1-US
NB	DELL	E6410
AP Router	NETGEAR	R7800

Master device FCC ID: PY315100319

2.4 External Cable List and Details

N/A

2.5 Block Diagram of Test Setup

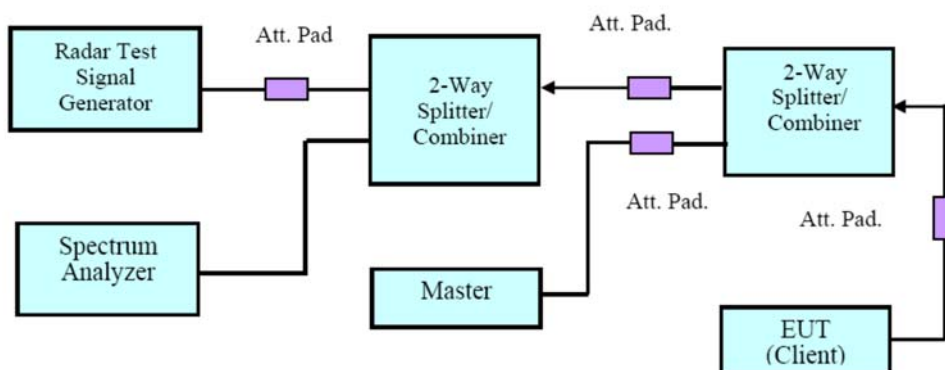

3 Summary of Test Results

The following result table represents the list of measurements required under the CFR §47 Part 15.407(h) and RSS-247, Issue 2, February 2017, KDB: 905462 D02 UNII DFS Compliance Procedures New Rules v02

Items	Description of Test	Results
Detection Bandwidth	UNII Detection Bandwidth	Not applicable
Performance Requirements Check	Initial Channel Availability Check Time (CAC)	Not applicable
	Radar Burst at the Beginning of the CAC	Not applicable
	Radar Burst at the End of the CAC	Not applicable
In-Service Monitoring	Channel Move Time	Compliant
	Channel Closing Transmission Time	Compliant
	Non-Occupancy Period	Compliant
Radar Detection	Statistical Performance Check	Not applicable

Not applicable: the EUT is a client unit without radar detection.

4 Test Equipment List and Details

Description	Manufacturer	Model	Serial Number	Calibration Date	Calibration Due Date
Spectrum Analyzer	Rohde & Schwarz	FSV40	101939	2023/3/23	2024/3/22
Signal Generator	Rohde & Schwarz	SMBV100A	261748	2023/2/10	2024/2/9
Cable	UTIFLEX	UFA210A	9435	2022/10/3	2023/10/2
				2023/10/2	2024/9/30
Cable	UTIFLEX	UFA210A	6679	2022/10/3	2023/10/2
				2023/10/2	2024/9/30
Attenuator	MCL	BW-S10W5+	1419	2023/2/2	2024/2/1
Attenuator	MCL	BW-S20W5+	1430	2023/6/6	2024/6/4
Power Splitter	Mini-Circuits	ZFRSC-183-S+	S F448201614	2023/6/6	2024/6/4
Power Splitter	Mini-Circuits	ZFRSC-183-S+	S F112701513	2023/2/1	2024/1/31

***Statement of Traceability:** BACL Corp. attests that all of the calibrations on the equipment items listed above were traceable to the SI System of Units via the R.O.C. Center for Measurement Standards of the Electronics Testing Center, Taiwan (ETC) or to another internationally recognized National Metrology Institute (NMI), and were compliant with the current Taiwan Accreditation Foundation (TAF) requirements

5 Applicable Standards

5.1 DFS Requirement

CFR §47 Part 15.407(h) and RSS-247, Issue 2, February 2017

FCC KDB 905462 D02 UNII DFS Compliance Procedures New Rules v02

Table 1: Applicability of DFS Requirements Prior to Use of a Channel

Requirement	Operational Mode		
	Master	Client Without Radar Detection	Client With Radar Detection
<i>Non-Occupancy Period</i>	Yes	Not required	Yes
<i>DFS Detection Threshold</i>	Yes	Not required	Yes
<i>Channel Availability Check Time</i>	Yes	Not required	Not required
<i>U-NII Detection Bandwidth</i>	Yes	Not required	Yes

Table 2: Applicability of DFS requirements during normal operation

Requirement	Operational Mode	
	Master Device or Client with Radar Detection	Client Without Radar Detection
<i>DFS Detection Threshold</i>	Yes	Not required
<i>Channel Closing Transmission Time</i>	Yes	Yes
<i>Channel Move Time</i>	Yes	Yes
<i>U-NII Detection Bandwidth</i>	Yes	Not required

Additional requirements for devices with multiple bandwidth modes	Master Device or Client with Radar Detection	Client Without Radar Detection
<i>U-NII Detection Bandwidth and Statistical Performance Check</i>	All BW modes must be tested	Not required
<i>Channel Move Time and Channel Closing Transmission Time</i>	Test using widest BW mode available	Test using the widest BW mode available for the link
<i>All other tests</i>	Any single BW mode	Not required
Note: Frequencies selected for statistical performance check (Section 7.8.4) should include several frequencies within the radar detection bandwidth and frequencies near the edge of the radar detection bandwidth. For 802.11 devices it is suggested to select frequencies in each of the bonded 20 MHz channels and the channel center frequency.		

Table 3: DFS Detection Thresholds for Master Devices and Client Devices With Radar Detection

Maximum Transmit Power	Value (See Notes 1, 2, and 3)
EIRP ≥ 200 milliwatt	-64 dBm
EIRP < 200 milliwatt and power spectral density < 10 dBm/MHz	-62 dBm
EIRP < 200 milliwatt that do not meet the power spectral density requirement	-64 dBm
<p>Note 1: This is the level at the input of the receiver assuming a 0 dBi receive antenna.</p> <p>Note 2: Throughout these test procedures an additional 1 dB has been added to the amplitude of the test transmission waveforms to account for variations in measurement equipment. This will ensure that the test signal is at or above the detection threshold level to trigger a DFS response.</p> <p>Note3: EIRP is based on the highest antenna gain. For MIMO devices refer to KDB Publication 662911 D01.</p>	

Table 4: DFS Response Requirement Values

Parameter	Value
<i>Non-occupancy period</i>	Minimum 30 minutes
<i>Channel Availability Check Time</i>	60 seconds
<i>Channel Move Time</i>	10 seconds See Note 1.
<i>Channel Closing Transmission Time</i>	200 milliseconds + an aggregate of 60 milliseconds over remaining 10 second period. See Notes 1 and 2.
<i>U-NII Detection Bandwidth</i>	Minimum 100% of the U-NII 99% transmission power bandwidth. See Note 3.
<p>Note 1: <i>Channel Move Time</i> and the <i>Channel Closing Transmission Time</i> should be performed with Radar Type 0. The measurement timing begins at the end of the Radar Type 0 burst.</p> <p>Note 2: The <i>Channel Closing Transmission Time</i> is comprised of 200 milliseconds starting at the beginning of the <i>Channel Move Time</i> plus any additional intermittent control signals required to facilitate a <i>Channel</i> move (an aggregate of 60 milliseconds) during the remainder of the 10 second period. The aggregate duration of control signals will not count quiet periods in between transmissions.</p> <p>Note 3: During the <i>U-NII Detection Bandwidth</i> detection test, radar type 0 should be used. For each frequency step the minimum percentage of detection is 90 percent. Measurements are performed with no data traffic.</p>	

Table 5 – Short Pulse Radar Test Waveforms

Radar Type	Pulse Width (μsec)	PRI (μsec)	Number of Pulses	Minimum Percentage of Successful Detection	Minimum Number of Trials
0	1	1428	18	See Note 1	See Note 1
1	1	Test A: 15 unique PRI values randomly selected from the list of 23 PRI values in Table 5a	Roundup $\left\{ \left(\frac{1}{360} \right) \cdot \left(\frac{19 \cdot 10^6}{\text{PRI}_{\mu\text{SEC}}} \right) \right\}$	60%	30
		Test B: 15 unique PRI values randomly selected within the range of 518-3066 μsec, with a minimum increment of 1 μsec, excluding PRI values selected in Test A			
2	1-5	150-230	23-29	60%	30
3	6-10	200-500	16-18	60%	30
4	11-20	200-500	12-16	60%	30
Aggregate (Radar Types 1-4)				80%	120
Note 1: Short Pulse Radar Type 0 should be used for the detection bandwidth test, channel move time, and channel closing time tests.					

A minimum of 30 unique waveforms are required for each of the Short Pulse Radar Types 2 through 4. If more than 30 waveforms are used for Short Pulse Radar Types 2 through 4, then each additional waveform must also be unique and not repeated from the previous waveforms. If more than 30 waveforms are used for Short Pulse Radar Type 1, then each additional waveform is generated with Test B and must also be unique and not repeated from the previous waveforms in Tests A or B.

For example if in Short Pulse Radar Type 1 Test B a PRI of 3066 usec is selected, the number of pulses would be $\text{Roundup} \left\{ \left(\frac{1}{360} \right) \cdot \left(\frac{19 \cdot 10^6}{3066} \right) \right\} = \text{Roundup} \{17.2\} = 18$.

Table 5a - Pulse Repetition Intervals Values for Test A

Pulse Repetition Frequency Number	Pulse Repetition Frequency (Pulses Per Second)	Pulse Repetition Interval (Microseconds)
1	1930.5	518
2	1858.7	538
3	1792.1	558
4	1730.1	578
5	1672.2	598
6	1618.1	618
7	1567.4	638
8	1519.8	658
9	1474.9	678
10	1432.7	698
11	1392.8	718
12	1355	738
13	1319.3	758
14	1285.3	778
15	1253.1	798
16	1222.5	818
17	1193.3	838
18	1165.6	858
19	1139	878
20	1113.6	898
21	1089.3	918
22	1066.1	938
23	326.2	3066

The aggregate is the average of the percentage of successful detections of Short Pulse Radar Types 1-4. For example, the following table indicates how to compute the aggregate of percentage of successful detections.

Radar Type	Number of Trials	Number of Successful Detections	Minimum Percentage of Successful Detection
1	35	29	82.9%
2	30	18	60%
3	30	27	90%
4	50	44	88%
Aggregate (82.9% + 60% + 90% + 88%)/4 = 80.2%			

Table 6 – Long Pulse Radar Test Waveform

Radar Type	Pulse Width (μsec)	Chirp Width (MHz)	PRI (μsec)	Number of Pulses per Burst	Number of Bursts	Minimum Percentage of Successful Detection	Minimum Number of Trials
5	50-100	5-20	1000-2000	1-3	8-20	80%	30

Table 7 – Frequency Hopping Radar Test Waveform

Radar Type	Pulse Width (μsec)	PRI (μsec)	Pulses per Hop	Hopping Rate (kHz)	Hopping Sequence Length (msec)	Minimum Percentage of Successful Detection	Minimum Number of Trials
6	1	333	9	0.333	300	70%	30

5.2 DFS Measurement System

BACL DFS measurement system consists of two subsystems: (1) The radar signal generating subsystem and (2) the traffic monitoring subsystem.

5.3 Test Procedure

A spectrum analyzer is used as a monitor verifies that the EUT status including Channel Closing Transmission Time and Channel Move Time, and does not transmit on a Channel during the Non-Occupancy Period after the diction and Channel move.

6 Test Result

6.1 Description of EUT

The EUT operates in 5250-5350 MHz and 5470-5725 MHz range.

The rated output power of master device is >23 dBm (EIRP), therefore the required interference threshold level is -64 dBm, the required radiated threshold at antenna port is -64 dBm.

Throughout these test procedures an additional 1 dB has been added to the amplitude of the test transmission waveforms to account for variations in measurement equipment. This will ensure that the test signal is at or above the detection threshold level to trigger a DFS response.

The calibrated radiated DFS detection threshold level is set to $-64 + (\text{Master antenna gain}) =$

Band 2 : $-64 + 1.11 = -62.89$ dBm.

Band 3 : $-64 + 1.61 = -62.39$ dBm

6.2 Channel Loading

WLAN traffic is generated by software "Lan Test20", software is used by IP and Frame based systems for loading the test channel during the In service compliance testing of the U-NII device. Data package streamed from the Access Point to the Client using the software "Lan Test20".

6.3 Radar Waveform Calibration

Radar Type 0

5290 MHz:

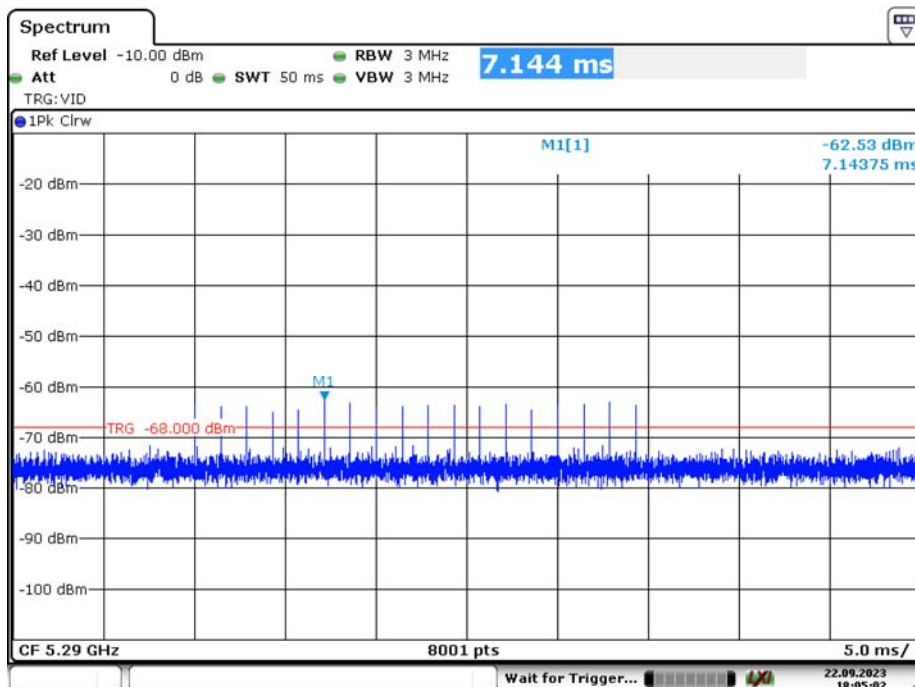

Date: 22.SEP.2023 18:05:02

5530 MHz:

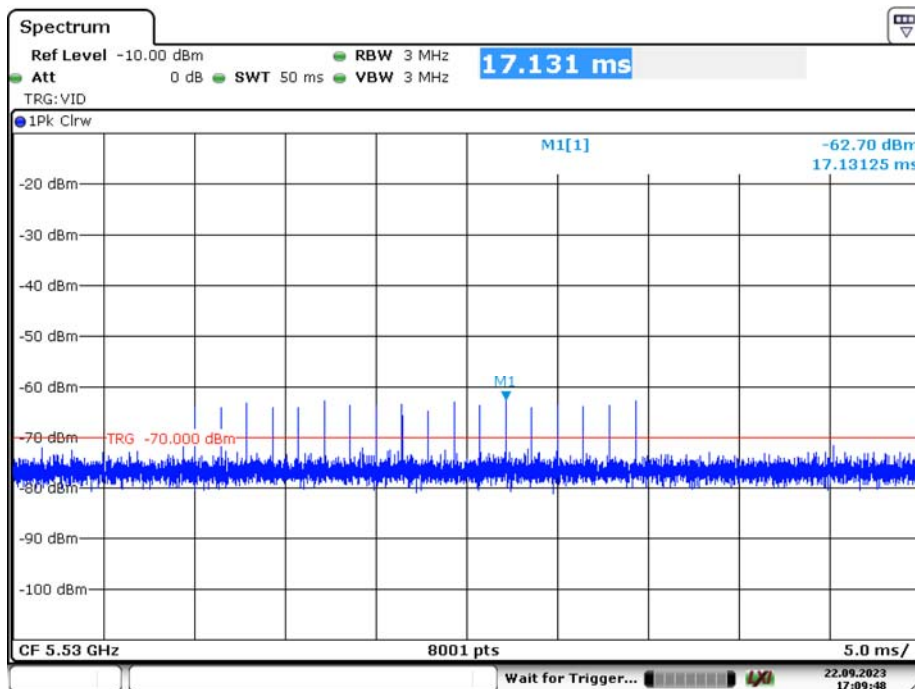

Date: 22.SEP.2023 17:09:48

7 Channel Move Time and Channel Closing Transmission Time

7.1 Test Procedure

Perform type 0 short pulse radar waveform. The aggregate channel closing transmission time is calculated as follows:

$$\text{Aggregate Transmission Time} = N * \text{Dwell Time}$$

N is the number of spectrum analyzer bins showing a device transmission Dwell Time is the dwell time per bin (i.e. Dwell Time = S/B, S is the sweep time and B is the number of bin, i.e. 8001)

7.2 Test Results

Frequency (MHz)	Bandwidth (MHz)	Radar Type	Results
5290	80	Type 0	Compliant
5530	80	Type 0	Compliant

Please refer to the following tables and plots.

5290 MHz

Type 0 radar channel move time result:

Item	Time (s)	Limit (s)
Channel move time	0	10

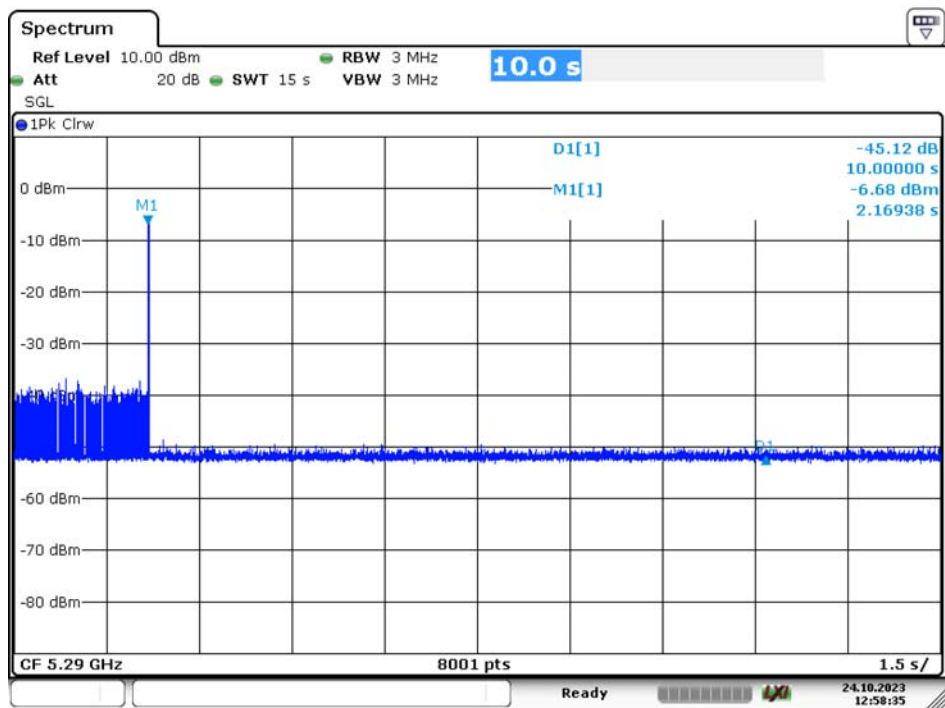

Date: 24.OCT.2023 12:58:35

Type0 radar channel closing transmission time result:

Item	Time (ms)	Limit (ms)
Closing Transmission Time	0	60

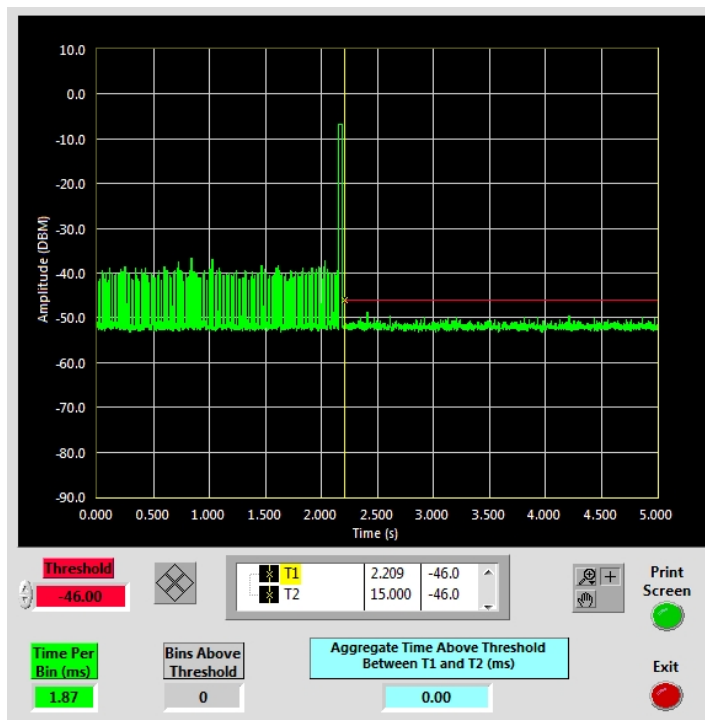
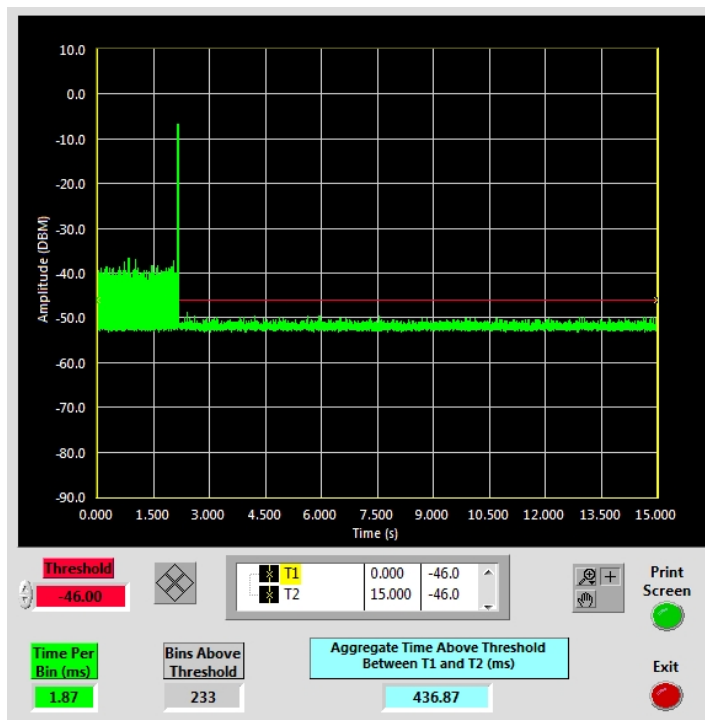

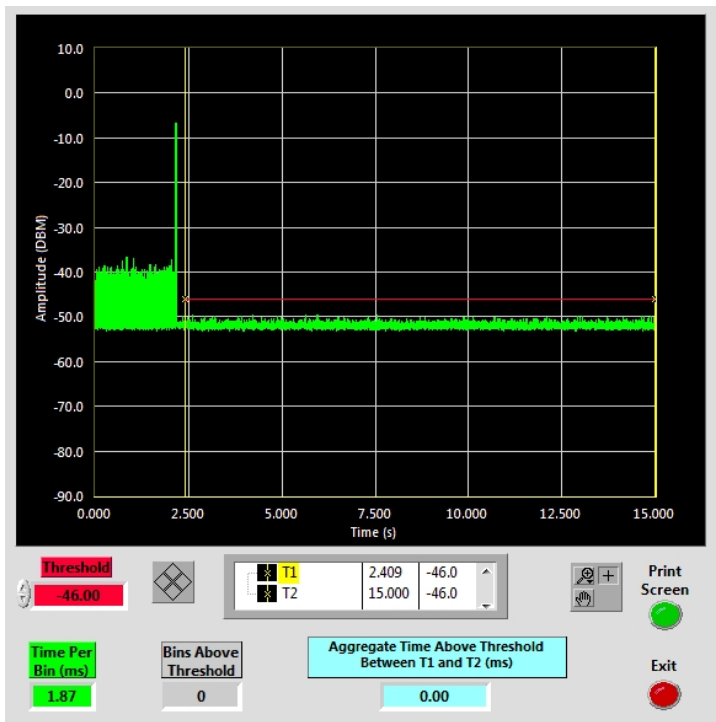
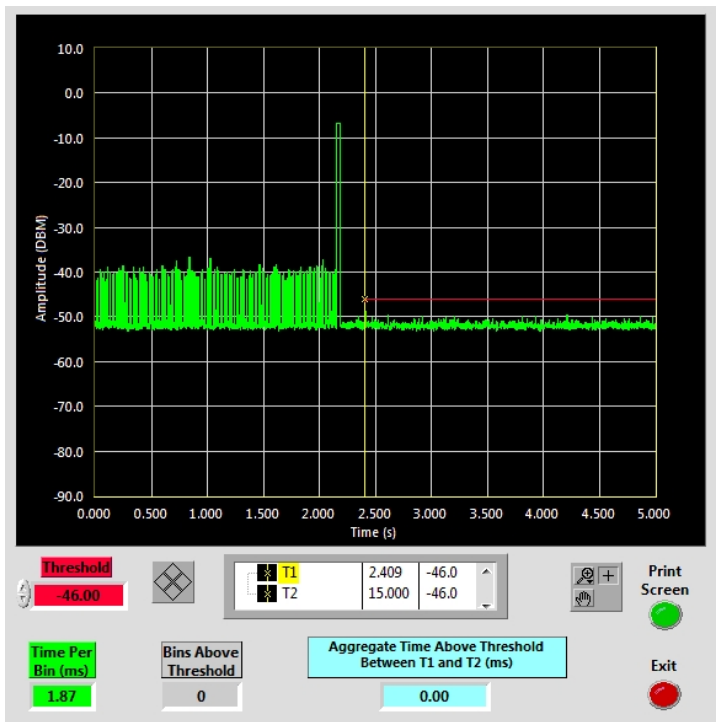

5530 MHz

Type 0 radar channel move time result:

Item	Time (s)	Limit (s)
Channel move time	0	10

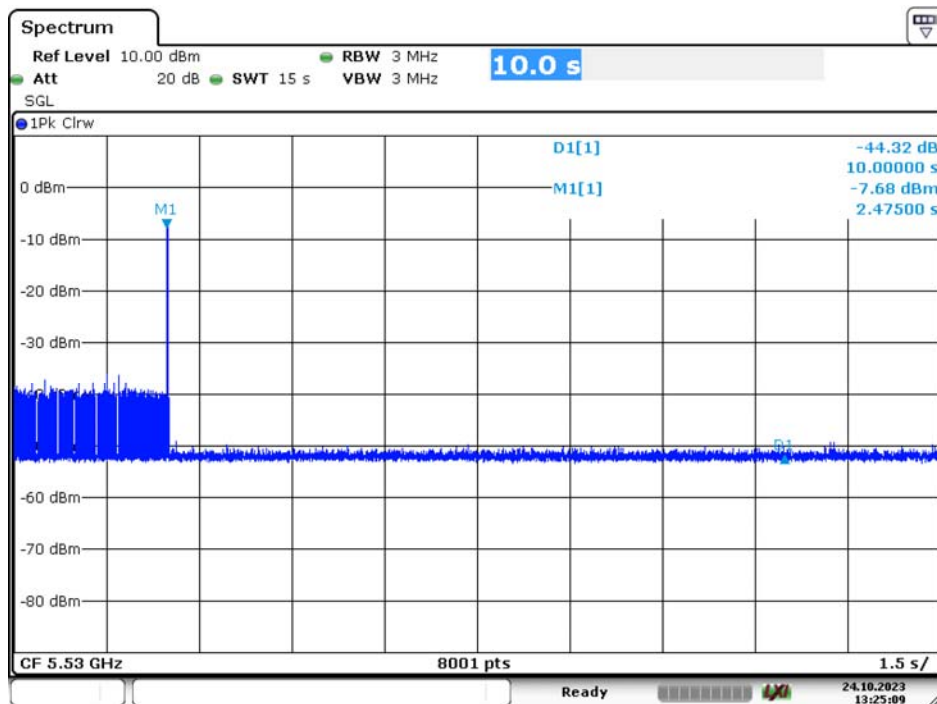

Date: 24.OCT.2023 13:25:08

Type0 radar channel closing transmission time result:

Item	Time (ms)	Limit (ms)
Closing Transmission Time	0	60

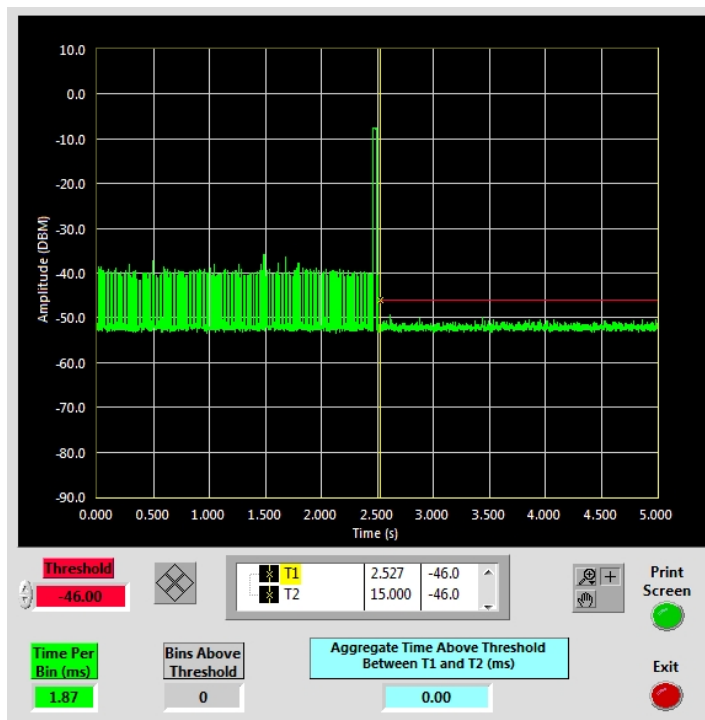
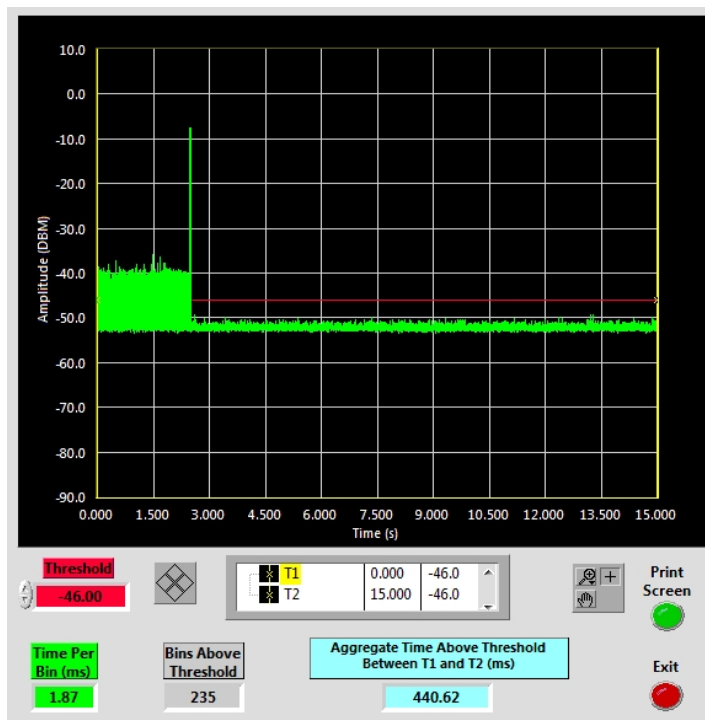

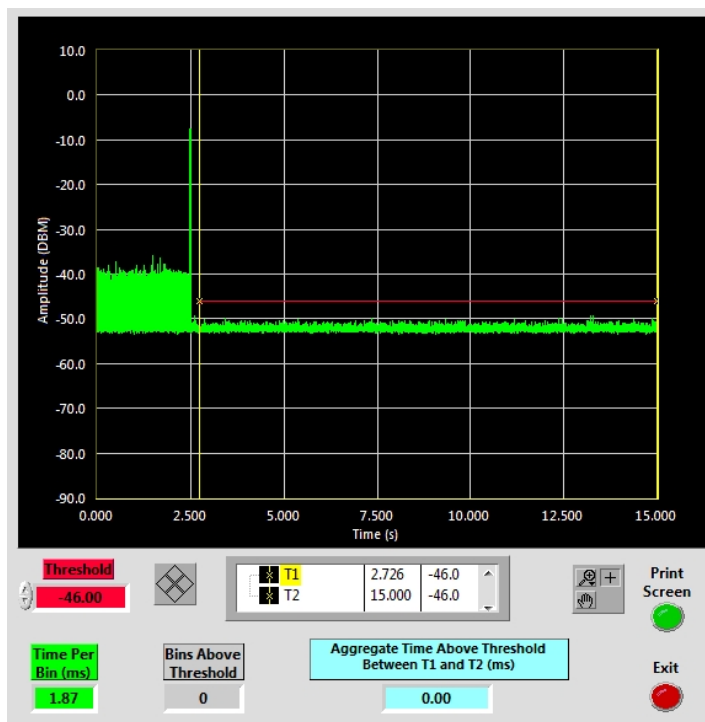
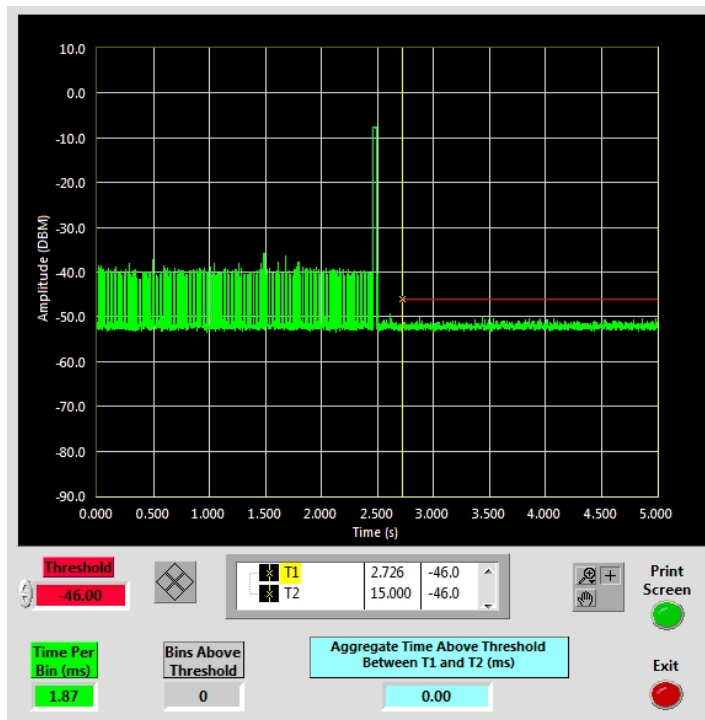

8 Non-Occupancy Period

8.1 Test Procedure

Measure the EUT for more than 30 minutes following the channel close/move time to very that the EUT does not resume any transmissions on this channel. Provide one plot to demonstrate no transmission on the channel for the non-occupancy period (30 minutes observation time)

8.2 Test Result

Frequency(MHz)	Bandwidth (MHz)	Spectrum Analyzer Display
5290	80	No transmission within 30 minutes
5530	80	No transmission within 30 minutes

Please refer to the following plots.

5290 MHz

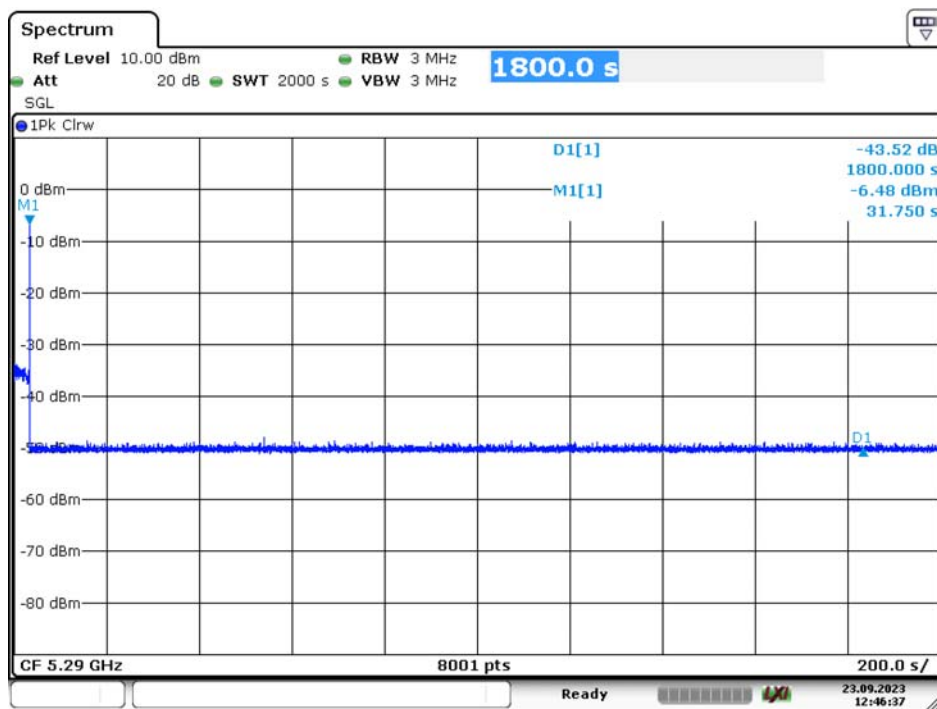

Date: 23.SEP.2023 12:46:37

5530 MHz

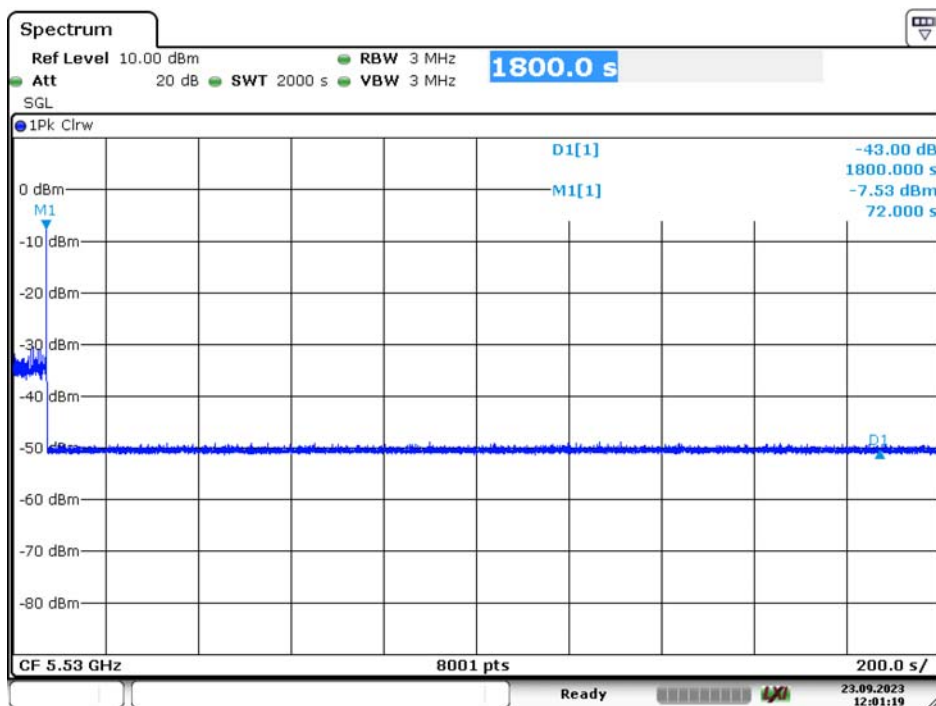

Date: 23.SEP.2023 12:01:19

***** END OF REPORT *****