

Ke Mei Ou Laboratory Co., Ltd.

E506, 5th Floor, No.39 Keji Middle 2nd Rd, Science & Technology
Park, Nanshan District, Shenzhen, P. R. China
Tel: + 86 755 83642690 Fax: + 86 755 83297077
www.kmolab.com

FCC TEST REPORT

Under :
FCC Part 15, Class B

Prepared For :

Yealink (Xiamen) Network Technology Co., Ltd.

4th-5th Floor, South Building, NO.63 WangHai Road, 2nd Software Park, Xiamen, China

FCC ID: T2C-T19P
EUT: IP Phone
Model: SIP-T19P

August 8, 2013
Issue Date:
Original Report
Report Type:
<i>Eric Guo</i>
Test Engineer: Eric Guo

Review By: Apollo Liu / Manager

The test report consists 24 pages in total. It may be duplicated completely for legal use with the allowance of the applicant. It shall not be reproduced except in full, without the written approval of Ke Mei Ou Laboratory Corporation. The test result in the report only applied to the tested sample.

TABLE OF CONTENTS

1. General Information	3
1. 1 Notes.....	3
1. 2 Testing Laboratory.....	3
1. 3 Details of Applicant.....	3
1. 4 Application Details	3
1. 5 Test Item	3
1. 6 Test Standards.....	3
2. Technical Test.....	4
2. 1 Summary of Test Results	4
3. EUT Modifications	4
4. Conducted Power Line Test.....	5
4. 1 Test Equipment.....	5
4. 2 Test Procedure	5
4. 3 Test Setup	5
4. 4 Configuration of The EUT.....	6
4. 5 EUT Operating Condition.....	7
4. 6 Conducted Power Line Emission Limits	7
4. 7 Conducted Power Line Test Result.....	8
5. Radiated Emission Test.....	11
5. 1 Test Equipment.....	11
5. 2 Test Procedure	11
5. 3 Radiated Test Setup	11
5. 4 Configuration of The EUT.....	12
5. 5 EUT Operating Condition.....	12
5. 6 Radiated Emission Limit	12
5. 7 Radiated Emission Test Result.....	13
6. Photo of Testing.....	15
6.1 Emission test view.....	15
6.2 Photograph - EUT.....	17
7. FCC ID Label.....	23
8. Test Equipment.....	24

1. General Information

1.1 Notes

The test results of this report relate exclusively to the test item specified in 1.5. The KMO Lab does not assume responsibility for any conclusions and generalizations drawn from the test results with regard to other specimens or samples of the type of the equipment represented by the test item. The test report may only be reproduced or published in full. Reproduction or publication of extracts from the report requires the prior written approval of the KMO Lab.

1.2 Testing Laboratory

Sintek Laboratory Co., Ltd.

Site on File with the Federal Communications Commission – United States

Registration Number: 963441

1.3 Details of Applicant

Name : Yealink (Xiamen) Network Technology Co.,Ltd

Address : 4th-5th Floor, South Building,NO.63 WangHai Road, 2nd Software Park, Xiamen, China

1.4 Application Details

Date of Receipt of Application : June 21, 2013

Date of Receipt of Test Item : June 21, 2013

Date of Test : July 19~August 8, 2013

1.5 Test Item

Manufacturer : Yealink (Xiamen) Network Technology Co.,Ltd

Address : 4th-5th Floor, South Building,NO.63 WangHai Road, 2nd Software Park,
Xiamen, China

Trade Name : Yealink

Model No.(Base) : SIP-T19P

Model No.(Extension) : N/A

Description : IP Phone

Additional Information

Frequency : N/A

Number of Channels : N/A

Power Supply : DC 5V/600mA(Adapter model:OH-1006B0500600U-VDE)
DC 5V/0.6A(Adapter model:NSA6EE-050060)
POE 48V power

Operation Distance : N/A

Resolution : N/A

1.6 Test Standards

FCC 15 Subpart B

Note: All radiated measurements were made in all three orthogonal planes. The values reported are the maximum values.

2. Technical Test

2.1 Summary of Test Results

The EUT has been tested according to the following specifications:

FCC 15 Subpart B: 2007, Class B

Standard	Test Type	Result	Notes
FCC Part 15, Paragraph 15.107	Conducted Test	PASS	Complies
FCC Part 15, Paragraph 15.109	Radiated Test	PASS	Complies

3. EUT Modifications

No modification by test lab.

4. Conducted Power Line Test

4.1 Test Equipment

Please refer to Section 8 this report.

4.2 Test Procedure

The EUT was tested according to ANSI C63.4 - 2003. The frequency spectrum from 0.15 MHz to 30 MHz was investigated. The LISN used was 50 ohm / 50 u-Henry as specified by section 5.1 OF ANSI C63.4 - 2003. cables and peripherals were moved to find the maximum emission levels for each frequency.

4.3 Test Setup

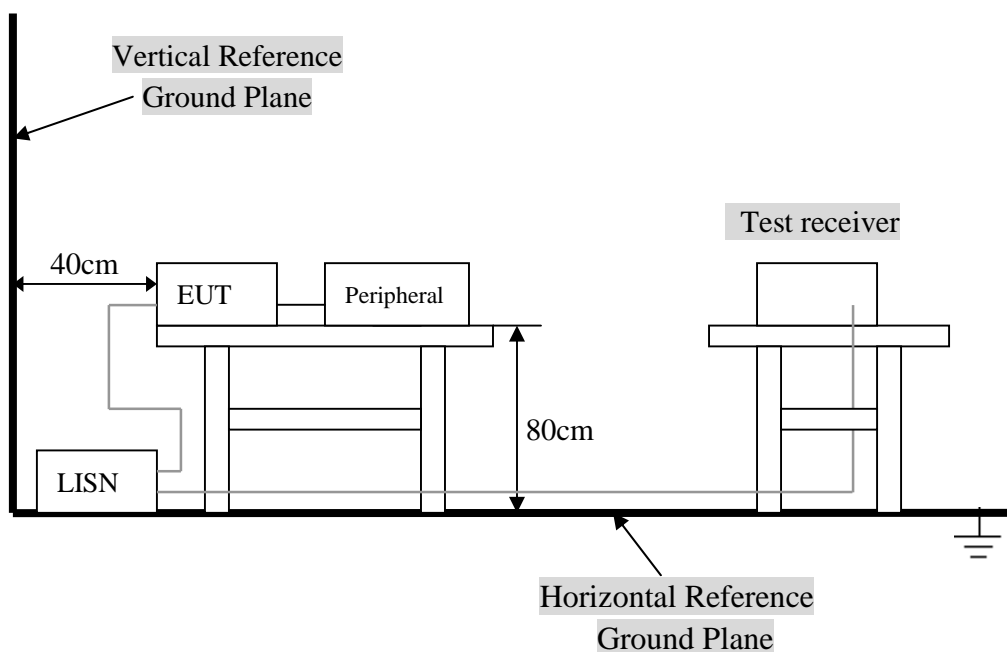

For the actual test configuration, Please refer to the related items – Photos of Testing.

4.4 Configuration of The EUT

The EUT was configured according to ANSI C63.4-2003. All interface ports were connected to the appropriate peripherals. All peripherals and cables are listed below.

A. EUT

Device	Manufacturer	Model #	FCC ID
IP Phone	Yealink (Xiamen) Network Technology Co.,Ltd	SIP-T19P	T2C-T19P

B. Internal Devices

Device	Manufacturer	Model #	FCCID / DoC
N/A			

C. Peripherals

Device	Manufacturer	Model # Serial #	FCC ID/ DoC	Cable
Printer	HP	HP930C	DoC	1.5m unshielded power cord 1.2m unshielded data cable.
Modem	GVC	N/A	DoC	1.5m unshielded power cord 1.2m unshielded data cable.
Notebook	DELL	PP10L	DoC	1.5m unshielded power cord
PC	Dell	2400n	DoC	1.5m unshielded power cord

4.5 EUT Operating Condition

Operating condition is according to ANSI C63.4 - 2003.

- A. Setup the EUT and simulators as shown on follow.
- B. Enable RF signal and confirm EUT active.
- A. Modulate output capacity of EUT up to specification.

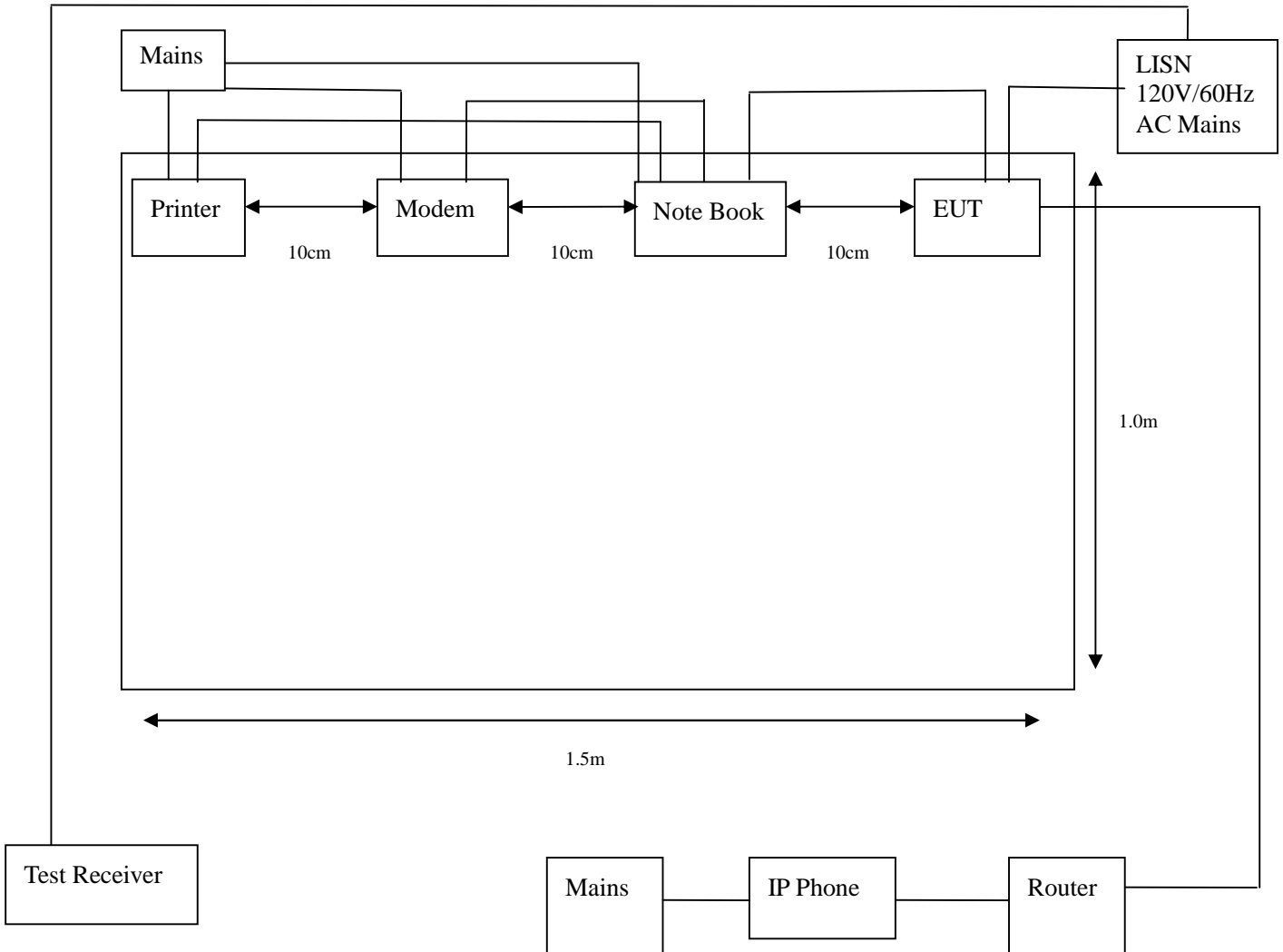

4.6 Conducted Power Line Emission Limits

Frequency Range (MHz)	Class A QP/AV (dBuV)	Class B QP/AV (dBuV)
0.15 – 0.5	79/66	66 –56/56 –46
0.5 – 5.0	73/60	56/46
5.0 – 30	73/60	60/50

Note: In the above table, the tighter limit applies at the band edges.

4.7 Conducted Power Line Test Result

Product	: IP Phone	Test Mode	: Talking
Test Item	: Conducted Emission Data	Temperature	: 25 °C
Test Voltage	: AC120V/60Hz /POE	Humidity	: 56%RH
Test Result	: PASS	Adapter Model	:

The frequency spectrum from 0.15 MHz to 30 MHz was investigated. All readings are quasi -peak values with a resolution bandwidth of 9 KHz.

- Temperature : 26 °C
- Humidity : 53 % RH

Adapter model: OH-1006B0500600U-UL

FCC Part 15 Paragraph 15.107							
Frequency (MHz)	Emission (dBuV)		LINE/NEUTRAL	Limit (dBuV)		Margin (dB)	
	QP	AV		QP	AV	QP	AV
0.158	41.81	29.55	Line	65.57	55.57	-23.76	-26.02
0.154	40.33	28.45	Neutral	65.78	55.78	-25.45	-27.33
0.314	44.44	35.67	Line	59.86	49.86	-15.42	-14.19
0.318	41.52	30.77	Neutral	59.76	49.76	-18.24	-18.99
0.326	43.65	35.38	Line	59.55	49.55	-15.90	-14.17
0.322	41.11	30.34	Neutral	59.66	49.66	-18.55	-19.32

Note: NF = No Significant Peak was Found.

Adapter model: NSA6EU-050060

FCC Part 15 Paragraph 15.107							
Frequency (MHz)	Emission (dBuV)		LINE/NEUTRAL	Limit (dBuV)		Margin (dB)	
	QP	AV		QP	AV	QP	AV
0.242	53.21	43.12	Line	62.03	52.03	-8.82	-8.91
0.266	57.98	47.45	Neutral	61.24	51.24	-3.26	-3.79
0.266	54.65	44.72	Line	61.24	51.24	-6.59	-6.52
0.274	54.51	43.33	Neutral	61.00	51.00	-6.49	-7.67
0.630	48.18	41.22	Line	56.00	46.00	-7.82	-4.78
0.866	46.32	35.91	Neutral	56.00	46.00	-9.68	-10.09

Note: NF = No Significant Peak was Found.

POE

FCC Part 15 Paragraph 15.107							
Frequency (MHz)	Emission (dBuV)		LINE/NEUTRAL	Limit (dBuV)		Margin (dB)	
	QP	AV		QP	AV	QP	AV
0.246	36.06	32.61	Line	61.89	51.89	-25.83	-19.28
0.242	37.08	33.62	Neutral	62.03	52.03	-24.95	-18.41
0.426	37.32	33.91	Line	57.33	47.33	-20.01	-13.42
0.366	37.01	33.78	Neutral	58.59	48.59	-21.58	-14.81
0.486	37.22	33.79	Line	56.24	46.24	-19.02	-12.45
0.426	37.51	34.22	Neutral	57.33	47.33	-19.82	-13.11

Note: NF = No Significant Peak was Found.

Note:

- 1.Uncertainty in conducted emission measured is <+/- 2dB.
- 2.The emission levels of other frequencies were very low against the limit.
- 3.All Reading Levels are Quasi-Peak and Average value.
- 4.Emission = Meter Reading + Factor; Factor = Insertion Loss + Cable Loss.
- 5.Margin Value = Emission Level - Limit Value.

Conducted Emission

FCC15.107

EUT: IP Phone

M/N: SIP-T21P

Manufacturer: Yealink (Xiamen) Network Technology Co.,Ltd

Operating Condition: Transmitter

Test Site: Normal

Operator: Eric

Test Specification: LINE&NEUTRAL

Comment:

Adapter model: OH-1006B0500600U-UL

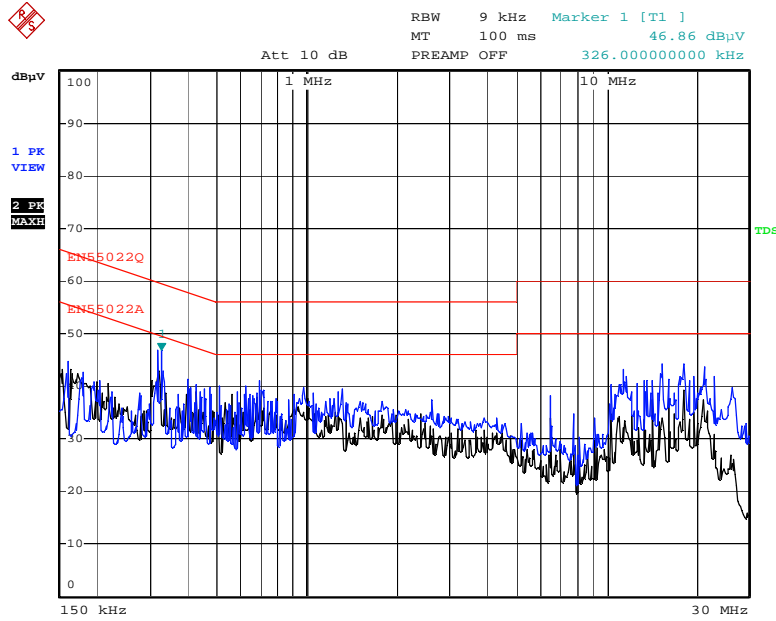

Date: 8.AUG.2013 16:04:48

Adapter model: NSA6EU-050060

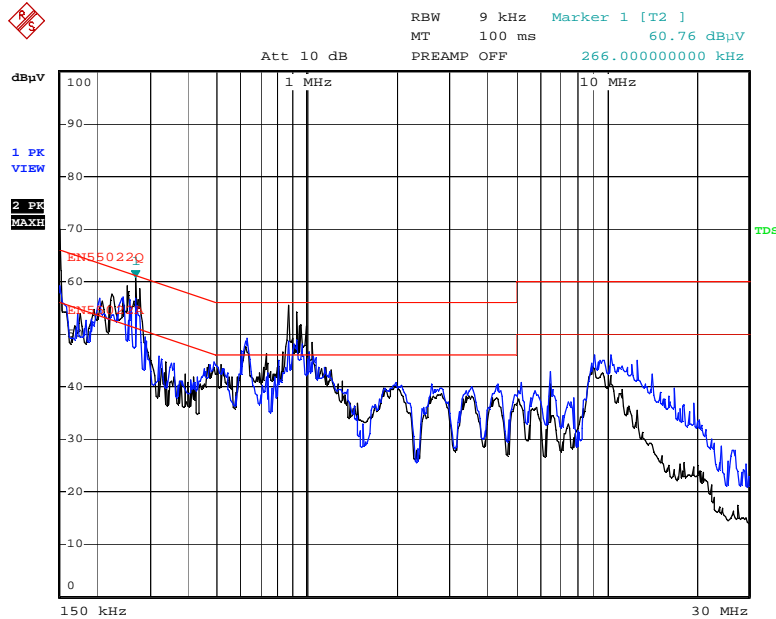

Date: 8.AUG.2013 11:17:28

POE



RBW 9 kHz Marker 1 [T2]
MT 100 ms 41.74 dBµV
PREAMP OFF 366.00000000 kHz

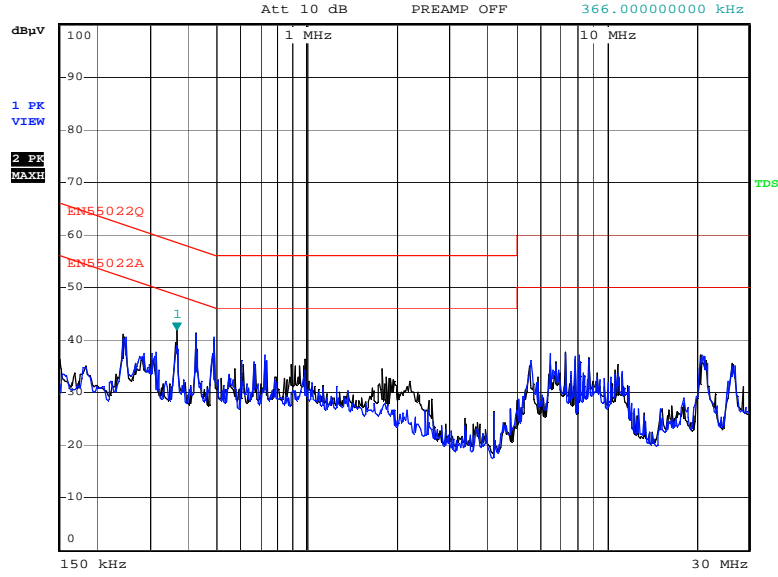

Date: 8.AUG.2013 16:20:54

5. Radiated Emission Test

5.1 Test Equipment

Please refer to Section 8 this report.

5.2 Test Procedure

1. The EUT was tested according to ANSI C63.4 - 2003.
2. The EUT, peripherals were put on the turntable which table size is 1m x 1.5 m, table high 0.8 m. All set up is according to ANSI C63.4-2003.
3. The frequency spectrum from 9 kHz to 25 GHz was investigated. All readings from 9 kHz to 150 kHz are quasi-peak values with a resolution bandwidth of 200 Hz. All readings from 150 kHz to 30 MHz are quasi-peak values with a resolution bandwidth of 9 KHz. All readings from 30 MHz to 1 GHz are quasi-peak values with a resolution bandwidth of 120 KHz. All readings are above 1 GHz , peak values with a resolution bandwidth of 1 MHz . Measurements were made at 3 meters.
4. The emissions from the EUT were measured continuously at every azimuth by rotating the turntable. The Receiving antenna high is varied from 1 m to 4 m high to find the maximum emission for each frequency. Emissions below 30MHz were measured with a loop antenna while emission above 30MHz were measured using a broadband E-field antenna.
5. Maximizing procedure was performed on the six (6) highest emissions to ensure EUT compliance is with all installation combinations. All data was recorded in the peak detection mode. Quasi-peak readings was performed only when an emission was found to be marginal (within -4 dB of specification limit), and are distinguished with a "QP" in the data table.
6. Each emission was to be maximized by changing the polarization of receiving antenna both horizontal and vertical. In order to find out the max. emission, the relative positions of this transmitter(EUT) was rotated through three orthogonal axes according to the requirements in Section 8 and 13 of ANSI C63.4 - 2003.

5.3 Radiated Test Setup

For Frequencies below 30 MHz

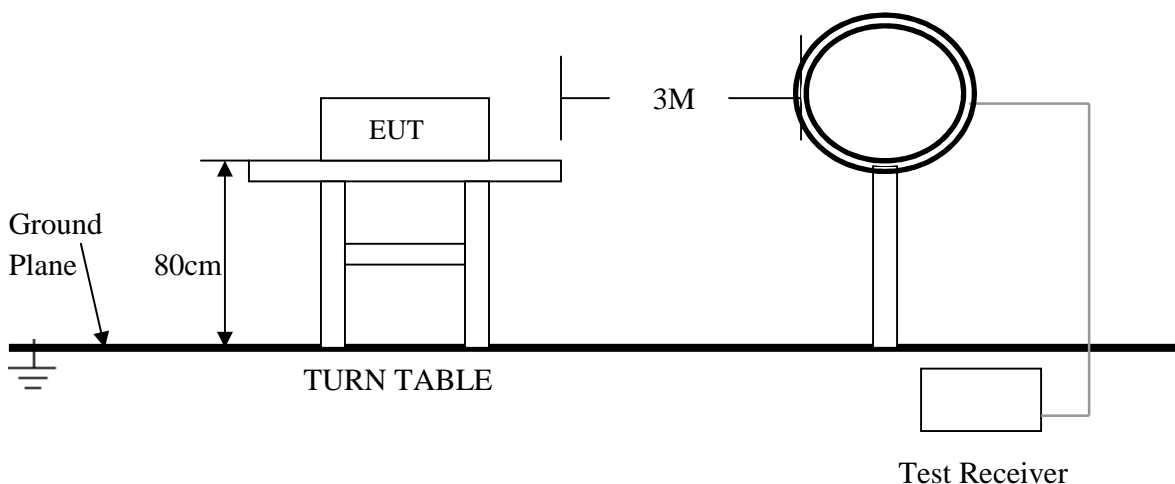

For the actual test configuration , please refer to the related items – Photos of Testing

For Frequencies above 30 MHz

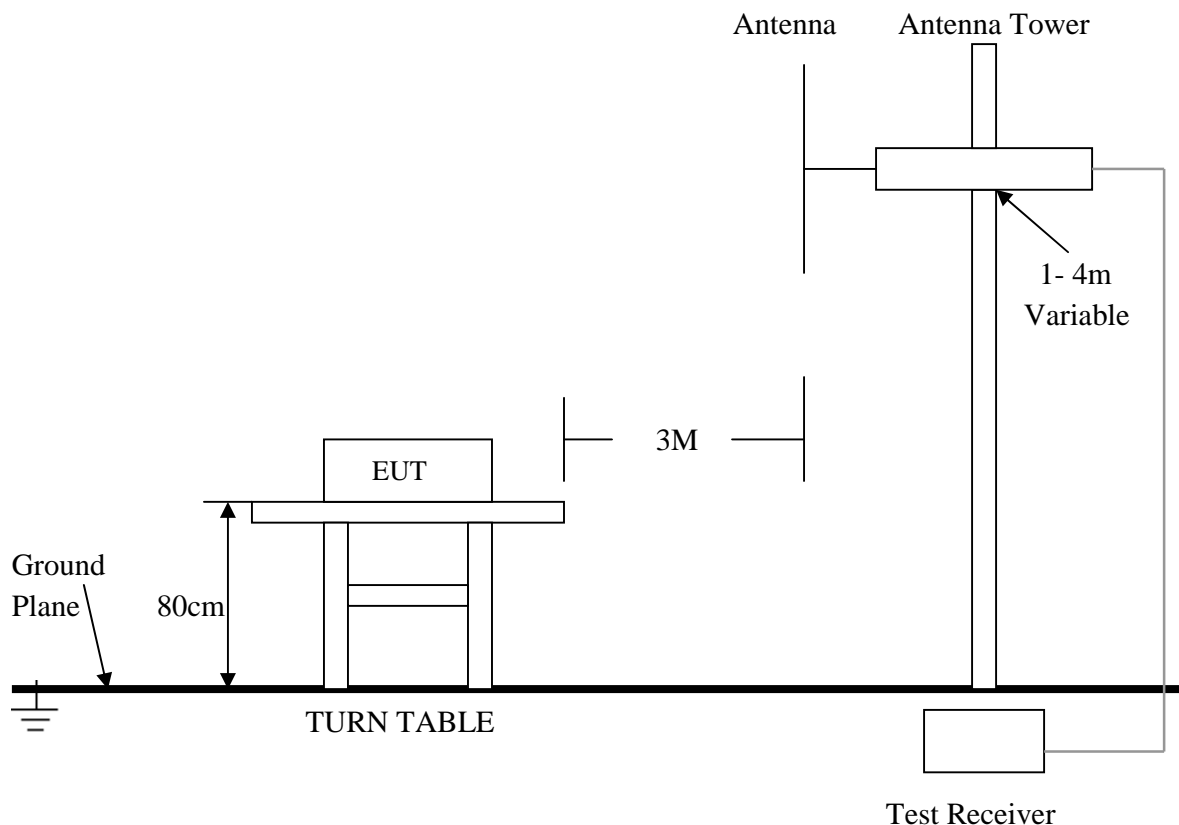

For the actual test configuration , please refer to the related items – Photos of Testing

5. 4 Configuration of The EUT

Same as section 4.4 of this report

5. 5 EUT Operating Condition

Same as section 4.5 of this report

5. 6 Radiated Emission Limit

All emission from a digital device, including any network of conductors and apparatus connected thereto, shall not exceed the level of field strength specified below:

Frequencies in restricted band are complied to limit on Paragraph 15.109.

Frequency (MHz)	Distance (m)	Field Strength (dBuV/m)
30 - 88	3	40.0
88 - 216	3	43.5
216 - 960	3	46.0
Above 960	3	54.0

Note:

1. In the emission tables above, the tighter limit applies at the band edges.
2. Distance refers to the distance between measuring instrument, antenna, and the closest point of any part of the device or system.
3. The lower limit shall apply at the transition frequencies.

5.7 Radiated Emission Test Result

Product	: IP Phone	Test Mode	: Talking
Test Item	: Radiated Emission Data	Temperature	: 25 °C
Test Voltage	: 120V/60Hz POE	Humidity	: 56%RH
Test Result	: PASS	Model	:

For Frequency Below 30MHz

Freq. (MHz)	Emission (dBuV/m) QP Detector	HORIZ / VERT	Limits (dBuV/m)	Margin (dB)
N/A	N/A	N/A	N/A	N/A

- Note:**
- (1) All Readings below 1GHz are Quasi-Peak, above are performed with peak and/or average measurements as necessary.
 - (2) "N/A" remark, if no specific emissions from the EUT are recorded (ie: margin>20dB from the applicable limit) and considered that's already beyond the background noise floor.
 - (3) Emission Level = Reading Level + Probe Factor + Cable Loss.

For Frequency Above 30MHz

Adapter model: OH-1006B0500600U-UL

Freq. (MHz)	Emission (dBuV/m) QP Detector	HORIZ / VERT	Limits (dBuV/m)	Margin (dB)
250.040	36.74	HORZ	46.0	-9.26
32.600	36.17	VERT	40.0	-3.83
331.800	39.01	HORZ	46.0	-6.99
71.640	30.01	VERT	40.0	-9.99
450.040	38.72	HORZ	46.0	-7.28
550.080	41.28	VERT	46.0	-4.72

Adapter model: NSA6EU-050060

Freq. (MHz)	Emission (dBuV/m) QP Detector	HORIZ / VERT	Limits (dBuV/m)	Margin (dB)
250.040	35.42	HORZ	46.0	-10.58
30.320	38.59	VERT	40.0	-1.41
331.800	41.28	HORZ	46.0	-4.72
442.400	40.01	VERT	46.0	-5.99
350.040	35.87	HORZ	46.0	-10.13
550.080	41.02	VERT	46.0	-4.98

POE

Freq. (MHz)	Emission (dBuV/m) QP Detector	HORIZ / VERT	Limits (dBuV/m)	Margin (dB)
221.160	32.06	HORZ	46.0	-13.94
32.600	36.78	VERT	40.0	-3.22
250.040	36.61	HORZ	46.0	-9.39
250.000	36.27	VERT	46.0	-9.73
331.840	32.98	HORZ	46.0	-13.02
650.080	36.41	VERT	46.0	-9.59

- Note:**
- (1) All Readings below 1GHz are Quasi-Peak, above are performed with peak and/or average measurements as necessary.
 - (2) Emission Level = Reading Level + Probe Factor + Cable Loss.

For Frequency above 1GHz

Freq. (MHz)	Emission (dBuV/m)		HORIZ / VERT	Limits(dBuV/m)		Margin(dB)	
	PK	AV		PK	AV	PK	AV
1.3172	33.46	26.89	HORZ	74	54	-40.54	-27.11
1.1004	32.31	25.83	VERT	74	54	-41.69	-28.17
1.5020	32.66	26.21	HORZ	74	54	-41.34	-27.79
1.4988	32.65	26.22	VERT	74	54	-41.35	-27.78
1.7056	33.10	26.58	HORZ	74	54	-40.90	-27.42
1.8576	33.90	27.51	VERT	74	54	-40.10	-26.49

- Note:**
- (1) All Readings below 1GHz are Quasi-Peak, above are performed with peak and/or average measurements as necessary.
 - (2) Emission Level = Reading Level + Probe Factor + Cable Loss.

6. Photo of Testing

6.1 Emission test view

Conducted emission test view



Radiated emission test view





6.2 Photograph - EUT

EUT top view



EUT bottom view



EUT inside whole view



Main & RF board component side

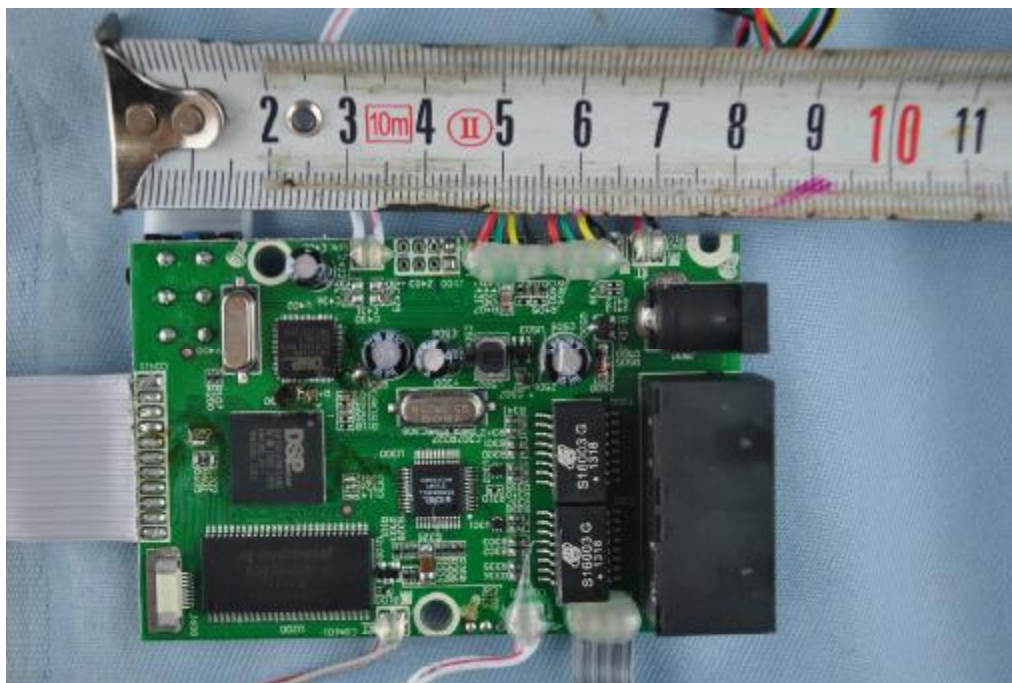

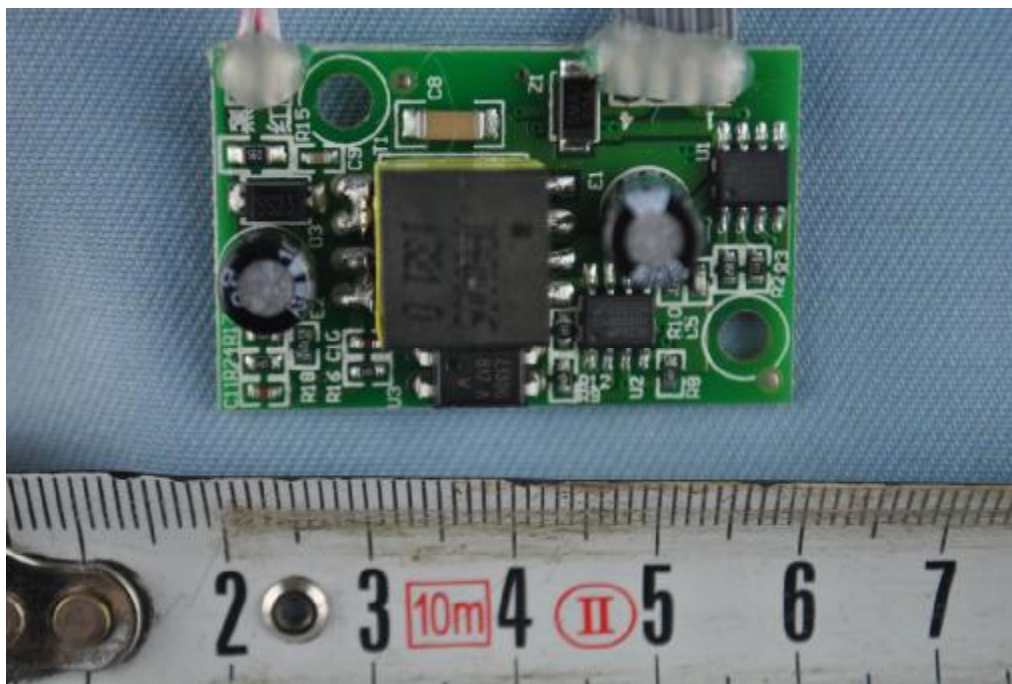

Main & RF board solder side

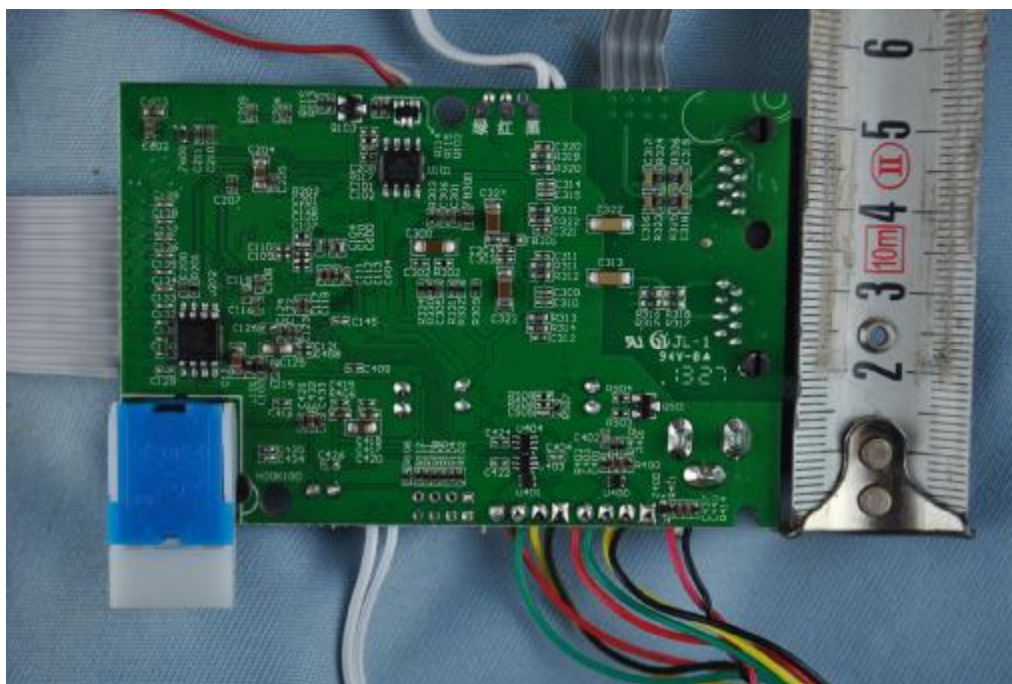

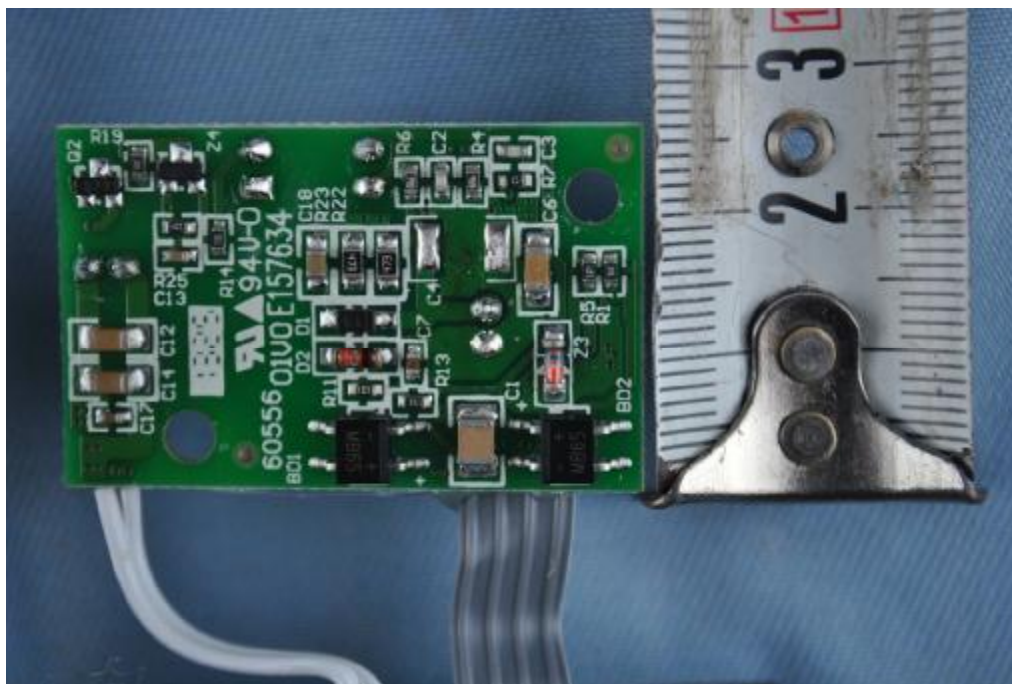

Adapter top view





Adapter side view





7. FCC ID Label

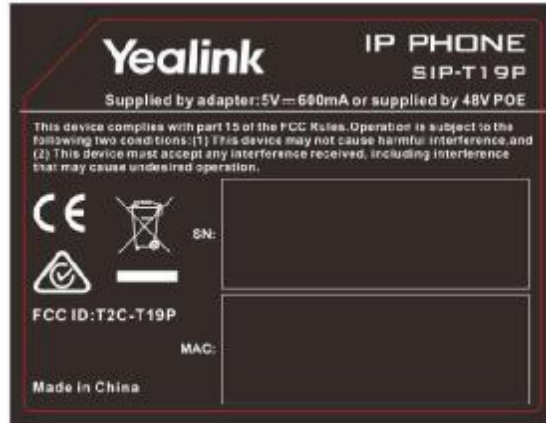

This device complies with Part 15 of the FCC Rules. Operation is subject to the following two conditions: (1) this device may not cause harmful interference, and (2) this device must accept any interference received, including interference that may cause undesired operation.

The Label must not be a stick-on paper label. The Label on these products must be permanently affixed to the product and readily visible at the time of purchase and must last the expected lifetime of the equipment not be readily detachable.

Proposed Label Location on EUT

EUT Bottom View/Proposed FCC ID Label Location



8. Test Equipment

The following test equipments were used during the radiated & conducted emission test:

Equipment/ Facilities	Manufacturer	Model #	Serial No.	Due Date
Turntable	SinTek	N/A	N/A	NCR
Antenna Tower	SinTek	N/A	N/A	NCR
OATS	SinTek	N/A	N/A	Sep.28, 2013
Pre-Amplifier	Agilent	87405C	KMO-SZ155	Dec.6, 2013
Pre-Amplifier	Com-Power	PAM-840	KMO-SZ156	Dec.6, 2013
Horn Antenna	Com-Power	AH-840	KMO-SZ157	Dec.6, 2013
EMI Test Receiver	Rohde & Schwarz	ESPI7	KMO-SZ002	June 01, 2014
Spectrum Analyzer	Rohde & Schwarz	FSP40	KMO-SZ003	May 27, 2014
Signal Generator	FLUKE	PM5418+Y/C	KMO-SZ020	May 27, 2014
Loop Antenna	Rohde & Schwarz	HFH2-Z2	KMO-SZ004	Jan. 30, 2014
Trilog-Super Broadband Antenna	SCHWARZBECK	VULB9161	KMO-SZ005	Sep.18, 2013
Trilog-Super Broadband Antenna	SCHWARZBECK	VULB9161	KMO-SZ006	Sep.18, 2013
Broad-Band Horn Antenna	SCHWARZBECK	BBHA 9120D	KMO-SZ007	Sep.18, 2013
Broad-Band Horn Antenna	SCHWARZBECK	BBHA 9120D	KMO-SZ008	Sep.18, 2013
AMN	Rohde & Schwarz	ESH3-Z5	KMO-SZ009	May 27, 2014
Pulse Limiter	SCHWARZBECK	VTSD 9561-F	KMO-SZ077	Nov.29, 2013
ISN	SCHWARZBECK	NTFM 8158 CAT3	KMO-SZ070	Nov.19, 2013
ISN	SCHWARZBECK	NTFM 8158 CAT5	KMO-SZ071	Nov.19, 2013
ISN	SCHWARZBECK	NTFM 8158 CAT6	KMO-SZ072	Nov.19, 2013
KMO Shielded Room	KMO	KMO-001	N/A	N/A
Coaxial Cable with N-Connectors	SCHWARZBECK	AK9515H	KMO-SZ037	Sep.18, 2013
SOHO Telephone Switching System	IKE	2000-108C	N/A	NCR
3m Anechoic Chamber	KMO	KMO-3AC	KMO-3AC-1	May 29, 2014
Temperature Chamber	TABAI	PSL-4GTW	N/A	Feb.10, 2014