

# Antenna Specification

## Specifications Summary

ITEM	SPEC.	
	<b>2.4GHz</b>	
Center Frequency	2402 MHz	2.61 dBi
	2442 MHz	2.66 dBi
	2484 MHz	3.22dBi
<b>MAX. GAIN</b>	<b>3.22 dBi</b>	

ITEM	SPEC.	
	<b>5 GHz</b>	
Center Frequency	5150 MHz	3.50 dBi
	5300 MHz	4.07 dBi
	5500 MHz	4.17 dBi
	5800 MHz	4.06 dBi
<b>MAX. GAIN</b>	<b>4.17 dBi</b>	

## Antenna Photo & Length

天线类型/  
ANT Type:

FPC

天线型号/  
ANT Model:

2.4G&5G ANT3

制造商/  
Manufacture:

YEALINK(XIAMEN) NETWORK TECHNOLOGY CO.,LTD.  
No.666 Hu'an Rd. Huli District Xiamen City, Fujian, P.R. China

天线尺寸/ANT Size

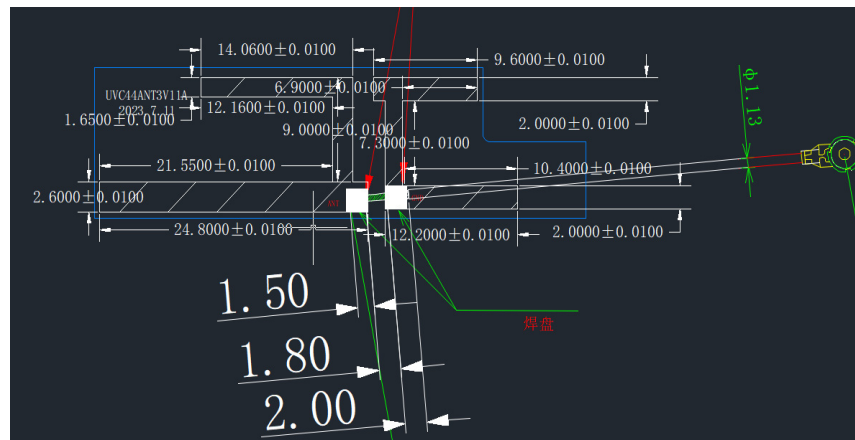

2402MHz

3D Antenna Pattern

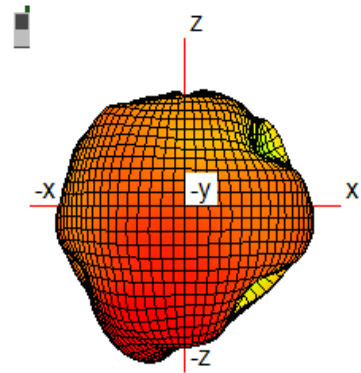

2D Antenna Pattern (X->Y;X->Z;Y->Z)

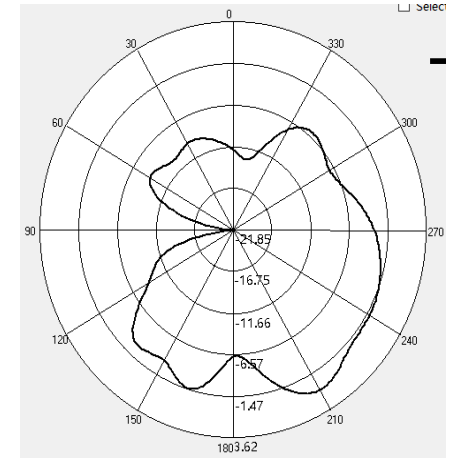
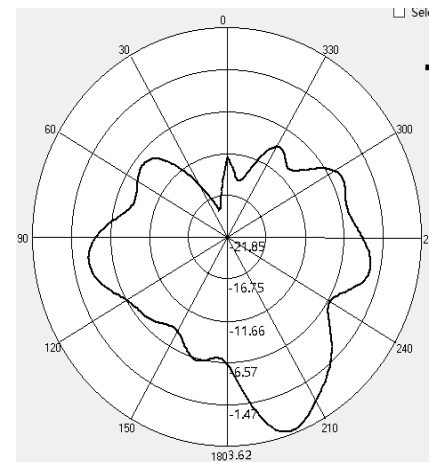
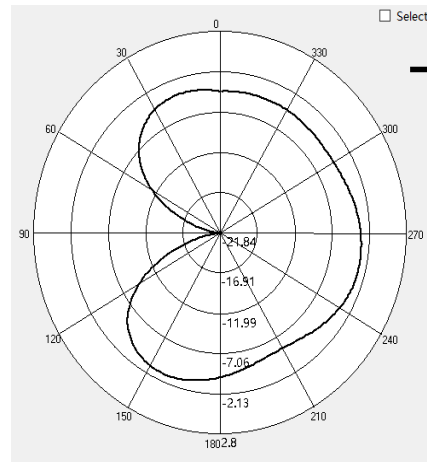

2442MHz

3D Antenna Pattern

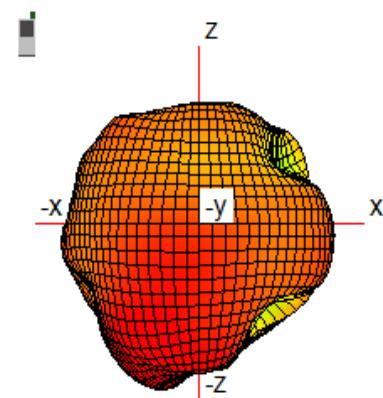

2D Antenna Pattern (X->Y;X->Z;Y->Z)

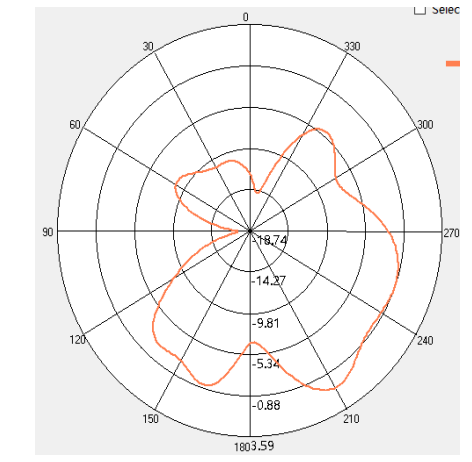
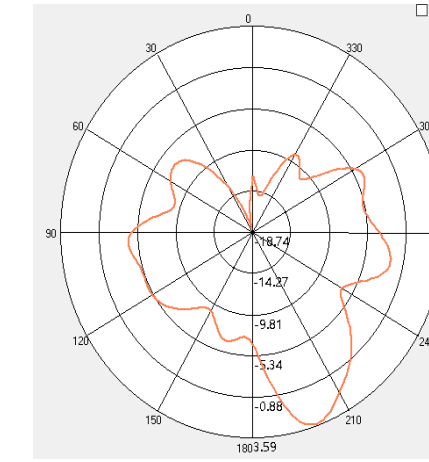
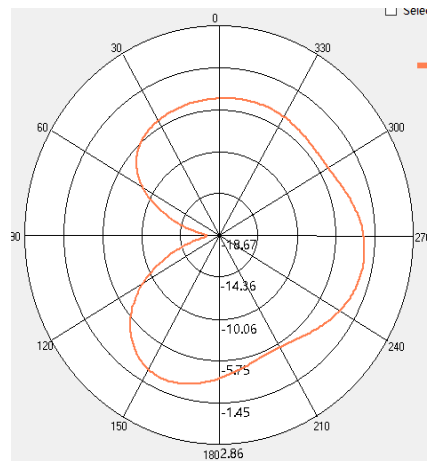

2484MHz

3D Antenna Pattern

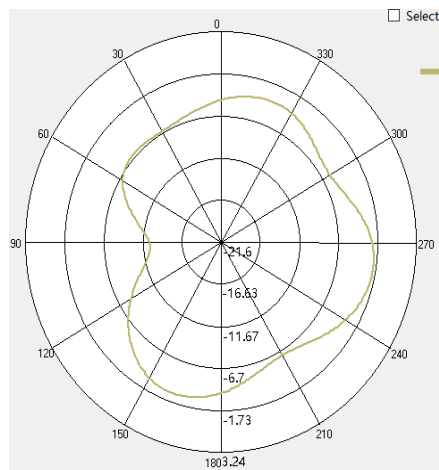
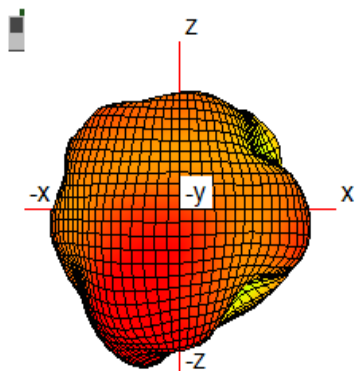

2D Antenna Pattern (X->Y;X->Z;Y->Z)

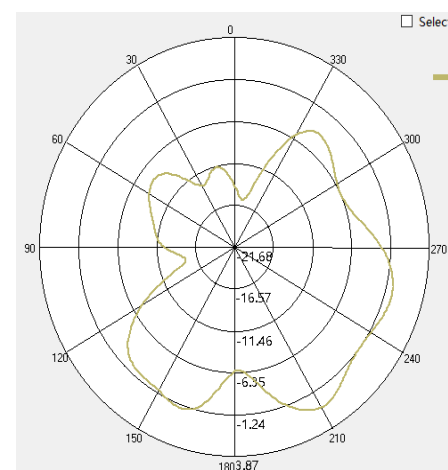
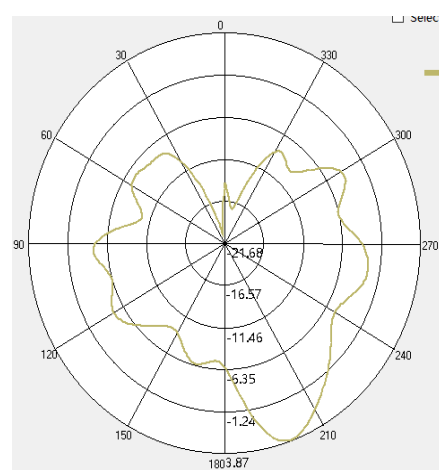

Point Values	Minimum Gain (dBi)	Maximum Gain (dBi)	Average Gain (dBi)
Frequency (MHz)			
2402	-21.8146	2.60963	-4.74139
2442	-18.6659	2.65654	-4.52752
2484	-21.5990	3.22460	-4.26703

5150MHz

3D Antenna Pattern

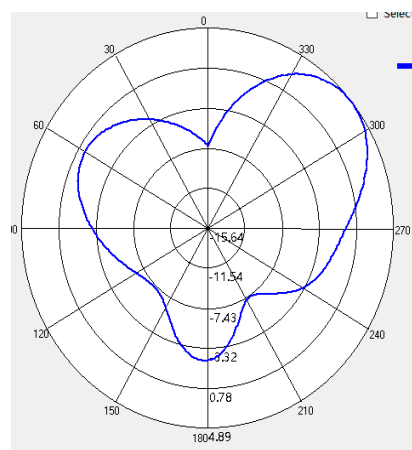
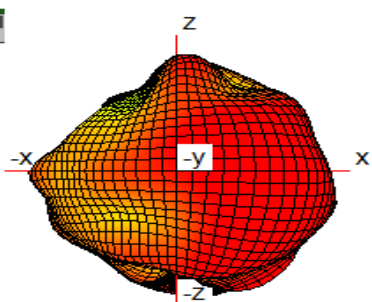

2D Antenna Pattern (X->Y;X->Z;Y->Z)

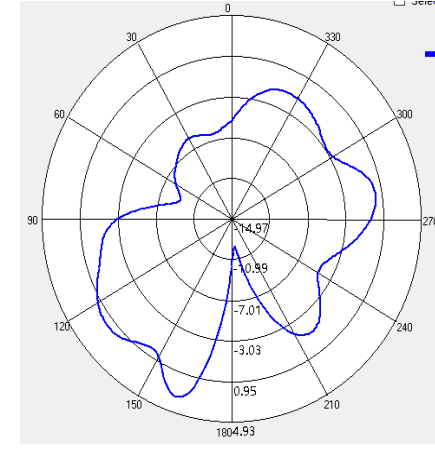
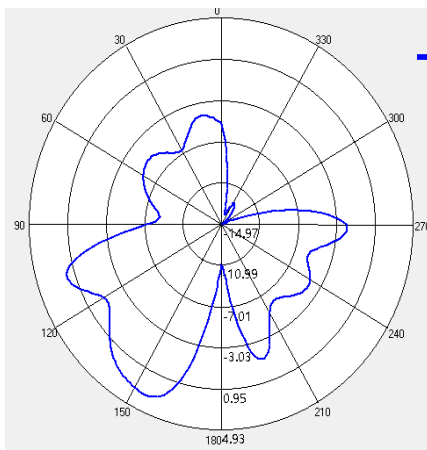

5300MHz

3D Antenna Pattern

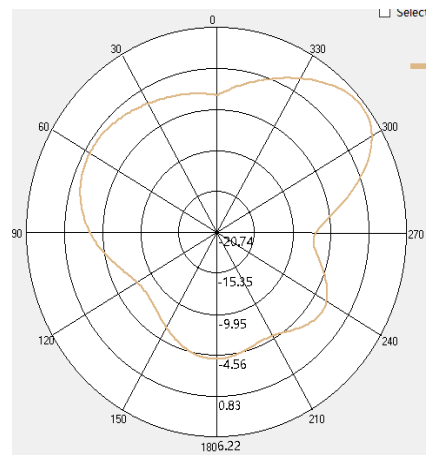
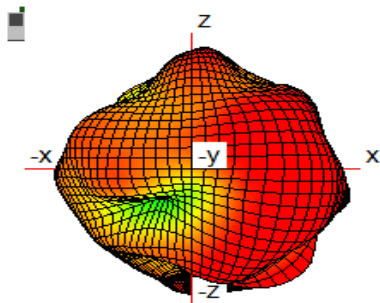

2D Antenna Pattern (X->Y; X->Z; Y->Z)

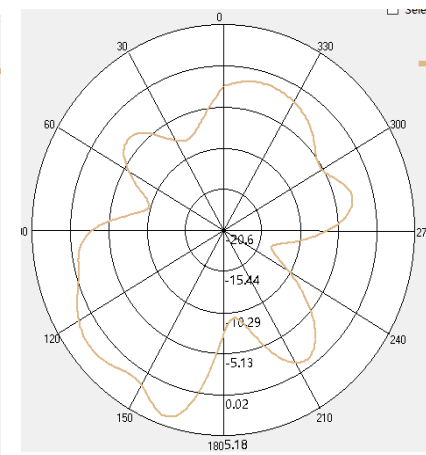
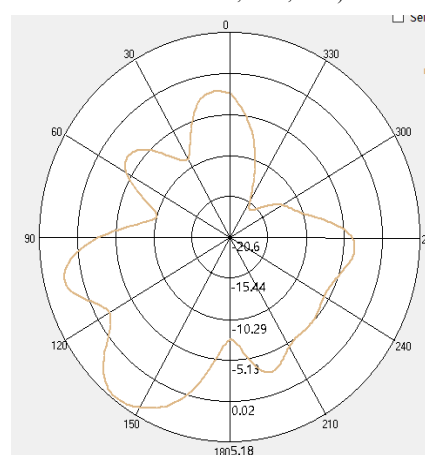

5500MHz

3D Antenna Pattern

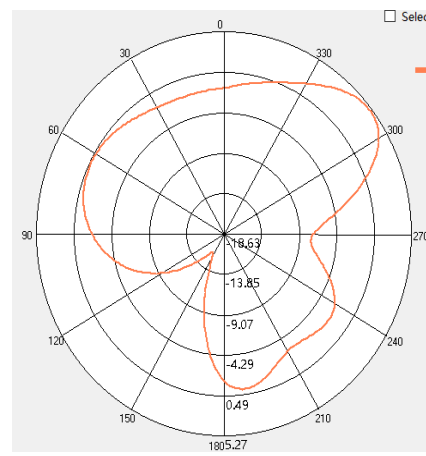
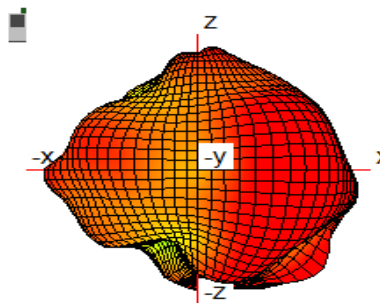

2D Antenna Pattern (X->Y; X->Z; Y->Z)

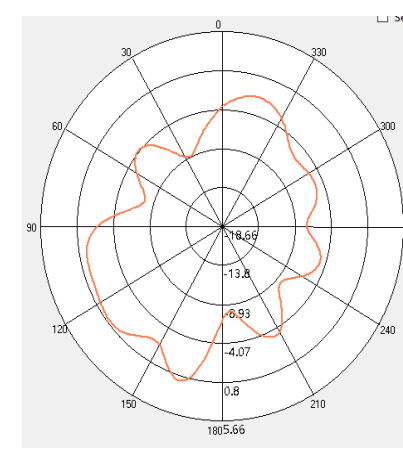

5800MHz

3D Antenna Pattern

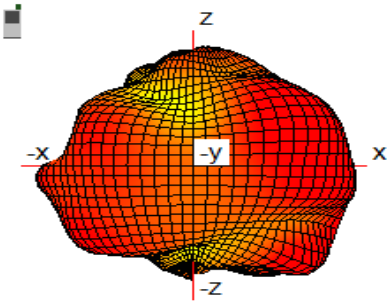

2D Antenna Pattern (X->Y; X->Z; Y->Z)

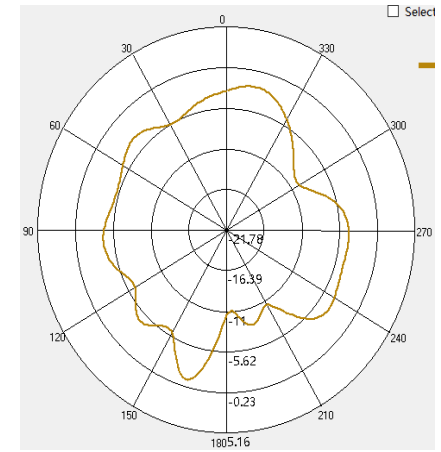
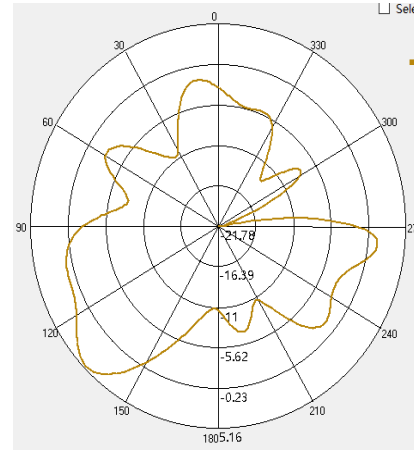
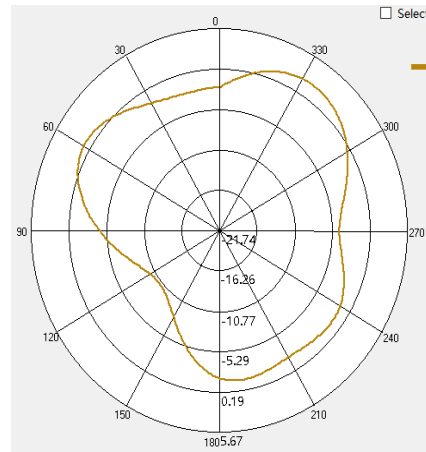

Point Values	Minimum Gain (dBi)	Maximum Gain (dBi)	Average Gain (dBi)
Frequency (MHz)			
5150	-14.8206	3.50211	-1.65558
5300	-20.5959	4.06944	-1.43717
5500	-18.6286	4.16515	-1.76720
5800	-21.7382	4.05745	-1.99530