



中认信通

CHINA CERTIFICATION ICT CO., LTD (DONGGUAN)



TEST REPORT

Applicant: YEALINK (XIAMEN) NETWORK TECHNOLOGY CO.,LTD.

Address: No.666 Hu'an Rd. Huli District Xiamen City, Fujian, P.R. China

FCC ID: T2C-OPSA001
IC: 10741A-OPSA001

HVIN: OPSA001

Product Name: Android OPS Module

Model Number: OPS-A001

Standard(s): 47 CFR Part 15, Subpart E(15.407)
RSS-247 Issue 2, February 2017
RSS-Gen, Issue 5, February 2021 Amendment 2
ANSI C63.10-2013
KDB 789033 D02 General U-NII Test Procedures New Rules v02r01

The above equipment has been tested and found compliant with the requirement of the relative standards by China Certification ICT Co., Ltd (Dongguan)

Report Number: CR221259082-00F

Date Of Issue: 2023/11/2

Reviewed By: Sun Zhong

Title: Manager

Sun Zhong

Test Laboratory: China Certification ICT Co., Ltd (Dongguan)

No. 113, Pingkang Road, Dalang Town, Dongguan,
Guangdong, China
Tel: +86-769-82016888

Test Facility

The Test site used by China Certification ICT Co., Ltd (Dongguan) to collect test data is located on the No. 113, Pingkang Road, Dalang Town, Dongguan, Guangdong, China.

The lab has been recognized as the FCC accredited lab under the KDB 974614 D01 and is listed in the FCC Public Access Link (PAL) database, FCC Registration No. : 442868, the FCC Designation No. : CN1314.

The lab has been recognized by Innovation, Science and Economic Development Canada to test to Canadian radio equipment requirements, the CAB identifier: CN0123.

Declarations

China Certification ICT Co., Ltd (Dongguan) is not responsible for the authenticity of any test data provided by the applicant. Data included from the applicant that may affect test results are marked with a triangle symbol “▲”. Customer model name, addresses, names, trademarks etc. are not considered data.

Unless otherwise stated the results shown in this test report refer only to the sample(s) tested.

This report cannot be reproduced except in full, without prior written approval of the Company.

This report is valid only with a valid digital signature. The digital signature may be available only under the Adobe software above version 7.0.

This report may contain data that are not covered by the accreditation scope and shall be marked with an asterisk “★”.

CONTENTS

DOCUMENT REVISION HISTORY	5
1. GENERAL INFORMATION	6
1.1 PRODUCT DESCRIPTION FOR EQUIPMENT UNDER TEST (EUT)	6
1.2 DESCRIPTION OF TEST CONFIGURATION.....	8
1.2.1 EUT Operation Condition:	8
1.2.2 Support Equipment List and Details	10
1.2.3 Support Cable List and Details	10
1.2.4 Block Diagram of Test Setup.....	11
1.3 MEASUREMENT UNCERTAINTY	12
2. SUMMARY OF TEST RESULTS	13
3. REQUIREMENTS AND TEST PROCEDURES	14
3.1 AC LINE CONDUCTED EMISSIONS.....	14
3.1.1 Applicable Standard.....	14
3.1.2 EUT Setup.....	15
3.1.3 EMI Test Receiver Setup	16
3.1.4 Test Procedure	16
3.1.5 Corrected Amplitude & Margin Calculation.....	16
3.2 RADIATION SPURIOUS EMISSIONS.....	17
3.2.1 Applicable Standard.....	17
3.2.2 EUT Setup.....	19
3.2.3 EMI Test Receiver & Spectrum Analyzer Setup	19
3.2.4 Test Procedure	20
3.2.5 Corrected Amplitude & Margin Calculation.....	20
3.3 26dB ATTENUATED BELOW THE CHANNEL POWER:.....	21
3.3.1 Applicable Standard.....	21
3.3.2 EUT Setup.....	21
3.3.3 Test Procedure	21
3.4 EMISSION BANDWIDTH:	22
3.4.1 Applicable Standard.....	22
3.4.2 EUT Setup.....	22
3.4.3 Test Procedure	22
3.5 MAXIMUM CONDUCTED OUTPUT POWER:	24
3.5.1 Applicable Standard.....	24
3.5.2 EUT Setup.....	25
3.5.3 Test Procedure	25
3.6 MAXIMUM POWER SPECTRAL DENSITY:	26
3.6.1 Applicable Standard.....	26
3.6.2 EUT Setup.....	27
3.6.3 Test Procedure	28
3.7 DUTY CYCLE:.....	28
3.7.1 EUT Setup.....	28
3.7.2 Test Procedure	28
3.8 TRANSMITTER FREQUENCY STABILITY	29

3.8.1 Applicable Standard.....	29
3.8.2 EUT Setup.....	29
3.8.3 Test Procedure	29
3.9 ANTENNA REQUIREMENT.....	31
3.9.1 Applicable Standard.....	31
3.9.2 Judgment.....	31
3.10 ADDITIONAL REQUIREMENT	32
3.10.1 Applicable Standard.....	32
3.10.2 JUDGMENT.....	33
4.Test DATA AND RESULTS.....	34
4.1 AC LINE CONDUCTED EMISSIONS.....	34
4.2 RADIATION SPURIOUS EMISSIONS.....	37
4.3 26dB ATTENUATED BELOW THE CHANNEL POWER:.....	61
4.4 EMISSION BANDWIDTH.....	68
4.5 MAXIMUM CONDUCTED OUTPUT POWER.....	101
4.6 MAXIMUM POWER SPECTRAL DENSITY	104
4.7 DUTY CYCLE	138
4.8 FREQUENCY STABILITY.....	140
5. RF EXPOSURE EVALUATION	143
5.1 MPE-BASED EXEMPTION.....	143
5.1.1 Applicable Standard.....	143
5.1.2 Measurement Result.....	144
5.2 EXEMPTION LIMITS FOR ROUTINE EVALUATION – RF EXPOSURE EVALUATION.....	145
5.2.1 Applicable Standard.....	145

DOCUMENT REVISION HISTORY

Revision Number	Report Number	Description of Revision	Date of Revision
1.0	CR221259082-00F	Original Report	2023/11/2

1. GENERAL INFORMATION

1.1 Product Description for Equipment under Test (EUT)

EUT Name:	Android OPS Module
EUT Model:	OPS-A001
Operation Frequency:	5180-5240 MHz (802.11a/n ht20) 5190-5230 MHz(802.11n ht40) 5260-5320 MHz (802.11a/n ht20) 5270-5310 MHz(802.11n ht40) 5500-5720 MHz (802.11a/n ht20) 5510-5710 MHz(802.11n ht40) 5745-5825 MHz (802.11a/n ht20) 5755-5795 MHz(802.11n ht40)
Maximum Average Output Power (Conducted):	16.79dBm (5150-5250 MHz) 17.67dBm (5250-5350 MHz) 18.68dBm (5470-5725 MHz) 18.38dBm (5725-5850 MHz)
Modulation Type:	OFDM-BPSK, QPSK, 16QAM, 64QAM
Rated Input Voltage:	24Vdc
Serial Number:	1TRF
EUT Received Date:	2022/12/14
EUT Received Status:	Good
Note: 5600-5650 MHz was disabled by software in Canada Market.	

1.1.2 Operation Frequency Detail:

For 802.11a/n ht20:

5150-5250MHz Band		5250-5350 MHz Band		5470-5725 MHz Band		5725-5850MHz Band	
Channel	Frequency (MHz)	Channel	Frequency (MHz)	Channel	Frequency (MHz)	Channel	Frequency (MHz)
36	5180	52	5260	100	5500	149	5745
40	5200	56	5280	104	5520	153	5765
44	5220	60	5300	108	5540	157	5785
48	5240	64	5320	112	5560	161	5805
/	/	/	/	116	5580	165	5825
/	/	/	/	120*	5600	/	/
/	/	/	/	124*	5620	/	/
/	/	/	/	128*	5640	/	/
/	/	/	/	132	5660	/	/
/	/	/	/	136	5680	/	/
/	/	/	/	140	5700	/	/
/	/	/	/	144	5720		

Note: the channels mark with * were in the range of 5600-5650 MHz disabled by software in Canada Market.

Per section 15.31(m)/RSS-Gen, the below frequencies were performed the test as below:

36	5180	52	5260	100	5500	149	5745
40	5200	56	5280	116	5580	157	5785
48	5240	64	5320	140	5700	165	5825
/	/	/	/	144	5720	/	/

For 802.11n ht40:

5150-5250MHz Band		5250-5350 MHz Band		5470-5725 MHz Band		5725-5850MHz Band	
Channel	Frequency (MHz)	Channel	Frequency (MHz)	Channel	Frequency (MHz)	Channel	Frequency (MHz)
38	5190	54	5270	102	5510	151	5755
46	5230	62	5310	110	5550	159	5795
/	/	/	/	118*	5590	/	/
/	/	/	/	126*	5630	/	/
/	/	/	/	134	5670	/	/
/	/	/	/	142	5710	/	/

Note: the channels mark with * were in the range of 5600-5650 MHz disabled by software in Canada Market.

Per section 15.31(m)/RSS-Gen, the below frequencies were performed the test as below:

38	5190	54	5270	102	5510	151	5755
46	5230	62	5310	110	5550	159	5795
/	/	/	/	134	5670	/	/
/	/	/	/	142	5710	/	/

1.1.3 Antenna Information Detail ▲ :

Antenna	Antenna Type	input impedance (Ohm)	Frequency Range	Antenna Gain	RSS-Gen Requirement
Chain 0	dipole	50	5150~5250 MHz	0.7 dBi	Compliance
			5250~5350 MHz	1.9 dBi	
			5470~5725 MHz	3 dBi	
			5725~5850 MHz	2.8 dBi	
Chain 1	dipole	50	5150~5250 MHz	0.7 dBi	
			5250~5350 MHz	1.9 dBi	
			5470~5725 MHz	3 dBi	
			5725~5850 MHz	2.8 dBi	

The Method of §15.203 Compliance:

- Antenna must be permanently attached to the unit.
 Antenna must use a unique type of connector to attach to the EUT.
 Unit must be professionally installed, and installer shall be responsible for verifying that the correct antenna is employed with the unit.

1.1.4 Accessory Information:

No.

1.2 Description of Test Configuration

1.2.1 EUT Operation Condition:

EUT Operation Mode:		The system was configured for testing in Engineering Mode, which was provided by the manufacturer.			
Equipment Modifications:		No			
EUT Exercise Software:		AuthenticationTool			
The software was provided by manufacturer. The maximum power was configured as below, that was provided by the manufacturer ▲ :					
5150-5250 MHz Band:					
Test Modes	Test Channels	Test Frequency (MHz)	Data rate	Power Level Setting	
				Chain 0	Chain 1
802.11a	Lowest	5180	6Mbps	16	16
	Middle	5200	6Mbps	16	16
	Highest	5240	6Mbps	16	16
802.11n ht20	Lowest	5180	MCS8	16	16
	Middle	5200	MCS8	16	16
	Highest	5240	MCS8	16	16
802.11n ht40	Lowest	5190	MCS8	14	14
	Highest	5230	MCS8	14	14
5250-5350 MHz Band:					
Test Modes	Test Channels	Test Frequency (MHz)	Data rate	Power Level Setting	
				Chain 0	Chain 1
802.11a	Lowest	5260	6Mbps	16	16
	Middle	5280	6Mbps	16	16
	Highest	5320	6Mbps	16	16
802.11n ht20	Lowest	5260	MCS8	16	16
	Middle	5280	MCS8	16	16
	Highest	5320	MCS8	16	16
802.11n ht40	Lowest	5270	MCS8	16	16
	Highest	5310	MCS8	13	13

5470-5725 MHz Band:					
Test Modes	Test Channels	Test Frequency	Data rate	Power Level Setting	
				Chain 0	Chain 1
802.11a	Lowest	5500	6Mbps	16	16
	Middle	5580	6Mbps	16	16
	Highest	5700	6Mbps	16	16
	Cross	5720	6Mbps	16	16
802.11n ht20	Lowest	5500	MCS8	16	16
	Middle	5580	MCS8	16	16
	Highest	5700	MCS8	15	15
	Cross	5720	MCS8	15	15
802.11n ht40	Lowest	5510	MCS8	15	15
	Middle	5550	MCS8	15	15
	Highest	5670	MCS8	14	14
	Cross	5710	MCS8	14	14
5725-5850 MHz Band:					
Test Modes	Test Channels	Test Frequency	Data rate	Power Level Setting	
				Chain 0	Chain 1
802.11a	Lowest	5745	6Mbps	16	16
	Middle	5785	6Mbps	16	16
	Highest	5825	6Mbps	16	16
802.11n ht20	Lowest	5745	MCS8	16	16
	Middle	5785	MCS8	16	16
	Highest	5825	MCS8	16	16
802.11n ht40	Lowest	5755	MCS8	16	16
	Highest	5795	MCS8	16	16
Note:					
1. The device supports SISO in all modes, and MIMO 2T2R in 802.11n modes, per pretest, 2T2Rmode was the worst mode and reported for 802.11n modes.					
2. The above are the worst-case data rates, which are determined for each mode based upon investigations by measuring the average power and PSD across all data rates, bandwidths, and modulations.					

1.2.2 Support Equipment List and Details

Manufacturer	Description	Model	Serial Number
Lenovo	Laptop	T460S	60PDTEK8
Yealink	Collaboration Board	MeetingBoard 86	1QHS
TOTO LINK	Router	X5000R	X5000RK9T0560

1.2.3 Support Cable List and Details

Cable Description	Shielding Type	Ferrite Core	Length (m)	From Port	To
Power Cable	No	No	1.5	Collaboration Board	LISN
RJ45 Cable	No	No	3	EUT	Router
USB Cable	No	No	1.5	EUT	Laptop
HDMI Cable	No	No	1.5	EUT	Laptop

1.2.4 Block Diagram of Test Setup

AC line conducted emissions:

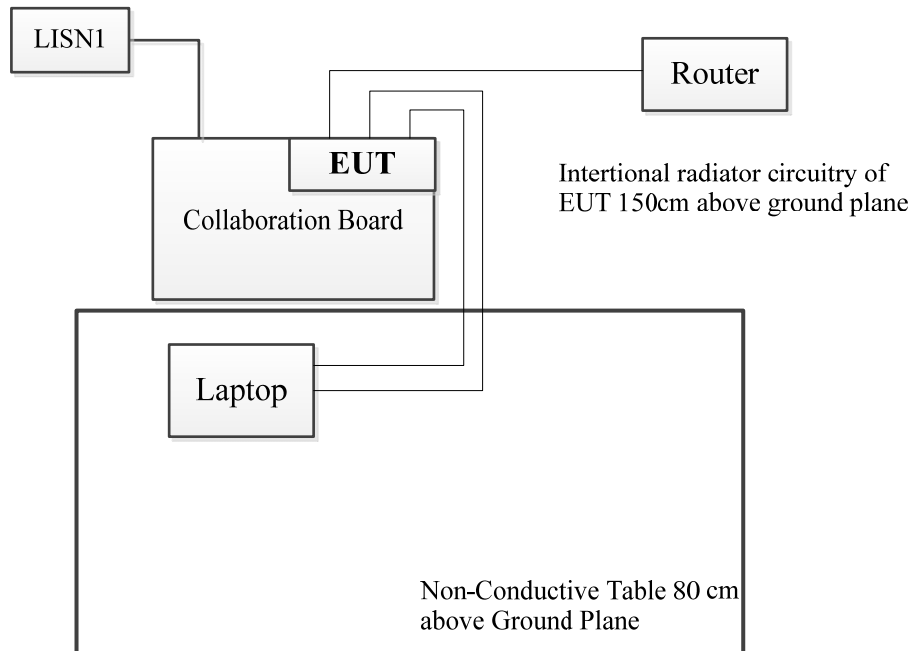

Spurious Emissions:

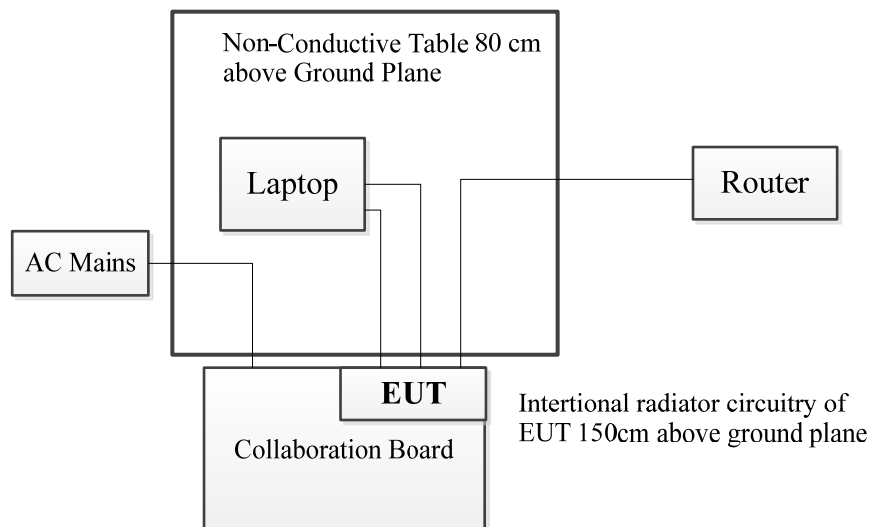

1.3 Measurement Uncertainty

Otherwise required by the applicant or Product Regulations, Decision Rule in this report did not consider the uncertainty. The extended uncertainty given in this report is obtained by combining the standard uncertainty times the coverage factor K with the 95% confidence interval.

Parameter	Measurement Uncertainty
Occupied Channel Bandwidth	±5 %
RF output power, conducted	±0.61dB
Power Spectral Density, conducted	±0.61 dB
Unwanted Emissions, radiated	30M~200MHz: 4.15 dB,200M~1GHz: 5.61 dB,1G~6GHz: 5.14 dB, 6G~18GHz: 5.93 dB,18G~26.5G:5.47 dB,26.5G~40G:5.63 dB
Unwanted Emissions, conducted	±1.26 dB
Temperature	±1 °C
Humidity	±5%
DC and low frequency voltages	±0.4%
Duty Cycle	1%
AC Power Lines Conducted Emission	2.8 dB (150 kHz to 30 MHz)

2. SUMMARY OF TEST RESULTS

Standard(s) Section	Test Items	Result
§15.207(a) RSS-Gen Clause 8.8	AC line conducted emissions	Compliant
FCC§15.205& §15.209 &§15.407(b) RSS-247 Clause 6.2	Undesirable Emission& Restricted Bands	Compliant
RSS-247 Clause 6.2.1.2	26dB attenuated below the channel power	Compliant
FCC§15.407(a) (e) RSS-247 Clause 6.2 RSS-Gen Clause 6.7	Emission Bandwidth	Compliant
FCC§15.407(a) RSS-247 Clause 6.2	Maximum Conducted Output Power	Compliant
FCC§15.407 (a) RSS-247 Clause 6.2	Power Spectral Density	Compliant
RSS-GEN Clause 6.11	Frequency Stability	Compliant
§15.203 RSS-Gen Clause 6.8	Antenna Requirement	Compliant
RSS-247 Clause 6.4	Additional requirements	Compliant
FCC §1.1307 RSS-102 Clause 2.5.2	RF Exposure Evaluation	Compliant

3. REQUIREMENTS AND TEST PROCEDURES

3.1 AC Line Conducted Emissions

3.1.1 Applicable Standard

FCC§15.207(a).

(a) Except as shown in paragraphs (b) and (c) of this section, for an intentional radiator that is designed to be connected to the public utility (AC) power line, the radio frequency voltage that is conducted back onto the AC power line on any frequency or frequencies, within the band 150 kHz to 30 MHz, shall not exceed the limits in the following table, as measured using a 50 μ H/50 ohms line impedance stabilization network (LISN). Compliance with the provisions of this paragraph shall be based on the measurement of the radio frequency voltage between each power line and ground at the power terminal. The lower limit applies at the boundary between the frequency ranges.

Frequency of emission (MHz)	Conducted limit (dB μ V)	
	Quasi-peak	Average
0.15-0.5	66 to 56*	56 to 46*
0.5-5	56	46
5-30	60	50

*Decreases with the logarithm of the frequency.

(b) The limit shown in paragraph (a) of this section shall not apply to carrier current systems operating as intentional radiators on frequencies below 30 MHz. In lieu thereof, these carrier current systems shall be subject to the following standards:

(1) For carrier current system containing their fundamental emission within the frequency band 535-1705 kHz and intended to be received using a standard AM broadcast receiver: no limit on conducted emissions.

(2) For all other carrier current systems: 1000 μ V within the frequency band 535-1705 kHz, as measured using a 50 μ H/50 ohms LISN.

(3) Carrier current systems operating below 30 MHz are also subject to the radiated emission limits in §15.205, §15.209, §15.221, §15.223, or §15.227, as appropriate.

(c) Measurements to demonstrate compliance with the conducted limits are not required for devices which only employ battery power for operation and which do not operate from the AC power lines or contain provisions for operation while connected to the AC power lines. Devices that include, or make provisions for, the use of battery chargers which permit operating while charging, AC adapters or battery eliminators or that connect to the AC power lines indirectly, obtaining their power through another device which is connected to the AC power lines, shall be tested to demonstrate compliance with the conducted limits.

RSS-Gen Clause 8.8

Unless stated otherwise in the applicable RSS, for radio apparatus that are designed to be connected to the public utility AC power network, the radio frequency voltage that is conducted back onto the AC power line on any frequency or frequencies within the range 150 kHz to 30 MHz shall not exceed the limits in table 4, as measured using a 50 μ H / 50 Ω line impedance stabilization network. This requirement applies for the radio frequency voltage measured between each power line and the ground terminal of each AC power-line mains cable of the EUT.

For an EUT that connects to the AC power lines indirectly, through another device, the requirement for compliance with the limits in table 4 shall apply at the terminals of the AC power-line mains cable of a representative support device, while it provides power to the EUT. The lower limit applies at the

boundary between the frequency ranges. The device used to power the EUT shall be representative of typical applications.

Table 4 – AC power-line conducted emissions limits

Frequency (MHz)	Conducted limit (dB μ V)	
	Quasi-peak	Average
0.15 - 0.5	66 to 56 ¹	56 to 46 ¹
0.5 – 5	56	46
5 – 30	60	50

Note 1: The level decreases linearly with the logarithm of the frequency.

For an EUT with a permanent or detachable antenna operating between 150 kHz and 30 MHz, the AC power-line conducted emissions must be measured using the following configurations:

(a) Perform the AC power-line conducted emissions test with the antenna connected to determine compliance with the limits of table 4 outside the transmitter's fundamental emission band.

(b) Retest with a dummy load instead of the antenna to determine compliance with the limits of table 4 within the transmitter's fundamental emission band. For a detachable antenna, remove the antenna and connect a suitable dummy load to the antenna connector. For a permanent antenna, remove the antenna and terminate the RF output with a dummy load or network that simulates the antenna in the fundamental frequency band.

3.1.2 EUT Setup

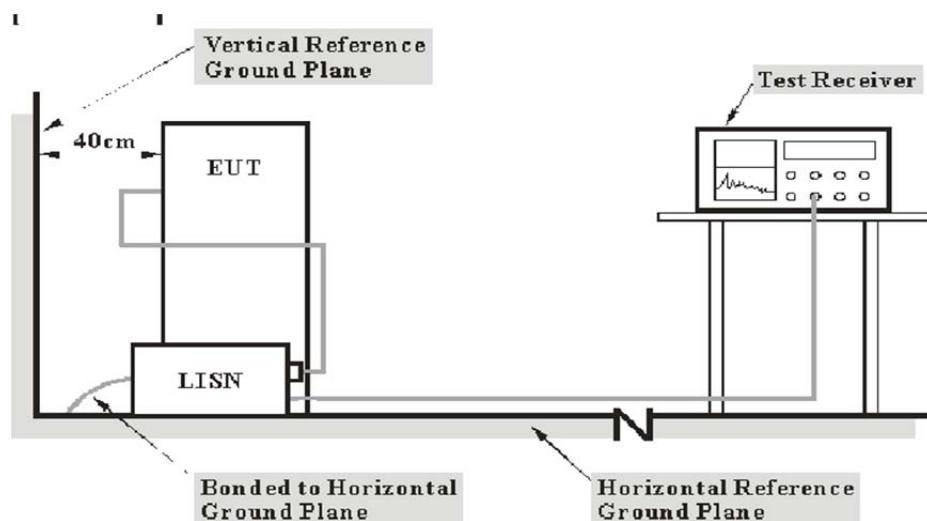

- Note: 1. Support units were connected to second LISN.
 2. Both of LISNs (AMN) 80 cm from EUT and at the least 80 cm from other units and other metal planes support units.

The setup of EUT is according with per ANSI C63.10-2013 measurement procedure. The specification used was with the FCC Part 15.207,RSS-Genlimits.

The spacing between the peripherals was 10cm.

The adapter or EUT was connected to the main LISN with a 120 V/60 Hz AC power source.

3.1.3 EMI Test Receiver Setup

The EMI test receiver was set to investigate the spectrum from 150 kHz to 30MHz.

During the conducted emission test, the EMI test receiver was set with the following configurations:

Frequency Range	IF B/W
150 kHz – 30 MHz	9 kHz

3.1.4 Test Procedure

The frequency and amplitude of the six highest ac power-line conducted emissions relative to the limit, measured over all the current-carrying conductors of the EUT power cords, and the operating frequency or frequency to which the EUT is tuned (if appropriate), should be reported, unless such emissions are more than 20 dB below the limit. AC power-line conducted emissions measurements are to be separately carried out only on each of the phase (“hot”) line(s) and (if used) on the neutral line(s), but not on the ground [protective earth] line(s). If less than six emission frequencies are within 20 dB of the limit, then the noise level of the measuring instrument at representative frequencies should be reported. The specific conductor of the power-line cord for each of the reported emissions should be identified. Measure the six highest emissions with respect to the limit on each current-carrying conductor of each power cord associated with the EUT (but not the power cords of associated or peripheral equipment that are part of the test configuration). Then, report the six highest emissions with respect to the limit from among all the measurements identifying the frequency and specific current-carrying conductor identified with the emission. The six highest emissions should be reported for each of the current-carrying conductors, or the six highest emissions may be reported over all the current-carrying conductors.

3.1.5 Corrected Amplitude & Margin Calculation

The basic equation is as follows:

Result = Reading + Factor

Factor = attenuation caused by cable loss + voltage division factor of AMN

The “**Margin**” column of the following data tables indicates the degree of compliance within the applicable limit. The equation for margin calculation is as follows:

Margin = Limit – Result

3.2 Radiation Spurious Emissions

3.2.1 Applicable Standard

FCC §15.407 (b);

Undesirable emission limits. Except as shown in paragraph (b)(7) of this section, the maximum emissions outside of the frequency bands of operation shall be attenuated in accordance with the following limits:

(1) For transmitters operating in the 5.15-5.25 GHz band: All emissions outside of the 5.15-5.35 GHz band shall not exceed an e.i.r.p. of -27 dBm/MHz.

(2) For transmitters operating in the 5.25-5.35 GHz band: All emissions outside of the 5.15-5.35 GHz band shall not exceed an e.i.r.p. of -27 dBm/MHz.

(3) For transmitters operating in the 5.47-5.725 GHz band: All emissions outside of the 5.47-5.725 GHz band shall not exceed an e.i.r.p. of -27 dBm/MHz.

(4) For transmitters operating solely in the 5.725-5.850 GHz band:

(i) All emissions shall be limited to a level of -27 dBm/MHz at 75 MHz or more above or below the band edge increasing linearly to 10 dBm/MHz at 25 MHz above or below the band edge, and from 25 MHz above or below the band edge increasing linearly to a level of 15.6 dBm/MHz at 5 MHz above or below the band edge, and from 5 MHz above or below the band edge increasing linearly to a level of 27 dBm/MHz at the band edge.

(ii) Devices certified before March 2, 2017 with antenna gain greater than 10 dBi may demonstrate compliance with the emission limits in § 15.247(d), but manufacturing, marketing and importing of devices certified under this alternative must cease by March 2, 2018. Devices certified before March 2, 2018 with antenna gain of 10 dBi or less may demonstrate compliance with the emission limits in § 15.247(d), but manufacturing, marketing and importing of devices certified under this alternative must cease before March 2, 2020.

(8) The emission measurements shall be performed using a minimum resolution bandwidth of 1 MHz. A lower resolution bandwidth may be employed near the band edge, when necessary, provided the measured energy is integrated to show the total power over 1 MHz.

(9) Unwanted emissions below 1 GHz must comply with the general field strength limits set forth in § 15.209. Further, any U-NII devices using an AC power line are required to comply also with the conducted limits set forth in § 15.207.

(10) The provisions of § 15.205 apply to intentional radiators operating under this section.

(11) When measuring the emission limits, the nominal carrier frequency shall be adjusted as close to the upper and lower frequency band edges as the design of the equipment permits.

(c) The device shall automatically discontinue transmission in case of either absence of information to transmit or operational failure. These provisions are not intended to preclude the transmission of control or signalling information or the use of repetitive codes used by certain digital technologies to complete frame or burst intervals. Applicants shall include in their application for equipment authorization a description of how this requirement is met.

RSS-247 Clause 6.2.1.2 Unwanted emission limits in Frequency band 5150-5250 MHz

For transmitters with operating frequencies in the band 5150-5250 MHz, all emissions outside the band 5150-5350 MHz shall not exceed -27 dBm/MHz e.i.r.p. Any unwanted emissions that fall into the band 5250-5350 MHz shall be attenuated below the channel power by at least 26 dB, when measured using a resolution bandwidth between 1 and 5% of the occupied bandwidth (i.e. 99% bandwidth), above 5250 MHz. The 26 dB bandwidth may fall into the 5250-5350 MHz band; however, if the occupied bandwidth also falls within the 5250-5350 MHz band, the transmission is considered as intentional and the devices shall comply with all requirements in the band 5250-5350 MHz including implementing dynamic frequency selection (DFS) and TPC, on the portion of the emission that resides in the 5250-5350 MHz band.

RSS-247 Clause 6.2.2.2 Unwanted emission limits in Frequency band 5250-5350 MHz

Devices shall comply with the following:

- a) All emissions outside the band 5250-5350 MHz shall not exceed -27 dBm/MHz e.i.r.p.; or
- b) All emissions outside the band 5150-5350 MHz shall not exceed -27 dBm/MHz e.i.r.p. and its power shall comply with the spectral power density for operation within the band 5150-5250 MHz. The device, except devices installed in vehicles, shall be labelled or include in the user manual the following text “for indoor use only.”

RSS-247 Clause 6.2.3.2 Unwanted emission limits in Frequency band 5470-5600 MHz and 5650-5725 MHz

Emissions outside the band 5470-5600 MHz and 5650-5725 MHz shall not exceed -27 dBm/MHz e.i.r.p. However, devices with bandwidth overlapping the band edge of 5725 MHz can meet the emission limit of -27 dBm/MHz e.i.r.p. at 5850 MHz instead of 5725 MHz.

RSS-247 Clause 6.2.4.2 Unwanted emission limits in Frequency band 5725-5850 MHz

Devices operating in the band 5725-5850 MHz with antenna gain greater than 10 dBi can have unwanted emissions that comply with either the limits in this section or in section 5.5 until six (6) months after the publication date of this standard for certification. Certified devices that do not comply with emission limits in this section shall not be manufactured, imported, distributed, leased, offered for sale or sold after April 1, 2018.

Devices operating in the band 5725-5850 MHz with antenna gain of 10 dBi or less can have unwanted emissions that comply with either the limits in this section or in section 5.5 until April 1, 2018 for certification. Certified devices that do not comply with emission limits in this section shall not be manufactured, imported, distributed, leased, offered for sale or sold after April 1, 2020.

Devices operating in the band 5725-5850 MHz shall have e.i.r.p. of unwanted emissions comply with the following:

- a) 27 dBm/MHz at frequencies from the band edges decreasing linearly to 15.6 dBm/MHz at 5 MHz above or below the band edges;
- b) 15.6 dBm/MHz at 5 MHz above or below the band edges decreasing linearly to 10 dBm/MHz at 25 MHz above or below the band edges;
- c) 10 dBm/MHz at 25 MHz above or below the band edges decreasing linearly to -27 dBm/MHz at 75 MHz above or below the band edges; and
- d) -27 dBm/MHz at frequencies more than 75 MHz above or below the band edges.

3.2.2 EUT Setup

Below 1GHz:

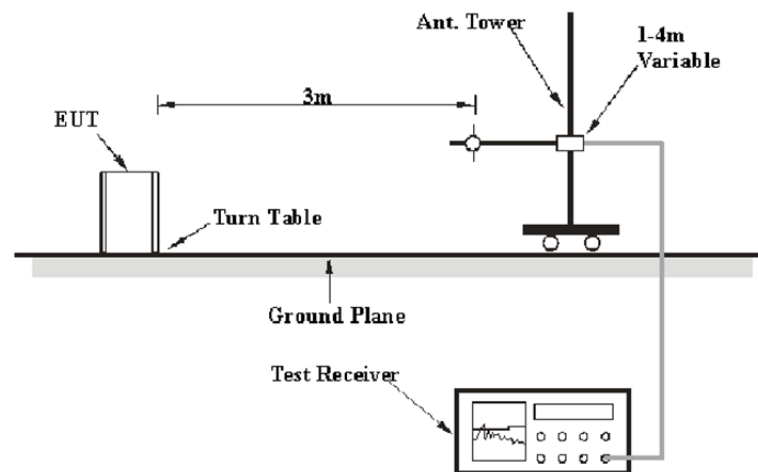

1-40 GHz:

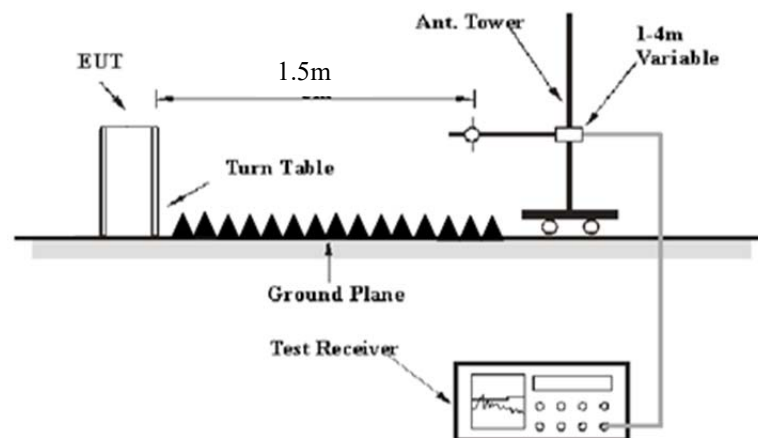

The radiated emission tests were performed in the 3 meters chamber test site, using the setup accordance with the ANSI C63.10-2013. The specification used was FCC 15.209, FCC 15.407, RSS-247, RSS-Gen limits.

The external I/O cables were draped along the test table and formed a bundle 30 to 40cm long in the middle.

The spacing between the peripherals was 10cm.

3.2.3 EMI Test Receiver & Spectrum Analyzer Setup

The system was investigated from 30 MHz to 40 GHz.

During the radiated emission test, the EMI test receiver & Spectrum Analyzer Setup were set with the following configurations:

30-1000MHz:

Detector	RBW	Video B/W	IF B/W
QP	120 kHz	300 kHz	120kHz

1GHz- 40GHz:

Measurement	Duty cycle	RBW	Video B/W
PK	Any	1MHz	3 MHz
AV	>98%	1MHz	10 Hz
	<98%	1MHz	1/T

Note: T is minimum transmission duration

If the maximized peakmeasured value complies with under theQP/Average limit more than 6dB, then it is unnecessary to perform an QP/Average measurement.

3.2.4 Test Procedure

During the radiated emission test, the adapter was connected to the first AC floor outlet.

Data was recorded in Quasi-peak detection mode for frequency range of 30 MHz-1GHz, peak and Average detection modes for frequencies above 1GHz.

According to KDB 789033 D02 General UNII Test Procedures New Rules v02r01, emission shall be computed as: $E [dB\mu V/m] = EIRP[dBm] + 95.2$, for $d = 3$ meters.

According to C63.10, the above 1G test result shall be extrapolated to the specified distance using an extrapolation Factor of 20dB/decade from 3m to 1.5m

Distance extrapolation Factor = $20 \log (\text{specific distance } [3m]/\text{test distance } [1.5m])$ dB= 6.02 dB

All emissions under the average limit and under the noise floor have not recorded in the report.

3.2.5 Corrected Amplitude & Margin Calculation

The basic equation is as follows:

Factor= Antenna Factor + Cable Loss-Amplifier Gain

For 30MHz-1GHz:

Result = Reading + Factor

For 1GHz-40GHz

Result = Reading + Factor-Distance extrapolation Factor

The “**Margin**” column of the following data tables indicates the degree of compliance within the applicable limit. The equation for margin calculation is as follows:

Margin = Limit – Result

3.3 26dB Attenuated below the channel power:

3.3.1 Applicable Standard

RSS-247 Clause 6.2.1.2

For transmitters with operating frequencies in the band 5150-5250 MHz, all emissions outside the band 5150-5350 MHz shall not exceed -27 dBm/MHz e.i.r.p. Any unwanted emissions that fall into the band 5250-5350 MHz shall be attenuated below the channel power by at least 26 dB, when measured using a resolution bandwidth between 1 and 5% of the occupied bandwidth (i.e. 99% bandwidth), above 5250 MHz. The 26 dB bandwidth may fall into the 5250-5350 MHz band; however, if the occupied bandwidth also falls within the 5250-5350 MHz band, the transmission is considered as intentional and the devices shall comply with all requirements in the band 5250-5350 MHz including implementing dynamic frequency selection (DFS) and TPC, on the portion of the emission that resides in the 5250-5350 MHz band.

3.3.2 EUT Setup

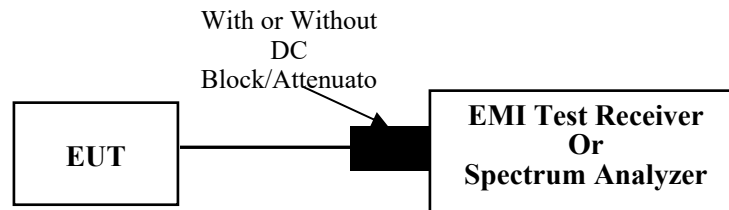

3.3.3 Test Procedure

- a) Set RBW = 1%~5% of the emission bandwidth.
- b) Set the VBW > RBW.
- c) Detector = peak.
- d) Trace mode = max hold
- e) Measure the emission attenuated below the channel power

3.4 Emission Bandwidth:

3.4.1 Applicable Standard

FCC §15.407 (a),(h)

(h)(2) Radar Detection Function of Dynamic Frequency Selection (DFS). U-NII devices operating with any part of its 26 dB emission bandwidth in the 5.25-5.35 GHz and 5.47-5.725 GHz bands shall employ a DFS radar detection mechanism to detect the presence of radar systems and to avoid co-channel operation with radar systems.

FCC §15.407 (e)

Within the 5.725-5.850 GHz and 5.850-5.895 GHz bands, the minimum 6 dB bandwidth of U-NII devices shall be at least 500 kHz.

RSS-247 Clause 6.2.1.2

For transmitters with operating frequencies in the band 5150-5250 MHz, all emissions outside the band 5150-5350 MHz shall not exceed -27 dBm/MHz e.i.r.p. Any unwanted emissions that fall into the band 5250-5350 MHz shall be attenuated below the channel power by at least 26 dB, when measured using a resolution bandwidth between 1 and 5% of the occupied bandwidth (i.e. 99% bandwidth), above 5250 MHz. The 26 dB bandwidth may fall into the 5250-5350 MHz band; however, if the occupied bandwidth also falls within the 5250-5350 MHz band, the transmission is considered as intentional and the devices shall comply with all requirements in the band 5250-5350 MHz including implementing dynamic frequency selection (DFS) and TPC, on the portion of the emission that resides in the 5250-5350 MHz band.

RSS-247 Clause 6.2.4.1

For equipment operating in the band 5725-5850 MHz, the minimum 6 dB bandwidth shall be at least 500 kHz.

3.4.2 EUT Setup

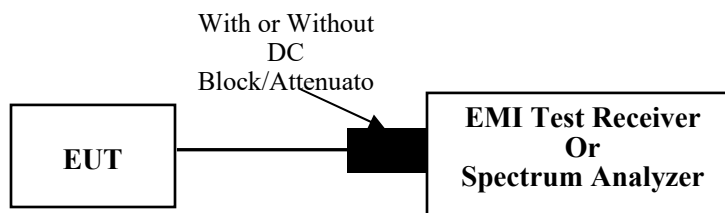

3.4.3 Test Procedure

26dB Emission Bandwidth:

According to ANSI C63.10-2013 Section 12.4.1

- a) Set RBW = approximately 1% of the emission bandwidth.
- b) Set the VBW > RBW.
- c) Detector = peak.
- d) Trace mode = max hold
- e) Measure the maximum width of the emission that is 26 dB down from the peak of the emission. Compare this with the RBW setting of the instrument. Readjust RBW and repeat measurement as needed until the RBW/EBW ratio is approximately 1%.

99% Occupied Bandwidth:

According to ANSI C63.10-2013 Section 12.4.2&6.9.3

The occupied bandwidth is the frequency bandwidth such that, below its lower and above its upper frequency limits, the mean powers are each equal to 0.5% of the total mean power of the given emission. The following procedure shall be used for measuring 99% power bandwidth:

- a) The instrument center frequency is set to the nominal EUT channel center frequency. The frequency span for the spectrum analyzer shall be between 1.5 times and 5.0 times the OBW.
- b) The nominal IF filter bandwidth (3 dB RBW) shall be in the range of 1% to 5% of the OBW, and VBW shall be approximately three times the RBW, unless otherwise specified by the applicable requirement.
- c) Set the reference level of the instrument as required, keeping the signal from exceeding the maximum input mixer level for linear operation. In general, the peak of the spectral envelope shall be more than $[10 \log (OBW/RBW)]$ below the reference level. Specific guidance is given in 4.1.5.2.
- d) Step a) through step c) might require iteration to adjust within the specified range.
- e) Video averaging is not permitted. Where practical, a sample detection and single sweep mode shall be used. Otherwise, peak detection and max hold mode (until the trace stabilizes) shall be used.
- f) Use the 99% power bandwidth function of the instrument (if available) and report the measured bandwidth.
- g) If the instrument does not have a 99% power bandwidth function, then the trace data points are recovered and directly summed in linear power terms. The recovered amplitude data points, beginning at the lowest frequency, are placed in a running sum until 0.5% of the total is reached; that frequency is recorded as the lower frequency. The process is repeated until 99.5% of the total is reached; that frequency is recorded as the upper frequency. The 99% power bandwidth is the difference between these two frequencies.
- h) The occupied bandwidth shall be reported by providing plot(s) of the measuring instrument display; the plot axes and the scale units per division shall be clearly labeled. Tabular data may be reported in addition to the plot(s).

6 dB emission bandwidth:

According to KDB 789033 D02 General UNII Test Procedures New Rules v02r01

- a) Set RBW = 100 kHz.
- b) Set the video bandwidth (VBW) ≥ 3 RBW.
- c) Detector = Peak.
- d) Trace mode = max hold.
- e) Sweep = auto couple.
- f) Allow the trace to stabilize.
- g) Measure the maximum width of the emission that is constrained by the frequencies associated with the two outermost amplitude points (upper and lower frequencies) that are attenuated by 6 dB relative to the maximum level measured in the fundamental emission.

Note: The automatic bandwidth measurement capability of a spectrum analyzer or EMI receiver may be employed if it implements the functionality described in this section. For devices that use channel aggregation refer to III.A and III.C for determining emission bandwidth.

3.5 Maximum Conducted Output Power:

3.5.1 Applicable Standard

FCC §15.407(a)(1)(iv)

For client devices in the 5.15-5.25 GHz band, the maximum conducted output power over the frequency band of operation shall not exceed 250 mW provided the maximum antenna gain does not exceed 6 dBi. In addition, the maximum power spectral density shall not exceed 11 dBm in any 1 megahertz band. If transmitting antennas of directional gain greater than 6 dBi are used, both the maximum conducted output power and the maximum power spectral density shall be reduced by the amount in dB that the directional gain of the antenna exceeds 6 dBi.

FCC §15.407(a)(2)

For the 5.25-5.35 GHz and 5.47-5.725 GHz bands, the maximum conducted output power over the frequency bands of operation shall not exceed the lesser of 250 mW or $11 \text{ dBm} + 10 \log B$, where B is the 26 dB emission bandwidth in megahertz. In addition, the maximum power spectral density shall not exceed 11 dBm in any 1 megahertz band. If transmitting antennas of directional gain greater than 6 dBi are used, both the maximum conducted output power and the maximum power spectral density shall be reduced by the amount in dB that the directional gain of the antenna exceeds 6 dBi.

FCC §15.407(a)(3)(i)

For the band 5.725-5.850 GHz, the maximum conducted output power over the frequency band of operation shall not exceed 1 W. In addition, the maximum power spectral density shall not exceed 30 dBm in any 500-kHz band. If transmitting antennas of directional gain greater than 6 dBi are used, both the maximum conducted output power and the maximum power spectral density shall be reduced by the amount in dB that the directional gain of the antenna exceeds 6 dBi. However, fixed point-to-point U-NII devices operating in this band may employ transmitting antennas with directional gain greater than 6 dBi without any corresponding reduction in transmitter conducted power. Fixed, point-to-point operations exclude the use of point-to-multipoint systems, omnidirectional applications, and multiple collocated transmitters transmitting the same information. The operator of the U-NII device, or if the equipment is professionally installed, the installer, is responsible for ensuring that systems employing high gain directional antennas are used exclusively for fixed, point-to-point operations.

RSS-247 Clause 6.2.1.1

For OEM devices installed in vehicles, the maximum e.i.r.p. shall not exceed 30 mW or $1.76 + 10 \log_{10} B$, dBm, whichever is less stringent. Devices shall implement transmitter power control (TPC) in order to have the capability to operate at least 3 dB below the maximum permitted e.i.r.p. of 30 mW.

For other devices, the maximum e.i.r.p. shall not exceed 200 mW or $10 + 10 \log_{10} B$, dBm, whichever power is less. B is the 99% emission bandwidth in megahertz. The e.i.r.p. spectral density shall not exceed 10 dBm in any 1.0 MHz band.

RSS-247 Clause 6.2.2.1

Devices, other than devices installed in vehicles, shall comply with the following:

a) The maximum conducted output power shall not exceed 250 mW or $11 + 10 \log_{10} B$, dBm, whichever is less. The power spectral density shall not exceed 11 dBm in any 1.0 MHz band;

b) The maximum e.i.r.p. shall not exceed 1.0 W or $17 + 10 \log_{10}B$, dBm, whichever is less. B is the 99% emission bandwidth in megahertz. Note that devices with a maximum e.i.r.p. greater than 500 mW shall implement TPC in order to have the capability to operate at least 6 dB below the maximum permitted e.i.r.p. of 1 W.

RSS-247 Clause 6.2.3.1

The maximum conducted output power shall not exceed 250 mW or $11 + 10 \log_{10}B$, dBm, whichever is less. The power spectral density shall not exceed 11 dBm in any 1.0 MHz band.

The maximum e.i.r.p. shall not exceed 1.0 W or $17 + 10 \log_{10}B$, dBm, whichever is less. B is the 99% emission bandwidth in megahertz. Note that devices with a maximum e.i.r.p. greater than 500 mW shall implement TPC in order to have the capability to operate at least 6 dB below the maximum permitted e.i.r.p. of 1 W.

RSS-247 Clause 6.2.4.1

The maximum conducted output power shall not exceed 1 W. The output power spectral density shall not exceed 30 dBm in any 500 kHz band. If transmitting antennas of directional gain greater than 6 dBi are used, both the maximum conducted output power and the output power spectral density shall be reduced by the amount in dB that the directional gain of the antenna exceeds 6 dBi. However, fixed point-to-point devices operating in this band may employ transmitting antennas with directional gain greater than 6 dBi without any corresponding reduction in transmitter conducted power. Fixed point-to-point operations exclude the use of point-to-multipoint systems, omnidirectional applications and multiple collocated transmitters transmitting the same information.

3.5.2 EUT Setup

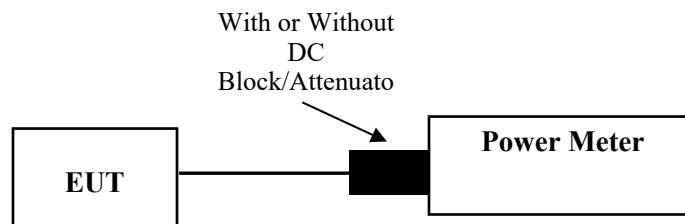

3.5.3 Test Procedure

According to ANSI C63.10-2013 Section 12.3.3.2

Method PM-G is measurement using a gated RF average power meter. Measurements may be performed using a wideband gated RF power meter provided that the gate parameters are adjusted such that the power is measured only when the EUT is transmitting at its maximum power control level. Because the measurement is made only during the ON time of the transmitter, no duty cycle correction factor is required.

3.6 Maximum power spectral density:

3.6.1 Applicable Standard

FCC §15.407(a)(1)(iv)

For client devices in the 5.15-5.25 GHz band, the maximum conducted output power over the frequency band of operation shall not exceed 250 mW provided the maximum antenna gain does not exceed 6 dBi. In addition, the maximum power spectral density shall not exceed 11 dBm in any 1 megahertz band. If transmitting antennas of directional gain greater than 6 dBi are used, both the maximum conducted output power and the maximum power spectral density shall be reduced by the amount in dB that the directional gain of the antenna exceeds 6 dBi.

FCC §15.407(a)(2)

For the 5.25-5.35 GHz and 5.47-5.725 GHz bands, the maximum conducted output power over the frequency bands of operation shall not exceed the lesser of 250 mW or $11 \text{ dBm} + 10 \log B$, where B is the 26 dB emission bandwidth in megahertz. In addition, the maximum power spectral density shall not exceed 11 dBm in any 1 megahertz band. If transmitting antennas of directional gain greater than 6 dBi are used, both the maximum conducted output power and the maximum power spectral density shall be reduced by the amount in dB that the directional gain of the antenna exceeds 6 dBi.

FCC §15.407(a)(3)(i)

For the band 5.725-5.850 GHz, the maximum conducted output power over the frequency band of operation shall not exceed 1 W. In addition, the maximum power spectral density shall not exceed 30 dBm in any 500-kHz band. If transmitting antennas of directional gain greater than 6 dBi are used, both the maximum conducted output power and the maximum power spectral density shall be reduced by the amount in dB that the directional gain of the antenna exceeds 6 dBi. However, fixed point-to-point U-NII devices operating in this band may employ transmitting antennas with directional gain greater than 6 dBi without any corresponding reduction in transmitter conducted power. Fixed, point-to-point operations exclude the use of point-to-multipoint systems, omnidirectional applications, and multiple collocated transmitters transmitting the same information. The operator of the U-NII device, or if the equipment is professionally installed, the installer, is responsible for ensuring that systems employing high gain directional antennas are used exclusively for fixed, point-to-point operations.

RSS-247 Clause 6.2.1.1

For OEM devices installed in vehicles, the maximum e.i.r.p. shall not exceed 30 mW or $1.76 + 10 \log_{10} B$, dBm, whichever is less stringent. Devices shall implement transmitter power control (TPC) in order to have the capability to operate at least 3 dB below the maximum permitted e.i.r.p. of 30 mW.

For other devices, the maximum e.i.r.p. shall not exceed 200 mW or $10 + 10 \log_{10} B$, dBm, whichever power is less. B is the 99% emission bandwidth in megahertz. The e.i.r.p. spectral density shall not exceed 10 dBm in any 1.0 MHz band.

RSS-247 Clause 6.2.2.1

Devices, other than devices installed in vehicles, shall comply with the following:

- a) The maximum conducted output power shall not exceed 250 mW or $11 + 10 \log_{10} B$, dBm, whichever is less. The power spectral density shall not exceed 11 dBm in any 1.0 MHz band;

b) The maximum e.i.r.p. shall not exceed 1.0 W or $17 + 10 \log_{10}B$, dBm, whichever is less. B is the 99% emission bandwidth in megahertz. Note that devices with a maximum e.i.r.p. greater than 500 mW shall implement TPC in order to have the capability to operate at least 6 dB below the maximum permitted e.i.r.p. of 1 W.

RSS-247 Clause 6.2.3.1

The maximum conducted output power shall not exceed 250 mW or $11 + 10 \log_{10}B$, dBm, whichever is less. The power spectral density shall not exceed 11 dBm in any 1.0 MHz band.

The maximum e.i.r.p. shall not exceed 1.0 W or $17 + 10 \log_{10}B$, dBm, whichever is less. B is the 99% emission bandwidth in megahertz. Note that devices with a maximum e.i.r.p. greater than 500 mW shall implement TPC in order to have the capability to operate at least 6 dB below the maximum permitted e.i.r.p. of 1 W.

RSS-247 Clause 6.2.4.1

The maximum conducted output power shall not exceed 1 W. The output power spectral density shall not exceed 30 dBm in any 500 kHz band. If transmitting antennas of directional gain greater than 6 dBi are used, both the maximum conducted output power and the output power spectral density shall be reduced by the amount in dB that the directional gain of the antenna exceeds 6 dBi. However, fixed point-to-point devices operating in this band may employ transmitting antennas with directional gain greater than 6 dBi without any corresponding reduction in transmitter conducted power. Fixed point-to-point operations exclude the use of point-to-multipoint systems, omnidirectional applications and multiple collocated transmitters transmitting the same information.

3.6.2 EUT Setup

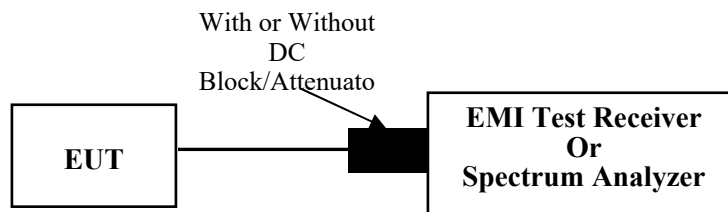

3.6.3 Test Procedure

According to KDB 789033 D02 General UNII Test Procedures New Rules v02r01

Duty cycle $\geq 98\%$

KDB 789033 D02 General UNII Test Procedures New Rules v02r01 Method SA-1 should be applied.

Duty cycle $< 98\%$, duty cycle variations are less than $\pm 2\%$

KDB 789033 D02 General UNII Test Procedures New Rules v02r01 Method SA-2 should be applied.

Duty cycle $< 98\%$, duty cycle variations exceed $\pm 2\%$

KDB 789033 D02 General UNII Test Procedures New Rules v02r01 Method SA-3 should be applied.

3.7 Duty Cycle:

3.7.1 EUT Setup

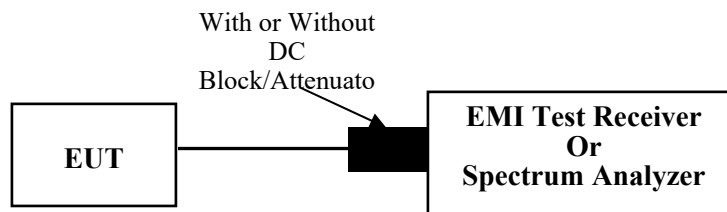

3.7.2 Test Procedure

According to ANSI C63.10-2013 Section 12.2

The zero-span mode on a spectrum analyzer or EMI receiver if the response time and spacing between bins on the sweep are sufficient to permit accurate measurements of the ON and OFF times of the transmitted signal:

- 1) Set the center frequency of the instrument to the center frequency of the transmission.
- 2) Set $RBW \geq OBW$ if possible; otherwise, set RBW to the largest available value.
- 3) Set $VBW \geq RBW$. Set detector = peak or average.
- 4) The zero-span measurement method shall not be used unless both RBW and VBW are $> 50/T$ and the number of sweep points across duration T exceeds 100. (For example, if VBW and/or RBW are limited to 3 MHz, then the zero-span method of measuring the duty cycle shall not be used if $T \leq 16.7 \mu s$.)

3.8 Transmitter frequency stability

3.8.1 Applicable Standard

RSS-Gen Clause 8.11

If the frequency stability of the licence-exempt radio apparatus is not specified in the applicable RSS, the fundamental emissions of the radio apparatus should be kept within at least the central 80% of its permitted operating frequency band in order to minimize the possibility of out-of-band operation. In addition, its occupied bandwidth shall be entirely outside the restricted bands and the prohibited TV bands of 54-72 MHz, 76-88 MHz, 174-216 MHz, and 470-602 MHz, unless otherwise indicated.

3.8.2 EUT Setup

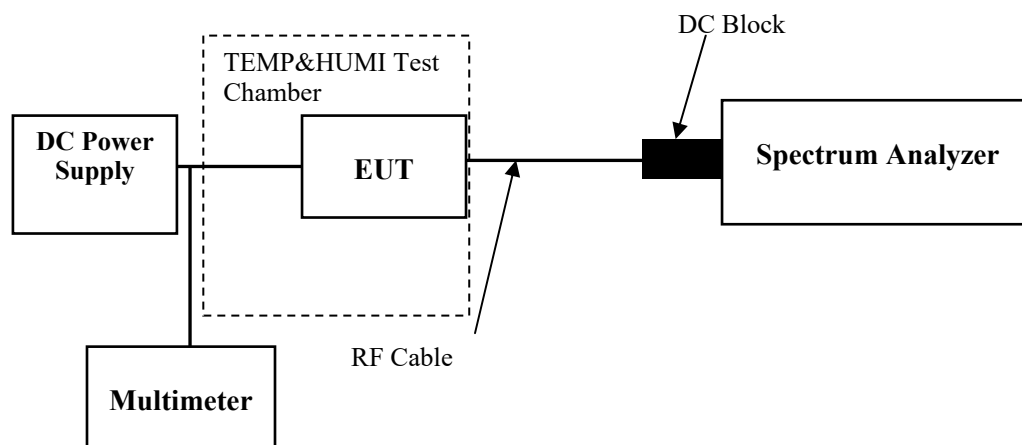

3.8.3 Test Procedure

According to ANSI C63.10-2013 Section 6.8

Frequency stability with respect to ambient temperature

- Supply the EUT with a nominal ac voltage or install a new or fully charged battery in the EUT. If possible, a dummy load shall be connected to the EUT because an antenna near the metallic walls of an environmental test chamber could affect the output frequency of the EUT. If the EUT is equipped with a permanently attached, adjustable-length antenna, then the EUT shall be placed in the center of the chamber with the antenna adjusted to the shortest length possible. Turn ON the EUT and tune it to one of the number of frequencies shown in 5.6.
- Couple the unlicensed wireless device output to the measuring instrument by connecting an antenna to the measuring instrument with a suitable length of coaxial cable and placing the measuring antenna near the EUT (e.g., 15 cm away), or by connecting a dummy load to the measuring instrument, through an attenuator if necessary.

NOTE—An instrument that has an adequate level of accuracy as specified by the procuring or regulatory agency is the recommended measuring instrument.

- Adjust the location of the measurement antenna and the controls on the measurement instrument to obtain a suitable signal level (i.e., a level that will not overload the measurement instrument but is strong enough to allow measurement of the operating or fundamental frequency of the EUT).

- d) Turn the EUT OFF and place it inside the environmental temperature chamber. For devices that have oscillator heaters, energize only the heater circuit.
- e) Set the temperature control on the chamber to the highest specified in the regulatory requirements for the type of device and allow the oscillator heater and the chamber temperature to stabilize.
- f) While maintaining a constant temperature inside the environmental chamber, turn the EUT ON and record the operating frequency at startup, and at 2 minutes, 5 minutes, and 10 minutes after the EUT is energized. Four measurements in total are made.
- g) Measure the frequency at each of frequencies specified in 5.6.
- h) Switch OFF the EUT but do not switch OFF the oscillator heater.
- i) Lower the chamber temperature by not more than 10 °C, and allow the temperature inside the chamber to stabilize.
- j) Repeat step f) through step i) down to the lowest specified temperature.

Frequency stability when varying supply voltage

Unless otherwise specified, these tests shall be made at ambient room temperature (+15 °C to +25 °C). An antenna shall be connected to the antenna output terminals of the EUT if possible. If the EUT is equipped with or uses an adjustable-length antenna, then it shall be fully extended.

- a) Supply the EUT with nominal voltage or install a new or fully charged battery in the EUT. Turn ON the EUT and couple its output to a frequency counter or other frequency-measuring instrument.
NOTE—An instrument that has an adequate level of accuracy as specified by the procuring or regulatory agency is the recommended measuring instrument.
- b) Tune the EUT to one of the number of frequencies required in 5.6. Adjust the location of the measurement antenna and the controls on the measurement instrument to obtain a suitable signal level (i.e., a level that will not overload the measurement instrument but is strong enough to allow measurement of the operating or fundamental frequency of the EUT).
- c) Measure the frequency at each of the frequencies specified in 5.6.
- d) Repeat the above procedure at 85% and 115% of the nominal supply voltage as described in 5.13.

3.9 Antenna Requirement

3.9.1 Applicable Standard

FCC §15.203

An intentional radiator shall be designed to ensure that no antenna other than that furnished by the responsible party shall be used with the device. The use of a permanently attached antenna or of an antenna that uses a unique coupling to the intentional radiator shall be considered sufficient to comply with the provisions of this section. The manufacturer may design the unit so that a broken antenna can be replaced by the user, but the use of a standard antenna jack or electrical connector is prohibited. This requirement does not apply to carrier current devices or to devices operated under the provisions of §§15.211, 15.213, 15.217, 15.219, 15.221, or §15.236. Further, this requirement does not apply to intentional radiators that must be professionally installed, such as perimeter protection systems and some field disturbance sensors, or to other intentional radiators which, in accordance with §15.31(d), must be measured at the installation site. However, the installer shall be responsible for ensuring that the proper antenna is employed so that the limits in this part are not exceeded.

RSS-GEN Clause 6.8

The applicant for equipment certification shall provide a list of all antenna types that may be used with the transmitter, where applicable (i.e. for transmitters with detachable antenna), indicating the maximum permissible antenna gain (in dBi) and the required impedance for each antenna. The test report shall demonstrate the compliance of the transmitter with the limit for maximum equivalent isotropically radiated power (e.i.r.p.) specified in the applicable RSS, when the transmitter is equipped with any antenna type, selected from this list.

For expediting the testing, measurements may be performed using only the antenna with highest gain of each combination of transmitter and antenna type, with the transmitter output power set at the maximum level. However, the transmitter shall comply with the applicable requirements under all operational conditions and when in combination with any type of antenna from the list provided in the test report (and in the notice to be included in the user manual, provided below).

When measurements at the antenna port are used to determine the RF output power, the effective gain of the device's antenna shall be stated, based on a measurement or on data from the antenna's manufacturer.

The test report shall state the RF power, output power setting and spurious emission measurements with each antenna type that is used with the transmitter being tested.

For licence-exempt equipment with detachable antennas, the user manual shall also contain the following notice in a conspicuous location:

This radio transmitter [enter the device's ISED certification number] has been approved by Innovation, Science and Economic Development Canada to operate with the antenna types listed below, with the maximum permissible gain indicated. Antenna types not included in this list that have a gain greater than the maximum gain indicated for any type listed are strictly prohibited for use with this device.

Immediately following the above notice, the manufacturer shall provide a list of all antenna types which can be used with the transmitter, indicating the maximum permissible antenna gain (in dBi) and the required impedance for each antenna type.

3.9.2 Judgment

Result: Compliant. Please refer to the Antenna Information detail in Section 1.

3.10 Additional requirement

3.10.1 Applicable Standard

According to RSS-247 Clause 6.4 Additional requirement

The following requirements shall apply:

- a) The device shall automatically discontinue transmission in cases of absence of information to transmit, or operational failure. A description on how this is done shall accompany the application for equipment certification. Note that this is not intended to prohibit transmission of control or signalling information or the use of repetitive codes where required by the technology.
- b) All LE-LAN devices must contain security features to protect against modification of software by unauthorized parties.

Manufacturers must implement security features in any digitally modulated devices capable of operating in any of the frequency ranges within the 5 GHz band, so that third parties are not able to reprogram the device to operate outside the parameters for which the device was certified. The software must prevent the user from operating the transmitter with operating frequencies, output power, modulation types or other radio frequency parameters outside those that were approved for the device. Manufacturers may use various means, including the use of a private network that allows only authenticated users to download software, electronic signatures in software or coding in hardware that is decoded by software to verify that new software can be legally loaded into a device to meet these requirements and must describe the methods in their application for equipment certification.

Manufacturers must take steps to ensure that DFS functionality cannot be disabled by the operator of the LE-LAN device.

- c) The user manual for LE-LAN devices shall contain instructions related to the restrictions mentioned in the above sections, namely that:
 - i. the device for operation in the band 5150–5250 MHz is only for indoor use to reduce the potential for harmful interference to co-channel mobile satellite systems;⁴
 - ii. for devices with detachable antenna(s), the maximum antenna gain permitted for devices in the bands 5250-5350 MHz and 5470-5725 MHz shall be such that the equipment still complies with the e.i.r.p. limit;
 - iii. for devices with detachable antenna(s), the maximum antenna gain permitted for devices in the band 5725-5850 MHz shall be such that the equipment still complies with the e.i.r.p. limits as appropriate; and
 - iv. where applicable, antenna type(s), antenna models(s), and worst-case tilt angle(s) necessary to remain compliant with the e.i.r.p. elevation mask requirement set forth in section 6.2.2.3 shall be clearly indicated.

3.10.2 Judgment

RSS-247 Clause 6.4 a):

The device shall automatically discontinue transmission in cases of absence of information to transmit, or operational failure. Please refer to the declaration

RSS-247 Clause 6.4 b):

The devices must contain security features to protect against modification of software by unauthorized parties. Please refer to the declaration

RSS-247 Clause 6.4 c):

i). The device operates on 5150-5250MHz is only for indoor use.

ii). The device operates on 5250-5350MHz/5470-5725MHz complies with the e.i.r.p. limit.

iii). The antenna is detachable, and all the EIPR compliance with RSS-247 requirement. Please refer to the conducted output power test result.

iv). Not Applicable.

4. Test DATA AND RESULTS

4.1 AC Line Conducted Emissions

Serial Number:	1TRF	Test Date:	2022/12/20
Test Site:	CE	Test Mode:	Transmitting (maximum output power mode (802.11n ht20 5580MHz))
Tester:	Vic Du	Test Result:	Pass

Environmental Conditions:					
Temperature: (°C)	18.9	Relative Humidity: (%)	40	ATM Pressure: (kPa)	101.4

Test Equipment List and Details:

Manufacturer	Description	Model	Serial Number	Calibration Date	Calibration Due Date
R&S	LISN	ENV216	101134	2022/04/01	2023/03/31
R&S	EMI Test Receiver	ESR3	102726	2022/07/15	2023/07/14
MICRO-COAX	Coaxial Cable	UTIFLEX	C-0200-01	2022/08/07	2023/08/06
Audix	Test Software	E3	190306 (V9)	N/A	N/A

* Statement of Traceability: China Certification ICT Co., Ltd (Dongguan) attests that all calibrations have been performed, traceable to National Primary Standards and International System of Units (SI).

Test Mode: Transmitting
 Port: Line
 Note:

Date: 2022-12-20

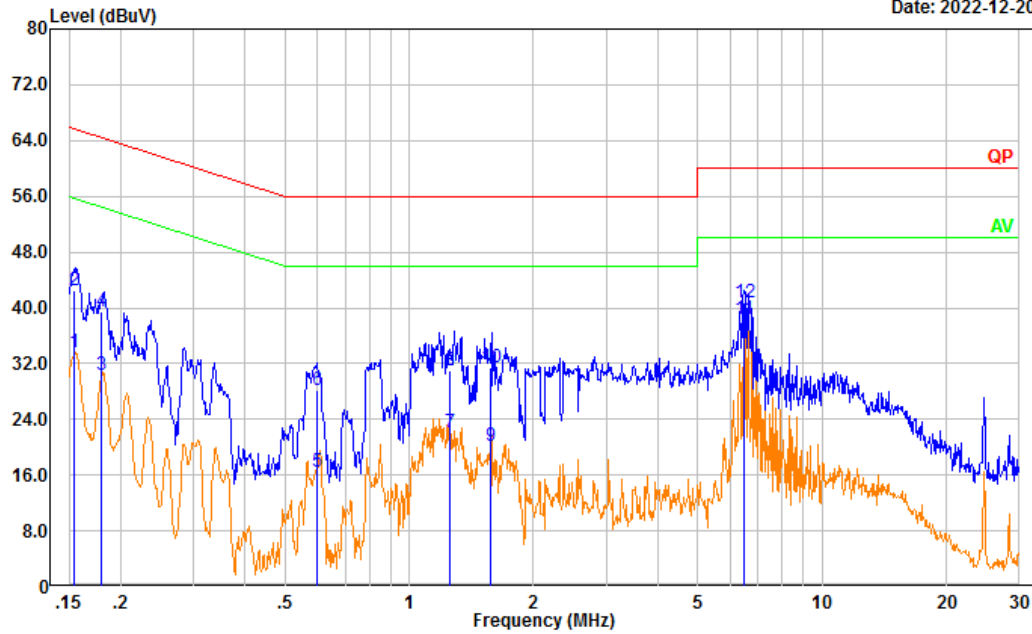

No.	Frequency (MHz)	Reading (dBμV)	Factor (dB)	Result (dBμV)	Limit (dBμV)	Margin (dB)	Detector
1	0.155	23.90	9.61	33.51	55.73	22.22	Average
2	0.155	32.83	9.61	42.44	65.73	23.29	QP
3	0.180	20.65	9.61	30.26	54.48	24.22	Average
4	0.180	29.74	9.61	39.35	64.48	25.13	QP
5	0.596	6.80	9.62	16.42	46.00	29.58	Average
6	0.596	18.52	9.62	28.14	56.00	27.86	QP
7	1.251	12.56	9.62	22.18	46.00	23.82	Average
8	1.251	21.48	9.62	31.10	56.00	24.90	QP
9	1.579	10.51	9.63	20.14	46.00	25.86	Average
10	1.579	21.91	9.63	31.54	56.00	24.46	QP
11	6.453	28.77	9.66	38.43	50.00	11.57	Average
12	6.453	31.00	9.66	40.66	60.00	19.34	QP

Test Mode: Transmitting
 Port: neutral
 Note:

Date: 2022-12-20

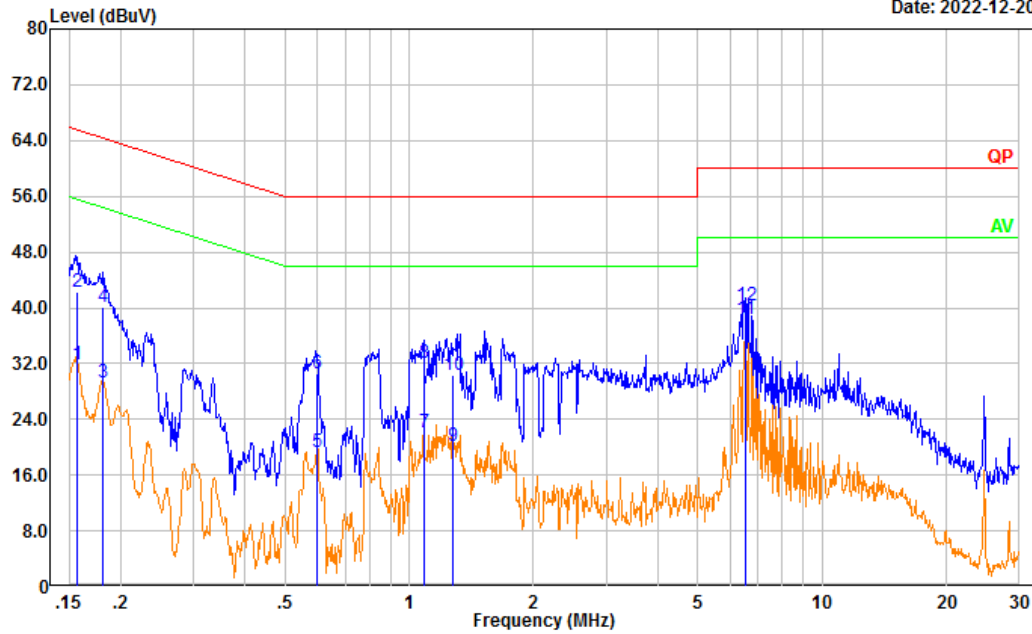

No.	Frequency (MHz)	Reading (dBμV)	Factor (dB)	Result (dBμV)	Limit (dBμV)	Margin (dB)	Detector
1	0.157	22.17	9.61	31.78	55.62	23.84	Average
2	0.157	32.65	9.61	42.26	65.62	23.36	QP
3	0.181	19.67	9.61	29.28	54.46	25.18	Average
4	0.181	30.43	9.61	40.04	64.46	24.42	QP
5	0.598	9.77	9.62	19.39	46.00	26.61	Average
6	0.598	21.05	9.62	30.67	56.00	25.33	QP
7	1.085	12.46	9.62	22.08	46.00	23.92	Average
8	1.085	22.37	9.62	31.99	56.00	24.01	QP
9	1.279	10.47	9.62	20.09	46.00	25.91	Average
10	1.279	20.75	9.62	30.37	56.00	25.63	QP
11	6.509	28.78	9.66	38.44	50.00	11.56	Average
12	6.509	30.57	9.66	40.23	60.00	19.77	QP

4.2 Radiation Spurious Emissions

Serial Number:	1TRF	Test Date:	2022/12/27~2023/03/10
Test Site:	966-2, 966-1	Test Mode:	Transmitting
Tester:	Carl Xue, coco Tian	Test Result:	Pass

Environmental Conditions:

Temperature: (°C)	21.4~23.4	Relative Humidity: (%)	40~42	ATM Pressure: (kPa)	101.7~101.8
----------------------	-----------	------------------------------	-------	------------------------	-------------

Test Equipment List and Details:

Manufacturer	Description	Model	Serial Number	Calibration Date	Calibration Due Date
Sunol Sciences	Antenna	JB6	A082520-5	2020/10/19	2023/10/18
R&S	EMI Test Receiver	ESR3	102724	2022/07/15	2023/07/14
TIMES MICROWAVE	Coaxial Cable	LMR-600-UltraFlex	C-0470-02	2022/07/17	2023/07/16
TIMES MICROWAVE	Coaxial Cable	LMR-600-UltraFlex	C-0780-01	2022/07/17	2023/07/16
Sonoma	Amplifier	310N	186165	2022/07/17	2023/07/16
ETS-Lindgren	Horn Antenna	3115	9912-5985	2020/10/13	2023/10/12
R&S	Spectrum Analyzer	FSV40	101591	2022/07/15	2023/07/14
MICRO-COAX	Coaxial Cable	UFA210A-1-1200-70U300	217423-008	2022/08/07	2023/08/06
MICRO-COAX	Coaxial Cable	UFA210A-1-2362-300300	235780-001	2022/08/07	2023/08/06
Mini	Pre-amplifier	ZVA-183-S+	5969001149	2022/11/09	2023/11/08
Audix	Test Software	E3	201021 (V9)	N/A	N/A
PASTERNAK	Horn Antenna	PE9852/2F-20	112002	2021/02/05	2024/02/04
Quinstar	Preamplifier	QLW-18405536-JO	15964001005	2022/9/16	2023/9/15
MICRO-COAX	Coaxial Cable	UFB142A-1-2362-200200	235772-001	2022/08/07	2023/08/06
E-Microwave	Band Rejection Filter	5150-5850MHz	OE01902423	2022/08/07	2023/08/06
Mini Circuits	High Pass Filter	VHF-6010+	31119	2022/08/07	2023/08/06
PASTERNAK	Horn Antenna	PE9850/2F-20	072001	2021/02/05	2024/02/04

* Statement of Traceability: China Certification ICT Co., Ltd (Dongguan) attests that all calibrations have been performed, traceable to National Primary Standards and International System of Units (SI).

Test Data:

1) 30MHz-1GHz (maximum output power mode (802.11n ht20 5580MHz))

Test Mode: Transmitting
 Polarization: horizontal
 Note:

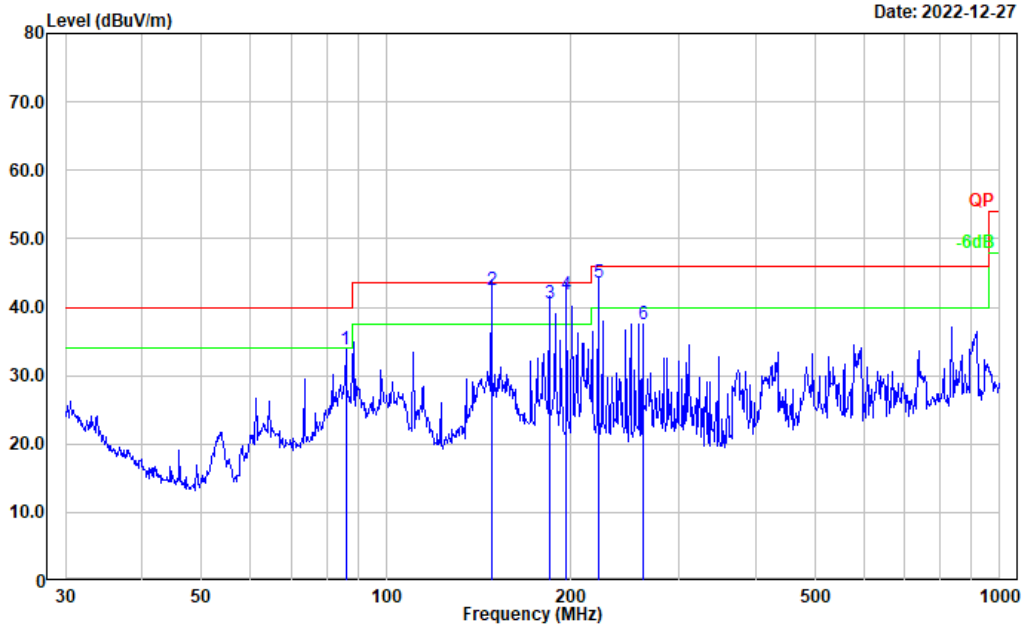

No.	Frequency (MHz)	Reading (dBμV)	Factor (dB/m)	Result (dBμV/m)	Limit (dBμV/m)	Margin (dB)	Detector
1	85.898	51.00	-17.15	33.85	40.00	6.15	Peak
2	148.441	54.52	-12.00	42.52	43.50	0.98	QP
3	184.490	54.11	-13.58	40.53	43.50	2.97	QP
4	196.510	54.38	-12.60	41.78	43.50	1.72	QP
5	221.392	56.38	-12.84	43.54	46.00	2.46	QP
6	261.975	49.91	-12.37	37.54	46.00	8.46	Peak

Test Mode: Transmitting
 Polarization: vertical
 Note:

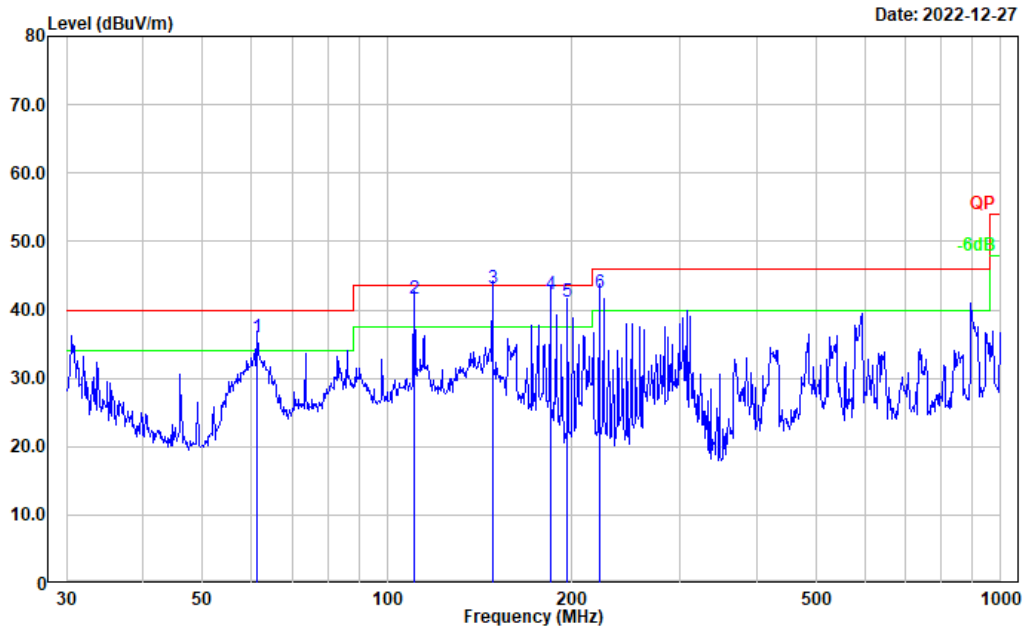

No.	Frequency (MHz)	Reading (dBμV)	Factor (dB/m)	Result (dBμV/m)	Limit (dBμV/m)	Margin (dB)	Detector
1	61.346	53.31	-17.32	35.99	40.00	4.01	QP
2	110.569	53.82	-12.28	41.54	43.50	1.96	QP
3	148.441	55.05	-12.00	43.05	43.50	0.45	QP
4	184.490	55.92	-13.58	42.34	43.50	1.16	QP
5	196.510	53.79	-12.60	41.19	43.50	2.31	QP
6	221.392	55.43	-12.84	42.59	46.00	3.41	QP

2) 1GHz-40GHz:**5150-5250MHz****802.11a Chain 0:**

Frequency (MHz)	Receiver		Polar (H/V)	Factor (dB/m)	Result (dB μ V/m)	Limit (dB μ V/m)	Margin (dB)
	Reading (dB μ V)	Detector					
Low Channel: 5180MHz							
5180.000	78.71	PK	H	38.68	111.37	N/A	N/A
5180.000	68.93	AV	H	38.68	101.59	N/A	N/A
5180.000	74.26	PK	V	38.68	106.92	N/A	N/A
5180.000	62.59	AV	V	38.68	95.25	N/A	N/A
5150.000	31.26	PK	H	38.64	63.88	74.00	10.12
5150.000	18.14	AV	H	38.64	50.76	54.00	3.24
10360.000	33.36	PK	H	19.18	46.52	68.20	21.68
15540.000	34.48	PK	H	22.44	50.90	74.00	23.10
15540.000	21.39	AV	H	22.44	37.81	54.00	16.19
Middle Channel: 5200 MHz							
5200.000	76.54	PK	H	38.70	109.22	N/A	N/A
5200.000	66.89	AV	H	38.70	99.57	N/A	N/A
5200.000	72.04	PK	V	38.70	104.72	N/A	N/A
5200.000	62.97	AV	V	38.70	95.65	N/A	N/A
10400.000	33.28	PK	H	19.16	46.42	68.20	21.78
15600.000	36.45	PK	H	22.41	52.84	74.00	21.16
15600.000	23.52	AV	H	22.41	39.91	54.00	14.09
High Channel: 5240 MHz							
5240.000	73.33	PK	H	38.85	106.16	N/A	N/A
5240.000	64.16	AV	H	38.85	96.99	N/A	N/A
5240.000	67.83	PK	V	38.85	100.66	N/A	N/A
5240.000	64.21	AV	V	38.85	97.04	N/A	N/A
5350.000	29.53	PK	H	39.03	62.54	74.00	11.46
5350.000	16.62	AV	H	39.03	49.63	54.00	4.37
10480.000	33.66	PK	H	18.86	46.50	68.20	21.70
15720.000	36.11	PK	H	22.28	52.37	74.00	21.63
15720.000	23.47	AV	H	22.28	39.73	54.00	14.27

802.11a Chain 1:

Frequency (MHz)	Receiver		Polar (H/V)	Factor (dB/m)	Result (dB μ V/m)	Limit (dB μ V/m)	Margin (dB)
	Reading (dB μ V)	Detector					
Low Channel: 5180MHz							
5180.000	78.48	PK	H	38.68	111.14	N/A	N/A
5180.000	68.70	AV	H	38.68	101.36	N/A	N/A
5180.000	74.03	PK	V	38.68	106.69	N/A	N/A
5180.000	62.36	AV	V	38.68	95.02	N/A	N/A
5150.000	31.03	PK	H	38.64	63.65	74.00	10.35
5150.000	17.91	AV	H	38.64	50.53	54.00	3.47
10360.000	33.13	PK	H	19.18	46.29	68.20	21.91
15540.000	34.25	PK	H	22.44	50.67	74.00	23.33
15540.000	21.16	AV	H	22.44	37.58	54.00	16.42
Middle Channel: 5200 MHz							
5200.000	76.32	PK	H	38.70	109.00	N/A	N/A
5200.000	66.67	AV	H	38.70	99.35	N/A	N/A
5200.000	71.82	PK	V	38.70	104.50	N/A	N/A
5200.000	62.75	AV	V	38.70	95.43	N/A	N/A
10400.000	33.06	PK	H	19.16	46.20	68.20	22.00
15600.000	36.23	PK	H	22.41	52.62	74.00	21.38
15600.000	23.30	AV	H	22.41	39.69	54.00	14.31
High Channel: 5240 MHz							
5240.000	73.12	PK	H	38.85	105.95	N/A	N/A
5240.000	63.96	AV	H	38.85	96.79	N/A	N/A
5240.000	67.65	PK	V	38.85	100.48	N/A	N/A
5240.000	64.24	AV	V	38.85	97.07	N/A	N/A
5350.000	29.32	PK	H	39.03	62.33	74.00	11.67
5350.000	16.41	AV	H	39.03	49.42	54.00	4.58
10480.000	33.45	PK	H	18.86	46.29	68.20	21.91
15720.000	35.90	PK	H	22.28	52.16	74.00	21.84
15720.000	23.26	AV	H	22.28	39.52	54.00	14.48

802.11n ht20:

Frequency (MHz)	Receiver		Polar (H/V)	Factor (dB/m)	Result (dB μ V/m)	Limit (dB μ V/m)	Margin (dB)
	Reading (dB μ V)	Detector					
Low Channel: 5180MHz							
5180.000	77.86	PK	H	38.68	110.52	N/A	N/A
5180.000	67.93	AV	H	38.68	100.59	N/A	N/A
5180.000	73.28	PK	V	38.68	105.94	N/A	N/A
5180.000	63.43	AV	V	38.68	96.09	N/A	N/A
5150.000	31.39	PK	H	38.64	64.01	74.00	9.99
5150.000	18.26	AV	H	38.64	50.88	54.00	3.12
10360.000	33.46	PK	H	19.18	46.62	68.20	21.58
15540.000	34.57	PK	H	22.44	50.99	74.00	23.01
15540.000	21.62	AV	H	22.44	38.04	54.00	15.96
Middle Channel: 5200 MHz							
5200.000	72.64	PK	H	38.70	105.32	N/A	N/A
5200.000	62.49	AV	H	38.70	95.17	N/A	N/A
5200.000	68.39	PK	V	38.70	101.07	N/A	N/A
5200.000	58.76	AV	V	38.70	91.44	N/A	N/A
10400.000	33.79	PK	H	19.16	46.93	68.20	21.27
15600.000	35.48	PK	H	22.41	51.87	74.00	22.13
15600.000	22.52	AV	H	22.41	38.91	54.00	15.09
High Channel: 5240 MHz							
5240.000	73.12	PK	H	38.85	105.95	N/A	N/A
5240.000	63.09	AV	H	38.85	95.92	N/A	N/A
5240.000	69.46	PK	V	38.85	102.29	N/A	N/A
5240.000	59.54	AV	V	38.85	92.37	N/A	N/A
5350.000	29.50	PK	H	39.03	62.51	74.00	11.49
5350.000	16.64	AV	H	39.03	49.65	54.00	4.35
10480.000	34.11	PK	H	18.86	46.95	68.20	21.25
15720.000	35.16	PK	H	22.28	51.42	74.00	22.58
15720.000	22.43	AV	H	22.28	38.69	54.00	15.31

802.11n ht40:

Frequency (MHz)	Receiver		Polar (H/V)	Factor (dB/m)	Result (dB μ V/m)	Limit (dB μ V/m)	Margin (dB)
	Reading (dB μ V)	Detector					
Low Channel: 5190 MHz							
5190.000	69.75	PK	H	38.69	102.42	N/A	N/A
5190.000	59.86	AV	H	38.69	92.53	N/A	N/A
5190.000	65.58	PK	V	38.69	98.25	N/A	N/A
5190.000	55.76	AV	V	38.69	88.43	N/A	N/A
5150.000	34.03	PK	H	38.64	66.65	74.00	7.35
5150.000	20.41	AV	H	38.64	53.03	54.00	0.97
10380.000	34.21	PK	H	19.17	47.36	68.20	20.84
15570.000	35.43	PK	H	22.43	51.84	74.00	22.16
15570.000	22.39	AV	H	22.43	38.80	54.00	15.20
High Channel: 5230 MHz							
5230.000	70.26	PK	H	38.81	103.05	N/A	N/A
5230.000	60.15	AV	H	38.81	92.94	N/A	N/A
5230.000	66.87	PK	V	38.81	99.66	N/A	N/A
5230.000	56.94	AV	V	38.81	89.73	N/A	N/A
5350.000	29.69	PK	H	39.03	62.70	74.00	11.30
5350.000	16.61	AV	H	39.03	49.62	54.00	4.38
10460.000	34.26	PK	H	18.94	47.18	68.20	21.02
15690.000	34.76	PK	H	22.29	51.03	74.00	22.97
15690.000	21.34	AV	H	22.29	37.61	54.00	16.39

Note:

Result = Reading + Factor- Distance extrapolation Factor

Distance extrapolation Factor = $20 \log (\text{specific distance [3m]}/\text{test distance [1.5m]})$ dB= 6.02 dB

5250-5350MHz**802.11a Chain 0:**

Frequency (MHz)	Receiver		Polar (H/V)	Factor (dB/m)	Result (dB μ V/m)	Limit (dB μ V/m)	Margin (dB)
	Reading (dB μ V)	Detector					
Low Channel: 5260MHz							
5260.000	77.95	PK	H	38.90	110.83	N/A	N/A
5260.000	68.02	AV	H	38.90	100.90	N/A	N/A
5260.000	74.35	PK	V	38.90	107.23	N/A	N/A
5260.000	64.02	AV	V	38.90	96.90	N/A	N/A
5150.000	29.77	PK	H	38.64	62.39	74.00	11.61
5150.000	16.88	AV	H	38.64	49.50	54.00	4.50
10520.000	34.09	PK	H	18.93	47.00	68.20	21.20
15780.000	35.76	PK	H	22.26	52.00	74.00	22.00
15780.000	22.81	AV	H	22.26	39.05	54.00	14.95
Middle Channel: 5280 MHz							
5280.000	77.42	PK	H	38.91	110.31	N/A	N/A
5280.000	67.51	AV	H	38.91	100.40	N/A	N/A
5280.000	73.22	PK	V	38.91	106.11	N/A	N/A
5280.000	63.38	AV	V	38.91	96.27	N/A	N/A
10560.000	33.62	PK	H	19.20	46.80	68.20	21.40
15840.000	35.69	PK	H	22.34	52.01	74.00	21.99
15840.000	22.78	AV	H	22.34	39.10	54.00	14.90
High Channel: 5320 MHz							
5320.000	76.27	PK	H	38.97	109.22	N/A	N/A
5320.000	66.10	AV	H	38.97	99.05	N/A	N/A
5320.000	72.36	PK	V	38.97	105.31	N/A	N/A
5320.000	62.45	AV	V	38.97	95.40	N/A	N/A
5350.000	30.36	PK	H	39.03	63.37	74.00	10.63
5350.000	17.35	AV	H	39.03	50.36	54.00	3.64
10640.000	34.11	PK	H	19.50	47.59	74.00	26.41
10640.000	21.16	AV	H	19.50	34.64	54.00	19.36
15960.000	35.84	PK	H	22.22	52.04	74.00	21.96
15960.000	22.76	AV	H	22.22	38.96	54.00	15.04

802.11a Chain 1:

Frequency (MHz)	Receiver		Polar (H/V)	Factor (dB/m)	Result (dB μ V/m)	Limit (dB μ V/m)	Margin (dB)
	Reading (dB μ V)	Detector					
Low Channel: 5260MHz							
5260.000	77.62	PK	H	38.90	110.50	N/A	N/A
5260.000	67.69	AV	H	38.90	100.57	N/A	N/A
5260.000	74.02	PK	V	38.90	106.90	N/A	N/A
5260.000	63.69	AV	V	38.90	96.57	N/A	N/A
5150.000	29.44	PK	H	38.64	62.06	74.00	11.94
5150.000	16.55	AV	H	38.64	49.17	54.00	4.83
10520.000	33.76	PK	H	18.93	46.67	68.20	21.53
15780.000	35.43	PK	H	22.26	51.67	74.00	22.33
15780.000	22.48	AV	H	22.26	38.72	54.00	15.28
Middle Channel: 5280 MHz							
5280.000	77.11	PK	H	38.91	110.00	N/A	N/A
5280.000	67.20	AV	H	38.91	100.09	N/A	N/A
5280.000	72.91	PK	V	38.91	105.80	N/A	N/A
5280.000	63.07	AV	V	38.91	95.96	N/A	N/A
10560.000	33.31	PK	H	19.20	46.49	68.20	21.71
15840.000	35.38	PK	H	22.34	51.70	74.00	22.30
15840.000	22.47	AV	H	22.34	38.79	54.00	15.21
High Channel: 5320 MHz							
5320.000	76.02	PK	H	38.97	108.97	N/A	N/A
5320.000	65.85	AV	H	38.97	98.80	N/A	N/A
5320.000	72.11	PK	V	38.97	105.06	N/A	N/A
5320.000	62.20	AV	V	38.97	95.15	N/A	N/A
5350.000	30.11	PK	H	39.03	63.12	74.00	10.88
5350.000	17.10	AV	H	39.03	50.11	54.00	3.89
10640.000	33.86	PK	H	19.50	47.34	74.00	26.66
10640.000	20.91	AV	H	19.50	34.39	54.00	19.61
15960.000	35.59	PK	H	22.22	51.79	74.00	22.21
15960.000	22.51	AV	H	22.22	38.71	54.00	15.29

802.11n ht20:

Frequency (MHz)	Receiver		Polar (H/V)	Factor (dB/m)	Result (dB μ V/m)	Limit (dB μ V/m)	Margin (dB)
	Reading (dB μ V)	Detector					
Low Channel: 5260MHz							
5260.000	77.43	PK	H	38.90	110.31	N/A	N/A
5260.000	68.36	AV	H	38.90	101.24	N/A	N/A
5260.000	73.17	PK	V	38.90	106.05	N/A	N/A
5260.000	63.26	AV	V	38.90	96.14	N/A	N/A
5150.000	29.76	PK	H	38.64	62.38	74.00	11.62
5150.000	16.84	AV	H	38.64	49.46	54.00	4.54
10520.000	34.08	PK	H	18.93	46.99	68.20	21.21
15780.000	35.56	PK	H	22.26	51.80	74.00	22.20
15780.000	21.99	AV	H	22.26	38.23	54.00	15.77
Middle Channel: 5280 MHz							
5280.000	77.42	PK	H	38.91	110.31	N/A	N/A
5280.000	67.35	AV	H	38.91	100.24	N/A	N/A
5280.000	73.02	PK	V	38.91	105.91	N/A	N/A
5280.000	63.24	AV	V	38.91	96.13	N/A	N/A
10560.000	33.91	PK	H	19.20	47.09	68.20	21.11
15840.000	35.46	PK	H	22.34	51.78	74.00	22.22
15840.000	22.65	AV	H	22.34	38.97	54.00	15.03
High Channel: 5320 MHz							
5320.000	76.25	PK	H	38.97	109.20	N/A	N/A
5320.000	66.25	AV	H	38.97	99.20	N/A	N/A
5320.000	72.58	PK	V	38.97	105.53	N/A	N/A
5320.000	62.48	AV	V	38.97	95.43	N/A	N/A
5350.000	30.10	PK	H	39.03	63.11	74.00	10.89
5350.000	17.32	AV	H	39.03	50.33	54.00	3.67
10640.000	33.66	PK	H	19.50	47.14	74.00	26.86
10640.000	20.59	AV	H	19.50	34.07	54.00	19.93
15960.000	35.76	PK	H	22.22	51.96	74.00	22.04
15960.000	21.48	AV	H	22.22	37.68	54.00	16.32

802.11n ht40:

Frequency (MHz)	Receiver		Polar (H/V)	Factor (dB/m)	Result (dB μ V/m)	Limit (dB μ V/m)	Margin (dB)
	Reading (dB μ V)	Detector					
Low Channel: 5270 MHz							
5270.000	73.71	PK	H	38.91	106.60	N/A	N/A
5270.000	63.15	AV	H	38.91	96.04	N/A	N/A
5270.000	69.09	PK	V	38.91	101.98	N/A	N/A
5270.000	59.43	AV	V	38.91	92.32	N/A	N/A
5150.000	29.75	PK	H	38.64	62.37	74.00	11.63
5150.000	16.80	AV	H	38.64	49.42	54.00	4.58
10540.000	34.07	PK	H	19.07	47.12	68.20	21.08
15810.000	35.64	PK	H	22.28	51.90	74.00	22.10
15810.000	22.51	AV	H	22.28	38.77	54.00	15.23
High Channel: 5310 MHz							
5310.000	71.45	PK	H	38.95	104.38	N/A	N/A
5310.000	61.03	AV	H	38.95	93.96	N/A	N/A
5310.000	57.86	PK	V	38.95	90.79	N/A	N/A
5310.000	51.91	AV	V	38.95	84.84	N/A	N/A
5350.000	31.99	PK	H	39.03	65.00	74.00	9.00
5350.000	18.78	AV	H	39.03	51.79	54.00	2.21
10620.000	33.46	PK	H	19.49	46.93	74.00	27.07
10620.000	20.51	AV	H	19.49	33.98	54.00	20.02
15930.000	35.00	PK	H	22.33	51.31	74.00	22.69
15930.000	22.19	AV	H	22.33	38.50	54.00	15.50

Note:

Result = Reading + Factor- Distance extrapolation Factor

Distance extrapolation Factor = 20 log (specific distance [3m]/test distance [1.5m]) dB= 6.02 dB

5470-5725MHz:**802.11a Chain 0:**

Frequency (MHz)	Receiver		Polar (H/V)	Factor (dB/m)	Result (dB μ V/m)	Limit (dB μ V/m)	Margin (dB)
	Reading (dB μ V)	Detector					
Low Channel: 5500MHz							
5500.000	76.45	PK	H	39.32	109.75	N/A	N/A
5500.000	66.38	AV	H	39.32	99.68	N/A	N/A
5500.000	72.64	PK	V	39.32	105.94	N/A	N/A
5500.000	62.71	AV	V	39.32	96.01	N/A	N/A
5470.000	30.47	PK	H	39.27	63.72	68.20	4.48
11000.000	34.77	PK	H	19.83	48.58	74.00	25.42
11000.000	21.89	AV	H	19.83	35.70	54.00	18.30
16500.000	35.82	PK	H	22.73	52.53	68.20	15.67
Middle Channel: 5580 MHz							
5580.000	77.56	PK	H	39.43	110.97	N/A	N/A
5580.000	64.49	AV	H	39.43	97.90	N/A	N/A
5580.000	7.82	PK	V	39.43	41.23	N/A	N/A
5580.000	63.79	AV	V	39.43	97.20	N/A	N/A
11160.000	33.58	PK	H	19.97	47.53	74.00	26.47
11160.000	20.16	AV	H	19.97	34.11	54.00	19.89
16740.000	35.62	PK	H	23.68	53.28	68.20	14.92
High Channel: 5700MHz							
5700.000	77.95	PK	H	39.51	111.44	N/A	N/A
5700.000	67.89	AV	H	39.51	101.38	N/A	N/A
5700.000	74.20	PK	V	39.51	107.69	N/A	N/A
5700.000	64.53	AV	V	39.51	98.02	N/A	N/A
5725.000	33.25	PK	H	39.48	66.71	68.20	1.49
11400.000	34.29	PK	H	20.93	49.20	74.00	24.80
11400.000	21.33	AV	H	20.93	36.24	54.00	17.76
17100.000	34.92	PK	H	26.19	55.09	68.20	13.11

802.11a Chain 1:

Frequency (MHz)	Receiver		Polar (H/V)	Factor (dB/m)	Result (dB μ V/m)	Limit (dB μ V/m)	Margin (dB)
	Reading (dB μ V)	Detector					
Low Channel: 5500MHz							
5500.000	76.20	PK	H	39.32	109.50	N/A	N/A
5500.000	66.13	AV	H	39.32	99.43	N/A	N/A
5500.000	72.39	PK	V	39.32	105.69	N/A	N/A
5500.000	62.46	AV	V	39.32	95.76	N/A	N/A
5470.000	30.22	PK	H	39.27	63.47	68.20	4.73
11000.000	34.52	PK	H	19.83	48.33	74.00	25.67
11000.000	21.64	AV	H	19.83	35.45	54.00	18.55
16500.000	35.57	PK	H	22.73	52.28	68.20	15.92
Middle Channel: 5580 MHz							
5580.000	77.39	PK	H	39.43	110.80	N/A	N/A
5580.000	64.26	AV	H	39.43	97.67	N/A	N/A
5580.000	74.57	PK	V	39.43	107.98	N/A	N/A
5580.000	63.56	AV	V	39.43	96.97	N/A	N/A
11160.000	33.35	PK	H	19.97	47.30	74.00	26.70
11160.000	19.93	AV	H	19.97	33.88	54.00	20.12
16740.000	35.39	PK	H	23.68	53.05	68.20	15.15
High Channel: 5700MHz							
5700.000	77.82	PK	H	39.51	111.31	N/A	N/A
5700.000	67.76	AV	H	39.51	101.25	N/A	N/A
5700.000	74.07	PK	V	39.51	107.56	N/A	N/A
5700.000	64.40	AV	V	39.51	97.89	N/A	N/A
5725.000	33.12	PK	H	39.48	66.58	68.20	1.62
11400.000	34.16	PK	H	20.93	49.07	74.00	24.93
11400.000	21.20	AV	H	20.93	36.11	54.00	17.89
17100.000	34.79	PK	H	26.19	54.96	68.20	13.24

802.11n ht20:

Frequency (MHz)	Receiver		Polar (H/V)	Factor (dB/m)	Result (dB μ V/m)	Limit (dB μ V/m)	Margin (dB)
	Reading (dB μ V)	Detector					
LowChannel: 5500MHz							
5500.000	75.01	PK	H	39.32	108.31	N/A	N/A
5500.000	64.79	AV	H	39.32	98.09	N/A	N/A
5500.000	71.64	PK	V	39.32	104.94	N/A	N/A
5500.000	61.89	AV	V	39.32	95.19	N/A	N/A
5470.000	30.13	PK	H	39.27	63.38	68.20	4.82
11000.000	34.11	PK	H	19.83	47.92	74.00	26.08
11000.000	21.08	AV	H	19.83	34.89	54.00	19.11
16500.000	35.77	PK	H	22.73	52.48	68.20	15.72
Middle Channel: 5580 MHz							
5580.000	77.69	PK	H	39.43	111.10	N/A	N/A
5580.000	67.86	AV	H	39.43	101.27	N/A	N/A
5580.000	73.59	PK	V	39.43	107.00	N/A	N/A
5580.000	63.47	AV	V	39.43	96.88	N/A	N/A
11160.000	35.28	PK	H	19.97	49.23	74.00	24.77
11160.000	22.69	AV	H	19.97	36.64	54.00	17.36
16740.000	35.64	PK	H	23.68	53.30	68.20	14.90
High Channel: 5700MHz							
5700.000	76.86	PK	H	39.51	110.35	N/A	N/A
5700.000	56.79	AV	H	39.51	90.28	N/A	N/A
5700.000	72.58	PK	V	39.51	106.07	N/A	N/A
5700.000	62.77	AV	V	39.51	96.26	N/A	N/A
5725.000	33.75	PK	H	39.48	67.21	68.20	0.99
11400.000	34.26	PK	H	20.93	49.17	74.00	24.83
11400.000	21.46	AV	H	20.93	36.37	54.00	17.63
17100.000	35.78	PK	H	26.19	55.95	68.20	12.25

802.11n ht40:

Frequency (MHz)	Receiver		Polar (H/V)	Factor (dB/m)	Result (dB μ V/m)	Limit (dB μ V/m)	Margin (dB)
	Reading (dB μ V)	Detector					
Low Channel: 5510MHz							
5510.000	72.98	PK	H	39.35	106.31	N/A	N/A
5510.000	62.82	AV	H	39.35	96.15	N/A	N/A
5510.000	78.69	PK	V	39.35	112.02	N/A	N/A
5510.000	68.47	AV	V	39.35	101.80	N/A	N/A
5470.000	32.16	PK	V	39.27	65.41	68.20	2.79
11020.000	33.69	PK	V	19.85	47.52	74.00	26.48
11020.000	20.58	AV	V	19.85	34.41	54.00	19.59
16530.000	35.39	PK	V	23.02	52.39	68.20	15.81
Middle Channel: 5550 MHz							
5550.000	74.16	PK	H	39.46	107.60	N/A	N/A
5550.000	64.21	AV	H	39.46	97.65	N/A	N/A
5550.000	70.02	PK	V	39.46	103.46	N/A	N/A
5550.000	60.11	AV	V	39.46	93.55	N/A	N/A
11100.000	33.47	PK	H	19.95	47.40	74.00	26.60
11100.000	20.26	AV	H	19.95	34.19	54.00	19.81
16650.000	35.26	PK	H	23.65	52.89	68.20	15.31
High Channel: 5670 MHz							
5670.000	74.01	PK	H	39.50	107.49	N/A	N/A
5670.000	64.48	AV	H	39.50	97.96	N/A	N/A
5670.000	70.12	PK	V	39.50	103.60	N/A	N/A
5670.000	60.21	AV	V	39.50	93.69	N/A	N/A
5725.000	33.61	PK	H	39.48	67.07	68.20	1.13
11340.000	34.62	PK	H	20.77	49.37	74.00	24.63
11340.000	21.34	AV	H	20.77	36.09	54.00	17.91
17010.000	35.47	PK	H	25.56	55.01	68.20	13.19

Note:

Result = Reading + Factor- Distance extrapolation Factor

Distance extrapolation Factor = 20 log (specific distance [3m]/test distance [1.5m]) dB= 6.02 dB

5725-5850MHz:**802.11a Chain 0:**

Frequency (MHz)	Receiver		Polar (H/V)	Factor (dB/m)	Result (dB μ V/m)	Limit (dB μ V/m)	Margin (dB)
	Reading (dB μ V)	Detector					
Low Channel: 5745MHz							
5745.000	77.78	PK	H	39.46	111.22	N/A	N/A
5745.000	68.15	AV	H	39.46	101.59	N/A	N/A
5745.000	74.32	PK	V	39.46	107.76	N/A	N/A
5745.000	64.75	AV	V	39.46	98.19	N/A	N/A
5725.000	39.53	PK	H	39.48	72.99	122.20	49.21
5720.000	31.89	PK	H	39.49	65.36	110.80	45.44
5700.000	31.91	PK	H	39.51	65.40	105.20	39.80
5650.000	30.19	PK	H	39.49	63.66	68.20	4.54
11490.000	37.64	PK	H	20.67	52.29	74.00	21.71
11490.000	34.71	AV	H	20.67	49.36	54.00	4.64
17235.000	34.79	PK	H	26.76	55.53	68.20	12.67
Middle Channel: 5785 MHz							
5785.000	77.35	PK	H	39.44	110.77	N/A	N/A
5785.000	67.99	AV	H	39.44	101.41	N/A	N/A
5785.000	74.16	PK	V	39.44	107.58	N/A	N/A
5785.000	64.83	AV	V	39.44	98.25	N/A	N/A
11570.000	37.59	PK	H	20.83	52.40	74.00	21.60
11570.000	34.61	AV	H	20.83	49.42	54.00	4.58
17355.000	34.52	PK	H	27.74	56.24	68.20	11.96
High Channel: 5825 MHz							
5825.000	77.64	PK	H	39.46	111.08	N/A	N/A
5825.000	68.07	AV	H	39.46	101.51	N/A	N/A
5825.000	74.35	PK	V	39.46	107.79	N/A	N/A
5825.000	64.92	AV	V	39.46	98.36	N/A	N/A
5850.000	35.07	PK	H	39.49	68.54	122.20	53.66
5855.000	32.32	PK	H	39.51	65.81	110.80	44.99
5875.000	32.87	PK	H	39.60	66.45	105.20	38.75
5925.000	32.64	PK	H	39.68	66.30	68.20	1.90
11650.000	38.73	PK	H	21.07	53.78	74.00	20.22
11650.000	35.96	AV	H	21.07	51.01	54.00	2.99
17475.000	33.46	PK	H	28.61	56.05	68.20	12.15

802.11a Chain 1:

Frequency (MHz)	Receiver		Polar (H/V)	Factor (dB/m)	Result (dB μ V/m)	Limit (dB μ V/m)	Margin (dB)
	Reading (dB μ V)	Detector					
Low Channel: 5745MHz							
5745.000	77.43	PK	H	39.46	110.87	N/A	N/A
5745.000	67.86	AV	H	39.46	101.30	N/A	N/A
5745.000	73.97	PK	V	39.46	107.41	N/A	N/A
5745.000	64.43	AV	V	39.46	97.87	N/A	N/A
5725.000	39.18	PK	H	39.48	72.64	122.20	49.56
5720.000	31.54	PK	H	39.49	65.01	110.80	45.79
5700.000	31.56	PK	H	39.51	65.05	105.20	40.15
5650.000	29.84	PK	H	39.49	63.31	68.20	4.89
11490.000	37.29	PK	H	20.67	51.94	74.00	22.06
11490.000	34.36	AV	H	20.67	49.01	54.00	4.99
17235.000	34.44	PK	H	26.76	55.18	68.20	13.02
Middle Channel: 5785 MHz							
5785.000	77.13	PK	H	39.44	110.55	N/A	N/A
5785.000	67.67	AV	H	39.44	101.09	N/A	N/A
5785.000	73.86	PK	V	39.44	107.28	N/A	N/A
5785.000	64.51	AV	V	39.44	97.93	N/A	N/A
11570.000	37.27	PK	H	20.83	52.08	74.00	21.92
11570.000	34.29	AV	H	20.83	49.10	54.00	4.90
17355.000	34.20	PK	H	27.74	55.92	68.20	12.28
High Channel: 5825 MHz							
5825.000	77.49	PK	H	39.46	110.93	N/A	N/A
5825.000	67.86	AV	H	39.46	101.30	N/A	N/A
5825.000	74.17	PK	V	39.46	107.61	N/A	N/A
5825.000	64.69	AV	V	39.46	98.13	N/A	N/A
5850.000	34.84	PK	H	39.49	68.31	122.20	53.89
5855.000	32.09	PK	H	39.51	65.58	110.80	45.22
5875.000	32.64	PK	H	39.60	66.22	105.20	38.98
5925.000	32.41	PK	H	39.68	66.07	68.20	2.13
11650.000	38.50	PK	H	21.07	53.55	74.00	20.45
11650.000	35.73	AV	H	21.07	50.78	54.00	3.22
17475.000	33.23	PK	H	28.61	55.82	68.20	12.38

802.11n ht20:

Frequency (MHz)	Receiver		Polar (H/V)	Factor (dB/m)	Result (dB μ V/m)	Limit (dB μ V/m)	Margin (dB)
	Reading (dB μ V)	Detector					
LowChannel: 5745MHz							
5745.000	77.69	PK	H	39.46	111.13	N/A	N/A
5745.000	68.01	AV	H	39.46	101.45	N/A	N/A
5745.000	73.56	PK	V	39.46	107.00	N/A	N/A
5745.000	63.91	AV	V	39.46	97.35	N/A	N/A
5725.000	39.97	PK	H	39.48	73.43	122.20	48.77
5720.000	33.57	PK	H	39.49	67.04	110.80	43.76
5700.000	31.34	PK	H	39.51	64.83	105.20	40.37
5650.000	30.27	PK	H	39.49	63.74	68.20	4.46
11490.000	36.84	PK	H	20.67	51.49	74.00	22.51
11490.000	23.77	AV	H	20.67	38.42	54.00	15.58
17235.000	34.52	PK	H	26.76	55.26	68.20	12.94
Middle Channel: 5785 MHz							
5785.000	77.38	PK	H	39.44	110.80	N/A	N/A
5785.000	77.06	AV	H	39.44	110.48	N/A	N/A
5785.000	74.79	PK	V	39.44	108.21	N/A	N/A
5785.000	75.12	AV	V	39.44	108.54	N/A	N/A
11570.000	36.75	PK	H	20.83	51.56	74.00	22.44
11570.000	23.48	AV	H	20.83	38.29	54.00	15.71
17355.000	34.67	PK	H	27.74	56.39	68.20	11.81
High Channel: 5825 MHz							
5825.000	77.34	PK	H	39.46	110.78	N/A	N/A
5825.000	68.00	AV	H	39.46	101.44	N/A	N/A
5825.000	74.57	PK	V	39.46	108.01	N/A	N/A
5825.000	75.02	AV	V	39.46	108.46	N/A	N/A
5850.000	33.05	PK	H	39.49	66.52	122.20	55.68
5855.000	32.45	PK	H	39.51	65.94	110.80	44.86
5875.000	32.92	PK	H	39.60	66.50	105.20	38.70
5925.000	32.14	PK	H	39.68	65.80	68.20	2.40
11650.000	36.57	PK	H	21.07	51.62	74.00	22.38
11650.000	23.75	AV	H	21.07	38.80	54.00	15.20
17475.000	34.24	PK	H	28.61	56.83	68.20	11.37

802.11n ht40:

Frequency (MHz)	Receiver		Polar (H/V)	Factor (dB/m)	Result (dB μ V/m)	Limit (dB μ V/m)	Margin (dB)
	Reading (dB μ V)	Detector					
Low Channel: 5755 MHz							
5755.000	74.04	PK	H	39.45	107.47	N/A	N/A
5755.000	64.59	AV	H	39.45	98.02	N/A	N/A
5755.000	70.34	PK	V	39.45	103.77	N/A	N/A
5755.000	60.46	AV	V	39.45	93.89	N/A	N/A
5725.000	42.94	PK	H	39.48	76.40	122.20	45.80
5720.000	39.92	PK	H	39.49	73.39	110.80	37.41
5700.000	21.41	PK	H	39.51	54.90	105.20	50.30
5650.000	30.45	PK	H	39.49	63.92	68.20	4.28
11510.000	35.96	PK	H	20.67	50.61	74.00	23.39
11510.000	23.02	AV	H	20.67	37.67	54.00	16.33
17265.000	34.09	PK	H	26.94	55.01	68.20	13.19
High Channel: 5795 MHz							
5795.000	74.72	PK	H	39.43	108.13	N/A	N/A
5795.000	65.64	AV	H	39.43	99.05	N/A	N/A
5795.000	70.26	PK	V	39.43	103.67	N/A	N/A
5795.000	60.38	AV	V	39.43	93.79	N/A	N/A
5850.000	32.34	PK	H	39.49	65.81	122.20	56.39
5855.000	32.64	PK	H	39.51	66.13	110.80	44.67
5875.000	32.22	PK	H	39.60	65.80	105.20	39.40
5925.000	31.96	PK	H	39.68	65.62	68.20	2.58
11590.000	36.45	PK	H	20.88	51.31	74.00	22.69
11590.000	23.58	AV	H	20.88	38.44	54.00	15.56
17385.000	34.51	PK	H	28.07	56.56	68.20	11.64

Note:

Result = Reading + Factor- Distance extrapolation Factor

Distance extrapolation Factor = 20 log (specific distance [3m]/test distance [1.5m]) dB = 6.02 dB

5725-5850MHz Worst Band Edge Test plots (802.11a chain 0)

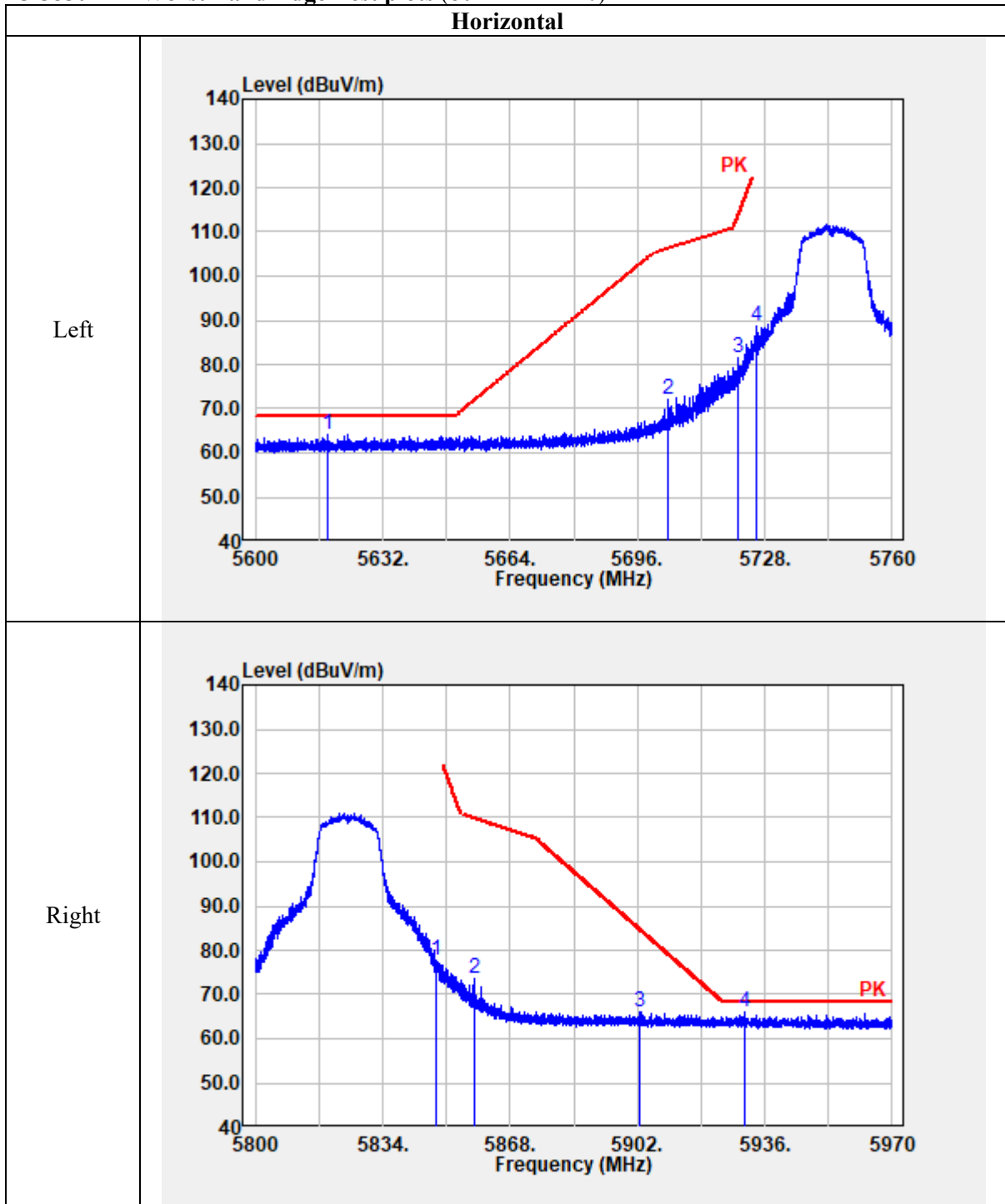

Vertical

Left

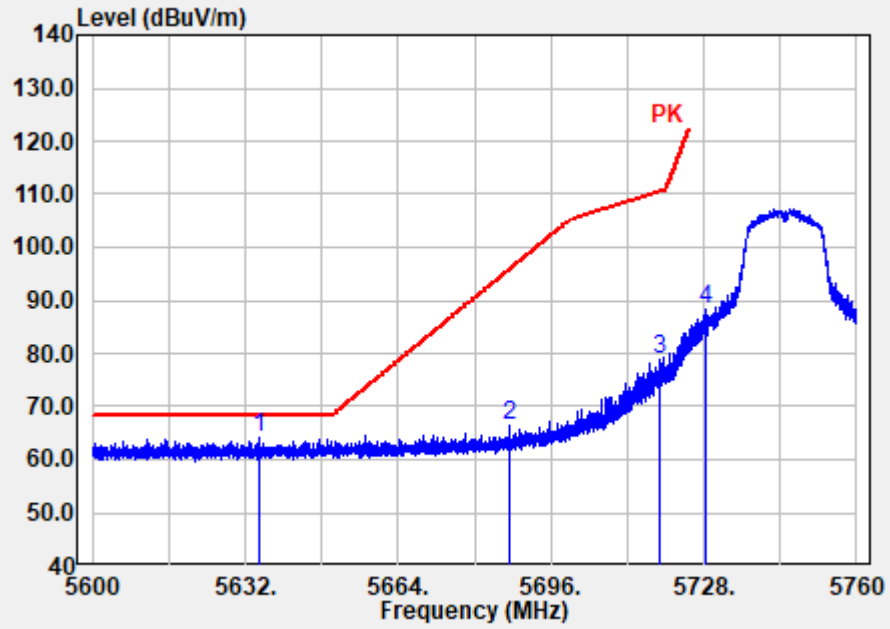

Right

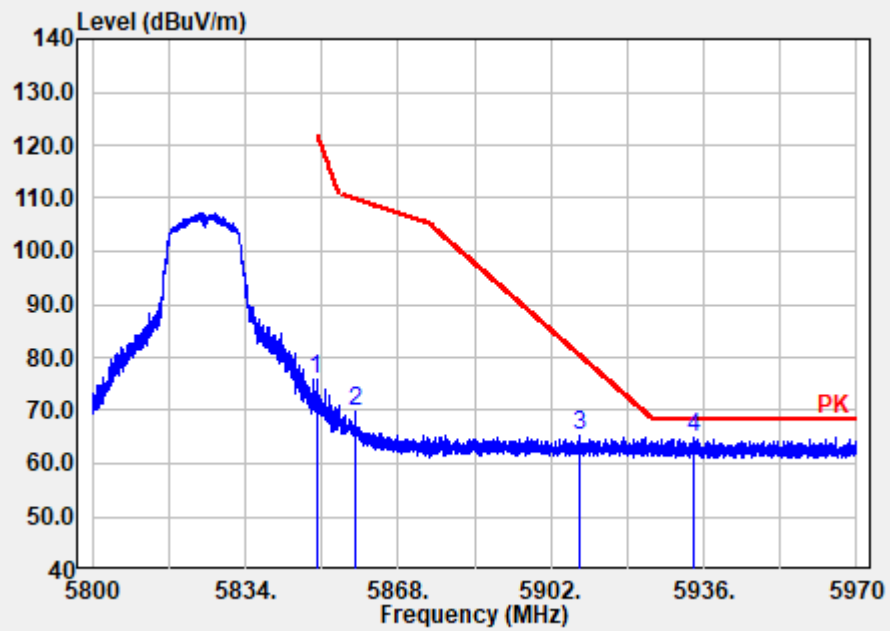

Worst Test plots(802.11a chain 0 5825 MHz was the worst)

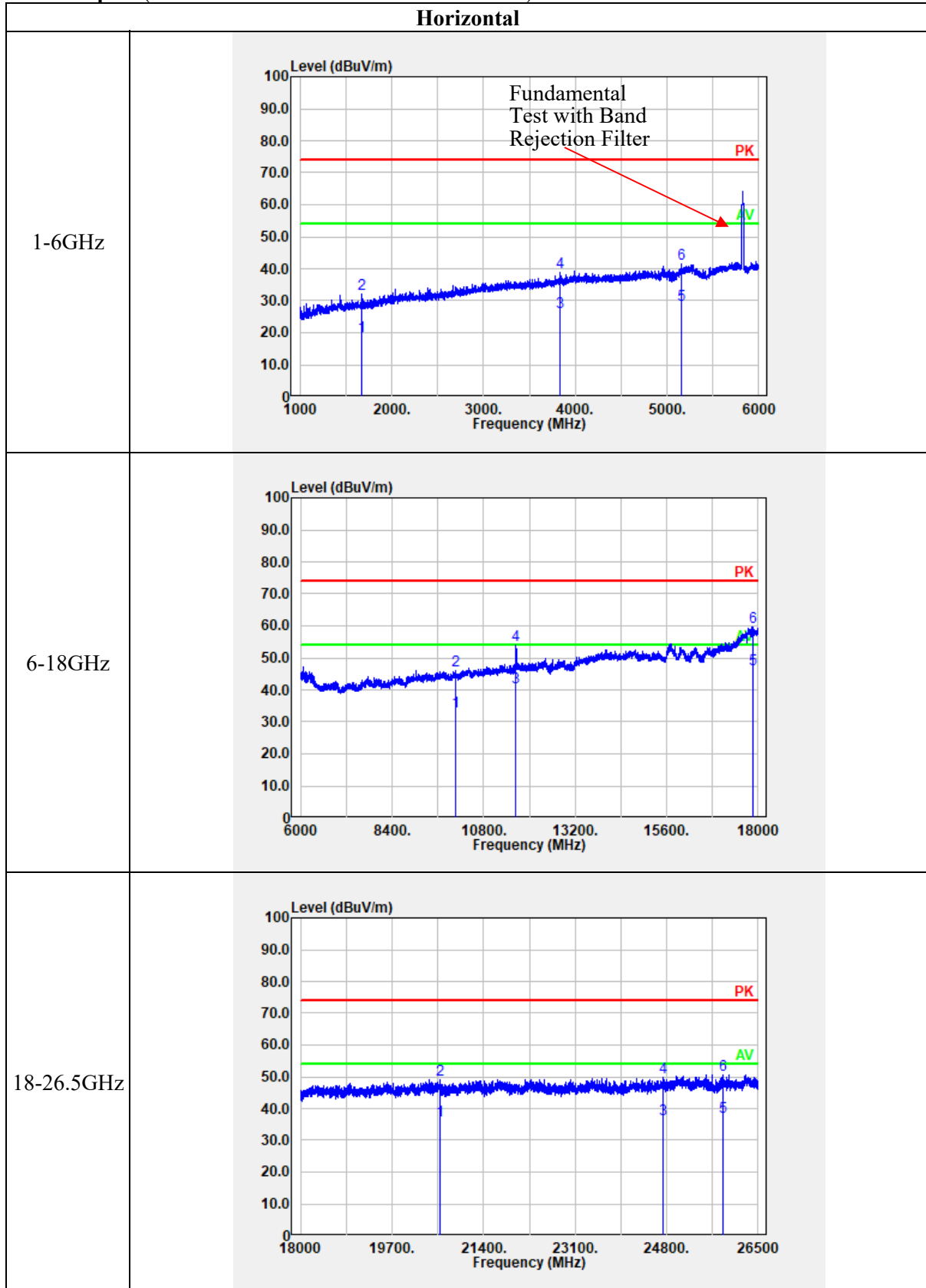

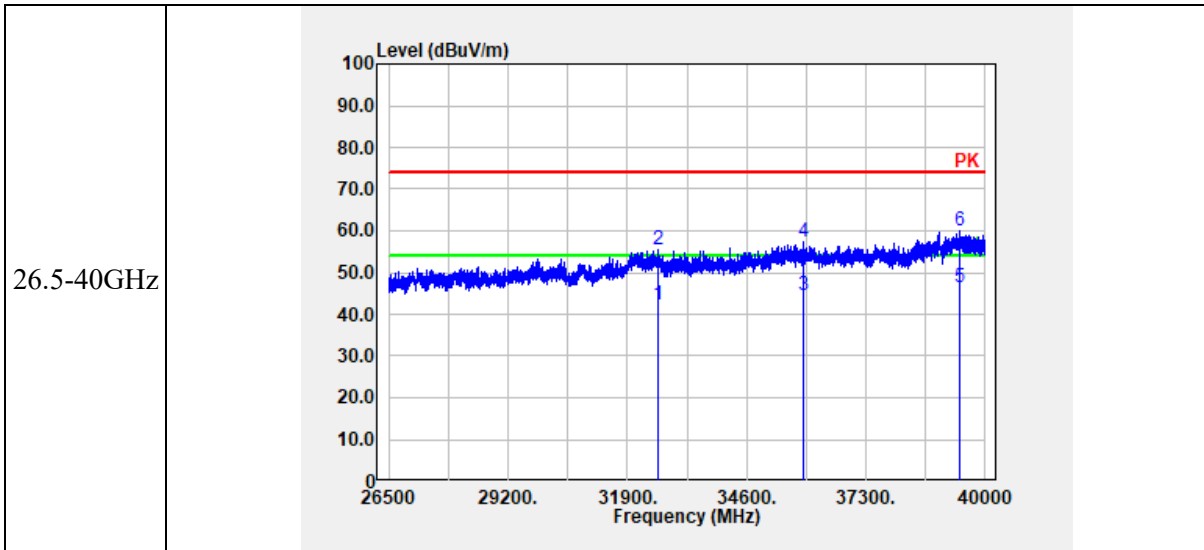

Vertical

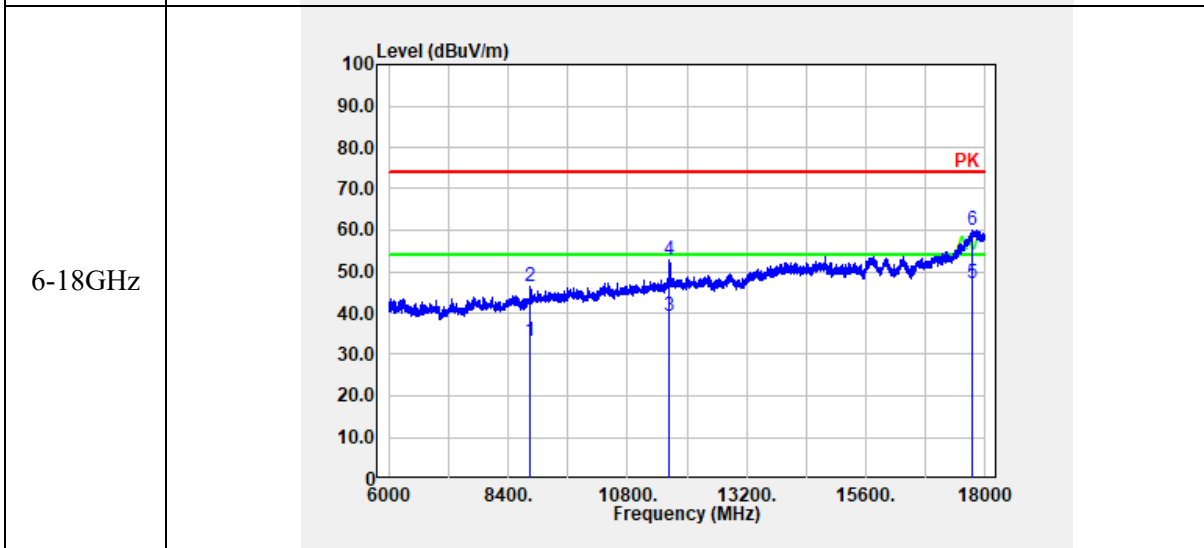
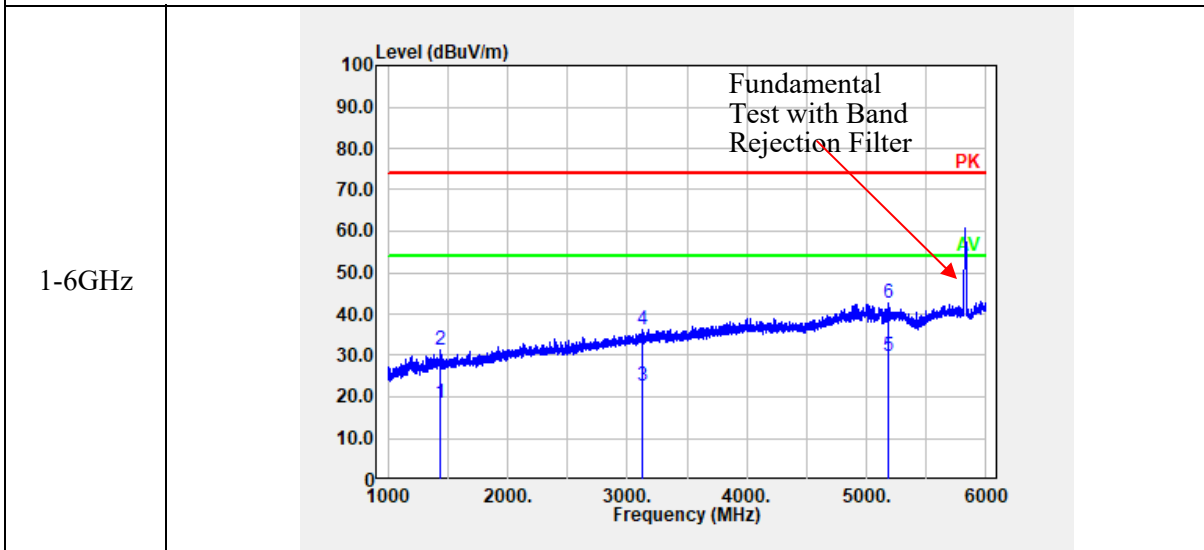

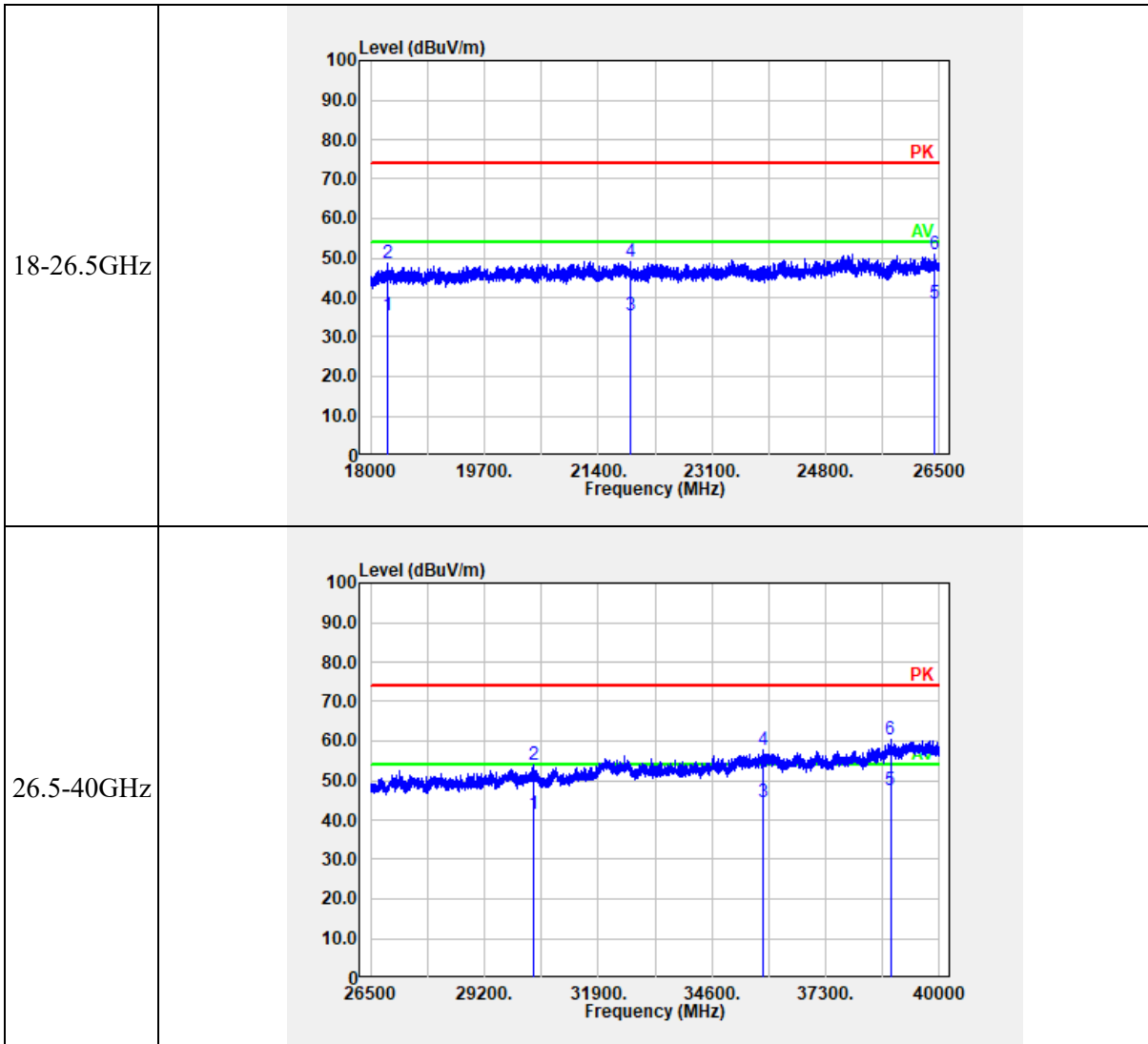

4.3 26dB attenuated below the channel power:

Serial Number:	1TRF	Test Date:	2023/7/7~2023/7/12
Test Site:	RF	Test Mode:	Transmitting
Tester:	Claire Liu	Test Result:	Pass

Environmental Conditions:					
Temperature: (°C)	24.8~26.2	Relative Humidity: (%)	51~62	ATM Pressure: (kPa)	99.7~100.6

Test Equipment List and Details:

Manufacturer	Description	Model	Serial Number	Calibration Date	Calibration Due Date
R&S	Spectrum Analyzer	FSU26	200256	2022/7/15	2023/7/14
YINSAIGE	Coaxial Cable	SS402	SJ0100002	Each time	N/A

* *Statement of Traceability: China Certification ICT Co., Ltd (Dongguan) attests that all calibrations have been performed, traceable to National Primary Standards and International System of Units (SI).*

Test Data:

Note: the requirement is for 5150-5250 MHz band. The channel power please refer to the power test result in section 4.5.

5150-5250MHz:
Chain 0:

26dB attenuated below the channel power

802.11a
Lowest Channel

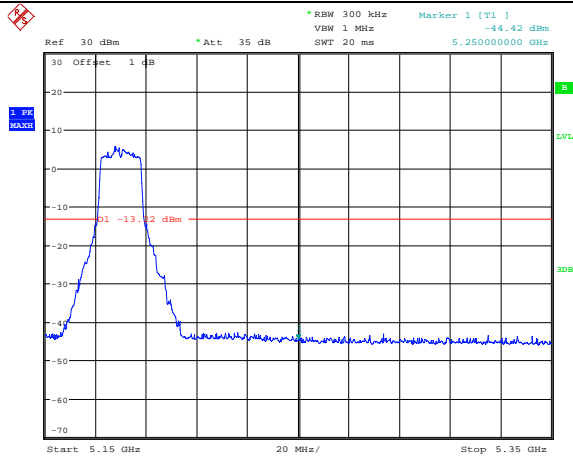

Date: 7.JUL.2023 14:32:51

802.11a
Middle Channel

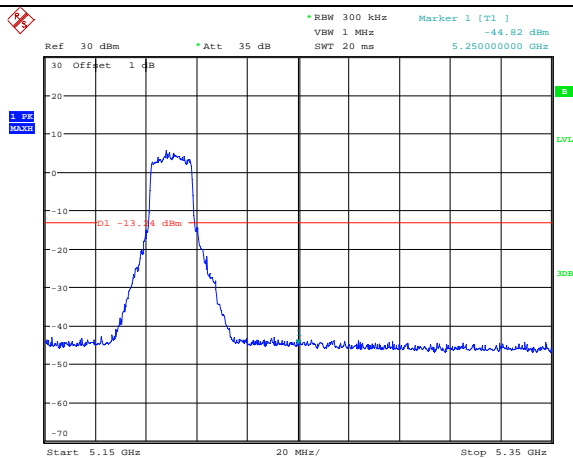

Date: 7.JUL.2023 14:35:01

802.11a
Highest Channel

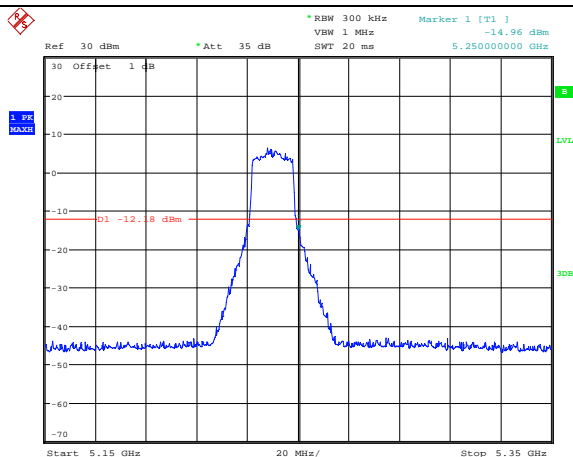

Date: 7.JUL.2023 14:52:00

26dB attenuated below the channel power

802.11n ht20
Lowest Channel

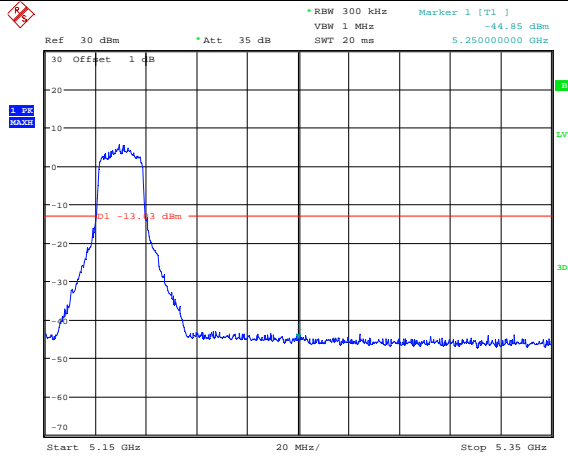

Date: 7.JUL.2023 14:59:18

802.11n ht20
Middle Channel

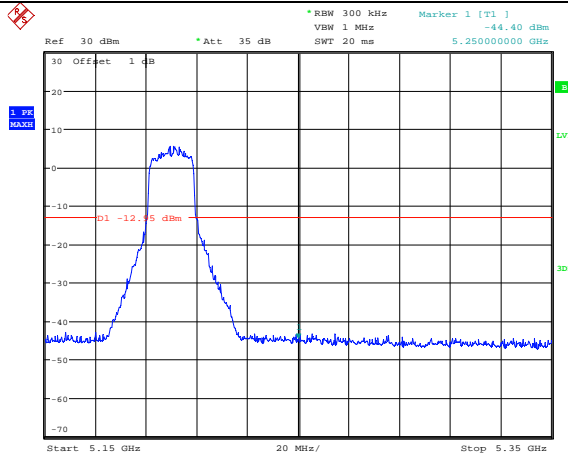

Date: 7.JUL.2023 14:58:23

802.11n ht20
Highest Channel

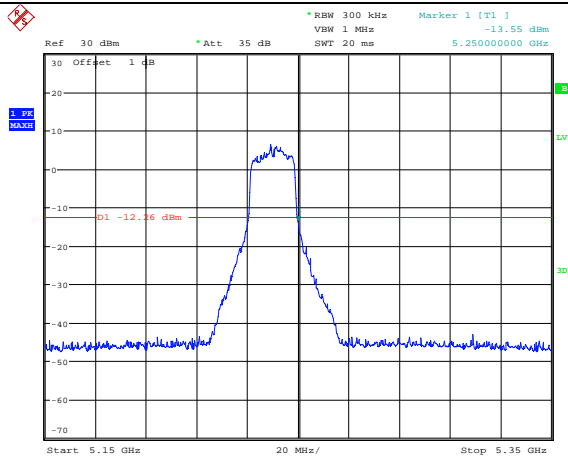

Date: 7.JUL.2023 14:54:29

26dB attenuated below the channel power

802.11n ht40
Lowest Channel

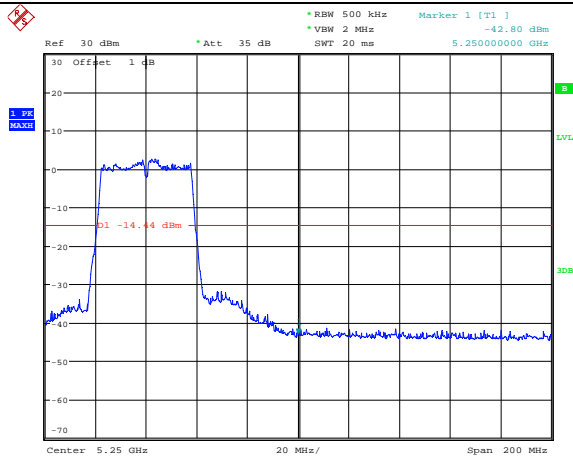

Date: 7.JUL.2023 15:06:55

802.11n ht40
Highest Channel

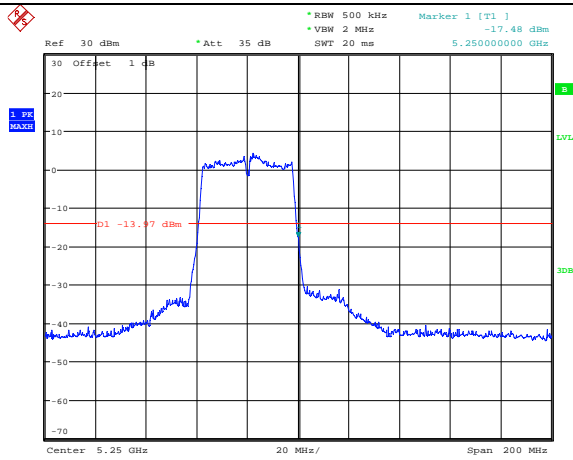

Date: 7.JUL.2023 15:06:14

Chain 1:

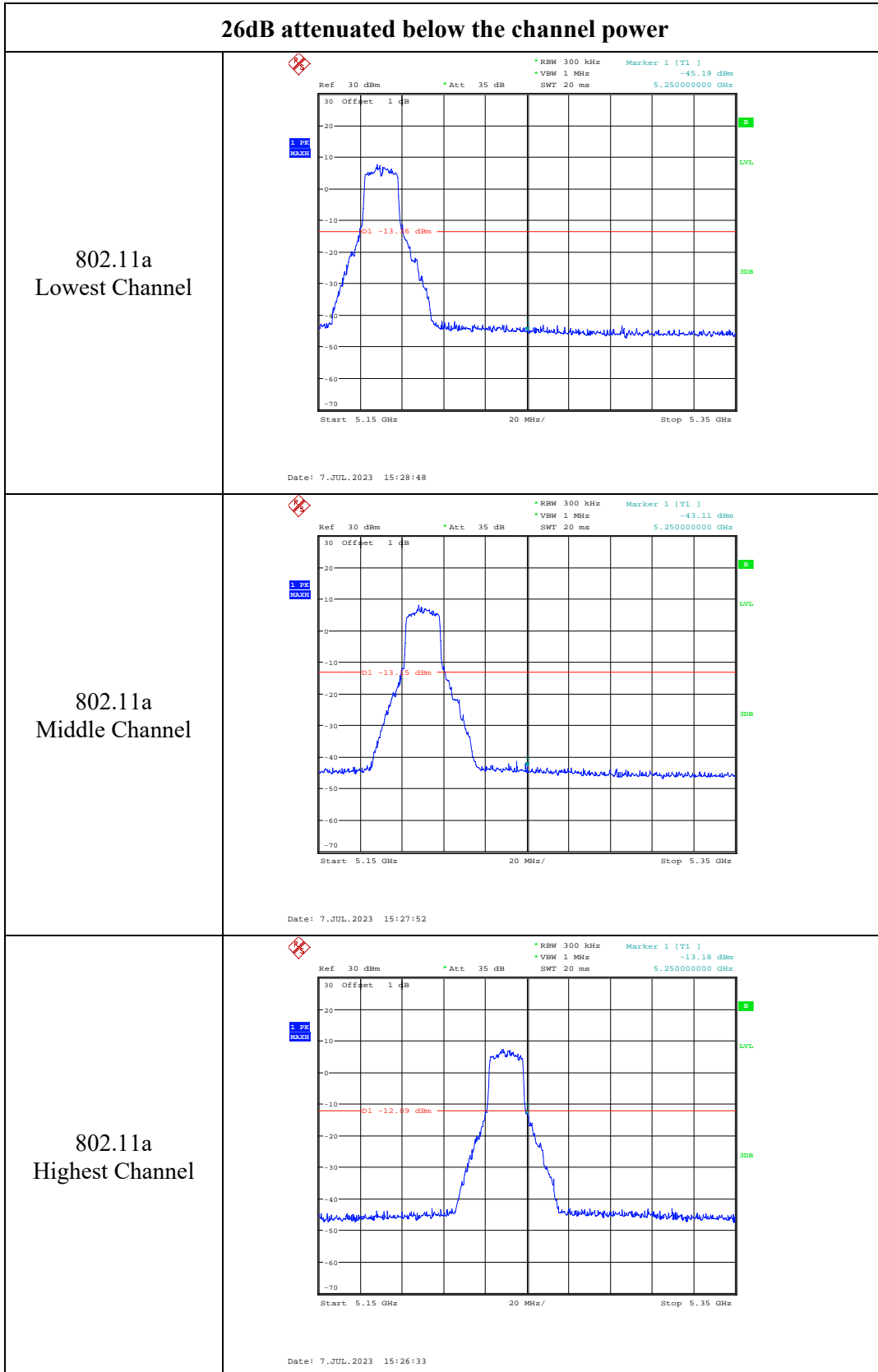

26dB attenuated below the channel power

802.11n ht20
Lowest Channel

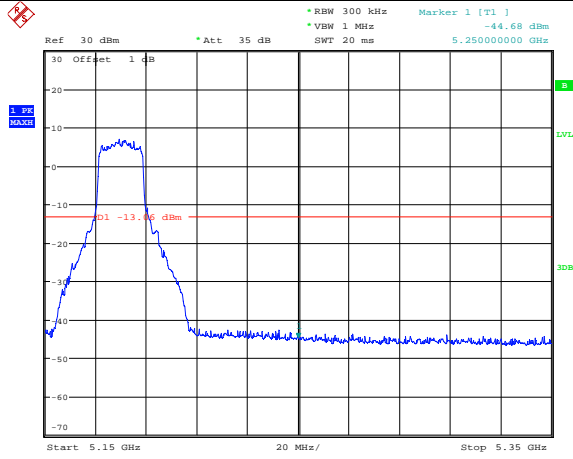

Date: 7.JUL.2023 15:17:23

802.11n ht20
Middle Channel

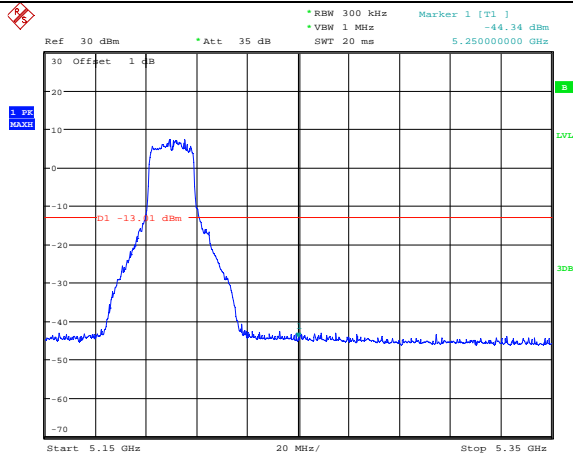

Date: 7.JUL.2023 15:18:45

802.11n ht20
Highest Channel

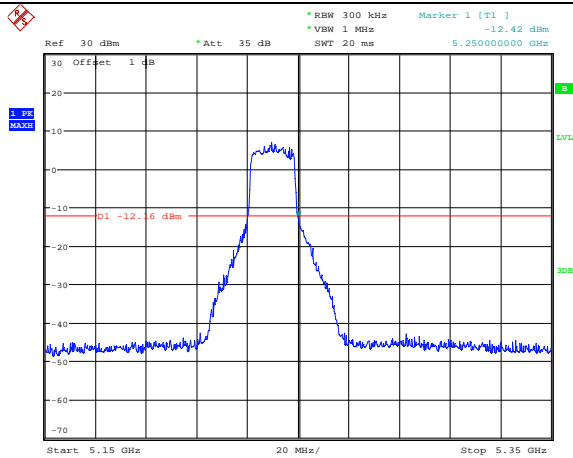

Date: 7.JUL.2023 15:20:56

26dB attenuated below the channel power

802.11n ht40
Lowest Channel

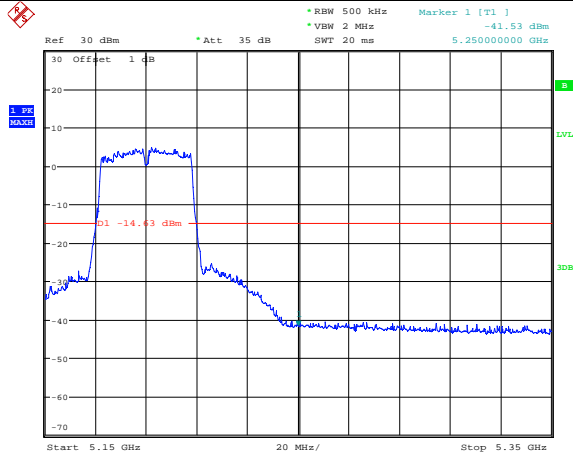

Date: 7.JUL.2023 15:15:53

802.11n ht40
Highest Channel

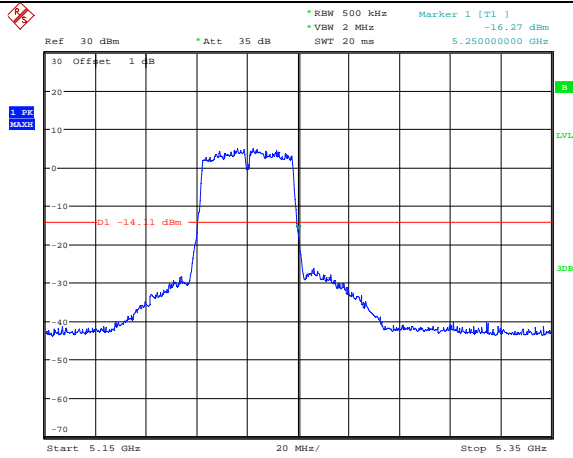

Date: 7.JUL.2023 15:13:28

4.4 Emission Bandwidth

Serial Number:	1TRF	Test Date:	2023/7/7~2023/7/12
Test Site:	RF	Test Mode:	Transmitting
Tester:	Claire Liu	Test Result:	Pass

Environmental Conditions:					
Temperature: (°C)	24.8~26.2	Relative Humidity: (%)	51~62	ATM Pressure: (kPa)	99.7~100.6

Test Equipment List and Details:

Manufacturer	Description	Model	Serial Number	Calibration Date	Calibration Due Date
R&S	Spectrum Analyzer	FSU26	200256	2022/7/15	2023/7/14
YINSAIGE	Coaxial Cable	SS402	SJ0100002	Each time	N/A

* *Statement of Traceability: China Certification ICT Co., Ltd (Dongguan) attests that all calibrations have been performed, traceable to National Primary Standards and International System of Units (SI).*

Test Data:

5150-5250 MHz:

Test Modes	Test Frequency (MHz)	26 dB Bandwidth (MHz)	99% Occupied Bandwidth (MHz)
802.11a	5180	24.43	16.96
	5200	24.72	16.88
	5240	24.62	16.96
802.11n ht20	5180	25.92	18
	5200	26.12	18.24
	5240	25.18	18
802.11n ht40	5190	42.4	36.32
	5230	41.76	36.32

Note: Test only was performed at Chain 0.

5250-5350 MHz:

Test Modes	Test Frequency (MHz)	26 dB Bandwidth (MHz)	99% Occupied Bandwidth (MHz)
802.11a	5260	25.63	17.04
	5280	25.87	17.12
	5320	26.73	17.2
802.11n ht20	5260	28.71	18.16
	5280	28.23	18.24
	5320	28.94	18.32
802.11n ht40	5270	45.43	36.64
	5310	41.83	36.32

Note: Test only was performed at Chain 0.

5470-5725 MHz

Test Modes	Test Frequency (MHz)	26 dB Bandwidth (MHz)	99% Occupied Bandwidth (MHz)
802.11a	5500	25.15	16.96
	5580	25.48	16.96
	5700	26.21	16.96
	5720	26.42	17.12
802.11n ht20	5500	28.04	18.16
	5580	28.71	18.24
	5700	26.12	18
	5720	26.42	18.08
802.11n ht40	5510	42.72	36.64
	5550	42.47	36.48
	5670	42.47	36.32
	5710	42.08	36.48

Note: Test only was performed at Chain 0.

5725-5850 MHz:

Test Modes	Test Frequency (MHz)	6 dB Bandwidth (MHz)	99% Occupied Bandwidth (MHz)
802.11a	5745	15.680	17.04
	5785	15.52	17.04
	5825	15.6	17.04
802.11n ht20	5745	15.36	18.16
	5785	15.76	18.24
	5825	16.88	18.16
802.11n ht40	5755	35.680	36.48
	5795	35.84	36.32
Note: 6dB Emission Bandwidth Limit: ≥ 0.5 MHz Test only was performed at Chain 0.			

5150-5250MHz:

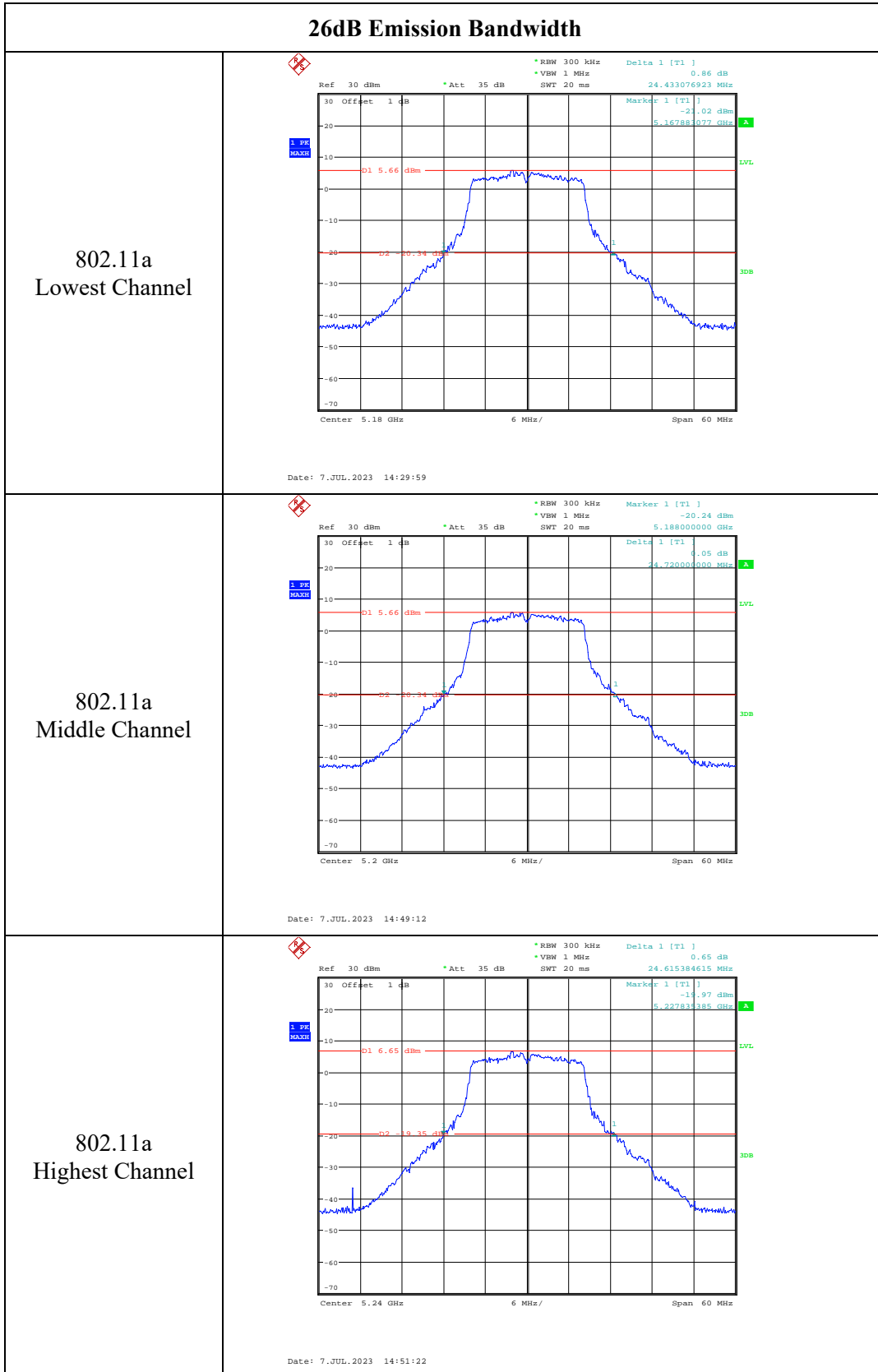

26dB Emission Bandwidth

802.11n ht20
Lowest Channel

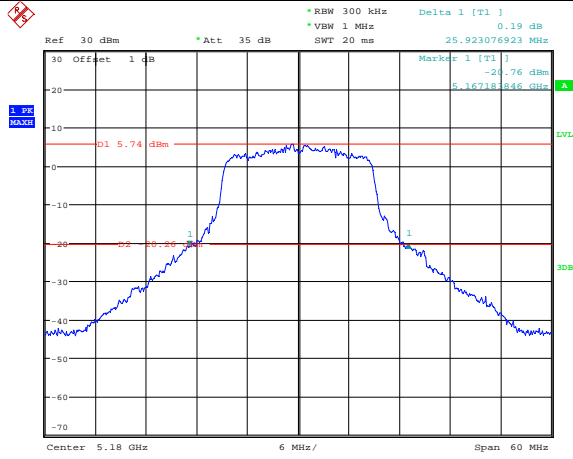

Date: 7.JUL.2023 15:00:49

802.11n ht20
Middle Channel

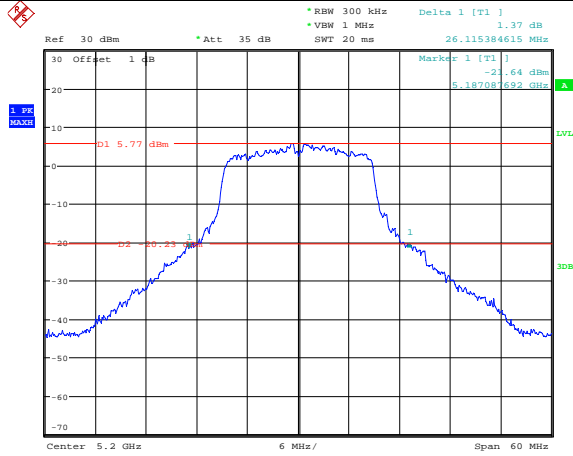

Date: 7.JUL.2023 14:57:49

802.11n ht20
Highest Channel

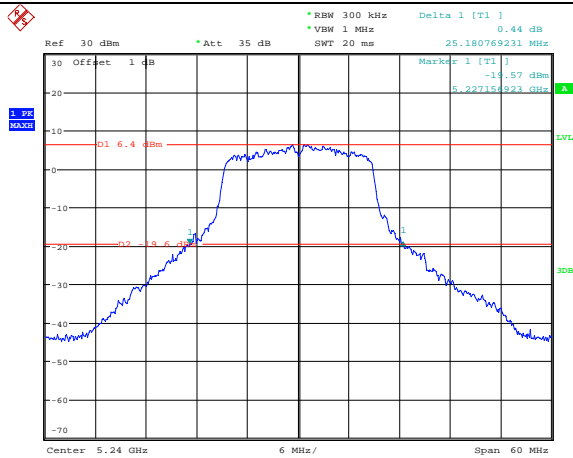

Date: 7.JUL.2023 14:56:19

26dB Emission Bandwidth

802.11n ht40
Lowest Channel

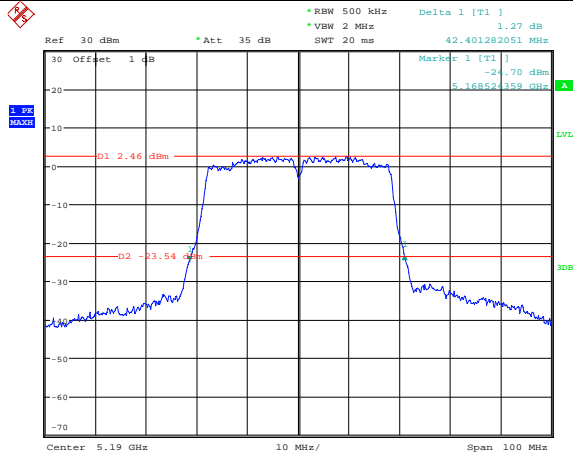

Date: 7.JUL.2023 15:03:40

802.11n ht40
Highest Channel

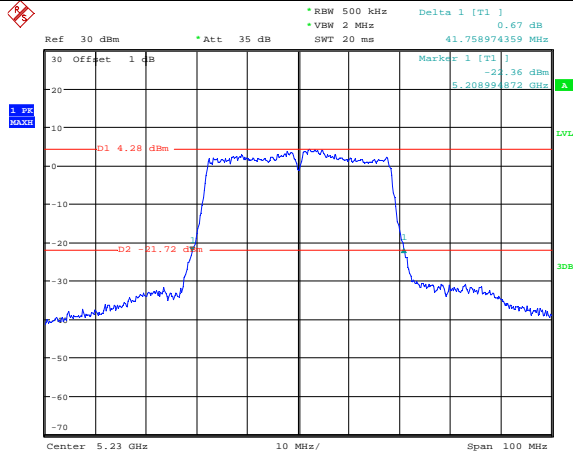

Date: 7.JUL.2023 15:10:26

99% Emission Bandwidth

802.11n ht40
Lowest Channel

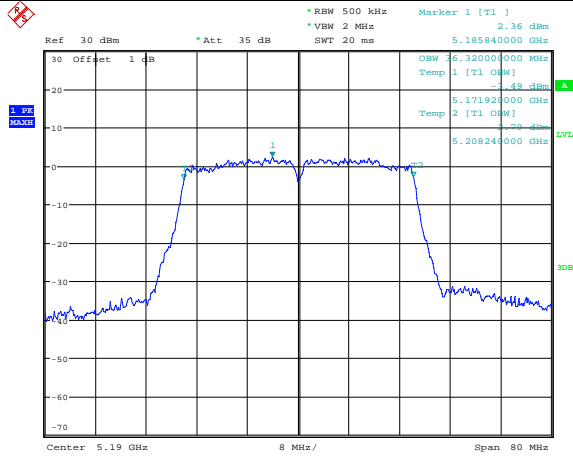

Date: 7.JUL.2023 13:12:44

802.11n ht40
Highest Channel

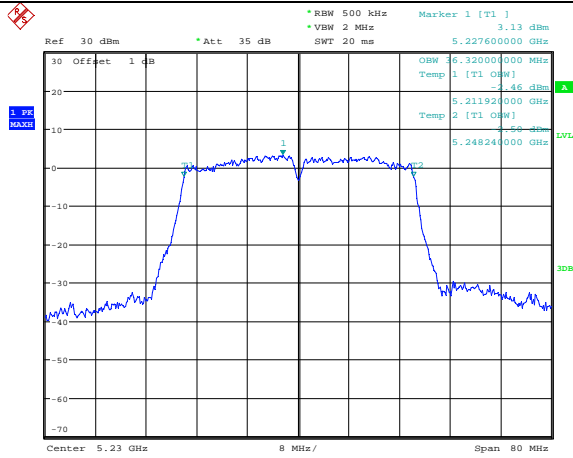

Date: 7.JUL.2023 13:13:33

5250-5350MHz:

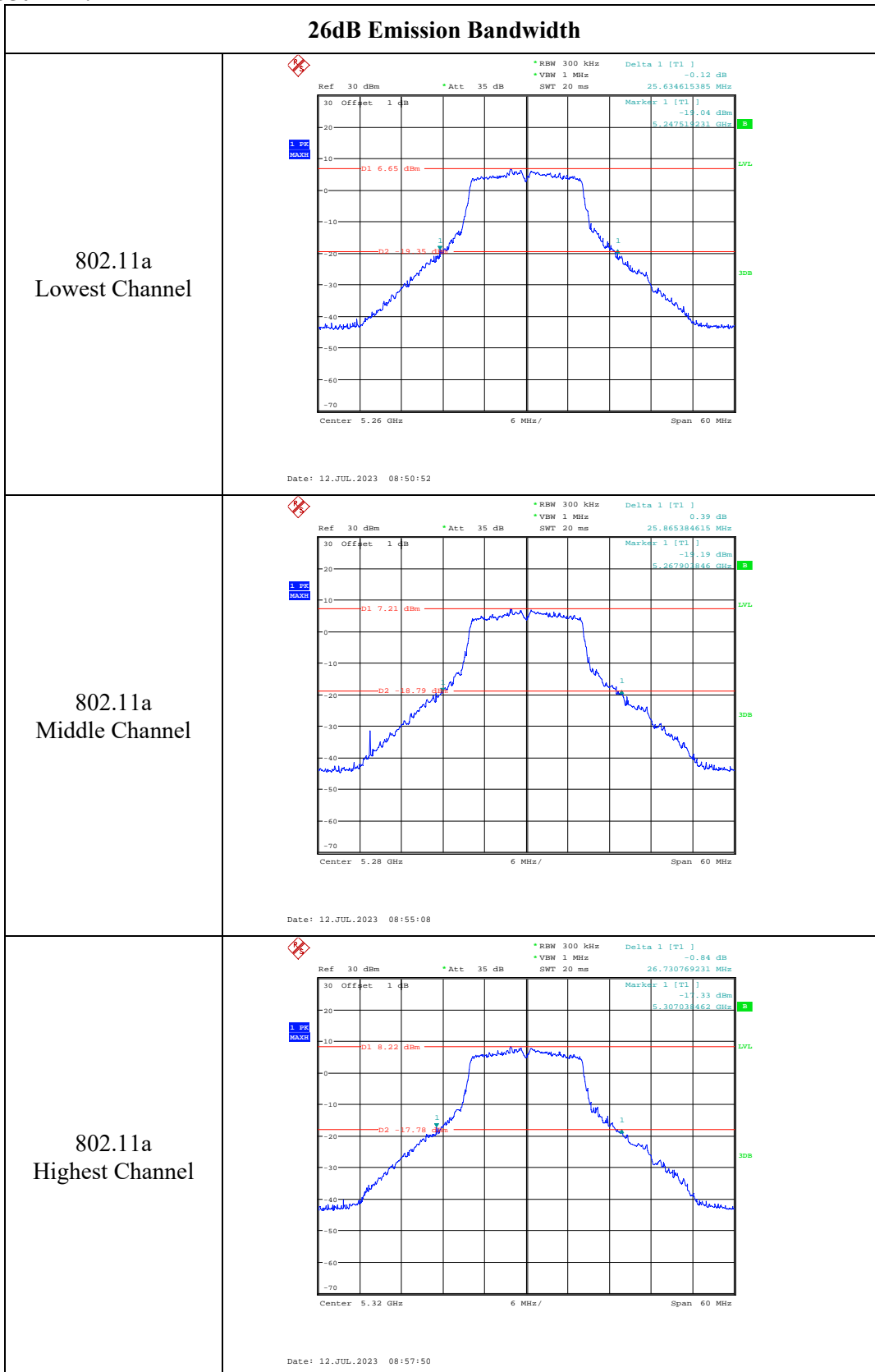

26dB Emission Bandwidth

802.11n ht20
Lowest Channel

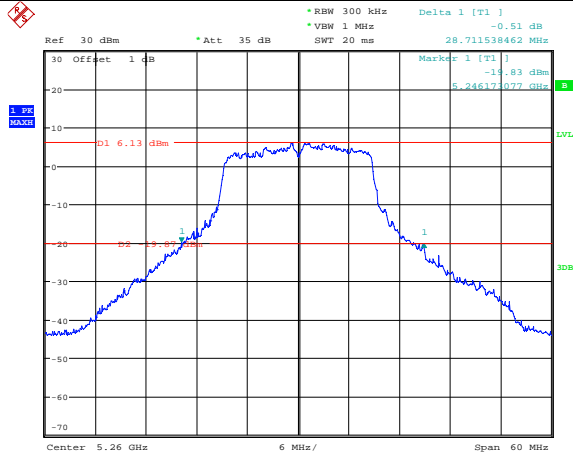

Date: 12.JUL.2023 09:07:12

802.11n ht20
Middle Channel

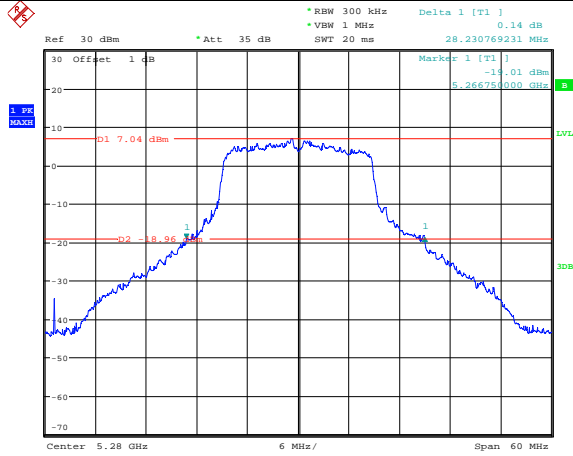

Date: 12.JUL.2023 09:04:25

802.11n ht20
Highest Channel

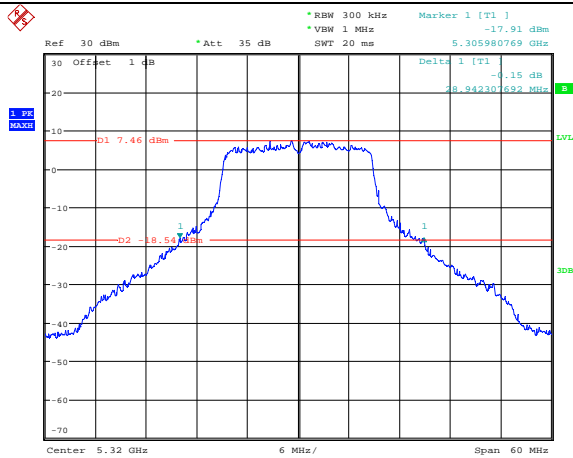

Date: 12.JUL.2023 09:02:09

26dB Emission Bandwidth

802.11n ht40
Lowest Channel

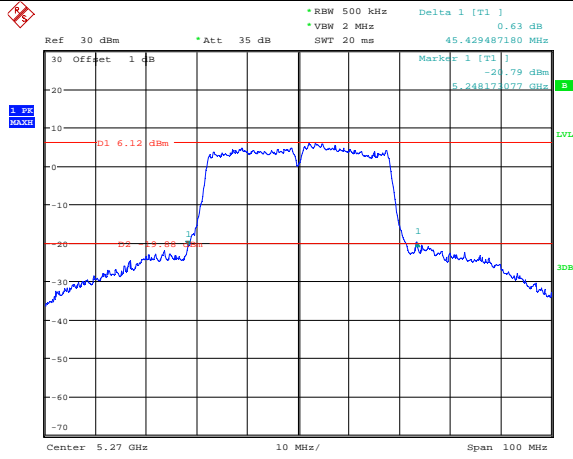

Date: 12.JUL.2023 09:11:09

802.11n ht40
Highest Channel

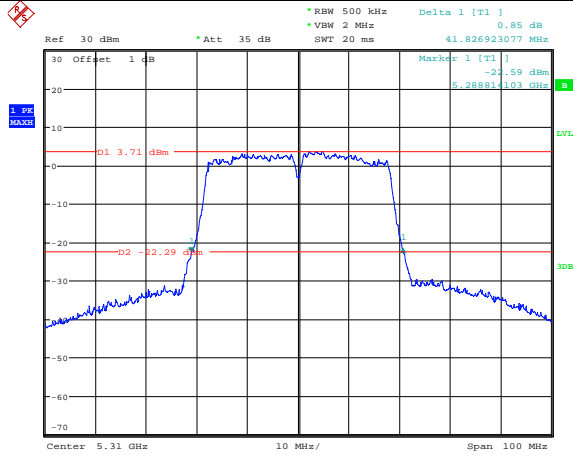

Date: 12.JUL.2023 09:23:59

99% Emission Bandwidth

802.11a
Lowest Channel

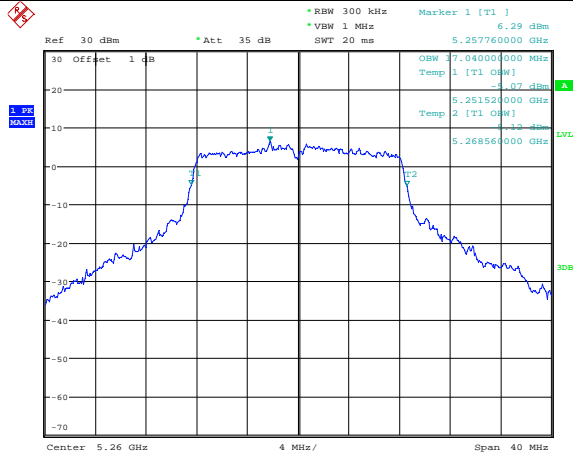

Date: 7.JUL.2023 13:20:43

802.11a
Middle Channel

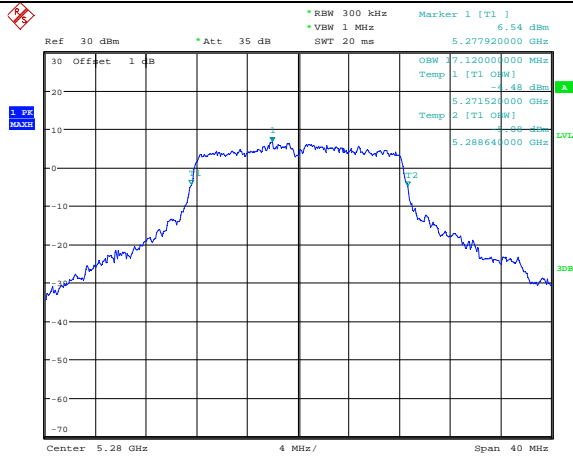

Date: 7.JUL.2023 13:20:06

802.11a
Highest Channel

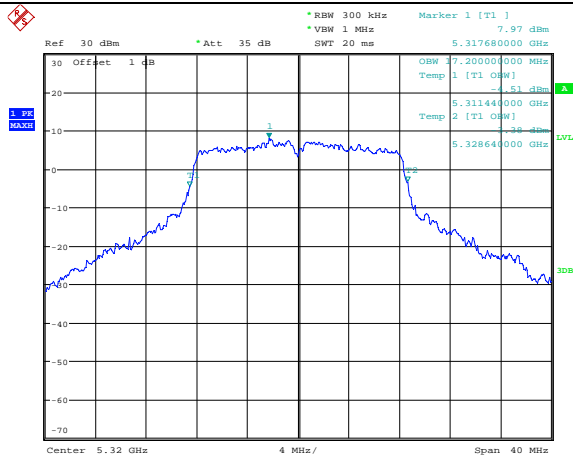

Date: 7.JUL.2023 13:19:27

99% Emission Bandwidth

802.11n ht20
Lowest Channel

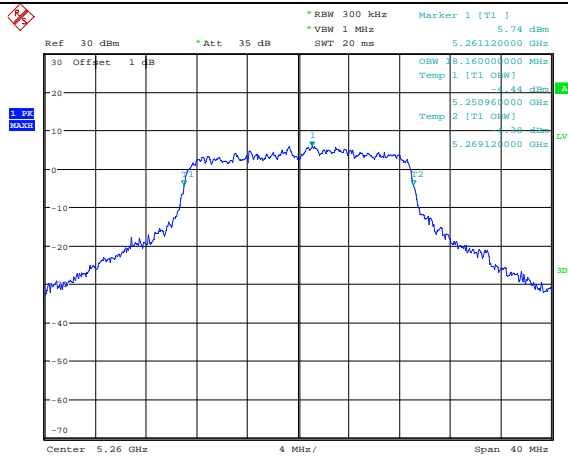

Date: 7.JUL.2023 13:17:16

802.11n ht20
Middle Channel

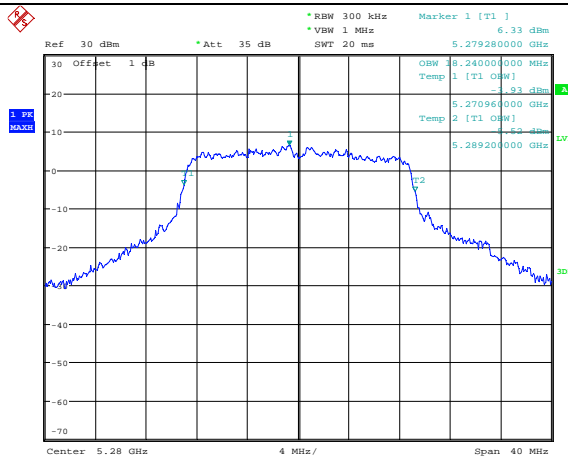

Date: 7.JUL.2023 13:18:01

802.11n ht20
Highest Channel

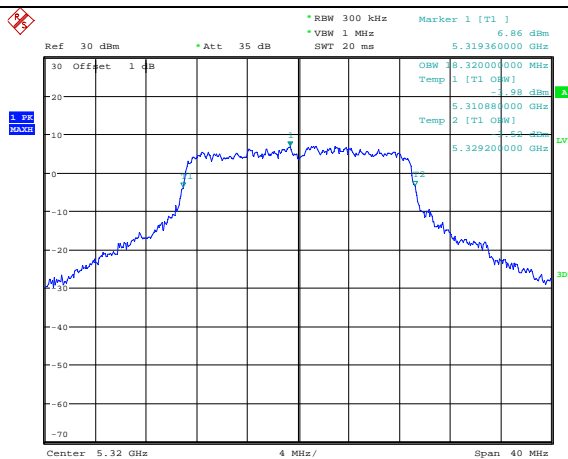

Date: 7.JUL.2023 13:18:42

99% Emission Bandwidth

802.11n ht40
Lowest Channel

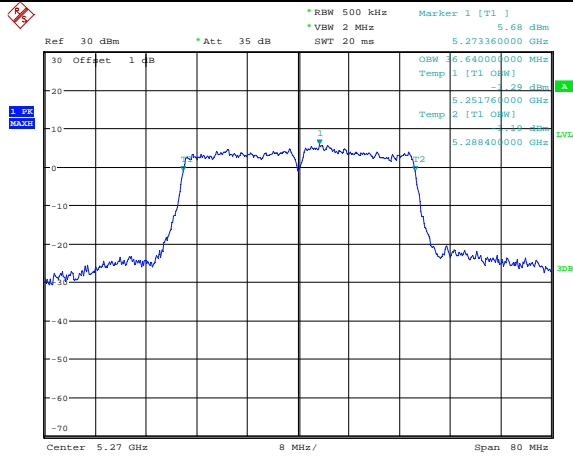

Date: 7.JUL.2023 13:16:21

802.11n ht40
Highest Channel

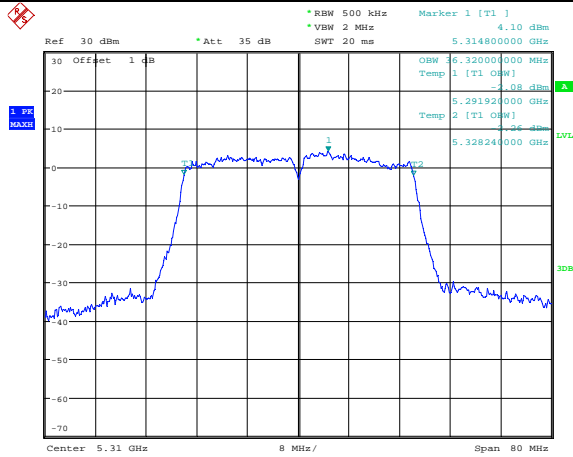

Date: 7.JUL.2023 13:15:26

5470-5725MHz:

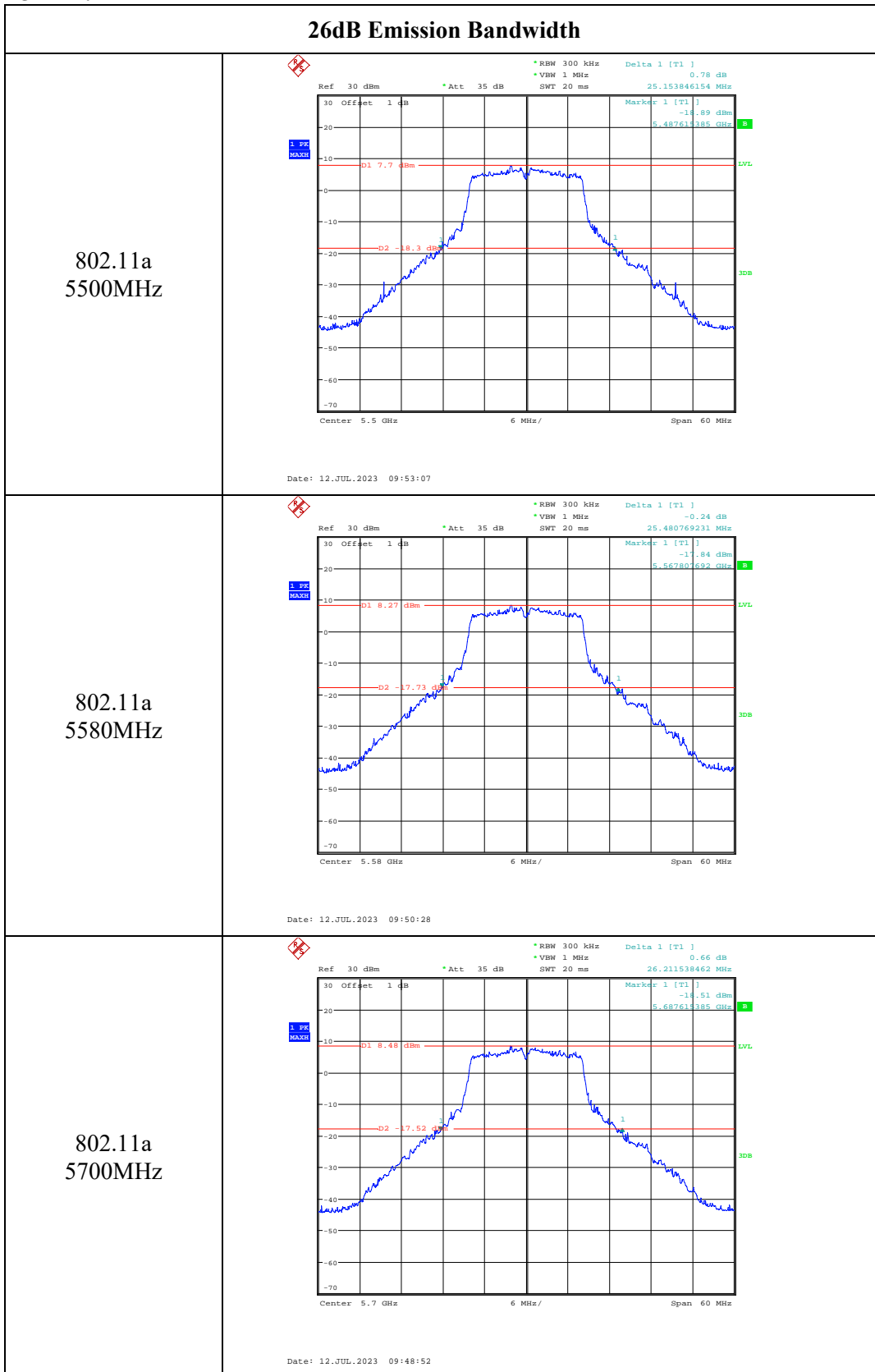

802.11a
5720MHz

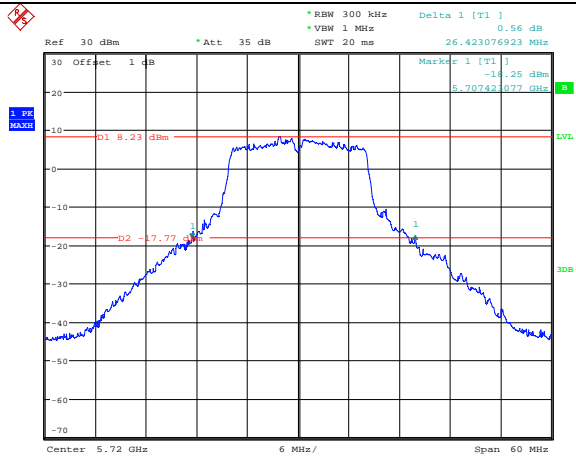

Date: 12.JUL.2023 09:46:15

26dB Emission Bandwidth

802.11n ht20
5500MHz

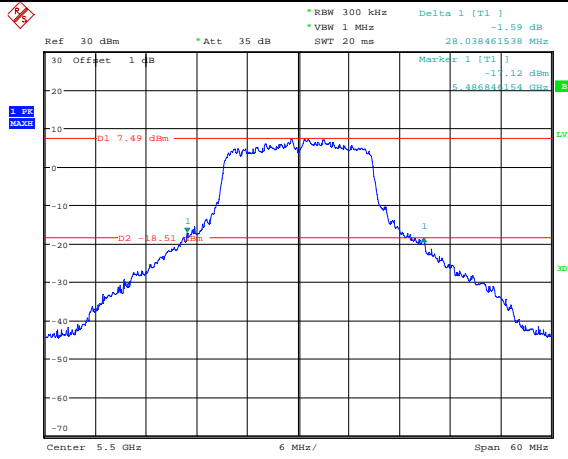

Date: 12.JUL.2023 09:36:51

802.11n ht20
5580MHz

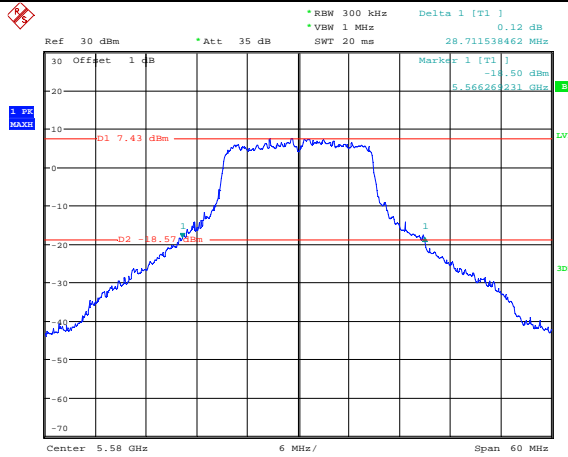

Date: 12.JUL.2023 09:39:22

802.11n ht20
5700MHz

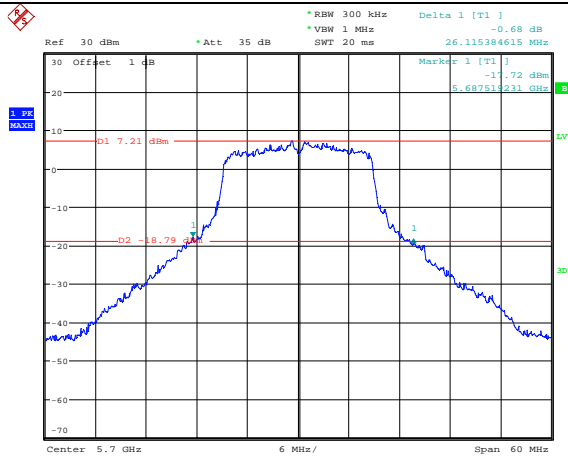

Date: 12.JUL.2023 09:41:29

802.11n ht20
5720MHz

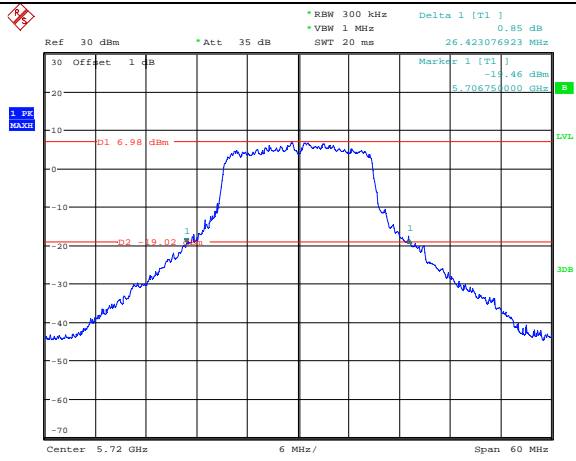

Date: 12.JUL.2023 09:43:54

26dB Emission Bandwidth

802.11n ht40
5510MHz

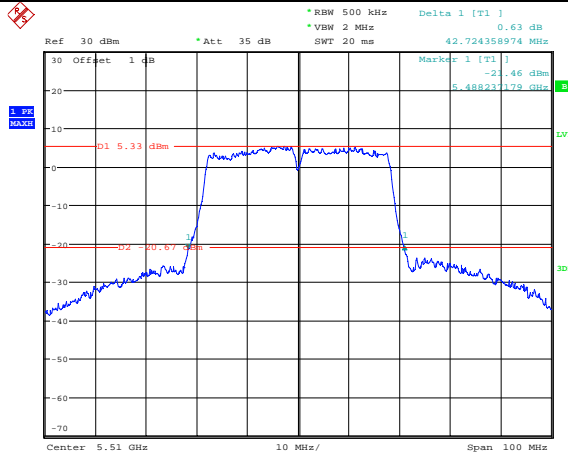

Date: 12.JUL.2023 09:26:19

802.11n ht40
5550MHz

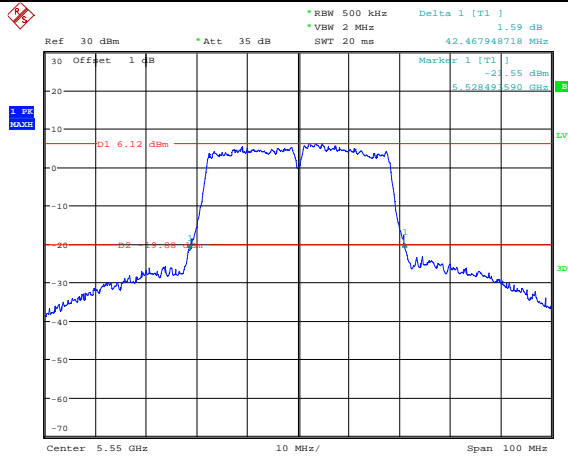

Date: 12.JUL.2023 09:28:18

802.11n ht40
5670MHz

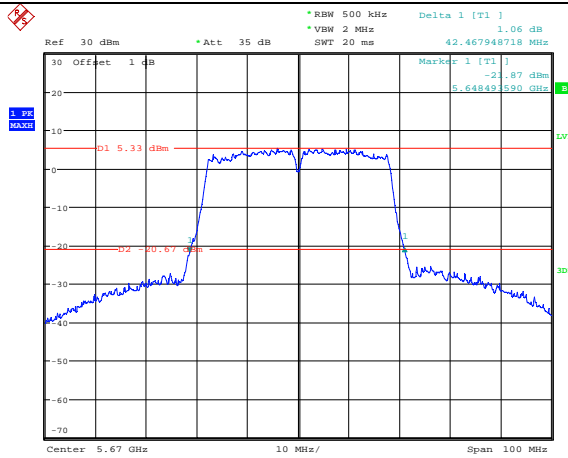

Date: 12.JUL.2023 09:31:47

802.11n ht40
5710MHz

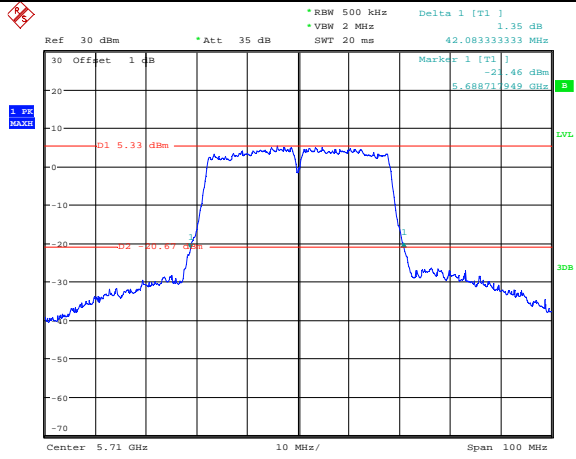

Date: 12.JUL.2023 09:34:19

99% Emission Bandwidth

802.11a
5500MHz

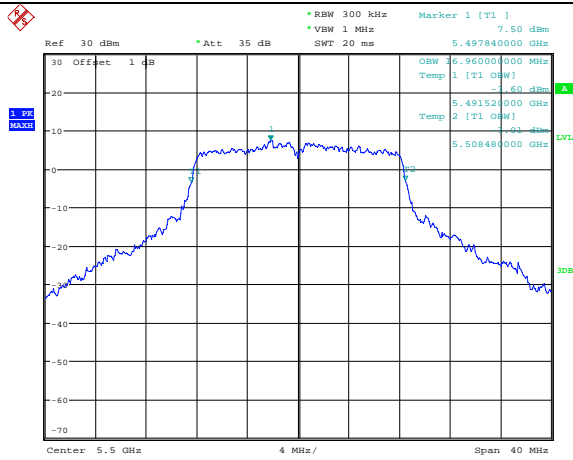

Date: 7.JUL.2023 13:25:11

802.11a
5580MHz

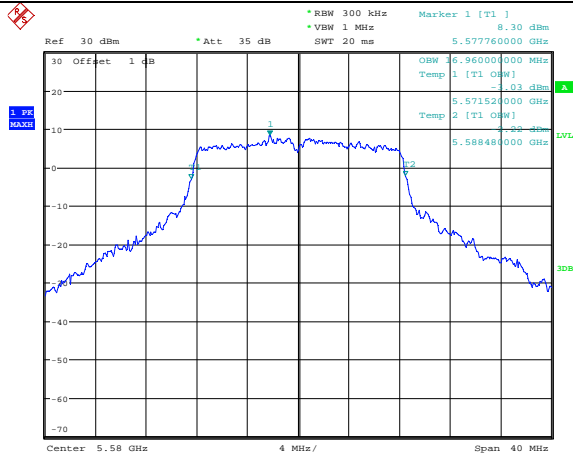

Date: 7.JUL.2023 13:31:28

802.11a
5700MHz

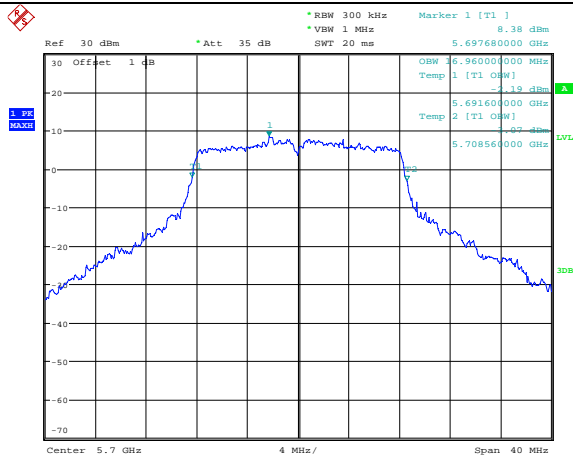

Date: 7.JUL.2023 13:35:02

802.11a
5720MHz

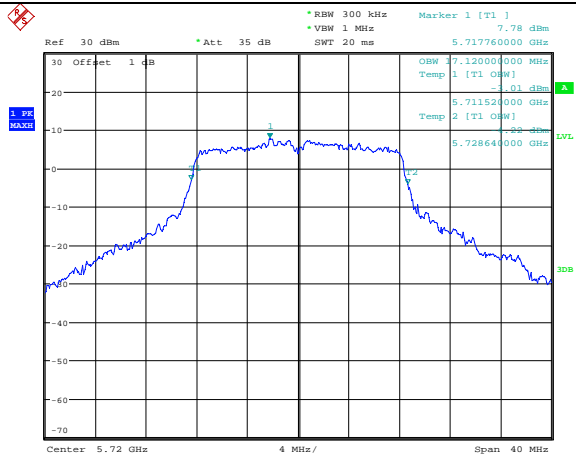

Date: 7.JUL.2023 16:04:25

99% Emission Bandwidth

802.11n ht20
5500MHz

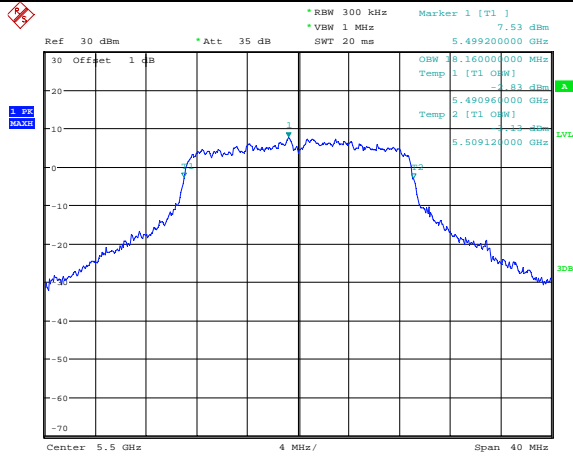

Date: 7.JUL.2023 13:38:53

802.11n ht20
5580MHz

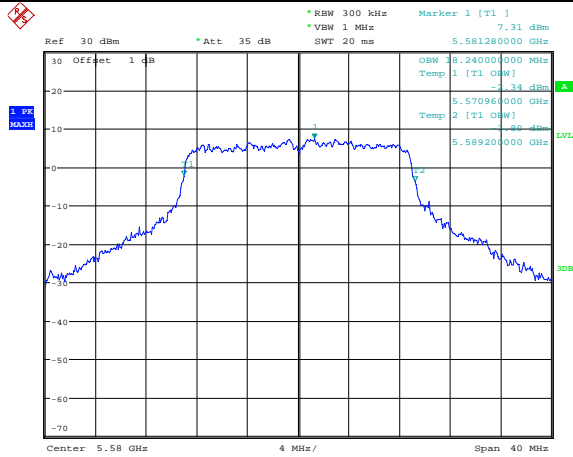

Date: 7.JUL.2023 13:39:38

802.11n ht20
5700MHz

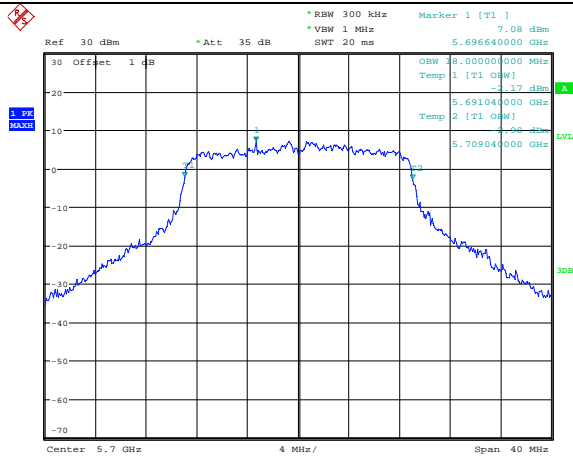

Date: 7.JUL.2023 13:36:14

802.11n ht20
5720MHz

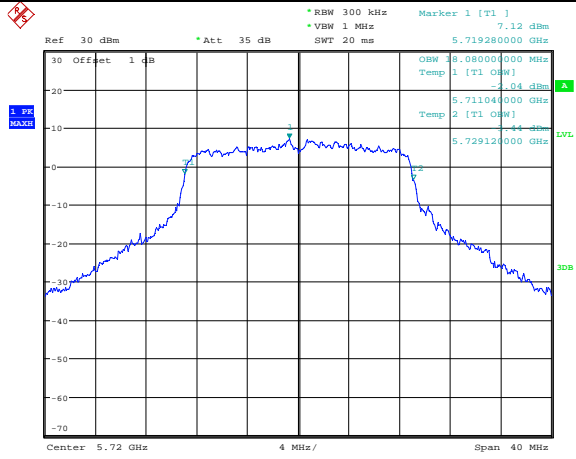

Date: 7.JUL.2023 13:37:39

99% Emission Bandwidth

802.11n ht40
5510MHz

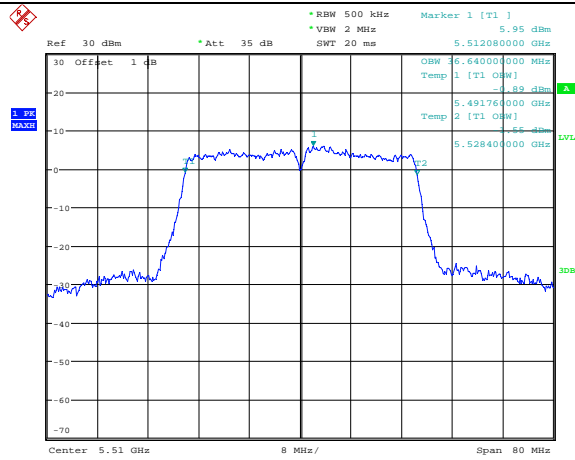

Date: 7.JUL.2023 13:41:13

802.11n ht40
5550MHz

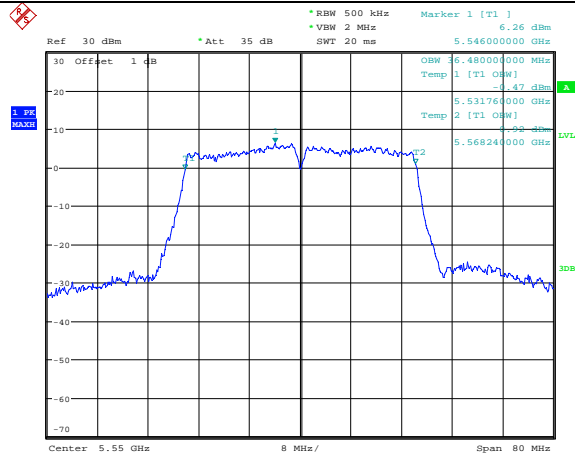

Date: 7.JUL.2023 13:42:02

802.11n ht40
5670MHz

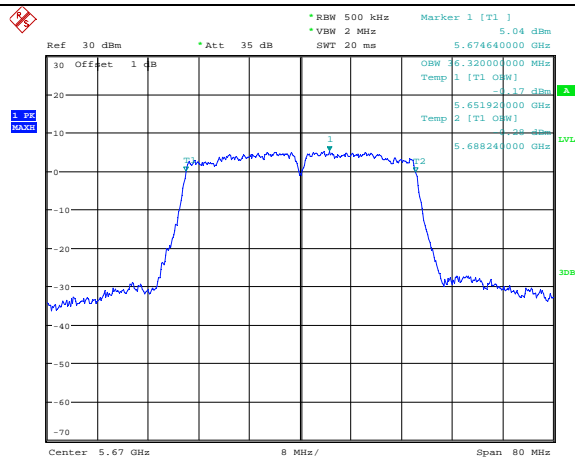

Date: 7.JUL.2023 13:43:04

8802.11n ht40
5710MHz

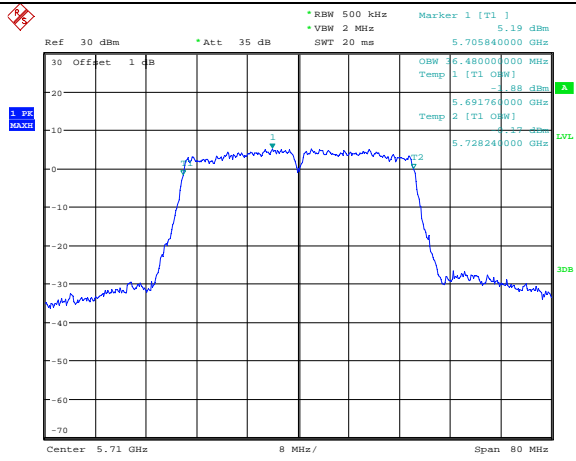

Date: 7.JUL.2023 13:44:34

5725-5850MHz:

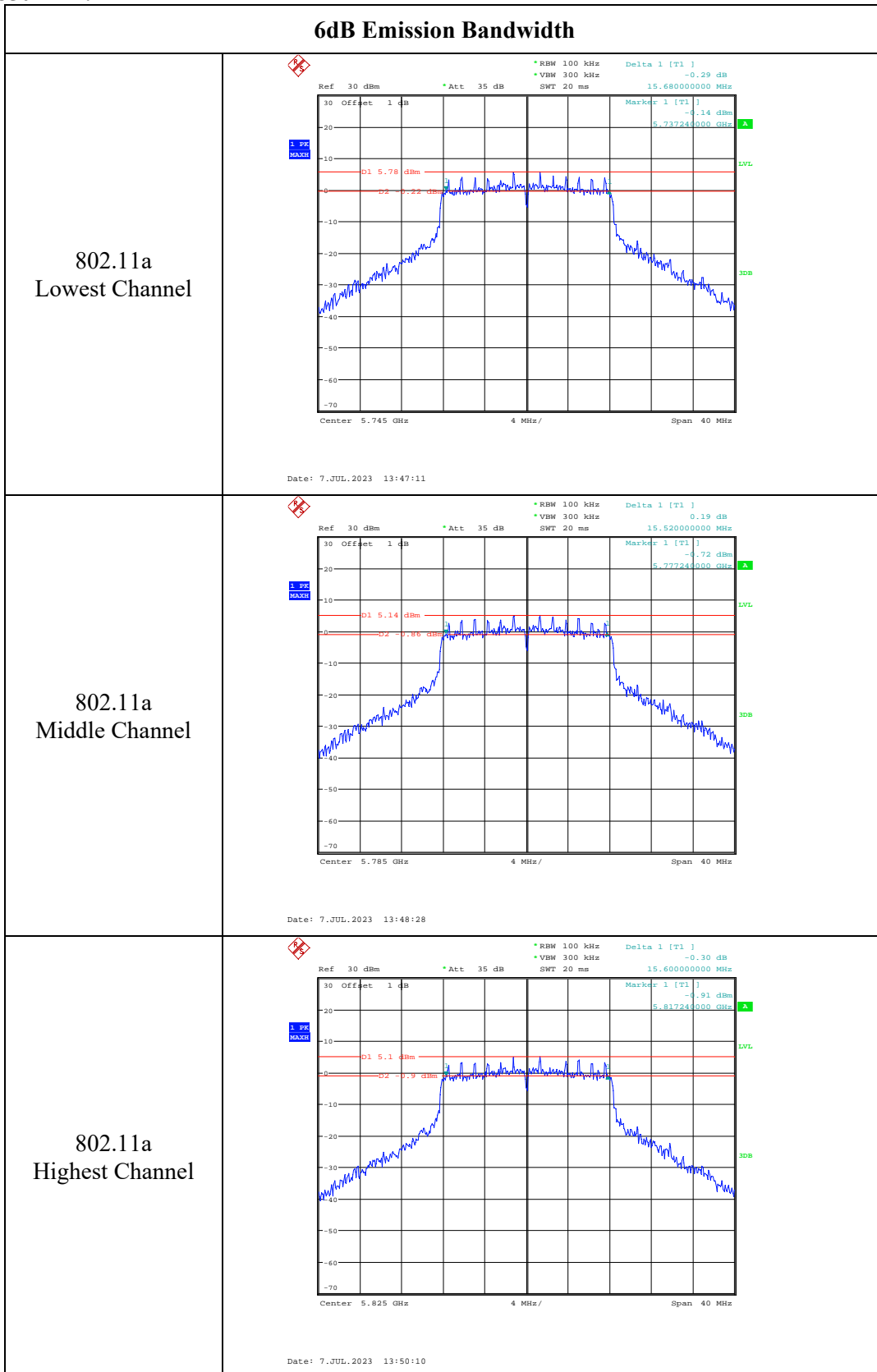

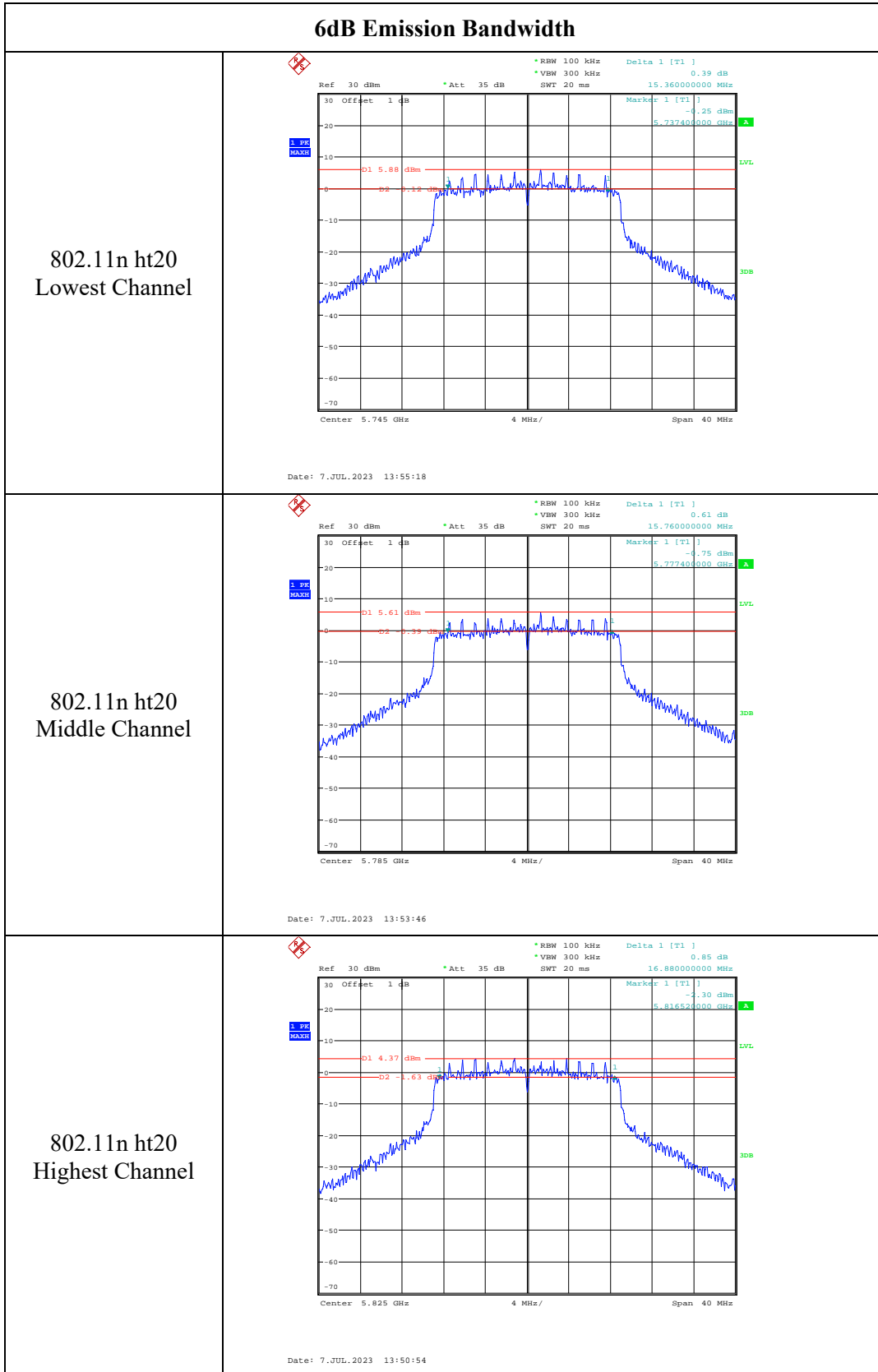

6dB Emission Bandwidth

802.11n ht40
Lowest Channel

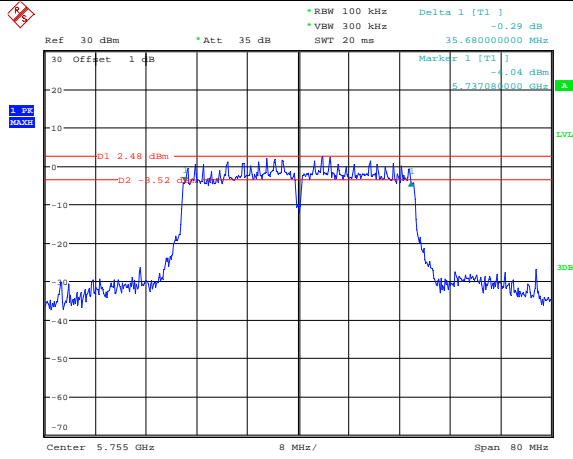

Date: 7.JUL.2023 13:57:23

802.11n ht40
Highest Channel

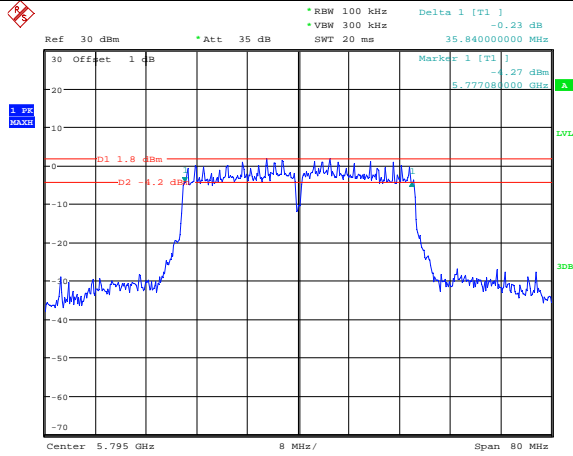

Date: 7.JUL.2023 13:58:37

99% Emission Bandwidth

<p>802.11a Lowest Channel</p>	<p>Ref 30 dBm * Att 35 dB * RBW 300 kHz Marker 1 [T1] * VBW 1 MHz 5.742760000 GHz SWT 20 ms</p> <p>OBW 17.04000000 MHz Temp 1 [T1 OBW] 8.57 dBm Temp 2 [T1 OBW] -1.87 dBm</p> <p>5.736520000 GHz Temp 1 [T1 OBW] 1.39 dBm Temp 2 [T1 OBW] -1.35 dBm</p> <p>5.753560000 GHz</p> <p>Center 5.745 GHz 4 MHz/ Span 40 MHz</p> <p>Date: 7.JUL.2023 13:46:16</p>
<p>802.11a Middle Channel</p>	<p>Ref 30 dBm * Att 35 dB * RBW 300 kHz Marker 1 [T1] * VBW 1 MHz 5.782760000 GHz SWT 20 ms</p> <p>OBW 17.04000000 MHz Temp 1 [T1 OBW] 8.05 dBm Temp 2 [T1 OBW] 1.39 dBm</p> <p>5.776520000 GHz Temp 1 [T1 OBW] 1.39 dBm Temp 2 [T1 OBW] -1.35 dBm</p> <p>5.793560000 GHz</p> <p>Center 5.785 GHz 4 MHz/ Span 40 MHz</p> <p>Date: 7.JUL.2023 13:49:09</p>
<p>802.11a Highest Channel</p>	<p>Ref 30 dBm * Att 35 dB * RBW 300 kHz Marker 1 [T1] * VBW 1 MHz 5.822680000 GHz SWT 20 ms</p> <p>OBW 17.04000000 MHz Temp 1 [T1 OBW] 7.93 dBm Temp 2 [T1 OBW] -1.36 dBm</p> <p>5.816520000 GHz Temp 1 [T1 OBW] 1.39 dBm Temp 2 [T1 OBW] -1.33 dBm</p> <p>5.833560000 GHz</p> <p>Center 5.825 GHz 4 MHz/ Span 40 MHz</p> <p>Date: 7.JUL.2023 13:49:45</p>

99% Emission Bandwidth

802.11n ht20
Lowest Channel

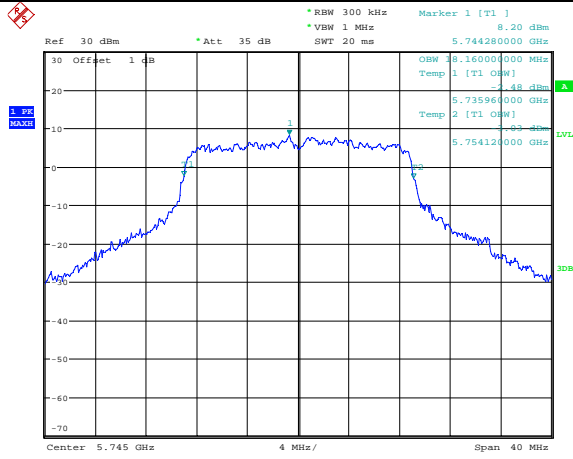

Date: 7.JUL.2023 13:56:08

802.11n ht20
Middle Channel

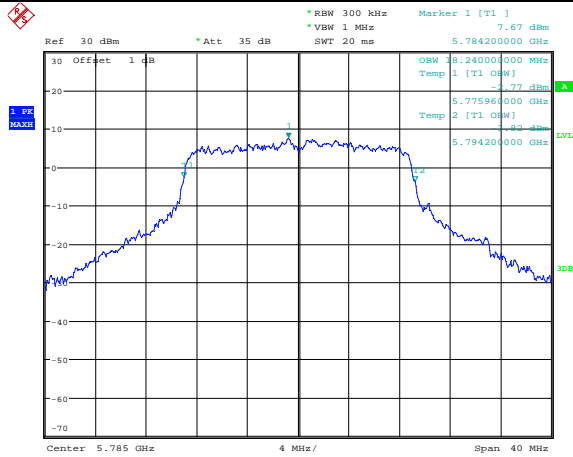

Date: 7.JUL.2023 13:52:22

802.11n ht20
Highest Channel

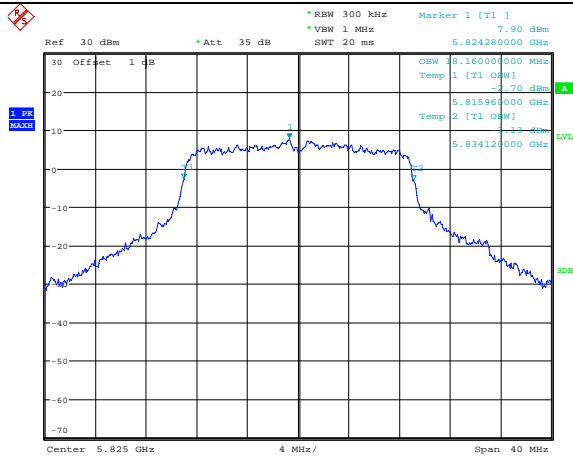

Date: 7.JUL.2023 13:51:30

99% Emission Bandwidth

802.11n ht40
Lowest Channel

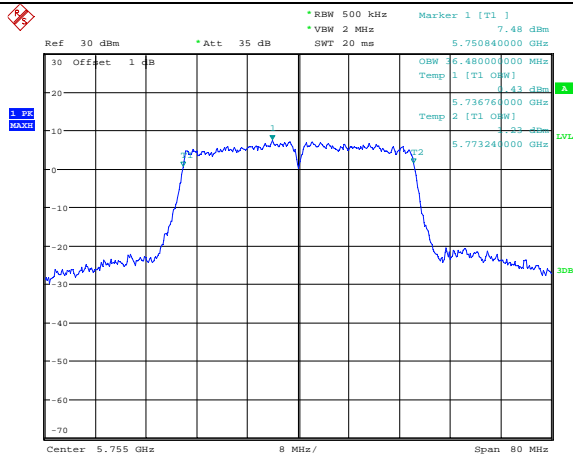

Date: 7.JUL.2023 13:56:58

802.11n ht40
Highest Channel

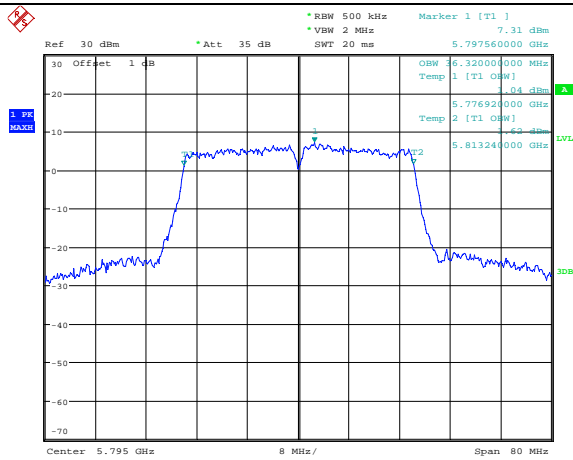

Date: 7.JUL.2023 13:59:16

4.5 Maximum Conducted Output Power

Serial Number:	1TRF	Test Date:	2023/7/7~2023/7/12
Test Site:	RF	Test Mode:	Transmitting
Tester:	Claire Liu	Test Result:	Pass

Environmental Conditions:

Temperature: (°C)	24.8~26.2	Relative Humidity: (%)	51~62	ATM Pressure: (kPa)	99.7~100.6
----------------------	-----------	------------------------------	-------	------------------------	------------

Test Equipment List and Details:

Manufacturer	Description	Model	Serial Number	Calibration Date	Calibration Due Date
YINSAIGE	Coaxial Cable	SS402	SJ0100002	Each time	N/A
Agilent	USB Wideband Power Sensor	U2021XA	MY54080015	2022/7/15	2023/7/14

* Statement of Traceability: China Certification ICT Co., Ltd (Dongguan) attests that all calibrations have been performed, traceable to National Primary Standards and International System of Units (SI).

Test Data:

5150-5250 MHz:

Test Modes	Test Frequency (MHz)	Max. Conducted Average Output Power (dBm)				EIRP (dBm)	
		Chain 0	Chain 1	Total	FCC Limit	Result	RSS-247 Limit
802.11a	5180	12.78	12.64	/	24	13.48	22.29
	5200	12.76	12.85	/	24	13.55	22.27
	5240	13.82	13.91	/	24	14.61	22.29
802.11n ht20	5180	12.97	12.94	15.97	24	16.67	22.55
	5200	13.05	12.99	16.03	24	16.73	22.61
	5240	13.74	13.82	16.79	24	17.49	22.55
802.11n ht40	5190	11.56	12.37	14.99	24	15.69	23
	5230	12.03	11.89	14.97	24	15.67	23

Note:

The device is a client device.

The device employed Cyclic Delay Diversity (CDD) for 802.11 MIMO transmitting, per KDB 662911 D01 Multiple Transmitter Output v02r01, for power measurements on IEEE 802.11 devices:

Array Gain = 0 dB (i.e., no array gain) for $N_{ANT} \leq 4$

Antenna Gain:	0.7	dBi	Directional gain:	0.7	dBi
---------------	-----	-----	-------------------	-----	-----

5250-5350 MHz:

Test Modes	Test Frequency (MHz)	Max. Conducted Average Output Power (dBm)					EIRP (dBm)	
		Chain 0	Chain 1	Total	FCC Limit	RSS-247 Limit	Result	RSS-247 Limit
802.11a	5260	11.78	13.85	/	24	23.31	15.75	29.31
	5280	12.98	14.08	/	24	23.34	15.98	29.34
	5320	14.82	14.73	/	24	23.36	16.63	29.36
802.11n ht20	5260	13.91	14.01	16.97	24	23.59	18.87	29.59
	5280	13.69	13.79	16.75	24	23.61	18.65	29.61
	5320	14.53	14.78	17.67	24	23.63	19.57	29.63
802.11n ht40	5270	13.98	14.03	17.02	24	24	18.92	30
	5310	12.01	11.97	15.00	24	24	16.9	30
<p>Note: The device is a client device. The device employed Cyclic Delay Diversity (CDD) for 802.11 MIMO transmitting, per KDB 662911 D01 Multiple Transmitter Output v02r01, for power measurements on IEEE 802.11 devices: Array Gain = 0 dB (i.e., no array gain) for $N_{ANT} \leq 4$</p>								
Antenna Gain:		1.9	dBi	Directional gain:		1.9	dBi	

5470-5725 MHz:

Test Modes	Test Frequency (MHz)	Max. Conducted Average Output Power (dBm)					EIRP (dBm)	
		Chain 0	Chain 1	Total	FCC Limit	RSS-247 Limit	Result	RSS-247 Limit
802.11a	5500	14.96	15.03	/	24	23.29	18.03	29.29
	5580	15.65	15.78	/	24	23.29	18.78	29.29
	5700	15.57	15.61	/	24	23.29	18.61	29.29
	5720	15.39	15.47	/	24	23.34	18.47	29.34
802.11n ht20	5500	14.91	15.03	17.98	24	23.59	20.98	29.59
	5580	15.55	15.78	18.68	24	23.61	21.68	29.61
	5700	14.56	14.61	17.60	24	23.55	20.6	29.55
	5720	14.37	14.45	17.42	24	23.57	20.42	29.57
802.11n ht40	5510	14.43	14.61	17.53	24	24	20.53	30
	5550	14.67	14.72	17.71	24	24	20.71	30
	5670	14.29	14.56	17.44	24	24	20.44	30
	5710	13.85	14.01	16.94	24	24	19.94	30
Note: The device is a client device. The device employed Cyclic Delay Diversity (CDD) for 802.11 MIMO transmitting, per KDB 662911 D01 Multiple Transmitter Output v02r01, for power measurements on IEEE 802.11 devices: Array Gain = 0 dB (i.e., no array gain) for $N_{ANT} \leq 4$								
Antenna Gain:		3	dBi	Directional gain:		3	dBi	

5725-5850 MHz:

Test Modes	Test Frequency (MHz)	Max. Conducted Average Output Power (dBm)					
		Chain 0	Chain 1	Total	Limit		
802.11a	5745	15.81	14.67	/	30		
	5785	15.57	14.39	/	30		
	5825	15.12	13.97	/	30		
802.11n ht20	5745	15.73	14.38	18.12	30		
	5785	15.37	14.17	17.82	30		
	5825	14.97	13.82	17.44	30		
802.11n ht40	5755	15.88	14.79	18.38	30		
	5795	15.67	14.16	17.99	30		
Note: The device employed Cyclic Delay Diversity (CDD) for 802.11 MIMO transmitting, per KDB 662911 D01 Multiple Transmitter Output v02r01, for power measurements on IEEE 802.11 devices: Array Gain = 0 dB (i.e., no array gain) for $N_{ANT} \leq 4$							
Antenna Gain:		2.8	dBi	Directional gain:		2.8	dBi

4.6 Maximum power spectral density

Serial Number:	1TRF	Test Date:	2023/7/7~2023/7/12
Test Site:	RF	Test Mode:	Transmitting
Tester:	Claire Liu	Test Result:	Pass

Environmental Conditions:					
Temperature: (°C)	24.8~26.2	Relative Humidity: (%)	51~62	ATM Pressure: (kPa)	99.7~100.6

Test Equipment List and Details:

Manufacturer	Description	Model	Serial Number	Calibration Date	Calibration Due Date
R&S	Spectrum Analyzer	FSU26	200256	2022/7/15	2023/7/14
YINSAIGE	Coaxial Cable	SS402	SJ0100002	Each time	N/A

* Statement of Traceability: China Certification ICT Co., Ltd (Dongguan) attests that all calibrations have been performed, traceable to National Primary Standards and International System of Units (SI).

Test Data:

5150-5250 MHz:

Test Modes	Test Frequency (MHz)	Reading (dBm/MHz)		Duty Cycle Factor (dB)	Maximum Conducted Power Spectral Density (dBm/MHz)		Maximum EIRP Power Spectral Density (dBm/MHz)	
		Chain 0	Chain 1		Total	FCC Limit	Result	RSS-247 Limit
802.11a	5180	3.99	4.01	/	/	11	4.71	10
	5200	4.04	4.42	/	/	11	5.12	10
	5240	4.32	4.45	/	/	11	5.15	10
802.11n ht20	5180	3.56	3.79	0.61	7.3	11	8	10
	5200	3.56	3.95	0.61	7.38	11	8.08	10
	5240	3.87	4.01	0.61	7.56	11	8.26	10
802.11n ht40	5190	-1.05	-0.63	/	2.18	11	2.88	10
	5230	-0.82	-0.44	/	2.38	11	3.08	10

Note:

The device is a client device.

The device employed Cyclic Delay Diversity (CDD) for 802.11 MIMO transmitting, per KDB 662911 D01 Multiple Transmitter Output v02r01, for power spectral density (PSD) measurements on the devices:

Array Gain = $10 \log(NANT/NSS)$ dB.

So:

Directional gain = $GANT + \text{Array Gain} = 0.7 + 10 * \log(2/1) = 3.7$ dBi

Duty cycle >98%

KDB 789033 D02 General UNII Test Procedures New Rules v02r01 Method SA-1 was used.

Duty cycle <98%, duty cycle variations are less than $\pm 2\%$

KDB 789033 D02 General UNII Test Procedures New Rules v02r01 Method SA-2 should be applied.

5250-5350 MHz:

Test Modes	Test Frequency (MHz)	Reading (dBm/MHz)		Duty Cycle Factor (dB)	Maximum Conducted Power Spectral Density (dBm/MHz)	
		Chain 0	Chain 1		Total	Limit
802.11a	5260	2.78	4.2	/	/	11
	5280	3.38	4.46	/	/	11
	5320	4.47	4.73	/	/	11
802.11n ht20	5260	2.57	3.8	0.61	6.85	11
	5280	3.16	4.02	0.61	7.23	11
	5320	3.64	4.25	0.61	7.58	11
802.11n ht40	5270	0.4	1.07	/	3.76	11
	5310	-1.23	-1.32	/	1.74	11

Note:

The device is a client device.

The device employed Cyclic Delay Diversity (CDD) for 802.11 MIMO transmitting, per KDB 662911 D01 Multiple Transmitter Output v02r01, for power spectral density (PSD) measurements on the devices:

Array Gain = $10 \log(NANT/NSS)$ dB.

So:

Directional gain = GANT + Array Gain = $1.9 + 10 \cdot \log(2/1) = 4.9$ dBi

Duty cycle >98%

KDB 789033 D02 General UNII Test Procedures New Rules v02r01 Method SA-1 was used.

Duty cycle <98%, duty cycle variations are less than $\pm 2\%$

KDB 789033 D02 General UNII Test Procedures New Rules v02r01 Method SA-2 should be applied.

5470-5725 MHz:

Test Modes	Test Frequency (MHz)	Reading (dBm/MHz)		Duty Cycle Factor (dB)	Maximum Conducted Power Spectral Density (dBm/MHz)	
		Chain 0	Chain 1		Total	Limit
802.11a	5500	3.92	4.43	/	/	11
	5580	4.43	4.58	/	/	11
	5700	4.83	4.1	/	/	11
	5720	4.72	4.32	/	/	11
802.11n ht20	5500	3.88	3.96	0.61	7.54	11
	5580	4.46	4.18	0.61	7.94	11
	5700	3.78	2.89	0.61	6.98	11
	5720	3.3	3.16	0.61	6.85	11
802.11n ht40	5510	0.29	0.29	/	3.3	11
	5550	0.74	0.75	/	3.76	11
	5670	-0.2	-0.23	/	2.8	11
	5710	0.08	-0.38	/	2.87	11

Note:

The device is a client device.

The device employed Cyclic Delay Diversity (CDD) for 802.11 MIMO transmitting, per KDB 662911 D01 Multiple Transmitter Output v02r01, for power spectral density (PSD) measurements on the devices:

Array Gain = $10 \log(NANT/NSS)$ dB.

So:

Directional gain = GANT + Array Gain = $3 + 10 * \log(2/1) = 6$ dBi

Duty cycle >98%

KDB 789033 D02 General UNII Test Procedures New Rules v02r01 Method SA-1 was used.

Duty cycle <98%, duty cycle variations are less than $\pm 2\%$

KDB 789033 D02 General UNII Test Procedures New Rules v02r01 Method SA-2 should be applied.

Test Modes	Test Frequency (MHz)	Reading (dBm/500kHz)		Duty Cycle Factor (dB)	Maximum Conducted Power Spectral Density (dBm/500kHz)	
		Chain 0	Chain 1		Total	Limit
802.11a	5745	1.83	0.66	/	/	30
	5785	1.59	0.22	/	/	30
	5825	1.56	0.82	/	/	30
802.11n ht20	5745	1.49	0.02	0.61	4.44	30
	5785	1.15	0.54	0.61	4.48	30
	5825	0.88	0.95	0.61	4.54	30
802.11n ht40	5755	-1.12	-2.33	/	1.33	30
	5795	-1.58	-2.1	/	1.18	30

Note:

The device is a client device.

The device employed Cyclic Delay Diversity (CDD) for 802.11 MIMO transmitting, per KDB 662911 D01 Multiple Transmitter Output v02r01, for power spectral density (PSD) measurements on the devices:

Array Gain = $10 \log(NANT/NSS)$ dB.

So:

Directional gain = GANT + Array Gain = $2.8 + 10 * \log(2/1) = 5.8$ dBi

Duty cycle >98%

KDB 789033 D02 General UNII Test Procedures New Rules v02r01 Method SA-1 was used.

Duty cycle <98%, duty cycle variations are less than $\pm 2\%$

KDB 789033 D02 General UNII Test Procedures New Rules v02r01 Method SA-2 should be applied.

Maximum power spectral density

802.11n ht20
Lowest Channel

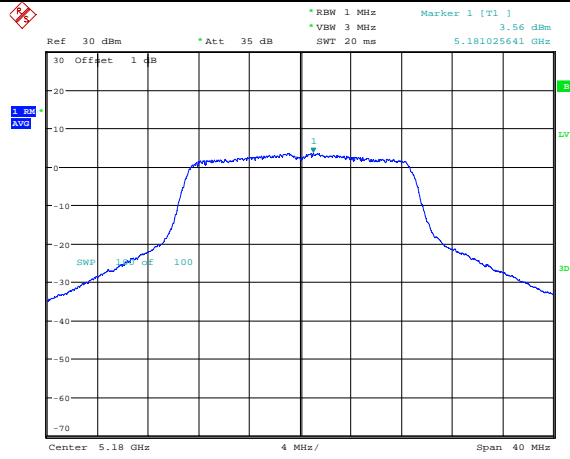

Date: 12.JUL.2023 11:41:02

802.11n ht20
Middle Channel

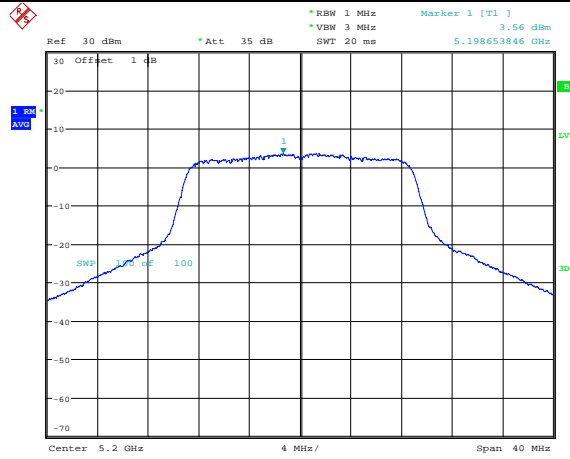

Date: 12.JUL.2023 11:40:29

802.11n ht20
Highest Channel

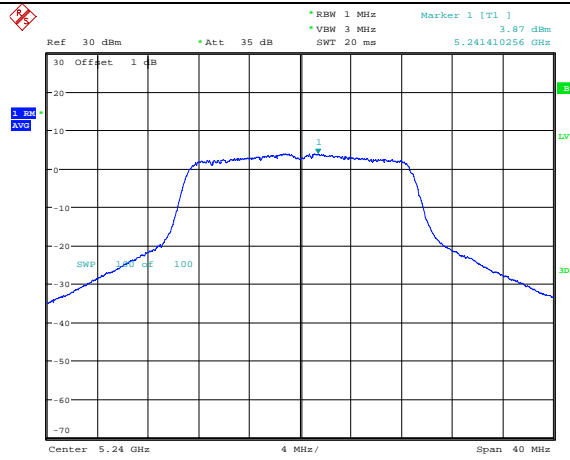

Date: 12.JUL.2023 11:39:53

Maximum power spectral density

802.11n ht40
Lowest Channel

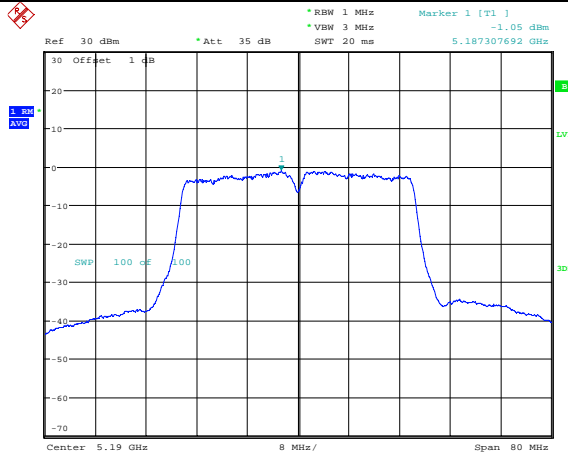

Date: 12.JUL.2023 11:41:52

802.11n ht40
Highest Channel

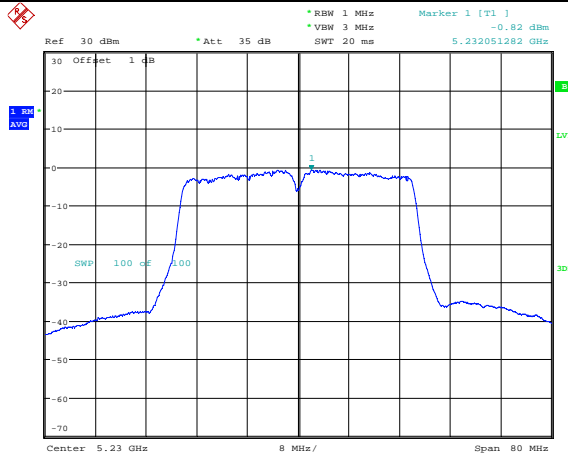

Date: 12.JUL.2023 11:42:36

5250-5350MHz:

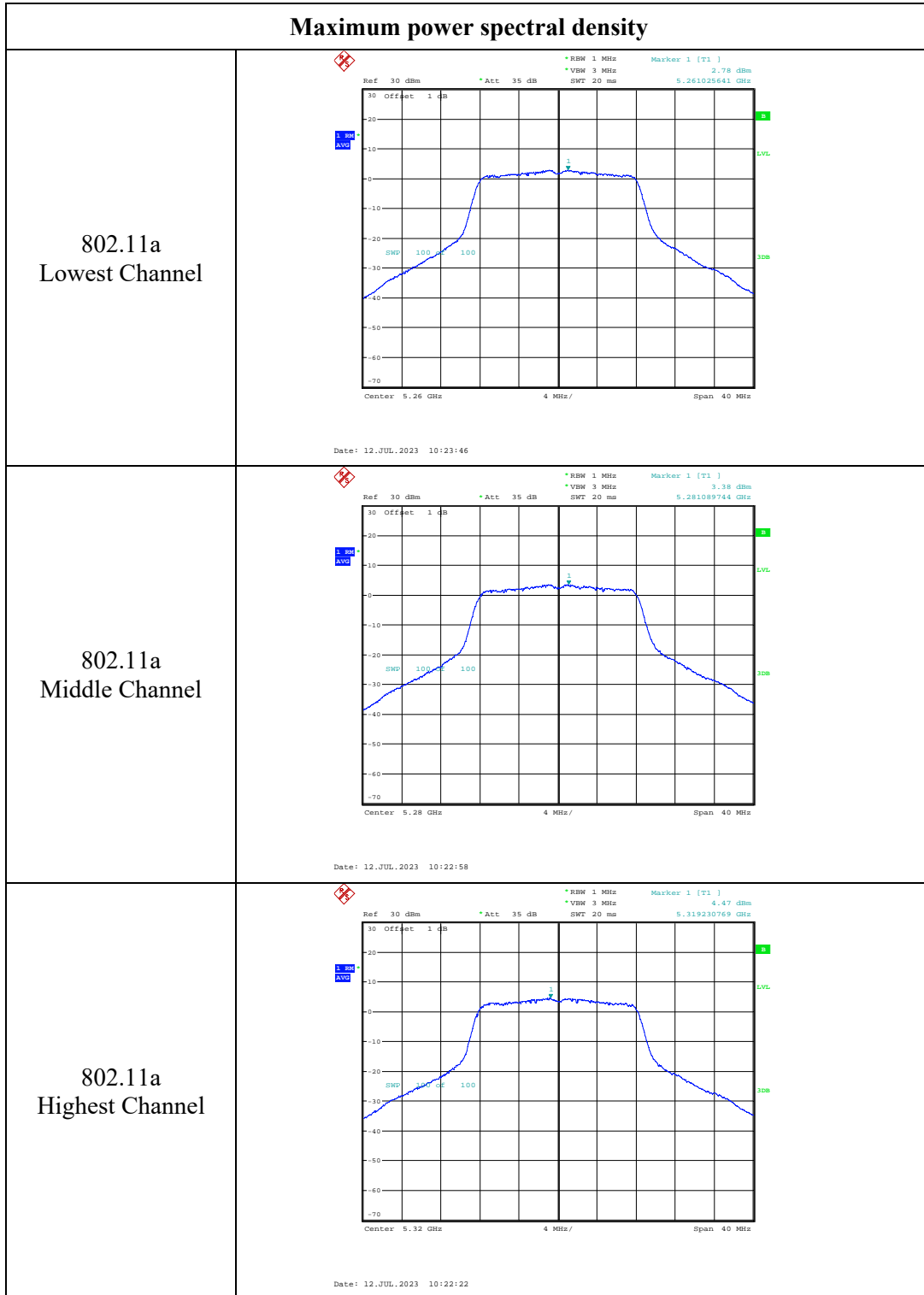

Maximum power spectral density

802.11n ht20
Lowest Channel

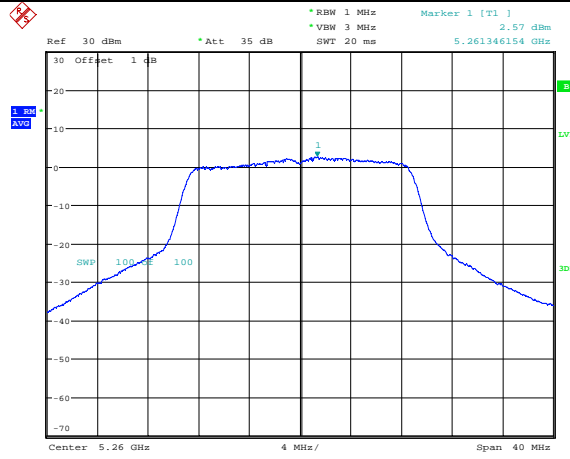

Date: 12.JUL.2023 10:20:19

802.11n ht20
Middle Channel

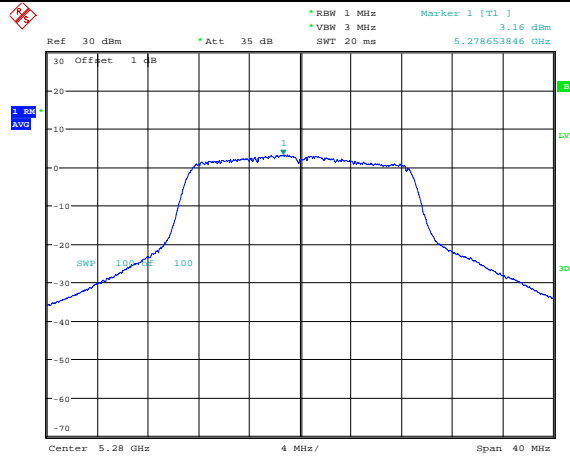

Date: 12.JUL.2023 10:21:00

802.11n ht20
Highest Channel

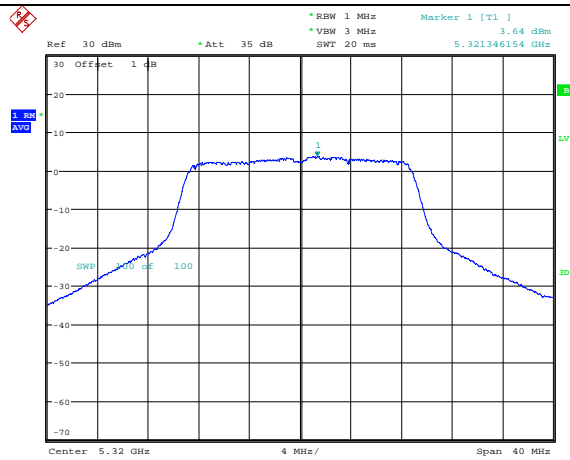

Date: 12.JUL.2023 10:21:39

Maximum power spectral density

802.11n ht40
Lowest Channel

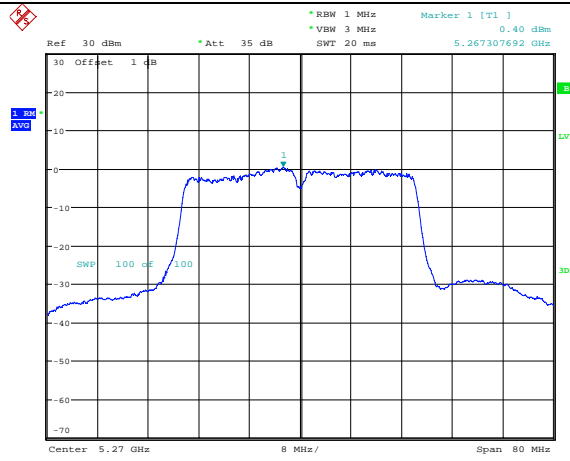

Date: 12.JUL.2023 10:12:06

802.11n ht40
Highest Channel

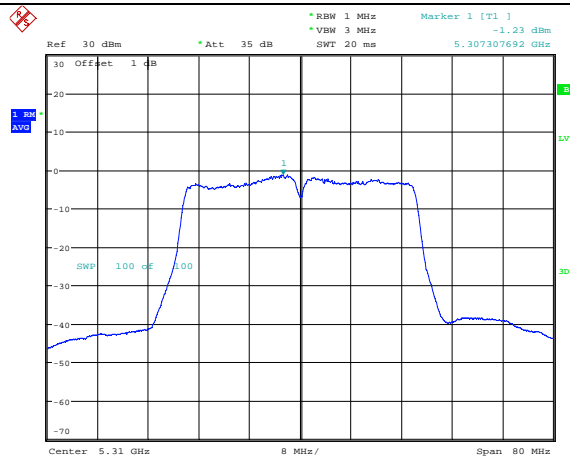

Date: 12.JUL.2023 10:16:32

5470-5725 MHz:

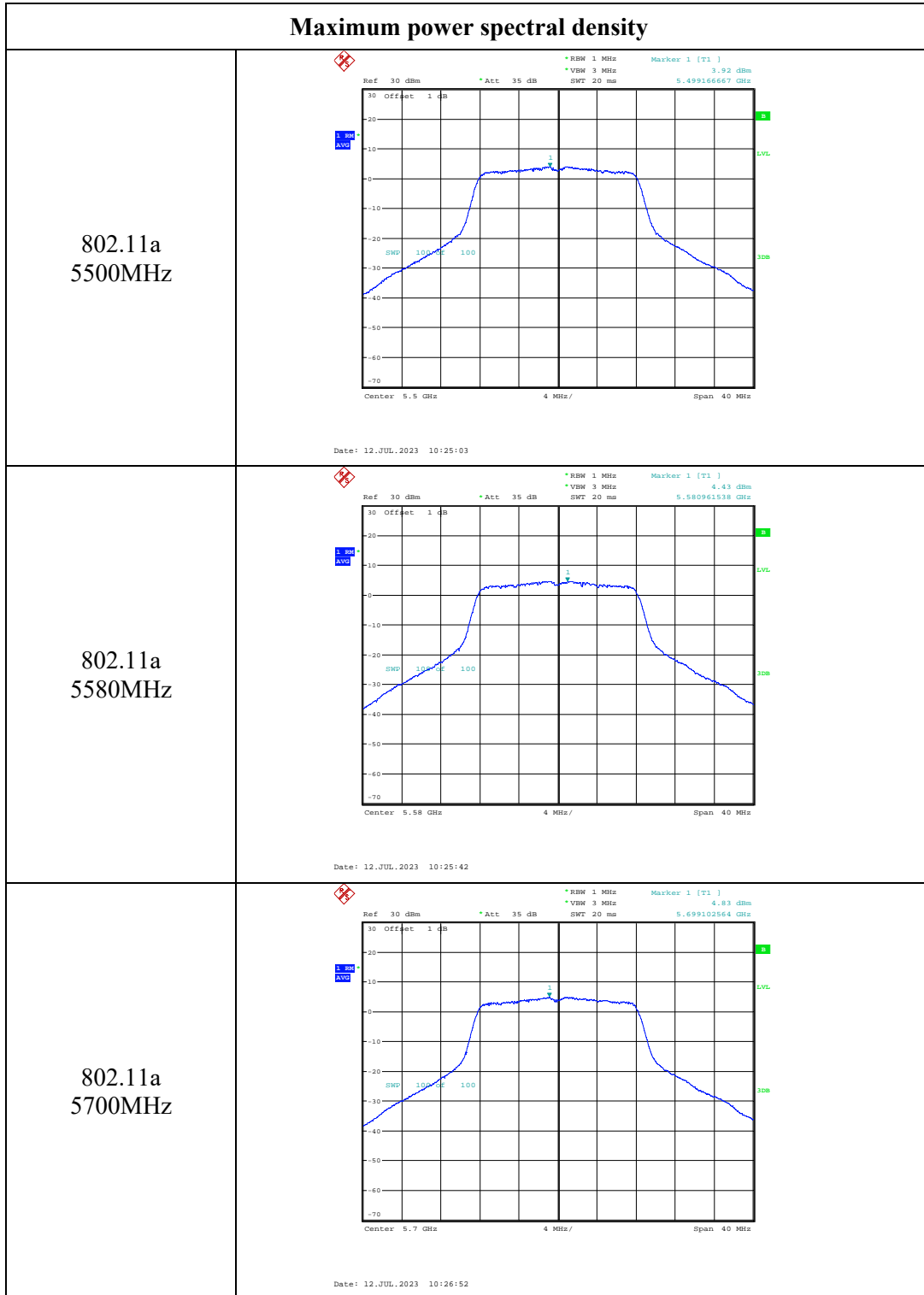

802.11a
5720MHz

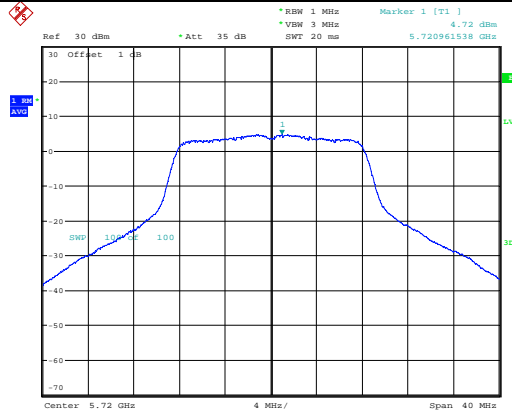

Date: 12 JUL 2023 10:27:38

Maximum power spectral density

802.11n ht20
5500MHz

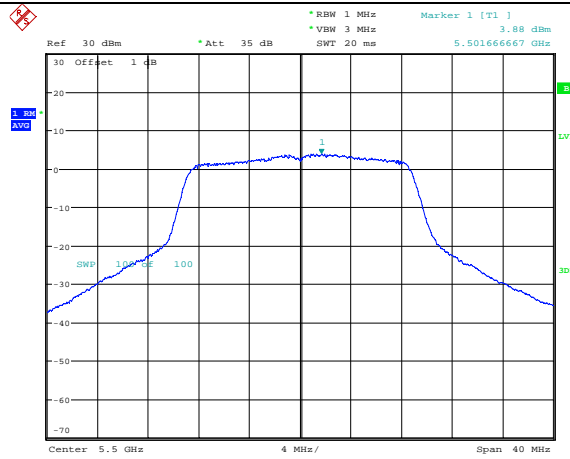

Date: 12.JUL.2023 10:29:42

802.11n ht20
5580MHz

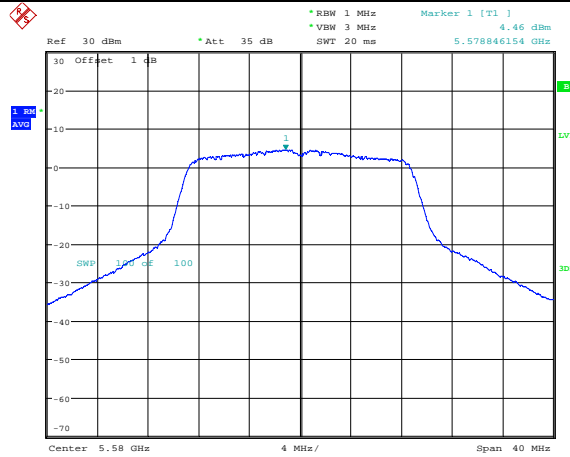

Date: 12.JUL.2023 10:30:46

802.11n ht20
5700MHz

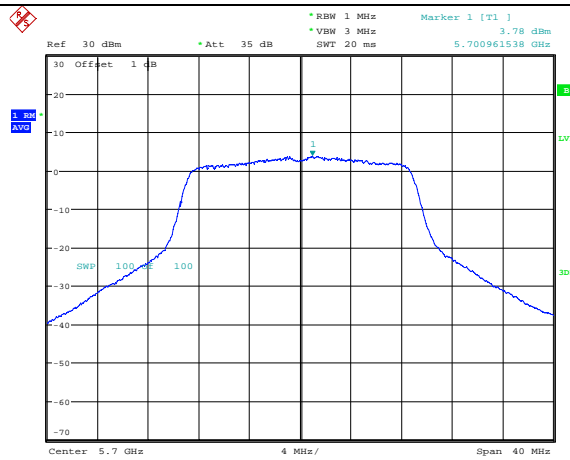

Date: 12.JUL.2023 10:31:43

802.11n ht20
5720MHz

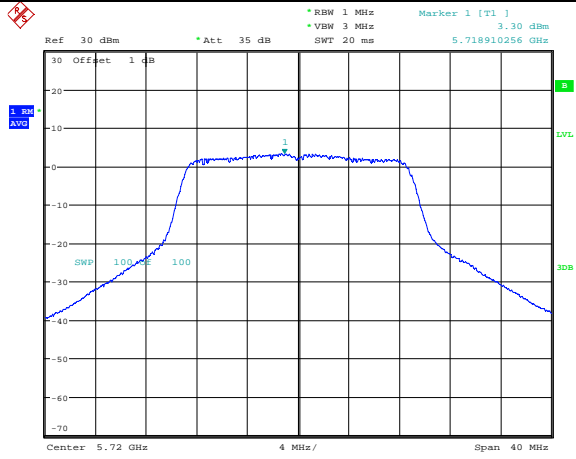

Date: 12.JUL.2023 10:32:21

Maximum power spectral density

802.11n ht40
5510MHz

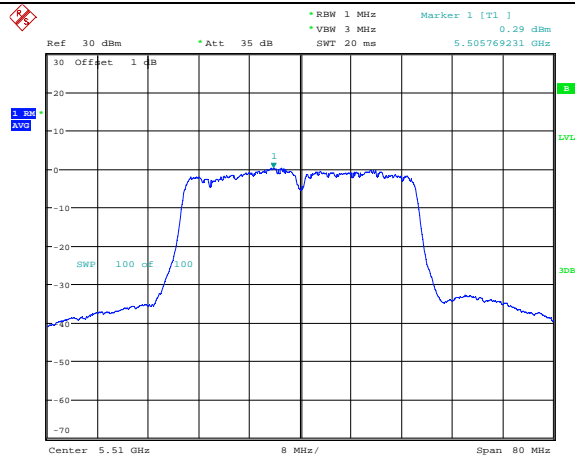

Date: 12.JUL.2023 10:33:46

802.11n ht40
5550MHz

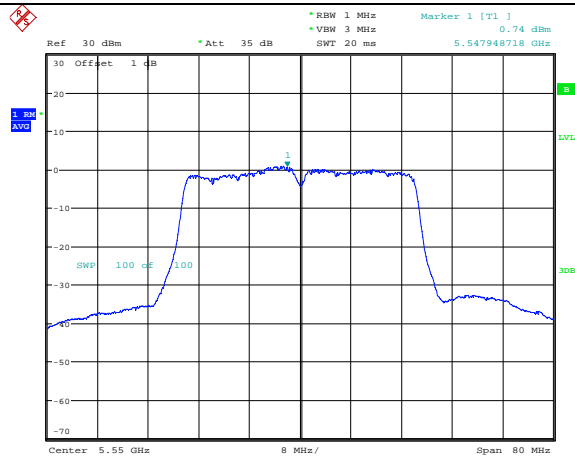

Date: 12.JUL.2023 10:34:20

802.11n ht40
5670MHz

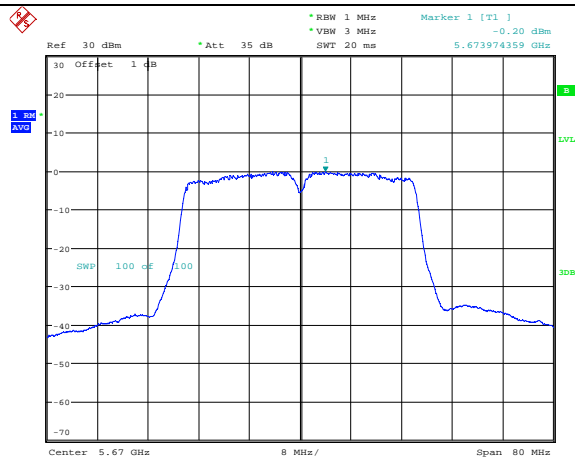

Date: 12.JUL.2023 10:35:15



5725-5850MHz

Maximum power spectral density

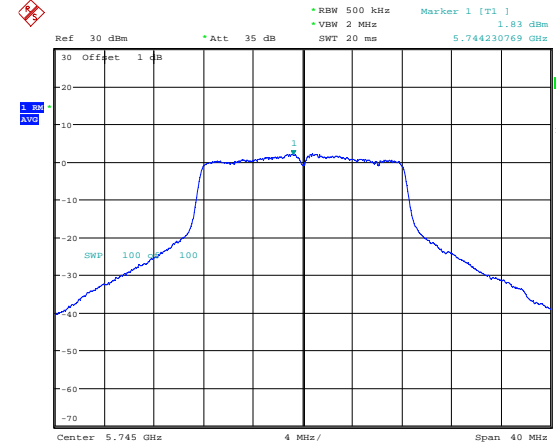
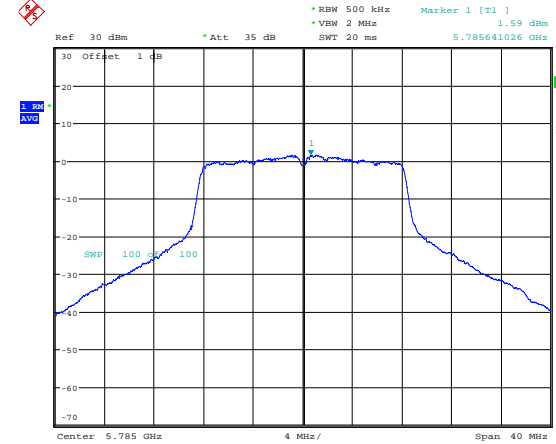
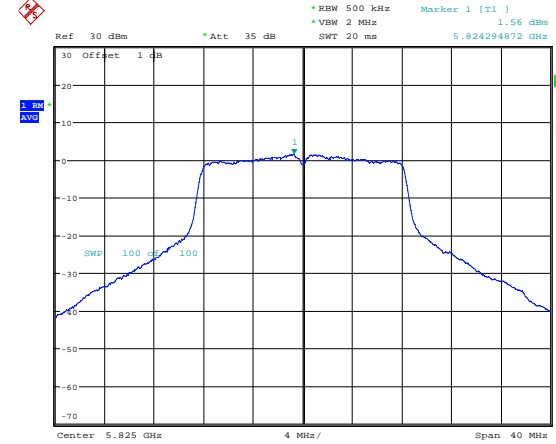
<p>802.11a Lowest Channel</p>	 <p>Ref 30 dBm * Att 35 dB * RBW 500 kHz Masker 1 [T1] 1.83 dBm * VBW 2 MHz 5.744230769 GHz SWT 20 ms</p> <p>30 Offset 1 dB -20 -10 0 -10 -20 -30 -40 -50 -60 -70</p> <p>SWP 100 dB 100</p> <p>Center 5.745 GHz 4 MHz/ Span 40 MHz</p> <p>Date: 12.JUL.2023 10:46:00</p>
<p>802.11a Middle Channel</p>	 <p>Ref 30 dBm * Att 35 dB * RBW 500 kHz Masker 1 [T1] 1.59 dBm * VBW 2 MHz 5.785641026 GHz SWT 20 ms</p> <p>30 Offset 1 dB -20 -10 0 -10 -20 -30 -40 -50 -60 -70</p> <p>SWP 100 dB 100</p> <p>Center 5.785 GHz 4 MHz/ Span 40 MHz</p> <p>Date: 12.JUL.2023 10:45:29</p>
<p>802.11a Highest Channel</p>	 <p>Ref 30 dBm * Att 35 dB * RBW 500 kHz Masker 1 [T1] 1.56 dBm * VBW 2 MHz 5.824294872 GHz SWT 20 ms</p> <p>30 Offset 1 dB -20 -10 0 -10 -20 -30 -40 -50 -60 -70</p> <p>SWP 100 dB 100</p> <p>Center 5.825 GHz 4 MHz/ Span 40 MHz</p> <p>Date: 12.JUL.2023 10:44:52</p>

Maximum power spectral density

802.11n ht20
Lowest Channel

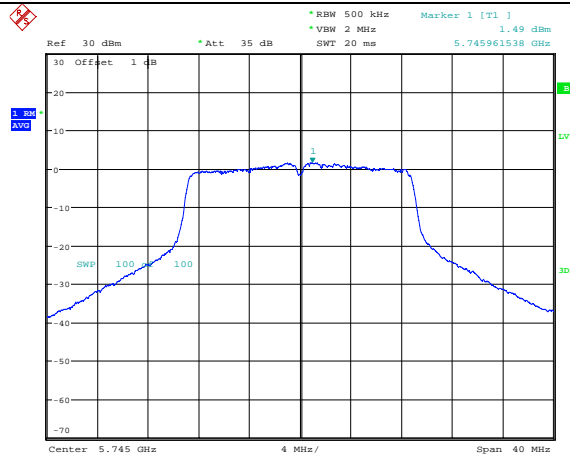

Date: 12.JUL.2023 10:42:29

802.11n ht20
Middle Channel

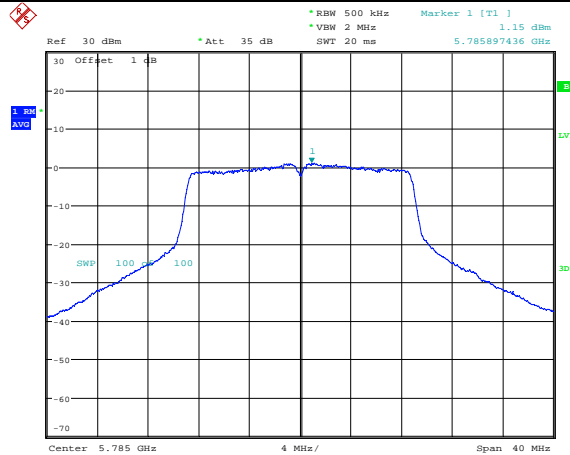

Date: 12.JUL.2023 10:43:17

802.11n ht20
Highest Channel

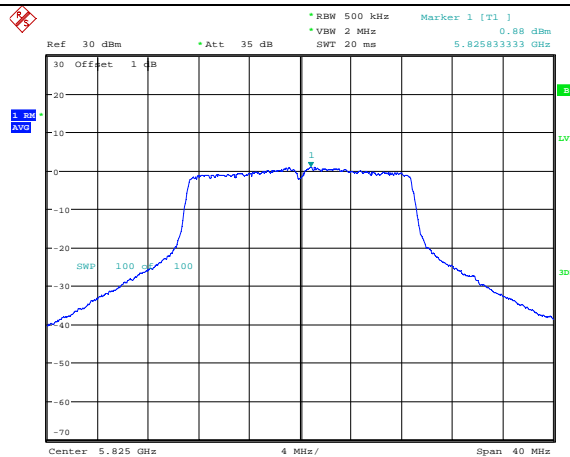

Date: 12.JUL.2023 10:43:53

Maximum power spectral density

802.11n ht40
Lowest Channel

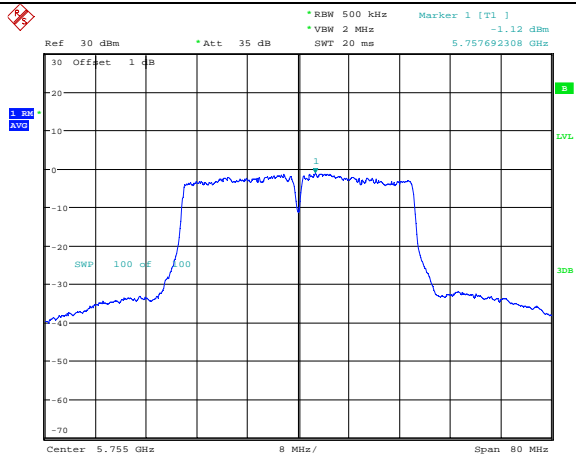

Date: 12.JUL.2023 10:40:03

802.11n ht40
Highest Channel

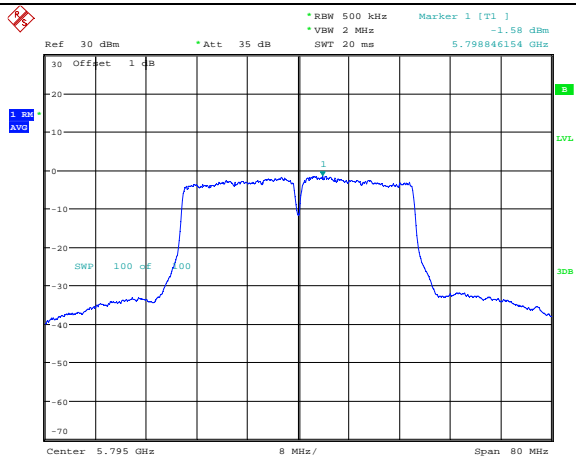

Date: 12.JUL.2023 10:41:23

Chain 1:
5150-5250MHz:

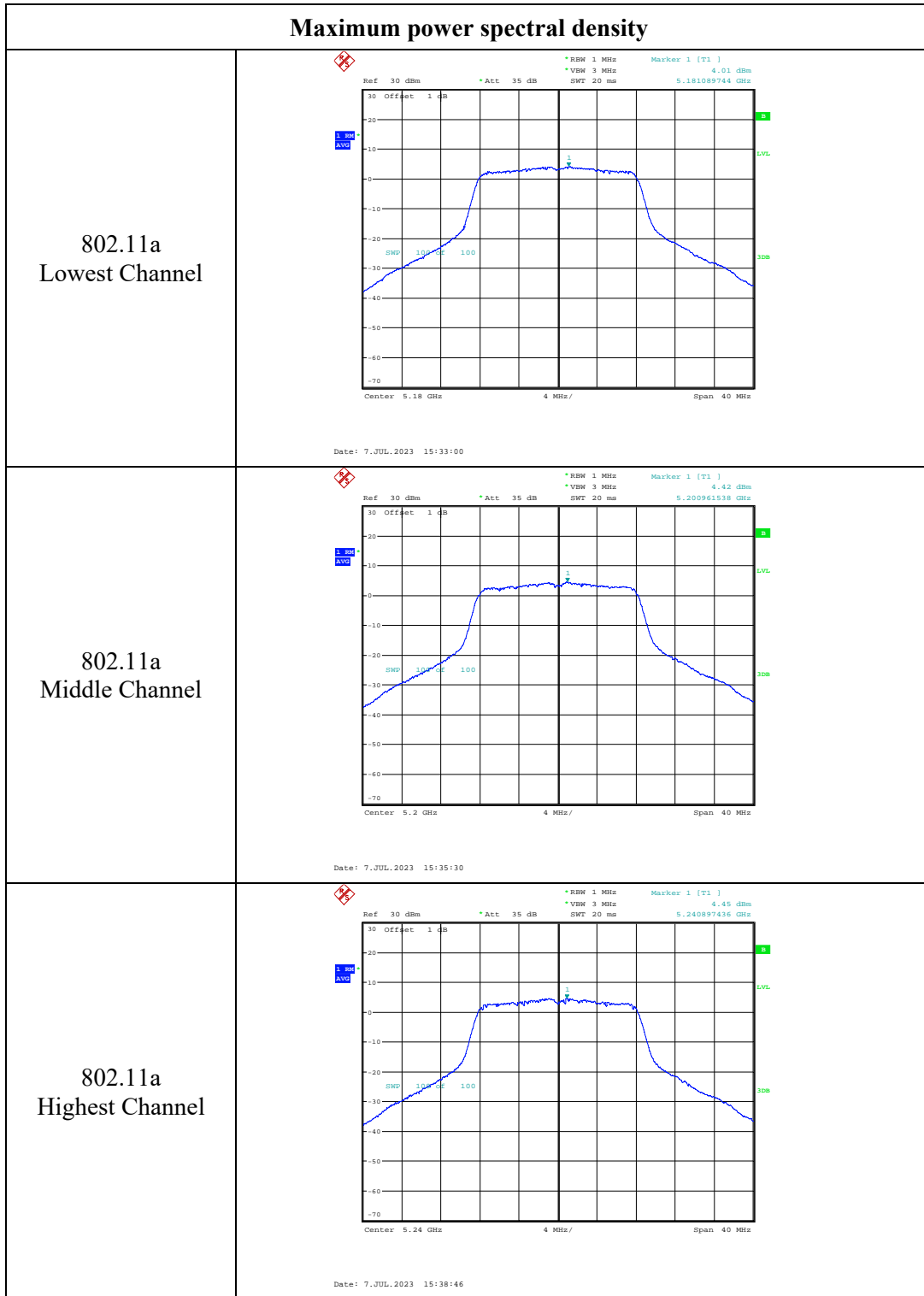

Maximum power spectral density

802.11n ht20
Lowest Channel

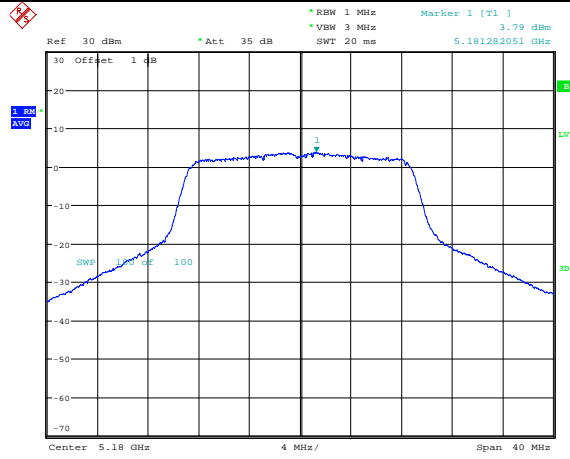

Date: 7.JUL.2023 15:41:48

802.11n ht20
Middle Channel

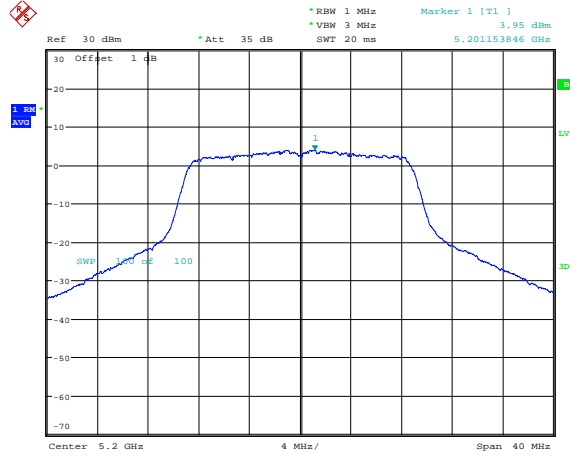

Date: 7.JUL.2023 15:41:07

802.11n ht20
Highest Channel

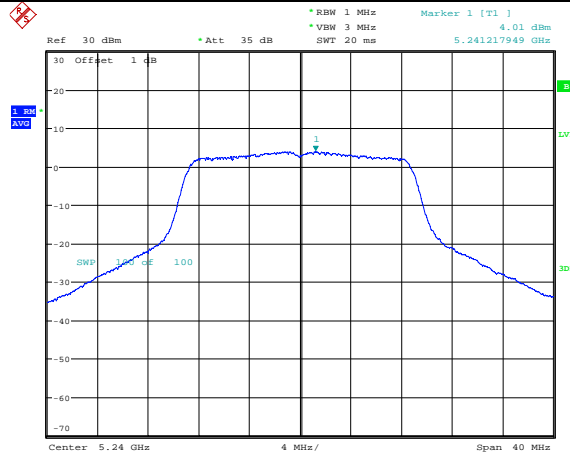

Date: 7.JUL.2023 15:40:21

Maximum power spectral density

802.11n ht40
Lowest Channel

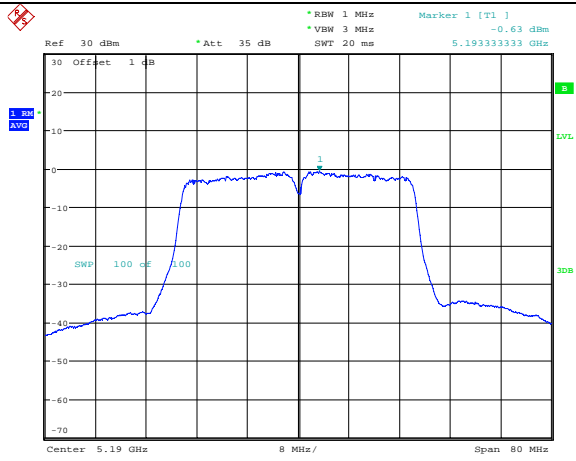

Date: 7.JUL.2023 15:42:43

802.11n ht40
Highest Channel

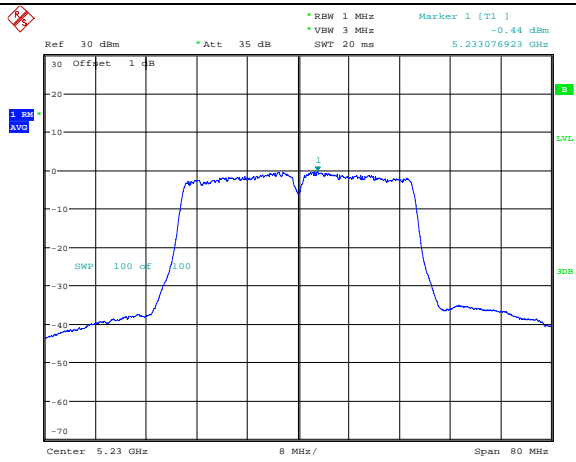

Date: 7.JUL.2023 15:43:24

5250-5350MHz:

Maximum power spectral density	
<p>802.11a Lowest Channel</p>	<p style="text-align: center;">Date: 7.JUL.2023 16:08:55</p>
<p>802.11a Middle Channel</p>	<p style="text-align: center;">Date: 7.JUL.2023 16:10:11</p>
<p>802.11a Highest Channel</p>	<p style="text-align: center;">Date: 7.JUL.2023 16:14:09</p>

Maximum power spectral density

802.11n ht20
Lowest Channel

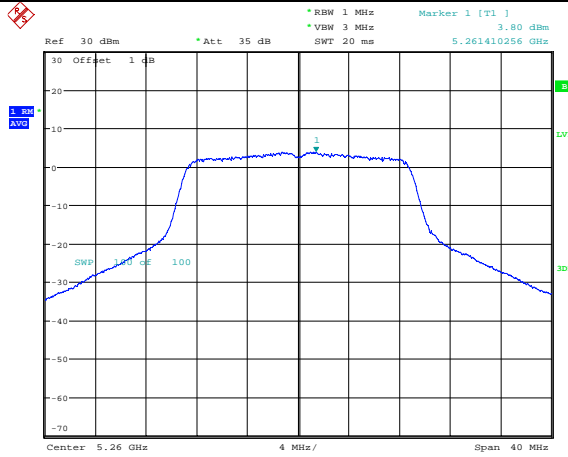

Date: 7.JUL.2023 15:55:22

802.11n ht20
Middle Channel

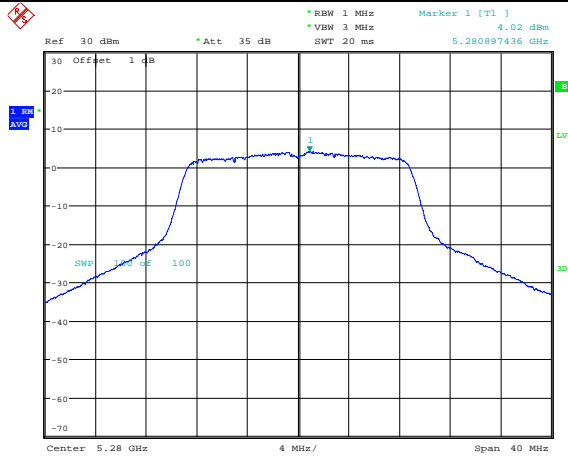

Date: 7.JUL.2023 15:56:06

802.11n ht20
Highest Channel

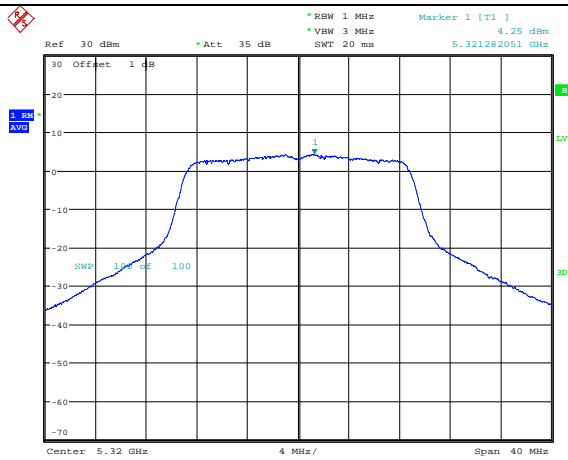

Date: 7.JUL.2023 15:57:04

Maximum power spectral density

802.11n ht40
Lowest Channel

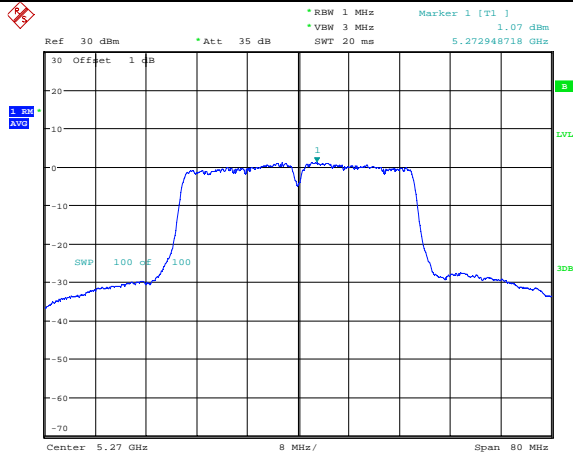

Date: 7.JUL.2023 15:46:40

802.11n ht40
Highest Channel

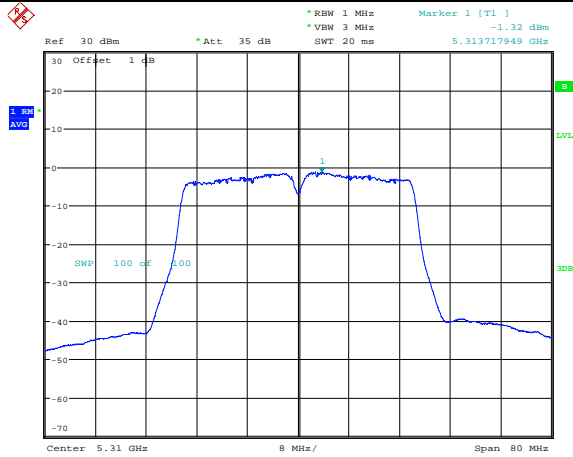

Date: 12.JUL.2023 11:23:01

5470-5725 MHz:

Maximum power spectral density	
<p>802.11a 5500MHz</p>	<p>Ref 30 dBm *Att 35 dB *RBW 1 MHz Marker 1 [T1] 4.43 dBm *VBW 3 MHz SWF 20 ms 5.498782051 GHz</p> <p>Center 5.5 GHz 4 MHz/ Span 40 MHz</p> <p>Date: 7.JUL.2023 16:07:06</p>
<p>802.11a 5580MHz</p>	<p>Ref 30 dBm *Att 35 dB *RBW 1 MHz Marker 1 [T1] 4.58 dBm *VBW 3 MHz SWF 20 ms 5.578974359 GHz</p> <p>Center 5.58 GHz 4 MHz/ Span 40 MHz</p> <p>Date: 7.JUL.2023 16:06:25</p>
<p>802.11a 5700MHz</p>	<p>Ref 30 dBm *Att 35 dB *RBW 1 MHz Marker 1 [T1] 4.10 dBm *VBW 3 MHz SWF 20 ms 5.698717949 GHz</p> <p>Center 5.7 GHz 4 MHz/ Span 40 MHz</p> <p>Date: 7.JUL.2023 16:05:27</p>

802.11a
5720MHz

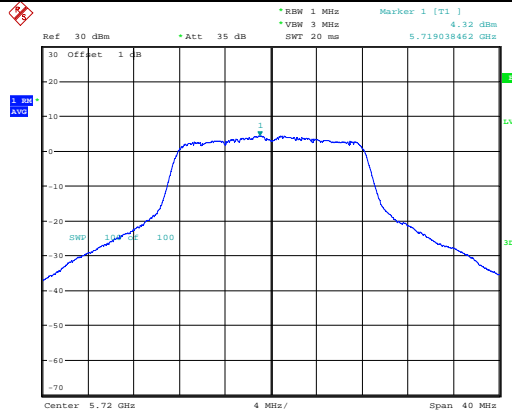

Date: 7.JUL.2023 16:03:03

Maximum power spectral density

802.11n ht20
5500MHz

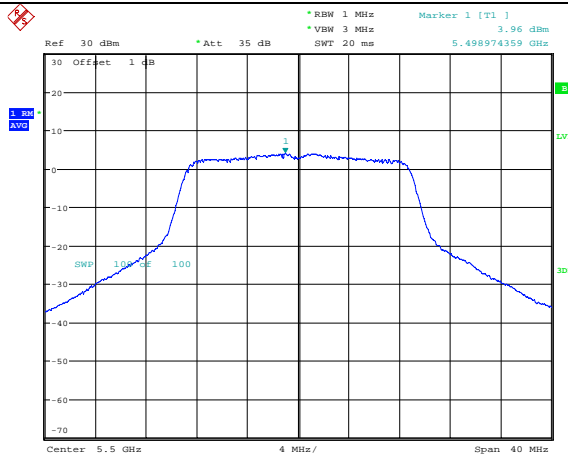

Date: 7.JUL.2023 15:58:31

802.11n ht20
5580MHz

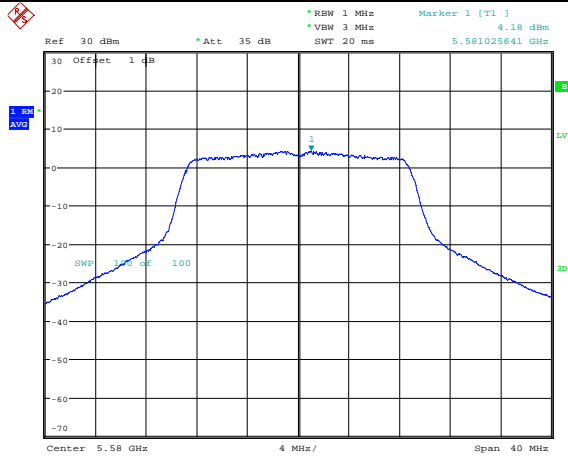

Date: 7.JUL.2023 15:59:21

802.11n ht20
5700MHz

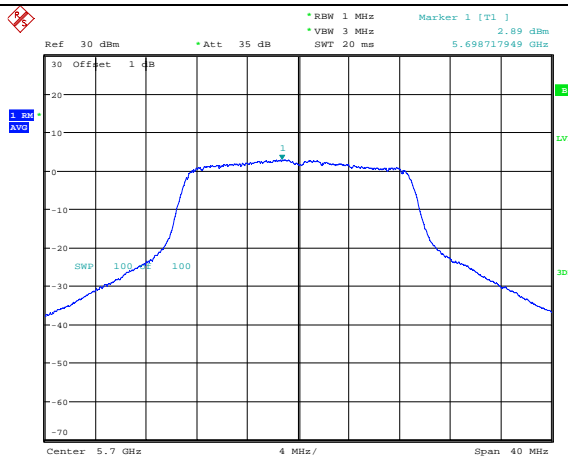

Date: 7.JUL.2023 16:00:23

802.11n ht20
5720MHz

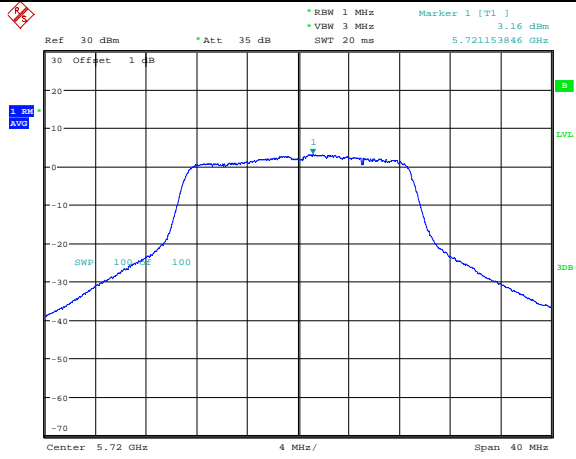

Date: 7.JUL.2023 16:01:09

Maximum power spectral density

802.11n ht40
5510MHz

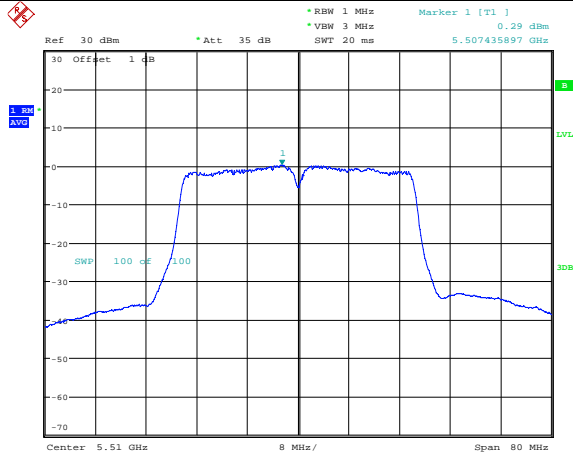

Date: 7.JUL.2023 15:50:07

802.11n ht40
5550MHz

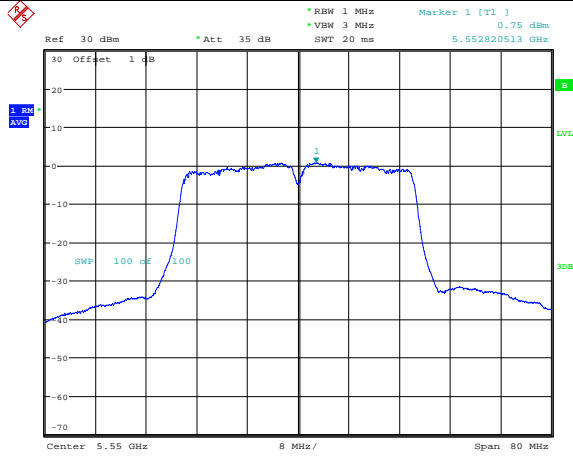

Date: 7.JUL.2023 15:50:52

802.11n ht40
5670MHz

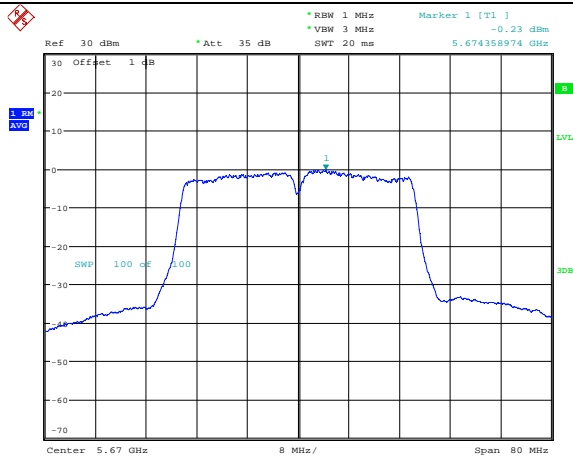

Date: 7.JUL.2023 15:52:09



5725-5850MHz

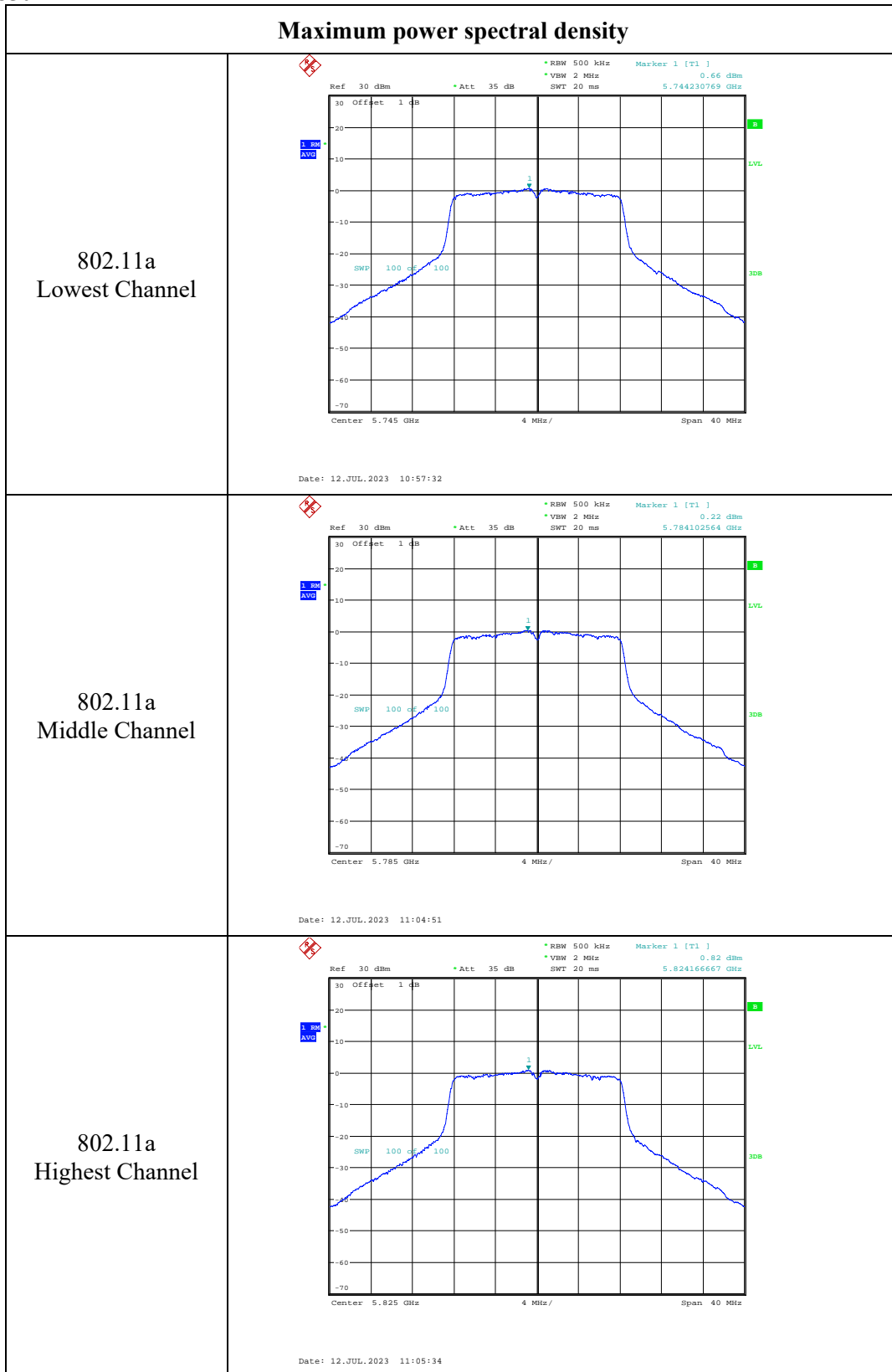

Maximum power spectral density

802.11n ht20
Lowest Channel

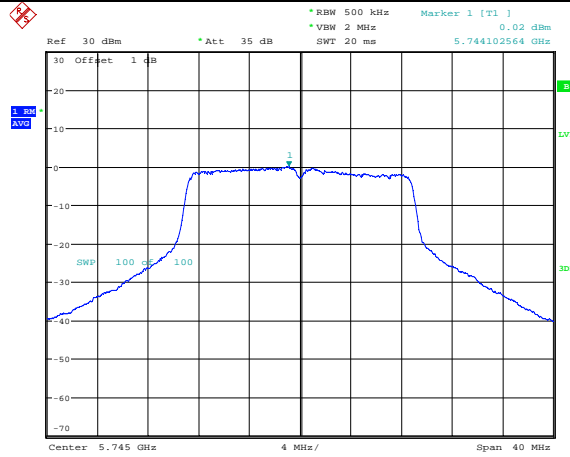

Date: 12.JUL.2023 11:08:18

802.11n ht20
Middle Channel

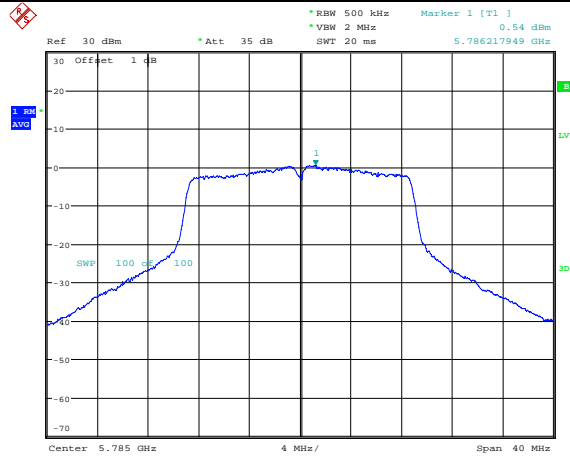

Date: 12.JUL.2023 11:07:33

802.11n ht20
Highest Channel

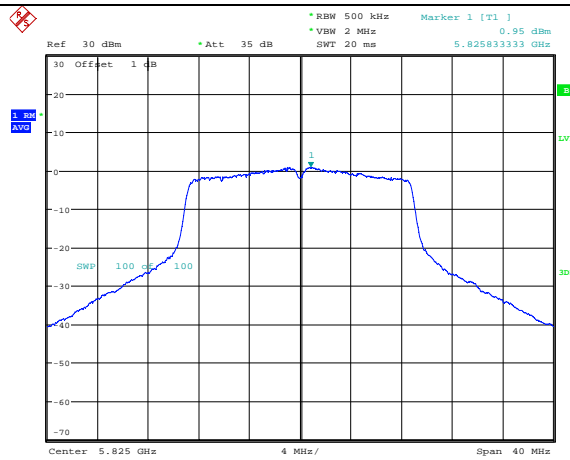

Date: 12.JUL.2023 11:06:49

Maximum power spectral density

802.11n ht40
Lowest Channel

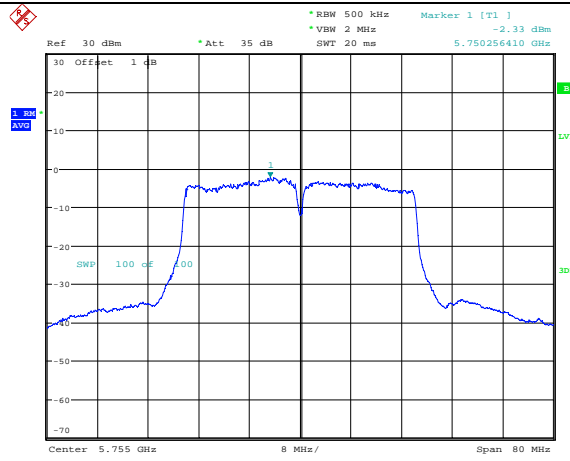

Date: 12.JUL.2023 11:09:08

802.11n ht40
Highest Channel

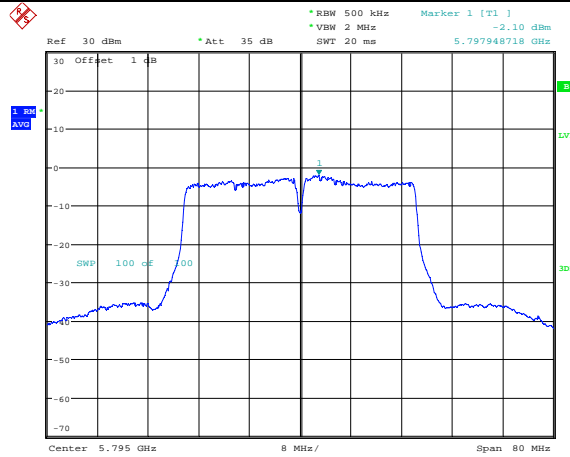

Date: 12.JUL.2023 11:10:00

4.7 Duty Cycle

Serial Number:	1TRF	Test Date:	2023/7/7~2023/7/12
Test Site:	RF	Test Mode:	Transmitting
Tester:	Claire Liu	Test Result:	N/A

Environmental Conditions:

Temperature: (°C)	24.8~26.2	Relative Humidity: (%)	51~62	ATM Pressure: (kPa)	99.7~100.6
----------------------	-----------	------------------------------	-------	------------------------	------------

Test Equipment List and Details:

Manufacturer	Description	Model	Serial Number	Calibration Date	Calibration Due Date
R&S	Spectrum Analyzer	FSU26	200256	2022/7/15	2023/7/14
YINSAIGE	Coaxial Cable	SS402	SJ0100002	Each time	N/A

* Statement of Traceability: China Certification ICT Co., Ltd (Dongguan) attests that all calibrations have been performed, traceable to National Primary Standards and International System of Units (SI).

Test Data:

Test Modes	Ton (ms)	Ton+off (ms)	Duty cycle (%)	1/T (Hz)	Duty Factor (dB)	VBW setting (Hz)
802.11a	2.09	2.105	99.29	/	/	10
802.11n ht20	1.974	2.271	86.92	507	0.61	1000
802.11n ht40	0.968	0.983	98.47	/	/	10

Duty Cycle

802.11a

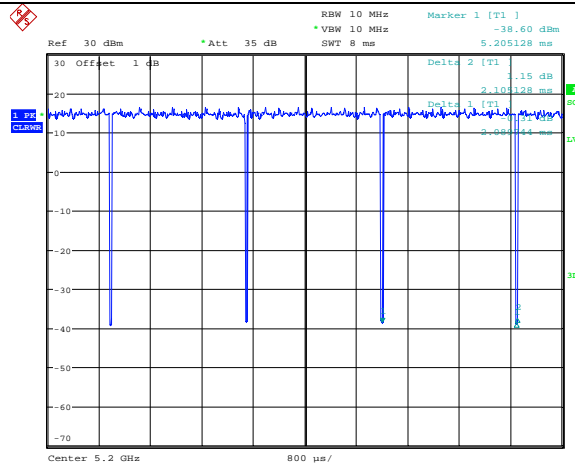

Date: 7.JUL.2023 11:41:56

802.11n ht20

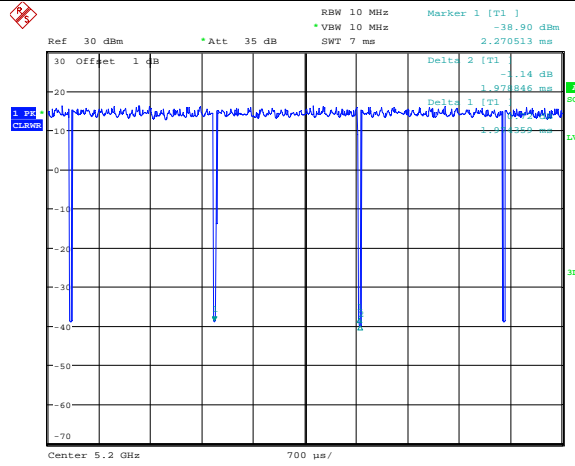

Date: 7.JUL.2023 11:45:33

802.11n ht40

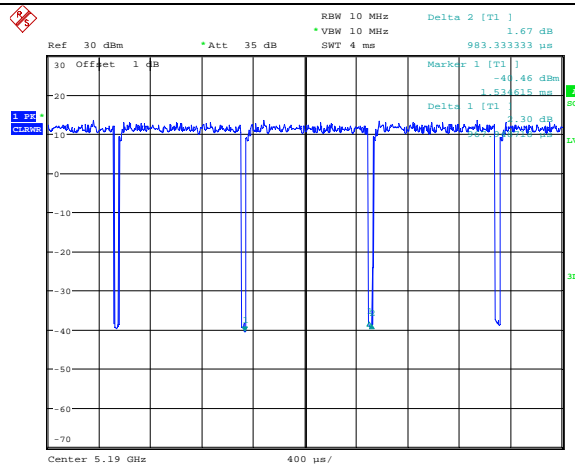

Date: 7.JUL.2023 11:48:09

4.8 Frequency Stability

Serial Number:	1TRF	Test Date:	2023/11/1
Test Site:	RF	Test Mode:	Transmitting
Tester:	Claire Liu	Test Result:	Pass

Environmental Conditions:

Temperature: (°C)	25.8	Relative Humidity: (%)	52	ATM Pressure: (kPa)	101.3
----------------------	------	------------------------------	----	---------------------------	-------

Test Equipment List and Details:

Manufacturer	Description	Model	Serial Number	Calibration Date	Calibration Due Date
R&S	Spectrum Analyzer	FSU26	200256	2023/3/31	2024/3/30
YINSAIGE	Coaxial Cable	SS402	SJ0100002	Each time	N/A
BACL	TEMP&HUMI Test Chamber	BTH-150-40	30174	2023/3/31	2024/3/30
UNI-T	Multimeter	UT39A+	C210582554	2023/9/28	2024/9/27

* Statement of Traceability: China Certification ICT Co., Ltd (Dongguan) attests that all calibrations have been performed, traceable to National Primary Standards and International System of Units (SI).

Test Data:

5150-5250 MHz Band:

Test Mode:	802.11a					
Test Item	Temperature (°C)	Voltage (V _{DC})	FL at Low Channel (MHz)		FH at High Channel (MHz)	
			Result	Limit	Result	Limit
Frequency Stability vs. Temperature	-20	24	5171.54	5150	5248.45	5250
	-10	24	5171.50	5150	5248.45	5250
	0	24	5171.49	5150	5248.51	5250
	10	24	5171.49	5150	5248.50	5250
	20	24	5171.52	5150	5248.48	5250
	30	24	5171.52	5150	5248.45	5250
	40	24	5171.51	5150	5248.47	5250
	50	24	5171.52	5150	5248.50	5250
Frequency Stability vs. Voltage	20	21.6	5171.53	5150	5248.51	5250
	20	26.4	5171.49	5150	5248.45	5250

5250-5350 MHz Band:

Test Mode:	802.11a					
Test Item	Temperature (°C)	Voltage (V _{DC})	FL at Low Channel (MHz)		FH at High Channel (MHz)	
			Result	Limit	Result	Limit
Frequency Stability vs. Temperature	-20	24	5251.54	5250	5311.44	5350
	-10	24	5251.52	5250	5311.45	5350
	0	24	5251.51	5250	5311.44	5350
	10	24	5251.51	5250	5311.41	5350
	20	24	5251.52	5250	5311.44	5350
	30	24	5251.53	5250	5311.47	5350
	40	24	5251.54	5250	5311.44	5350
	50	24	5251.55	5250	5311.45	5350
Frequency Stability vs. Voltage	20	21.6	5251.55	5250	5311.43	5350
	20	26.4	5251.51	5250	5311.44	5350

5470-5725 MHz Band:

Test Mode:	802.11a					
Test Item	Temperature (°C)	Voltage (V _{DC})	FL at Low Channel (MHz)		FH at High Channel (MHz)	
			Result	Limit	Result	Limit
Frequency Stability vs. Temperature	-20	24	5491.49	5470	5708.55	5725
	-10	24	5491.55	5470	5708.58	5725
	0	24	5491.49	5470	5708.56	5725
	10	24	5491.51	5470	5708.57	5725
	20	24	5491.52	5470	5708.56	5725
	30	24	5491.52	5470	5708.57	5725
	40	24	5491.49	5470	5708.56	5725
	50	24	5491.55	5470	5708.57	5725
Frequency Stability vs. Voltage	20	21.6	5491.50	5470	5708.53	5725
	20	26.4	5491.54	5470	5708.54	5725

5725-5850 MHz Band:

Test Mode:	802.11a					
Test Item	Temperature (°C)	Voltage (V _{DC})	FL at Low Channel (MHz)		FH at High Channel (MHz)	
			Result	Limit	Result	Limit
Frequency Stability vs. Temperature	-20	24	5736.52	5725	5833.59	5850
	-10	24	5736.51	5725	5833.55	5850
	0	24	5736.51	5725	5833.53	5850
	10	24	5736.52	5725	5833.54	5850
	20	24	5736.52	5725	5833.56	5850
	30	24	5736.49	5725	5833.54	5850
	40	24	5736.49	5725	5833.54	5850
	50	24	5736.51	5725	5833.54	5850
Frequency Stability vs. Voltage	20	21.6	5736.54	5725	5833.59	5850
	20	26.4	5736.52	5725	5833.54	5850

5. RF EXPOSURE EVALUATION

5.1 MPE-Based Exemption

5.1.1 Applicable Standard

According to §1.1307(b)(3)(i)

(C) Or using Table 1 and the minimum separation distance (R in meters) from the body of a nearby person for the frequency (f in MHz) at which the source operates, the ERP (watts) is no more than the calculated value prescribed for that frequency. For the exemption in Table 1 to apply, R must be at least $\lambda/2\pi$, where λ is the free-space operating wavelength in meters. If the ERP of a single RF source is not easily obtained, then the available maximum time-averaged power may be used in lieu of ERP if the physical dimensions of the radiating structure(s) do not exceed the electrical length of $\lambda/4$ or if the antenna gain is less than that of a half-wave dipole (1.64 linear value).

Table 1 to § 1.1307(b)(3)(i)(C) - Single RF Sources Subject to Routine Environmental Evaluation

RF Source frequency (MHz)	Threshold ERP (watts)
0.3-1.34	$1,920 R^2$.
1.34-30	$3,450 R^2/f^2$.
30-300	$3.83 R^2$.
300-1,500	$0.0128 R^2 f$.
1,500-100,000	$19.2R^2$.

5.1.2 Measurement Result

Radio	Frequency (MHz)	$\lambda/2$ Π (mm)	Distance (mm)	Exemption ERP (mW)	Maximum Conducted Power including Tune-up Tolerance (dBm)	Antenna Gain (dBi)	ERP		MPE-Based Exemption
							dBm	mW	
2.4G WLAN	2412-2462	19.80	200	768	18	2.90	18.75	74.99	Compliant
BLE	2402-2480	19.88	200	768	5.5	2.90	6.25	4.22	Compliant
BDR/EDR	2402-2480	19.88	200	768	6	2.90	6.75	4.73	Compliant
5.2G WLAN	5180-5240	9.22	200	768	17	0.70	15.55	35.89	Compliant
5.3G WLAN	5260-5320	9.08	200	768	18	1.90	17.75	59.57	Compliant
5.6G WLAN	5500-5720	8.68	200	768	19	3.00	19.85	96.61	Compliant
5.8G WLAN	5745-5825	8.31	200	768	19	2.80	19.65	92.26	Compliant

Note:

The Maximum Conducted Power including Tune-up Tolerance was declared by manufacturer.
The Bluetooth, WLAN 2.4G, 5G can't transmission simutenuously.

Result: The device compliant the MPE-Based Exemption at 20cm distances.

5.2 Exemption Limits for Routine Evaluation – RF Exposure Evaluation

5.2.1 Applicable Standard

According to RSS-102 Clause 2.5.2

RF exposure evaluation is required if the separation distance between the user and/or bystander and the device's radiating element is greater than 20 cm, except when the device operates as follows:

- below 20 MHz and the source-based, time-averaged maximum e.i.r.p. of the device is equal to or less than 1 W (adjusted for tune-up tolerance);
- at or above 20 MHz and below 48 MHz and the source-based, time-averaged maximum e.i.r.p. of the device is equal to or less than $4.49/f^{0.5}$ W (adjusted for tune-up tolerance), where f is in MHz;
- at or above 48 MHz and below 300 MHz and the source-based, time-averaged maximum e.i.r.p. of the device is equal to or less than 0.6 W (adjusted for tune-up tolerance);
- at or above 300 MHz and below 6 GHz and the source-based, time-averaged maximum e.i.r.p. of the device is equal to or less than $1.31 \times 10^{-2} f^{0.6834}$ W (adjusted for tune-up tolerance), where f is in MHz;
- at or above 6 GHz and the source-based, time-averaged maximum e.i.r.p. of the device is equal to or less than 5 W (adjusted for tune-up tolerance).

In these cases, the information contained in the RF exposure technical brief may be limited to information that demonstrates how the e.i.r.p. was derived.

Calculated Data:

Mode	Frequency (MHz)	Antenna Gain	Conducted output power including Tune-up Tolerance	EIRP		Exemption limits (mW)
		(dBi)	(dBm)	(dBm)	(mW)	
Wi-Fi	2412-2462	2.9	18	20.9	123.03	2684
BLE	2402-2480	2.9	5.5	8.4	6.92	2676
BDR/EDR	2402-2480	2.9	6	8.9	7.76	2676
WLAN 5.2G	5180-5240	0.7	17	17.7	58.88	4525
WLAN 5.3G	5260-5320	1.9	18	19.9	97.72	4573
WLAN 5.6G	5500-5580 5660-5720	3	19	22	158.49	4714
WLAN 5.8G	5745-5825	2.8	19	21.8	151.36	4909

Note:

The Maximum Conducted Power including Tune-up Tolerance was declared by manufacturer.
The Bluetooth, WLAN 2.4G, 5G can't transmission simutenuously.

So the device is compliance exemption from Routine Evaluation Limits –RF exposure Evaluation.

Result: Compliance

===== END OF REPORT =====